

FLAT AND ROUND PVC DUCTWORKS

"Plastivent" air ductwork system is the ideal solution for arrangement of ventilation systems in small and medium-sized residential, office and commercial premises as well for connection of cooker hoods, exhaust hoods, cowls and other exhaust equipment. It includes rectangular 55x110, 60x120, 60x204 mm air ducts, round Ø 100, 125, 150, 200 mm air ducts and a great variety of fittings such as bends, reducers, connectors, etc. Operation temperature from -30 °C up to +70 °C.

Basic advantages of "Plastivent" system:

- A great variety of fittings designed for assembly of complex ductworks with any geometry based exclusively on "Plastivent" system components.
- Smooth inner duct surface provides low air resistance.
- Corrosion resistant properties ensure long service life.
- Low weight.
- Ventilation system based on "Plastivent" air ducts produces lower noise level as compared to other systems with corrugated or steel air ducts.
- Low thermal conductivity.
- Environmentally friendly plastic used for manufacture of "Plastivent" system does not sustain combustion.

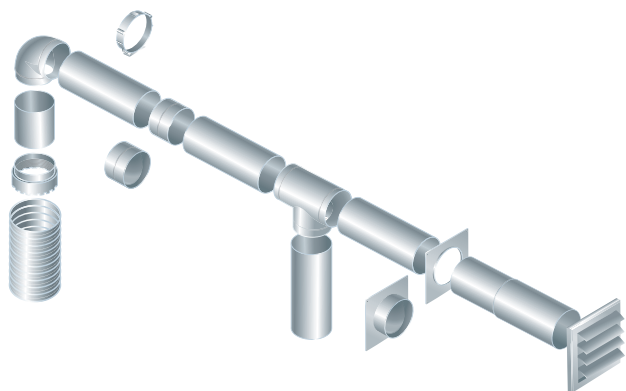
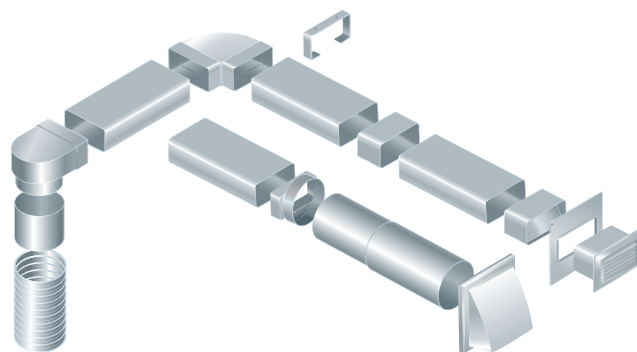

- Extremely easy mounting due to no complicated assembly operations and special tools.
- Small overall dimensions of the rectangular components allow using the system in limited area above false ceilings.
- Aesthetic view makes the system suitable for mounting in ready-made premises.

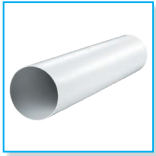

Round duct

page
356



Round telescopic duct

page
357



**Round flexible duct
connector**

page
357



90° bend for round ducts

page
357

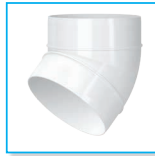

45° bend for round ducts

page
358



T-joint for round ducts

page
358



**Wall plate for round
ducts**

page
358



Round duct connector

page
359



**Connector with
backdraft damper
for round ducts**

page
359



**Connector with back-
draft damper and wall
plate for round ducts**

page
360



**Connector with plate
for round ducts**

page
360



Reducer

page
361



Reducer

page
362



Step round reducer

page
362



Step round reducer

page
363



Round to flat connector

page
363



Round flexible duct connector

page
364



Holder for round ducts

page
364

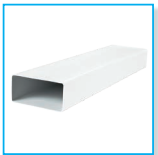

Flat duct

page
365



Flat duct connector

page
366



Flat duct connector with damper

page
366



Flexible flat duct connector

page
367



Air duct connector with a plate

page
367



Air duct connector with a plate and a back valve

page
368



Vertical 90° bend for flat ducts

page
368



Horizontal 90° bend for flat ducts

page
369



Versatile flat angular connector

page
369

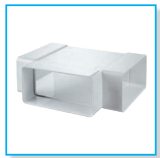

T-joint for flat ducts

page
370



Flat duct holder

page
370



**90° connecting bend for
flat and round ducts**

page
371



**T-joint for flat and
round ducts**

page
371

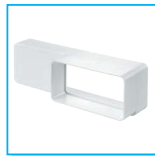

Reducer for flat ducts

page
372

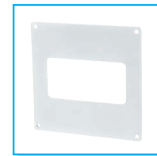

Wall plate for flat ducts

page
372



End grille

page
372



**End grille with air pass
regulation**

page
373



**Reducer for flat and
round ducts**

page
373



Wall plate with flange

page
374



**Round to flat connector
(symmetric)**

page
375

Kitchen

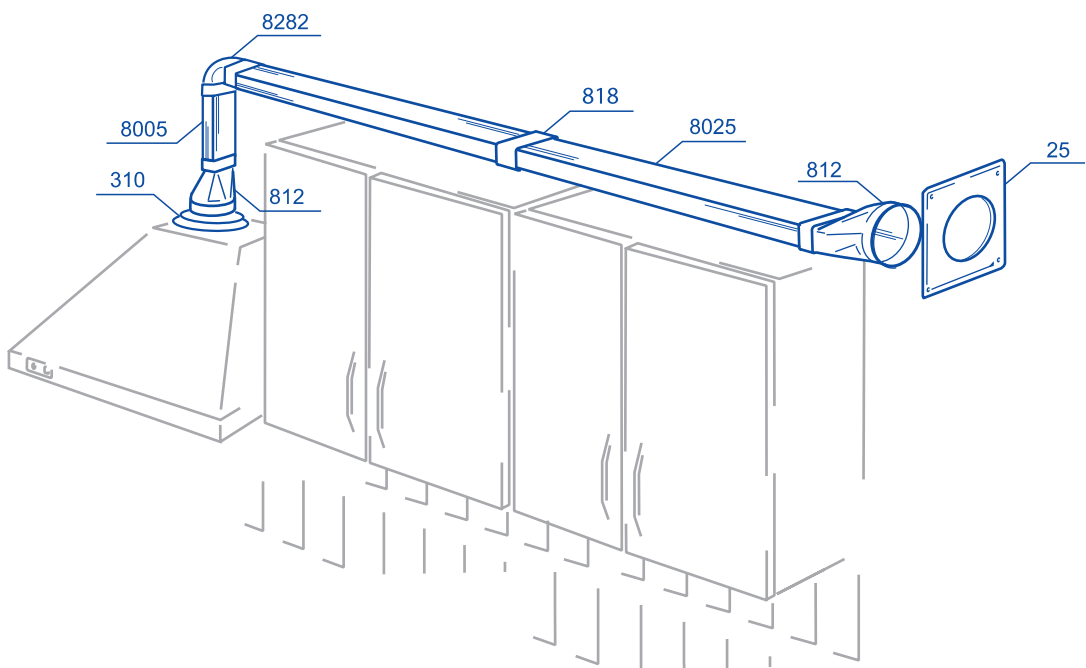
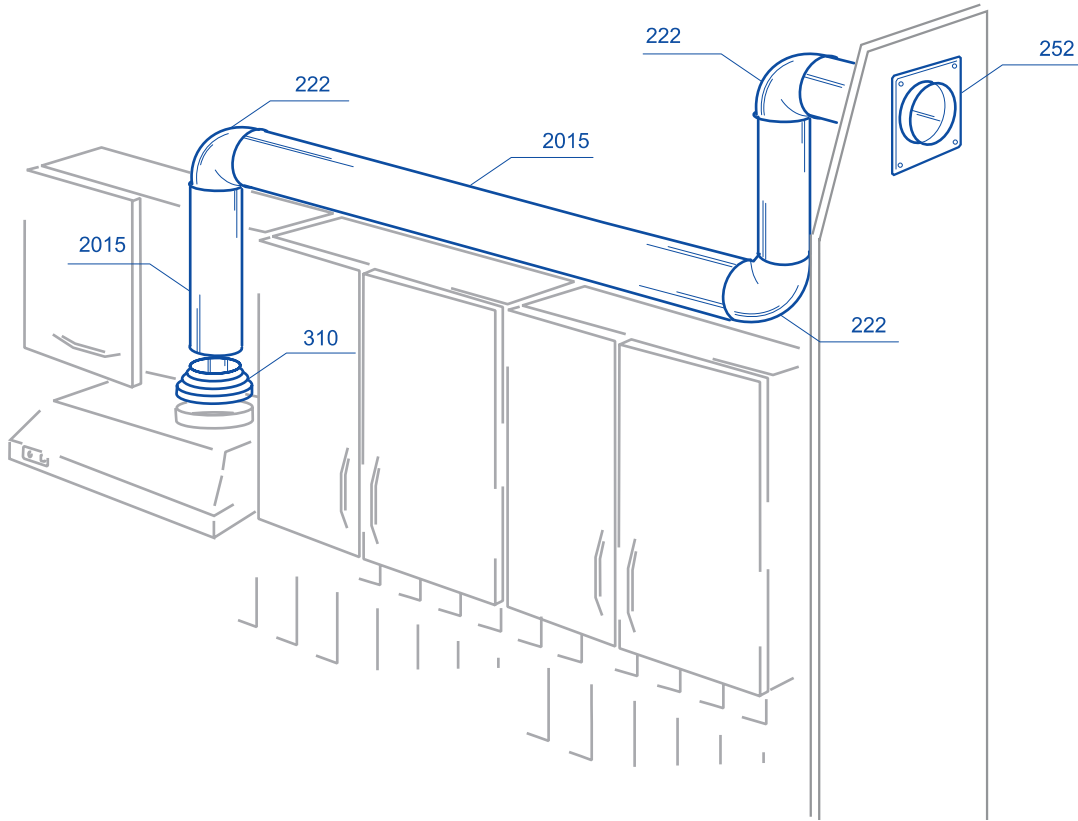

Cafe

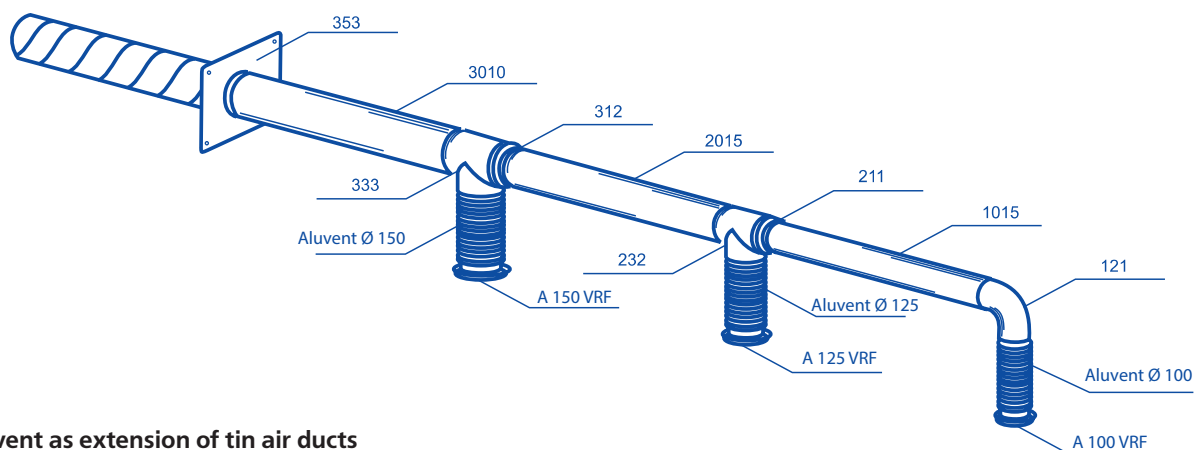
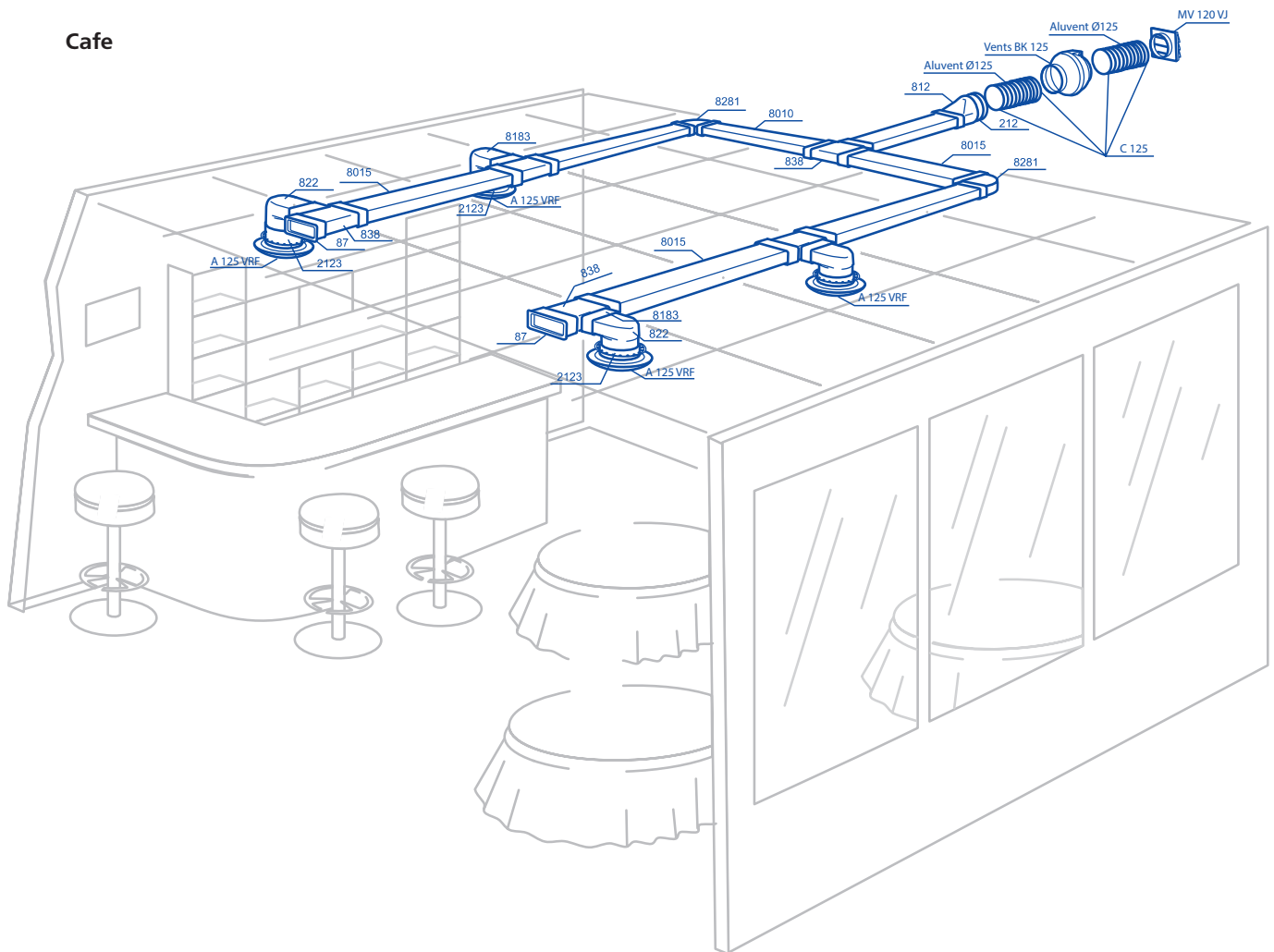

Plastivent as extension of tin air ducts

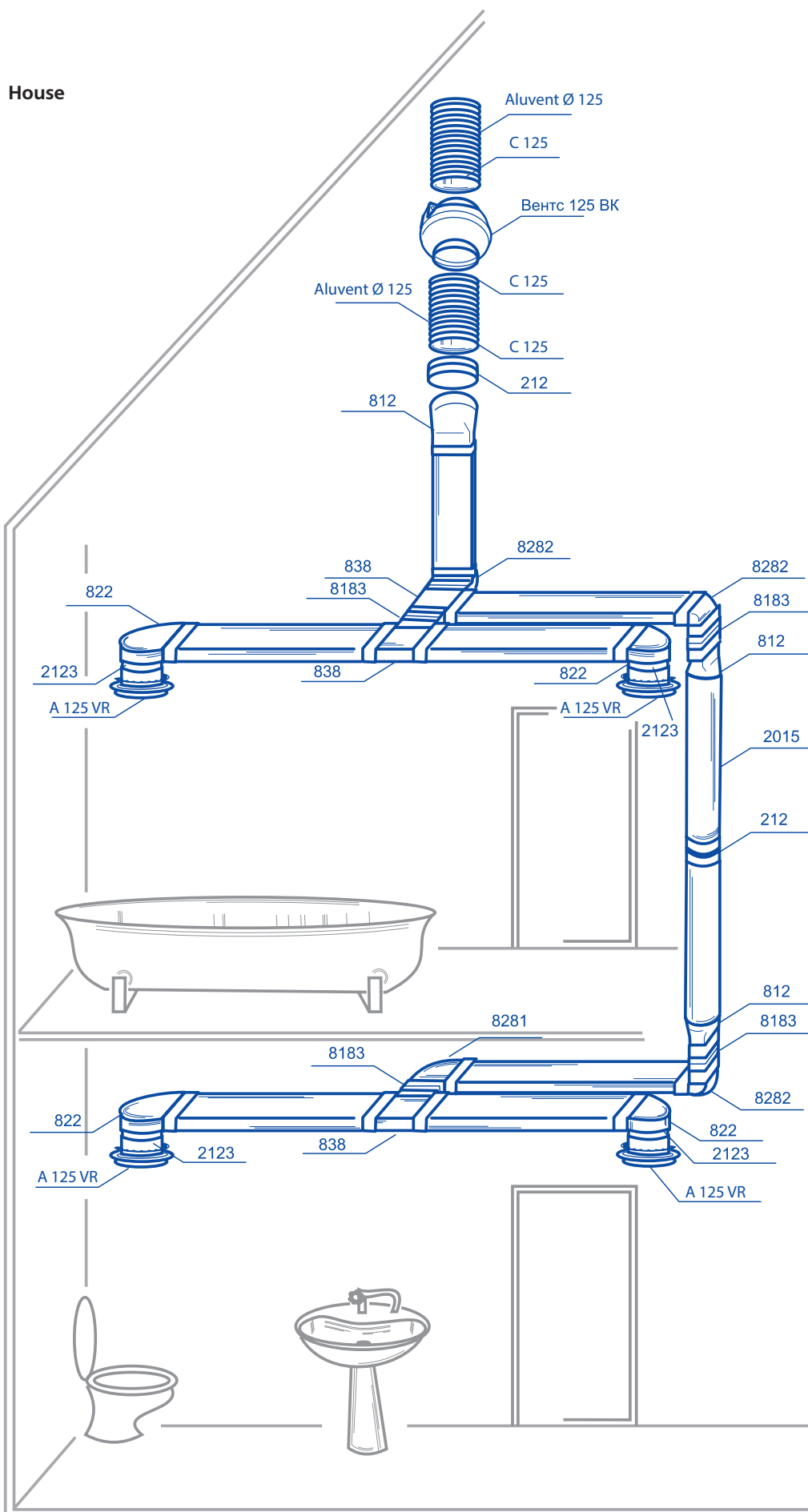

Office

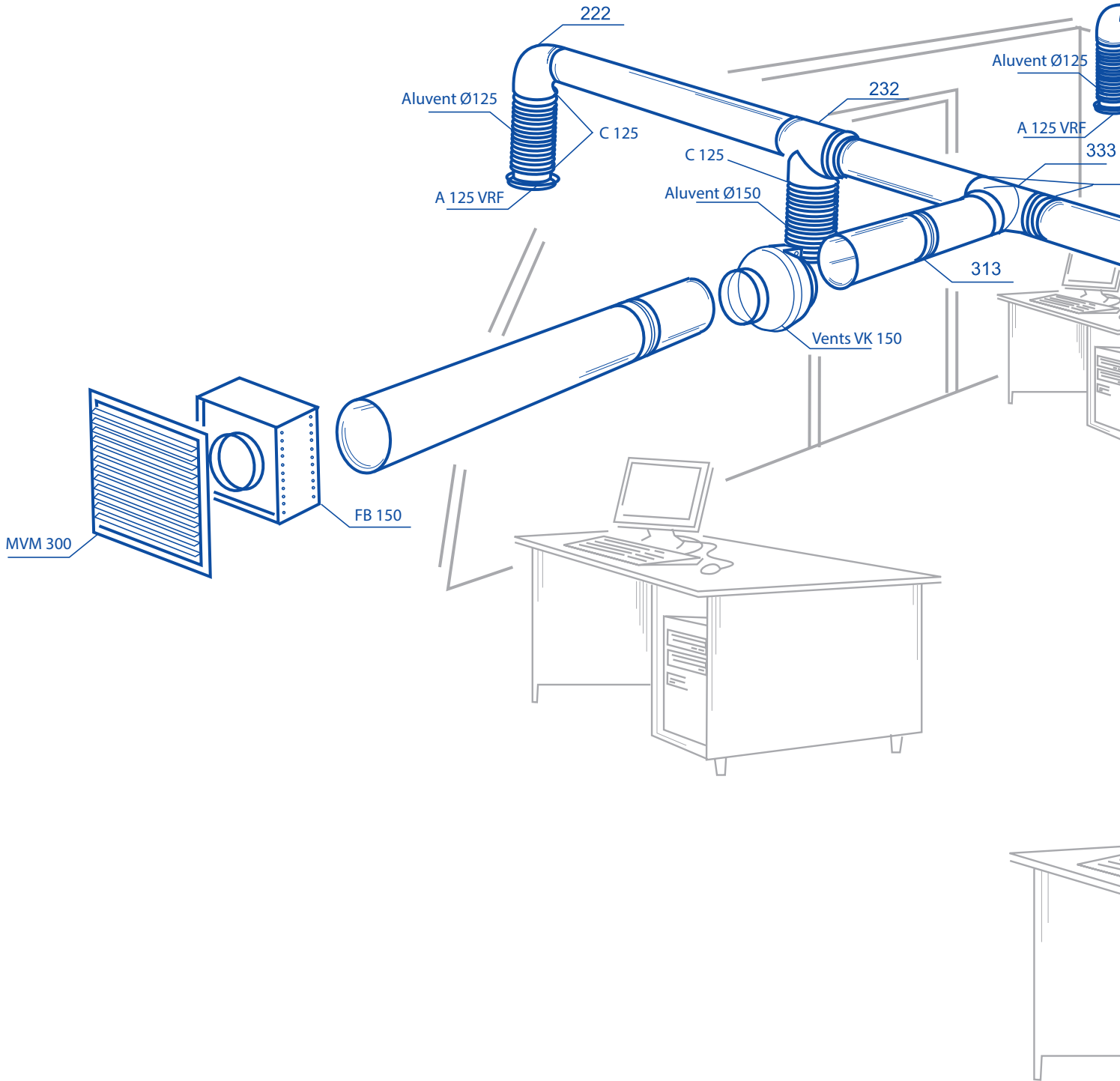

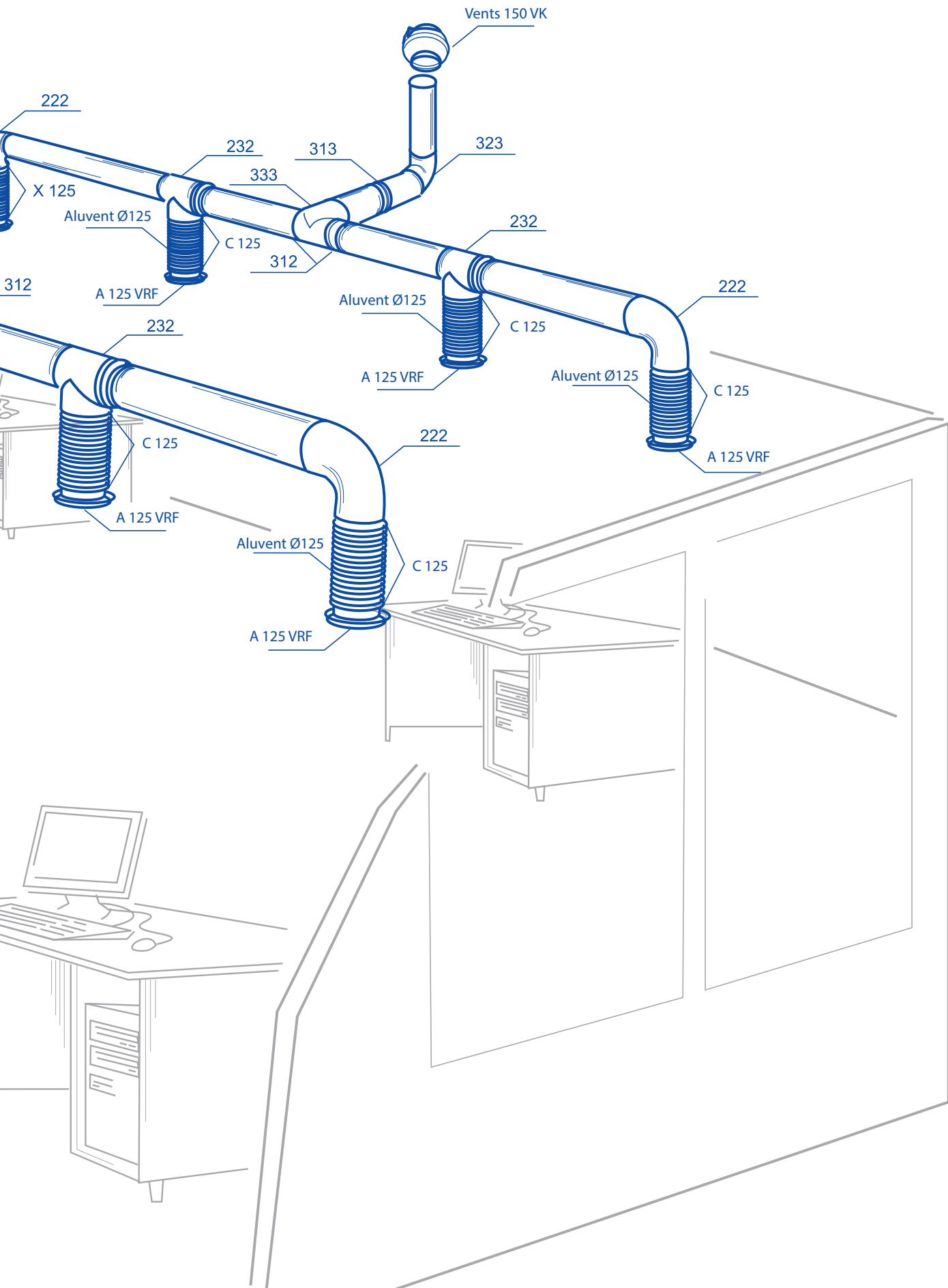

Round duct

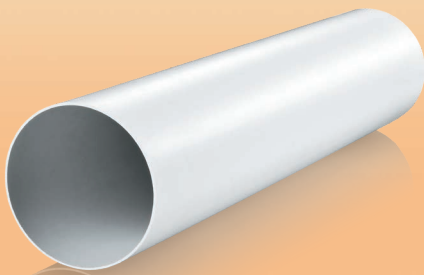

Application

- Supply and exhaust ventilation of various premises.
- Formation of round air ductworks.

Design

- Made of white PVC.
- Diameters: 100, 125, 150 and 200 mm.
- Duct length from 350 to 2500 mm.
- Connected with matching diameter connectors.

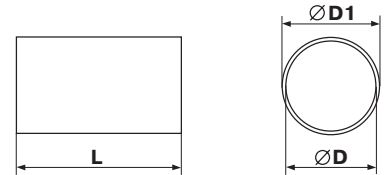

Code	Dimensions [mm]		
	D	D1	L
10035	100	103	350
20035	125	128	350
30035	150	153	350
40035	200	204	350
1005	100	103	500
2005	125	128	500
3005	150	153	500
4005	200	204	500
1010	100	103	1000
2010	125	128	1000
3010	150	153	1000
4010	200	204	1000
1015	100	103	1500
2015	125	128	1500
3015	150	153	1500
4015	200	204	1500
1020	100	103	2000
2020	125	128	2000

Code	Dimensions [mm]		
	D	D1	L
3020	150	153	2000
4020	200	204	2000
1025	100	103	2500
2025	125	128	2500
3025	150	153	2500
4025	200	204	2500
10035/2	104	107	350
20035/2	129	132	350
1005/2	104	107	500
2005/2	129	132	500
1010/2	104	107	1000
2010/2	129	132	1000
1015/2	104	107	1500
2015/2	129	132	1500
1020/2	104	107	2000
2020/2	129	132	2000
1025/2	104	107	2500
2025/2	129	132	2500

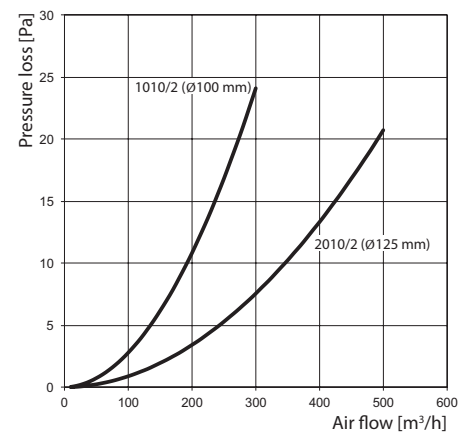
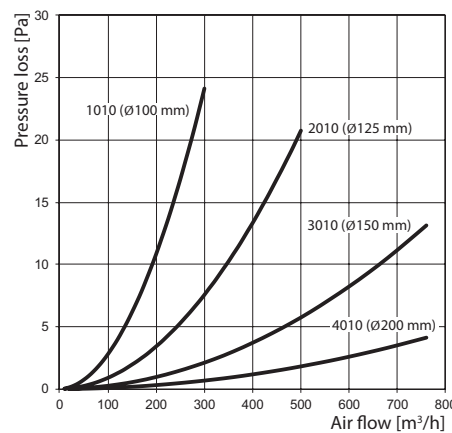

Data for 1 m air duct section

Round telescopic duct



Application

- Supply and exhaust ventilation of various premises.
- Wall mounting.

Code	Dimensions [mm]				
	D	D1	D2	D3	L
1805	100	103	104	107	300-500
2805	125	128	129	132	300-500
3805	150	153	154	157	300-500
1810	100	103	104	107	500-1000
2810	125	128	129	132	500-1000
3810	150	153	154	157	500-1000

Design

- Made of white PVC.
- Telescopic design of two parts.
- Diameters: 100, 125, 150 mm.
- Air duct length is adjusted within 300 to 500 or 500 to 1000 mm.

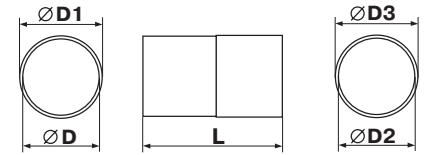

inner duct

outer duct

Round flexible duct connector



Application

- Supply and exhaust ventilation of various premises.
- Connection of flexible round ducts.

Code	Dimensions [mm]		
	a	D	D1
1113	60	100	103
2123	60	125	128
3133	60	150	153
4143	60	200	204

Design

- Made of white PVC.
- Cover the connector with air duct and fix it with clamps.
- Connecting diameters: 100, 125, 150, 200 mm.

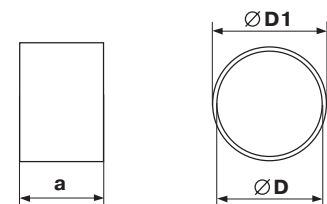

90° bend for round ducts



Application

- Supply and exhaust ventilation of various premises.
- Connection of same diameter air ducts at 90°.

Code	Dimensions [mm]			
	D	D1	a	b
121	100	97	137	30
222	125	122	164	30
323	150	147	189	30

Design

- Made of white plastic.
- Connecting diameters: 100, 125, 150 mm.

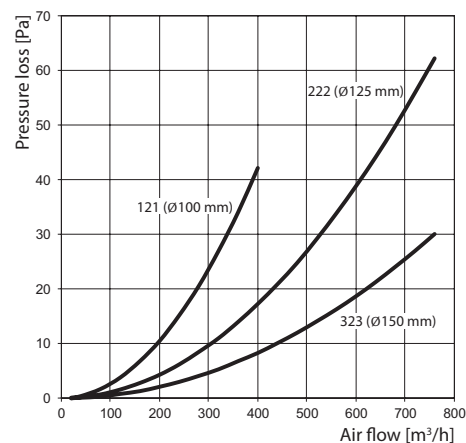
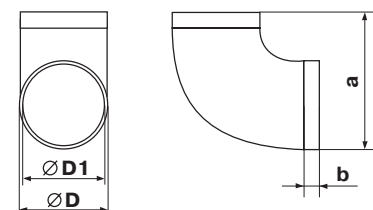

45° bend
for round ducts



Application

- Supply and exhaust ventilation of various premises.
- Connection of same diameter air ducts at 45°.

Design

- Made of white plastic.
- Connecting diameters: 100, 125 mm.

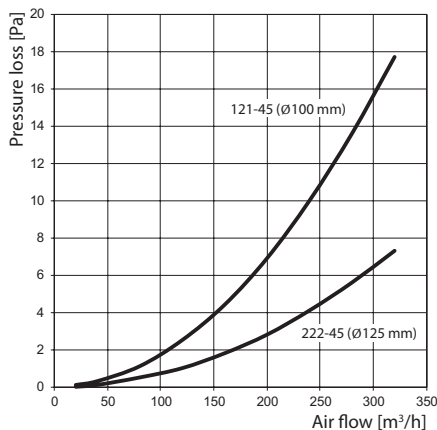

Code	Dimensions [mm]				
	D	D1	a	b	c
121-45	103	100	125	30	129
222-45	128	125	157	40	162

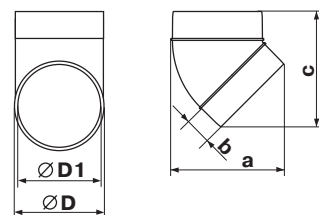

T-joint
for round ducts



Application

- Formation of branch connections in supply or exhaust ventilation systems located in residential, public and other buildings.
- Connection of same diameter round ducts and integration into complex ventilation systems.

Design

- Made of white plastic.
- Connection of same diameter three round ducts at 90°.
- Connecting diameters: 100, 125, 150 mm.

Code	Dimensions [mm]				
	D	D1	a	b	c
131	100	97	173	30	139
232	125	122	198	30	164
333	150	147	223	30	189

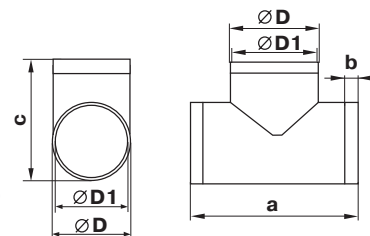

Wall plate
for round ducts



Application

- Supply and exhaust ventilation of various premises.
- Connection of air ducts to ventilation shafts.
- Decoration of mounting openings.

Design

- Made of white plastic.
- Screw fixing to wall.
- Connecting diameters: 100, 125, 150, 200 mm.

Code	Dimensions [mm]			
	D	h	a	b
15	103	3	150	134
25	128	3	170	154
35	151	3	204	188
45	204	3	250	230

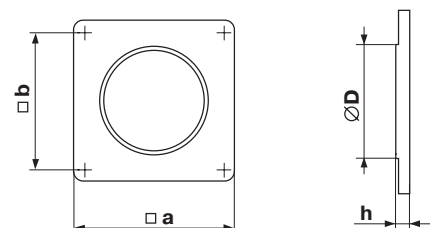

Round duct connector



Application

- Supply and exhaust ventilation of various premises.
- Connection of same diameter air ducts.

Design

- Made of white plastic.
- Designed for direct installation into air duct and equipped with a lock ring.
- Connecting diameters: 100, 125, 150, 200 mm.

Code	Dimensions [mm]		
	D	D1	a
111	100	96	62
212	125	123	62
313	150	148	62
414	200	197	62

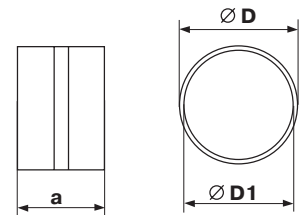

Connector with backdraft damper for round ducts



Application

- Supply and exhaust ventilation of various premises.
- Connection of same diameter air ducts.

Design

- Made of white plastic.
- Equipped with a backdraft damper for back flow prevention.
- Designed for direct installation into air duct and equipped with a lock ring.
- Connecting diameters: 100, 125, 150, 200 mm.

Code	Dimensions [mm]		
	D	D1	a
1111	100	96	62
2121	125	123	62
3131	150	148	62
4141	200	197	62

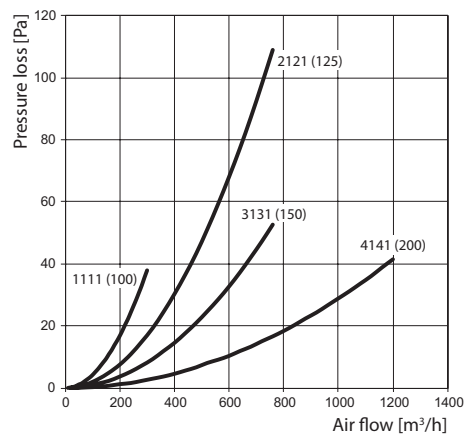
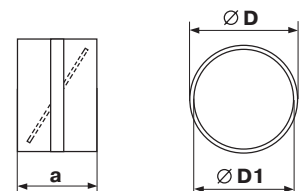

Connector with backdraft damper and wall plate for round ducts



Application

- Supply and exhaust ventilation of various premises.
- Connection of same diameter air ducts.
- Decoration of mounting openings.

Design

- Made of white plastic.
- Equipped with a wall plate for decoration of mounting openings.
- Equipped with a backdraft damper for back flow prevention.
- Screw fixing to wall.
- Connecting diameters: 100, 125, 150, 200 mm.

Code	Dimensions [mm]			
	a	b	c	D
1511	150	134	62	100
2521	170	154	62	125
3531	204	188	62	150
4541	250	230	62	200

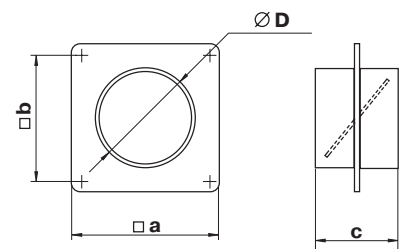

Connector with plate for round ducts



Application

- Supply and exhaust ventilation of various premises.
- Connection of same diameter air ducts.
- Decoration of mounting openings.

Design

- Made of white plastic.
- Equipped with a wall plate for decoration of mounting openings.
- Screw fixing to wall.
- Connecting diameters: 100, 125, 150, 200 mm.

Code	Dimensions [mm]			
	a	b	c	D
151	150	134	62	100
252	170	154	62	125
353	204	188	62	150
454	250	230	62	200

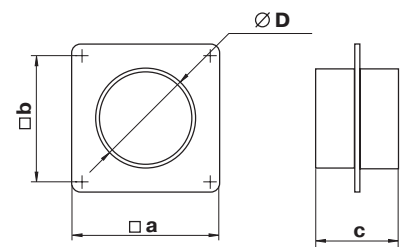

Reducer



Application

- Supply and exhaust ventilation of various premises.
- Connection of various diameter air ducts.

Design

- Made of white plastic.
- Connecting diameters: 80-100, 100-120, 100-125, 100-150, 125-150, 150-200 mm.

Code	Dimensions [mm]				
	a	D1	D2	D3	D4
110	60	103	100	76	80
211	60	129	125	96	100
311	96	154	150	98.5	100
312	60	154	150	121	125
413	71	204	200	146	150
611	60	124	120	98.5	99

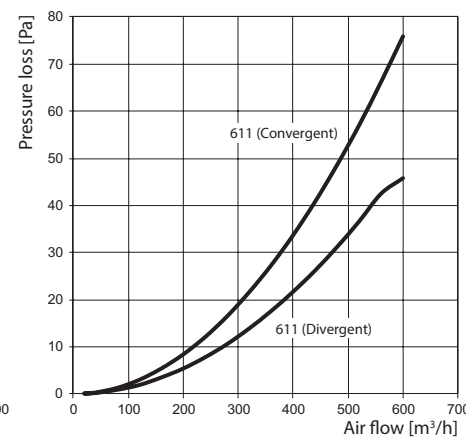
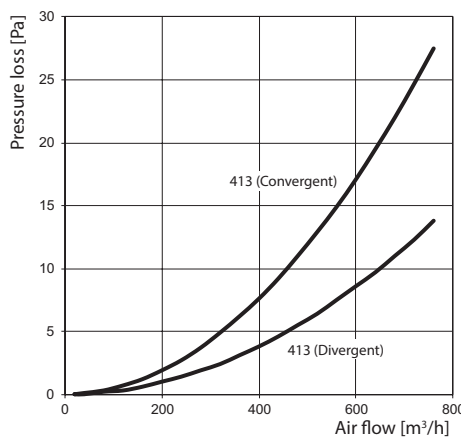
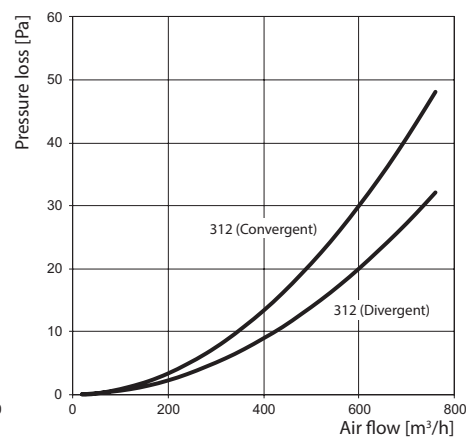
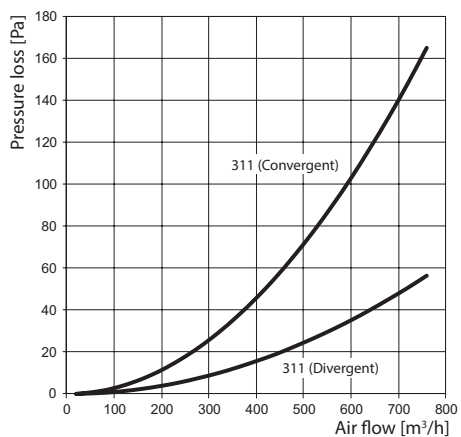
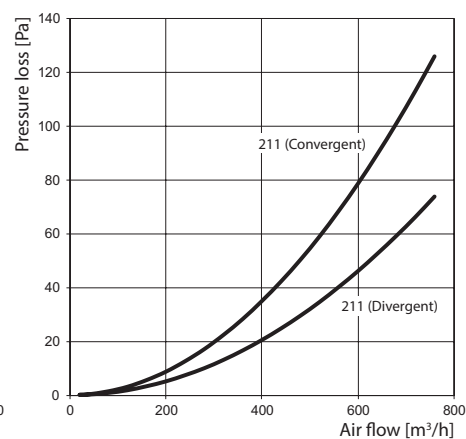
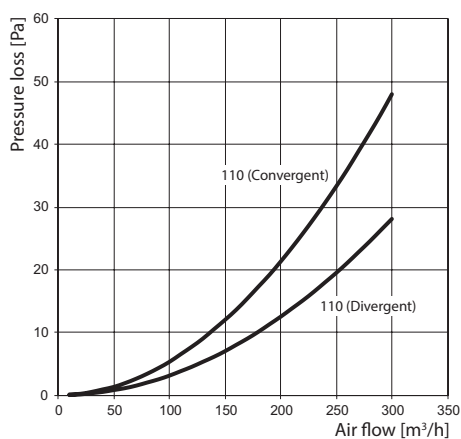
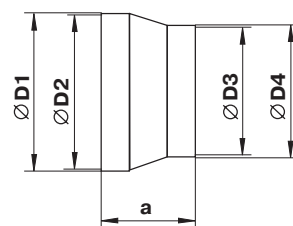

Reducer



Application

- Supply and exhaust ventilation of various premises.
- Connection of Ø 120 and 125 mm round air ducts.

Design

- Made of white plastic.
- Connecting diameters: 125-129 mm.

Code	Dimensions [mm]				
	a	D1	D2	D3	D4
216	42	129	125	115	119

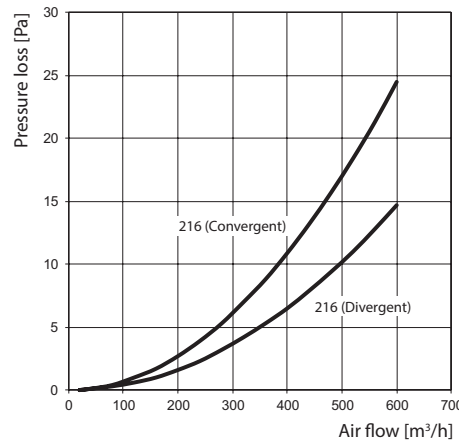
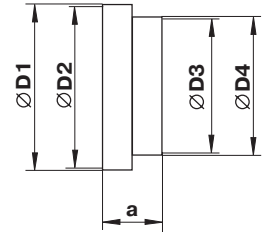

Round step reducer



Application

- Supply and exhaust ventilation of various premises.
- Connection of various diameter air ducts.

Design

- Made of white plastic.
- Connecting diameters: 80-100-120-125-150 mm.
- Cut out spare length piece to get the required size.

Code	Dimensions [mm]	
	a	Ø
310	125	80-100-120-125-150

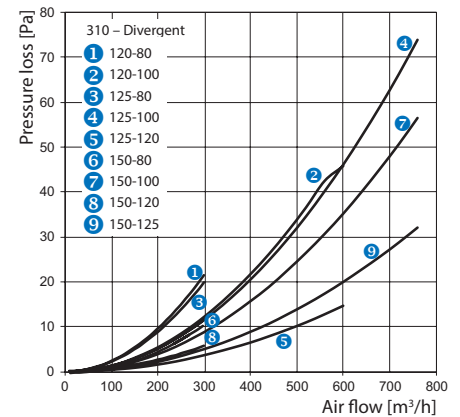
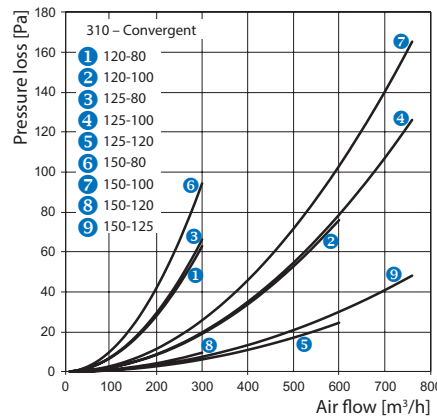
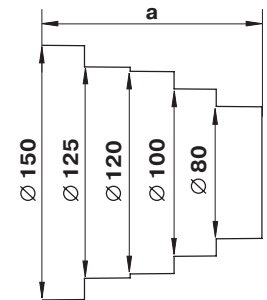

Eccentric reducer



Application

- Supply and exhaust ventilation of various premises.
- Connection of round ducts.

Design

- Made of white plastic.
- Connecting diameters: 100, 120, 125, 130, 150 mm.

Code	Dimensions [mm]						
	a	D1	D2	D3	D4	D5	D6
2118	90	125	120	123	103	99	-
3128	96	151	148	152	132	129	125

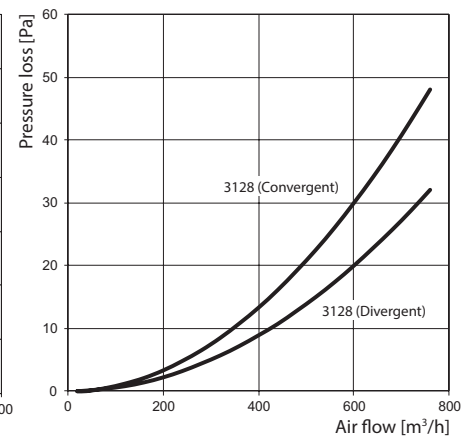
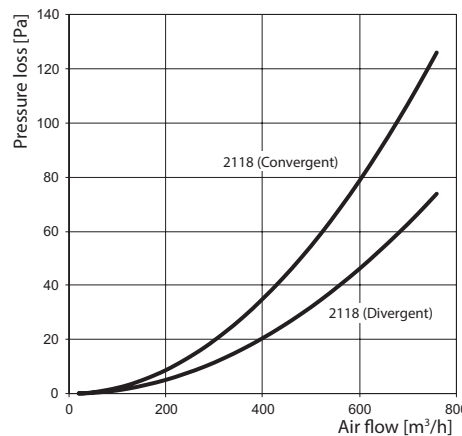
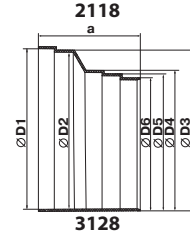
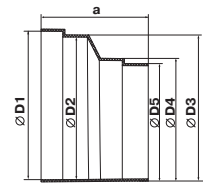

Round to flat connector



Application

- Supply and exhaust ventilation of various premises.
- Connection of round and flat ducts.

Design

- Made of white plastic.
- Direct connection to round and flat ducts.
- Connecting ducts: 100-55x110, 100-60x122, 125-60x204, 150-90x220 mm.

Code	Dimensions [mm]						
	a	a1	b	b1	D1	D2	L
511	113	110	59	55	103	100	137
711	124	122	64	60	103	100	137
812	208	204	64	60	128	125	140
913	224	220	94	90	150	146	165

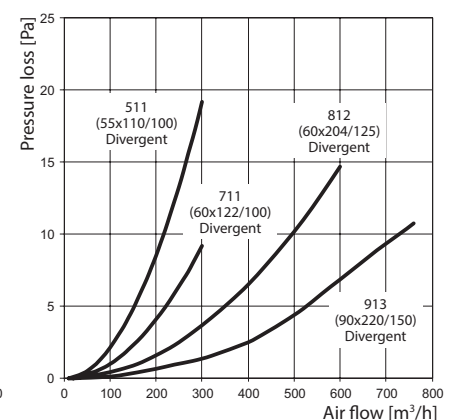
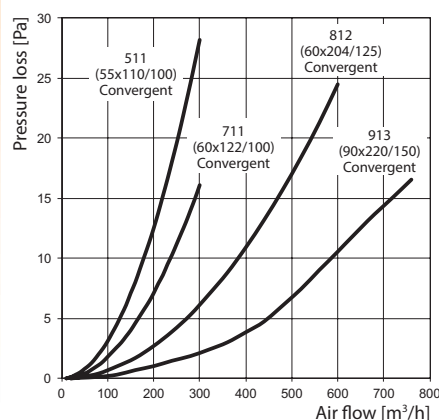
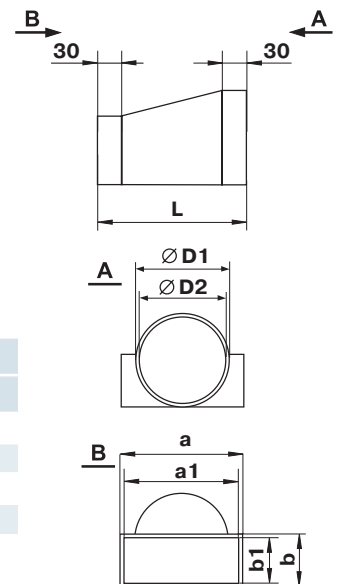

Round flexible duct connector



Application

- Supply and exhaust ventilation of various premises.
- Connection of flexible ducts with plastic system components.

Design

- Made of white plastic.
- Connection to flexible air ducts without clamps.
- Flexible spiral seam duct is connected to one side and the other side is connected to Ø 100 mm flange.
- Left or right (R) thread. Right thread connectors are used with Polyvents air ducts.

Code	Dimensions [mm]				
	A	B	C	D	E
1214	90	30	60	100	110
1214R	90	30	60	100	110

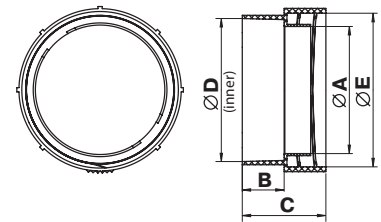

Round flexible duct connector



Application

- Supply and exhaust ventilation of various premises.
- Connection of flexible ducts with plastic system components.

Design

- Made of white plastic.
- Connection to flexible air ducts without clamps.
- Flexible spiral seam duct is connected to one side and the other side is connected to Ø 100 mm air duct.
- Left or right (R) thread. Right thread connectors are used with Polyvents air ducts.

Code	Dimensions [mm]				
	A	B	C	D	E
1215	90	30	60	100	110
1215R	90	30	60	100	110

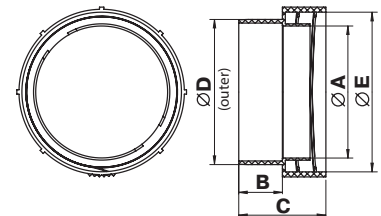

Holder
for round ducts



Application

- Supply and exhaust ventilation of various premises.
- Mounting of round ducts to wall, ceiling or any other plane surface.

Design

- Made of white plastic.
- Fixation to plane surface with screws.
- Special snaps provide reliable fixation of the duct with the holder.
- Connecting diameters: 100, 125, 150, 200 mm.

Code	Dimensions [mm]		
	a	b	D
16	113	20	103
26	138	20	128
36	163	20	153
46	213	20	203

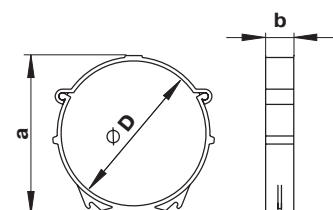

Flat air duct

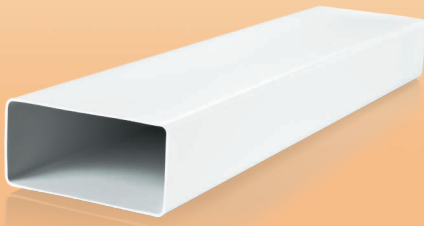

Application

- Supply and exhaust ventilation of various premises.
- Formation of flat air ductworks.

Design

- Made of white PVC.
- Size: 55x110, 60x122, 60x204, 90x220 mm.
- Duct length from 350 to 2500 mm.
- Connected with matching connectors.

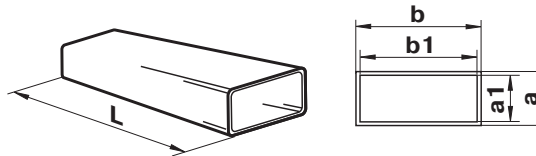

Code	Dimensions [mm]				
	a	b	a1	b1	L
50035	55	110	52	107	350
70035	60	122	57	119	350
80035	60	204	57	200	350
90035	90	220	86	216	350
5005	55	110	52	107	500
7005	60	122	57	119	500
8005	60	204	57	200	500
5010	55	110	52	107	1000
7010	60	122	57	119	1000
8010	60	204	57	200	1000
9010	90	220	86	216	1000
5015	55	110	52	107	1500
7015	60	122	57	119	1500
8015	60	204	57	200	1500
9015	90	220	86	216	1500
5020	55	110	52	107	2000
7020	60	122	57	119	2000
8020	60	204	57	200	2000
9020	90	220	86	216	2000
5025	55	110	52	107	2500
7025	60	122	57	119	2500
8025	60	204	57	200	2500
9025	90	220	86	216	2500

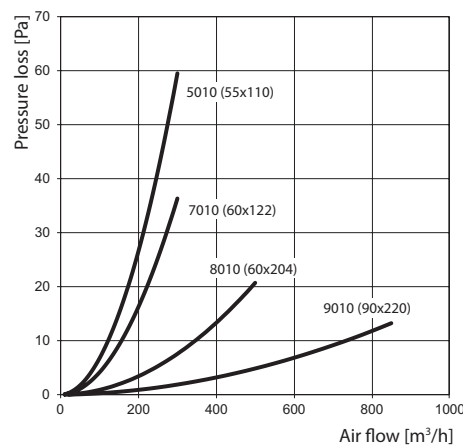

Data for 1 m air duct section

Flat duct connector



Application

- Supply and exhaust ventilation of various premises.
- Connection of same sized flat ducts.

Design

- Made of white plastic.
- Designed for installation into air duct and equipped with a lock ring for easy jointing.
- Connecting sizes: 55x110, 60x122, 60x204, 90x220 mm.

Code	Dimensions [mm]				
	a	b	a1	b1	c
515	56	110	59	114	66
717	60	122	65	126	69
818	60	204	65	209	62
919	90	220	95	225	62

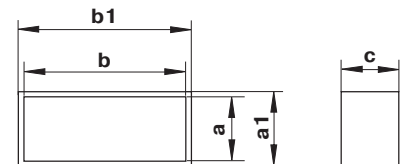

Flat duct connector with damper



Application

- Supply and exhaust ventilation of various premises.
- Connection of same sized flat ducts.

Design

- Made of white plastic.
- Designed for installation into air duct and equipped with a lock ring for easy jointing.
- Equipped with a backdraft damper for back flow prevention.
- Connecting sizes: 55x110, 60x122, 60x204, 90x220 mm.

Code	Dimensions [mm]				
	a	b	a1	b1	c
5151	56	110	59	114	66
7171	60	122	65	126	69
8181	60	204	65	209	62
9191	90	220	95	225	62

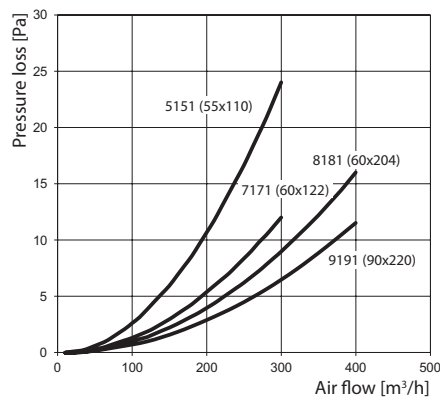
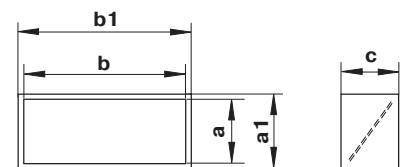

Flexible flat duct connector



Application

- Supply and exhaust ventilation of various premises.
- Connection of same sized flat flexible ducts.

Design

- Made of white PVC.
- Cover the connector with air duct and fix it with clamps.
- Connecting sizes: 55x100, 60x122, 60x204 mm.

Code	Dimensions [mm]				
	a	b	a1	b1	c
5153	55	110	52	107	60
7173	60	122	57	119	60
8183	60	204	57	200	60

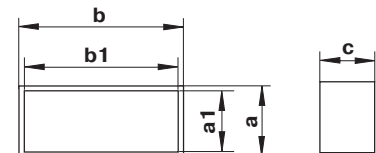

Air duct connector with a plate

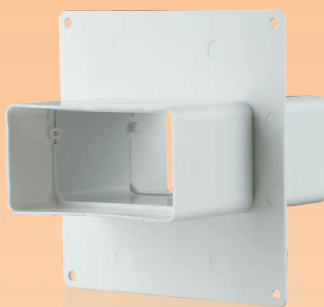

Application

- Supply or exhaust ventilation of various premises.
- Connection of single size flat air ducts.
- Decoration of mounting opening and connections to wall.

Design

- Made of white plastic.
- Air ducts are fitted inside the connector.
- Equipped with lock rings for easy adjustment.
- Screw fixing to wall.
- Connecting sizes: 55x110, 60x120, 60x204 mm.

Code	Dimensions [mm]							
	a	b	c	A	B	C	D	L
555	110	55	2	141	154	154	141	131
757	120	60	2	141	154	154	141	131
858	204	60	3	229	154	242	141	186

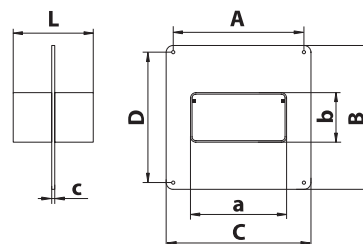

Air duct connector with a plate and a back valve



Application

- Supply or exhaust ventilation of various premises.
- Connection of single size flat air ducts.
- Decoration of mounting opening and connections to wall.

Design

- Made of white plastic.
- Air ducts are fitted inside the connector.
- Equipped with lock rings for easy adjustment.
- Equipped with a back valve to prevent back drafting.
- Screw fixing to wall.
- Connecting sizes: 55x110, 60x122, 60x204 mm.

Code	Dimensions [mm]							
	a	b	c	A	B	C	D	L
5551	110	55	2	141	154	154	141	131
7571	120	60	2	141	154	154	141	131
8581	204	60	3	229	154	242	141	186

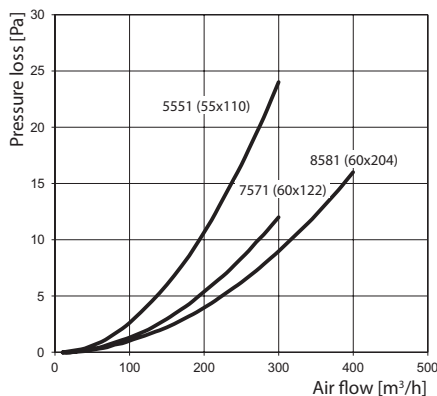
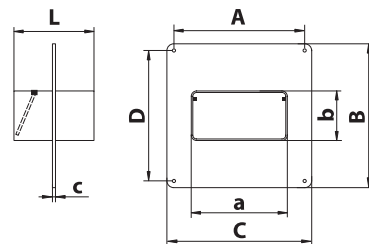

Vertical 90° bend for flat ducts



Application

- Supply and exhaust ventilation of various premises.
- Connection of same sized flat ducts at 90° vertically.

Design

- Made of white plastic.
- Connecting sizes: 55x110, 60x122, 60x204, 90x220 mm.

Code	Dimensions [mm]		
	a	b	c
5252	55x110	89	32
7272	60x122	93	32
8282	60x204	103	32
9292	90x220	130	35

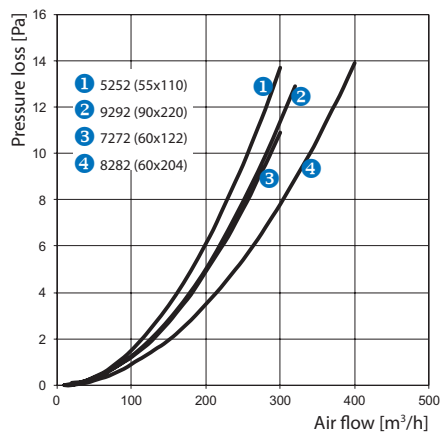
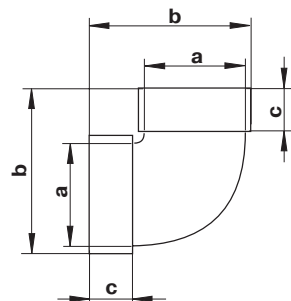

Horizontal 90° bend for flat ducts



Application

- Supply and exhaust ventilation of various premises.
- Connection of same sized flat ducts at 90° horizontally.

Design

- Made of white plastic.
- Connecting sizes: 55x110, 60x122, 60x204, 90x220 mm.

Code	Dimensions [mm]		
	a	b	c
5251	55x110	143	32
7271	60x122	155	32
8281	60x204	238	32
9291	90x220	262	35

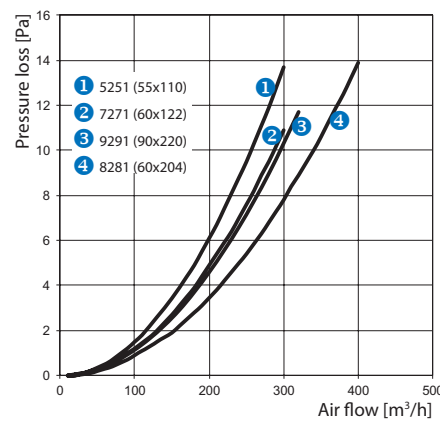
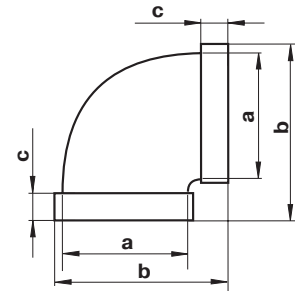

Versatile flat angular connector



Application

- Supply and exhaust ventilation of various premises.
- Angular connection of flat ducts.

Design

- Made of white plastic.
- Turning point angle from 3° to 48°.
- Depending on selected turning angle one connector side is cut out. Connection to the flat duct through matching sized connector.
- On flange side direct connection to flat duct of respective size.
- Connecting section: 55x100 and 60x204 mm.

Code	Dimensions [mm]		
	a	b	c
52510	190	143	55x110
82810	286	247	60x204

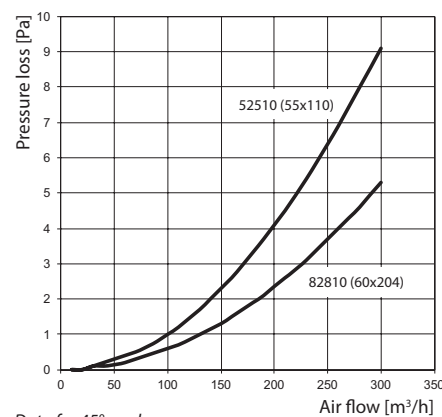

Data for 45° angle

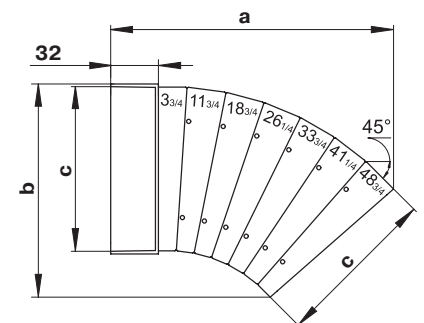

T-joint
for flat ducts



Application

- Formation of branch connections in supply or exhaust ventilation systems located in residential, public and other buildings.
- Connection of same sized flat ducts and integration into complex ventilation systems.

Design

- Made of white plastic.
- Connection of same sized three flat ducts at 90°.
- Connecting sizes: 55x110, 60x122, 60x204, 90x220 mm.
- Direct connection to matching sized ducts.

Code	Dimensions [mm]		
	a	b	c
535	144	174	55x110
737	155	185	60x122
838	248	288	60x204
939	261	296	90x220

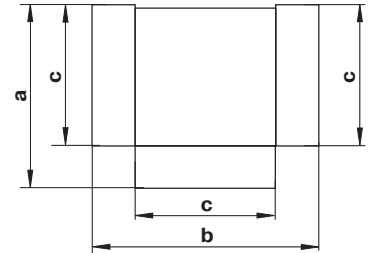

Flat duct holder



Application

- Supply and exhaust ventilation of various premises.
- Mounting of flat ducts to wall, ceiling or any other plane surface.

Design

- Made of white plastic.
- Fixation to plane surface with screws.
- Specially designed configuration provides reliable duct to holder fixation and quick dismantling.
- Connecting sizes: 55x110, 60x122, 60x204, 90x220 mm.

Code	Dimensions [mm]		
	a	b	c
56	114	59	74
76	126	64	86
86	209	65	169
96	227	95	175

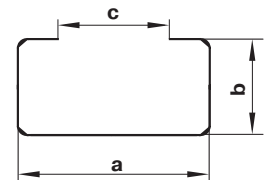

90° connecting bend for flat and round ducts



Application

- Supply and exhaust ventilation of various premises.
- Connection of flat and round ducts at 90°.

Design

- Made of white plastic.
- Connecting dimensions: 55x110-100, 60x122-100, 60x204-100, 60x204-125, 60x204-150, 90x220-125, 90x220-150 mm.
- Flat ducts have direct connection and round ducts are connected through a matching connector.

Code	Dimensions [mm]					
	a	D	D1	b	h	L
521	55x110	100	103	58x113	87	138
721	60x122	100	103	63x125	87	140
821	60x204	97	100	64x208	92	220
822	60x204	122	125	64x208	92	220
823	60x204	147	150	64x208	92	220
922	90x220	122	125	94x226	120	230
923	90x220	147	150	94x226	120	230

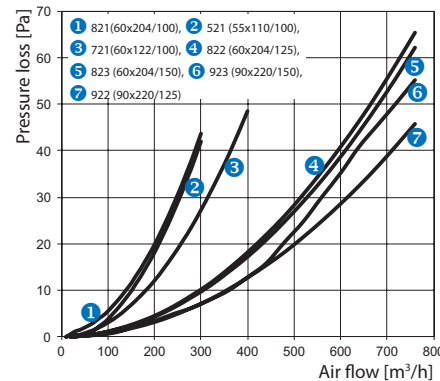
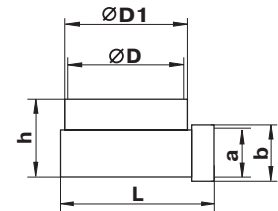

T-joint for flat and round ducts

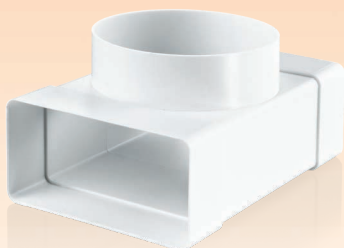

Application

- Formation of branch connections in supply or exhaust ventilation systems located in residential, public and other buildings.
- Connection of flat and round ducts.

Design

- Made of white plastic.
- Connecting dimensions: 55x110-100 mm.
- Direct connection to air duct.

Code	Dimensions [mm]						
	axb	D	D1	c	d	h	L
531	55x110	100	103	58	113	87	172

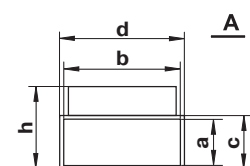
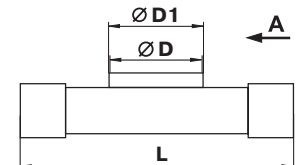

Reducer
for flat ducts

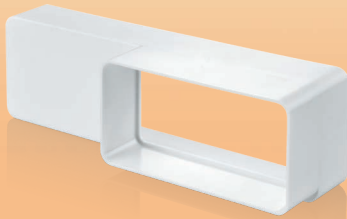

Wall plate
for flat ducts

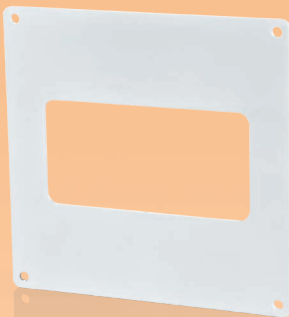

End grille



Application

- Supply and exhaust ventilation of various premises.
- Connection of flat different sized ducts.

Code	Dimensions [mm]		
	b	a	c
518	60x204	55x110	30

Design

- Made of white plastic.
- Connecting dimensions: 55x110-60x204 mm.

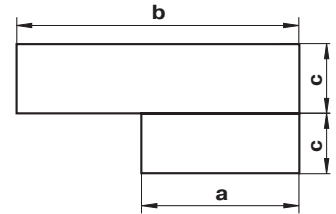

Application

- Supply and exhaust ventilation of various premises.
- Connection of air ducts to ventilation shafts.
- Decoration of mounting openings.

Design

- Made of white plastic.
- Screw fixing to wall.
- Connecting sizes: 55x110, 60x122, 60x204 mm.

Code	Dimensions [mm]						
	a	b	c	d	e	D	E
55	111	56	2	141	141	154	154
75	123	61	2	141	141	154	154
85	205	61	3	229	141	242	154

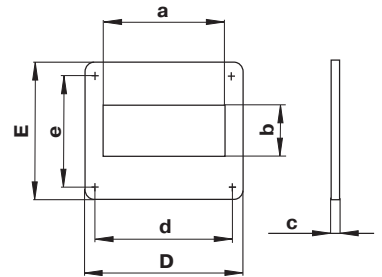

Application

- Decoration of supply or exhaust vents of public, residential and industrial ventilation systems.
- Correct air flow distribution in premises.
- Wall or ceiling mounting.

Design

- Made of white plastic.
- Detachable front part facilitates cleaning.
- Modification with an insect screen (s) is available.
- Connecting dimensions: 55x110 and 60x204 mm.

Code	Dimensions [mm]					
	a	b	c	d	e	f
571	88	137	114	59	73	9
871	93	232	208	64	76	9

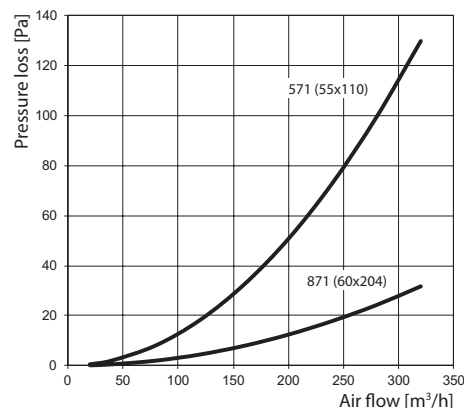
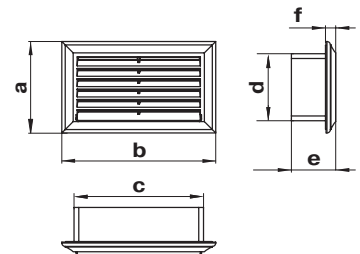

End grille with air pass regulation



Application

- Decoration of supply or exhaust vents of public, residential and industrial ventilation systems.
- Correct air flow distribution in premises.
- Wall or ceiling mounting.

Design

- Made of white plastic.
- Equipped with a movable flap for air flow regulation.
- Air pass is regulated with a tilt wand.
- Detachable front part facilitates cleaning.
- Modification with an insect screen (s) is available.
- Matches with 55x110 and 60x204 mm air ducts.

Code	Dimensions [mm]					
	a	b	c	d	e	f
572	88	137	114	59	73	18
872	93	232	208	64	76	18

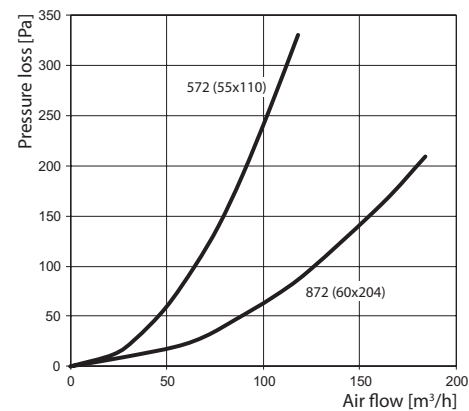
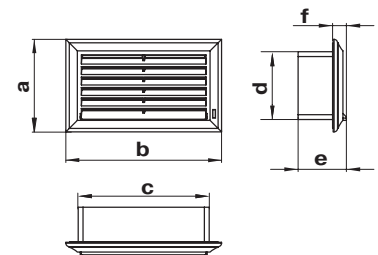

Reducer for flat and round ducts



Application

- Supply and exhaust ventilation of various premises.
- Flat to round duct connection.

Design

- Made of white plastic.
- Connecting dimensions: 55x110-100 mm.
- Direct connection of reducer to round and flat ducts.

Code	Dimensions [mm]			
	cx b	Ø D	f	a
115	58x114	103	62	32

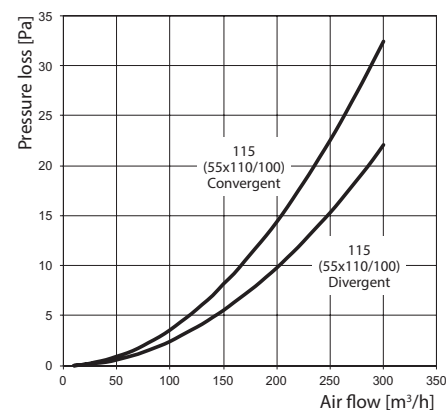
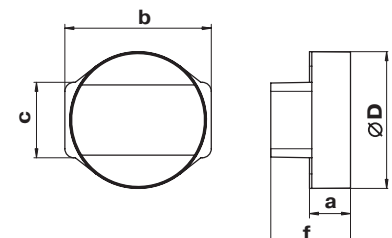

Reducer for flat and round ducts



Application

- Supply and exhaust ventilation of various premises.
- Flat to round duct connection.

Design

- Made of white plastic.
- Connecting dimensions: 55x110-100 mm.
- Reducer has direct connection to flat air ducts and connection through connector to round ducts.

Code	Dimensions [mm]			
	cxb	Ø D	f	a
1156	58x114	100	62	32

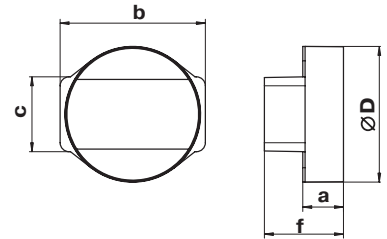
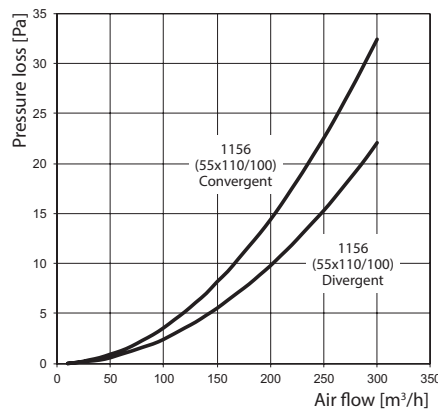

Wall plate with flange



Application

- Supply and exhaust ventilation of various premises.
- Connection of air ducts to ventilation shafts.
- Decoration of mounting openings.

Design

- Made of white plastic.
- Screw fixing to wall.
- Connecting sizes: 60x122 mm.

Code	Dimensions [mm]						
	a	b	c	d	D	e	E
750	126	172	3	65	113	60	65

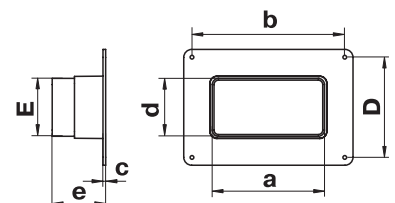

Round to flat connector (symmetric)



Application

- Supply and exhaust ventilation of various premises.
- Connection of round and flat ducts.

Design

- Made of white plastic.
- Direct connection flat duct, connection to round duct with connector.
- Connecting ducts: 100-60x122 mm.

Code	Dimensions [mm]							
	a	b	c	∅D	∅D1	e	h	L
7112	124	122	30	100	103	60	64	137

