



BRDV

VERTICAL OUTLET ROOF FANS

Fan Components and Material Properties

The models of BRDV series vertical centrifugal roof fans are manufactured from galvanized sheet steel. The models of BRDV 450-560 are made of aluminum sheet. Asynchronous motor is used in all models. The motor is out of airflow. The device is capable of carrying air at max.120°C.

Fan Structure

The fan blades are aerodynamically curved and provide regular flow. The fans are composed of backward sloping and infrequently arranged fins.

Benefits

BRDV roof fans provide a great advantage in applications with vertical shot feature in conditions where horizontal air is not allowed to be absorbed. Thanks to the aerodynamic wing structure, they work quietly. Speed can be adjusted with speed control devices. Since the rainwater is easily evacuated, water ingress is prevented from entering the chimney. Since the motor is out of

airflow, it is resistant to high temperature. Due to its high temperature resistance, the hot oil vapor absorbed from the hoods ensures a long distance to the vertical.

Speed Control

Optional control devices can be provided. Speed control can be done with linear voltage regulator in 1~phase products (see BSC accessory). Speed control with frequency inverter can be done in 3~phase products (see BSC-F accessory)

Usage Areas

In order to increase the air quality of indoor spaces, it is used in situations where vertical shot is required under conditions where air cannot be disposed horizontally. The BRF-V roof fans operate at low volume with an external rotor motor. It is used on the roofs of the places where the air is to be refreshed and the chimneys on the bathroom and wc roofs of the buildings which are opened to the common shaft.

Accessories

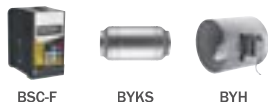

Technical Drawing and Tables

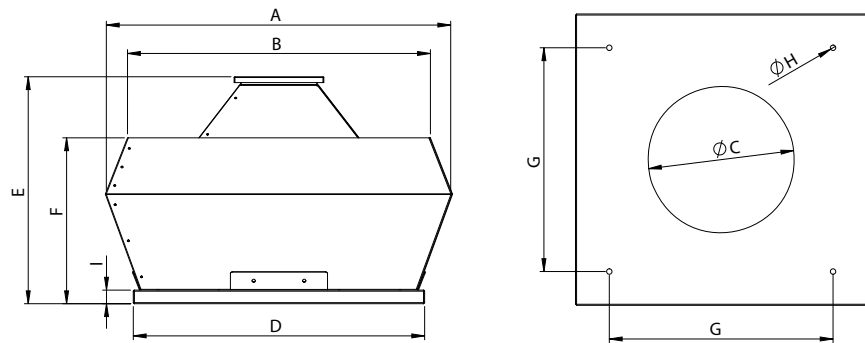

TYPE	A	B	C	D	E	F	G	H	I
BRDV 315	845	740	185	700	550	395	576	14	35
BRDV 355	845	740	235	700	550	395	576	14	35
BRDV 400	895	780	270	750	585	430	576	14	35
BRDV 450	960	855	282	800	595	440	625	14	35
BRDV 500	1030	915	320	850	695	490	675	14	35
BRDV 560	1195	960	360	950	820	610	740	14	35

Dimensions are in (mm)

TYPE	VOLTAGE	FREQUENCY	POWER	CURRENT	CAPACITOR	SPEED	AIR FLOW	SOUND PRESSURE	INSULATION CLASS	PROTECTION CLASS	WEIGHT
	V	Hz	kW	(A)	(µF)	r.p.m	m³/h	dB(A)	Ins.cl.	IP	kg
BRDV 315M	230	50	0,25	2,1	10	1380	1900	48-40	F	55	22
BRDV 355M	230	50	0,25	2,1	10	1380	2850	50-42	F	55	27
BRDV 400M	230	50	0,37	3,4	15	1390	4000	51-43	F	55	33
BRDV 450M	230	50	0,55	4,5	20	1365	5300	54-46	F	55	38
BRDV 500M	230	50	1,1	7,5	35	1410	8000	56-48	F	55	49
BRDV 560M	230	50	2,2	14,2	50	1420	10500	65-57	F	55	58
BRDV 315T	380	50	0,25	0,87	-	1380	1900	48-40	F	55	22
BRDV 355T	380	50	0,25	0,87	-	1380	2850	50-42	F	55	27
BRDV 400T	380	50	0,37	1,2	-	1390	4000	51-43	F	55	33
BRDV 450T	380	50	0,55	1,6	-	1365	5300	54-46	F	55	38
BRDV 500T	380	50	1,1	2,6	-	1410	8000	56-48	F	55	49
BRDV 560T	380	50	2,2	4,9	-	1420	10500	65-57	F	55	58

The sound level is measured at a distance of 4-10 m in open field condition.

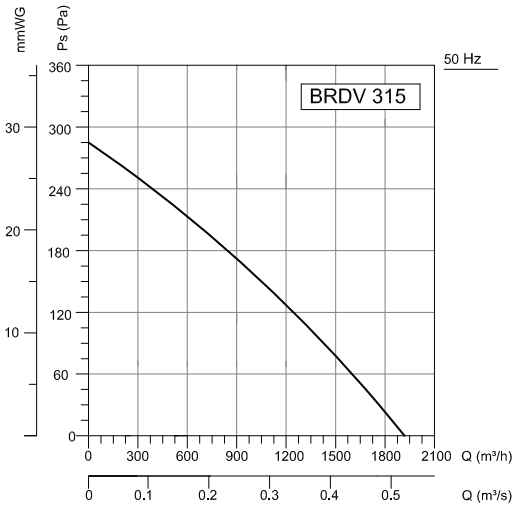

Frequency	Tot	63	125	250	500	1000	2000	4000	8000	Hz
L _{WA} Inlet	69	40	58	62	64	63	60	55	48	dB(A)
L _{WA} Surrounding	71	42	60	64	66	65	62	57	50	dB(A)

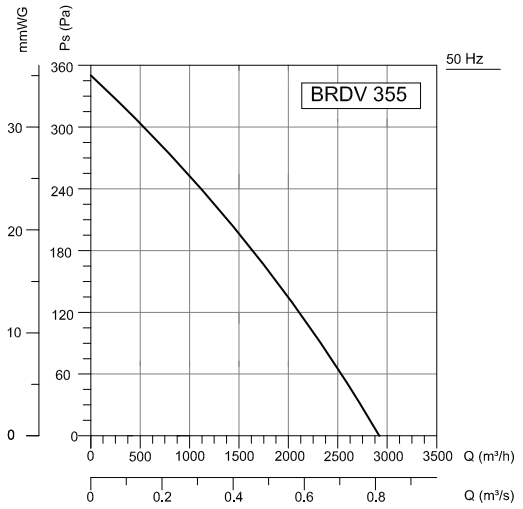

Frequency	Tot	63	125	250	500	1000	2000	4000	8000	Hz
L _{WA} Inlet	71	42	60	64	66	65	62	57	50	dB(A)
L _{WA} Surrounding	73	44	62	66	68	67	64	59	52	dB(A)

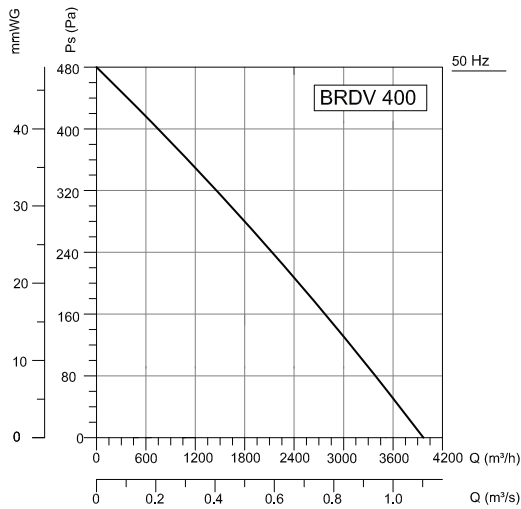

Frequency	Tot	63	125	250	500	1000	2000	4000	8000	Hz
L _{WA} Inlet	72	59	61	65	67	66	63	58	51	dB(A)
L _{WA} Surrounding	74	61	63	67	69	68	65	60	53	dB(A)

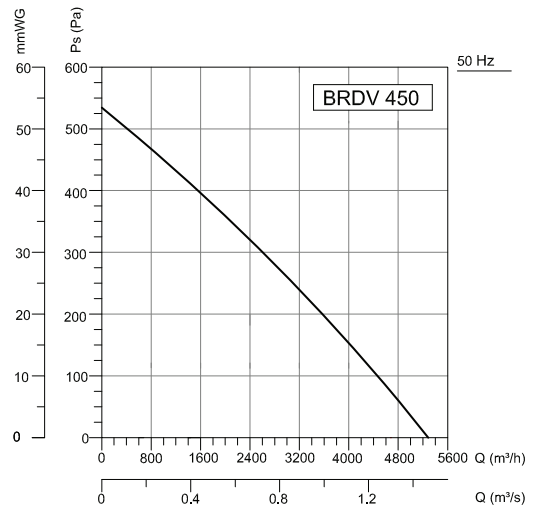

Frequency	Tot	63	125	250	500	1000	2000	4000	8000	Hz
L _{WA} Inlet	75	62	64	68	70	69	66	61	54	dB(A)
L _{WA} Surrounding	77	64	66	70	72	71	68	63	56	dB(A)

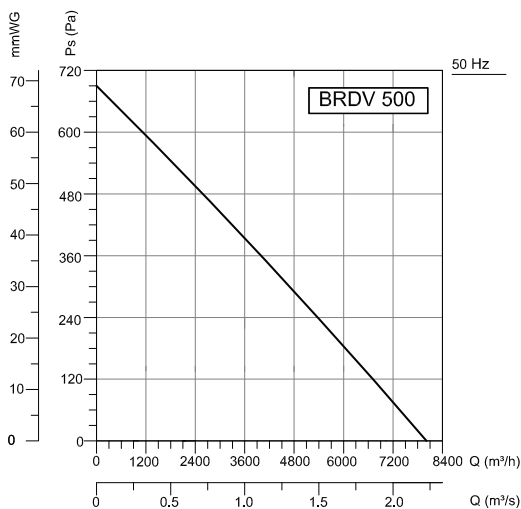

Frequency	Tot	63	125	250	500	1000	2000	4000	8000	Hz
L _{WA} Inlet	72	59	61	65	67	66	63	58	51	dB(A)
L _{WA} Surrounding	79	66	68	73	74	73	70	65	58	dB(A)

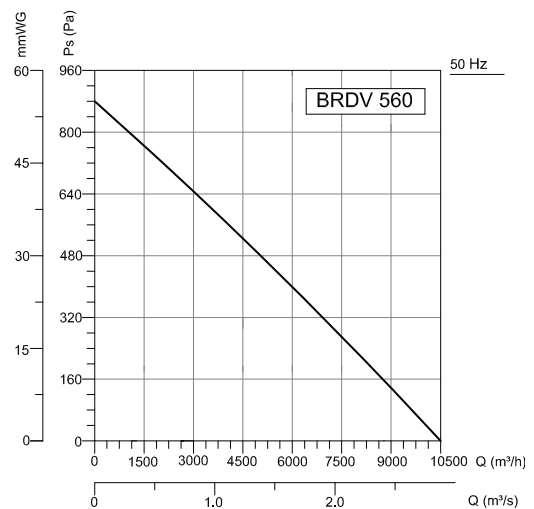

Frequency	Tot	63	125	250	500	1000	2000	4000	8000	Hz
L _{WA} Inlet	86	73	75	79	81	80	77	72	65	dB(A)
L _{WA} Surrounding	88	75	77	81	83	82	79	74	67	dB(A)