

FANS FOR ROUND DUCTS

 Series
VENTS VKM EC

Inline centrifugal fans with the air flow up to **1370 m³/h** in steel casing

Application

Supply and exhaust ventilation and air conditioning systems for various premises requiring cost-effective solution and controllable ventilation. EC motors applied in VKM fans reduce energy demand by about 35% and ensure high aerodynamic performance and low noise level. Such

characteristics are of special importance for ventilation of public premises as banks, supermarkets, restaurants, hotels, installation close to residential buildings and for domestic application, e.g. ventilation of private pools. EC motors enable integration of several fans into a unified networks and their centralized control. The steel casing ensures reliable operation of the fan in case of its outside installation. The fans are designed for connection to Ø 100, 125, 150, 160, 200, 250 and 315 mm air ducts.

Design

The fan casing is made of polymer coated steel. New technologies for manufacture of the fan components let attain the total casing air tightness.

Motor

The impellers with backward curved blades are powered with a high efficient electronically commutated (EC) direct current motor with external rotor. As of today, such motor type is the most advanced solution for energy saving. EC motors are featured by high performance and the best speed controllable range. Premium efficiency reaching up to 90% is the absolute advantage of electronically commutated motors. The motors are equipped with ball bearings for longer service life of the fan (40 000 hours). For precise features, safe operation and low noise, each turbine is dynamically balanced while assembly. Motor ingress protection rating IP44.

Speed control

The fan is controlled with the external control signal 0-10 V (air flow control as a function of temperature, pressure, smoke conditions and other parameters). Should the control value get changed, the EC motor adjusts its speed and the fan boosts as much air flow to the ventilation system as required. Maximum speed of the fan does not depend on the current frequency and it can operate at 50 or 60 Hz mains supply. The fans may be integrated into the unified dispatch system. The respective software enables to control all the fan integrated into the system. The computer displays all the system parameters. Each fan in the system may be individually adjusted.

Mounting

The fans may be installed at any angle. The fixing brackets that are included into the delivery set are used to facilitate the fan mounting to the wall. The fan is connected to power mains through the external terminal box.

Overall dimensions

Model	Dimensions [mm]									Mass [kg]
	ØD	ØD1	H	B	B1	L	L1	L2	L3	
VKM 100 EC	98	255	340	310	270	203	20	25	30	3,45
VKM 125 EC	123	255	340	310	270	203	20	25	30	3,58
VKM 150 EC	149	305	365	360	320	240	25	25	30	4,7
VKM 160 EC	159	305	365	360	320	240	25	25	30	4,9
VKM 200 EC	198	345	435	395	355	245	25	30	40	5,7
VKMS 200 EC	198	345	435	395	355	255	25	30	40	5,7
VKM 250 EC Q	248	345	435	395	355	250	25	30	40	5,1
VKM 250 EC	248	345	435	395	355	250	25	30	40	5,1
VKM 315 EC	314	405	465	455	415	260	30	30	40	7,3

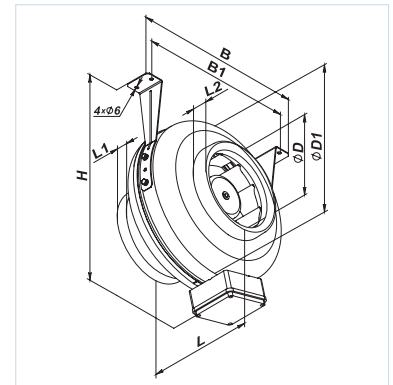
Designation key

Series	Air duct diameter	Motor	Options
VENTS VKM VENTS VKMS: High-power version	100; 125; 150; 160; 200; 250; 315	EC: electronically commutated synchronous motor	Q: low-power motor. Un: speed controller with electronic thermostat and external temperature sensor fixed on 4 m cable. P: built-in smooth speed controller. R1: power cable with a mains plug.

Accessories

Technical data

	VKM 100 EC	VKM 125 EC	VKM 150 EC	VKM 160 EC	VKM 200 EC
Voltage [V/50 (60) Hz]	1~230				
Power [W]	90	83	107	108	83
Current [A]	0.70	0.58	0.89	0.90	0.63
Max. air flow [m ³ /h]	345	480	700	785	845
RPM [min ⁻¹]	3600	3400	3060	3030	2500
Noise level at 3 m [dBA]	44	45	48	48	47
Transported air temperature [°C]	-25...+60				
SEC class	B	B	B	B	B
Protection rating	IPX4				

VENTS VKM EC
FAN SERIES

	VKMS 200 EC	VKM 250 EC Q	VKM 250 EC	VKM 315 EC
Voltage [V/50 (60) Hz]	1~230			
Power [W]	100	100	164	164
Current [A]	0.74	0.74	1.15	1.15
Max. air flow [m ³ /h]	1010	985	1230	1370
RPM [min ⁻¹]	2400	2500	2900	2900
Noise level at 3 m [dBA]	48	44	46	48
Transported air temperature [°C]	-25...+60			
SEC class	B	B	-	-
Protection rating	IPX4			

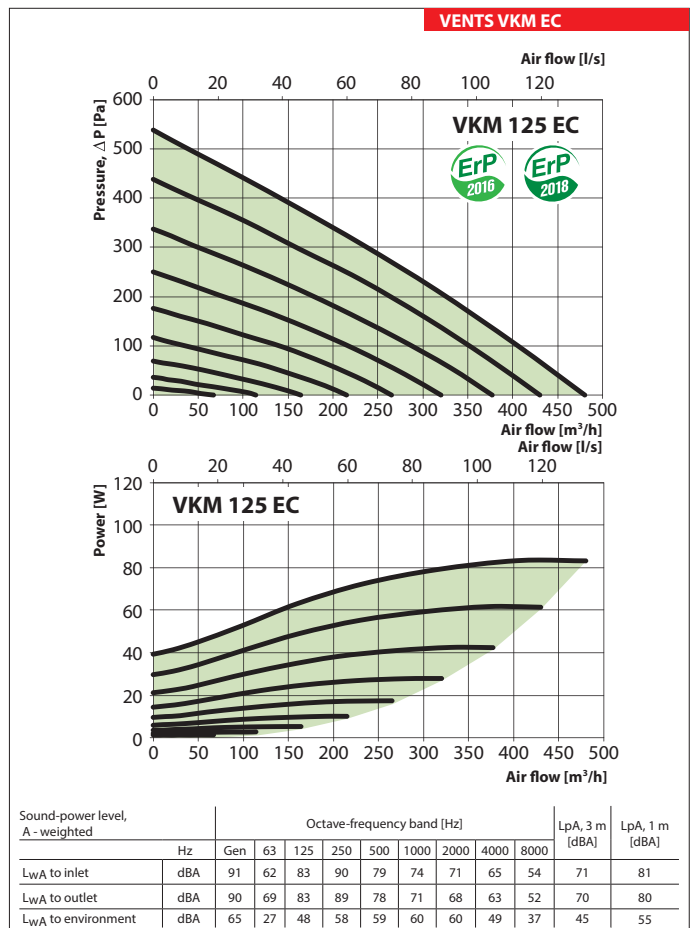
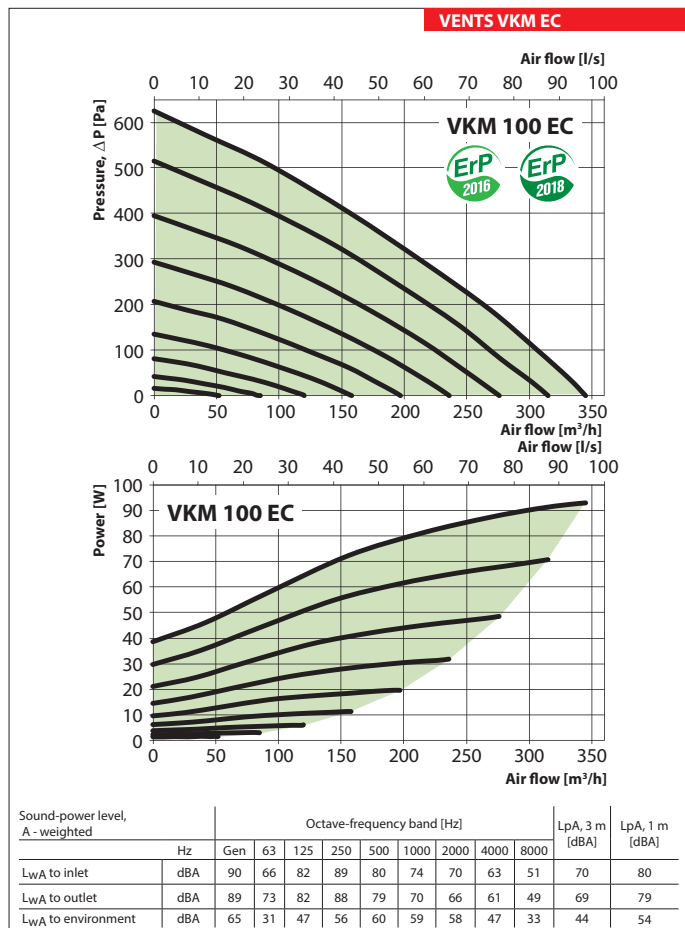

FANS FOR ROUND DUCTS

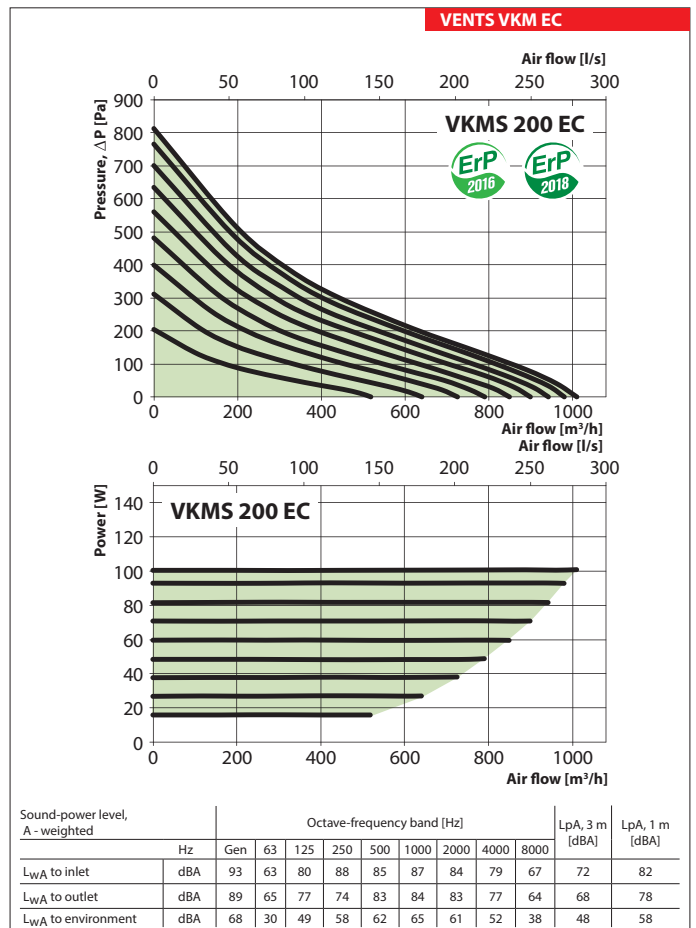
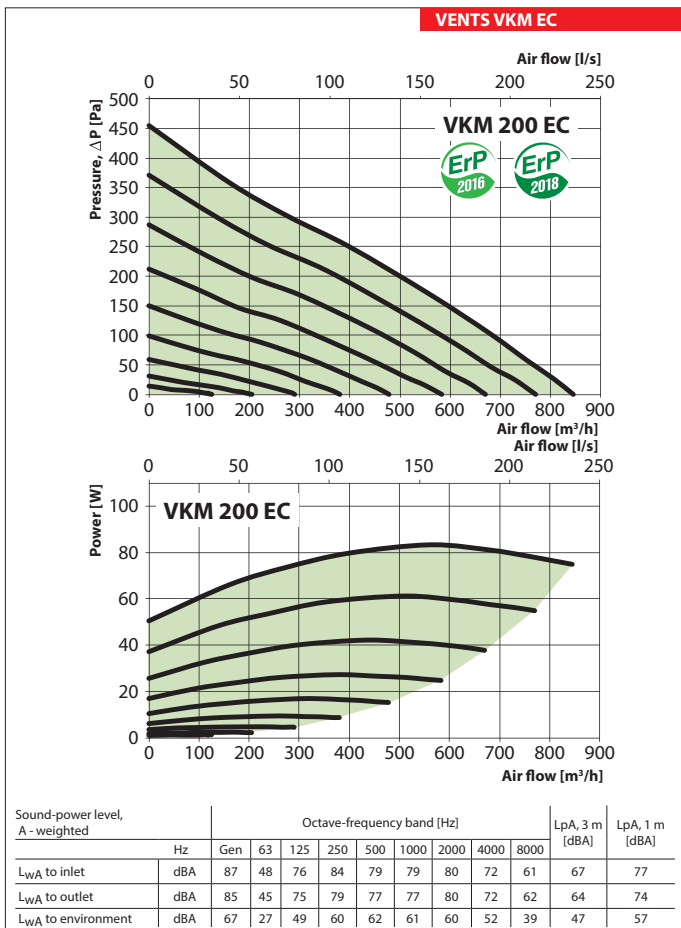
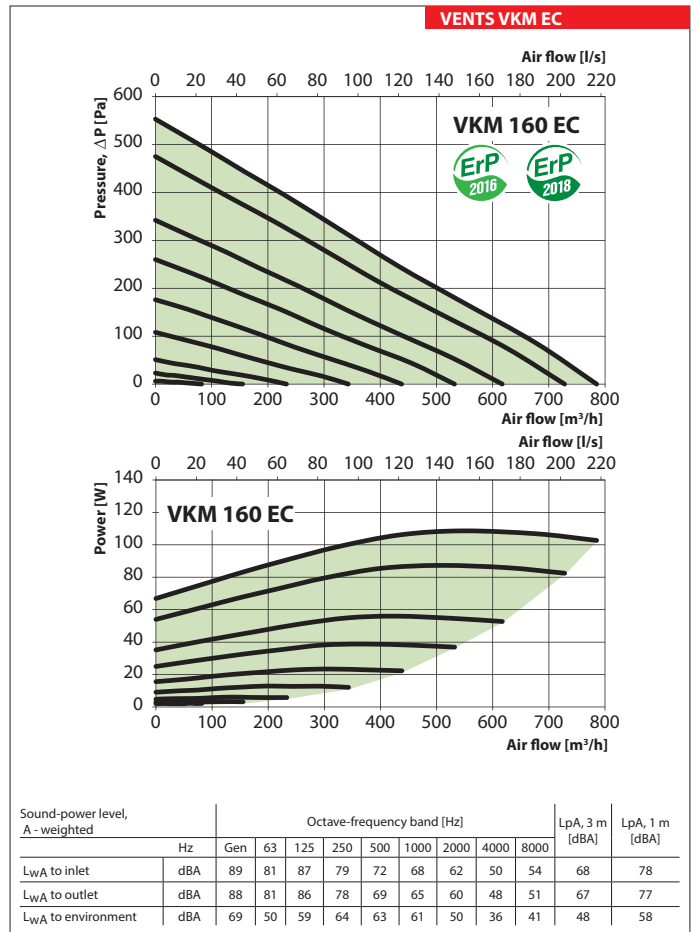
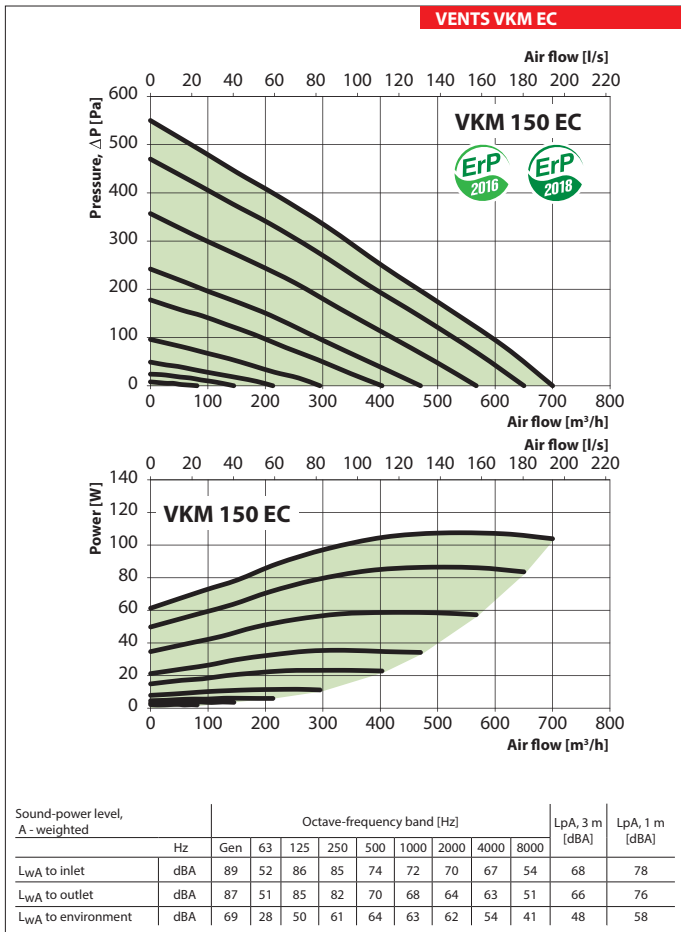

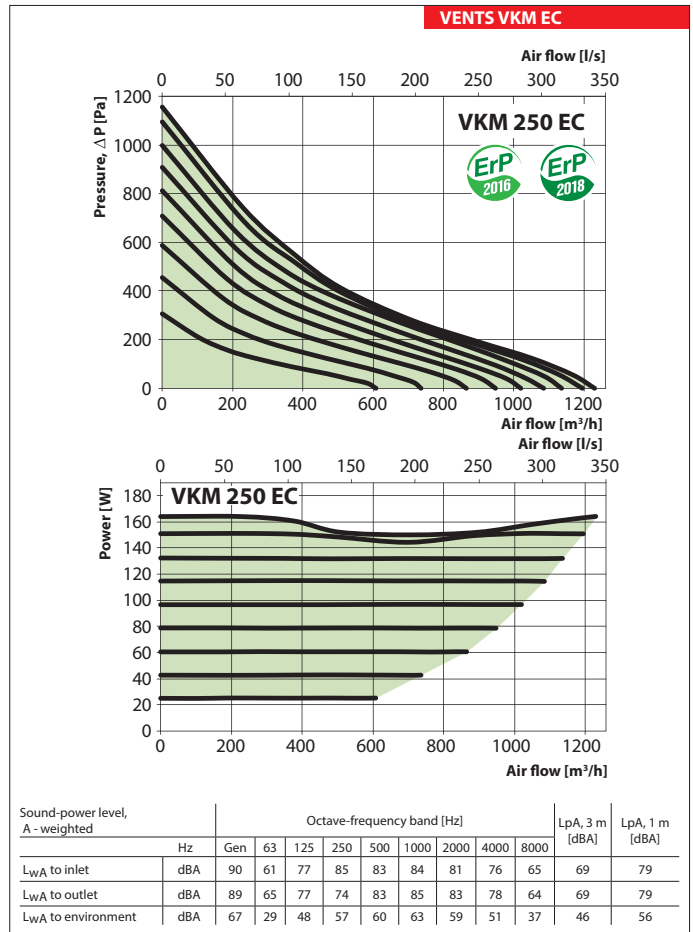
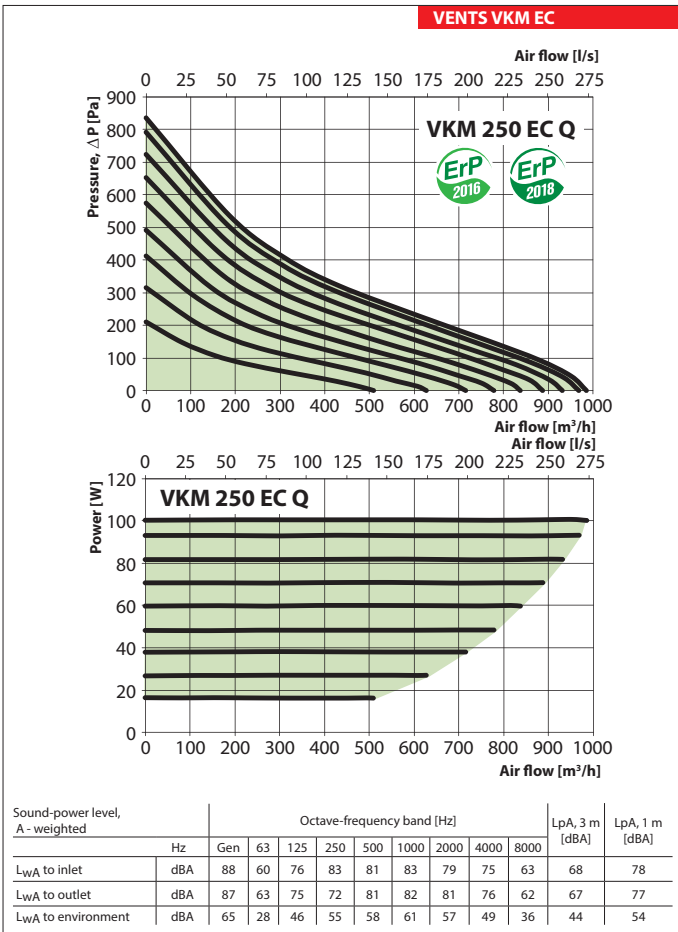

VENTS VKM EC
FAN SERIES

