



model
VENTS Quiet

EN AXIAL FANS
user's manual



Disconnect the fan from power mains prior to any connection, servicing and repair operations. Mounting and maintenance are allowed for duly qualified electricians with valid electrical work permit for electric operations at the units up to 1000 V after careful study of the present user's manual. The single-phase power mains must comply with the acting local electrical norms and standards. The fixed electrical wiring must be equipped with an automatic circuit breaker. The fan must be connected to power mains through an automatic circuit breaker QF integrated into the fixed wiring system with the gap between the breaker contacts on all poles not less than 3 mm.

Check the fan for any visible damages of the impeller and the casing before starting installation. The casing internals must be free of any foreign objects which can damage the impeller blades. While mounting the fan avoid the casing compression! Deformation of the casing may result in the motor jam and excessive noise.

The fan is not to be used by children and persons with reduced physical, mental or sensory capacities, without proper practical experience or expertise, unless they are controlled or instructed on the product operation by the person(s) responsible for their safety.

Do not leave children unattended and do not let them play with the fan.

Take steps to prevent ingress of smoke, carbon monoxide and other combustion products into the room through open chimney flues or other fire-protection devices. Sufficient air supply must be provided for proper combustion and exhaust of gases through the chimney of fuel burning equipment to prevent back drafting. Transported air must not contain any dust or other solid impurities, sticky substances or fibrous materials.

Do not use the fan in a hazardous or explosive environment containing spirits, gasoline, insecticides, etc. Do not close or block the fan intake or extract vents in order to ensure the most effective air passage. Do not sit on the fan and do not put objects on it.

Follow the user's manual requirements to ensure durable and trouble-free operation of the fan.



Recycle at the end of the service life.

Do not dispose the product with unsorted municipal trash.



Read the user's manual carefully before proceeding with installation works.
Compliance with the manual requirements ensures reliable operation and long service life of the product.
Keep the user's manual available as long as you use the product.
You may need to re-read the information on the product servicing.

DELIVERY SET

1. Fan - 1 item;
2. Screws and dowels - 4 items;
3. Plastic screwdriver - 1 item (only for the models with a timer);
4. User's manual;
5. Packing box.

BRIEF DESCRIPTION

The products is an axial fan for exhaust ventilation of small to medium-sized premises.

The fan is designed for connection to 100, 125 and 150 mm air ducts.

The fans with the connecting diameter 100 and 125 mm are equipped with a single-speed motor and the fan with the connecting diameter 150 mm is equipped with a double-speed motor.

VENTS 150 Quiet Extra fan model is equipped with a high-powered motor.

The fan is fitted with a back valve that prevents air backdrafting when the fan is off.

VENTS 100/125/150 Quiet - basic model.

VENTS 100/125/150 Quiet V - equipped with a pull cord switch.

VENTS 100/125/150* Quiet T - equipped with a turn-off delay timer adjustable from 2 up to 30 minutes.

VENTS 100/125/150* Quiet VT - equipped with a pull cord and a turn-off delay timer adjustable from 2 up to 30 minutes.

VENTS 100/125/150* Quiet TP - equipped with a turn-off delay timer adjustable from 2 up to 30 minutes and a motion sensor with a reach distance 1-4 m and a viewing angle up to 100°.

VENTS 100/125/150* Quiet TH - equipped with a turn-off delay timer adjustable from 2 up to 30 minutes and a humidity sensor adjustable from 60% up to 90%.

VENTS 100/125/150* Quiet VTH - equipped with a pull cord, turn-off delay timer adjustable from 2 up to 30 minutes and a humidity sensor adjustable from 60% up to 90%.

* - the model VENTS 150 Quiet T/TH/VT/VTH is extra equipped with a turn-on delay timer adjustable from 0 up to 2 minutes.

OPERATION GUIDELINES

The fan is designed for connection to AC 220-240 V, 50/60 Hz power mains. The model 12 is designed for connection to 12 V, 50 Hz power mains directly or to AC 220-240 V, 50 Hz power mains through the step-down transformer, for example, TRF 220/12-25 (optional).

Air flow direction in the system must match the pointer direction on the fan casing.

The fan is rated for operation at the ambient temperature ranging from +1 °C up to +45 °C.
Ingress protection rating against access to hazardous parts and water ingress IP 45.

The fan requires no grounding.

MOUNTING

The fan is designed for top or horizontal installation and connection to a ventilation shaft or a round air duct of a matching diameter, fig. 2.

Attention! In case of vertical mounting the fan must be protected against ingress of rainfalls and condensate inside the fan.

Fan installation with direct air discharge upwards is not allowed, fig. 3.

The fan mounting sequence is shown in fig. 4-12.

The fan wiring diagrams are shown in fig. 13-16, 18-20, 23-29.

Warning! Applicable only for 150 Quiet and 150 Quiet V.

Parallel power supply to the terminals 1 and 2, Fig. 21, is not allowed! That results in the fan breakdown.

The operating mode selection for the fans 150 Quiet T, TH, VT, VTH, TP are shown in fig. 22.

The visual operation indication for the fans 150 Quiet T, TH, VT, VTH, TP is shown in fig. 31.

Adjustment of the turn-off delay timer, the turn-on delay timer and the humidity sensor is shown in fig. 17, 30.

Warning! Only for 150 Quiet T, TH, VT, VTH, TP.

If one of the following events that actuated the turn-on delay timer operation (from 0 to 120 seconds):

power voltage cut-off to the input terminal 1;

no motion detection more in the premise;

humidity drop below the set level;

ceased to exist during its countdown, the fan remains in the previous operation mode.

MAINTENANCE

The fan maintenance periodicity is at least once per 6 months.

To clean the fan use a soft cloth or a brush wetted in a mild detergent solution, fig. 32-37.

WARNING! Avoid water dripping on the electric components.

Wipe the fan surfaces dry after cleaning.

TRANSPORTATION AND STORAGE RULES

Transport the product by any transportation vehicle in the manufacturer's original package.

Store the delivered product in the manufacturer's original packing box in a dry ventilated premise with the temperature range from +5eC up to +40eC and relative humidity less than 80%.

The storage environment must not contain dust, acid or alkali vapours that may cause corrosion of the product parts.

MANUFACTURER'S WARRANTY

The fan is manufactured at the factory of "Ventilation systems" PrJSC (hereinafter referred to as the manufacturer).

The manufacturer sets forth the warranty period of the fan as 60 months following the sale date via retail network subject to the customer's ensuring compliance with the rules of transportation, storage, mounting and operation.

In case of any malfunction of the fan through the manufacturer's fault within the warranty period the customer is entitled to free elimination of the defects by means of warranty repair.

The warranty repair means performing works specific to elimination of faults in the fan operation to ensure its intended use by the user within the warranty period.

The defects are eliminated by means of replacement or repair of the complete fan or the faulty part thereof.

The warranty repair does not include:

- Routine maintenance;
- Fan installation / dismantling;
- Fan setup.

To benefit from warranty repair the user must provide the fan, the user's manual with stamped sale date and the payment document to confirm the purchase.

The fan model must comply with the one stated in the user's manual.

Contact your Seller for warranty service, repair or replacement.

The manufacturer's warranty does not apply to the following cases:

user's failure to provide the fan in the entire delivery package as stated in the user's manual, including missing component parts previously dismantled by the user;

mismatch of the fan model and make with the respective details stated on the fan packing and in the user's manual;

user's failure to ensure timely technical maintenance of the fan;

external damage to the casing (excluding external modifications of the fan as required for its installation) and the internal components of the fan;

alteration of the fan design or engineering changes of the fan;

replacement and use of the assemblies, parts and components not approved by the manufacturer;

not intended use of the fan;

user's violation of the fan installation regulations;

user's violation of the fan operation regulations, warnings in the user's manual, including the warnings contained both in the text or in the graphic charts, figures, tables, such as "do not operate in this area", etc.

fan connection to power mains with a voltage higher than the one stated in the user's manual;

fan breakdown due to voltage surges in the power mains;

user's discretionary repair of the fan;

repair performed by any persons without the manufacturer's authorization;

expiry of the warranty period;

user's violation of the established regulations specific to the fan transportation;
user's violation of the fan storage regulations;
wrongful acts against the fan committed by third persons;
fan breakdown due to circumstances of insuperable force (fire, flood, earthquake, war, hostilities of any kind, blockade, etc.);
missing seals if provided by the user's manual;
failure to submit the user's manual with the sale date stamp;
failure to submit the warranty card;
failure to submit a payment document certifying the fan purchase.

FOLLOWING THE REGULATIONS STIPULATED HEREIN WILL ENSURE A LONG AND TROUBLE-FREE OPERATION OF THE FAN.

USERS' CLAIMS SHALL BE SUBJECT TO REVIEW ONLY UPON SUBMISSION OF THE FAN, THE PAYMENT DOCUMENT AND THE USER'S MANUAL WITH THE SALES DATE STAMP.

Due to constant improvements the design of some models may slightly differ from those ones described in this manual.

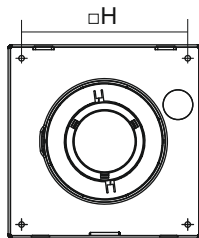
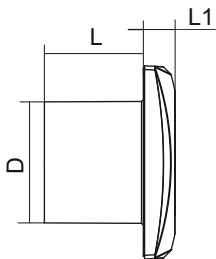
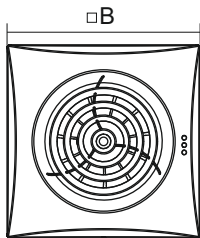

	100 Quiet	125 Quiet	150 Quiet
D, mm	99	124	148
B, mm	158	182	214
H, mm	136	158	190
L, mm	81	91	111
L1, mm	26	27	32

AIRTECHNIC
www.airtechnic.gr
 Air-Conditioning & Ventilation Components & Systems

1

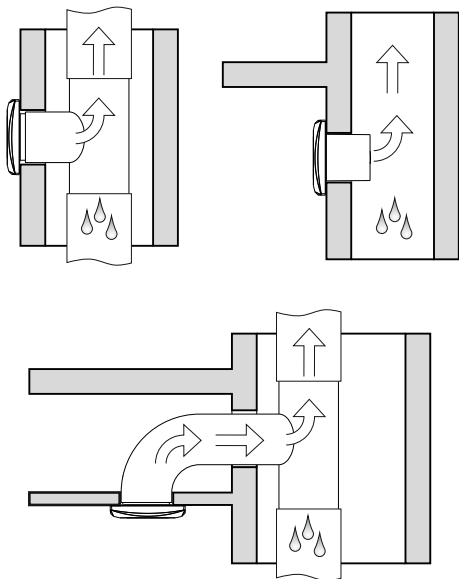

2

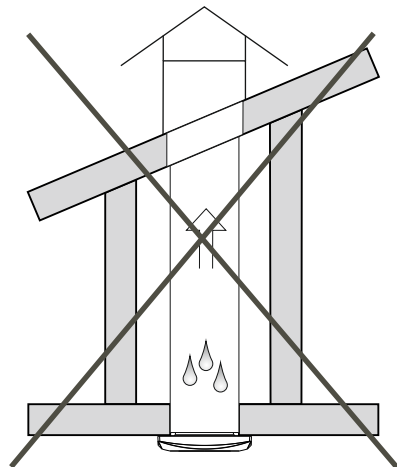

3

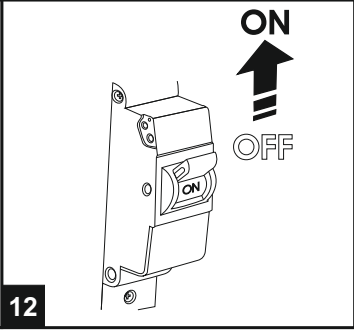
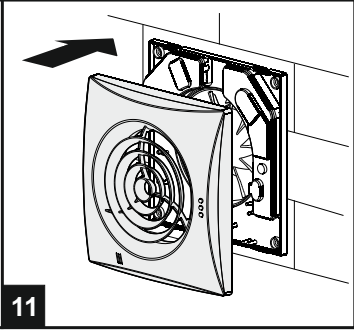
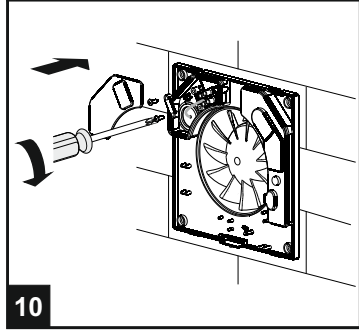
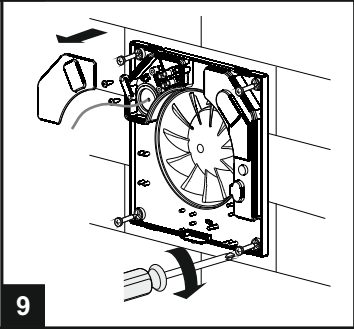
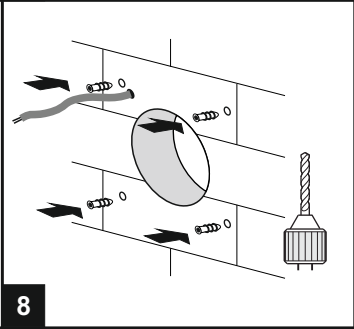
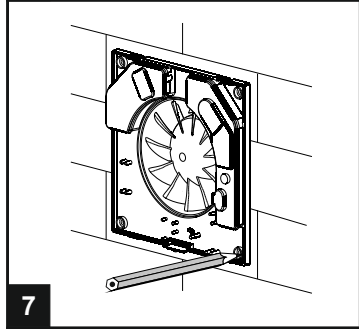
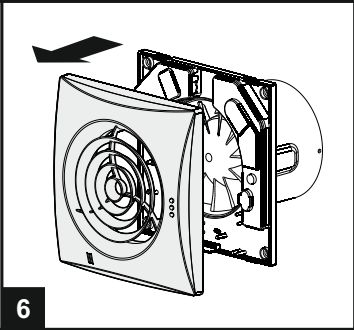
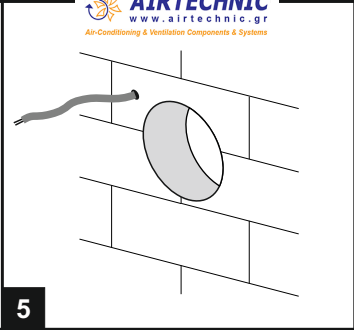
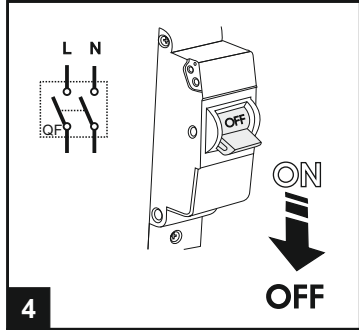

100 Quiet, 125 Quiet

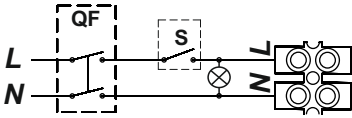
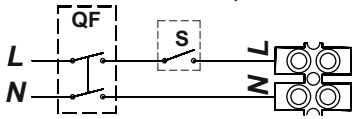

100 Quiet V, 125 Quiet V

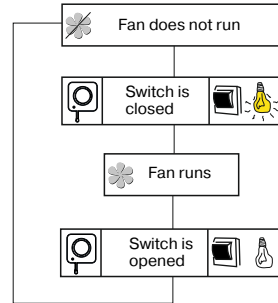
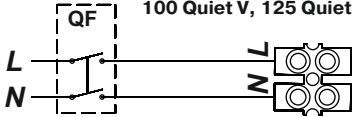

13

100 Quiet T, 125 Quiet T

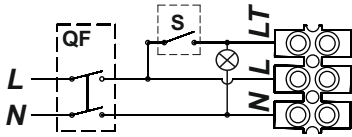
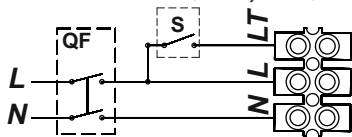

100 Quiet VT, 125 Quiet VT

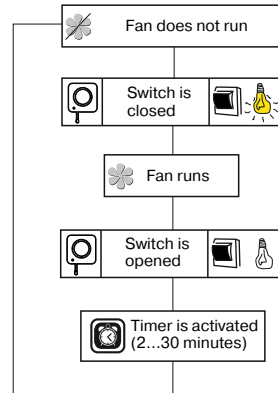
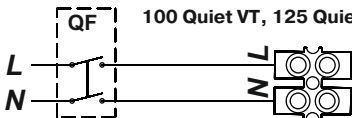

14

100 Quiet TH, 125 Quiet TH

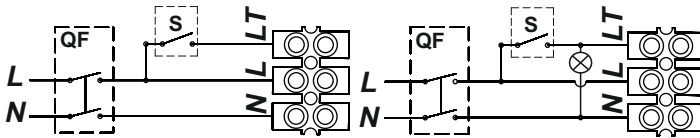

100 Quiet VTH, 125 Quiet VTH

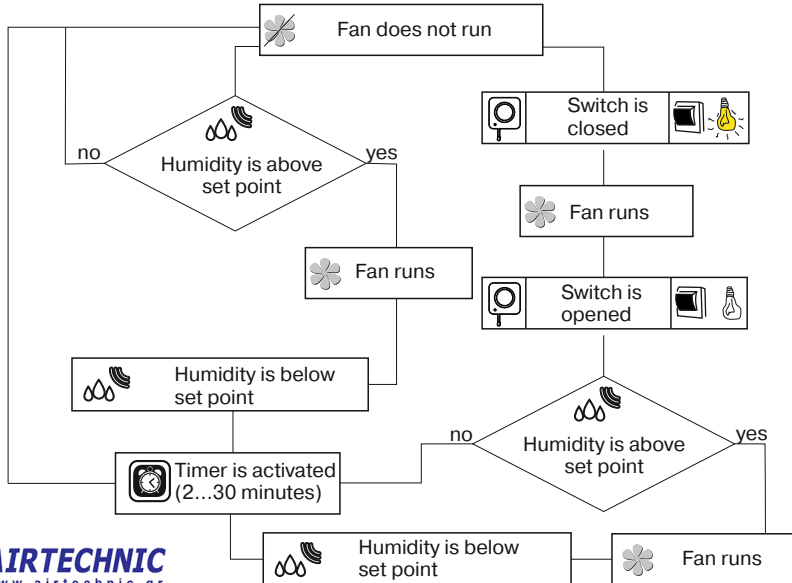
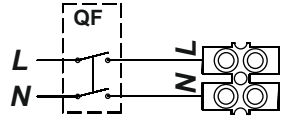

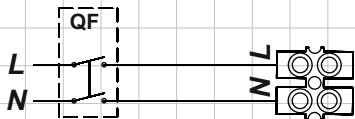

16

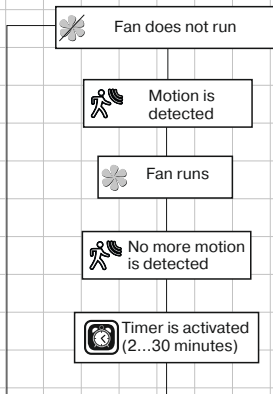

100/125 Quiet T/TH/TP/VT/VTH

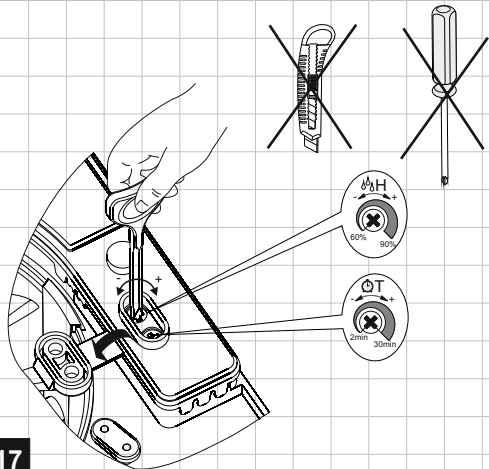

17

T To adjust the fan turn-off delay time, turn the control knob T clockwise to increase and counter-clockwise to decrease the turn-off delay time respectively, from 2 up to 30 minutes.

H To adjust the humidity set point turn the control knob H clockwise to increase and counter-clockwise to decrease the humidity sensor set point, from 60% up to 90%.

Warning! The timer circuit is under mains voltage. Disconnect the fan from power mains prior to any adjustment operations. The fan delivery set includes a specially designed plastic screwdriver for fan settings adjustments. Use it to change the turn-off delay time or the humidity set point. Do not use a metal screwdriver, knife, etc. for adjustment operations not to damage the circuit board.

150 Quiet (first speed)

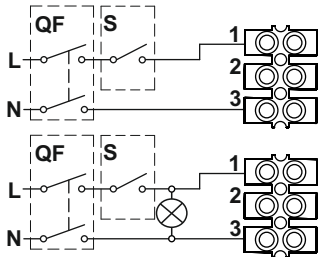

150 Quiet V (first speed)

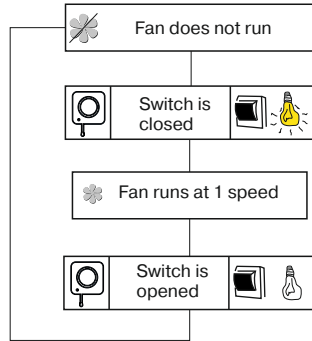
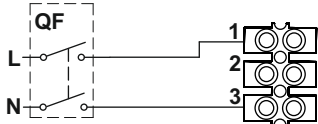

18

150 Quiet (2nd speed)

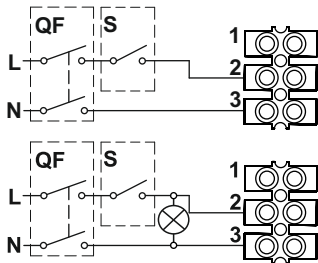

150 Quiet V (2nd speed)

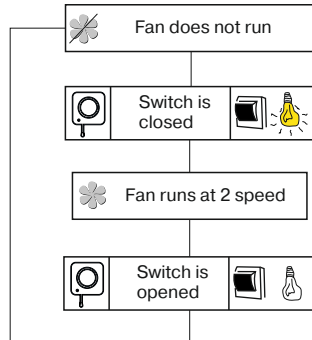
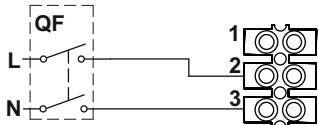





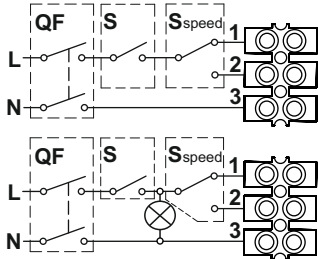

19

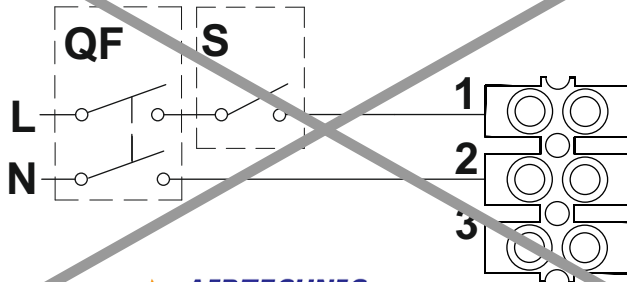
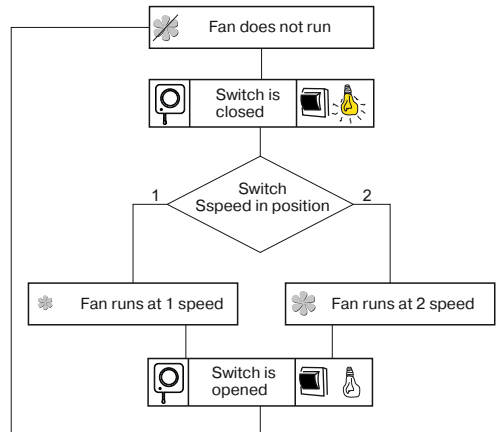
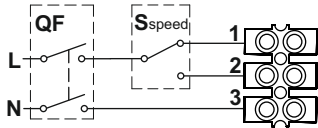
150 Quiet (1st and 2nd speed)



150 Quiet V (1st and 2nd speed)



	Mode 1	Mode 2	Mode 3	Mode 4	Mode 5
150 Quiet T					
150 Quiet VT				—	—
150 Quiet TP					
150 Quiet TH					
150 Quiet VTH					

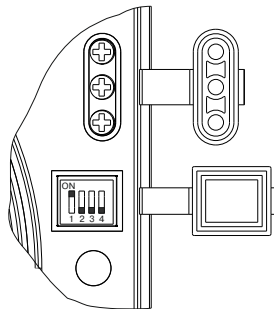

The operation mode of the fan models 150 Quiet T, TH, VT, VTH, TP is selected by setting the DIP switch into the required position. Use the plastic screwdriver from the delivery set to set the DIP-switch to required position.

Mode 1 (single-speed mode)

The fan is turned off by default. The fan starts operating at the 1st speed when the switch is closed or one of the sensors is activated.

Mode 2 (single-speed mode)

The fan is turned off by default. The fan starts operating at the 2nd speed when the switch is closed or the sensors are activated.

Mode 3 (two-speed mode)

The fan operates at the 1st speed by default. The fan switches to the 2nd speed when the switch is closed or the sensors are activated.

Mode 4 (two-speed mode)

The fan is turned off by default. The fan starts operating at the 1st speed when the switch is closed and switches to the 2nd speed when the humidity sensor is activated.

Mode 5 (two-speed mode)

The fan is turned off by default. The fan starts operating at the 1st speed when the switch is closed or when the humidity sensor is activated. If during the operation at the 1st speed the second even takes place. i.e. the switch is closed or the humidity sensor is activated, the fan switches to the 2nd speed.

ATTENTION! The operation mode 1 is set by default.

Any other operating mode may be set during the fan mounting or during its operation. Setting the DIP switch to any operating position other than stated in the table results in the emergency mode with red light indication. In such a case disconnect the fan from power supply in such a case and set the DIP switch to a correct position.

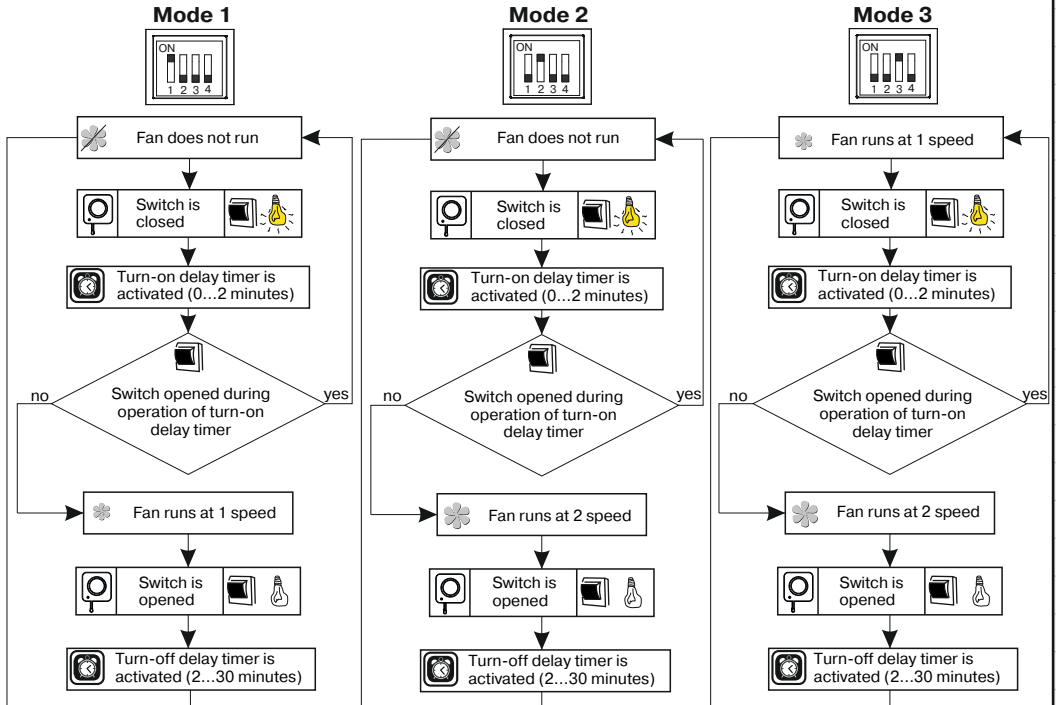
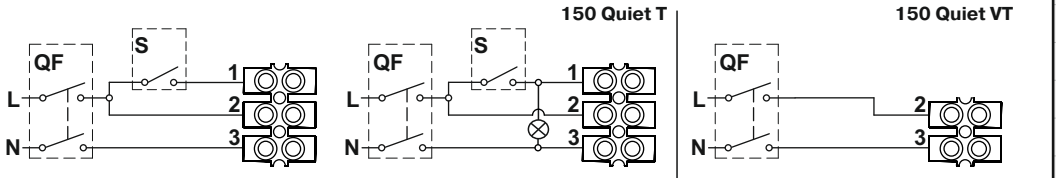

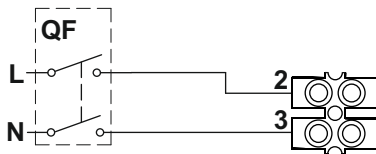

Mode 1

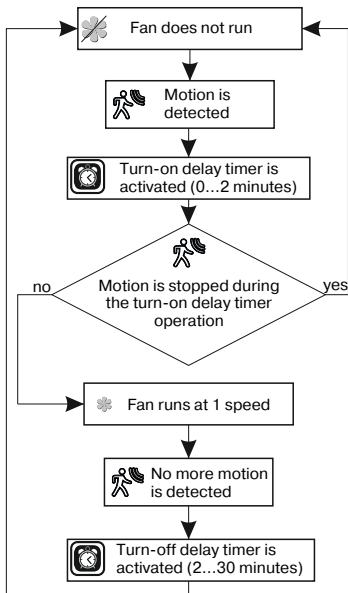

Mode 2

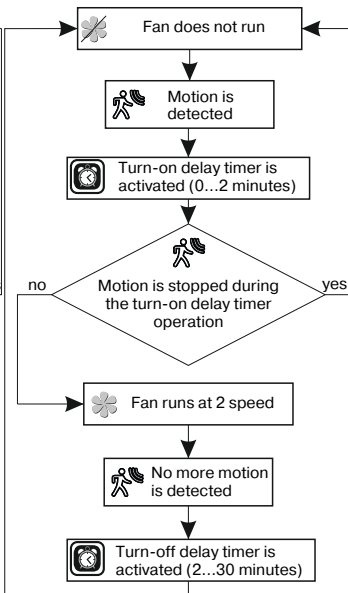

Mode 3

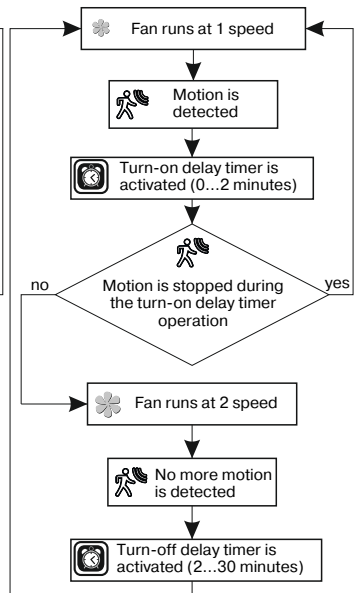

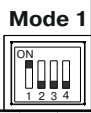
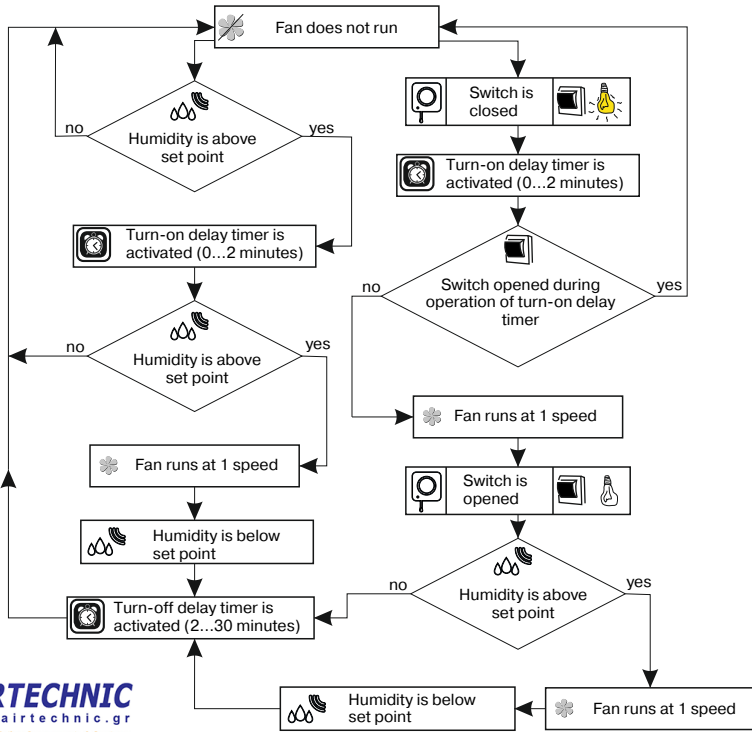
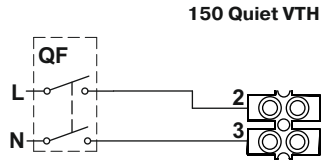
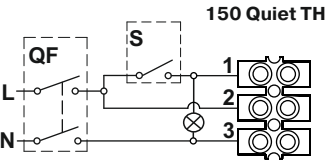
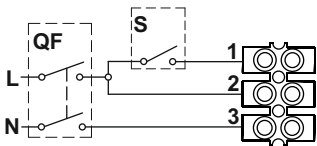

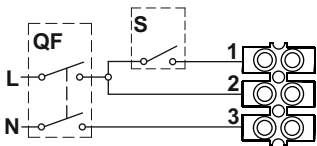

150 Quiet TH

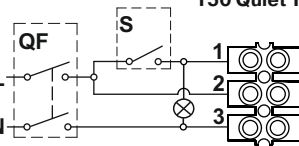

150 Quiet VTH

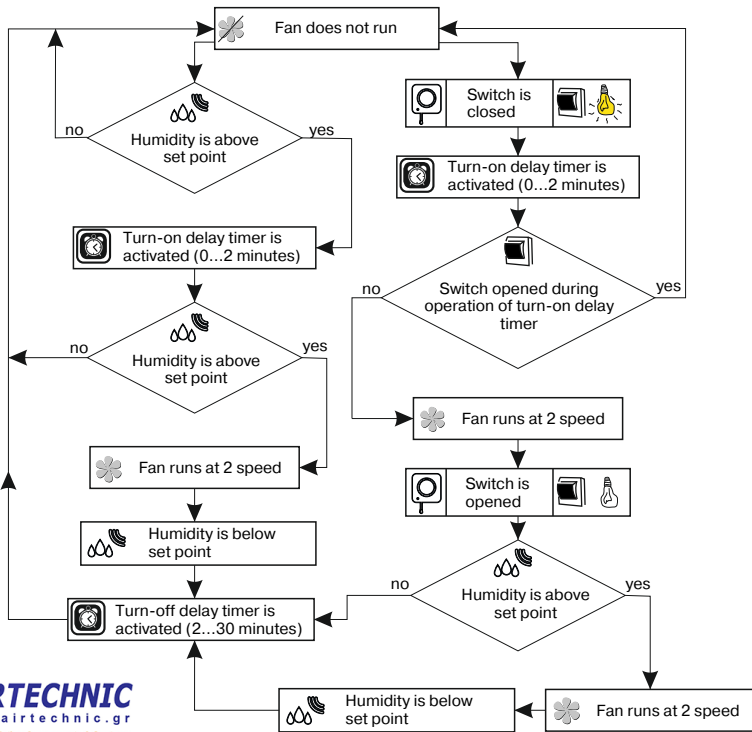
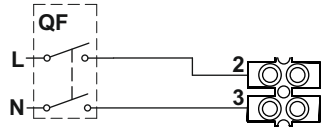

Mode 2



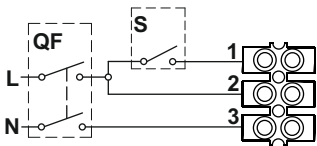

150 Quiet TH

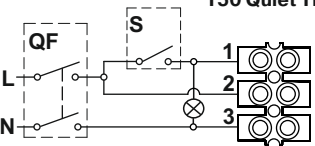

150 Quiet VTH

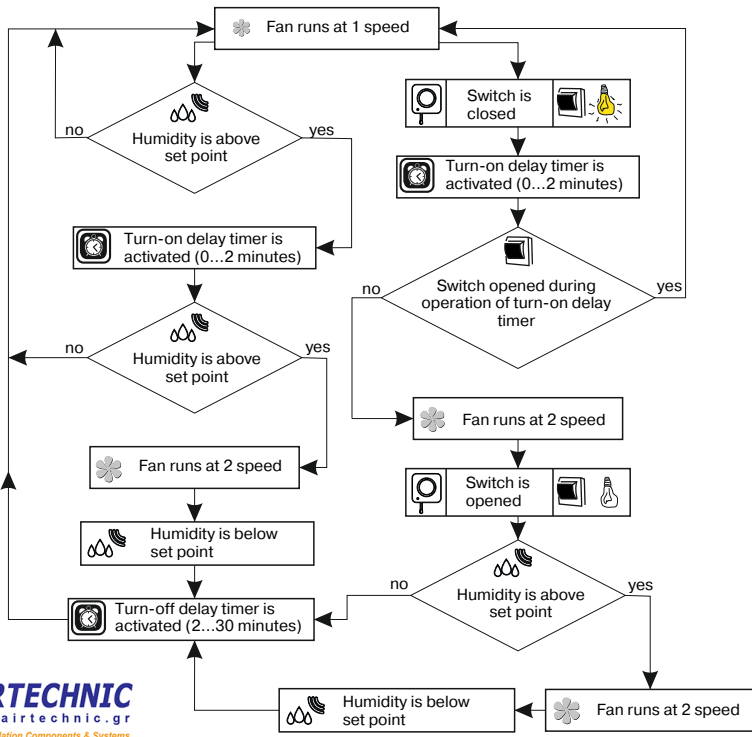
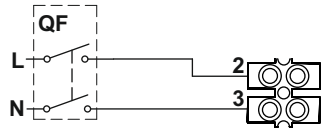

Mode 3



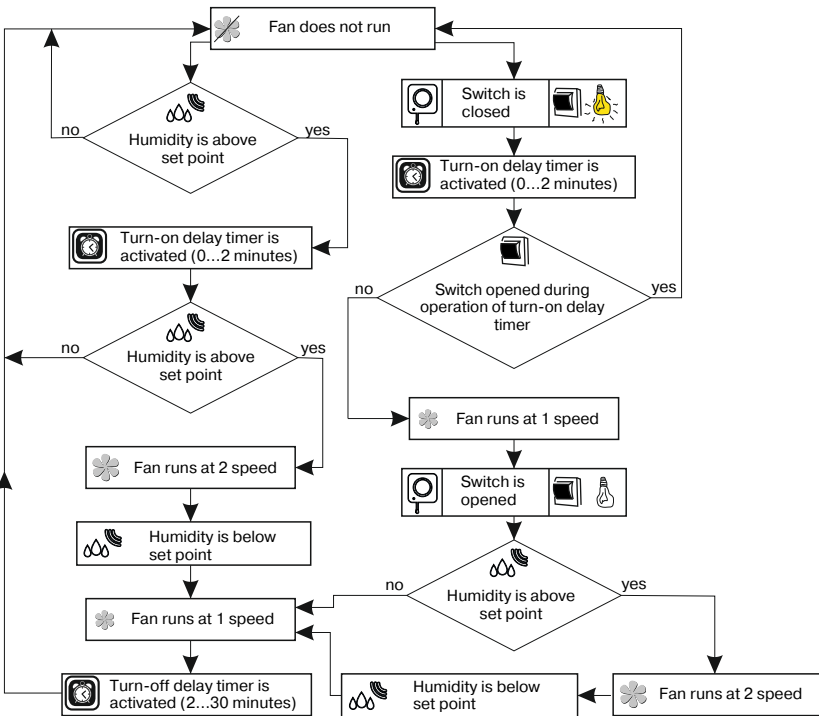
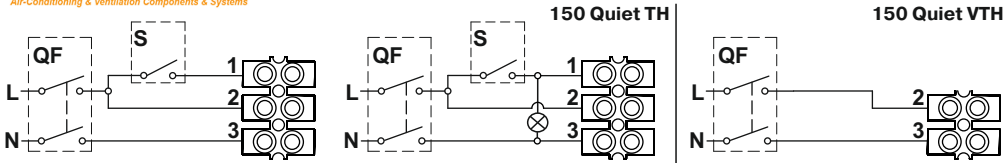

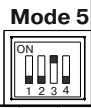
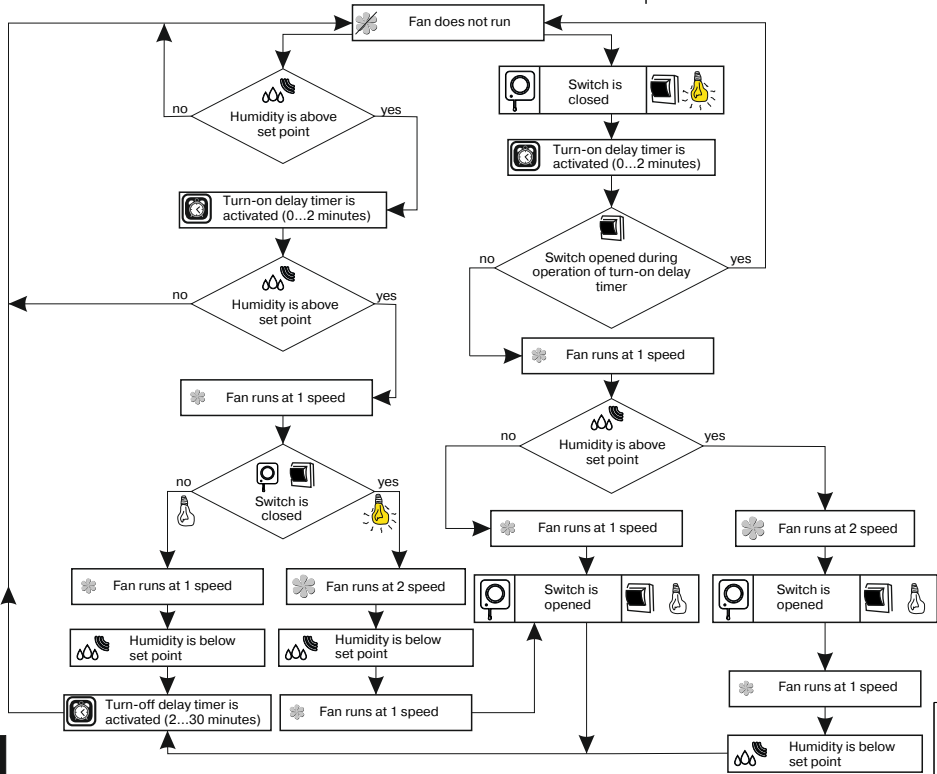
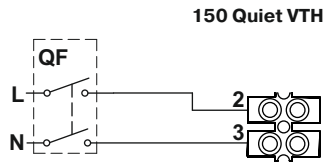
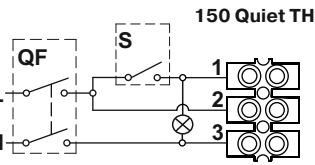
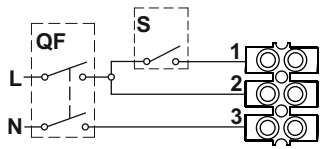

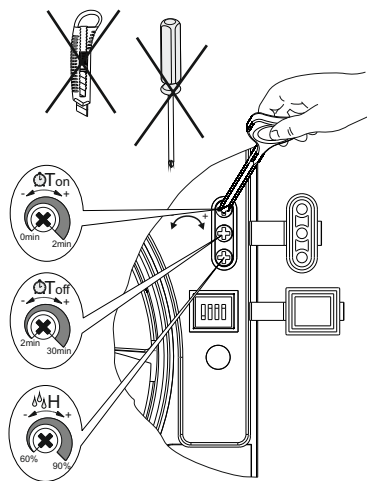

T_{on} To adjust the fan turn-on delay time, turn the control knob T_{on} clockwise to increase and counter-clockwise to decrease the turn-off delay time respectively, from 2 up to 30 minutes.

T_{off} To adjust the fan turn-off delay time, turn the control knob T_{off} clockwise to increase and counter-clockwise to decrease the turn-off delay time respectively, from 2 up to 30 minutes.

H To adjust the humidity set point turn the control knob H clockwise to increase and counter-clockwise to decrease the humidity sensor set point, from 60% up to 90%.

Warning! The timer circuit is under mains voltage. Disconnect the fan from power mains prior to any adjustment operations. The fan delivery set includes a specially designed plastic screwdriver for fan settings adjustments. Use the screwdriver to change the turn-off and turn-on delay time or the humidity set point. Do not use a metal screwdriver, knife, etc. for adjustment operations not to damage the circuit board.

Attention! The recommended turn-on delay timer setting (factory setting) for the model 150 Quiet VT, VTH is 0 minutes.

30

Operation indication

(only for the models VENTS 150 Quiet T, TH, VT, VTH, TP):

1. The indicator light blinks green once in 5 seconds - the fan is in operation mode with no signals from the sensors or the external switch.
2. The indicator light blinks green once in second - the fan operates with the activated turn-on delay timer.
3. The indicator light glows red - the fan operates with the activated humidity sensor or the motion sensor.
4. The indicator light glows green - the fan operates with the switch closed.
5. The indicator light blinks green and red once in 1 second - the fan operates with the activated turn-off delay timer.

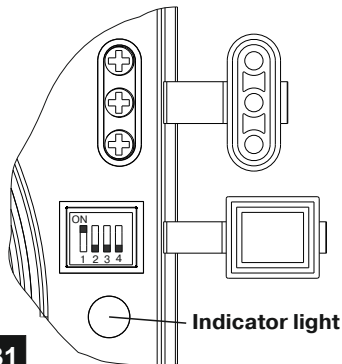

31

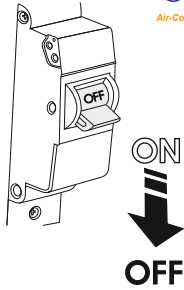

32

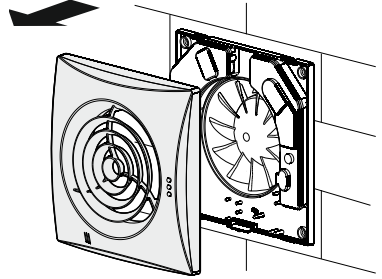

33

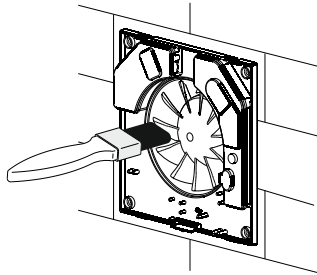

34

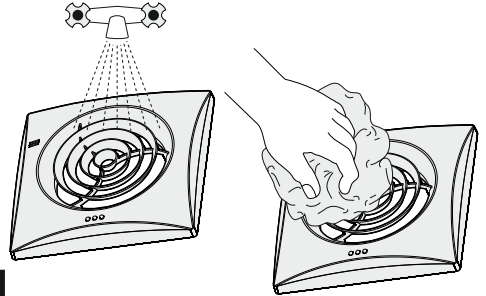

35

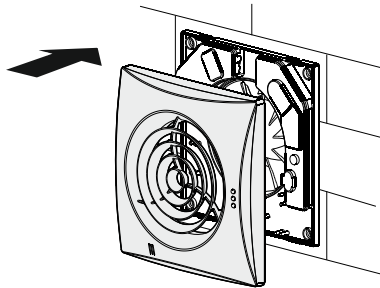

36

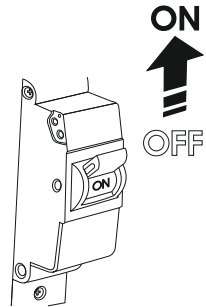

37

Acceptance certificate

The fan is recognized as serviceable.

		V	<input type="checkbox"/>
100		T	<input type="checkbox"/>
	Quiet		<input type="checkbox"/>
125		TH	<input type="checkbox"/>
	Quiet		<input type="checkbox"/>
	Extra		<input type="checkbox"/>
150		TP	<input type="checkbox"/>
			<input type="checkbox"/>
		12	<input type="checkbox"/>

Approval mark

Manufacturing date

Sold

(name and stamp of the seller)

Sales date



Μιχαήλ Καραολή 19, τκ 143 43, Ν. Χαλκηδόνα, Αθήνα
Τηλ: 211 - 70.55.500 & 210 - 21.30.051, Fax: 210 - 22.23.283