

FANS FOR ROUND DUCTS

Series
VENTS VKMz



Inline centrifugal fans in galvanized casing with the air capacity up to **1540 m³/h**

■ **Applications**

Supply and exhaust ventilation systems for various premises suitable for external surface mounting. For premises with high requirements to noise level we offer units in low-noise modification (VKMz...Q).

■ **Design**

The fan casing is made of galvanized steel. For easy connection and operation the fan can be equipped with the power cord with a plug (VKMz...R).

■ **Motor**

The impeller with backward curved blades is powered by the single phase motor with external rotor and overheating protection with automatic restart. The motor is equipped with ball bearings for long service life designed for at least 40 000 hours. For precise features, safe operation and low noise, each impeller is dynamically balanced while assembly. Motor protection rating IP 44.

■ **Speed control**

Smooth or step speed control with a thyristor or autotransformer speed controller. Several fans may be connected to one speed controller provided that the total power and operating current do not exceed the rated speed controller parameters.

■ **Mounting**

Mounting at any angle to wall or ceiling is performed with fastening brackets supplied with the unit. The fan is powered by means of the external terminal box. Electric connection and mounting shall be performed in compliance with the manual and wiring diagram on the terminal box.

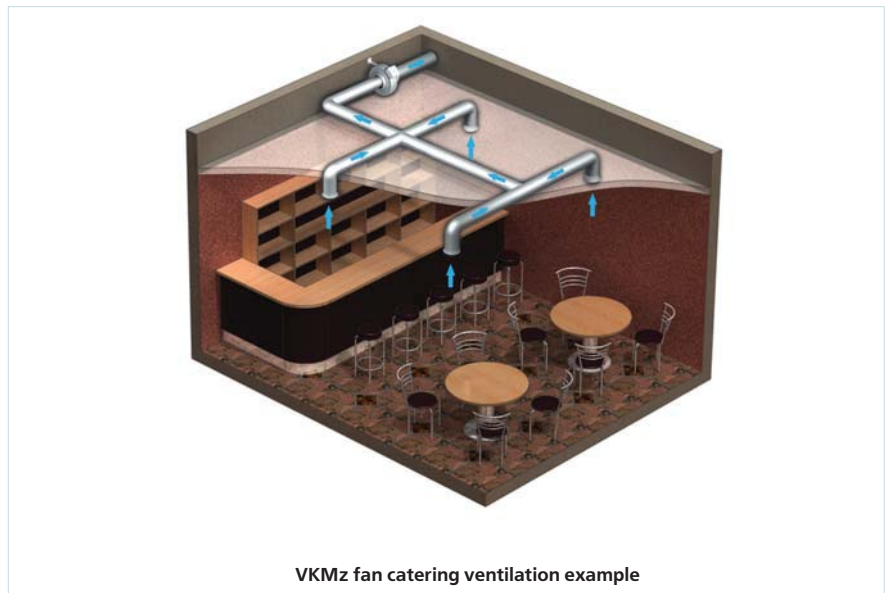

Designation key: _____

Series	Air duct diameter	Options
VENTS VKMz	100; 125; 150; 160; 200; 250; 315	Q – low-powered motor. R – power cord with IEC C14 electric plug.

Accessories



page 378 page 386 page 388 page 392 page 406 page 442 page 446 page 454 page 461 page 462 page 466 page 467

Technical data:

	VKMz 100 Q	VKMz 100	VKMz 125 Q	VKMz 125	VKMz 150	VKMz 160
Voltage [V / 50 Hz]	230	230	230	230	230	230
Power [W]	60	72	60	78	75	78
Current [A]	0.37	0.32	0.37	0.34	0.33	0.34
Max. air capacity [m ³ /h]	195	250	230	330	455	455
RPM [min ⁻¹]	2670	2820	2605	2820	2770	2760
Noise level at 3 m [dBA]	35	46	35	46	46	46
Transported air temperature [°C]	-25 +55	-25 +55	-25 +55	-25 +55	-25 +55	-25 +55
SEC class	C	C	C	C	B	B
Protection rating	IP X4	IP X4	IP X4	IP X4	IP X4	IP X4

Technical data:

	VKMz 200 Q	VKMz 200	VKMz 250 Q	VKMz 250	VKMz 315 Q	VKMz 315
Voltage [V / 50 Hz]	230	230	230	230	230	230
Power [W]	139	157	134	152	151	185
Current [A]	0.61	0.69	0.59	0.66	0.66	0.81
Max. air capacity [m ³ /h]	840	1000	980	1070	1330	1540
RPM [min ⁻¹]	2790	2740	2785	2765	2680	2730
Noise level at 3 m [dBA]	48	50	51	52	52	53
Transported air temperature [°C]	-25 +50	-25 +45	-25 +50	-25 +50	-25 +50	-25 +45
SEC class*	B	B	B	B	-	-
Protection rating	IP X4	IP X4	IP X4	IP X4	IP X4	IP X4

* The EC norm 1254/2014 does not apply if maximum air capacity is >1000 m³/h

Fan overall dimensions:

Type	Dimensions [mm]								Weight [kg]
	∅D	∅D1	B	B1	L	L1	L2	L3	
VKMz 100 Q	98	237	253	293	202	23	22	30	3.16
VKMz 100	98	237	253	293	202	23	22	30	3.16
VKMz 125 Q	123	237	253	293	202	23	22	30	3.16
VKMz 125	123	237	253	293	202	23	22	30	3.16
VKMz 150	148	278	294	334	200	25	23	30	3.42
VKMz 160	158	278	294	334	200	25	23	30	3.44
VKMz 200 Q	198	332	340	380	245	25	29	40	5.43
VKMz 200	198	332	340	380	245	25	29	40	5.43
VKMz 250 Q	249	332	340	380	213	25	29	40	5.25
VKMz 250	249	332	340	380	213	25	29	40	5.25
VKMz 315 Q	313	402	410	450	308	33	55	40	6.57
VKMz 315	313	402	410	450	308	33	55	40	6.57

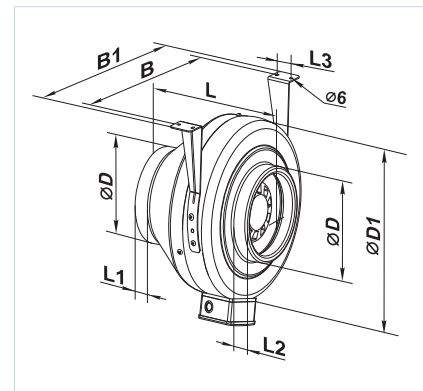

External terminal box for power supply



Fastening bracket for easy mounting supplied with the fan



VENTS VKMz...R is equipped with a power cord

FANS FOR ROUND DUCTS

VENTS VKMz

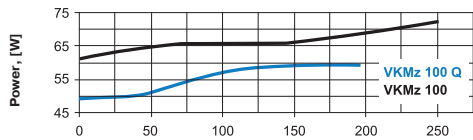
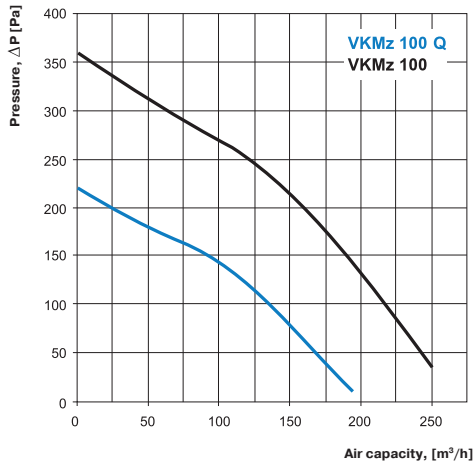

VKMz 100 Q

Sound-power level		Octave-frequency band [Hz]									
		Hz	Gen	63	125	250	500	1000	2000	4000	8000
L _{WA} to inlet	dBA	63	51	57	56	57	51	46	40	29	
L _{WA} to outlet	dBA	65	54	62	58	61	57	50	45	33	
L _{WA} to environment	dBA	55	19	14	21	34	42	41	29	17	

VKMz 100

Sound-power level		Octave-frequency band [Hz]									
		Hz	Gen	63	125	250	500	1000	2000	4000	8000
L _{WA} to inlet	dBA	72	47	67	68	67	60	54	53	42	
L _{WA} to outlet	dBA	73	56	67	72	66	63	58	57	42	
L _{WA} to environment	dBA	64	43	60	57	41	24	6	17	24	

VENTS VKMz

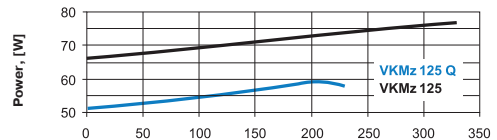
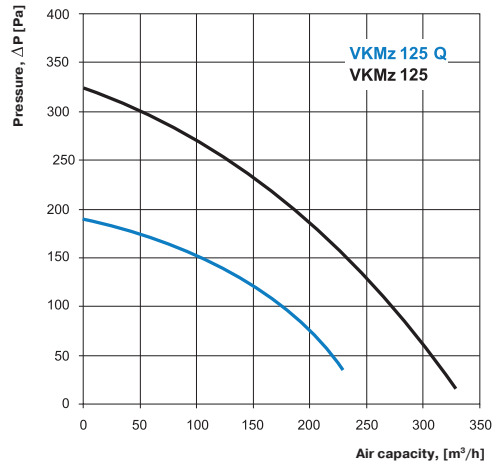

VKMz 125 Q

Sound-power level		Octave-frequency band [Hz]									
		Hz	Gen	63	125	250	500	1000	2000	4000	8000
L _{WA} to inlet	dBA	59	31	52	54	53	49	46	35	30	
L _{WA} to outlet	dBA	61	35	53	56	60	51	49	35	34	
L _{WA} to environment	dBA	64	46	60	59	43	33	15	30	28	

VKMz 125

Sound-power level		Octave-frequency band [Hz]									
		Hz	Gen	63	125	250	500	1000	2000	4000	8000
L _{WA} to inlet	dBA	75	56	63	68	69	64	61	52	41	
L _{WA} to outlet	dBA	75	58	71	74	72	65	65	56	47	
L _{WA} to environment	dBA	64	52	64	59	48	36	23	30	27	

VENTS VKMz

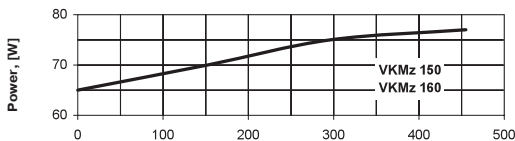
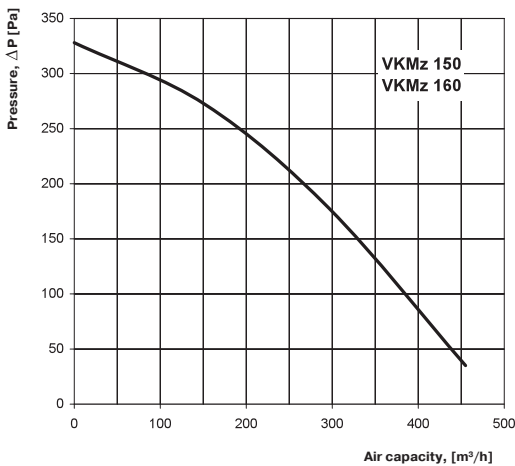

VKMz 150

Sound-power level		Octave-frequency band [Hz]									
		Hz	Gen	63	125	250	500	1000	2000	4000	8000
L _{WA} to inlet	dBA	72	42	65	64	64	61	60	48	38	
L _{WA} to outlet	dBA	73	47	68	66	69	64	59	47	41	
L _{WA} to environment	dBA	63	41	59	54	37	18	17	29	22	

VKMz 160

Sound-power level		Octave-frequency band [Hz]									
		Hz	Gen	63	125	250	500	1000	2000	4000	8000
L _{WA} to inlet	dBA	69	42	67	66	63	61	58	48	35	
L _{WA} to outlet	dBA	72	46	69	65	68	64	63	50	40	
L _{WA} to environment	dBA	60	41	60	53	36	20	18	30	24	

VENTS VKMz

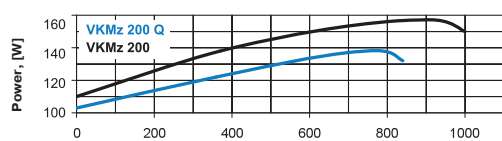
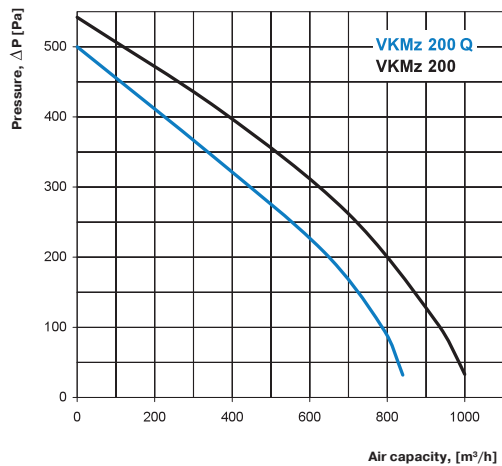

VKMz 200 Q

Sound-power level		Octave-frequency band [Hz]									
		Hz	Gen	63	125	250	500	1000	2000	4000	8000
L _{WA} to inlet	dBA	76	47	68	65	70	67	59	58	50	
L _{WA} to outlet	dBA	76	49	71	69	72	63	63	60	53	
L _{WA} to environment	dBA	64	46	61	57	48	32	27	48	42	

VKMz 200

Sound-power level		Octave-frequency band [Hz]									
		Hz	Gen	63	125	250	500	1000	2000	4000	8000
L _{WA} to inlet	dBA	73	51	66	68	71	67	64	58	52	
L _{WA} to outlet	dBA	79	51	73	69	74	67	65	60	50	
L _{WA} to environment	dBA	68	47	64	64	46	32	30	44	42	

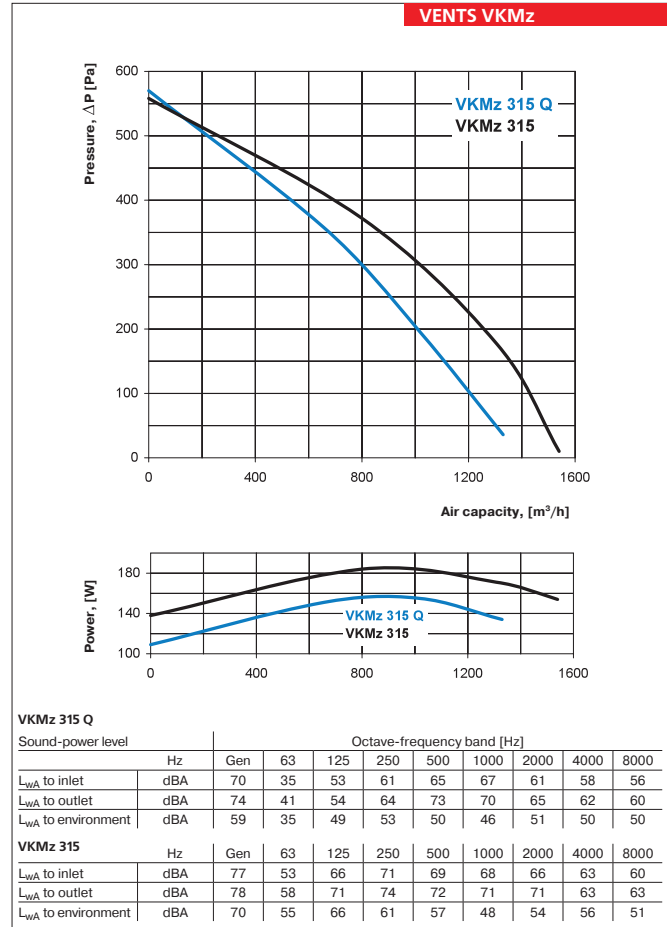
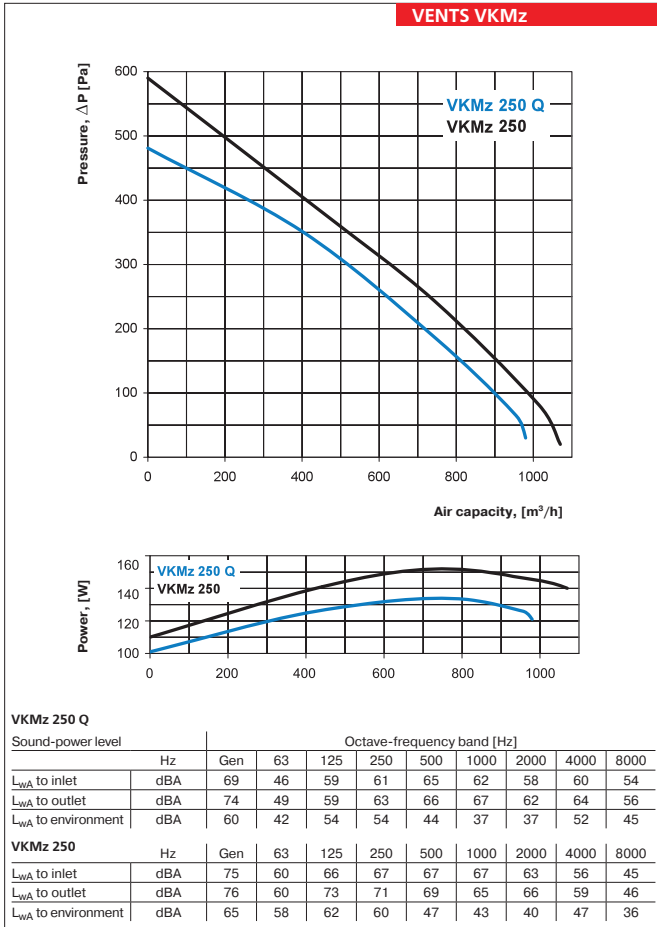

VENTS VKMz
FAN SERIES