



## BDTX

### ROUND DUCT TYPE FANS / Backward Curved

#### Device Components and Material Properties

The case and fan are made of high quality galvanized sheet metal which is pressed against corrosion. All models have an external rotor motor with a closed structure and have air transport at max.40°C. On request, the motor can be produced as thermally protected against high temperature. The terminal box and mounting legs are supplied with the product as standard. Suction and discharge nozzles are compatible with duct diameters and can be connected by clamp.

#### Fan Structure

Designed to work between round ducts. The fan blades are aerodynamically curved and provide regular flow. The fans are composed of backward sloping and infrequently arranged fins.

#### Benefits

The rotation of the fan on the motor housing saves efficiency and space. It works at optimum sound levels while providing strong air suction. It can be operated in any position. If necessary, it can be mounted on the wall thanks to the mounting legs. Speed can be adjusted with speed control devices.

#### Speed Control

Optional control devices can be provided.

\* Linear voltage regulator speed control can be done. (see BSC accessory)

#### Usage Areas

Round duct fans are used in low and medium volume ventilation requirements in duct systems where the application area is limited. It should be used with oil holding filter in oily environments.

### Technical Drawing and Tables

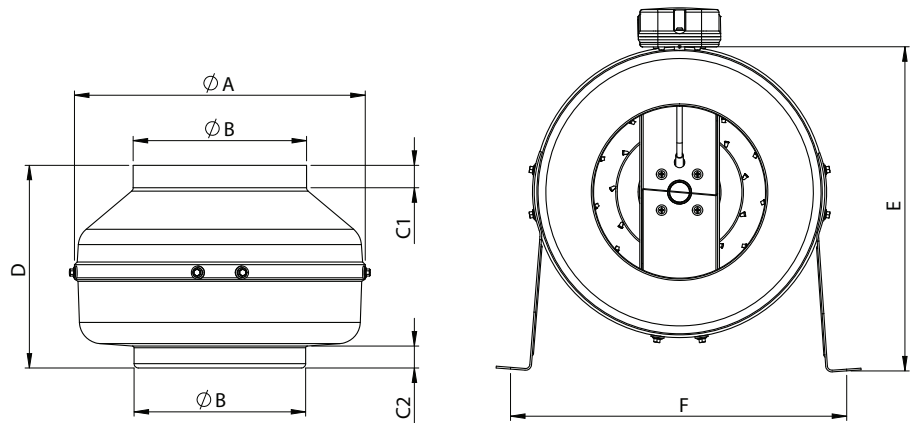

#### Accessories



TYPE	A	B	C1	C2	D	E	F
BDTX 100	245	97	20	20	197	273	268
BDTX 125	245	122	20	20	188	273	268
BDTX 150	272	147	23	25	192	286	295
BDTX 160	272	157	23	25	192	286	295
BDTX 200	330	196	30	28	230	380	352
BDTX 250	330	247	30	28	227	380	352
BDTX 315	400	313	30	30	285	415	422
BDTX 355	400	352	30	30	378	415	422

Dimensions are in (mm)

TYPE	VOLTAGE	FREQUENCY	POWER	CURRENT	CAPACITOR	SPEED	AIR FLOW	SOUND PRESSURE	INSULATION CLASS	PROTECTION CLASS	WEIGHT
	V	Hz	W	(A)	(µF)	r.p.m	m³/h	dB(A)	Ins.cl.	IP	kg
BDTX 100	230	50/60	60	0,3	2	2610/2960	240/275	44	B	44	2,6
BDTX 125	230	50/60	80	0,4	2,5	2325	315	43	B	44	2,7
BDTX 150	230	50/60	78	0,4	2,5	2450	420	46	B	44	3
BDTX 160	230	50/60	85	0,4	2,5	2550	440	45	B	44	3,2
BDTX 200-A	230	50/60	90	0,43	2,5	2300	735	46	B	44	4,4
BDTX 200-B	230	50/60	100/130	0,51/0,68	4	2530/2720	870/935	48	B	44	4,8
BDTX 250-A	230	50/60	140	0,69	4	2400	1010	45	B	44	4,9
BDTX 250-B	230	50/60	145/200	0,74/1,04	6	2650	1150	47	B	44	5,3
BDTX 315-A	230	50/60	160/210	0,8/1,1	6	2400	1450	48	B	44	6,8
BDTX 315-B	230	50/60	180/245	0,87/1,23	7	2500/2700	1750/1890	49	B	44	6,9
BDTX 355-A	230	50/60	160/175	1/0,85	4	1450/1700	1300/1525	45	F	44	9
BDTX 355-B	230	50	445	1,94	8	2450	2620	54	F	44	10

Sound Level Measured from 3m distance in room condition.

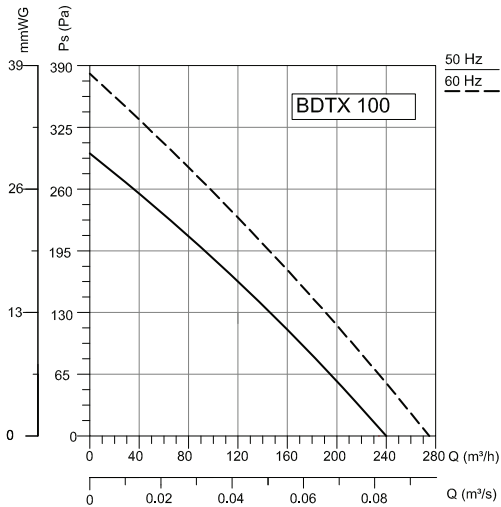

Frequency	Tot	63	125	250	500	1000	2000	4000	8000	Hz
L <sub>WA</sub> Inlet	71	53	65	62	65	64	60	52	42	dB(A)
L <sub>WA</sub> Outlet	68	54	64	58	62	61	58	50	40	dB(A)
L <sub>WA</sub> Surrounding	51	29	17	30	47	46	45	39	27	dB(A)

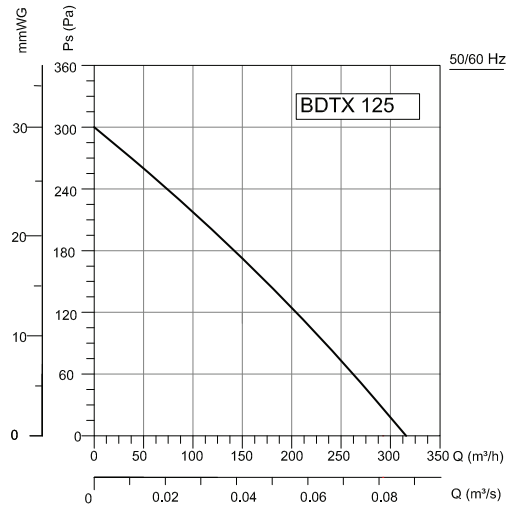

Frequency	Tot	63	125	250	500	1000	2000	4000	8000	Hz
L <sub>WA</sub> Inlet	70	47	63	64	65	63	60	55	45	dB(A)
L <sub>WA</sub> Outlet	68	49	62	59	62	61	58	52	43	dB(A)
L <sub>WA</sub> Surrounding	50	20	20	39	45	44	43	36	30	dB(A)

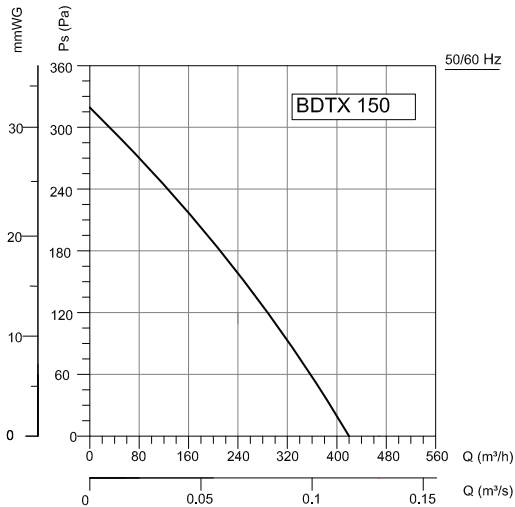

Frequency	Tot	63	125	250	500	1000	2000	4000	8000	Hz
L <sub>WA</sub> Inlet	76	52	73	65	69	67	62	60	50	dB(A)
L <sub>WA</sub> Outlet	74	55	71	62	68	64	62	55	50	dB(A)
L <sub>WA</sub> Surrounding	53	20	35	37	50	45	46	44	32	dB(A)

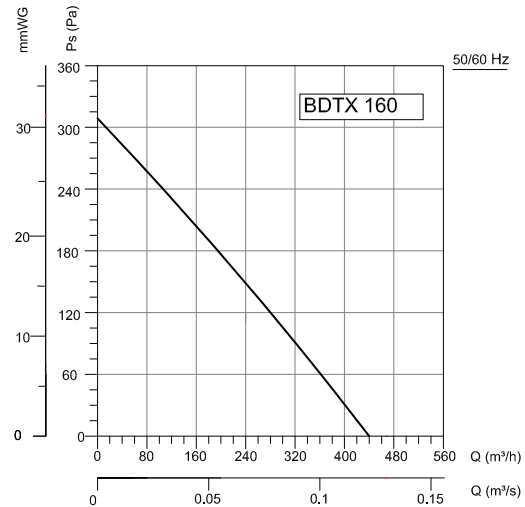

Frequency	Tot	63	125	250	500	1000	2000	4000	8000	Hz
L <sub>WA</sub> Inlet	75	50	70	66	71	68	45	58	48	dB(A)
L <sub>WA</sub> Outlet	76	56	74	61	69	66	62	56	48	dB(A)
L <sub>WA</sub> Surrounding	52	10	32	36	48	46	45	42	28	dB(A)

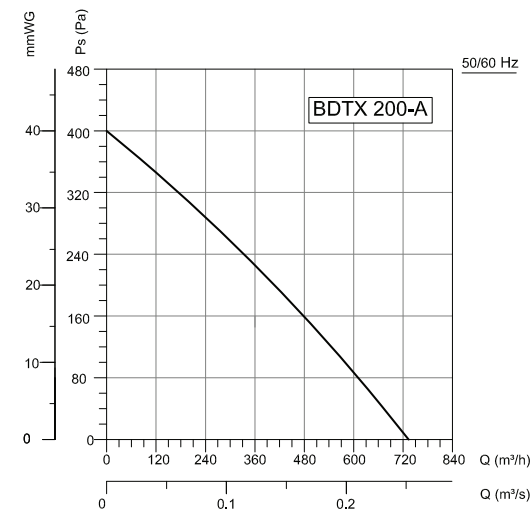

Frequency	Tot	63	125	250	500	1000	2000	4000	8000	Hz
L <sub>WA</sub> Inlet	70	42	61	64	63	64	63	56	54	dB(A)
L <sub>WA</sub> Outlet	71	49	59	62	65	64	64	58	53	dB(A)
L <sub>WA</sub> Surrounding	53	8	25	32	45	49	47	42	38	dB(A)

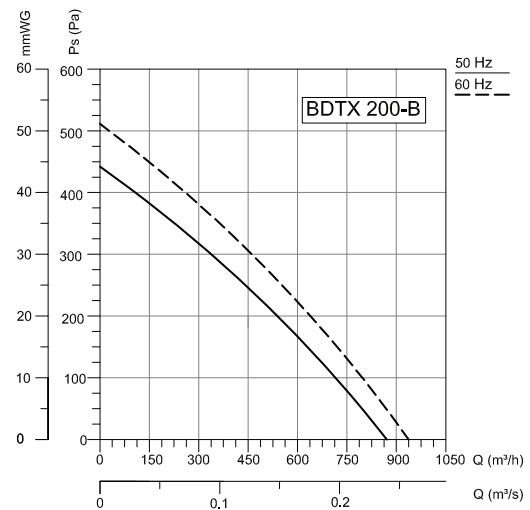

Frequency	Tot	63	125	250	500	1000	2000	4000	8000	Hz
L <sub>WA</sub> Inlet	71	42	61	64	64	64	63	56	54	dB(A)
L <sub>WA</sub> Outlet	72	49	60	63	66	64	66	58	53	dB(A)
L <sub>WA</sub> Surrounding	54	8	35	40	47	50	47	45	40	dB(A)

DUCT FANS / CIRCULAR DUCT FANS

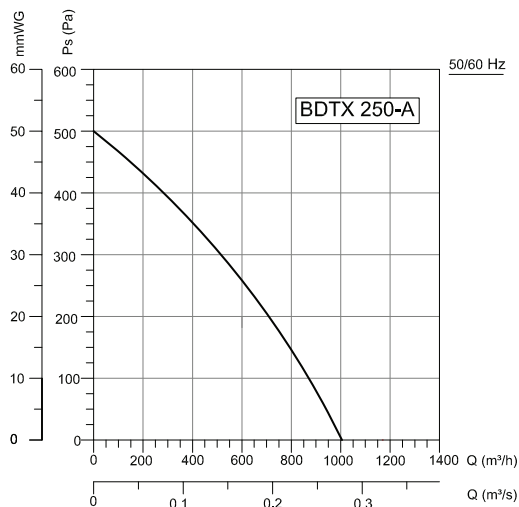

Frequency	Tot	63	125	250	500	1000	2000	4000	8000	Hz
L <sub>WA</sub> Inlet	70	49	59	65	61	64	61	60	50	dB(A)
L <sub>WA</sub> Outlet	71	48	60	65	61	65	63	61	51	dB(A)
L <sub>WA</sub> Surrounding	52	27	28	46	45	47	45	42	30	dB(A)

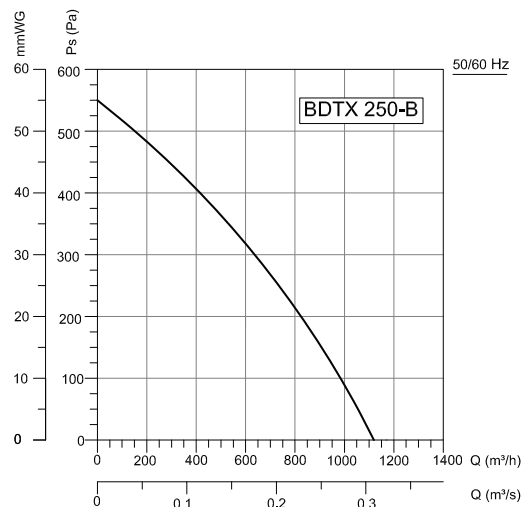

Frequency	Tot	63	125	250	500	1000	2000	4000	8000	Hz
L <sub>WA</sub> Inlet	70	49	59	65	62	65	61	60	50	dB(A)
L <sub>WA</sub> Outlet	71	48	60	65	61	65	63	61	51	dB(A)
L <sub>WA</sub> Surrounding	54	28	29	47	47	49	45	43	30	dB(A)

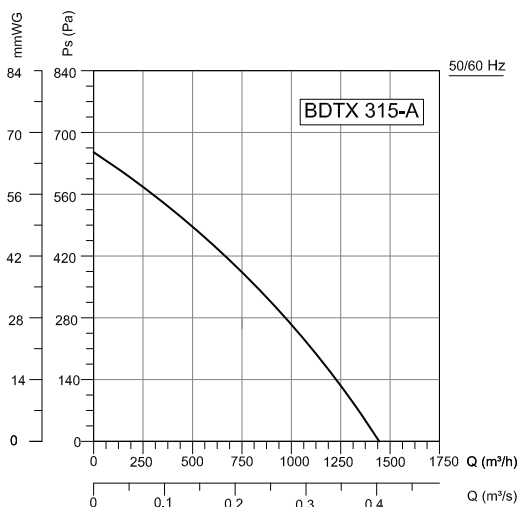

Frequency	Tot	63	125	250	500	1000	2000	4000	8000	Hz
L <sub>WA</sub> Inlet	72	46	60	65	64	66	63	64	53	dB(A)
L <sub>WA</sub> Outlet	73	52	60	64	63	66	67	65	55	dB(A)
L <sub>WA</sub> Surrounding	54	18	25	43	47	47	50	46	34	dB(A)

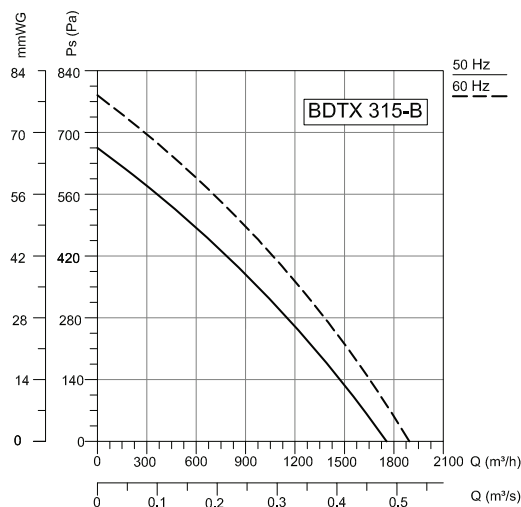

Frequency	Tot	63	125	250	500	1000	2000	4000	8000	Hz
L <sub>WA</sub> Inlet	75	55	66	68	70	68	66	63	58	dB(A)
L <sub>WA</sub> Outlet	76	62	67	71	69	68	69	63	57	dB(A)
L <sub>WA</sub> Surrounding	56	22	35	45	51	47	50	46	45	dB(A)

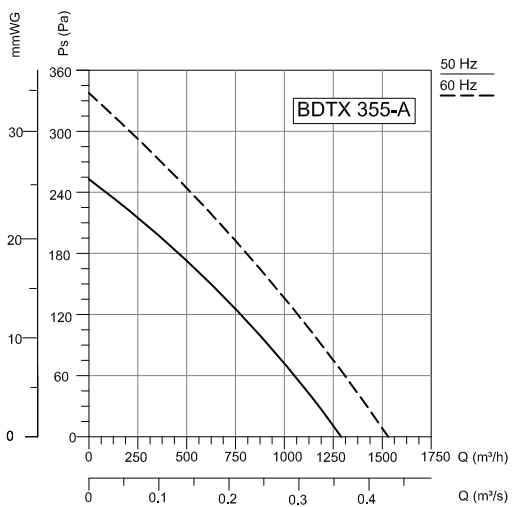

Frequency	Tot	63	125	250	500	1000	2000	4000	8000	Hz
L <sub>WA</sub> Inlet	70	49	59	65	61	64	61	60	50	dB(A)
L <sub>WA</sub> Outlet	71	48	60	65	61	65	63	61	51	dB(A)
L <sub>WA</sub> Surrounding	52	27	28	46	45	47	45	42	30	dB(A)

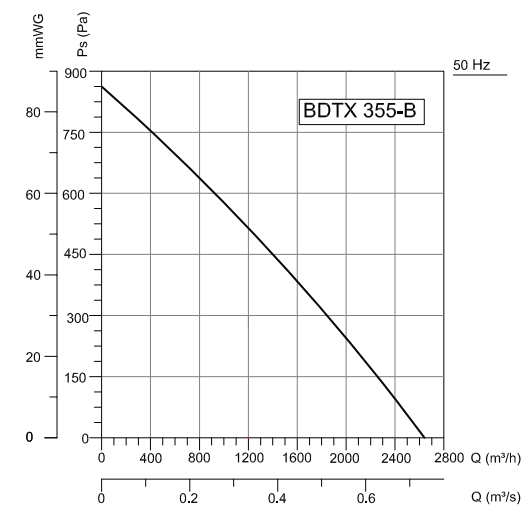

Frequency	Tot	63	125	250	500	1000	2000	4000	8000	Hz
L <sub>WA</sub> Inlet	75	55	66	68	70	68	66	63	58	dB(A)
L <sub>WA</sub> Outlet	76	62	67	71	69	68	69	63	57	dB(A)
L <sub>WA</sub> Surrounding	60	25	35	51	56	54	50	46	45	dB(A)