



AIRTECHNIC

www.airtechnic.gr

Air-Conditioning & Ventilation Components & Systems

● Energy Box TC

CEILING TYPE ENERGY RECOVERY UNIT



100 ÷ 5.000
m³/h



www.airtechnic.gr



www.facebook.com/Airtechnic.gr



ENERGY BOX TC Ceiling Type Energy Recovery Unit



ENERGY BOX TC

Index

| | | | |
|--|---|--|----|
| Unit components..... | 2 | Accessories | |
| Performance data..... | 3 | Duct type electric heaters..... | 11 |
| Technical specifications & installation..... | 7 | Duct type coils..... | 11 |
| Working principles..... | 8 | Ventilation on demand..... | 11 |
| Control system..... | 9 | Sound attenuator for circular ducts..... | 11 |

Casing & insulation

High corrosion resistive 200 gr/m² galvanize coated steel is used for the casing. Inside of outdoor air is 10 mm, outside of outdoor air is 5 mm; inside of indoor air is 10 mm insulated with non - flammable acoustics insulation material against sound and thermal conduction.

By - Pass system

ENERGY BOX - TC units have by - pass ventilation system. In transition seasons like spring, autumn and also at nights in summer or at same outdoor air conditions, by - pass damper opens, deactivate the heat exchanger and provides free - cooling. Control of by-pass damper with ENERGY BOX - TC control, is done depending on outdoor air temperature, indoor air temperature and set temperature. ENERGY BOX - TC 4.000 and ENERGY BOX - TC 5.000 units haven't by - pass system.

Cellulosic paper type Heat Exchanger

ENERGY BOX - TC energy recovery ventilation units have **cellulosic crossflow**, high efficient plate heat recovery exchangers. The exchanger transfers sensible heat and moisture between supply and exhaust air. Thus, it is also possible to transfer latent heat. With the optimization of heat exchanger, temperature and humidity efficiency is increased, pressure drop is decreased. Cellulosic paper type crossflow heat exchanger prevents decreasing moisture in winter time and increasing moisture in summer time. It helps indoor air quality to be increased.

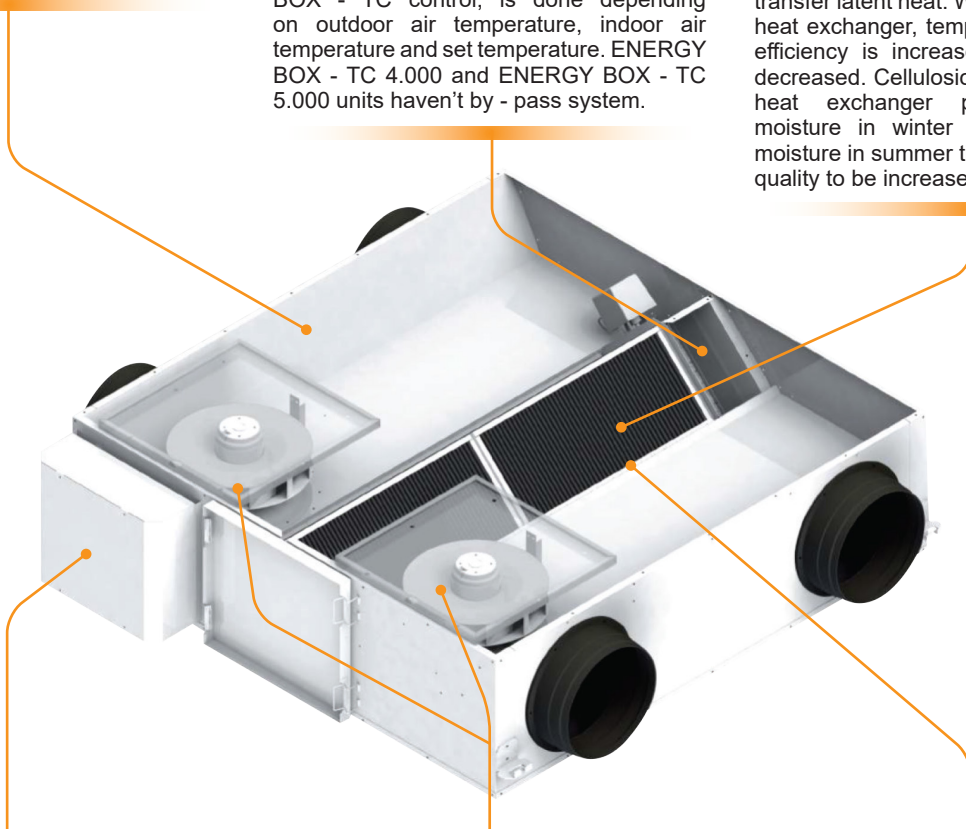

Control system

Plug&Play

ENERGY BOX - TC control unit is developed for controlling of heat recovery units' equipments, meeting the demands coming from the customers and is user friendly designed. ENERGY BOX - TC is capable of controlling the standard equipments and optional accessories. ENERGY BOX - TC Control unit can perform the basic functions without any control panel; it is more functional used with Basic and Pro - Panel. Besides, the control unit can switch on / off via **BMS**, gets fault signal and controls all the functions via **ModBus**. Alternatives different from ENERGY BOX - TC controller are listed in "Control System" part.

Supply and exhaust air fans

Backward curved plug fans are used in ENERGY BOX - TC units. Fan blades have high aerodynamic efficient backward curved design. Plug fans are used for high efficiency and low sound levels. With AC fans it is also possible to reduce maintenance costs as the fans are direct drive; free of belt and pulley.

filters

To increase indoor air quality and to protect the equipments used in unit, G class filters (according to EN 779 standard) are used for both exhaust and supply air streams. F class filters can be also used optionally. F class filters reduce the available static pressure of the unit for the nominal air flow rate.

Performance data

ENERGY BOX - TC 400

Performance curve

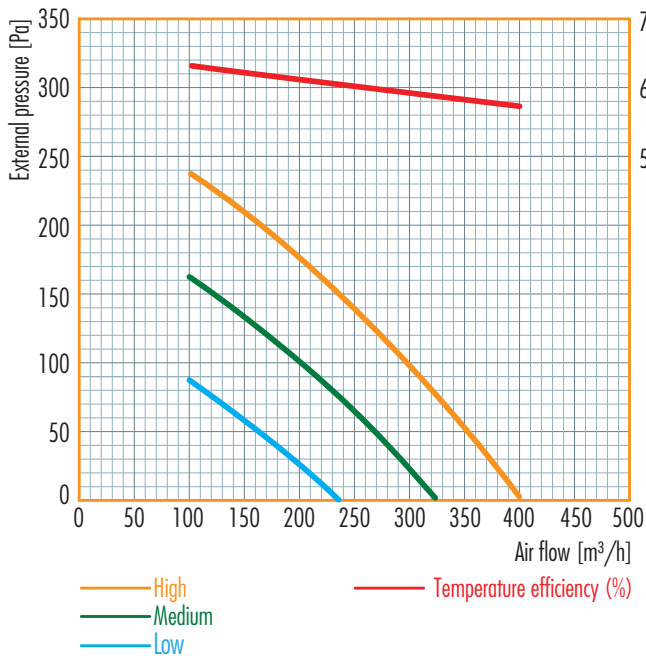

ENERGY BOX - TC 600

Performance curve

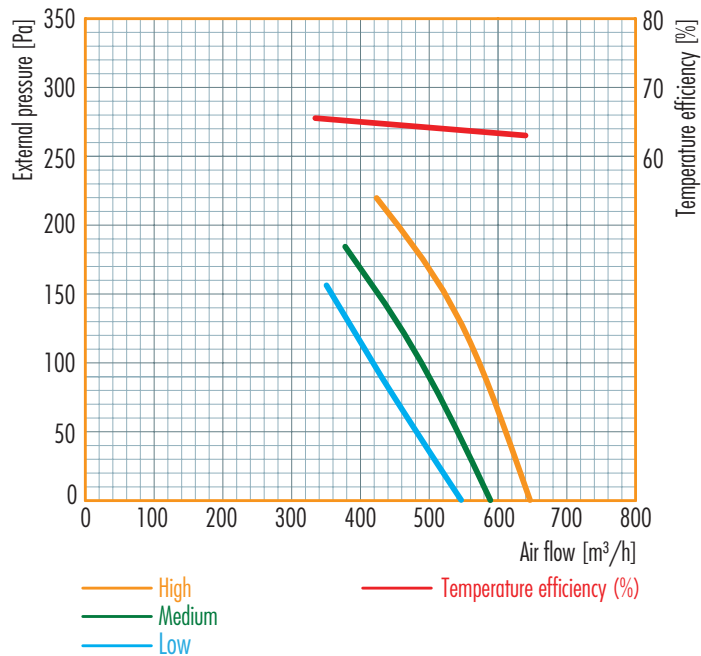

ENERGY BOX - TC 600

Sound curve

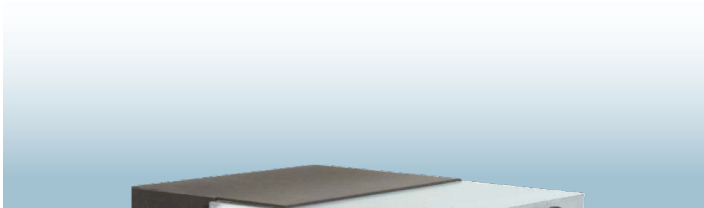
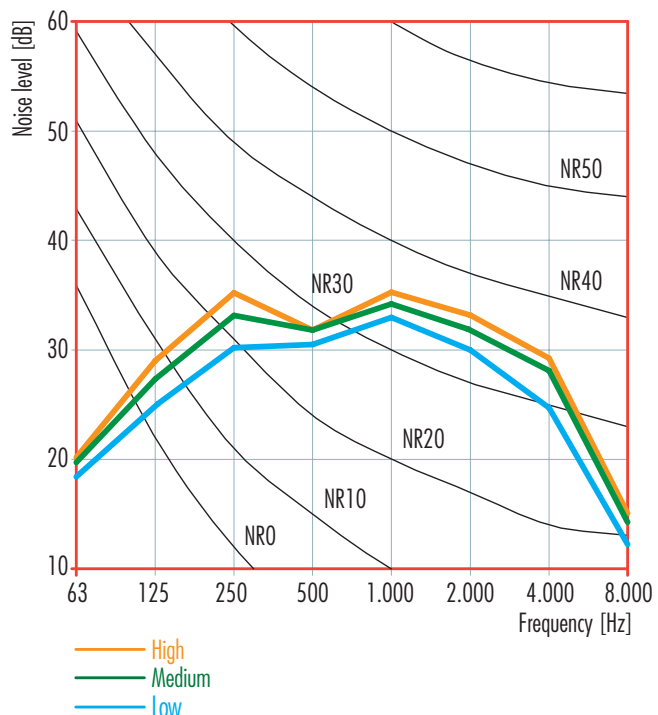

Note : Efficiency values are calculated according to EN 308 standard.

Performance data

ENERGY BOX - TC 1.000

Performance curve

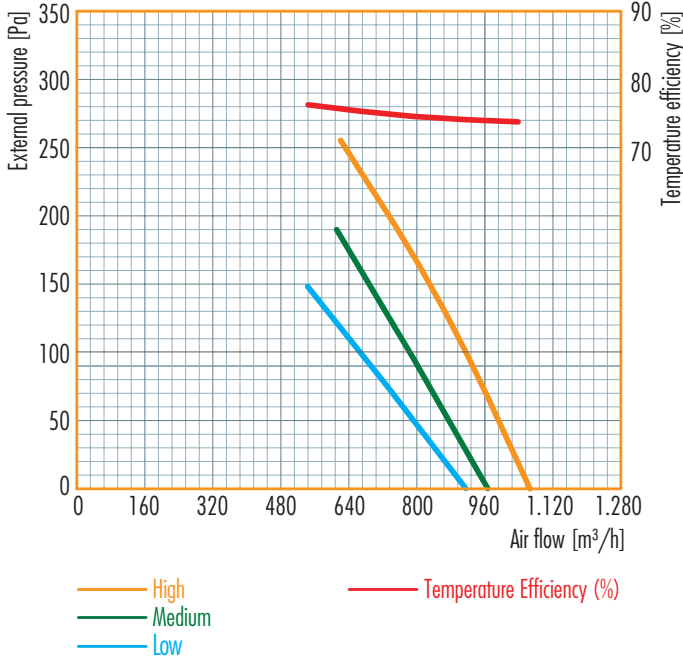

ENERGY BOX - TC 1.500

Performance curve

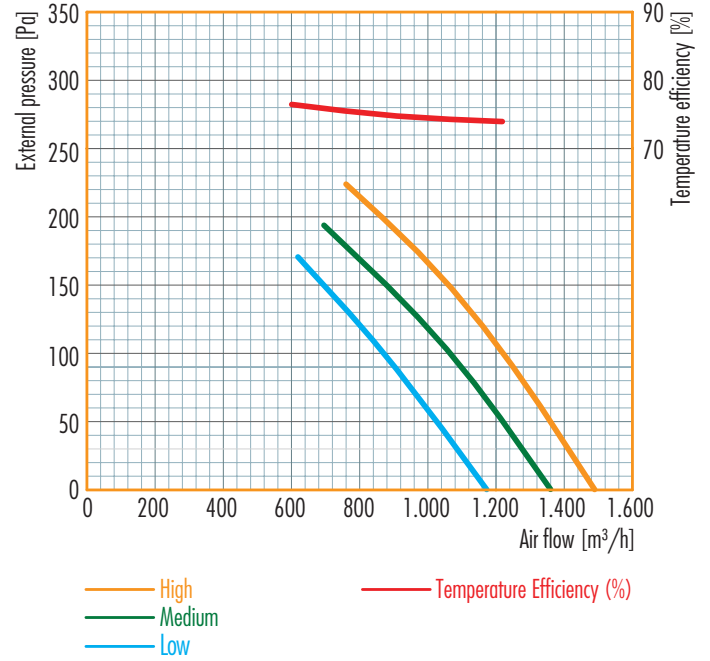

ENERGY BOX - TC 1.000

Sound curve

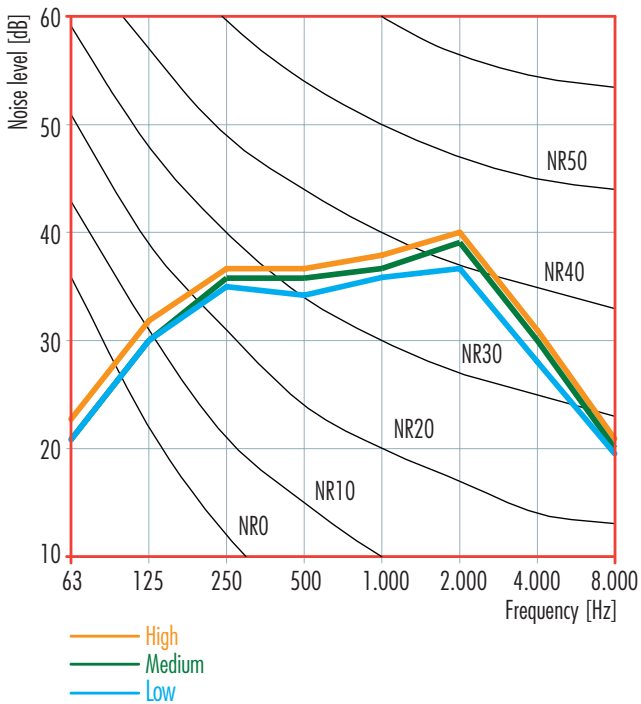

ENERGY BOX - TC 1.500

Sound curve

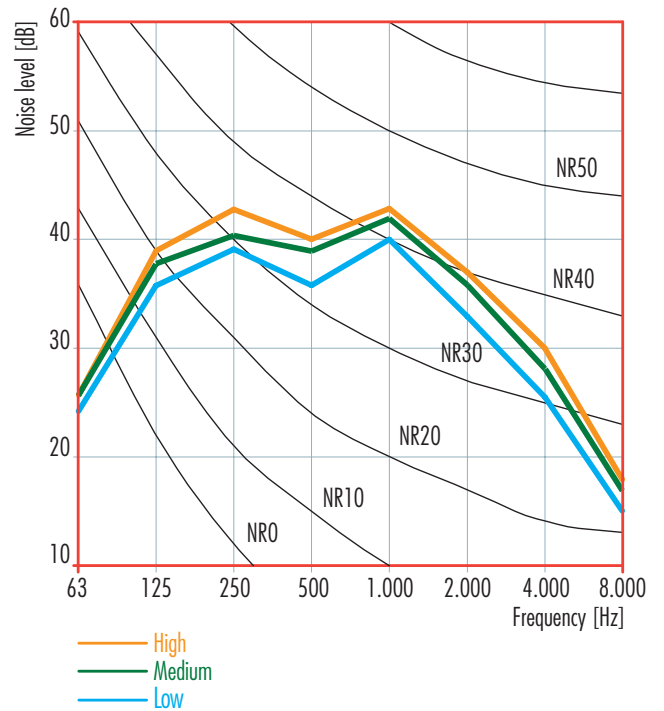

Note : Efficiency values are calculated according to EN 308 standard.

Performance data

ENERGY BOX - TC 2.000

Performance curve

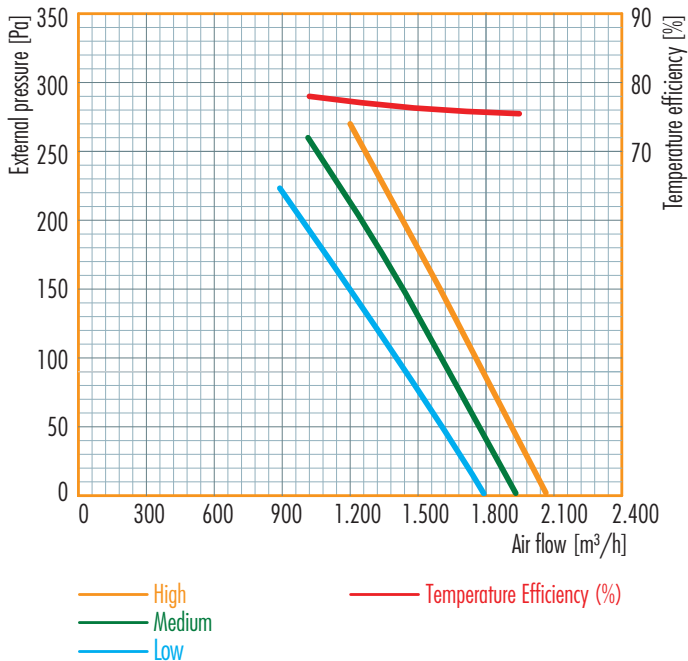

ENERGY BOX - TC 2.500

Performance curve

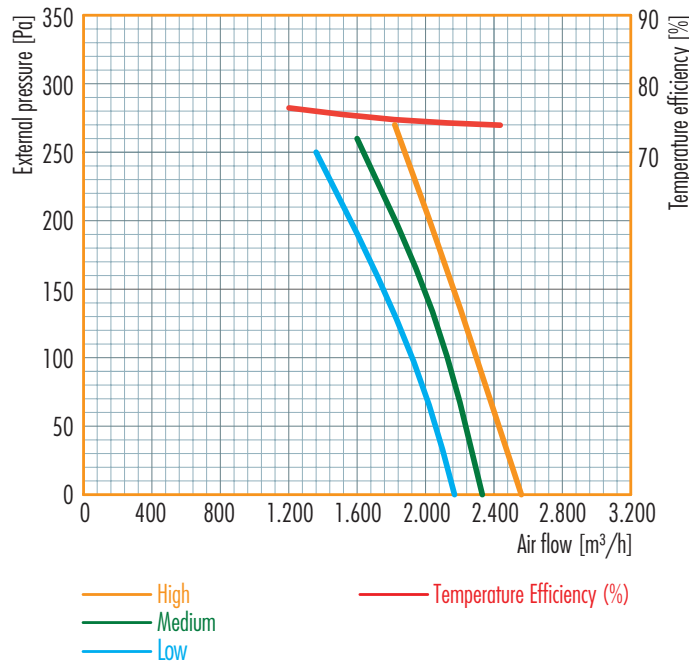

ENERGY BOX - TC 2.000

Sound curve

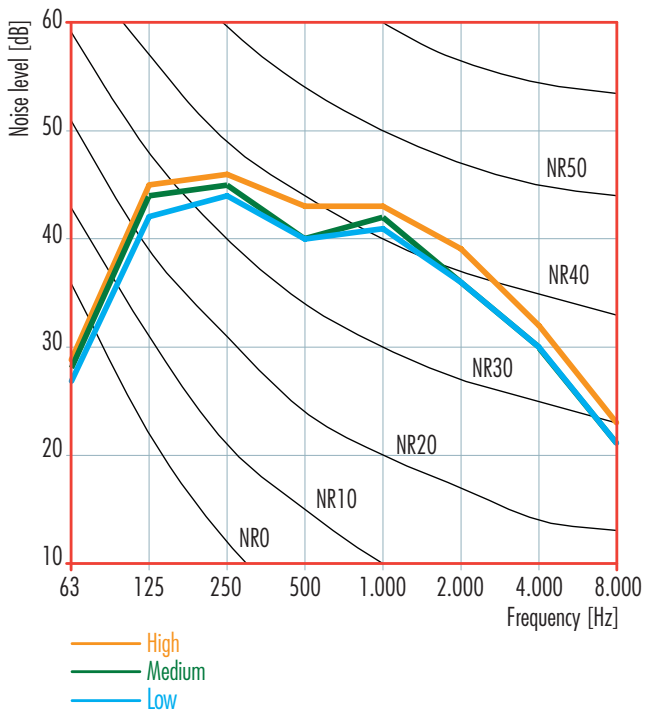

ENERGY BOX - TC 2.500

Sound curve

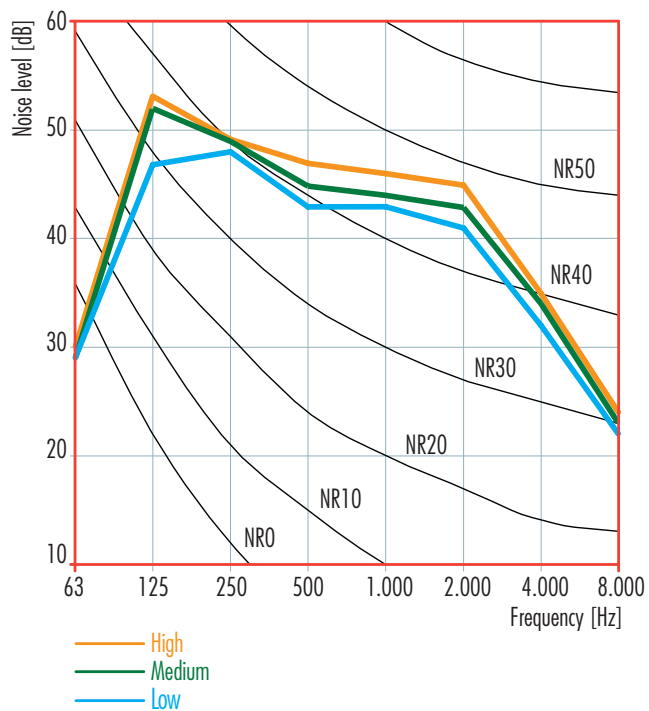

Note : Efficiency values are calculated according to EN 308 standard.

Performance data

ENERGY BOX - TC 4.000

Performance curve

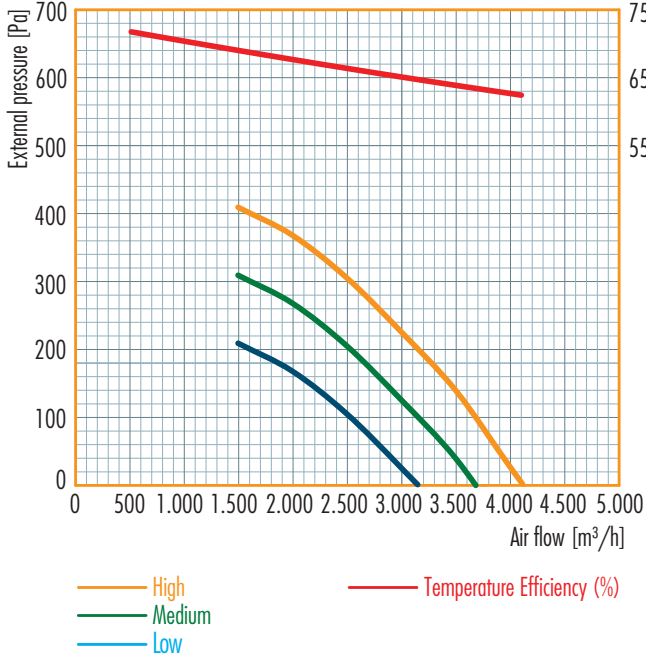

ENERGY BOX - TC 5.000

Performance curve

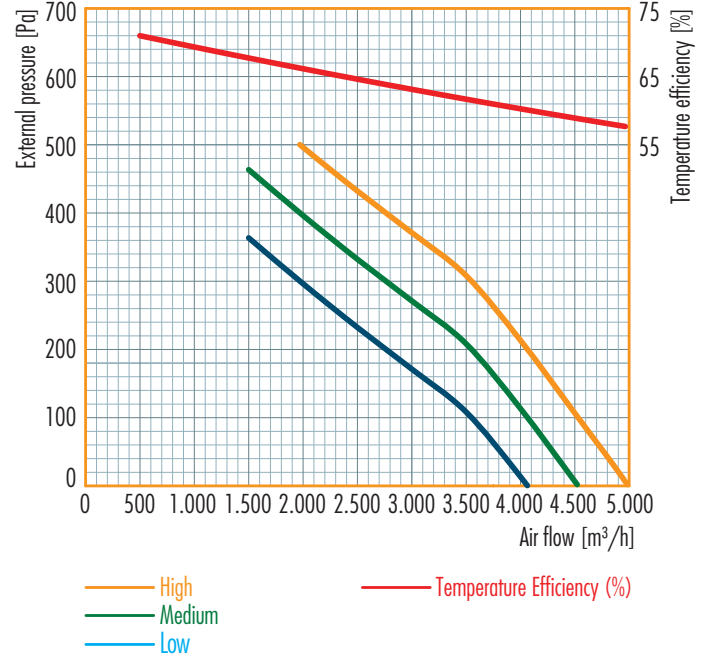

Installation options

- 1
- Ceiling installation
- 2
- Sideways or vertical wall installation
- 3
- Floor installation

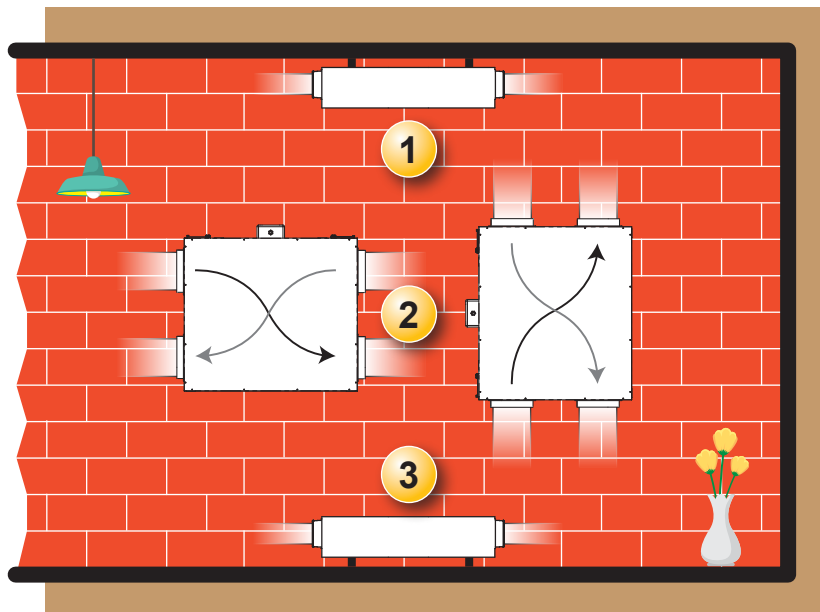

Note : Efficiency values are calculated according to EN 308 standard.

Technical specifications & unit dimensions

| ENERGY BOX - TC Technical specification | ENERGY BOX - TC | | 400 | 600 | 1.000 | 1.500 | 2.000 | 2.500 | 4.000 | 5.000 |
|--|------------------------|--|-------------|------|-------|-------|-------|-------|-------|-------|
| | Air Flow* | m ³ /h | 400 | 640 | 1.060 | 1.480 | 2.050 | 2.550 | 4.100 | 5.000 |
| | Supply Voltage | V/Hz/ph | 230/ 50 /1~ | | | | | | | |
| | Max. Power Consumption | W | 96 | 204 | 310 | 450 | 450 | 1.030 | 1.420 | 2.600 |
| | Operation Current | A | 0,44 | 0,90 | 1,36 | 2,0 | 2,0 | 4,5 | 6,0 | 11,6 |
| | Max. Sound Pressure** | dB | 35 | 36 | 36 | 41 | 45 | 49 | 50 | 52 |
| | Unit Weight | kg | 38 | 50 | 84 | 102 | 118 | 122 | 225 | 280 |
| | Filter Class | G Class Synthetic Filter According to EN 779 | | | | | | | | |

* External static pressure is 0 Pa.

** Measured at 1,5 m distance to the unit @ 250 Hz.

ENERGY BOX - TC unit dimensions

| | 400 | 600 | 1.000 | 1.500 | 2.000 | 2.500 | 4.000 | 5.000 |
|---|-------|-------|-------|-------|-------|-------|--------------------|--------------------|
| A | 758 | 665 | 925 | 1.175 | 1.125 | 1.425 | 1.570 | 1.651 |
| B | 985 | 1.130 | 1.130 | 1.150 | 1.650 | 1.650 | 2.200 | 2.200 |
| C | 275 | 330 | 330 | 330 | 440 | 440 | 587 | 650 |
| D | Ø 160 | Ø 200 | Ø 250 | Ø 250 | Ø 300 | Ø 355 | 500x400 800x400 | 550x450 800x450 |

*All measurement values are mm.

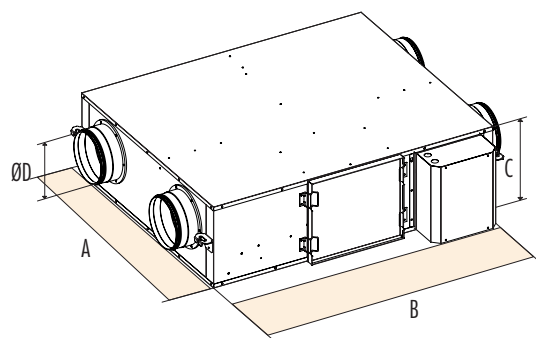

ENERGY BOX - TC service space & installation

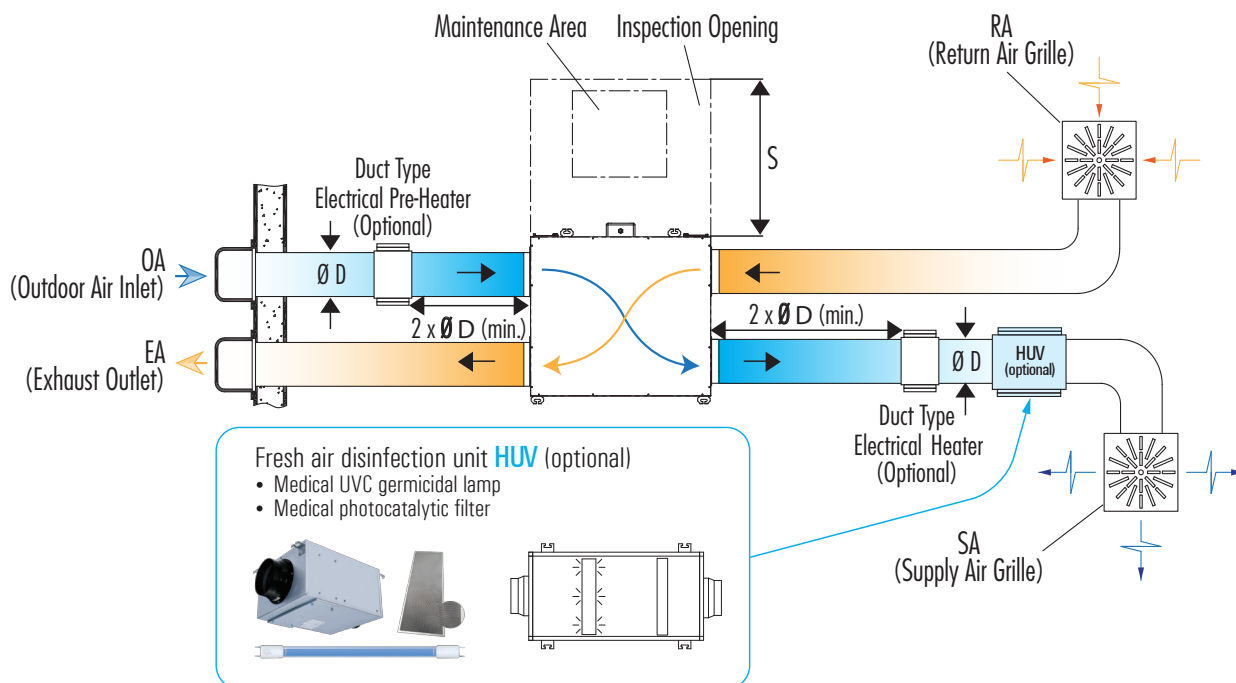

| | 400 | 600 | 1.000 | 1.500 | 2.000 | 2.500 | 4.000 | 5.000 |
|---|-----|-----|-------|-------|-------|-------|-------|-------|
| S | 700 | 600 | 600 | 600 | 700 | 700 | 1.100 | 1.100 |

"S" value indicate the size of the service area.

A service space of "C" must be left under the unit for fan service.

*All measurement values are mm.

Note : Efficiency values are calculated according to EN 308 standard.

Working principle of unit

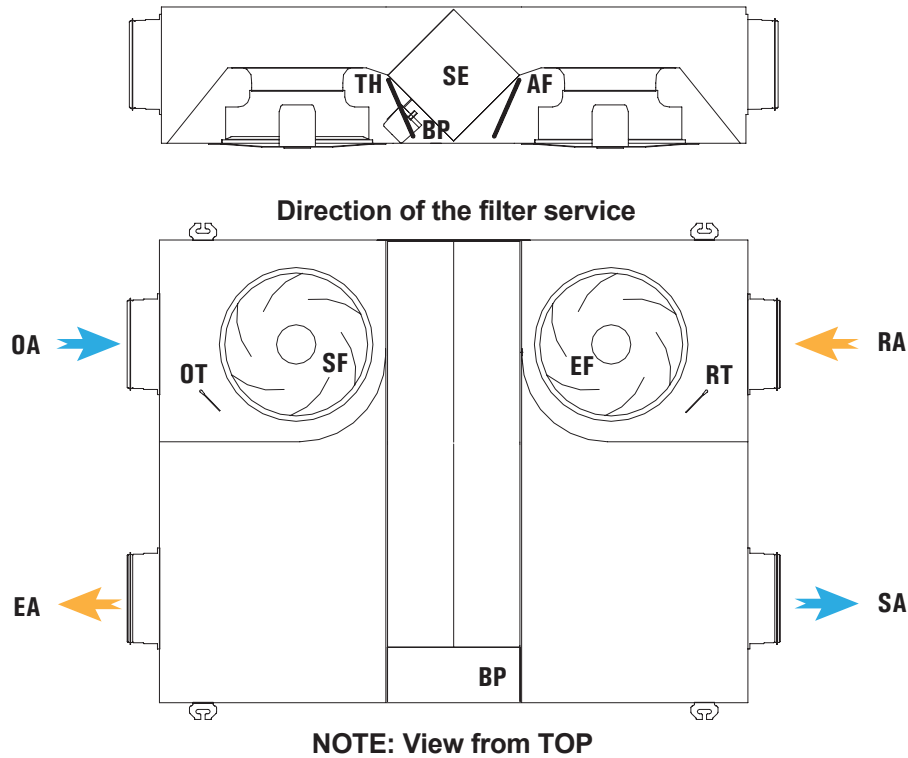

Descriptions

| | | |
|-------------------------|--|---|
| SA - Supply air | BP - By-pass damper | RT - Return air temperature sensor |
| RA - Return air | SF - Supply air fan | AF - Exhaust air filter |
| EA - Exhaust air | OT - Outdoor air temperature sensor | SE - Cellulosic exchanger |
| OA - Outdoor air | EF - Exhaust air fan | TH - Fresh air filter |

Cellulosic exchanger

- ◆ High efficiency sensible & latent enthalpy transfer
- ◆ Humidity transfer
- ◆ Up to 20% reduction in cooling load
- ◆ Sound absorbing material

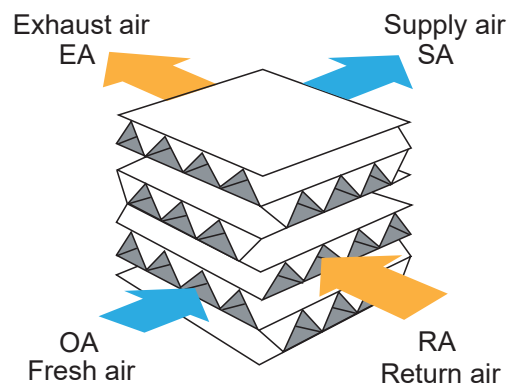

Control system

| Automation Options | | Control Cards | | | | | | |
|----------------------------------|---------------------------------|----------------|--------------|---------------|---------------|---------------|--------|--------|
| Standard | Optional | Standard Basic | Standard Pro | Alternative 1 | Alternative 2 | Alternative 3 | | |
| | | | | | | Type 1 | Type 2 | Type 3 |
| OA Temperature Sensor | | ✓ | ✓ | ✓ | ✓ | ✓ | ✓ | ✓ |
| RA Temperature Sensor | | ✓ | ✓ | ✓ | ✓ | ✓ | ✓ | ✓ |
| SA Fan Control | | ✓ | ✓ | ✓ | ✓ | ✓ | ✓ | ✓ |
| RA Fan Control | | ✓ | ✓ | ✓ | ✓ | ✓ | ✓ | ✓ |
| Filter Contamination Info (Time) | | ✓ | ✓ | ✓ | ✓ | ✓ | ✓ | ✓ |
| Modbus RTU | | ✓ | ✓ | ✗ | ✓ | ✓ | ✓ | ✓ |
| | On/Off Damper Control | ✓ | ✓ | ✗ | ✓ | ✓ | ✓ | ✓ |
| | Proportional Damper Control | ✗ | ✗ | ✗ | ✓ | ✓ | ✓ | ✓ |
| | Airflow Control | | | ✗ | ✓ | | ✓ | |
| | Humidity Control | ⊖ | ⊖ | ✓ | ✓ | ⊖ | ✓ | ⊖ |
| | CO2 Control | | | ✓ | ✓ | | ✓ | |
| | SA Temperature Sensor | ✓ | ✓ | ✓ | ✓ | ✓ | ✓ | ✓ |
| | On/Off Heating Coil | ✓ | ✓ | ✗ | ✓ | ✓ | ✓ | ✓ |
| | Proportional Heating Coil | ✗ | ✗ | ✗ | ✓ | ✓ | ✓ | ✓ |
| | On/Off Cooling Coil | ✓ | ✓ | ✗ | ✓ | ✓ | ✓ | ✓ |
| | Proportional Cooling Coil | ✗ | ✗ | ✗ | ✓ | ✓ | ✓ | ✓ |
| | Electrical Pre-Heater | ✓ | ✓ | ✗ | ✓ | ✓ | ✓ | ✓ |
| | Electrical After-Heater | ✓ | ✓ | ✗ | ✓ | ✓ | ✓ | ✓ |
| | BacNET MSTP | ✗ | ✗ | ✗ | ✓ | ✓ | ✓ | ✓ |
| | Web Browser (TCP/IP) | ✗ | ✗ | ✗ | ✓ | ✗ | ✓ | ✗ |
| | Weekly Timer | ✗ | ✓ | ✗ | ✓ | ✓ | ✓ | ✓ |
| | Filter Contamination Info (DPS) | ✓ | ✓ | ✓ | ✓ | ✓ | ✓ | ✓ |

⊖ Only one of them the defined functions is selectable for this control card.

| Control Panel | | Control Cards | | | | | | |
|---------------|--|----------------|--------------|---------------|---------------|---------------|--------|--------|
| Panel Type | Panel Descriptions | Standard Basic | Standard Pro | Alternative 1 | Alternative 2 | Alternative 3 | | |
| | | | | | | Type 1 | Type 2 | Type 3 |
| | Standard - Basic Wall - mounted type Max : 30 m communication ability | ✓ | ✗ | ✗ | ✗ | ✗ | ✗ | ✗ |
| | Standard - Pro Wall - mounted type Max : 50 m communication ability | ✗ | ✓ | ✗ | ✗ | ✗ | ✗ | ✗ |
| | Alternative - 1 Wall - mounted type Wireless Radio Frequency (RF) panel Max : 50 m communication ability | ✗ | ✗ | ✓ | ✗ | ✗ | ✗ | ✗ |
| | Alternative - 2 Wall - mounted type hand panel, IP 30 protection class, Max : 100 m communication ability | ✗ | ✗ | ✗ | ✓ | ✗ | ✗ | ✗ |
| | Alternative - 3.1 Wall - mounted type room panel, IP 30 protection class, Max : 700 m communication ability | ✗ | ✗ | ✗ | ✗ | ✗ | ✗ | ✓ |
| | Alternative - 3.2 Hand Panel 1 : Wall - mounted type, IP 65 protection class for only front side of panel, Max:50 m communication ability Hand Panel 2 : Magnet type, IP 65 protection class for whole panel, Max : 50 m communication ability | ✗ | ✗ | ✗ | ✗ | ✓ | ✓ | ✓ |
| | Alternative - 3.3 Magnet type, IP 31 protection class, Max : 700 m communication ability | ✗ | ✗ | ✗ | ✗ | ✓ | ✓ | ✓ |

Control system

Selection of Electrical Cable Cross-Section

| Electrical Cable Selection of Heat Recovery Unit - 230V 1 phase | | | | | | | | |
|---|-------------------------|-------------|--|-----|-----|-----|-----|----|
| Unit Model ENERGY BOX - TC | Unit Power Input (W) | Fuse (A) | Cable Cross-Section (mm ²) | | | | | |
| | | | 1,5 | 2,5 | 4 | 6 | 10 | 16 |
| 400 | 96 | 1 | 244 | - | - | - | - | - |
| 600 | 204 | 2 | 115 | 192 | - | - | - | - |
| 1.000 | 310 | 2 | 76 | 126 | - | - | - | - |
| 1.500 | 450 | 3 | 52 | 87 | 139 | 208 | - | - |
| 2.000 | 450 | 3 | 52 | 87 | 139 | 208 | - | - |
| 2.500 | 1.030 | 6 | - | 38 | 61 | 91 | 152 | - |
| 4.000 | 1.420 | 10 | - | 28 | 44 | 66 | 110 | - |
| 5.000 | 2.600 | 16 | - | - | 24 | 36 | 60 | 96 |

Note: The values given in the table is the length of the cable in meters (m). Cable property: 3 x (phase + neutral + earth).

| Electrical Cable Selection of Electric Heater - 230V 1 phase | | | | | | | | | |
|--|-------------------------|--------------------------|-------------|--|-----|-----|-----|-----|----|
| Unit Model ENERGY BOX - TC | Heater Diameter (mm) | Unit Power Input (kW) | Fuse (A) | Cable Cross-Section (mm ²) | | | | | |
| | | | | 1,5 | 2,5 | 4 | 6 | 10 | 16 |
| 400 | ∅ 160 | 1 | 6 | 61 | 102 | 163 | 163 | - | - |
| 600 | ∅ 200 | 2 | 16 | 31 | 51 | 82 | 122 | - | - |
| 1.000 | ∅ 250 | 3 | 20 | - | 34 | 55 | 82 | 136 | - |
| 1.500 | ∅ 250 | 3 | 20 | - | 34 | 55 | 82 | 136 | - |

Note: The values given in the table is the length of the cable in meters (m). Cable property: 3 x (phase + neutral + earth).

| Electrical Cable Selection of Electric Heater - 400V 3 phase | | | | | | | | | |
|--|-------------------------|--------------------------|-------------|--|-----|-----|-----|----|----|
| Unit Model ENERGY BOX - TC | Heater Diameter (mm) | Unit Power Input (kW) | Fuse (A) | Cable Cross-Section (mm ²) | | | | | |
| | | | | 1,5 | 2,5 | 4 | 6 | 10 | 16 |
| 2.000 | ∅ 300 | 5 | 3 x 16 | 73 | 121 | 194 | - | - | - |
| 2.500 | ∅ 355 | 7 | 3 x 16 | 52 | 87 | 139 | - | - | - |
| 3.000 | 500 x 400 | 8 | 3 x 16 | 46 | 76 | 121 | 182 | - | - |
| 4.000 | 550 x 450 | 10 | 3 x 20 | 37 | 61 | 97 | 146 | - | - |

Note: The values given in the table is the length of the cable in meters (m). Cable property: 4 x (phase 1 + phase 2 + phase 3 + earth).

Accessories

Duct type electric heater



Duct type electric heater that is used for reinforcement purpose depending on needs, is produced of stainless steel heating elements and galvanized metal casing. Besides, duct type electric heater is produced stainless sheet body optionally. Electric heaters are equipped with two excessive temperature protection. When inside of the electric heater's temperature is 70 °C, "automatic excessive temperature protection" enables and electric heater disables automatically. When 70 °C automatic temperature protection doesn't enable and the inside of the electric heater's temperature is 110 °C, the second protection enables and electric heater disables until the manual reset will be done. The electrical heaters, designed as maximum 2 steps, step automatically according to temperature that is set on room control panel with control panel. Electric heaters are connected in Delta connection in standard models.

Heating capacity calculation : $Q = 0,33 \times V \times (T_2 - T_1)$ | Q : Heating capacity (W) | T_1 : Air temperature before the heater (°C)
 V : Air flow through electric heater (m³/h) | T_2 : Air temperature after the heater (°C)

Duct type coils



Duct type heating / cooling coils are assembled in cabin as suitable to mount inside duct and have standard capacity. Coils consist of copper tubes and aluminum fins. Inlets and outlets of cabin are suitable for circular duct connections as in heat recovery ventilation units. Additionally, cooling coils have drain pan and extra insulation to prevent condensation of cabin. Both heating and cooling coils can be controlled separately as on / off via unit automation system.

Ventilation on demand

Duct type heating / cooling coils are assembled in cabin as suitable to mount inside duct and have standard capacity. Coils consist of copper tubes and aluminum fins. Inlets and outlets of cabin are suitable for circular duct connections as in heat recovery ventilation units. Additionally, cooling coils have drain pan and extra insulation to prevent condensation of cabin. Both heating and cooling coils can be controlled separately as on / off via unit automation system.

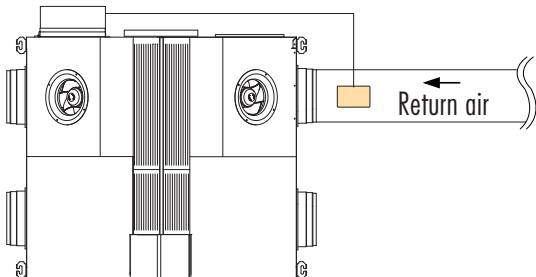

Fresh air demand in a space is calculated according to human occupancy and / or physical properties of the conditioned space. The calculation is based on the maximum indoor occupancy. In practice maximum occupancy is observed for only a small period of time annually where lower air flow rates will be sufficient for most of the year. By reducing the air flow rate according to the fresh air demand;

It is possible to reduce units electrical consumption and reduce also energy consumption used to condition the space. It should be noted that by increasing fresh air rate, indoors heating / cooling demand will also be increased. With the help of control kit of unit, it is possible to regulate fresh air rate according to the demand indoors. Indoor air quality sensor or CO₂ sensor is mounted to the return duct or the conditioned space and the demanded condition is set. A 0 -10 V signal will be created and the unit's air flow will be regulated according to the signal.

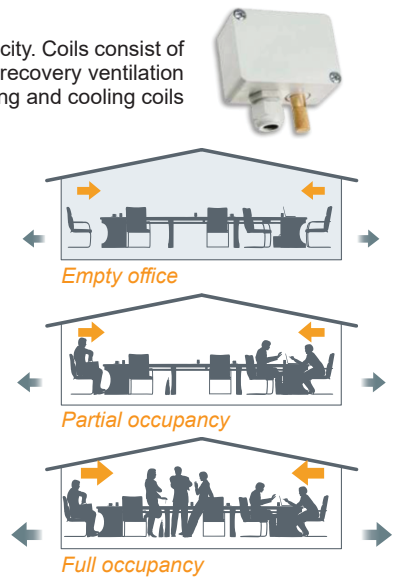

Sound attenuator for circular ducts



Sound attenuators are designed for standard duct dimensions. Various lengths are available according to attenuation demand. Sound attenuation capacities are given in the table. For better performance sound attenuators can be used in series. For the best result the sound attenuators shall be installed just after the unit.

Sound attenuator dimensions [mm]

| CSA | 63 | 125 | 250 | 500 | 1k | 2k | 4k | 8k | length (L) | Ø d | Ø do |
|-----------|----|-----|-----|-----|----|----|----|----|------------|-----|------|
| 200 - 300 | 1 | 2 | 3 | 6 | 10 | 14 | 12 | 14 | 300 | 200 | 260 |
| 200 - 600 | 2 | 3 | 6 | 7 | 13 | 17 | 18 | 20 | 600 | 200 | 260 |
| 200 - 900 | 3 | 4 | 7 | 10 | 16 | 18 | 21 | 22 | 900 | 200 | 260 |
| 250 - 300 | 1 | 2 | 6 | 6 | 13 | 16 | 14 | 15 | 300 | 250 | 310 |
| 250 - 600 | 2 | 3 | 7 | 7 | 18 | 21 | 20 | 22 | 600 | 250 | 310 |
| 250 - 900 | 3 | 4 | 9 | 8 | 21 | 24 | 21 | 23 | 900 | 250 | 310 |
| 300 - 300 | 1 | 2 | 4 | 4 | 10 | 12 | 12 | 15 | 300 | 300 | 360 |
| 300 - 600 | 1 | 3 | 6 | 7 | 13 | 15 | 17 | 19 | 600 | 300 | 360 |
| 300 - 900 | 2 | 4 | 7 | 8 | 15 | 17 | 18 | 21 | 900 | 300 | 360 |
| 355 - 600 | 1 | 3 | 8 | 8 | 9 | 6 | 5 | 7 | 600 | 355 | 415 |
| 355 - 900 | 4 | 4 | 13 | 13 | 11 | 7 | 6 | 8 | 900 | 355 | 415 |

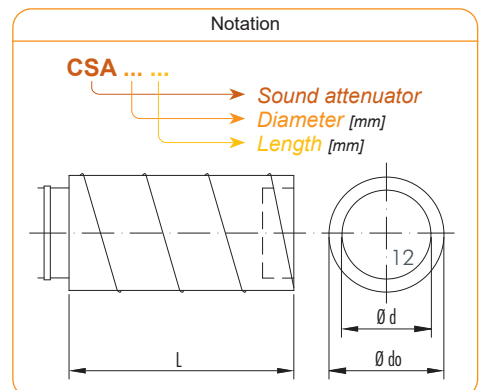



Management System
ISO 14001:2015



www.tuv.com
ID: 9108650718

ISO 9001:2015

ISO 14001:2015

AIR HANDLING UNITS



HEAT EXCHANGERS



FAN COIL UNITS



FANS & FAN SECTIONS



FIRE DAMPERS



AIR OUTLETS



STEAM HUMIDIFIERS - DEHUMIDIFIERS



CENTRAL VACUUM SYSTEMS



TUBO
THINK CLEAN

STAINLESS STEEL CHIMNEYS



AIR FILTERS



AIR CURTAINS



EVAPORATIVE COOLING



Main Office ATHENS

📍 Michail Karaoli Str. 19,
14343, Nea Chalkidona, Athens
211-7055500
✉ sales@airtechnic.gr

Factory - THIVA

📍 4th km Thiva - Chalkida Hwy,
32200, Thiva
22620 - 89006
✉ factory@airtechnic.gr

Factory - THESSALONIKI

📍 End of Meandrou Str.,
57013, Oraiokastro, Thessaloniki
2311 - 824000
✉ thessaloniki@airtechnic.gr