

THT

400°C/2h and 300°C/2h tubular axial extract fans with short casings



Tubular axial extract fans with short casing for immersed operation in fire risk zones.

Fan:

- Tubular casing in sheet steel.
- Variable angle impeller made of cast aluminium.
- Approved in accordance with standard EN 12101-3, with certifications no.: 0370-CPR-0305 (F400) and 0370-CPR-0973 (F300).
- Airflow direction from motor to impeller.

Motor:

- Class H motors for S1 continuous operation and S2 emergency use. With ball bearings, IP55 protection and 1 or 2 speeds, depending on model.
- Motors with IE3 efficiency for powers equal to or greater than 0.75 kW, except single-phase, 2-speed and 8-pole.
- Three-phase 230/400 V 50 Hz (up to 3 kW) and 400/690 V 50 Hz (powers greater than 3 kW).

- Maximum temperature of air to be carried: S1 -20 °C +40 °C continuous service, also suitable for warm climates with temperatures up to 50 °C. S2 operation, 300 °C/2h, 400 °C/2h.

Finish:

- Anti-corrosive finish in polyester resin, polymerised at 190 °C, after degreasing with phosphate-free nanotechnology treatment.

Available versions:

- THT/CL: tubular axial fans with long casing equipped with inspection hatch.

On request:

- Airflow direction from impeller to motor.
- 100% reversible impellers.

Order code

From size 40 to size 100

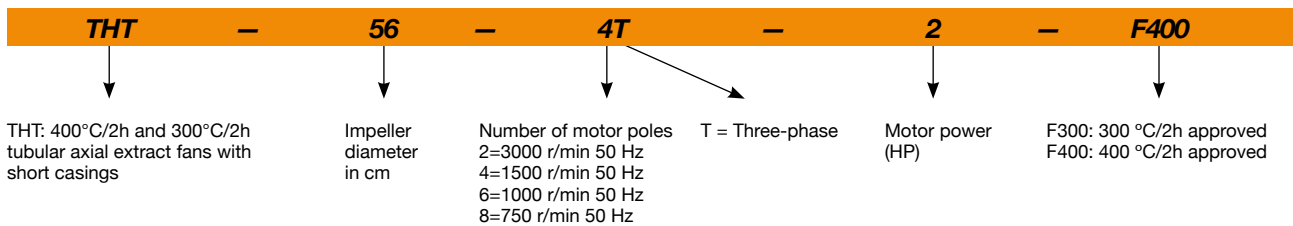

From size 125 to size 160

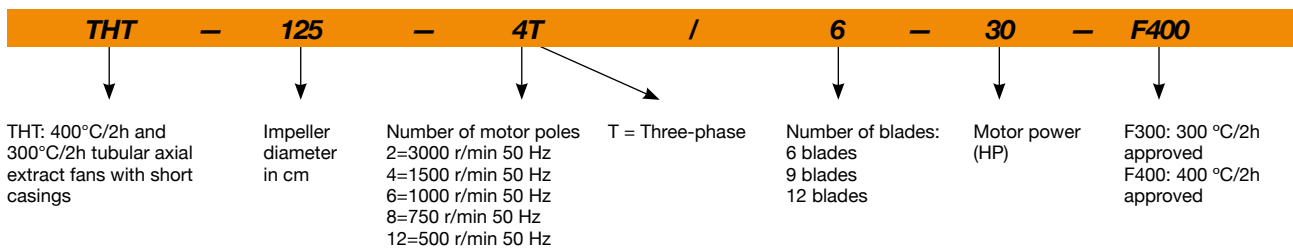

Technical characteristics

Model ¹	Speed (r/min)	Maximum admissible current (A)			Installed power (kW)	Blade tilt angle (°)	Maximum flow rate (m ³ /h)	Sound pressure level ² dB (A)	Approx. weight (Kg)
		230V	400V	690V				Inlet	
THT-40-2T-1.5 IE3	2880	4.02	2.23		1.10	20	7040	71	31
THT-40-2/4T-1.5	2900 / 1435		2.89 / 1.04		1.10 / 0.25	20	7040 / 3480	71 / 56	32
THT-40-4T-0.75	1420	2.84	1.64		0.55	32	4800	55	29
THT-40-6T-0.75	930	2.90	1.75		0.55	32	3150	46	34
THT-40-6/12T-0.75	940 / 455		1.98 / 0.84		0.55 / 0.09	32	3150 / 1520	46 / 31	38
THT-45-2T-2 IE3	2880	5.32	2.95		1.50	16	9400	71	34
THT-45-2/4T-2	2940 / 1460		4.33 / 1.36		1.50 / 0.37	16	9400 / 4670	71 / 56	34
THT-45-2T-3 IE3	2900	7.56	4.19		2.20	22	11330	71	36
THT-45-2T-4 IE3	2900	9.94	5.51		3.00	28	13075	72	46
THT-45-4T-0.75	1420	2.84	1.64		0.55	36	7450	58	30
THT-45-6T-0.75	930	2.90	1.75		0.55	30	4450	48	35
THT-45-6/12T-0.75	940 / 455		1.98 / 0.84		0.55 / 0.09	30	4450 / 2150	48 / 33	39
THT-50-2T-3 IE3	2870	7.56	4.19		2.20	12	11950	76	43
THT-50-4T-0.75	1420	2.84	1.64		0.55	22	8390	60	32
THT-50-6T-0.75	930	2.90	1.75		0.55	32	7000	52	36
THT-56-2T-5.5 IE3	2890		7.18	4.32	4.00	16	18800	78	60
THT-56-4T-1 IE3	1430	3.08	1.79		0.75	22	11250	63	40
THT-56-4T-1.5 IE3	1420	4.1	2.37		1.10	30	13600	63	40
THT-56-4/8T-1.5	1440 / 705		2.69 / 1.12		1.10 / 0.25	30	13600 / 6640	63 / 48	43
THT-56-4T-2 IE3	1425	5.89	3.38		1.50	36	15030	64	43
THT-56-6T-0.75	930	2.9	1.75		0.55	38	10140	54	39
THT-56-6/12T-0.75	940 / 455		2.35 / 1.15		0.60 / 0.15	38	10140 / 4890	54 / 39	43
THT-63-2T-12 IE3	2920		18.07	10.44	9.20	18	32300	83	143
THT-63-2T-20 IE3	2960		26.50	15.35	15.00	28	39950	82	170
THT-63-4T-1 IE3	1430	3.08	1.79		0.75	14	15190	67	43
THT-63-4T-1.5 IE3	1420	4.1	2.37		1.10	20	17800	66	45
THT-63-4/8T-1.5	1440 / 705		2.69 / 1.12		1.10 / 0.25	20	17800 / 8680	66 / 51	49
THT-63-4T-2 IE3	1425	5.89	3.38		1.50	24	19280	66	49
THT-63-4/8T-2	1415 / 715		3.40 / 1.65		1.50 / 0.30	24	19280 / 9740	66 / 52	60
THT-63-4T-3 IE3	1435	7.86	4.52		2.20	32	22150	68	54
THT-63-4/8T-3	1415 / 700		4.80 / 1.85		2.20 / 0.45	32	22150 / 10920	68 / 53	66
THT-63-4T-4 IE3	1430	11.01	6.33		3.00	38	24240	69	63
THT-63-4/8T-4	1420 / 710		6.45 / 2.28		3.00 / 0.60	38	24240 / 12070	69 / 54	77
THT-63-6T-0.75	930	2.9	1.75		0.55	28	13590	57	45
THT-63-6/12T-0.75	940 / 455		2.35 / 1.15		0.60 / 0.15	28	13590 / 6550	57 / 42	49
THT-63-6T-1 IE3	940	3.36	1.93		0.75	38	15890	58	48
THT-63-6/12T-1	935 / 455		3.75 / 2.76		0.80 / 0.20	38	15890 / 7700	58 / 43	55
THT-71-4T-1.5 IE3	1420	4.1	2.37		1.10	12	19480	71	52
THT-71-4/8T-1.5	1440 / 705		2.69 / 1.12		1.10 / 0.25	12	19480 / 9500	71 / 56	56
THT-71-4T-2 IE3	1425	5.89	3.38		1.50	14	20900	70	56
THT-71-4/8T-2	1415 / 715		3.40 / 1.65		1.50 / 0.30	14	20900 / 10560	70 / 56	67
THT-71-4T-3 IE3	1435	7.86	4.52		2.20	22	25100	70	61
THT-71-4/8T-3	1415 / 700		4.80 / 1.85		2.20 / 0.45	22	25100 / 12370	70 / 55	74
THT-71-4T-4 IE3	1430	11.01	6.33		3.00	28	27480	70	70
THT-71-4/8T-4	1420 / 710		6.45 / 2.28		3.00 / 0.60	28	27480 / 13680	70 / 55	83
THT-71-6T-0.75	930	2.9	1.75		0.55	20	16100	60	52
THT-71-6/12T-0.75	940 / 455		2.35 / 1.15		0.60 / 0.15	20	16100 / 7760	60 / 45	56
THT-71-6T-1 IE3	940	3.36	1.93		0.75	26	17300	60	55
THT-71-6/12T-1	935 / 455		3.75 / 2.76		0.80 / 0.20	26	17300 / 8380	60 / 45	62
THT-71-6T-1.5 IE3	945	4.73	2.72		1.10	34	19930	61	61
THT-71-6/12T-1.5	940 / 460		3.52 / 2.00		1.20 / 0.30	34	19930 / 9760	61 / 46	69
THT-80-4T-3 IE3	1435	7.86	4.52		2.20	12	25450	75	69
THT-80-4/8T-3	1415 / 700		4.80 / 1.85		2.20 / 0.45	12	25450 / 12550	75 / 60	82
THT-80-4T-4 IE3	1430	11.01	6.33		3.00	16	30250	74	78

Technical characteristics

Model ¹	Speed (r/min)	Maximum admissible current (A)			Installed power (kW)	Blade tilt angle (°)	Maximum flow rate (m ³ /h)	Sound pressure level ² dB (A) Inlet	Approx. weight (Kg)
		230V	400V	690V					
THT-80-4/8T-4	1420 / 710		6.45 / 2.28		3.00 / 0.60	16	30250 / 15060	74 / 59	92
THT-80-4T-5.5 IE3	1440		7.95	4.61	4.00	18	32750	73	85
THT-80-4/8T-5.5	1450 / 715		7.88 / 2.87		3.80 / 1.00	18	32750 / 16150	73 / 58	118
THT-80-6T-1.5 IE3	945	4.73	2.72		1.10	18	21450	63	69
THT-80-6/12T-1.5	940 / 460		3.52 / 2.00		1.20 / 0.30	18	21450 / 10500	63 / 48	77
THT-80-6T-2 IE3	945	6.25	3.62		1.50	26	25950	64	78
THT-80-6/12T-2	960 / 470		4.46 / 3.43		1.60 / 0.40	26	25950 / 12700	64 / 49	82
THT-80-6T-3 IE3	950	9.78	5.62		2.20	32	29930	65	84
THT-80-6/12T-3	940 / 475		5.62 / 3.32		2.20 / 0.55	32	29930 / 15120	65 / 51	91
THT-80-8T-0.75	700	3.48	2.00		0.55	20	17540	57	62
THT-80-8T-1	710	5.06	2.92		0.75	28	20650	58	69
THT-90-4T-4 IE3	1430	11.01	6.33		3.00	8	33580	79	93
THT-90-4/8T-4	1420 / 710		6.45 / 2.28		3.00 / 0.60	8	33580 / 16720	79 / 64	106
THT-90-4T-5.5 IE3	1440		7.95	4.61	4.00	12	38890	78	99
THT-90-4/8T-5.5	1450 / 715		7.88 / 2.87		3.80 / 1.00	12	38890 / 19170	78 / 63	132
THT-90-4T-7.5 IE3	1430		10.40	6.04	5.50	18	46140	77	126
THT-90-4/8T-7.5	1455 / 725		11.40 / 3.86		5.50 / 1.10	18	46140 / 22910	77 / 62	140
THT-90-4T-10 IE3	1460		14.20	8.17	7.50	22	50140	76	137
THT-90-4/8T-10	1455 / 725		15.10 / 5.16		7.50 / 1.50	22	50140 / 24900	76 / 61	140
THT-90-6T-2 IE3	945	6.25	3.62		1.50	16	28780	66	92
THT-90-6/12T-2	960 / 470		4.46 / 3.43		1.60 / 0.40	16	28780 / 14090	66 / 51	96
THT-90-6T-3 IE3	950	9.78	5.62		2.20	24	34000	66	99
THT-90-6/12T-3	940 / 475		5.62 / 3.32		2.20 / 0.55	24	34000 / 17180	66 / 52	105
THT-90-6T-4 IE3	945	12.8	6.36		3.00	30	38900	69	124
THT-90-6/12T-4	970 / 485		7.37 / 3.53		2.80 / 0.70	30	38900 / 19450	69 / 54	126
THT-90-8T-1	710	5.06	2.92		0.75	18	22900	60	84
THT-90-8T-2	700	7.32	4.21		1.50	30	29490	63	99
THT-90-8T-3	705	9.3	5.35		2.20	32	30850	64	116
THT-100-4T-7.5 IE3	1430		10.40	6.04	5.50	10	46850	82	131
THT-100-4/8T-7.5	1455 / 725		11.40 / 3.86		5.50 / 1.10	10	46850 / 23260	82 / 67	145
THT-100-4T-10 IE3	1460		14.20	8.17	7.50	16	57400	79	142
THT-100-4/8T-10	1455 / 725		15.10 / 5.16		7.50 / 1.50	14	54700 / 27160	80 / 65	145
THT-100-4T-15 IE3	1455		20.70	11.99	11.00	22	66300	79	195
THT-100-4/8T-15	1470 / 730		20.70 / 7.19		11.00 / 3.00	22	66300 / 32880	79 / 64	195
THT-100-4T-20 IE3	1460		27.80	16.03	15.00	28	76150	80	210
THT-100-4/8T-20	1470 / 725		31.72 / 11.75		15.00 / 3.80	28	76150 / 37560	80 / 65	210
THT-100-4T/9-15 IE3	1460		20.70	11.99	11.00	18	55340	80	204
THT-100-4T/9-20 IE3	1460		27.80	16.03	15.00	22	63260	80	219
THT-100-4T/9-25 IE3	1475		35.40	20.39	18.50	26	70625	80	249
THT-100-4T/9-30 IE3	1475		42.20	24.44	22.00	30	74845	82	266
THT-100-6T-3 IE3	950	9.78	5.62		2.20	16	37600	70	105
THT-100-6/12T-3	940 / 475		5.62 / 3.32		2.20 / 0.55	16	37600 / 18990	70 / 56	112
THT-100-6T-4 IE3	945	12.8	6.36		3.00	20	41150	69	130
THT-100-6/12T-4	970 / 485		7.37 / 3.53		2.80 / 0.70	20	41150 / 20580	69 / 54	131
THT-100-6T-5.5 IE3	970		8.37	4.82	4.00	26	47780	70	142
THT-100-6T/9-5.5 IE3	970		11.00	6.35	4.00	20	39020	70	145
THT-100-6T/9-7.5 IE3	970		12.30	7.07	5.50	26	46765	71	153
THT-100-6T/9-10 IE3	970		15.20	8.83	7.50	34	52255	74	193
THT-125-4T/6-20 IE3	1460		27.80	16.03	15.00	10	78600	87	290
THT-125-4/8T/6-20	1470 / 725		31.72 / 11.75		15.00 / 3.80	10	78600 / 38770	87 / 72	290
THT-125-4T/6-25 IE3	1465		35.40	20.39	18.50	14	92550	86	343
THT-125-4/8T/6-27	1470 / 730		39.70 / 14.10		20.00 / 5.00	16	98830 / 48910	85 / 70	357
THT-125-4T/6-30 IE3	1470		42.20	24.44	22.00	16	98830	85	357
THT-125-4/8T/6-37	1475 / 735		54.55 / 18.50		28.00 / 6.50	20	110890 / 55260	85 / 70	437

Technical characteristics

Model ¹	Speed (r/min)	Maximum admissible current (A)			Installed power (kW)	Blade tilt angle (°)	Maximum flow rate (m ³ /h)	Sound pressure level ² dB (A)	Approx. weight (Kg)
		230V	400V	690V				Inlet	
THT-125-4T/6-40 IE3	1475		53.30	31.02	30.00	22	117450	85	437
THT-125-4T/6-50 IE3	1480		66.80	38.70	37.00	26	131050	85	473
THT-125-4T/6-60 IE3	1475		80.90	46.90	45.00	28	135820	85	543
THT-125-4T/6-75 IE3	1480		98.60	57.20	55.00	34	152100	88	643
THT-125-4T/9-25 IE3	1465		35.40	20.39	18.50	10	79650	87	352
THT-125-4T/9-30 IE3	1470		42.20	24.44	22.00	12	88290	86	366
THT-125-4/8T/9-27	1470 / 730		39.70 / 14.10		20.00 / 5.00	12	88290 / 43690	86 / 71	366
THT-125-4/8T/9-37	1475 / 735		54.55 / 18.50		28.00 / 6.50	16	104040 / 51840	85 / 70	446
THT-125-4T/9-40 IE3	1475		53.30	31.02	30.00	16	104040	85	446
THT-125-4T/9-50 IE3	1480		66.80	38.70	37.00	20	118400	85	482
THT-125-4T/9-60 IE3	1475		80.90	46.90	45.00	24	134970	85	534
THT-125-4T/9-75 IE3	1480		98.60	57.20	55.00	28	146770	86	634
THT-125-4T/9-100 IE3	1480		128.00	74.22	75.00	34	158560	88	773
THT-125-4T/12-50 IE3	1480		66.80	38.70	37.00	18	101660	86	516
THT-125-4T/12-60 IE3	1475		80.90	46.90	45.00	20	109180	86	561
THT-125-4T/12-75 IE3	1480		98.60	57.20	55.00	26	131240	86	661
THT-125-4T/12-100 IE3	1480		128.00	74.22	75.00	32	154100	88	791
THT-125-6T/6-5.5 IE3	970		8.37	4.82	4.00	10	51500	77	218
THT-125-6T/6-7.5 IE3	970		12.30	7.07	5.50	14	60640	75	225
THT-125-6/12T/6-7.5	970 / 480		14.50 / 5.17		5.50 / 1.00	14	60640 / 30010	75 / 60	239
THT-125-6T/6-10 IE3	960		15.20	8.83	7.50	20	72650	74	255
THT-125-6/12T/6-10	970 / 490		13.60 / 5.69		7.20 / 1.80	20	72650 / 36510	74 / 60	275
THT-125-6T/6-15 IE3	955		22.50	13.07	11.00	26	85850	74	285
THT-125-6/12T/6-15	970 / 485		23.10 / 8.41		11.00 / 3.00	26	85850 / 42710	74 / 59	290
THT-125-6T/6-20 IE3	950		29.00	16.78	15.00	30	92850	76	343
THT-125-6/12T/6-24	970 / 480		41.60 / 13.21		17.60 / 2.85	34	99650 / 49320	78 / 63	437
THT-125-6T/9-10 IE3	960		15.20	8.83	7.50	14	63490	77	264
THT-125-6/12T/9-10	970 / 490		13.60 / 5.69		7.20 / 1.80	14	63490 / 31910	77 / 63	284
THT-125-6T/9-15 IE3	955		22.50	13.07	11.00	20	77550	75	294
THT-125-6/12T/9-15	970 / 485		23.10 / 8.41		11.00 / 3.00	20	77550 / 38580	75 / 60	299
THT-125-6T/9-20 IE3	950		29.00	16.78	15.00	26	92950	75	352
THT-125-6/12T/9-24	970 / 480		41.60 / 13.21		17.60 / 2.85	30	98500 / 48750	76 / 61	446
THT-125-6T/9-25 IE3	975		36.10	20.77	18.50	32	101450	77	372
THT-125-6T/9-30 IE3	975		42.30	24.35	22.00	36	106525	80	382
THT-125-6T/12-10 IE3	970		15.20	8.83	7.50	12	49630	79	328
THT-125-6T/12-15 IE3	970		22.50	13.07	11.00	18	67315	77	338
THT-125-6T/12-20 IE3	970		29.00	16.78	15.00	24	81840	76	396
THT-125-6T/12-25 IE3	975		36.10	20.77	18.50	30	96765	77	406
THT-125-6T/12-30 IE3	975		42.30	24.35	22.00	32	102040	78	416
THT-125-6T/12-40 IE3	985		56.00	32.50	30.00	34	106355	79	571
THT-140-6T/6-7.5 IE3	970		12.30	7.07	5.50	8	62800	83	260
THT-140-6T/6-15 IE3	955		22.50	13.07	11.00	16	86640	78	327
THT-140-6T/6-20 IE3	950		29.00	16.78	15.00	22	102950	77	396
THT-140-6T/6-25 IE3	975		36.10	20.77	18.50	24	108750	77	448
THT-140-6T/6-30 IE3	975		42.30	24.35	22.00	28	119050	77	457
THT-140-6T/9-15 IE3	955		22.50	13.07	11.00	12	77400	82	336
THT-140-6T/9-20 IE3	950		29.00	16.78	15.00	16	91200	81	405
THT-140-6T/9-25 IE3	975		36.10	20.77	18.50	20	103800	80	458
THT-140-6T/9-30 IE3	975		42.30	24.35	22.00	22	111000	79	467
THT-140-6T/9-40 IE3	985		56.00	32.50	30.00	28	128800	79	611
THT-140-6T/9-50 IE3	980		67.20	39.00	37.00	32	135750	80	696
THT-140-6T/9-60 IE3	985		84.40	48.90	45.00	38	145610	82	931
THT-140-6T/12-30 IE3	975		42.30	24.35	22.00	20	101570	81	492
THT-140-6T/12-40 IE3	985		56.00	32.50	30.00	28	128800	80	647

Technical characteristics

Model ¹	Speed (r/min)	Maximum admissible current (A)			Installed power (kW)	Blade tilt angle (°)	Maximum flow rate (m ³ /h)	Sound pressure level ² dB (A)		Approx. weight (Kg)
		230V	400V	690V				Inlet		
THT-140-6T/12-50 IE3	985		67.20	39.00	37.00	32	143360	81	730	
THT-140-6T/12-60 IE3	985		84.40	48.90	45.00	36	156705	82	940	
THT-140-6T/12-75 IE3	985		103.00	59.70	55.00	38	162890	83	965	
THT-160-6T/6-20 IE3	950		29.00	16.78	15.00	12	111990	85	463	
THT-160-6T/6-25 IE3	975		36.10	20.77	18.50	14	121100	84	515	
THT-160-6T/6-30 IE3	975		42.30	24.35	22.00	16	129330	83	524	
THT-160-6T/6-40 IE3	985		56.00	32.50	30.00	22	153700	82	669	
THT-160-6T/6-50 IE3	980		67.20	39.00	37.00	26	170800	81	757	
THT-160-6T/6-60 IE3	985		84.40	48.90	45.00	30	185460	82	984	
THT-160-6T/6-75 IE3	985		103.00	59.70	55.00	34	199030	83	1029	
THT-160-6T/9-25 IE3	975		36.10	20.77	18.50	10	104250	90	525	
THT-160-6T/9-30 IE3	975		42.30	24.35	22.00	14	126800	88	534	
THT-160-6T/9-40 IE3	985		56.00	32.50	30.00	18	145500	86	679	
THT-160-6T/9-50 IE3	980		67.20	39.00	37.00	20	154940	85	768	
THT-160-6T/9-60 IE3	985		84.40	48.90	45.00	24	176750	85	968	
THT-160-6T/9-75 IE3	985		103.00	59.70	55.00	28	192290	84	1013	
THT-160-6T/12-60 IE3	985		84.40	48.90	45.00	20	151615	86	1002	
THT-160-6T/12-75 IE3	985		103.00	59.70	55.00	26	182250	85	1047	

¹ The 40, 45, 50 and 56-2T models only in F300 version.

² The noise level values are pressures in dB(A) measured at a distance of 3 metres in a free field.



Erp. (Energy Related Products)

Information on Directive 2009/125/EC can be downloaded from the SODECA website or the QuickFan selector programme.

Acoustic characteristics

Sound power spectrum Lw(A) in dB(A) per Hz frequency band
Values measured at inlet with maximum flow rate

	63	125	250	500	1000	2000	4000	8000		63	125	250	500	1000	2000	4000	8000
40-2-1.5	47	63	75	83	88	86	82	75	63-8-2 (2V)	39	51	60	66	66	66	60	52
40-4-1.5 (2V)	32	48	60	68	73	71	67	60	63-4-3	56	68	77	83	83	83	77	69
40-4-0.75	37	53	63	70	71	68	67	68	63-8-3 (2V)	41	53	62	68	68	68	62	54
40-6-0.75	28	44	54	61	62	59	58	59	63-4-4	57	69	78	84	84	84	78	70
40-12-0.75 (2V)	12	28	38	45	46	43	42	43	63-8-4 (2V)	42	54	63	69	69	69	63	55
45-2-2	47	60	74	86	87	86	82	74	63-6-0.75	48	58	68	72	73	71	64	56
45-4-2 (2V)	32	45	59	71	72	71	67	59	63-12-0.75 (2V)	32	42	52	56	57	55	48	40
45-2-3	47	64	74	81	88	86	83	75	63-6-1	49	59	69	73	74	72	65	57
45-2-4	52	69	78	84	88	88	83	75	63-12-1 (2V)	32	42	52	56	57	55	48	40
45-4-0.75	47	59	67	73	73	73	68	60	71-4-1.5	57	73	80	86	86	86	82	74
45-6-0.75	37	49	57	63	63	63	58	50	71-8-1.5 (2V)	41	57	64	70	70	70	66	58
45-12-0.75 (2V)	21	33	41	47	47	47	42	34	71-4-2	56	72	79	85	85	85	81	73
50-2-3	58	74	84	91	92	89	88	89	71-8-2 (2V)	41	57	64	70	70	70	66	58
50-4-0.75	49	61	69	75	75	75	70	62	71-4-3	56	72	79	85	85	85	81	73
50-6-0.75	41	53	61	67	67	67	62	54	71-8-3 (2V)	41	57	64	70	70	70	66	58
56-2-5.5	53	66	84	92	94	93	88	81	71-4-4	63	75	79	85	85	86	83	75
56-4-1	51	63	72	78	78	78	72	64	71-8-4 (2V)	48	60	64	70	70	71	68	60
56-4-1.5	51	63	72	78	78	78	72	64	71-6-0.75	46	53	73	76	76	71	63	55
56-8-1.5 (2V)	35	47	56	62	62	62	56	48	71-12-0.75 (2V)	30	37	57	60	60	55	47	39
56-4-2	52	64	73	79	79	79	73	65	71-6-1	46	64	73	76	76	71	64	55
56-6-0.75	45	55	65	69	70	68	61	53	71-12-1 (2V)	29	47	56	59	59	54	47	38
56-12-0.75 (2V)	29	39	49	53	54	52	45	37	71-6-1.5	47	65	74	77	77	72	65	56
63-2-12	64	81	91	97	98	97	95	97	71-12-1.5 (2V)	32	50	59	62	62	57	50	41
63-2-20	63	80	90	96	97	96	94	96	80-4-3	55	71	84	91	91	88	82	74
63-4-1	48	64	76	82	84	81	74	66	80-8-3 (2V)	40	56	69	76	76	73	67	59
63-4-1.5	47	63	75	81	83	80	73	65	80-4-4	54	70	83	90	90	87	81	73
63-8-1.5 (2V)	31	47	59	65	67	64	57	49	80-8-4 (2V)	39	55	68	75	75	72	66	58
63-4-2	54	66	75	81	81	81	75	67	80-4-5.5	53	69	82	89	89	86	80	72

Acoustic characteristics

Sound power spectrum Lw(A) in dB(A) per Hz frequency band
Values measured at inlet with maximum flow rate

	63	125	250	500	1000	2000	4000	8000		63	125	250	500	1000	2000	4000	8000
80-8-5.5 (2V)	38	54	67	74	74	71	65	57	125-4/9-50	65	79	92	100	102	99	94	86
80-6-1.5	53	68	75	78	79	76	70	62	125-4/9-60	73	86	95	99	101	100	96	89
80-12-1.5 (2V)	38	53	60	63	64	61	55	47	125-4/9-75	74	87	96	100	102	101	97	90
80-6-2	59	69	75	79	80	78	73	65	125-4/9-100	76	89	98	102	104	103	99	92
80-12-2 (2V)	43	53	59	63	64	62	57	49	125-4/12-50	66	80	93	101	103	100	95	87
80-6-3	60	70	76	80	81	79	74	66	125-4/12-60	66	80	93	101	103	100	95	87
80-12-3 (2V)	45	55	61	65	66	64	59	51	125-4/12-75	74	87	96	100	102	101	97	90
80-8-0.75	46	59	67	72	74	71	64	53	125-4/12-100	76	89	98	102	104	103	99	92
80-8-1	47	60	68	73	75	72	65	54	125-6/6-5.5	64	79	89	92	93	90	85	77
90-4-4	61	77	88	94	95	93	88	80	125-6/6-7.5	62	77	87	90	91	88	83	75
90-8-4 (2V)	46	62	73	79	80	78	73	65	125-12/6-7.5 (2V)	47	62	72	75	76	73	68	60
90-4-5.5	60	76	87	93	94	92	87	79	125-6/6-10	61	76	86	89	90	87	82	74
90-8-5.5 (2V)	45	61	72	78	79	77	72	64	125-12/6-10 (2V)	46	61	71	74	75	72	67	59
90-4-7.5	59	75	86	92	93	91	86	78	125-6/6-15	61	76	86	89	90	87	82	74
90-8-7.5 (2V)	44	60	71	77	78	76	71	63	125-12/6-15 (2V)	45	60	70	73	74	71	66	58
90-4-10	58	74	85	91	92	90	85	77	125-6/6-20	63	78	88	91	92	89	84	76
90-8-10 (2V)	43	59	70	76	77	75	70	62	125-6/6-24	65	80	90	93	94	91	86	78
90-6-2	52	67	78	82	82	78	71	63	125-12/6-24 (2V)	50	65	75	78	79	76	71	63
90-12-2 (2V)	36	51	62	66	66	62	55	47	125-6/9-10	61	76	87	93	94	88	84	77
90-6-3	52	67	78	82	82	78	71	63	125-12/9-10 (2V)	46	61	72	78	79	73	69	62
90-12-3 (2V)	37	52	63	67	67	63	56	48	125-6/9-15	59	74	85	91	92	86	82	75
90-6-4	60	70	80	85	85	82	76	68	125-12/9-15 (2V)	43	58	69	75	76	70	66	59
90-12-4 (2V)	45	55	65	70	70	67	61	53	125-6/9-20	59	74	85	91	92	86	82	75
90-8-1	42	63	70	75	78	74	67	56	125-6/9-24	60	75	86	92	93	87	83	76
90-8-2	51	66	73	78	81	77	70	59	125-12/9-24 (2V)	45	60	71	77	78	72	68	61
90-8-3	53	67	74	79	82	78	71	60	125-6/9-25	61	76	87	93	94	88	84	77
100-4-7.5	67	83	90	97	98	96	92	84	125-6/9-30	64	79	90	96	97	91	87	80
100-8-7.5 (2V)	52	68	75	82	83	81	77	69	125-6/12-10	63	78	89	95	96	90	86	79
100-4-10	65	81	88	95	96	94	90	82	125-6/12-15	61	76	87	93	94	88	84	77
100-8-10 (2V)	50	66	73	80	81	79	75	67	125-6/12-20	60	75	86	92	93	87	83	76
100-4-15	71	83	87	93	94	94	91	83	125-6/12-25	61	76	87	93	94	88	84	77
100-8-15 (2V)	56	68	72	78	79	79	76	68	125-6/12-30	62	77	88	94	95	89	85	78
100-4-20	72	84	88	94	95	95	92	84	125-6/12-40	63	78	89	95	96	90	86	79
100-8-20 (2V)	57	69	73	79	80	80	77	69	140-6/6-7.5	63	79	91	97	98	96	94	96
100-4/9-15	65	81	88	95	96	94	90	82	140-6/6-15	58	74	86	92	93	91	89	91
100-4/9-20	72	84	88	94	95	95	92	84	140-6/6-20	57	73	85	91	92	90	88	90
100-4/9-25	72	84	88	94	95	95	92	84	140-6/6-25	56	72	84	92	94	89	87	89
100-4/9-30	74	86	90	96	97	97	94	86	140-6/6-30	57	73	85	91	92	90	88	90
100-6-3	57	72	82	85	86	83	75	67	140-6/9-15	64	77	89	97	99	95	91	83
100-12-3 (2V)	42	57	67	70	71	68	60	52	140-6/9-20	63	76	88	96	98	94	90	82
100-6-4	56	71	81	84	85	82	74	66	140-6/9-25	62	75	87	95	97	93	89	81
100-12-4 (2V)	41	56	66	69	70	67	59	51	140-6/9-30	61	74	86	94	96	92	88	80
100-6-5.5	57	72	82	85	86	83	75	67	140-6/9-40	61	74	86	94	96	92	88	80
100-6/9-5.5	57	72	82	85	86	83	75	67	140-6/9-50	52	65	76	85	91	94	98	92
100-6/9-7.5	58	73	83	86	87	84	76	68	140-6/9-60	54	67	78	87	93	96	100	94
100-6/9-10	61	76	86	89	90	87	79	71	140-6/12-30	63	76	88	96	98	94	90	82
125-4/6-20	69	85	96	103	104	102	95	87	140-6/12-40	62	75	87	95	97	93	89	81
125-8/6-20 (2V)	54	70	81	88	89	87	80	72	140-6/12-50	53	66	77	86	92	95	99	93
125-4/6-25	68	84	95	102	103	101	94	86	140-6/12-60	54	67	78	87	93	96	100	94
125-4/6-27	67	83	94	101	102	100	93	85	140-6/12-75	55	68	79	88	94	97	101	95
125-8/6-27 (2V)	52	68	79	86	87	85	78	70	160-6/6-20	67	83	92	99	100	98	97	97
125-4/6-30	67	83	94	101	102	100	93	85	160-6/6-25	66	82	91	98	99	97	96	96
125-4/6-37	67	83	94	101	102	100	93	85	160-6/6-30	66	82	91	98	99	96	96	96
125-8/6-37 (2V)	52	68	79	86	87	85	78	70	160-6/6-40	64	80	89	96	97	95	94	94
125-4/6-40	67	83	94	101	102	100	93	85	160-6/6-50	64	80	89	96	97	94	94	94
125-4/6-50	67	83	94	101	102	100	93	85	160-6/6-60	64	80	89	96	97	95	94	94
125-4/6-60	67	83	94	101	102	100	93	85	160-6/6-75	56	69	78	86	92	97	100	100
125-4/6-75	70	86	97	104	105	103	96	88	160-6/9-25	75	88	97	105	107	105	100	91
125-4/9-25	67	81	94	102	104	101	96	88	160-6/9-30	73	86	95	103	105	103	98	89
125-4/9-30	66	80	93	101	103	100	95	87	160-6/9-40	71	84	93	101	103	101	96	87
125-4/9-27	51	65	78	86	88	85	80	72	160-6/9-50	70	83	92	100	102	100	95	86
125-8/9-27 (2V)	66	80	93	101	103	100	95	87	160-6/9-60	70	83	92	100	102	100	95	86
125-4/9-37	65	79	92	100	102	99	94	86	160-6/9-75	59	72	80	87	88	100	103	96
125-8/9-37 (2V)	50	64	77	85	87	84	79	71	160-6/12-60	71	84	93	101	103	101	96	87
125-4/9-40	65	79	92	100	102	99	94	86	160-6/12-75	60	73	81	88	89	101	104	97

Dimensions mm

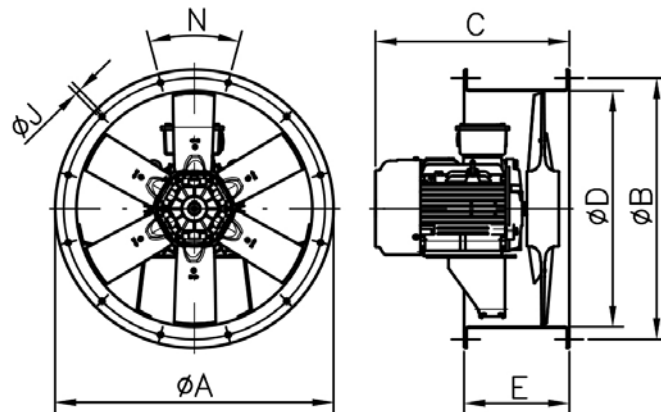

Motor size	ØA	ØB	C	ØD	E	ØJ	N
THT-40 80	490	450	356	410	250	12	8x45°
THT-40 90S	490	450	398.5	410	250	12	8x45°
THT-40 90L	490	450	429	410	250	12	8x45°
THT-45 80	540	500	356	460	250	12	8x45°
THT-45 90S	540	500	398.5	460	250	12	8x45°
THT-45 90L	540	500	429	460	250	12	8x45°
THT-45 100	540	500	435	460	250	12	8x45°
THT-50 80	600	560	356	514	250	12	12x30°
THT-50 90S	600	560	398.5	514	250	12	12x30°
THT-50 90L	600	560	429	514	250	12	12x30°
THT-50 100	600	560	435	514	250	12	12x30°
THT-50 112	600	560	456.5	514	250	12	12x30°
THT-56 80	660	620	356	560	250	12	12x30°
THT-56 90S	660	620	398.5	560	250	12	12x30°
THT-56 90L	660	620	429	560	250	12	12x30°
THT-56 100	660	620	432	560	250	12	12x30°
THT-56 112	660	620	460.5	560	250	12	12x30°
THT-56 132S	660	620	495	560	250	12	12x30°
THT-56 132M	660	620	533	560	250	12	12x30°
THT-63 80	730	690	356	640	250	12	12x30°
THT-63 90S	730	690	398.5	640	250	12	12x30°
THT-63 90L	730	690	429	640	250	12	12x30°
THT-63 100	730	690	432	640	250	12	12x30°
THT-63 112	730	690	455.5	640	250	12	12x30°
THT-63 132S	730	690	523	640	250	12	12x30°
THT-63 132M	730	690	561	640	250	12	12x30°
THT-63 160M	730	690	660	640	350	12	12x30°
THT-63 160L	730	690	704	640	350	12	12x30°
THT-71 80	810	770	363	710	300	12	16x22°30'
THT-71 90S	810	770	398.5	710	300	12	16x22°30'
THT-71 90L	810	770	429	710	300	12	16x22°30'
THT-71 100	810	770	434	710	300	12	16x22°30'
THT-71 112	810	770	452.5	710	300	12	16x22°30'
THT-80 90L	900	860	426.5	800	300	12	16x22°30'
THT-80 100	900	860	462	800	300	12	16x22°30'
THT-80 112	900	860	480.5	800	300	12	16x22°30'
THT-80 132S	900	860	516	800	300	12	16x22°30'

Motor size	ØA	ØB	C	ØD	E	ØJ	N
THT-90 100	1015	970	472	900	350	15	16x22°30'
THT-90 112	1015	970	500.5	900	350	15	16x22°30'
THT-90 132S	1015	970	526	900	350	15	16x22°30'
THT-90 132M	1015	970	564	900	350	15	16x22°30'
THT-100 112	1115	1070	490.5	1000	450	15	16x22°30'
THT-100 132S	1115	1070	526	1000	450	15	16x22°30'
THT-100 132M	1115	1070	564	1000	450	15	16x22°30'
THT-100 160M	1115	1070	658	1000	450	15	16x22°30'
THT-100 160L	1115	1070	702	1000	450	15	16x22°30'
THT-100 180M	1115	1070	711	1000	450	15	16x22°30'
THT-100 180L	1115	1070	749	1000	450	15	16x22°30'
THT-125 132M	1365	1320	603.5	1250	500	15	20x18°
THT-125 160M	1365	1320	660	1250	500	15	20x18°
THT-125 160L	1365	1320	704	1250	500	15	20x18°
THT-125 180M	1365	1320	715	1250	500	15	20x18°
THT-125 180L	1365	1320	753	1250	500	15	20x18°
THT-125 200	1365	1320	824.5	1250	500	15	20x18°
THT-125 225	1365	1320	881	1250	500	15	20x18°
THT-125 250	1365	1320	1025.5	1250	700	15	20x18°
THT-125 280	1365	1320	1129.6	1250	900	15	20x18°
THT-140 132S	1515	1470	537	1400	400	15	20x18°
THT-140 132M	1515	1470	575	1400	400	15	20x18°
THT-140 160L	1515	1470	704	1400	450	15	20x18°
THT-140 180L	1515	1470	762	1400	550	15	20x18°
THT-140 200	1515	1470	824.5	1400	550	15	20x18°
THT-140 225	1515	1470	881	1400	550	15	20x18°
THT-140 250	1515	1470	1025.5	1400	600	15	20x18°
THT-140 280	1515	1470	1110	1400	700	15	20x18°
THT-160 132S	1735	1680	537	1600	400	19	24x15°
THT-160 132M	1735	1680	575	1600	400	19	24x15°
THT-160 160L	1735	1680	704	1600	450	19	24x15°
THT-160 180L	1735	1680	762	1600	550	19	24x15°
THT-160 200	1735	1680	824.5	1600	550	19	24x15°
THT-160 225	1735	1680	881	1600	550	19	24x15°
THT-160 250	1735	1680	1025.5	1600	600	19	24x15°
THT-160 280	1735	1680	1110	1600	700	19	24x15°

Motor build sizes depending on power (1 speed)

	HP											
	0.75	1	1.5	2	3	4	5.5	7.5	10	12	15	20
2T (3000 r/min)	80	80	80	90S	90L	100LB	112M	132S	132S	132MA	160M	160M
4T (1500 r/min)	80	90S	90S	90L	100LA	100LB	112M	132S	132M	-	160ML	160L
6T (1000 r/min)	90S	90S	90L	100L	112M	132S	132MA	132MB	160M	-	160L	180ML
8T (750 r/min)	90L	100LA	100L	112M	132S	132M	160MA	160M	160L	-	180L	200MLA

	HP							
	22	25	30	40	50	60	75	100
2T (3000 r/min)	160L	180M	180L	200L	225S/M	225S/M	250S/M	280S/M
4T (1500 r/min)	-	180M	180L	200L	225S/M	225S/M	250S/M	280S/M
6T (1000 r/min)	-	200MLA	200MLB	225SMB	250S/M	280S/M	280S/M	-
8T (750 r/min)	-	225SMA	225SMB	250SMA	280S/M	280S/M	-	-

Motor build sizes depending on power (2 speeds)

	HP											
	0.75	1	1.5	2	3	4	5.5	6	7.5	8	9	10
2/4 (3000/1500 r/min)	-	-	90S	90S	90L	100L	-	112M	-	-	132M	-
4/8 (1500/750 r/min)	-	-	90S	100L	100LA	100LC	132S	-	132S	132S	132ML	132M
6/12 (1000/500 r/min)	90L	100L	100LB	112M	112M	132MC	160M	160M	160LB	160LB	-	160LB

	HP									
	12	15	18	20	22	24	27	37	38	40
2/4 (3000/1500 r/min)	160MA	-	160M	-	160L	-	-	-	-	-
4/8 (1500/750 r/min)	-	160M	-	160L	180M	180M	180L	200MLA	200L	225S/M
6/12 (1000/500 r/min)	-	200MLC	160L	200M	-	250SMB	225S/M	-	225S/M	-

Accessories



Configuration with BOXPARK



Control panels for car park ventilation systems with triple purpose: daily ventilation, CO concentration control and smoke extraction in case of fire

Control panels in metal enclosure with all the necessary elements for the management and control of fans in car park ventilation systems, whether they are based on duct networks or impulse fans, for the control of CO concentration levels and smoke extraction in case of fire. Customised panels for all power ratings and number of fans according to project requirements.

More information see BOXPARK series.

Installation examples with BOXPARK

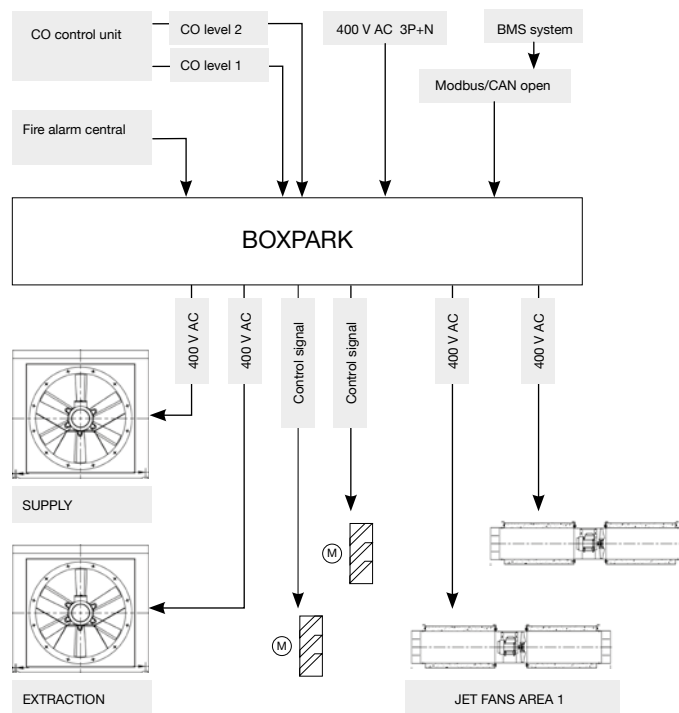

EXAMPLE OF SELECTION

Characteristic curves

Q= Flow rate in m³/h, m³/s and cfm

Pe= Static pressure in mm H₂O, Pa and inwg

Impeller diameter in cm: 71

Number of motor poles: 6

Number of blades: 6

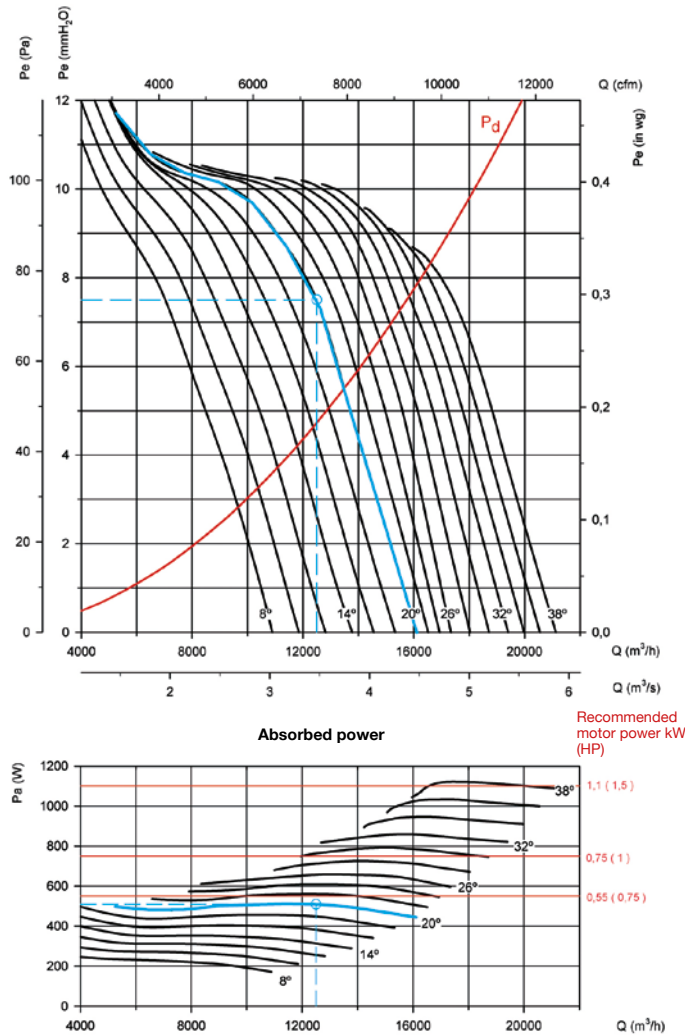

Initial data

Working point:

- Flow rate: 12,500 m³/h
- Loss of load: 7.5 mmH₂O

Steps for the selection of equipment

On the pressure graph:

- Mark the working point, defined by the airflow (12,500 m³/h) and the loss of load (7.5 mmH₂O).
- Select the curve of the equipment which is closest above the working point. In our case, a curve with a blade angle of 20° is obtained.

On the power graph:

- Mark the working point, defined by the airflow (12,500 m³/h) and the selected blade angle (20°).
- Read the absorbed power on the power axis on the left. Pa= 510 W at the working point.
- Look for the straight red line which is closest to the working point above. On the right-hand side of the graph, the value of the installed motor power is obtained. In our case, this is 0.55 kW or 0.75 HP.

EXAMPLE OF ORDER CODE

THT	-	71	-	6T	-	0.75	-	F400
Name of series: THT		Impeller diameter in cm		Number of motor poles 2=3000 r/min 50 Hz 4=1500 r/min 50 Hz 6=1000 r/min 50 Hz 8=750 r/min 50 Hz 12=500 r/min 50 Hz	T = Three-phase	Motor power (HP)		F300: 300 °C/2h approved F400: 400 °C/2h approved

Characteristic curves

Q= Flow rate in m³/h, m³/s and cfm

Pe= Static pressure in mm H₂O, Pa and inwg

Impeller diameter in cm: 40

Number of motor poles: 2

Number of blades: 6

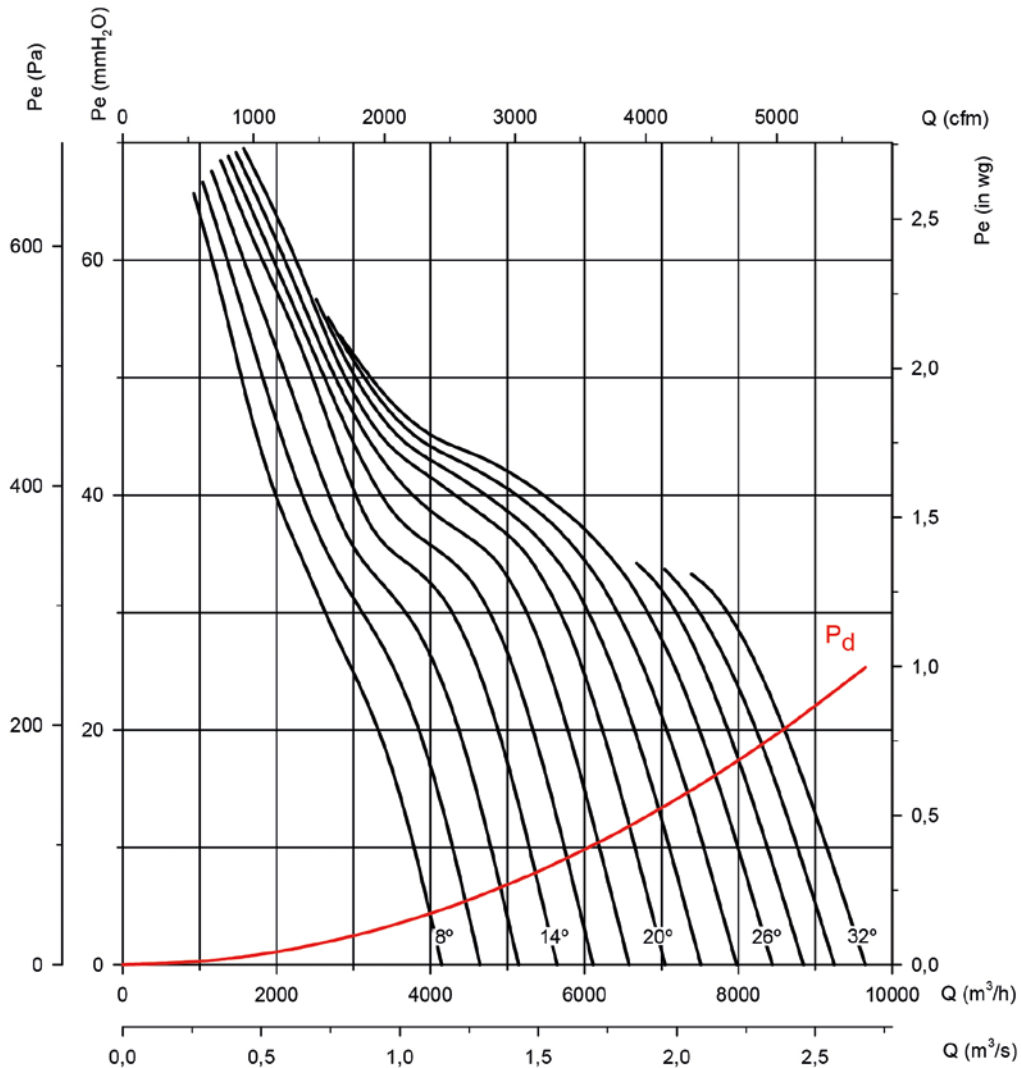

Absorbed power

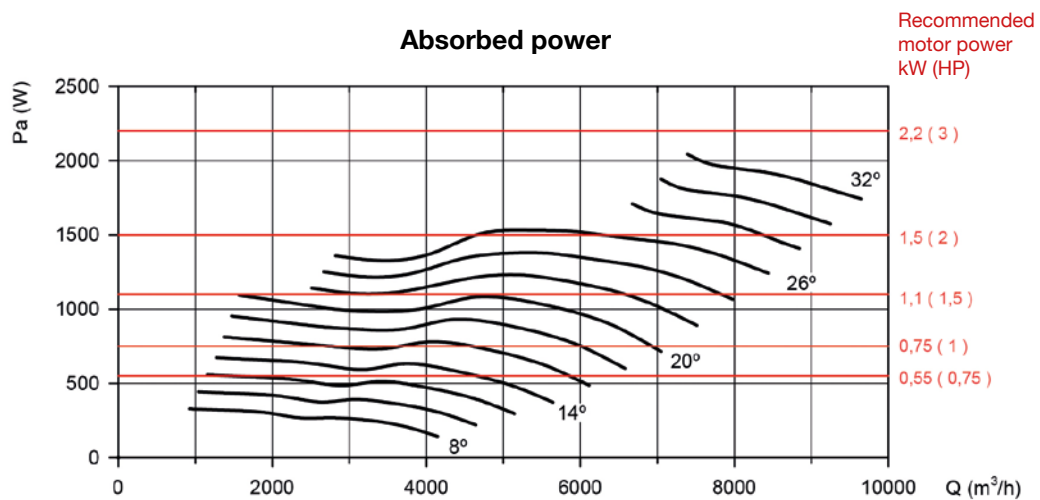

Characteristic curves

Q= Flow rate in m³/h, m³/s and cfm Pe= Static pressure in mm H₂O, Pa and inwg

Impeller diameter in cm: 40

Number of motor poles: 4

Number of blades: 6

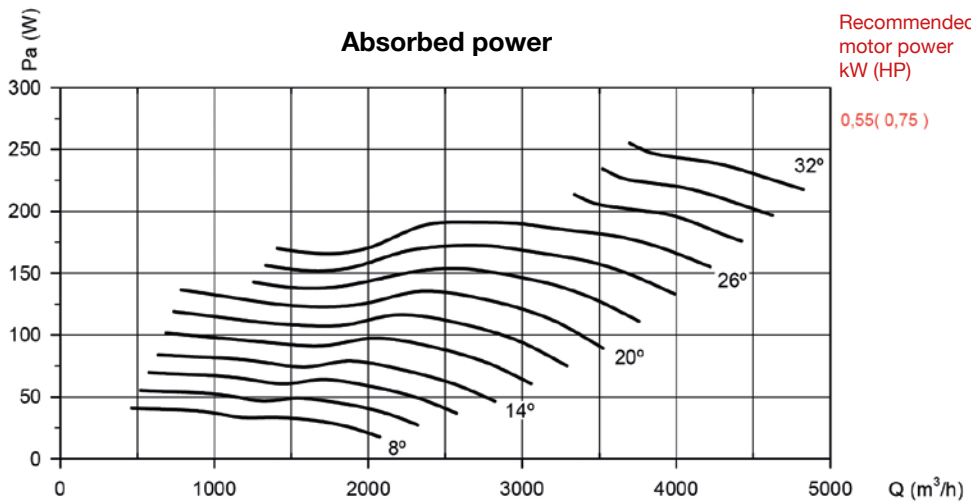
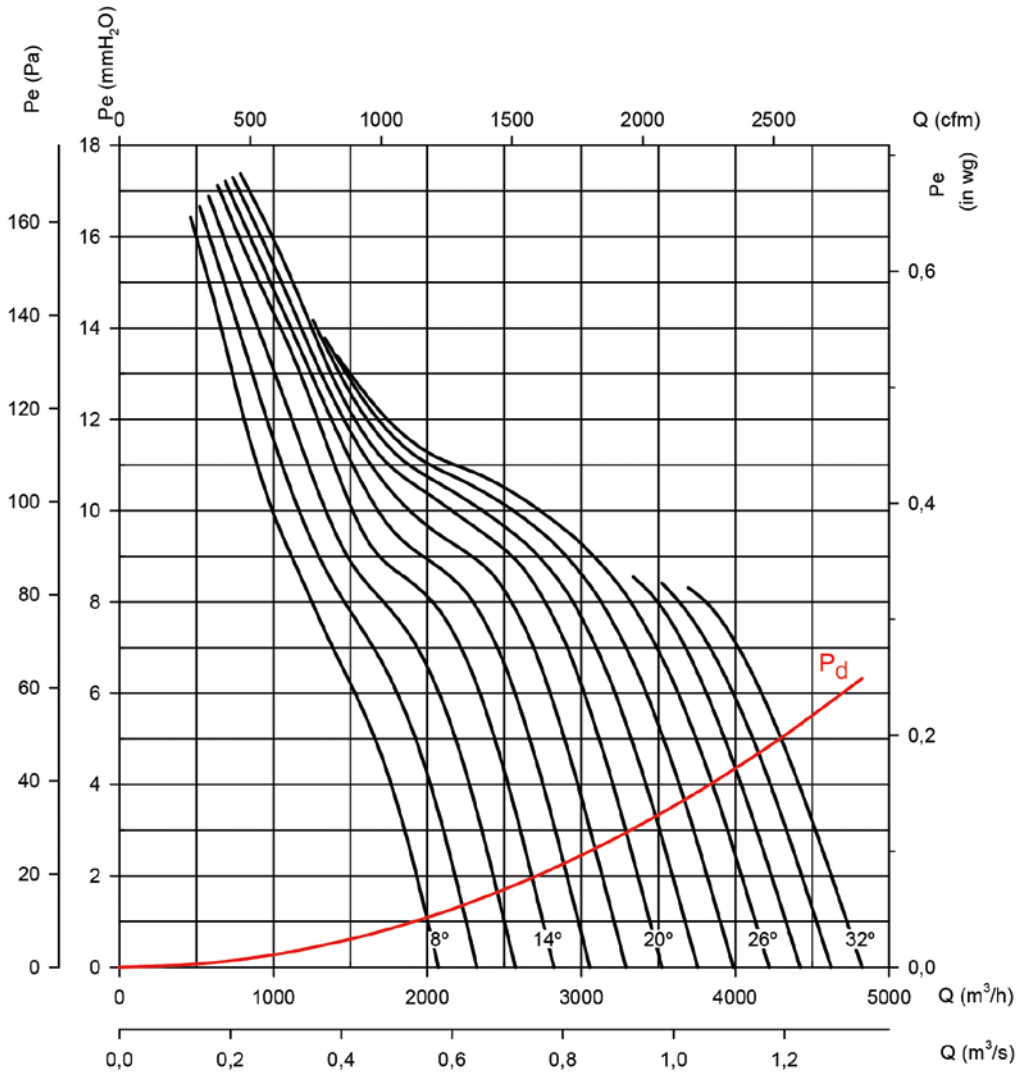

Characteristic curves

Q= Flow rate in m³/h, m³/s and cfm

Pe= Static pressure in mm H₂O, Pa and inwg

Impeller diameter in cm: 40

Number of motor poles: 6

Number of blades: 6

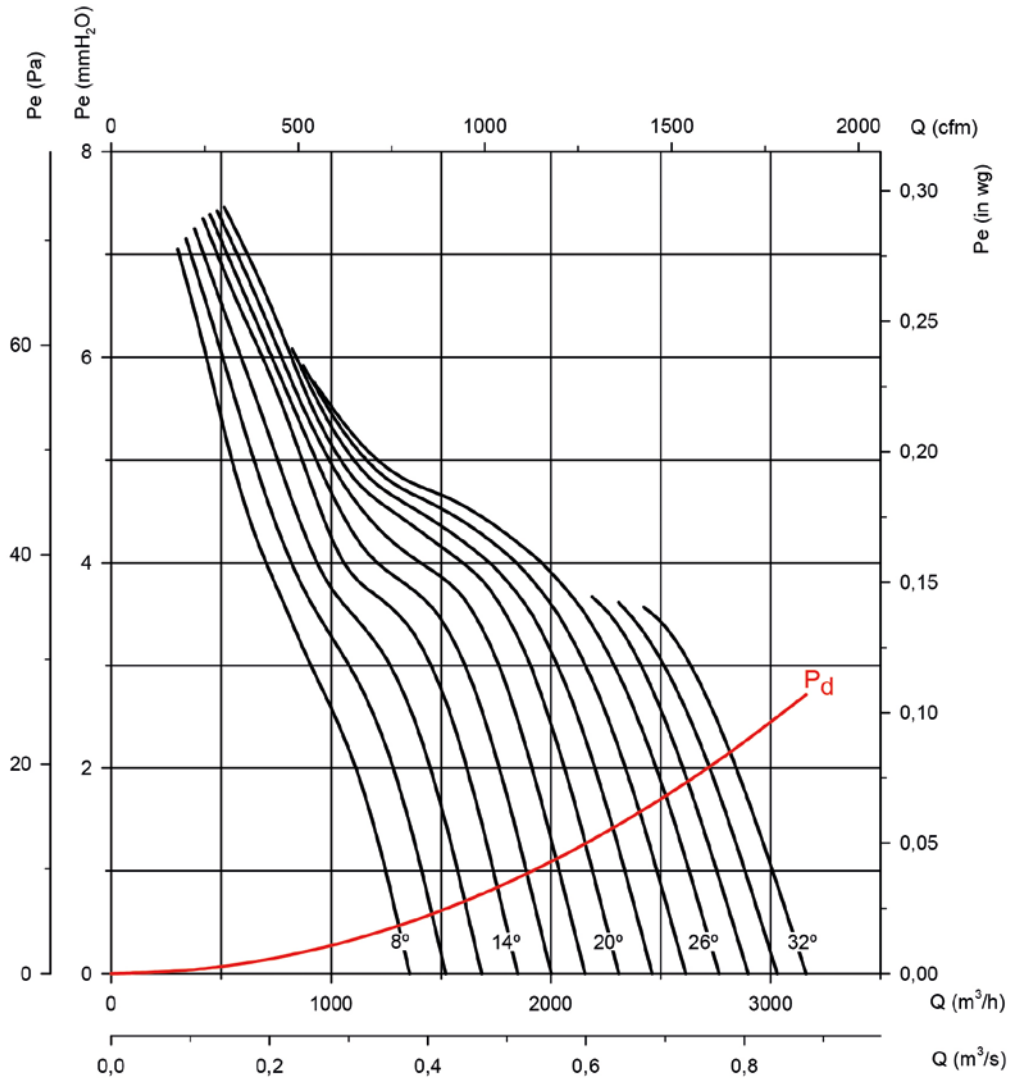

Absorbed power

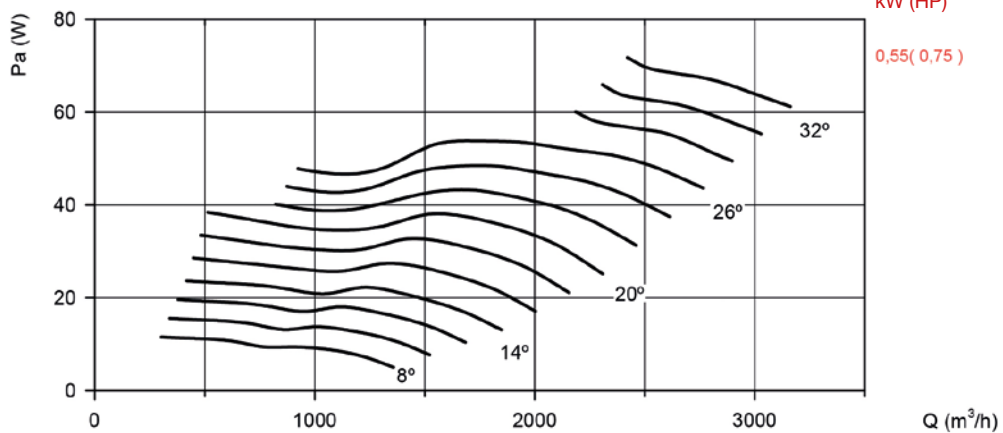

Recommended motor power kW (HP)

0,55 (0,75)

Characteristic curves

Q= Flow rate in m³/h, m³/s and cfm

Pe= Static pressure in mm H₂O, Pa and inwg

Impeller diameter in cm: 45

Number of motor poles: 2

Number of blades: 6

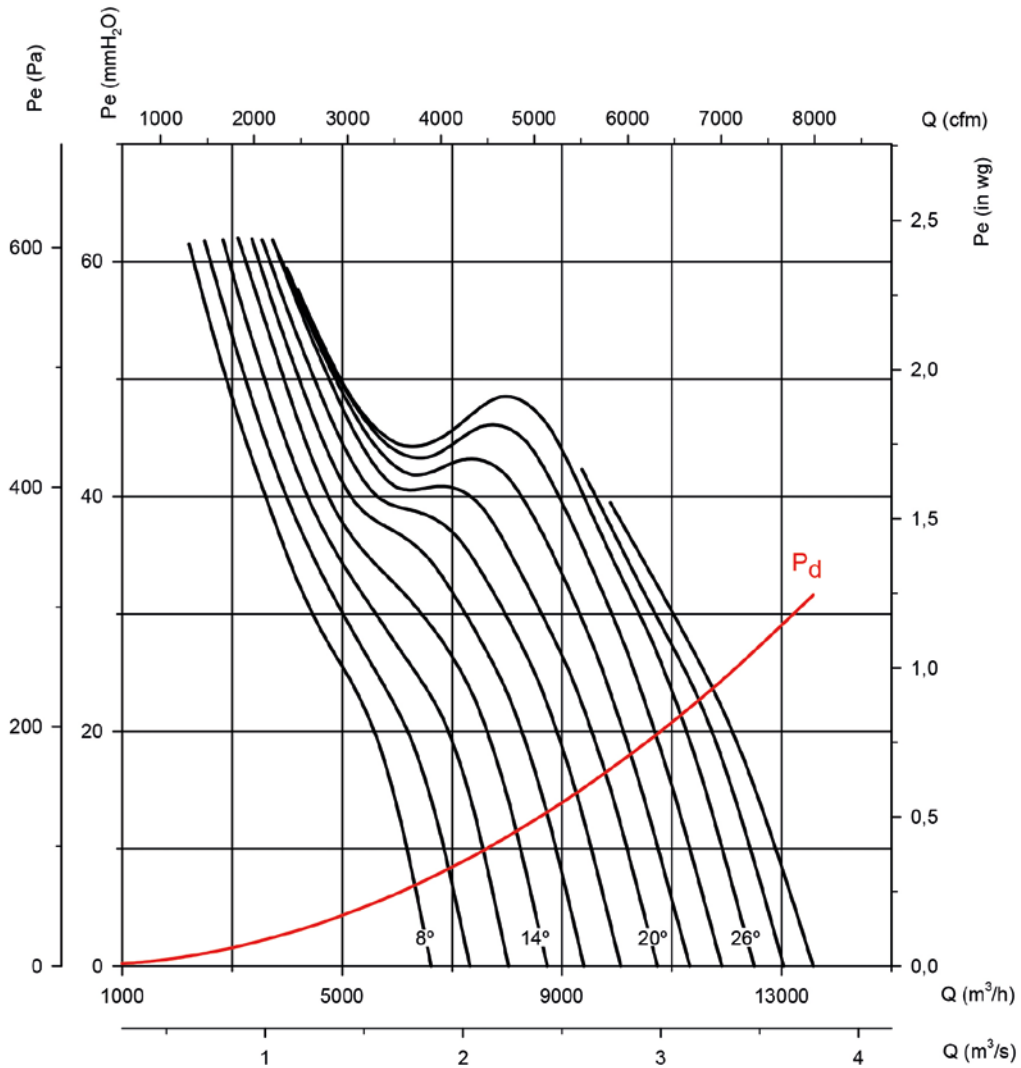

Absorbed power

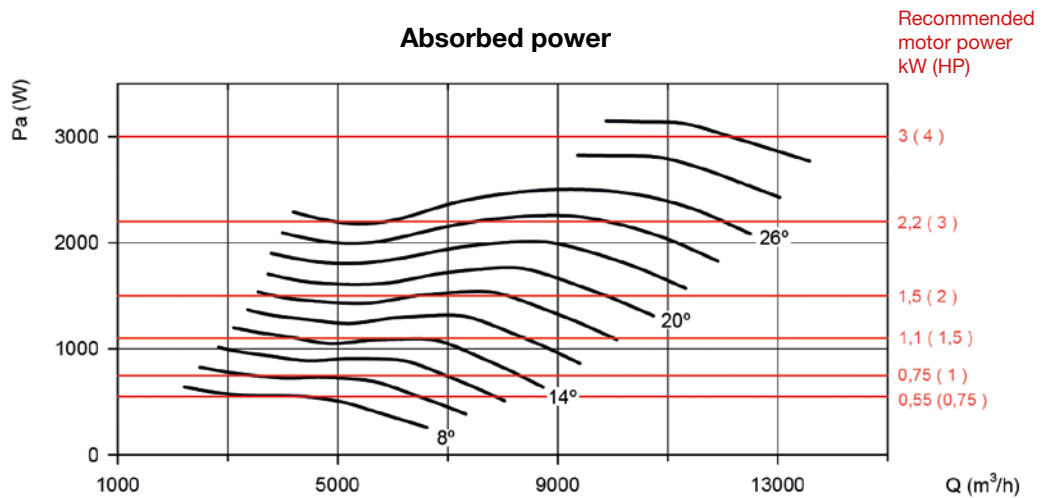

Characteristic curves

Q= Flow rate in m³/h, m³/s and cfm

Pe= Static pressure in mm H₂O, Pa and inwg

Impeller diameter in cm: 45

Number of motor poles: 4

Number of blades: 6

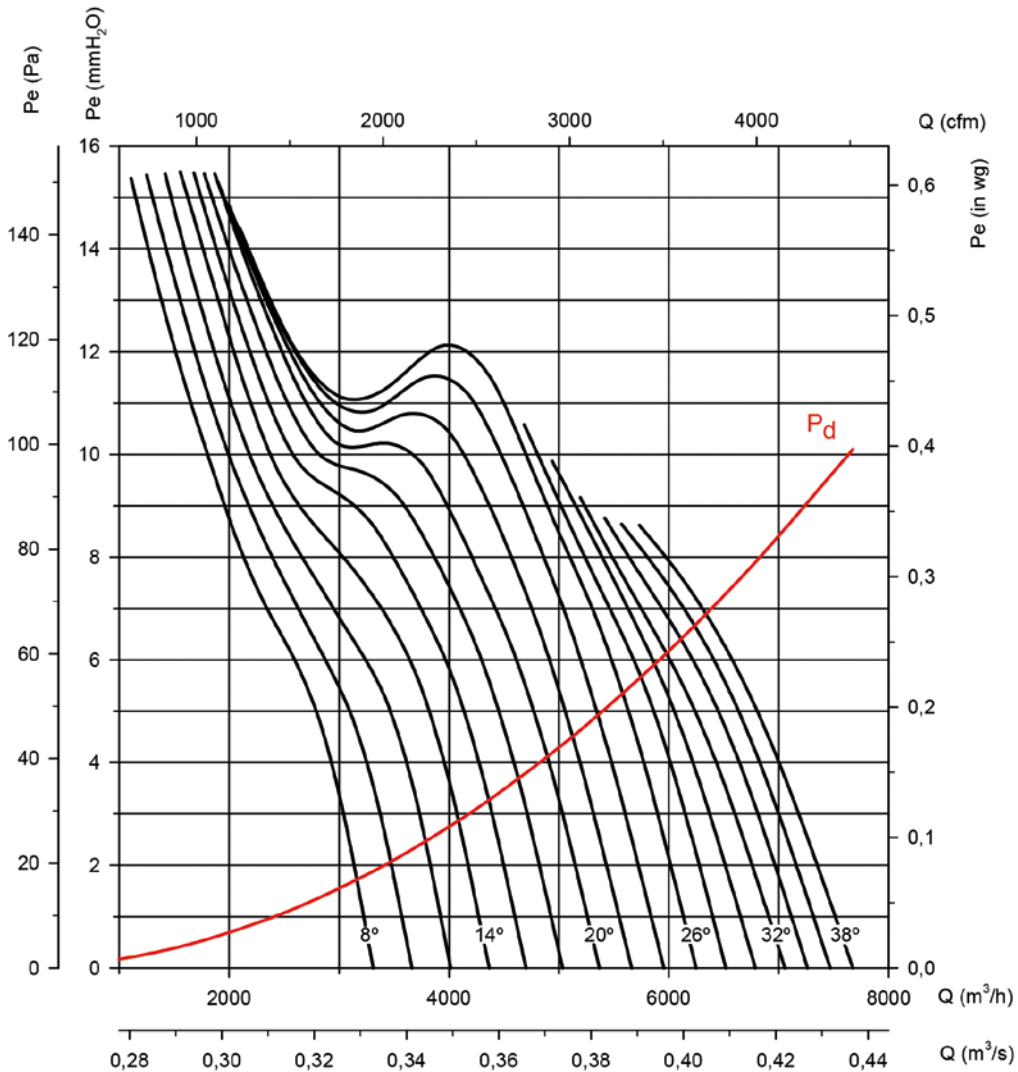

Absorbed power

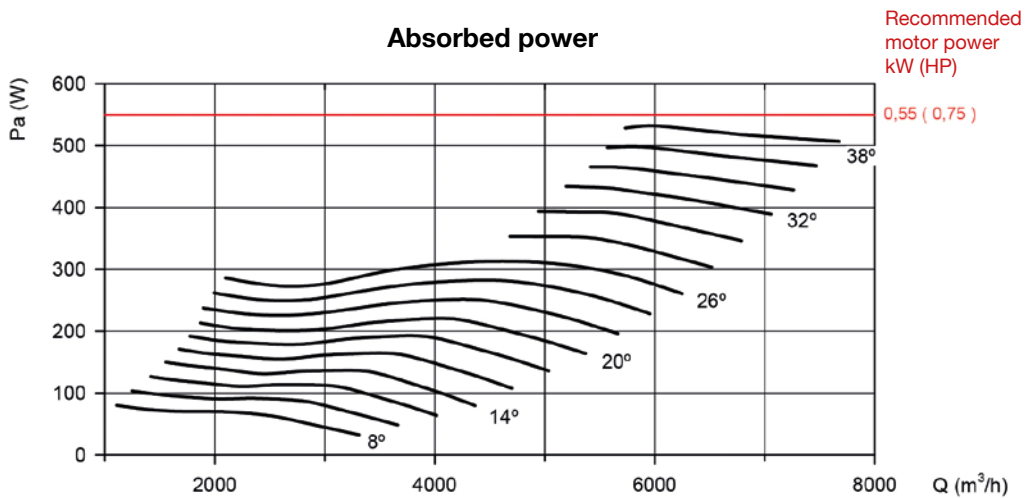

Characteristic curves

Q= Flow rate in m³/h, m³/s and cfm Pe= Static pressure in mm H₂O, Pa and inwg

Impeller diameter in cm: 45

Number of motor poles: 6

Number of blades: 6

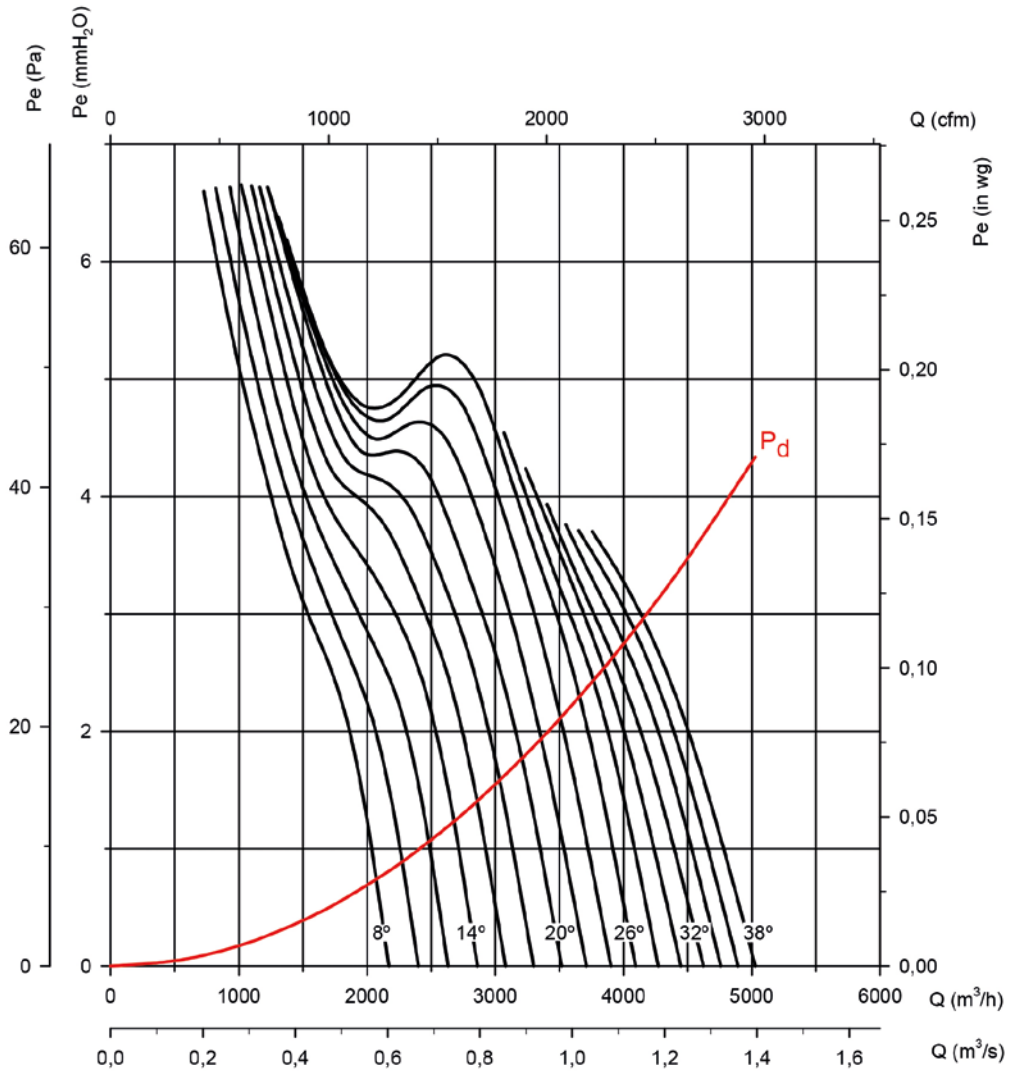

Absorbed power

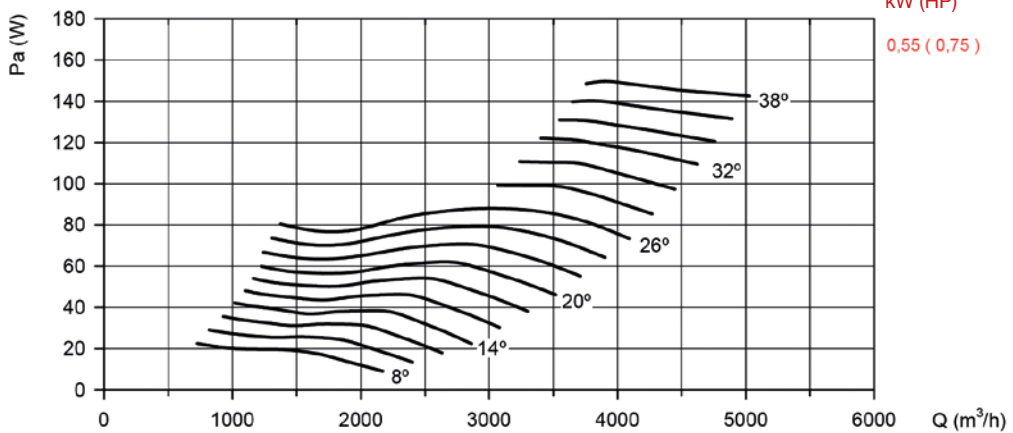

Characteristic curves

Q= Flow rate in m³/h, m³/s and cfm Pe= Static pressure in mm H₂O, Pa and inwg

Impeller diameter in cm: 50

Number of motor poles: 2

Number of blades: 6

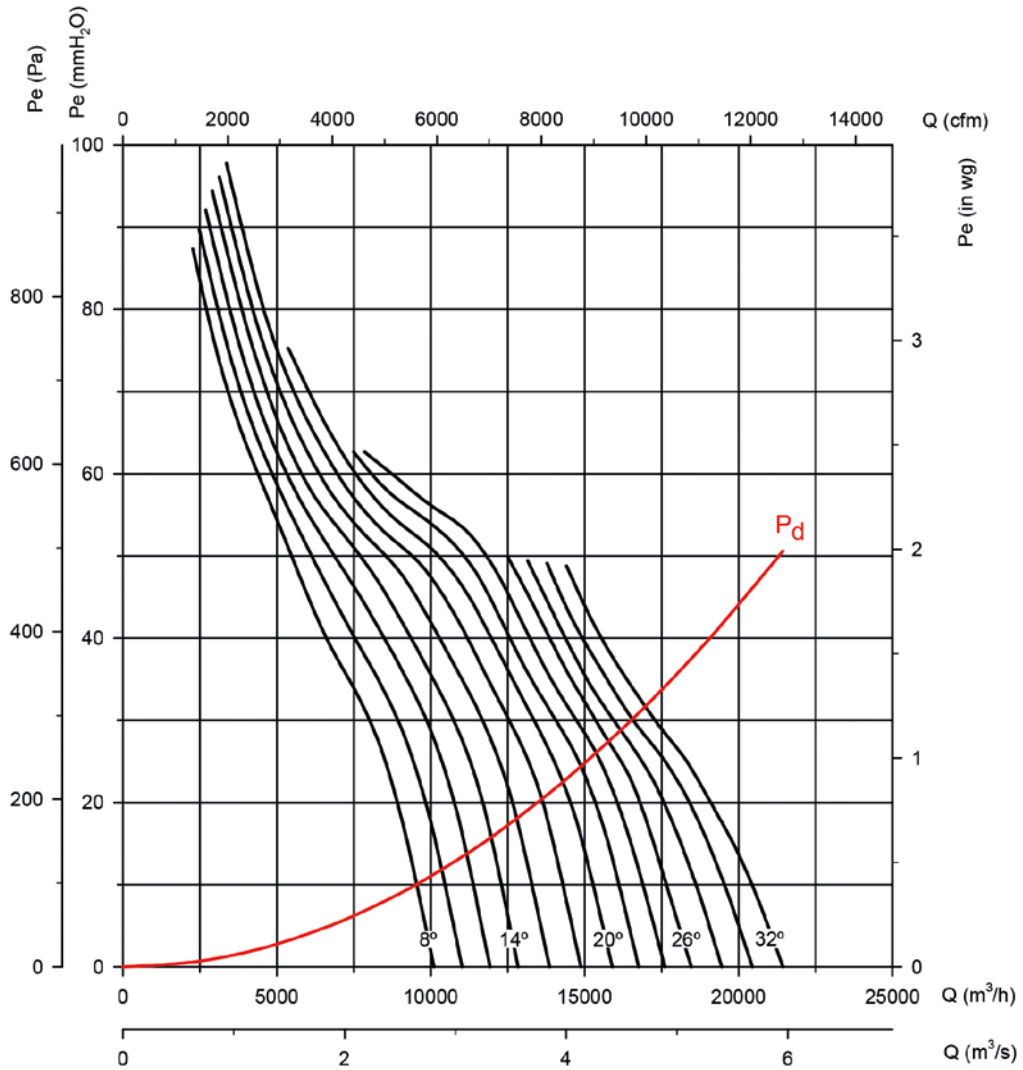

Absorbed power

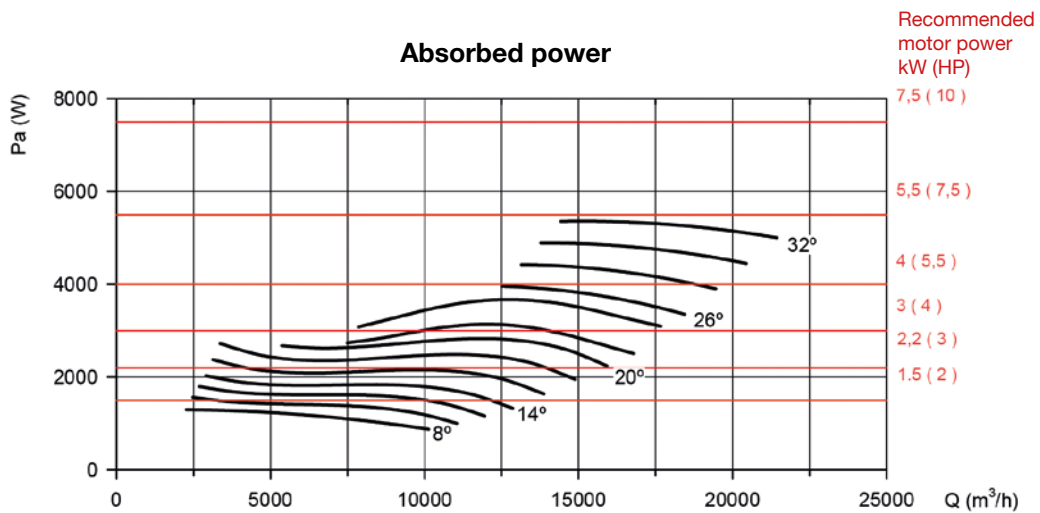

Characteristic curves

Q= Flow rate in m³/h, m³/s and cfm Pe= Static pressure in mm H₂O, Pa and inwg

Impeller diameter in cm: 50

Number of motor poles: 4

Number of blades: 6

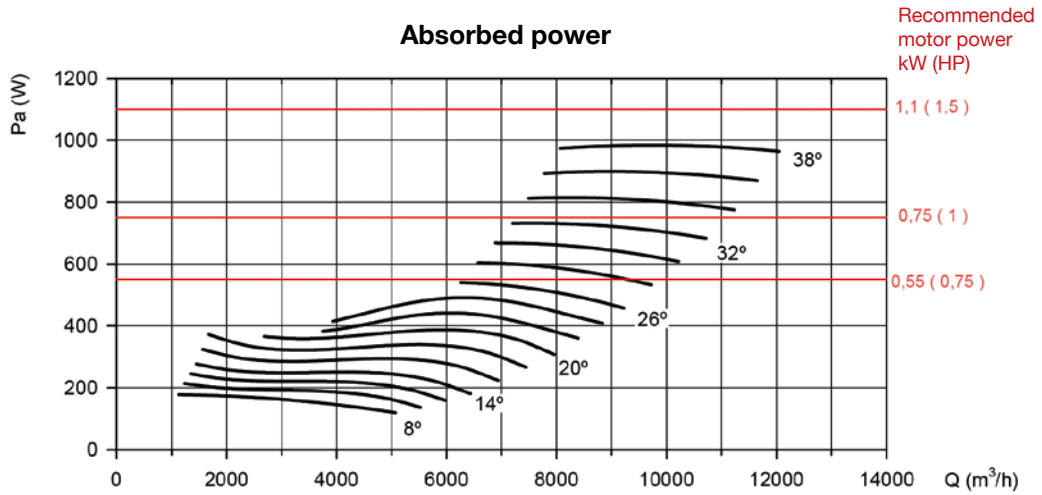
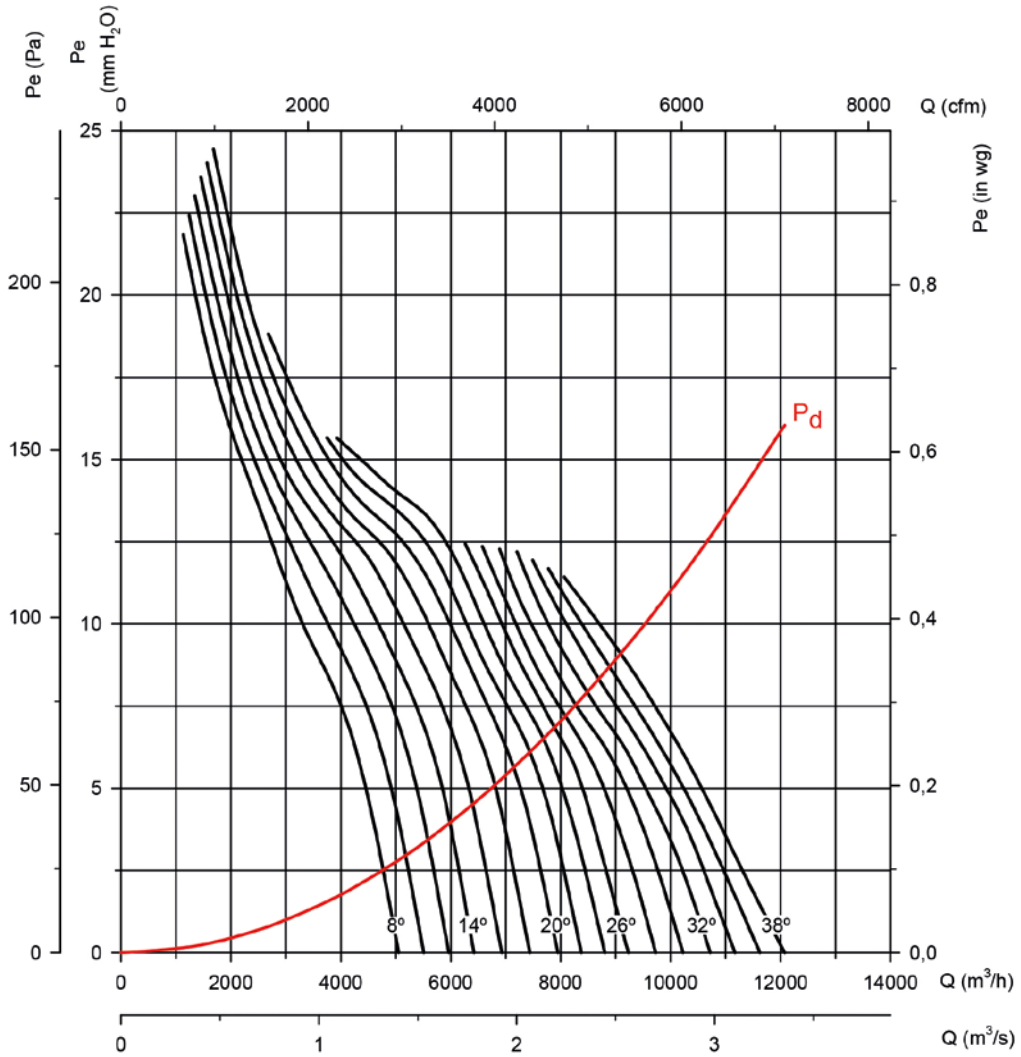

Characteristic curves

Q= Flow rate in m³/h, m³/s and cfm

Pe= Static pressure in mm H₂O, Pa and inwg

Impeller diameter in cm: 50

Number of motor poles: 6

Number of blades: 6

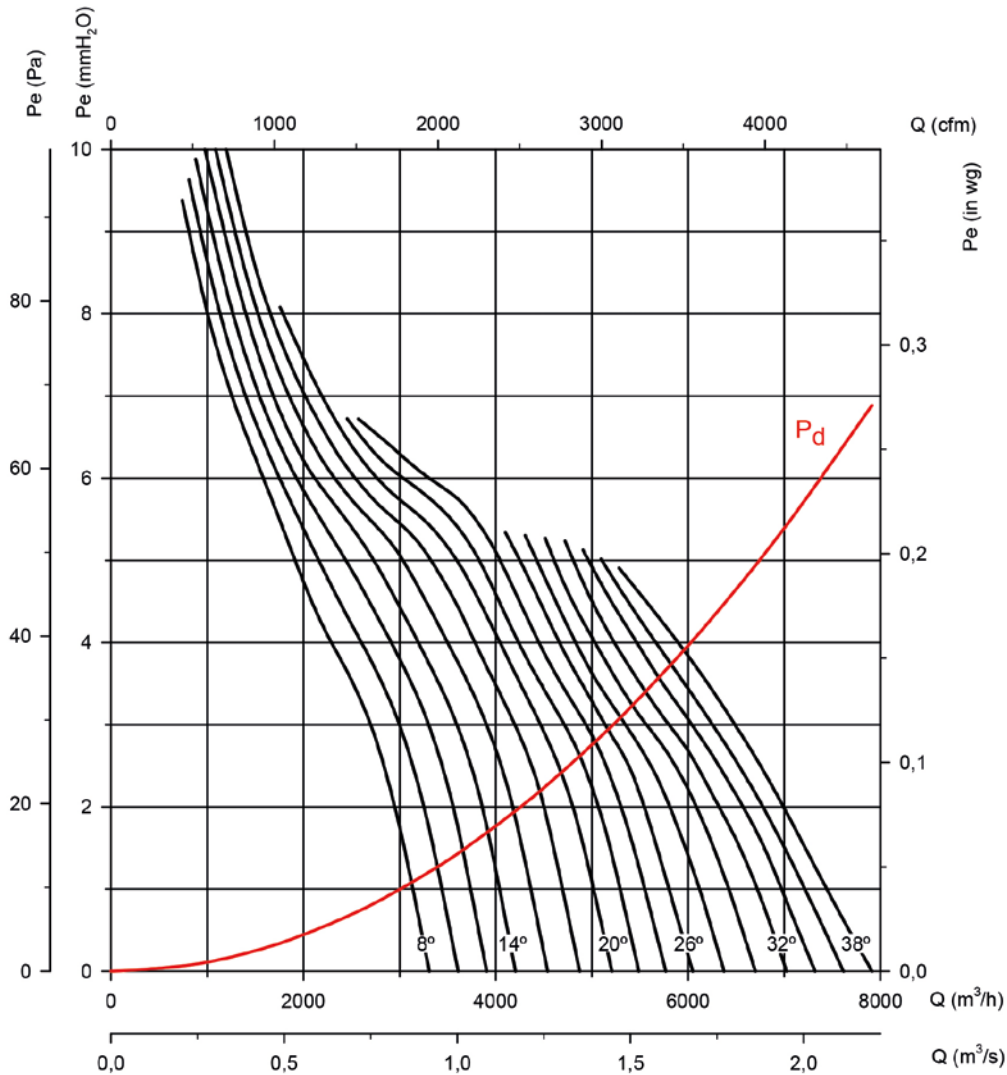

Absorbed power

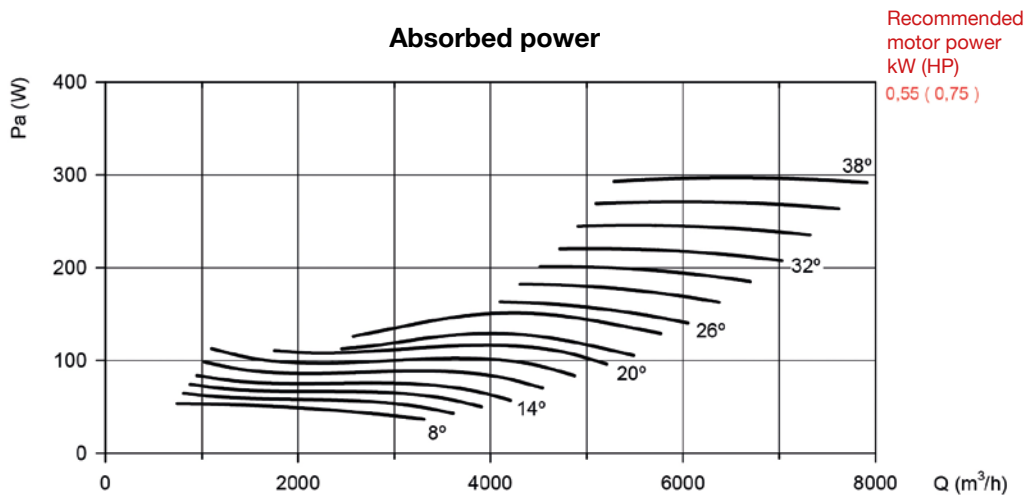

Characteristic curves

Q= Flow rate in m³/h, m³/s and cfm Pe= Static pressure in mm H₂O, Pa and inwg

Impeller diameter in cm: 56

Number of motor poles: 2

Number of blades: 6

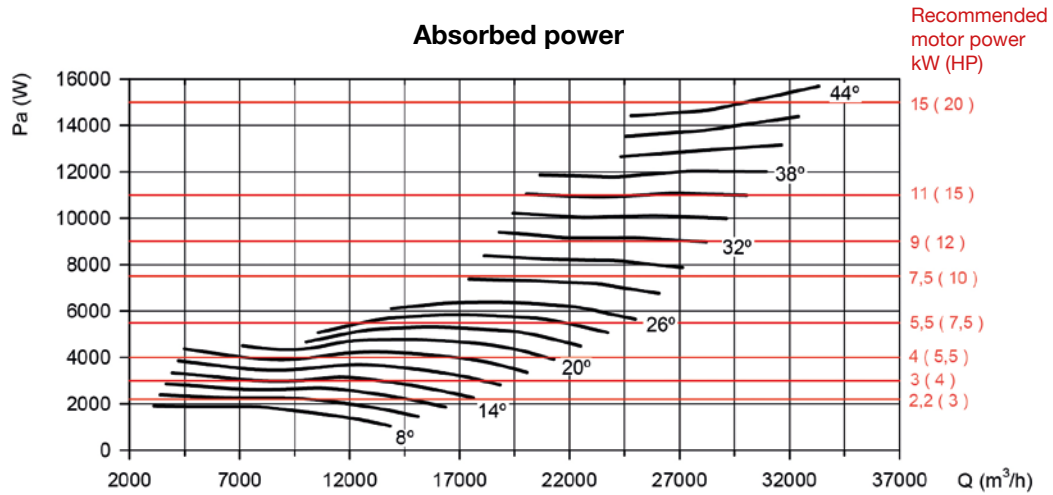
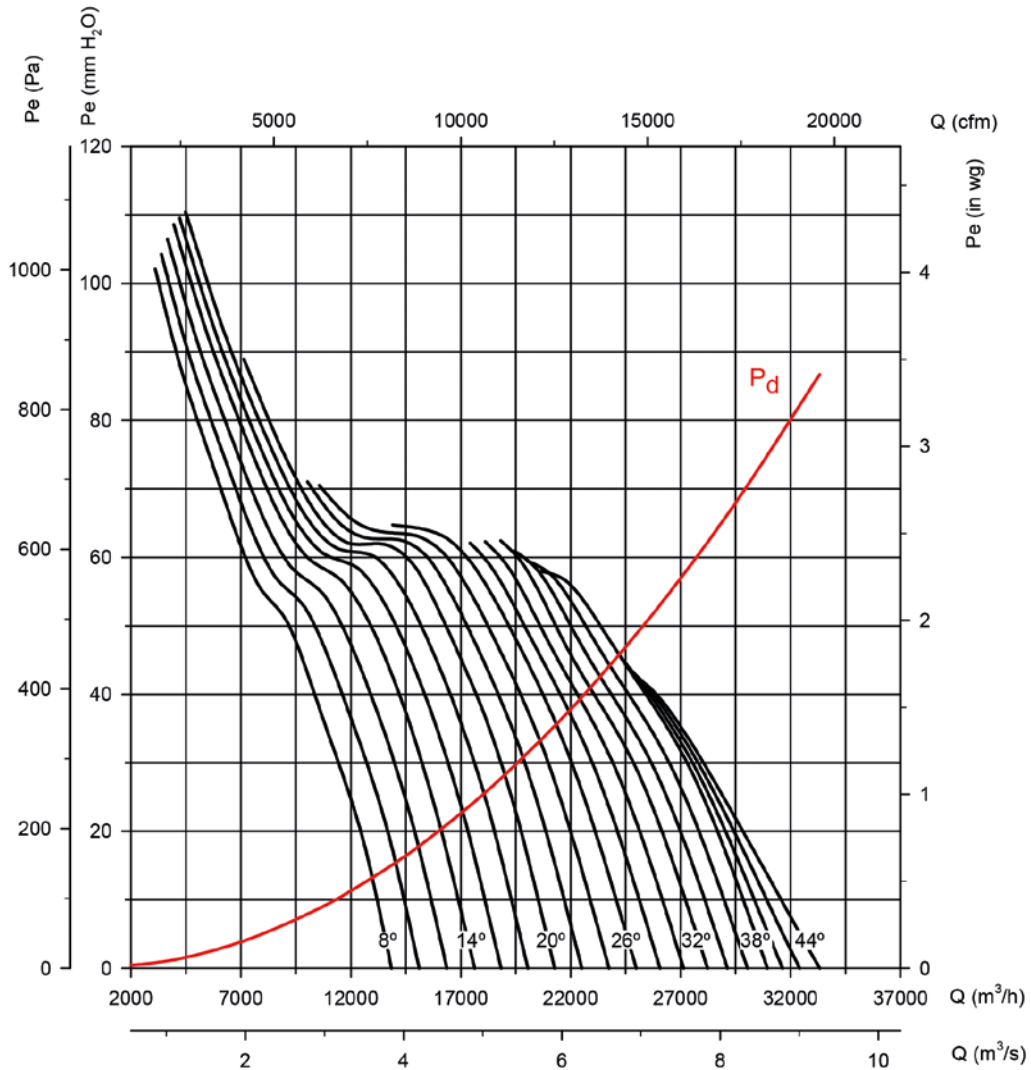

Characteristic curves

Q= Flow rate in m³/h, m³/s and cfm

Pe= Static pressure in mm H₂O, Pa and inwg

Impeller diameter in cm: 56

Number of motor poles: 4

Number of blades: 6

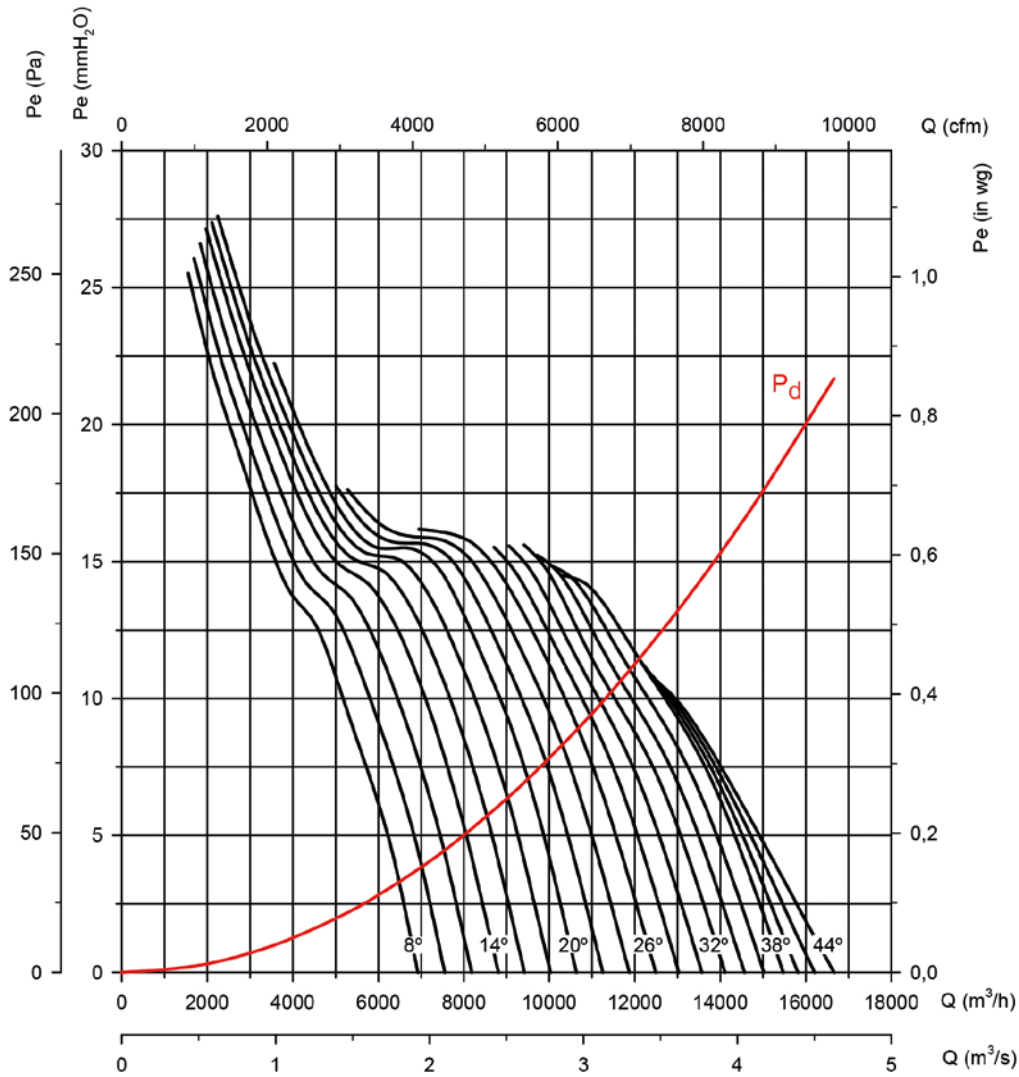

Absorbed power

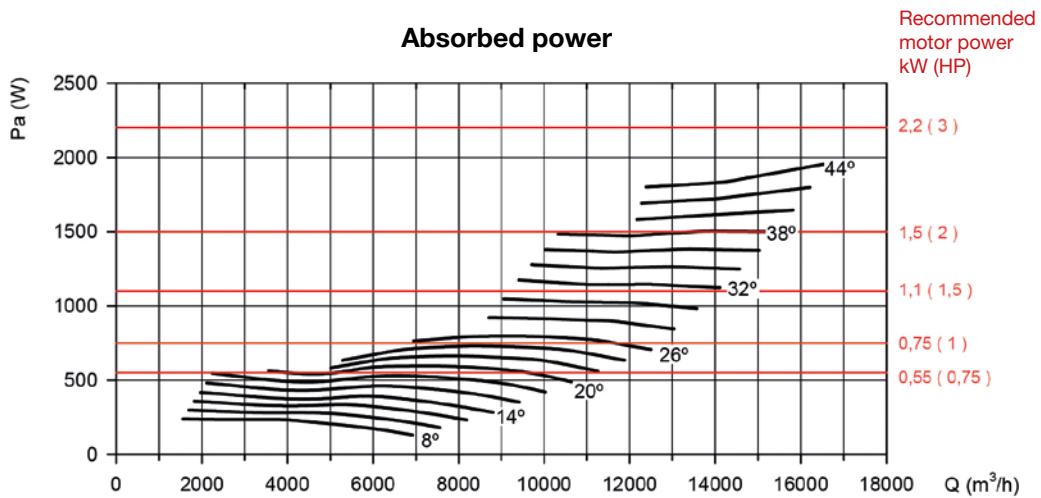

Characteristic curves

Q= Flow rate in m³/h, m³/s and cfm Pe= Static pressure in mm H₂O, Pa and inwg

Impeller diameter in cm: 56

Number of motor poles: 6

Number of blades: 6

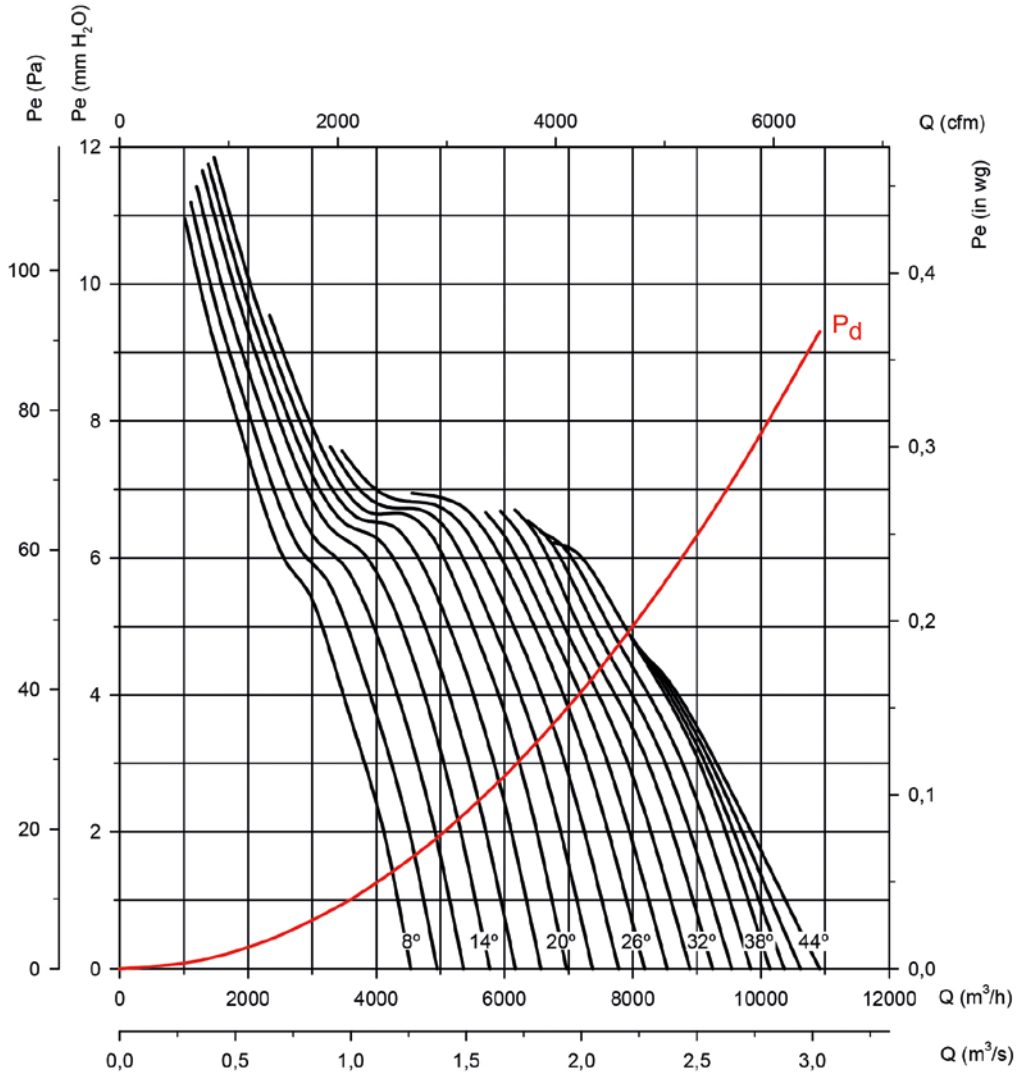

Absorbed power

Recommended motor power kW (HP)

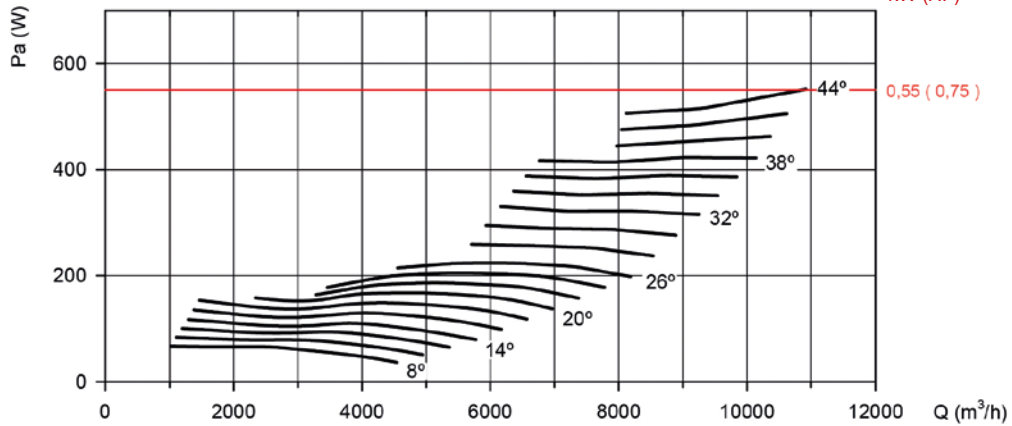

Characteristic curves

Q= Flow rate in m³/h, m³/s and cfm

Pe= Static pressure in mm H₂O, Pa and inwg

Impeller diameter in cm: 63

Number of motor poles: 2

Number of blades: 6

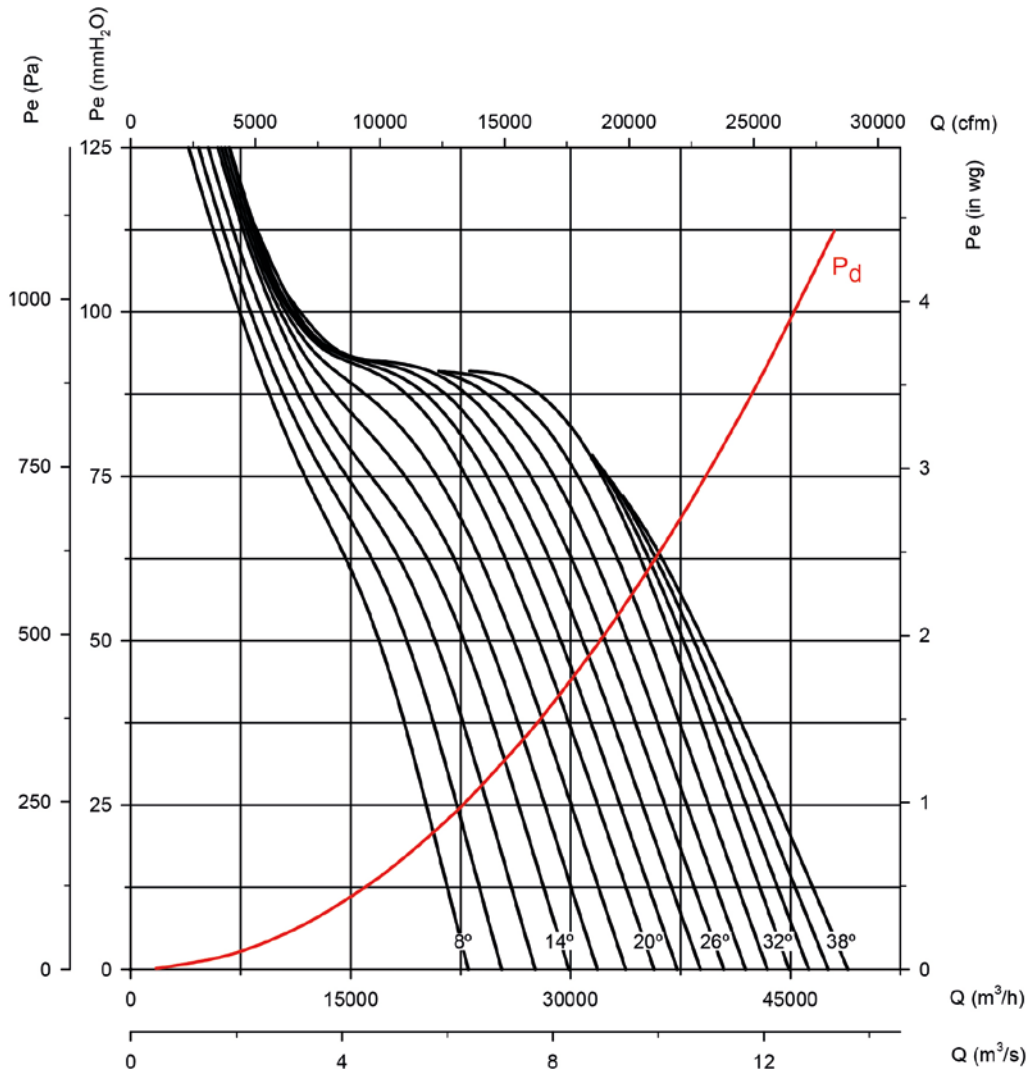

Absorbed power

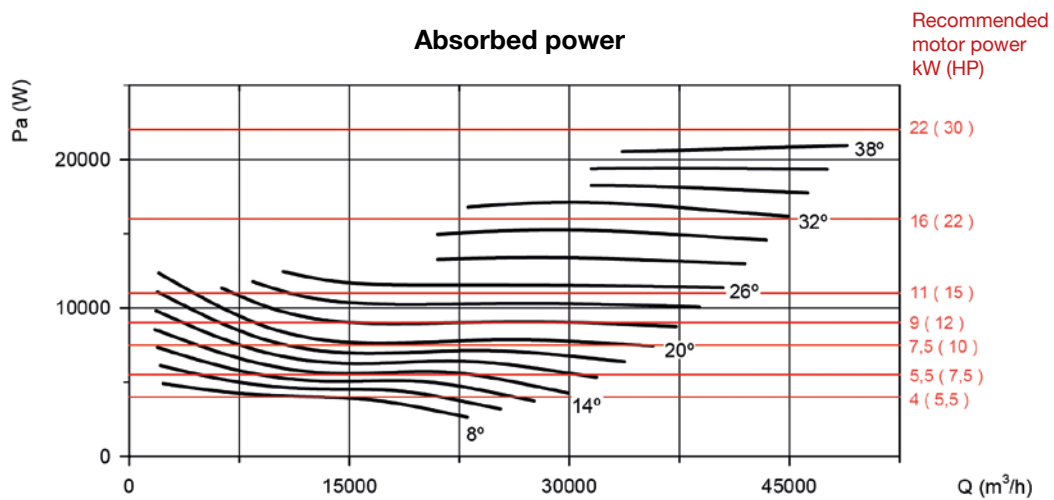

Characteristic curves

Q= Flow rate in m³/h, m³/s and cfm Pe= Static pressure in mm H₂O, Pa and inwg

Impeller diameter in cm: 63

Number of motor poles: 4

Number of blades: 6

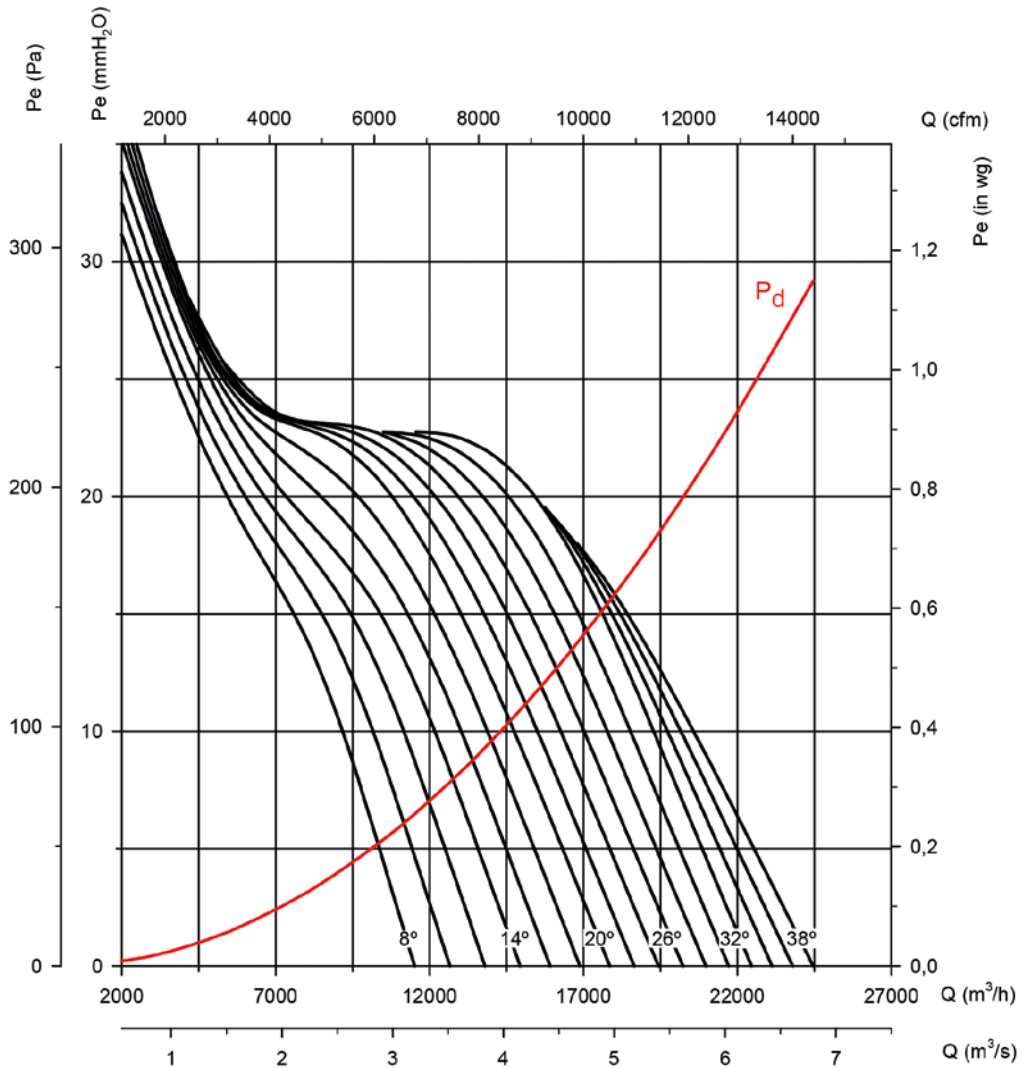

Absorbed power

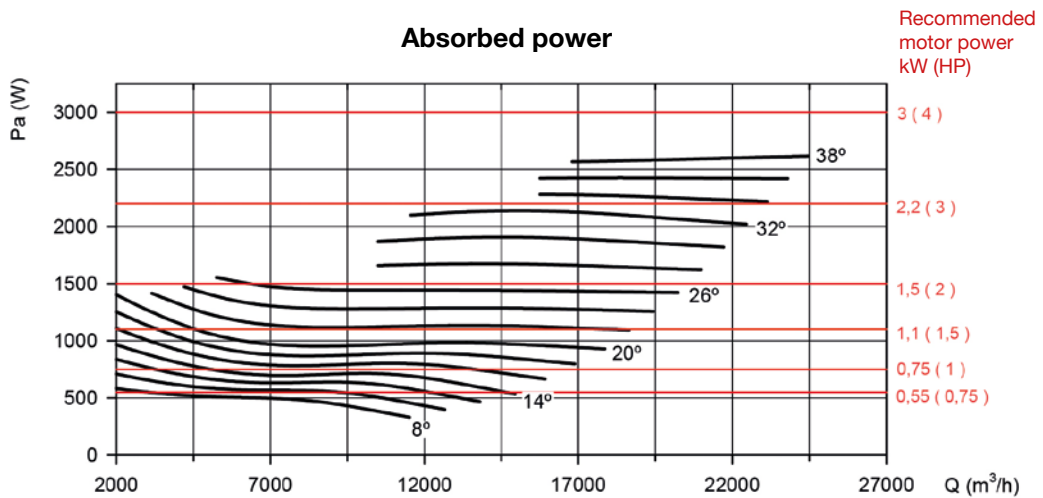

Characteristic curves

Q= Flow rate in m³/h, m³/s and cfm

Pe= Static pressure in mm H₂O, Pa and inwg

Impeller diameter in cm: 63

Number of motor poles: 6

Number of blades: 6

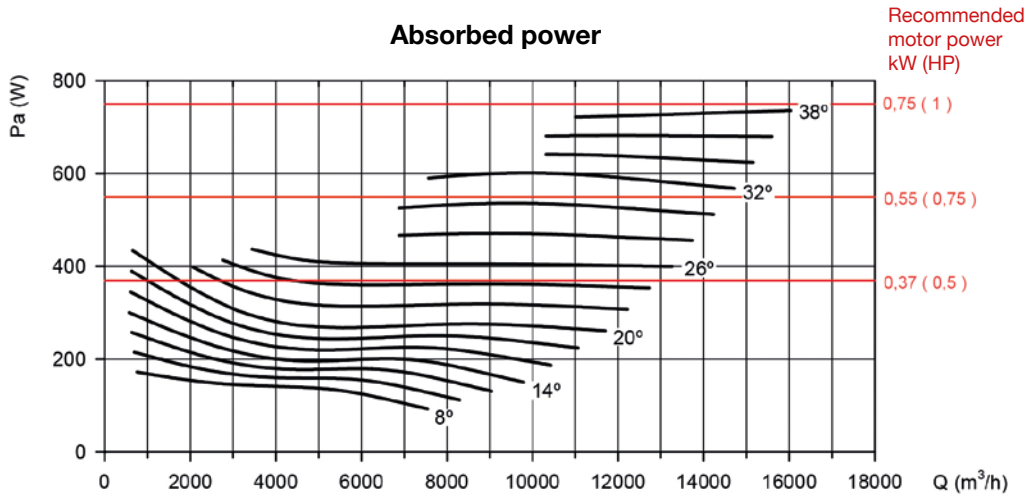
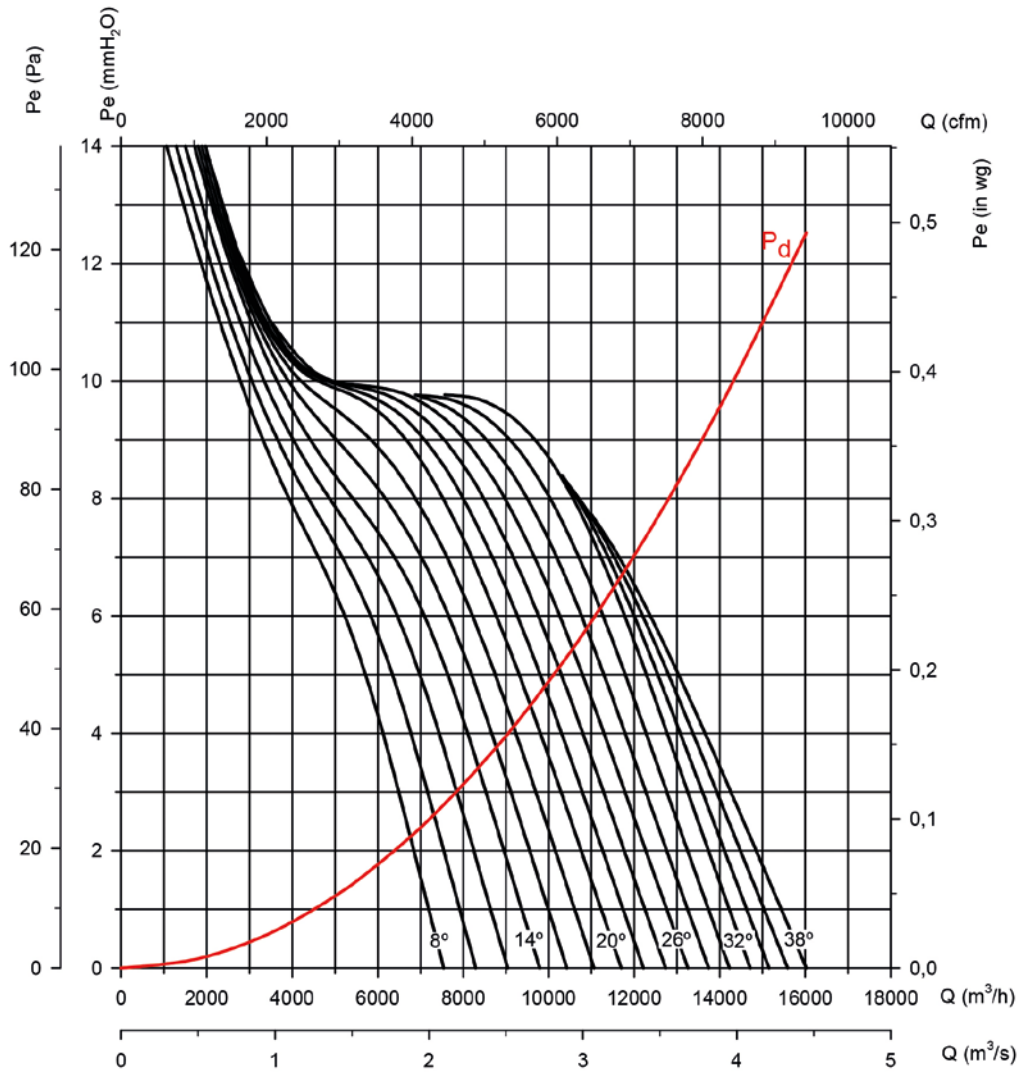

Characteristic curves

Q= Flow rate in m³/h, m³/s and cfm

Pe= Static pressure in mm H₂O, Pa and inwg

Impeller diameter in cm: 71

Number of motor poles: 4

Number of blades: 6

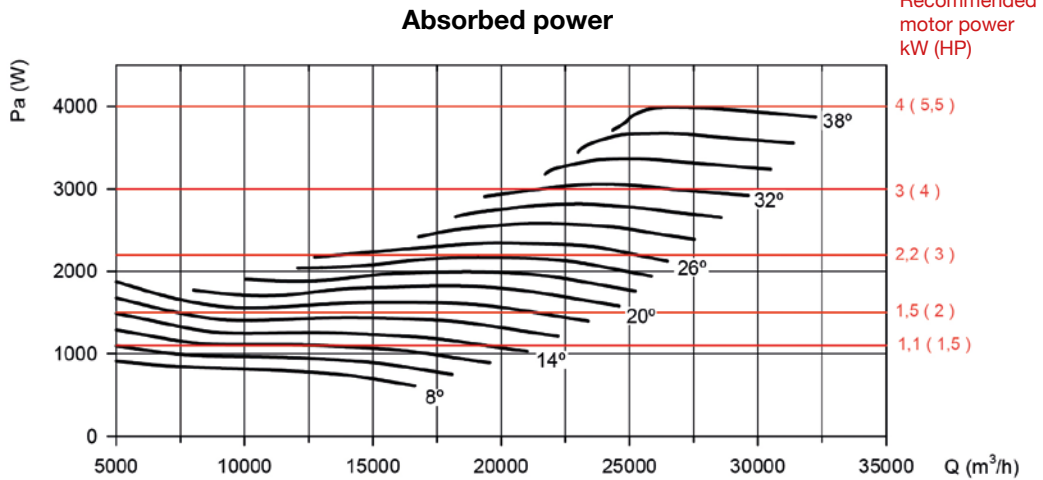
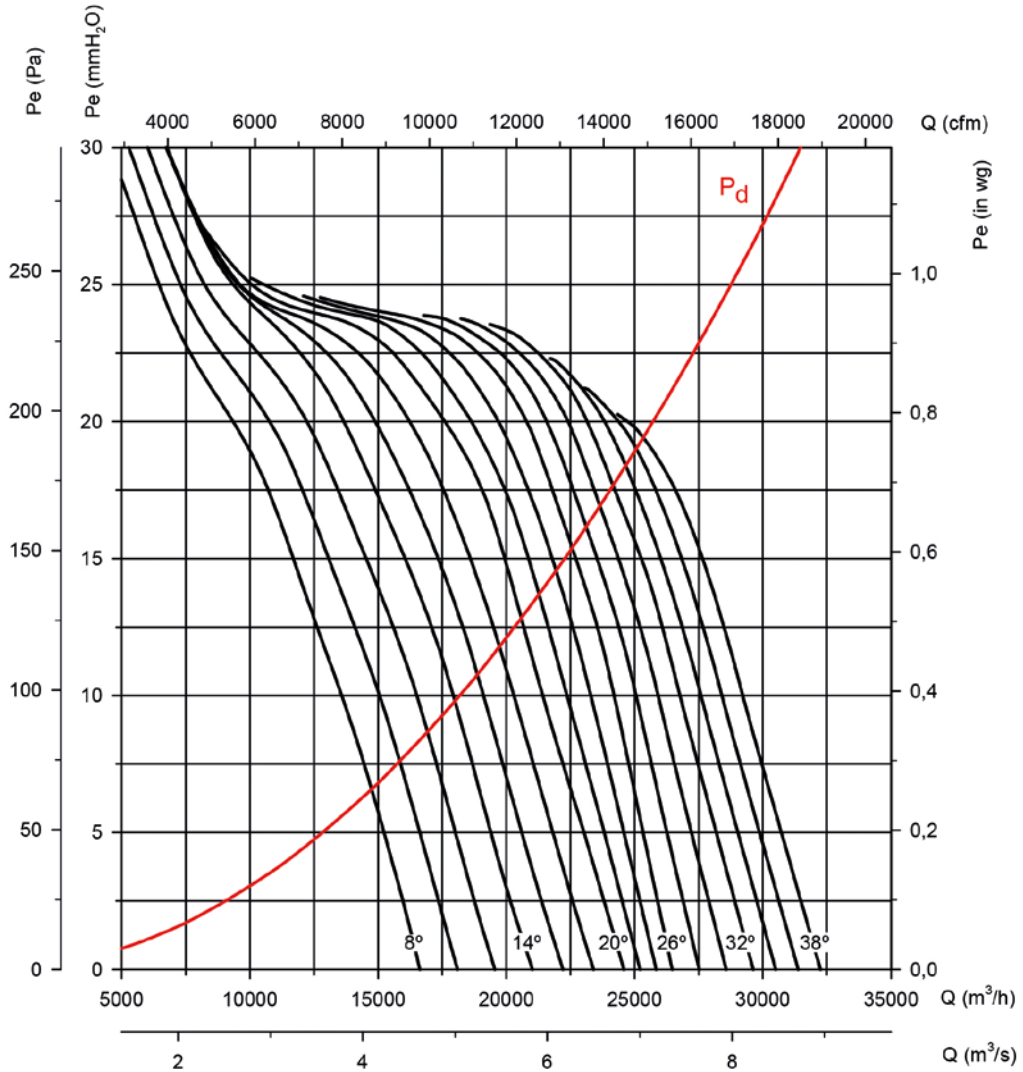

Characteristic curves

Q= Flow rate in m³/h, m³/s and cfm

Pe= Static pressure in mm H₂O, Pa and inwg

Impeller diameter in cm: 71

Number of motor poles: 6

Number of blades: 6

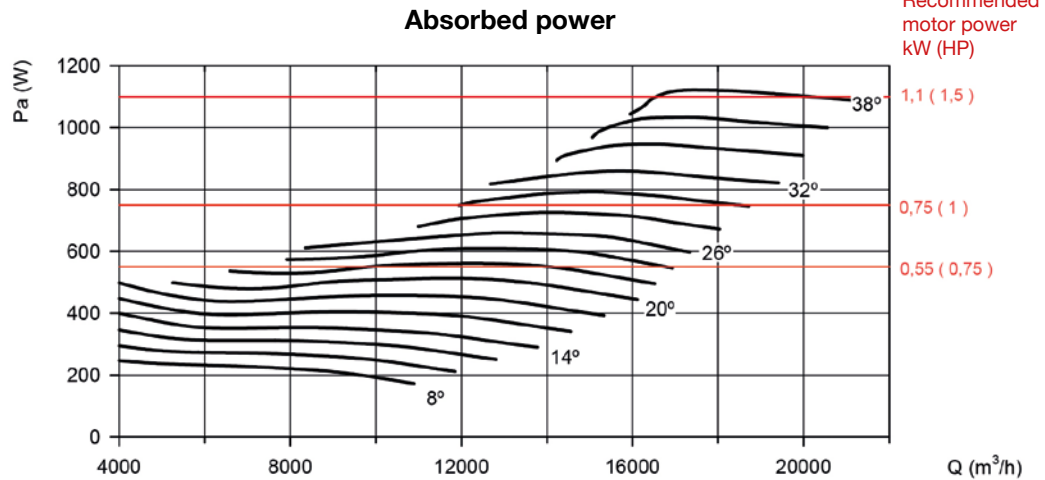
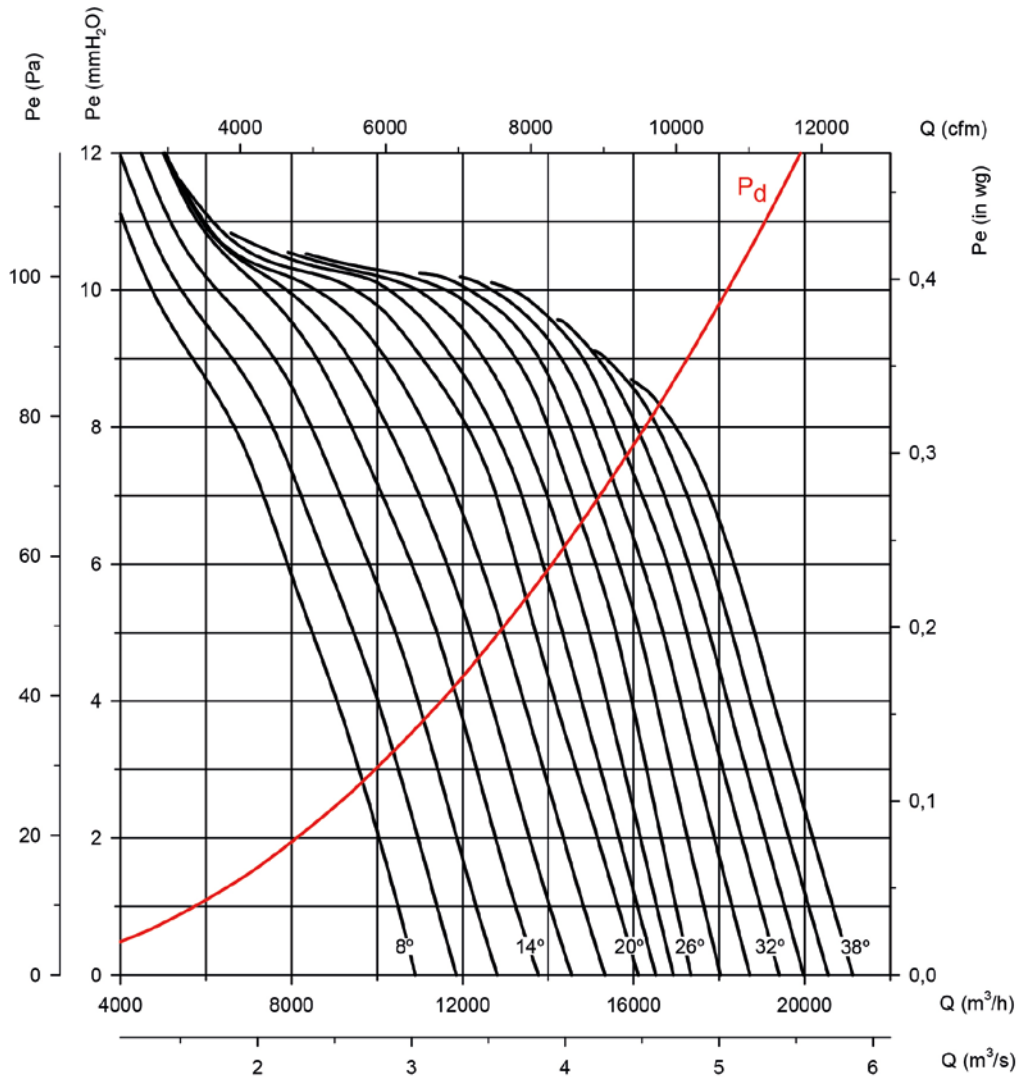

Characteristic curves

Q= Flow rate in m³/h, m³/s and cfm Pe= Static pressure in mm H₂O, Pa and inwg

Impeller diameter in cm: 80

Number of motor poles: 4

Number of blades: 6

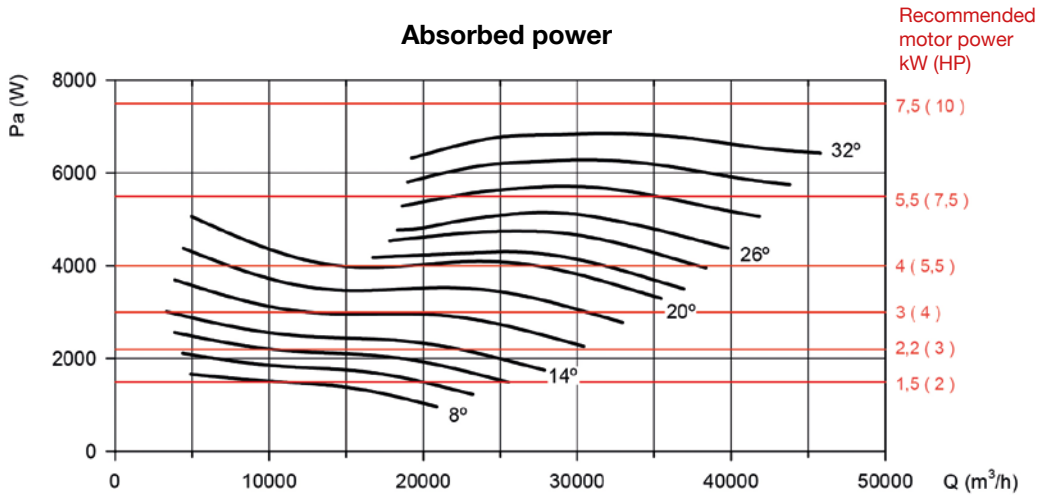
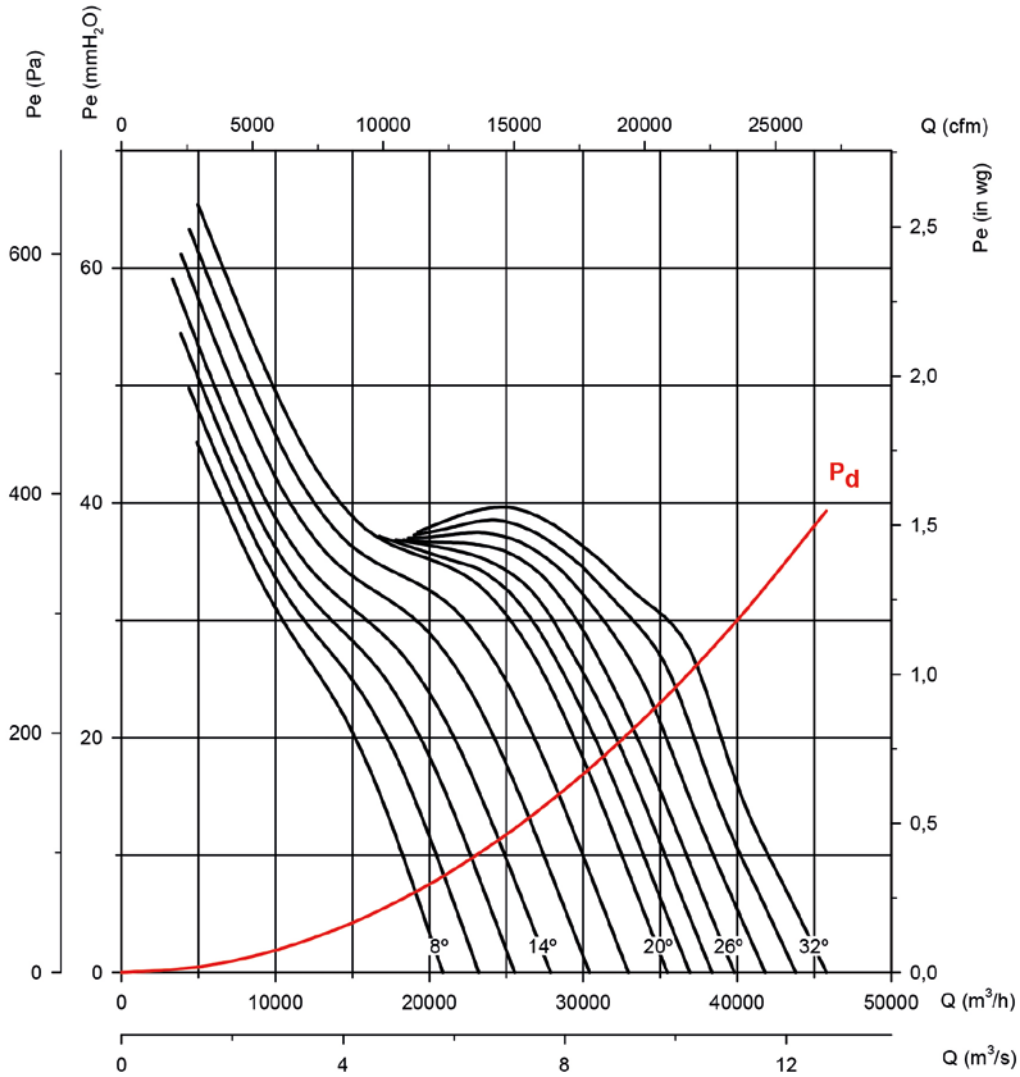

Characteristic curves

Q= Flow rate in m³/h, m³/s and cfm

Pe= Static pressure in mm H₂O, Pa and inwg

Impeller diameter in cm: 80

Number of motor poles: 6

Number of blades: 6

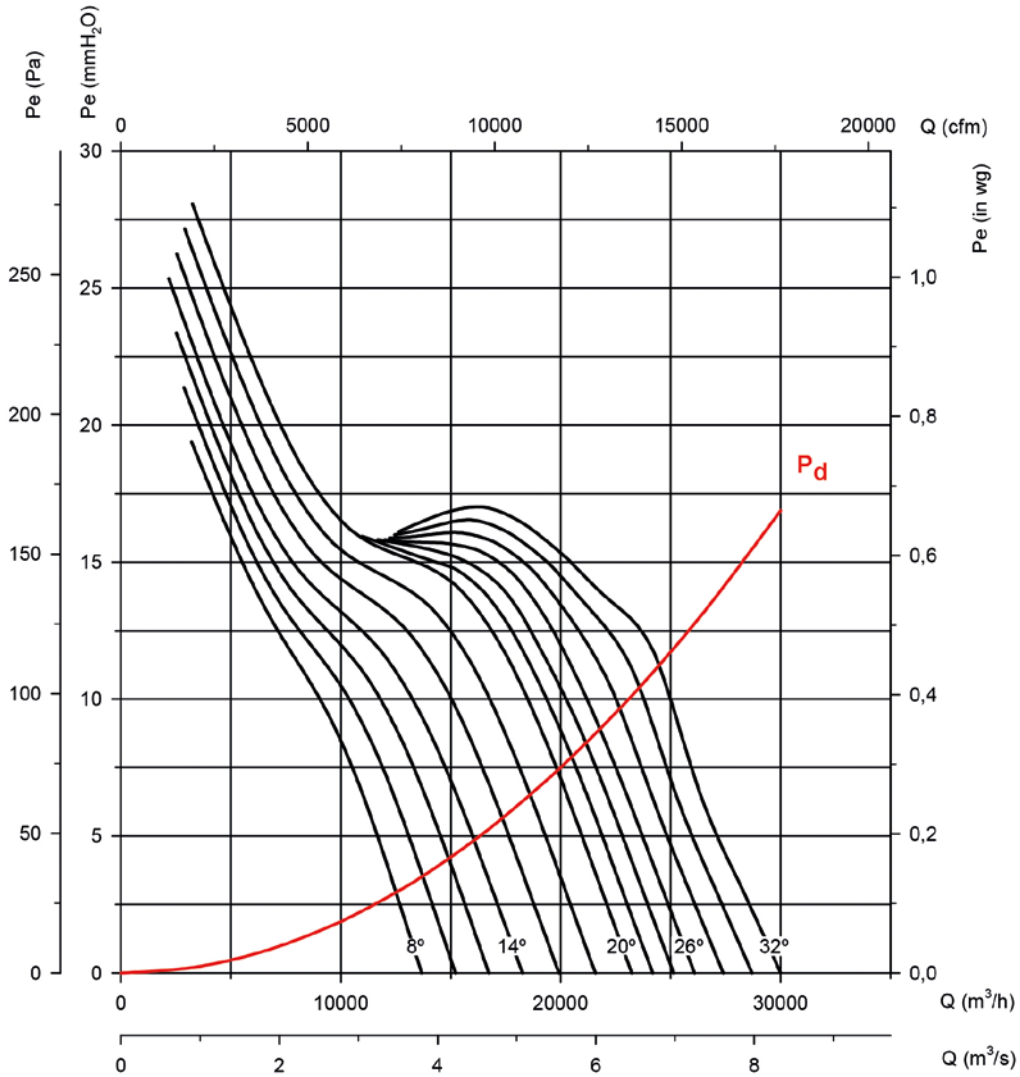

Absorbed power

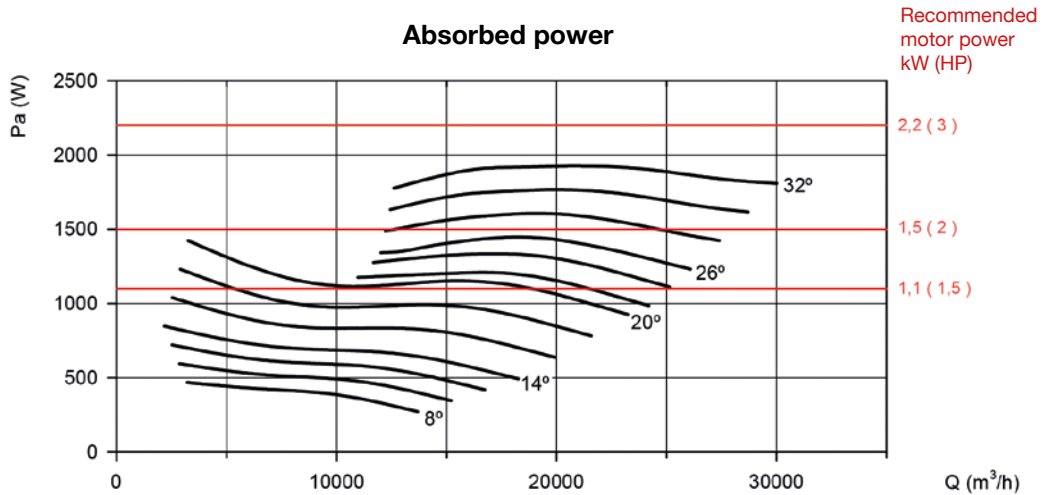

Characteristic curves

Q= Flow rate in m³/h, m³/s and cfm Pe= Static pressure in mm H₂O, Pa and inwg

Impeller diameter in cm: 80

Number of motor poles: 8

Number of blades: 6

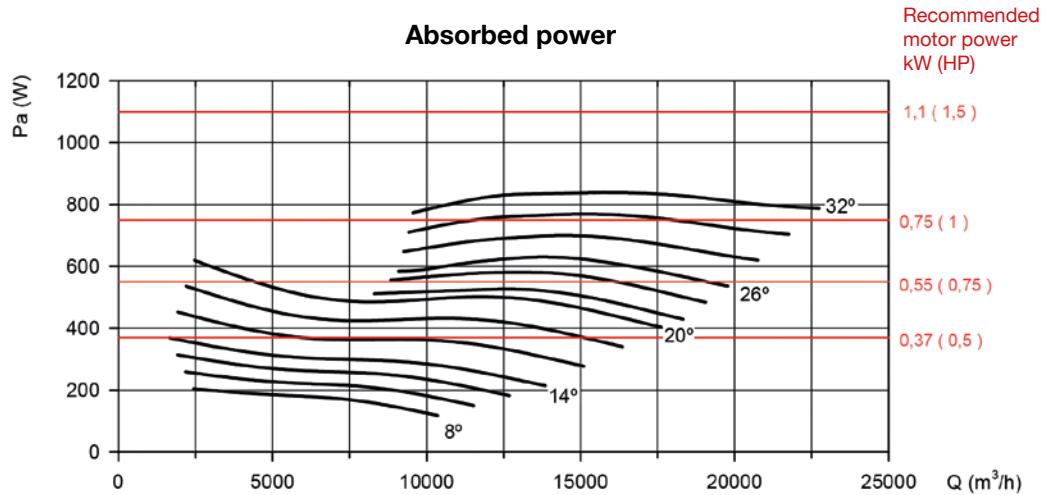
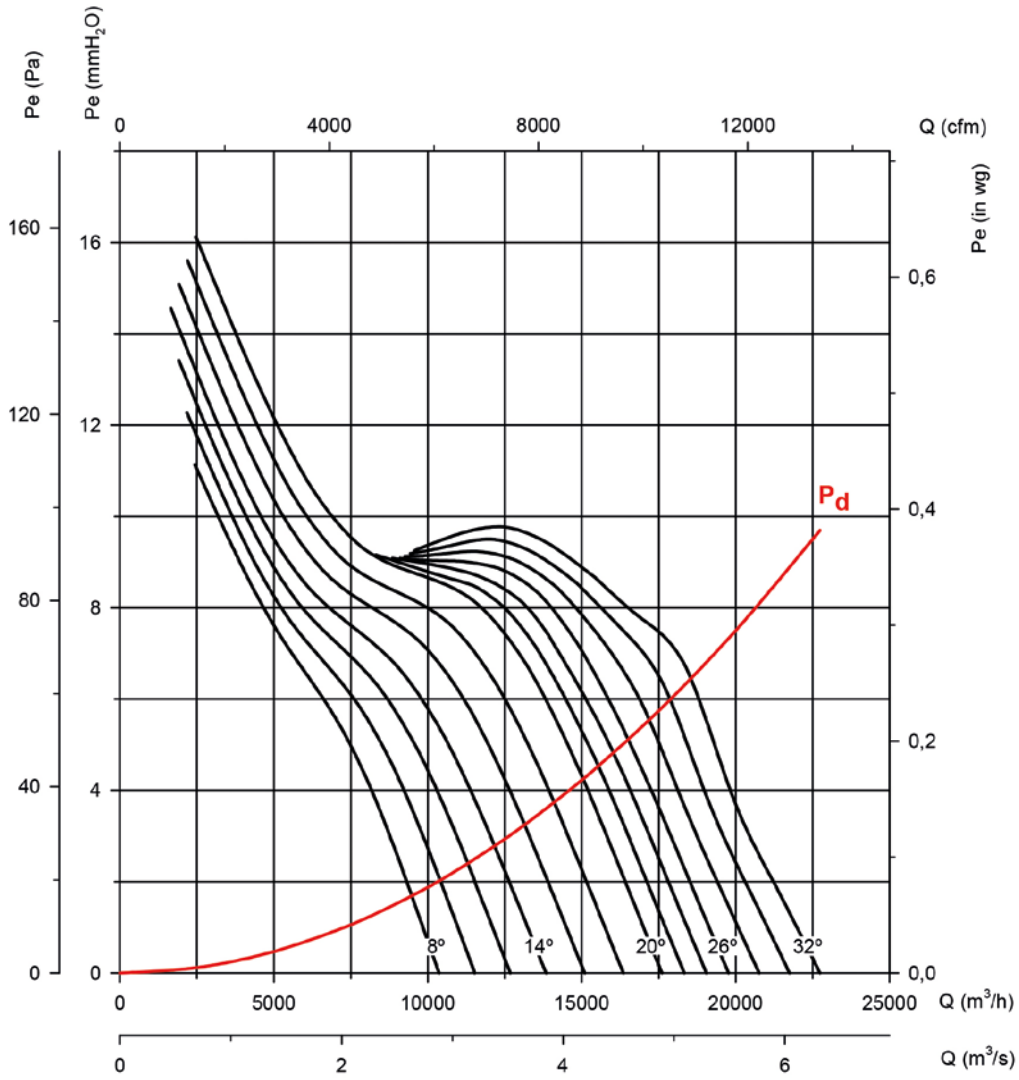

Characteristic curves

Q= Flow rate in m³/h, m³/s and cfm

Pe= Static pressure in mm H₂O, Pa and inwg

Impeller diameter in cm: 90

Number of motor poles: 4

Number of blades: 6

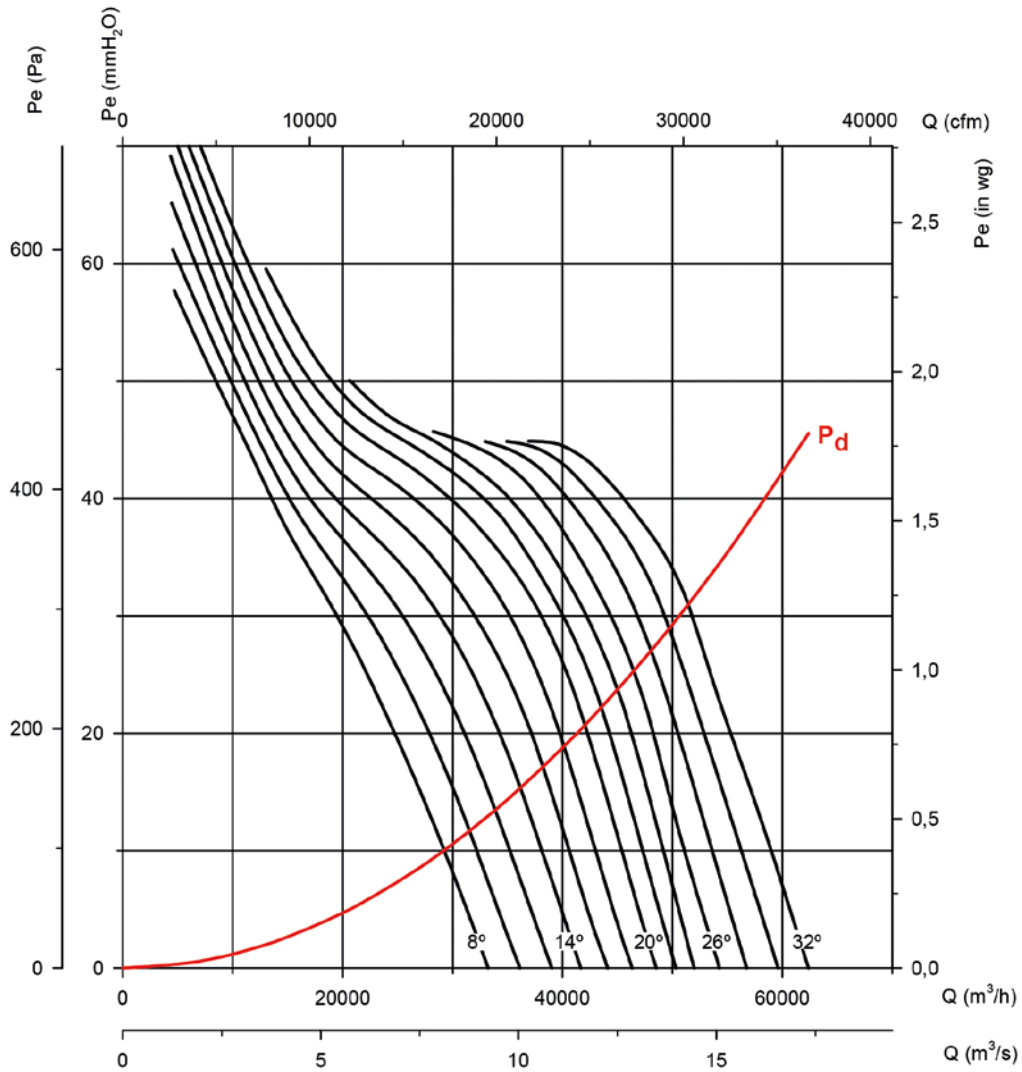

Absorbed power

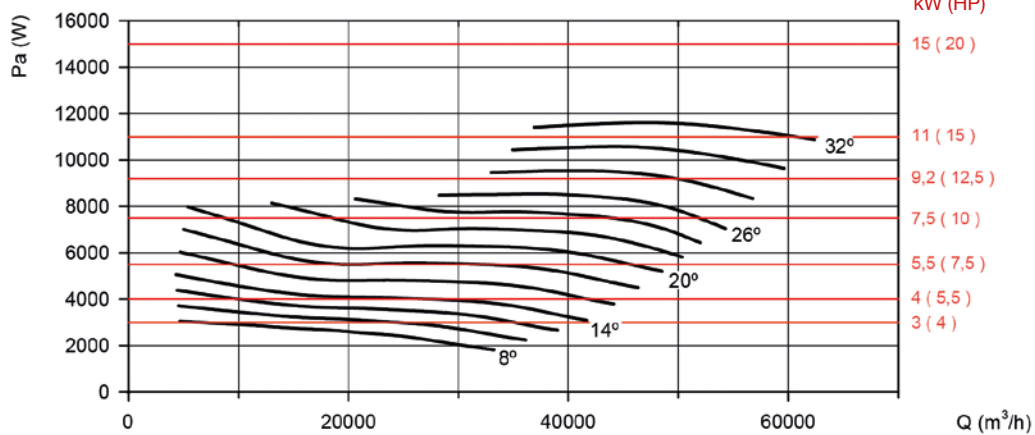

Characteristic curves

Q= Flow rate in m³/h, m³/s and cfm Pe= Static pressure in mm H₂O, Pa and inwg

Impeller diameter in cm: 90

Number of motor poles: 6

Number of blades: 6

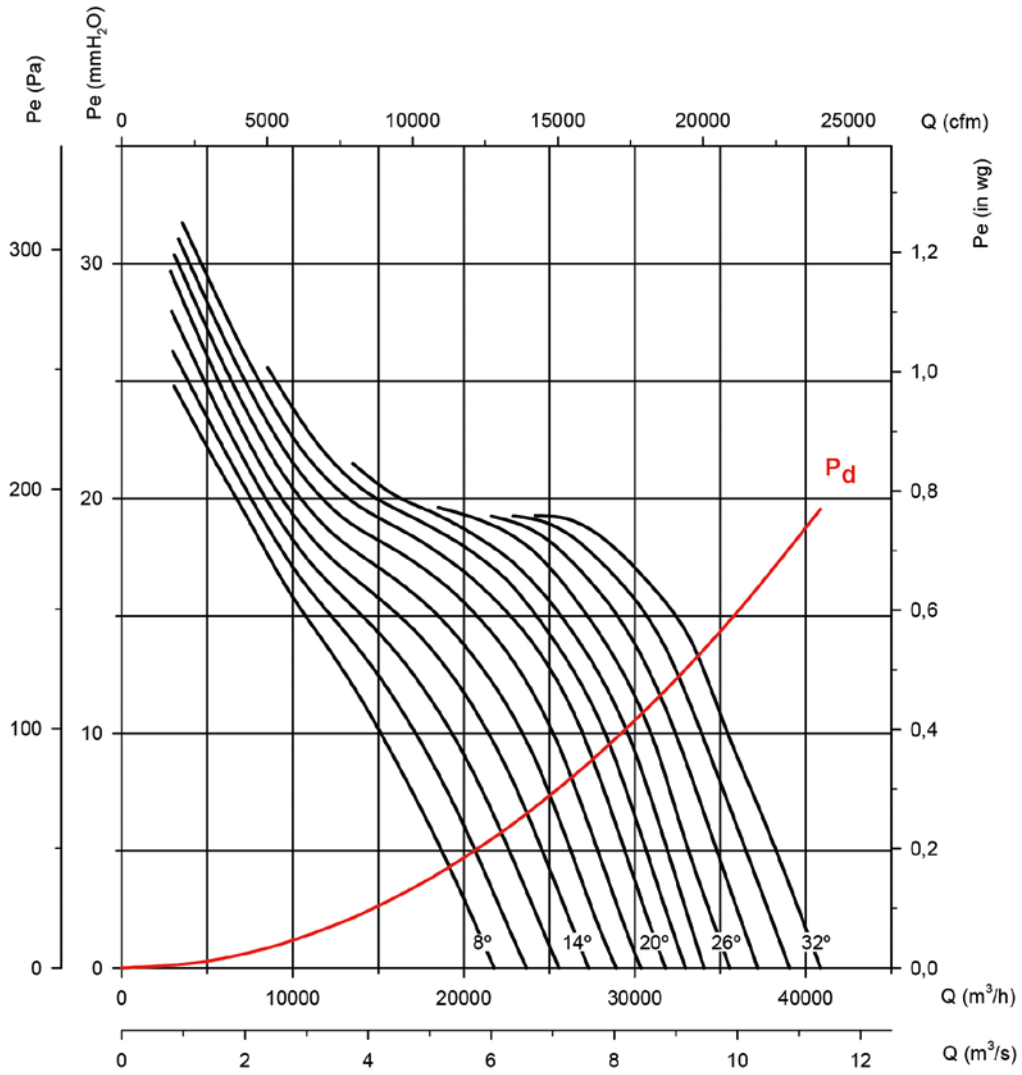

Absorbed power

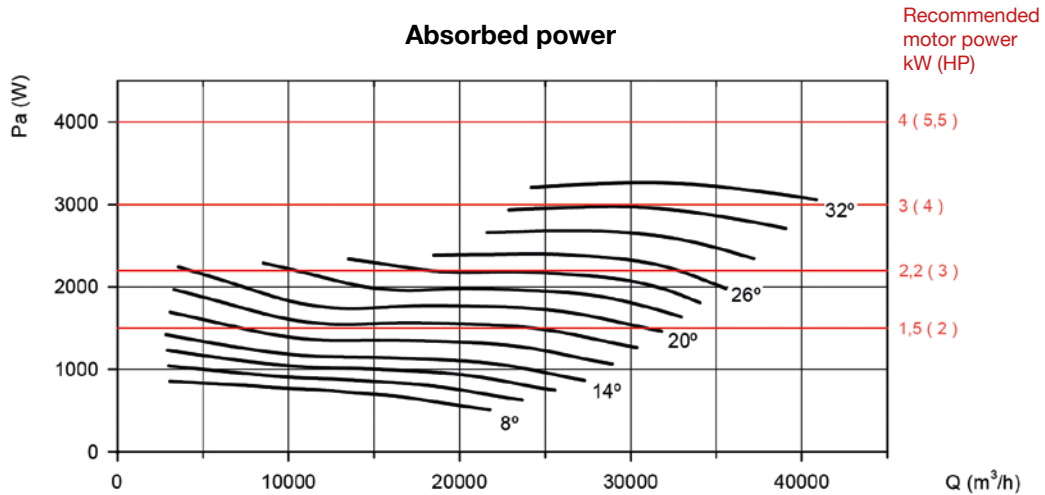

Characteristic curves

Q= Flow rate in m³/h, m³/s and cfm

Pe= Static pressure in mm H₂O, Pa and inwg

Impeller diameter in cm: 90

Number of motor poles: 8

Number of blades: 6

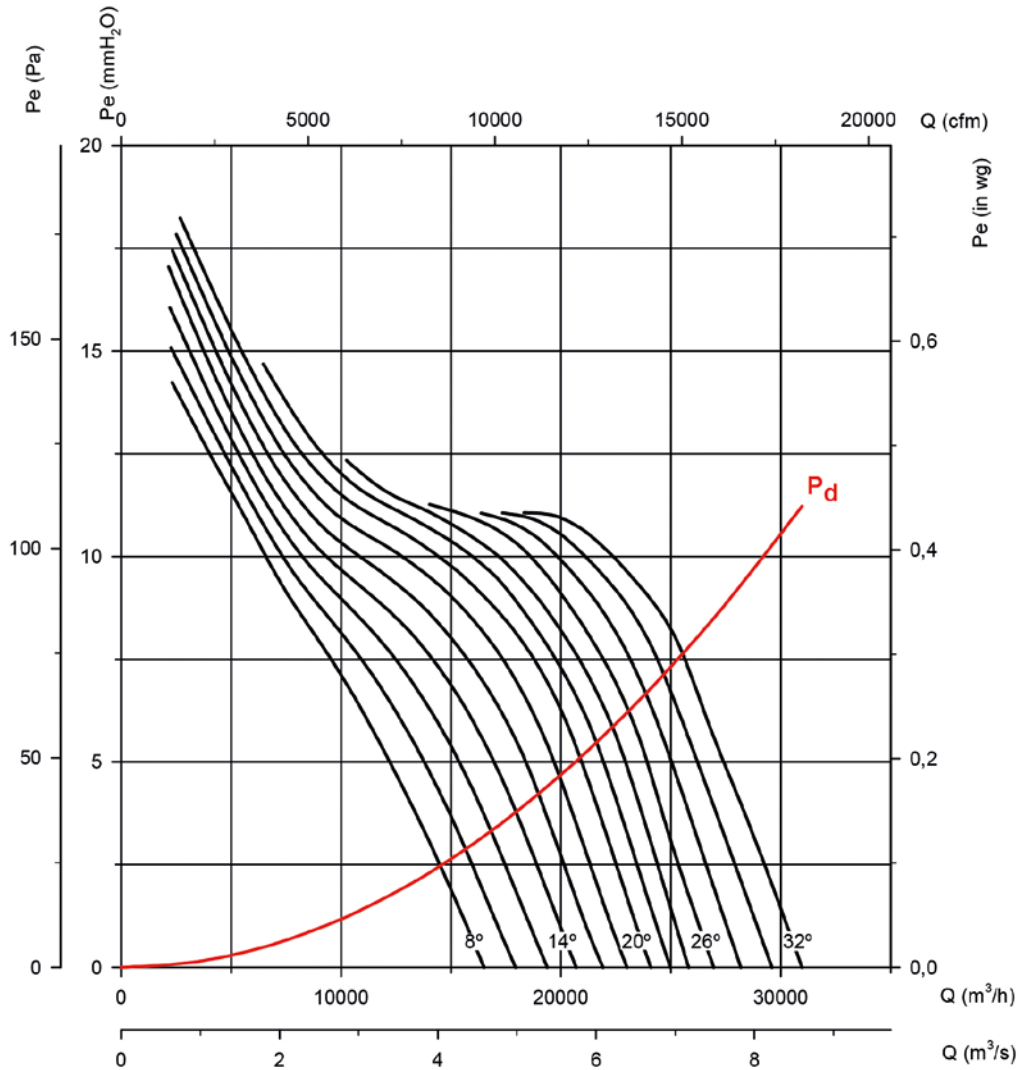

Absorbed power

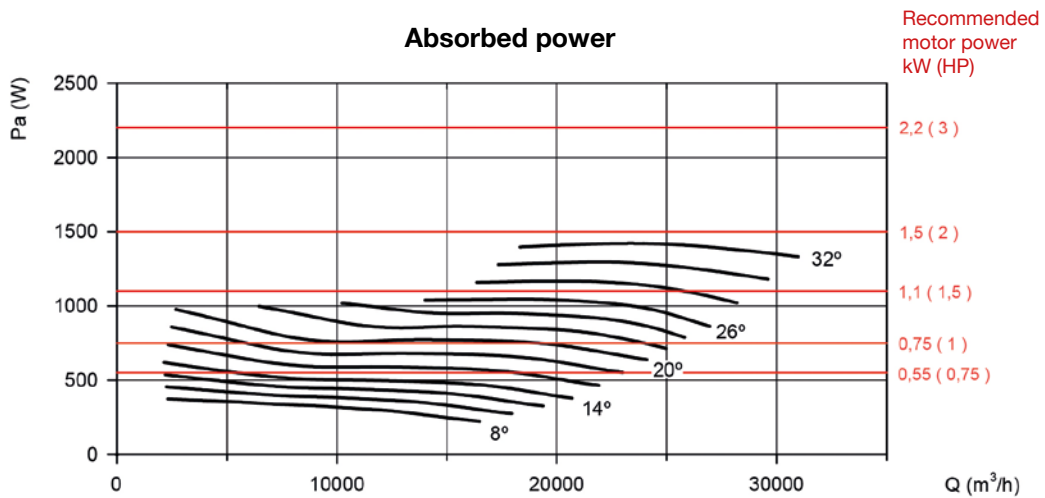

Characteristic curves

Q= Flow rate in m³/h, m³/s and cfm Pe= Static pressure in mm H₂O, Pa and inwg

Impeller diameter in cm: 100

Number of motor poles: 4

Number of blades: 6

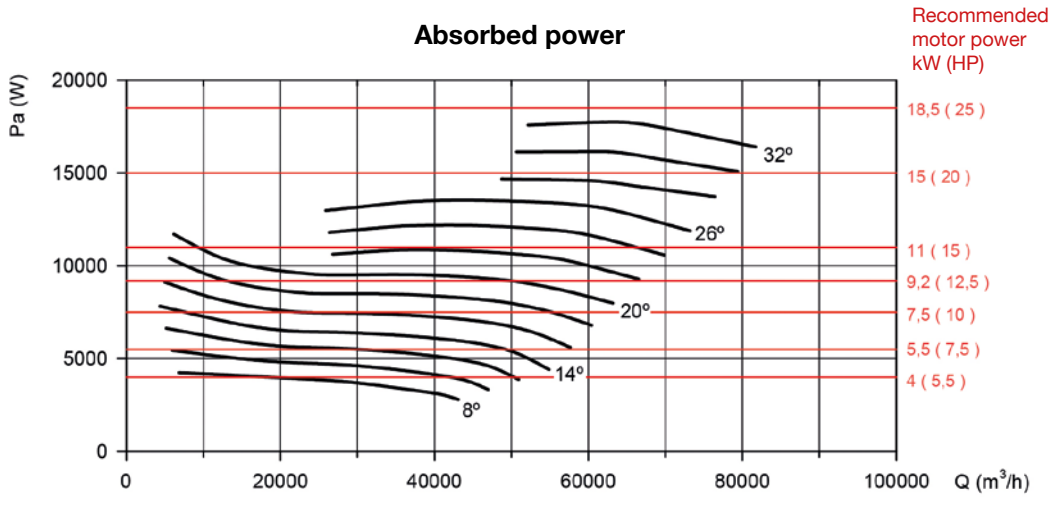
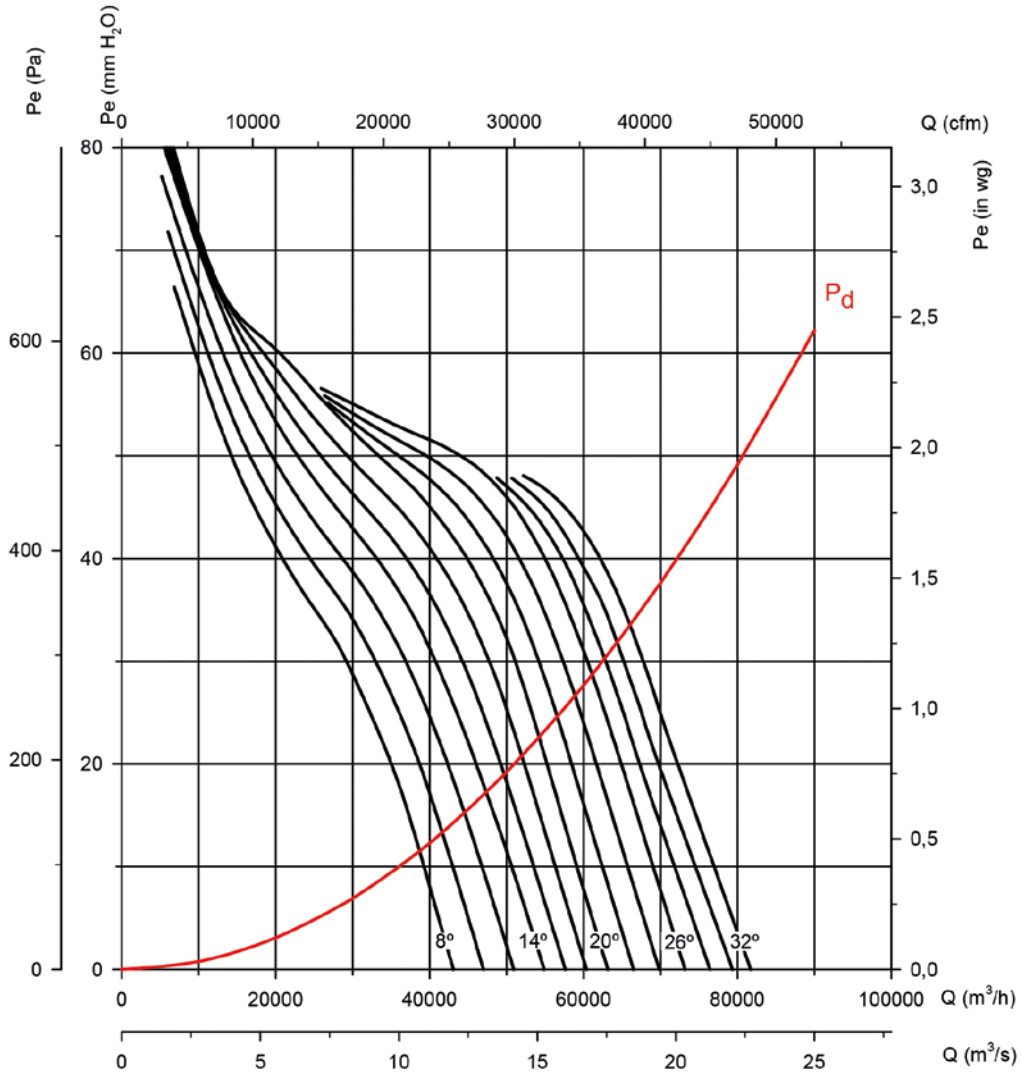

Characteristic curves

Q= Flow rate in m³/h, m³/s and cfm

Pe= Static pressure in mm H₂O, Pa and inwg

Impeller diameter in cm: 100

Number of motor poles: 4

Number of blades: 9

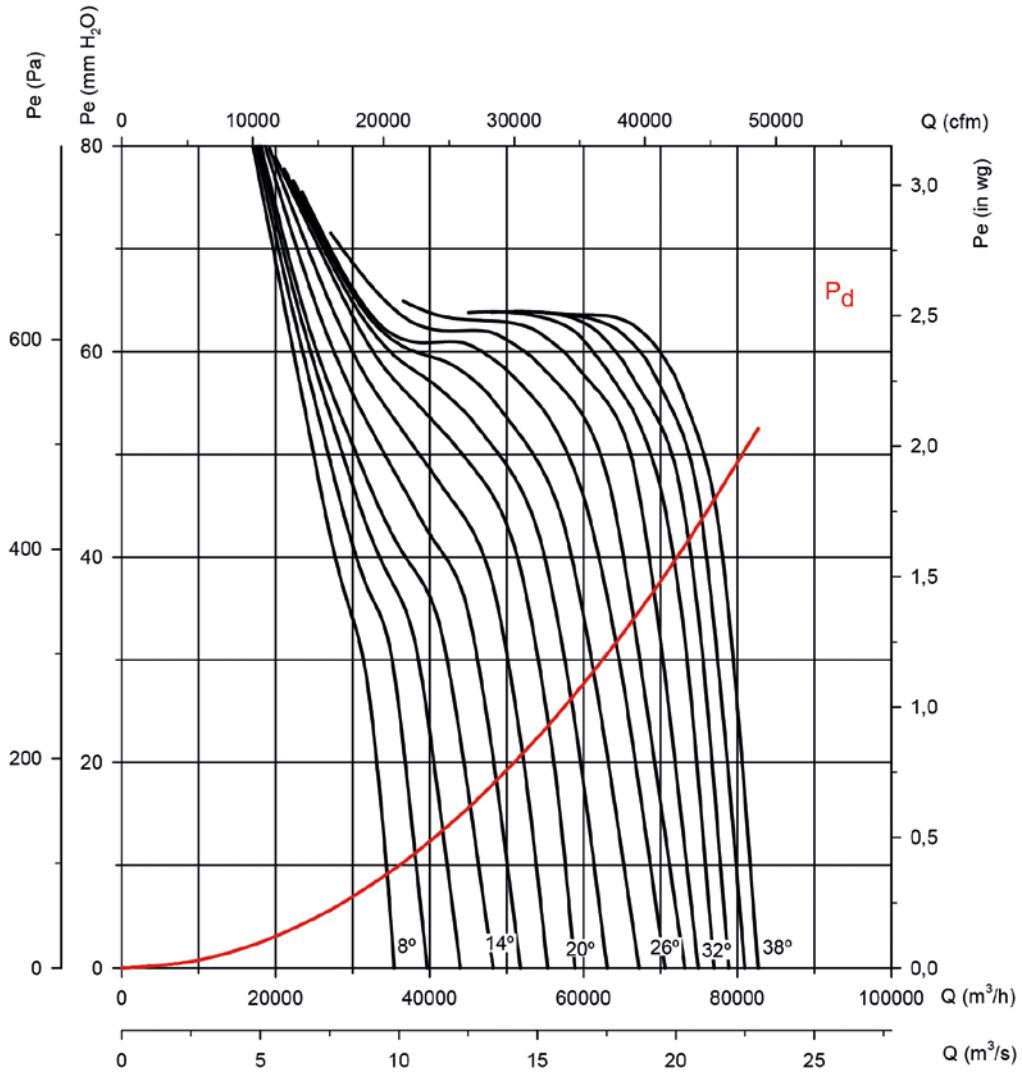

Absorbed power

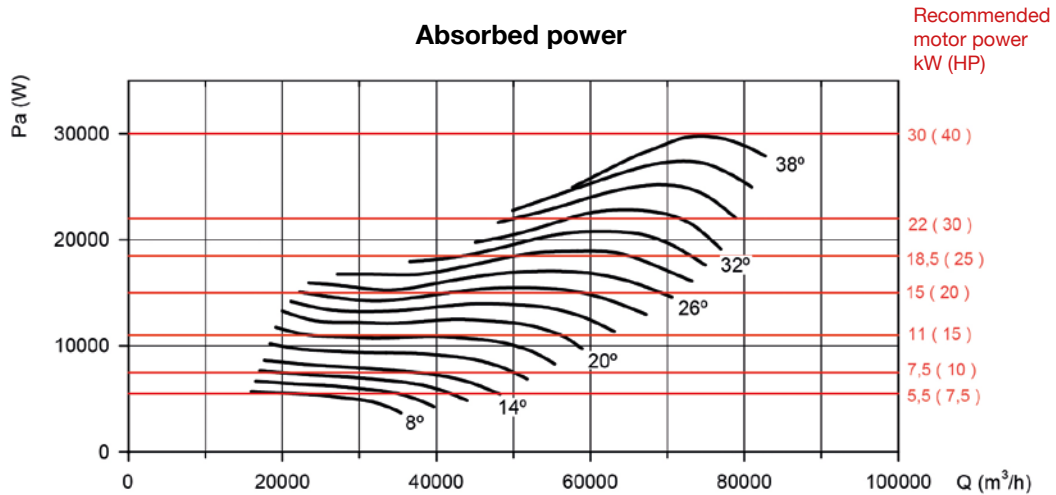

Characteristic curves

Q= Flow rate in m³/h, m³/s and cfm Pe= Static pressure in mm H₂O, Pa and inwg

Impeller diameter in cm: 100

Number of motor poles: 6

Number of blades: 6

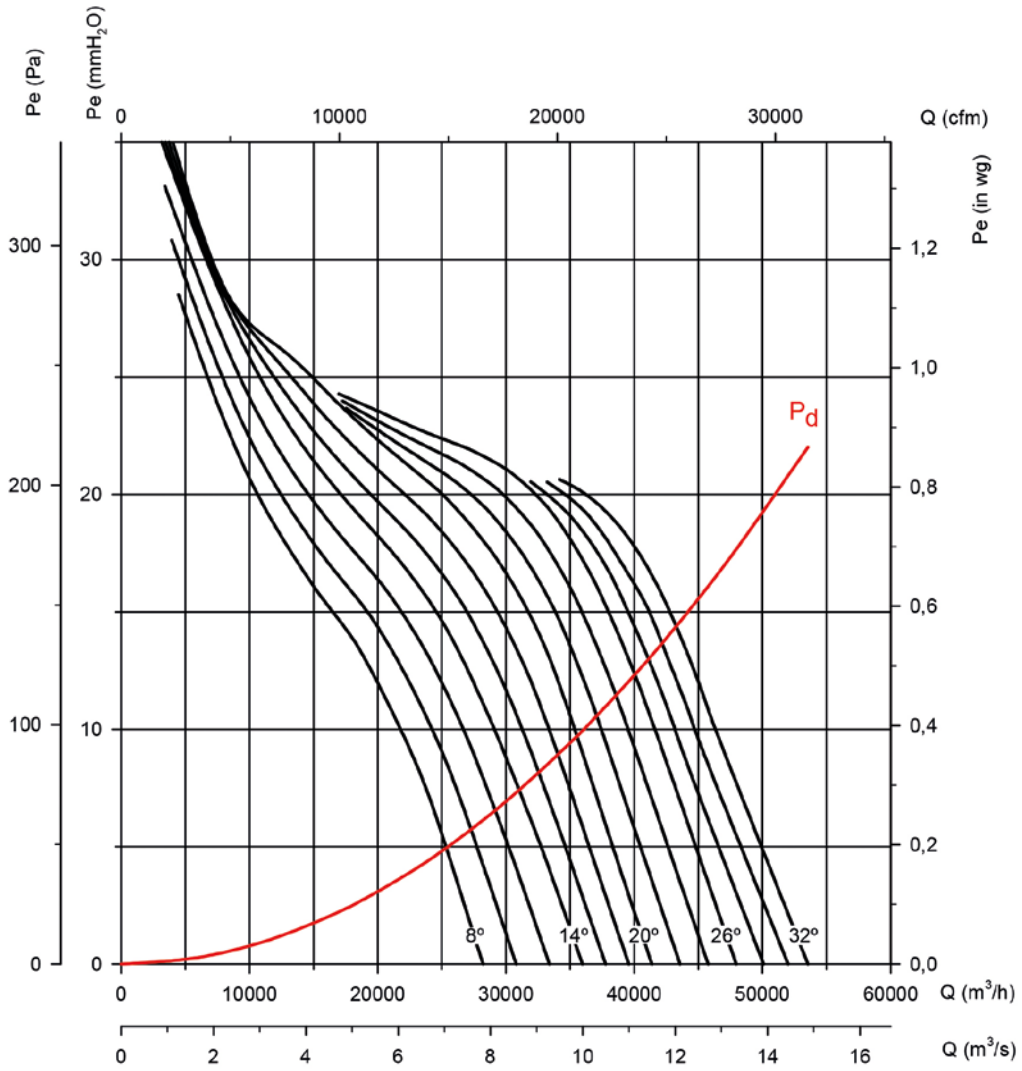

Absorbed power

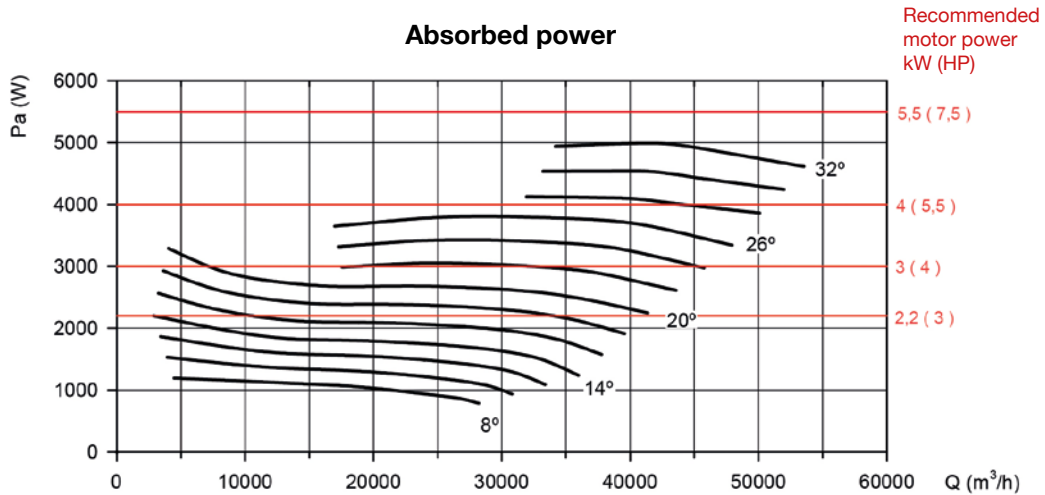

Characteristic curves

Q= Flow rate in m³/h, m³/s and cfm

Pe= Static pressure in mm H₂O, Pa and inwg

Impeller diameter in cm: 100

Number of motor poles: 6

Number of blades: 9

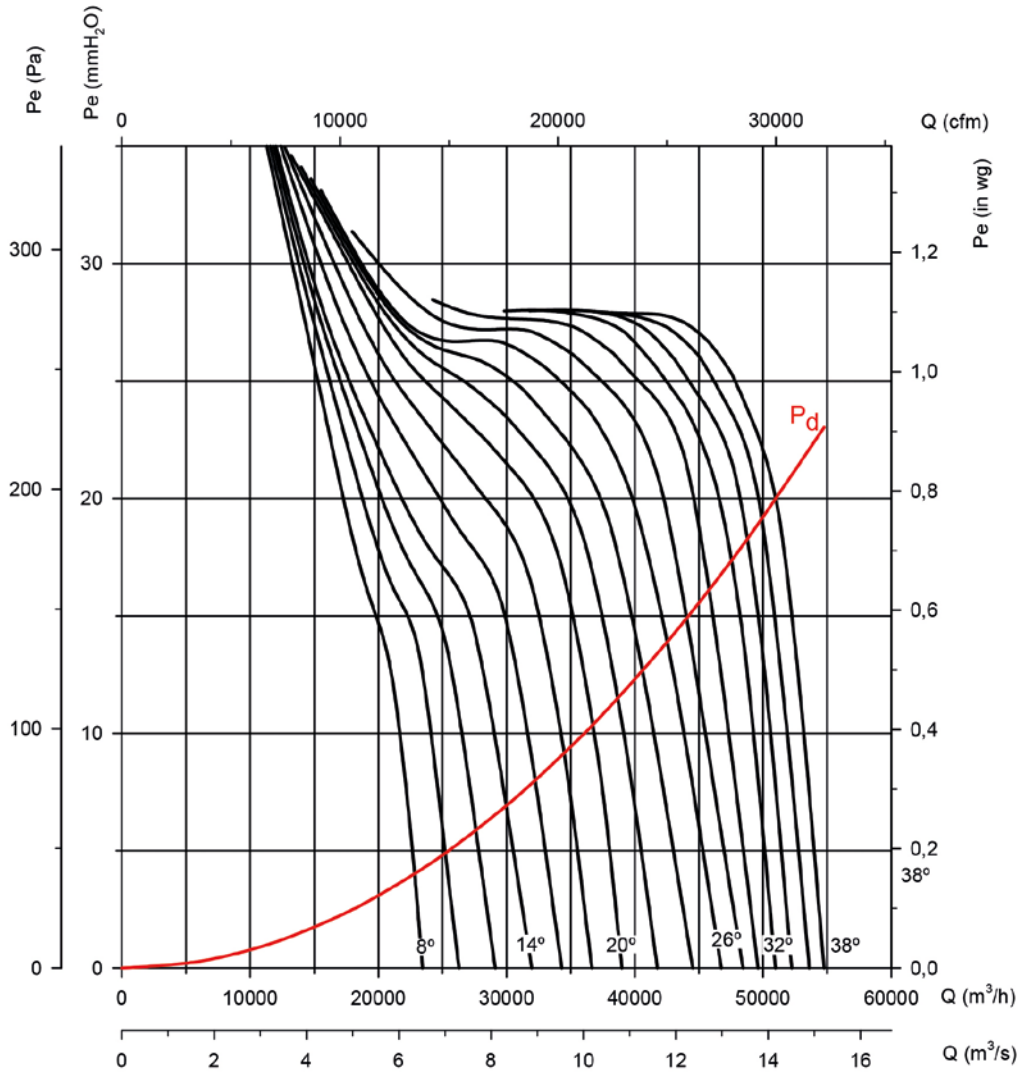

Absorbed power

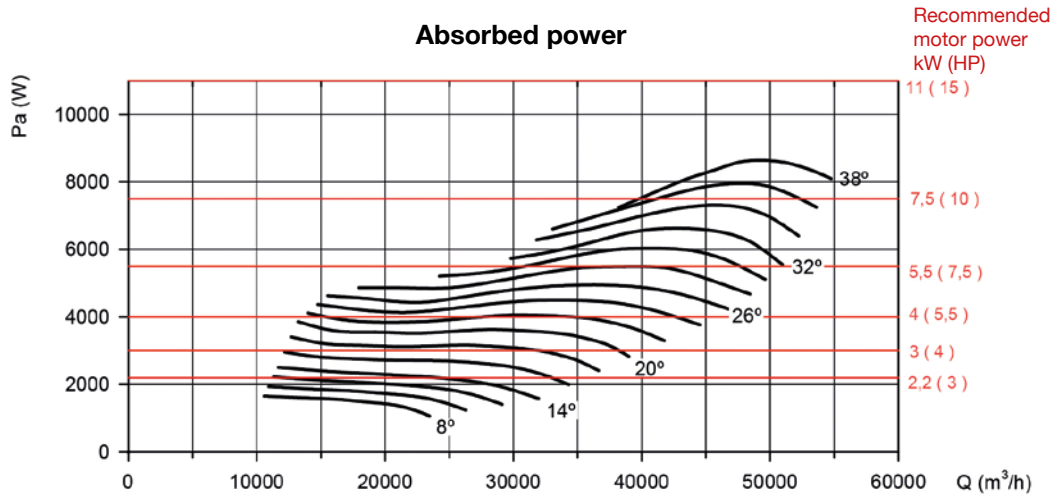

Characteristic curves

Q= Flow rate in m³/h, m³/s and cfm Pe= Static pressure in mm H₂O, Pa and inwg

Impeller diameter in cm: 100

Number of motor poles: 8

Number of blades: 6

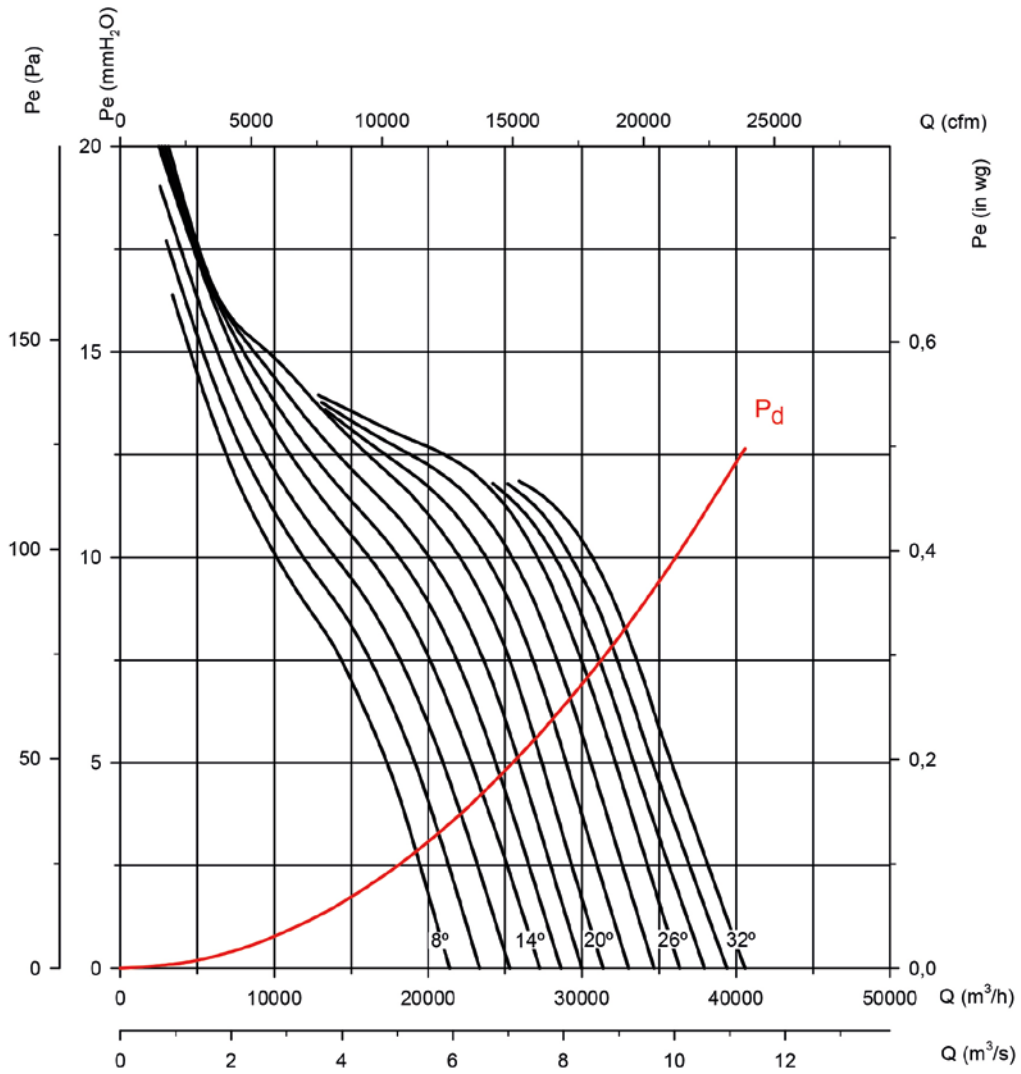

Absorbed power

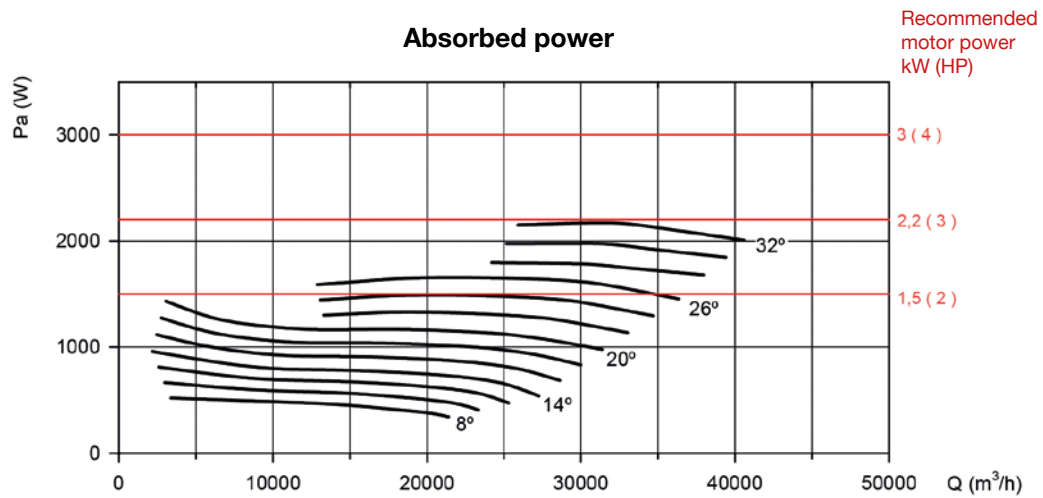

Characteristic curves

Q= Flow rate in m³/h, m³/s and cfm Pe= Static pressure in mm H₂O, Pa and inwg

Impeller diameter in cm: 125

Number of motor poles: 4

Number of blades: 6

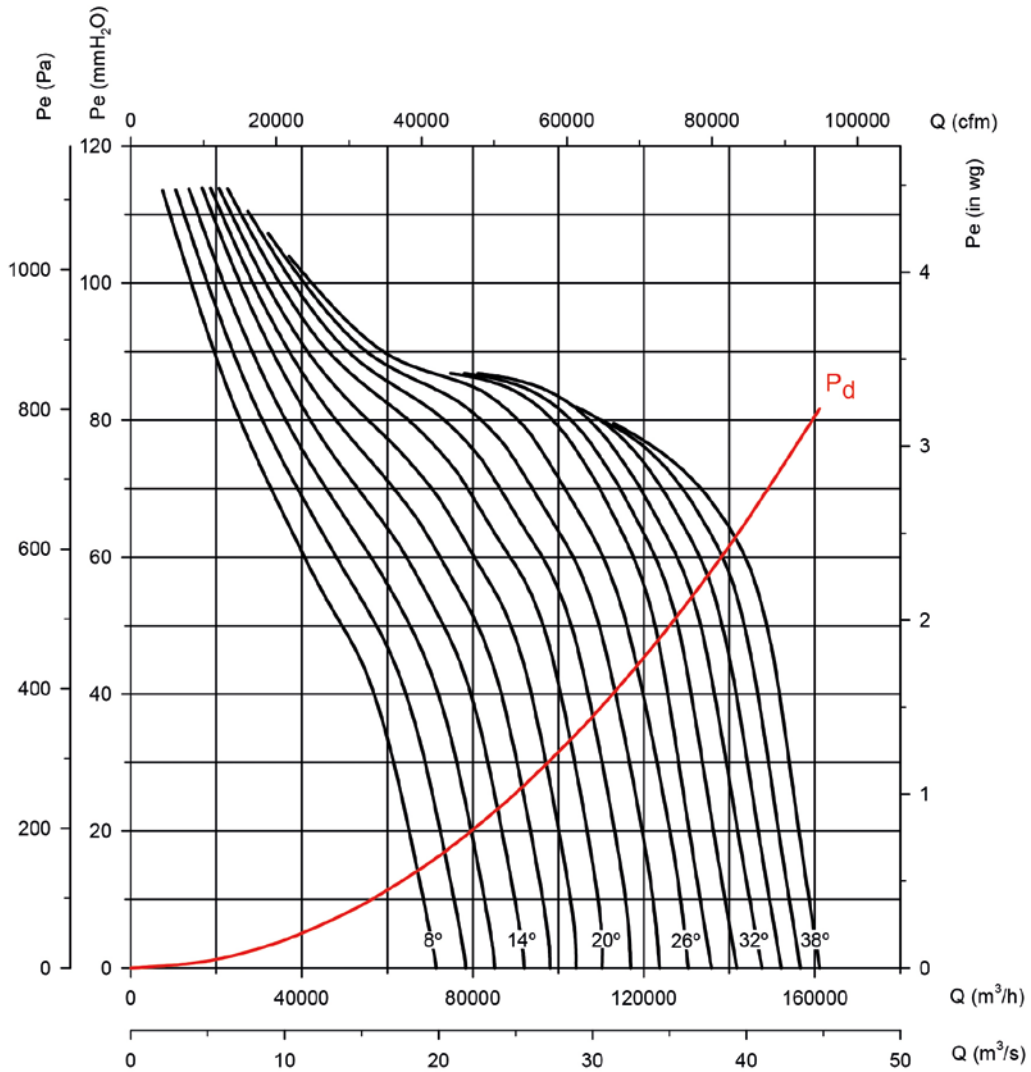

Absorbed power

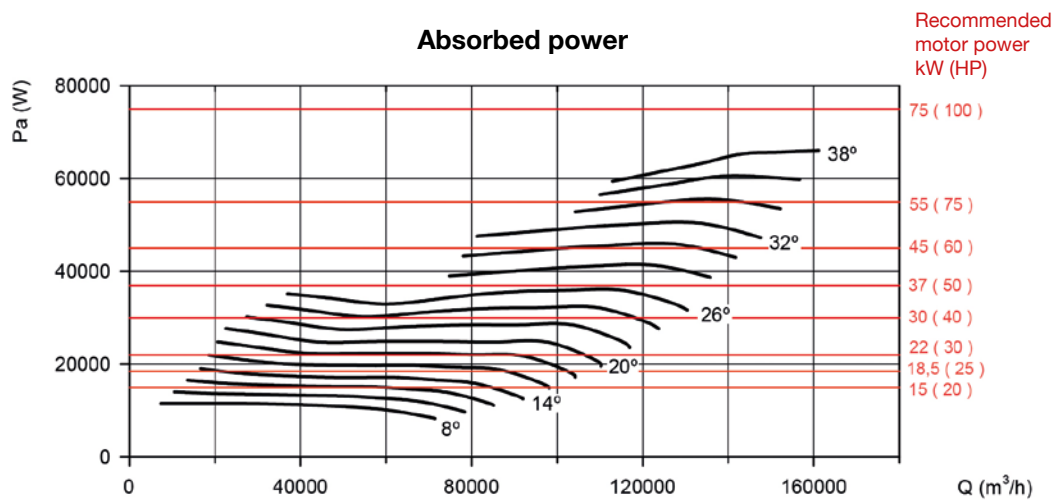

Characteristic curves

Q= Flow rate in m³/h, m³/s and cfm

Pe= Static pressure in mm H₂O, Pa and inwg

Impeller diameter in cm: 125

Number of motor poles: 4

Number of blades: 9

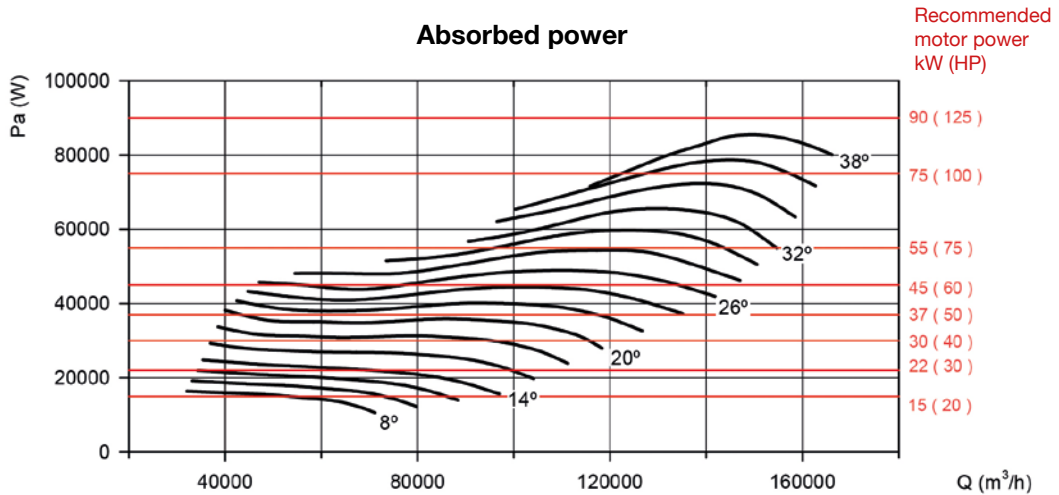
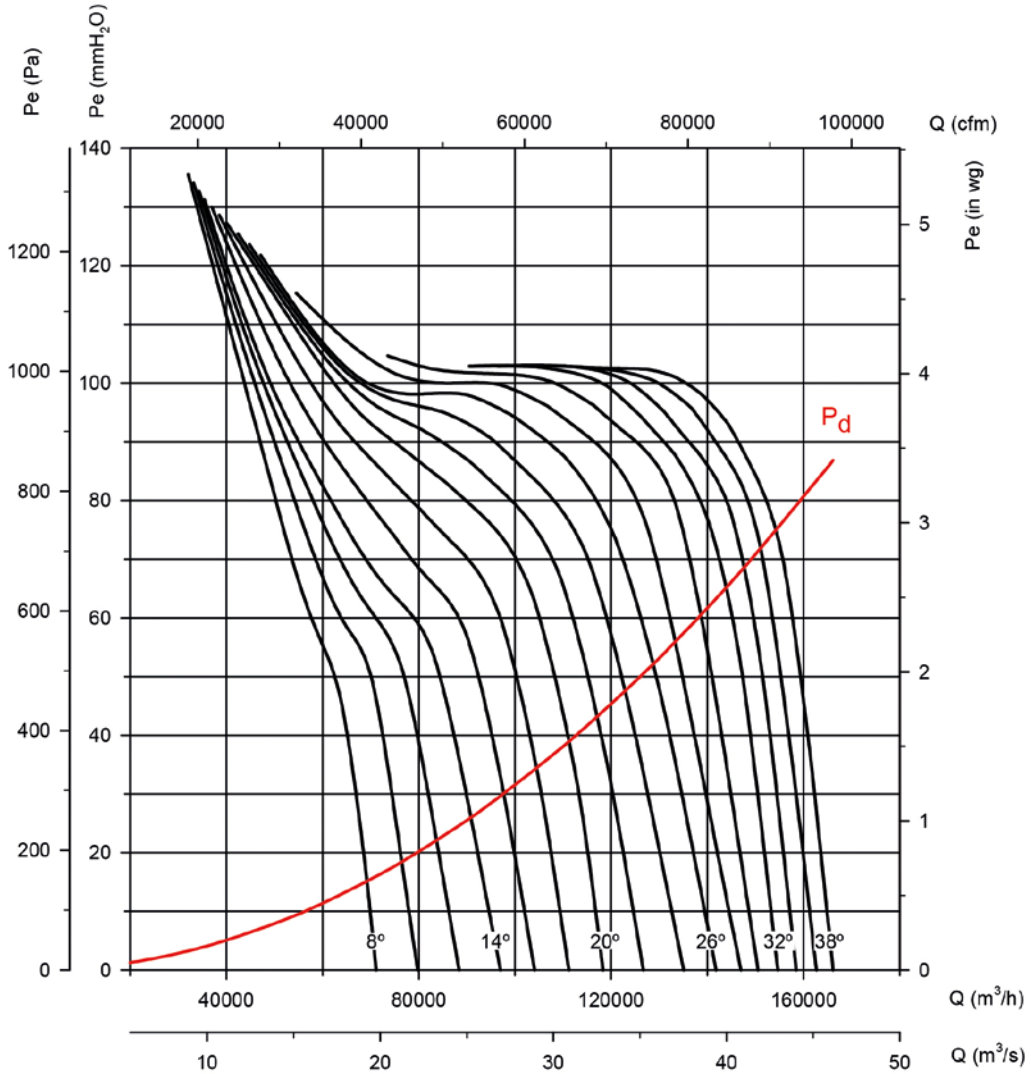

Characteristic curves

Q= Flow rate in m³/h, m³/s and cfm Pe= Static pressure in mm H₂O, Pa and inwg

Impeller diameter in cm: 125

Number of motor poles: 4

Number of blades: 12

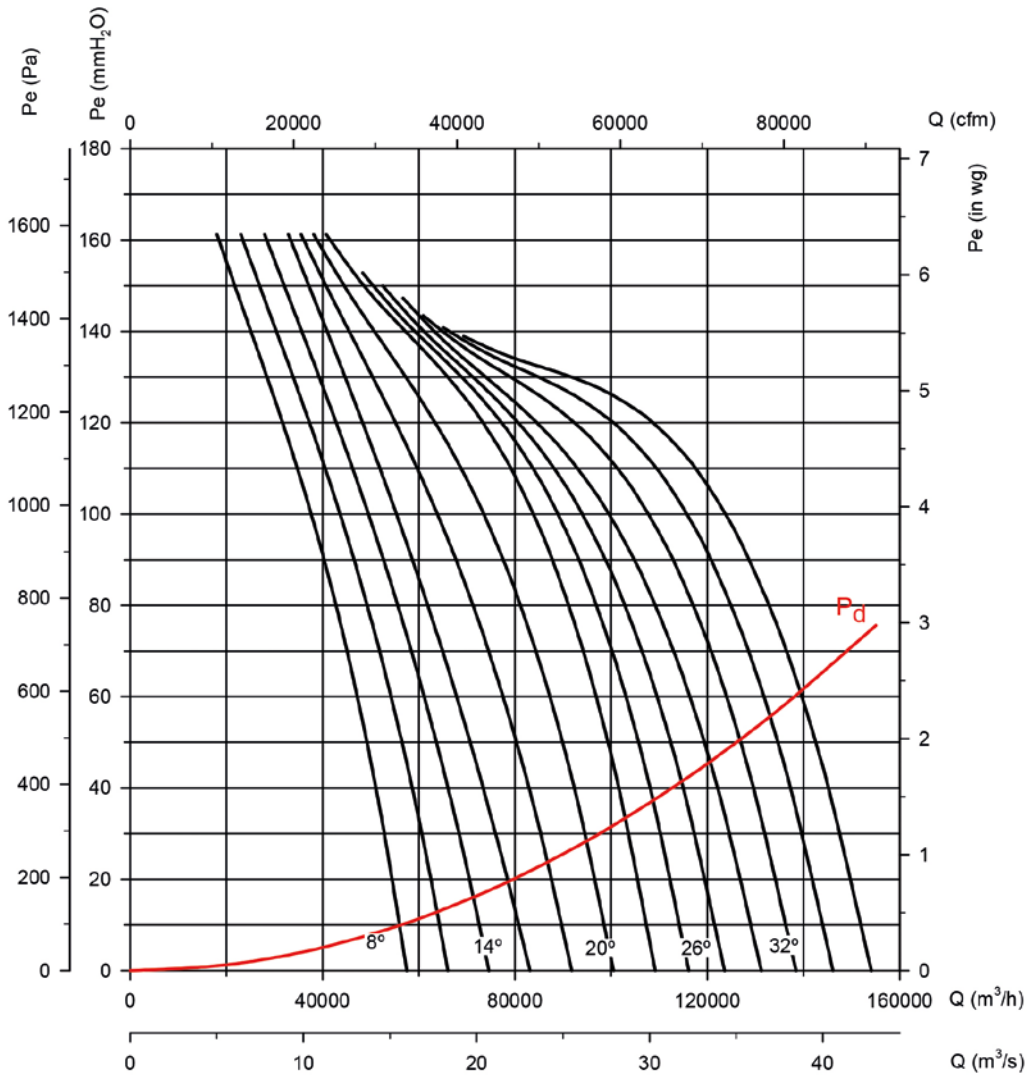

Absorbed power

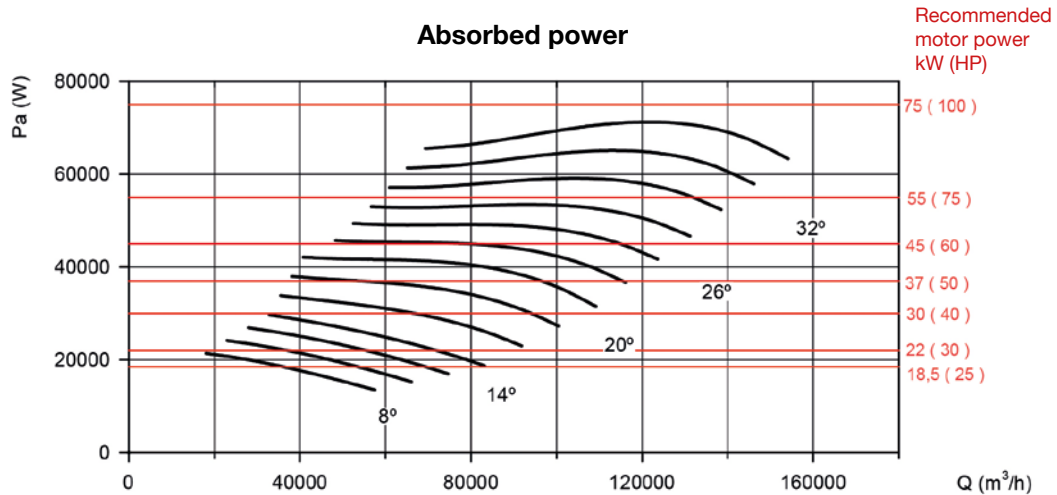

Characteristic curves

Q= Flow rate in m³/h, m³/s and cfm Pe= Static pressure in mm H₂O, Pa and inwg

Impeller diameter in cm: 125

Number of motor poles: 6

Number of blades: 6

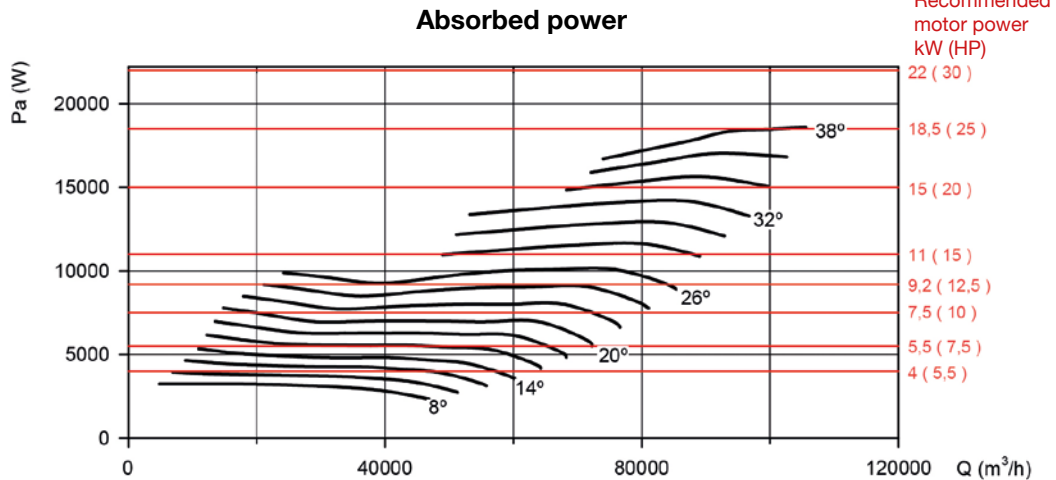
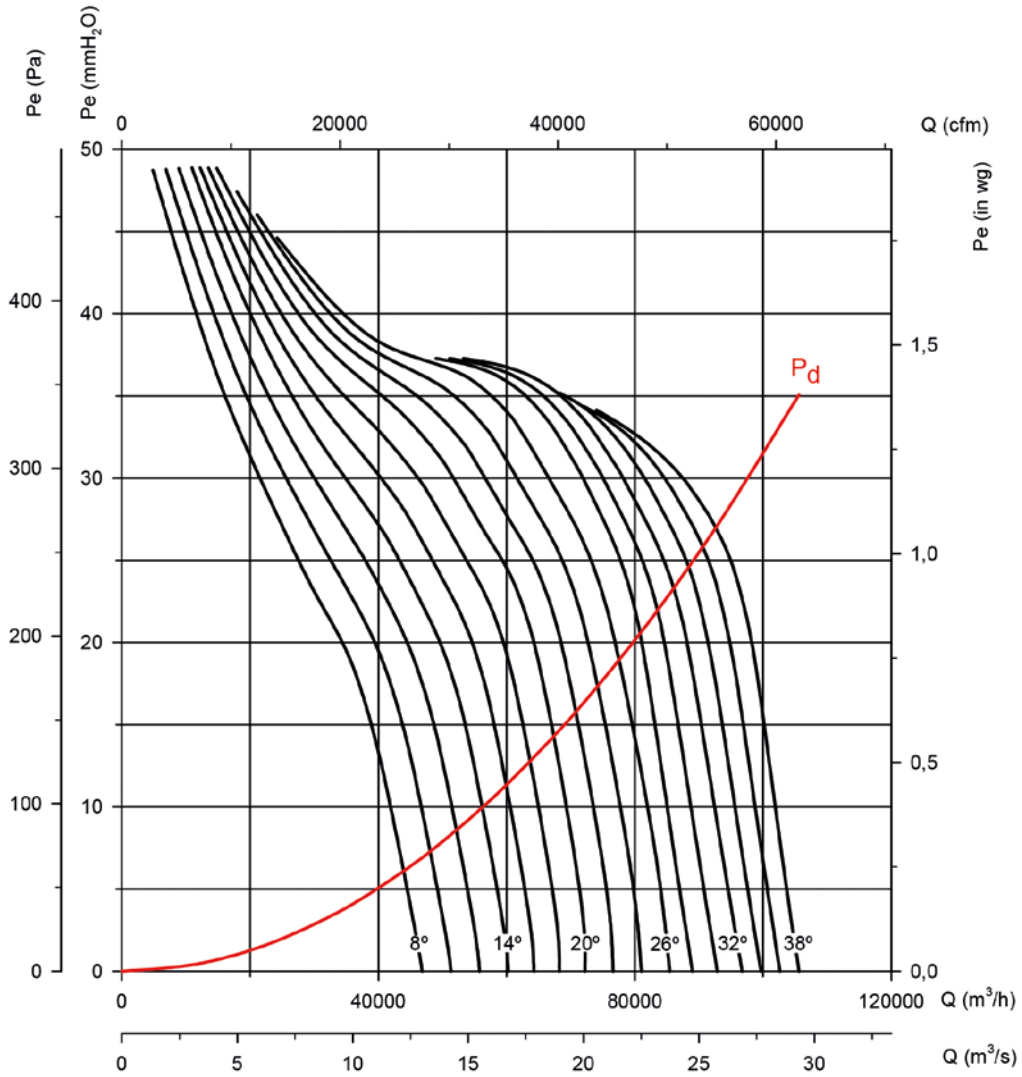

Characteristic curves

Q= Flow rate in m³/h, m³/s and cfm

Pe= Static pressure in mm H₂O, Pa and inwg

Impeller diameter in cm: 125

Number of motor poles: 6

Number of blades: 9

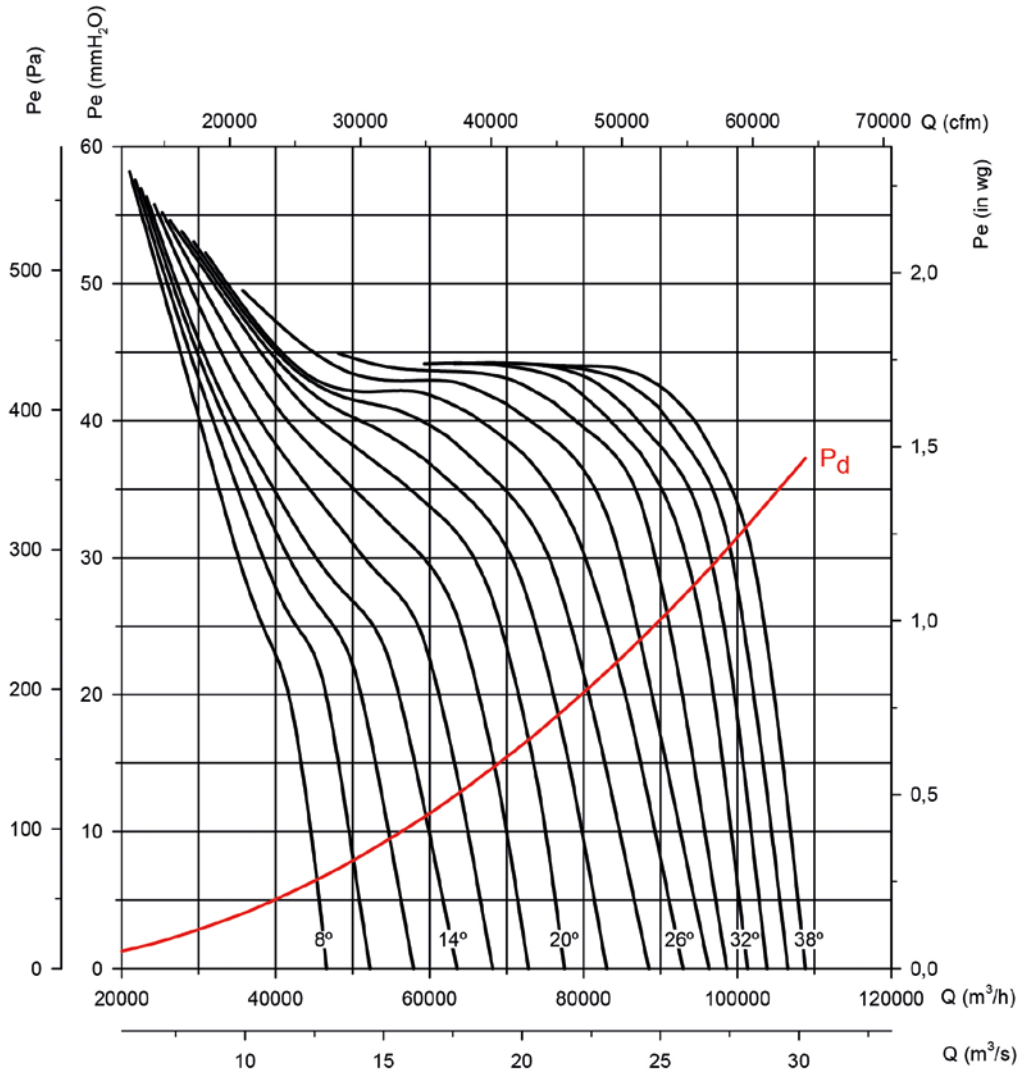

Absorbed power

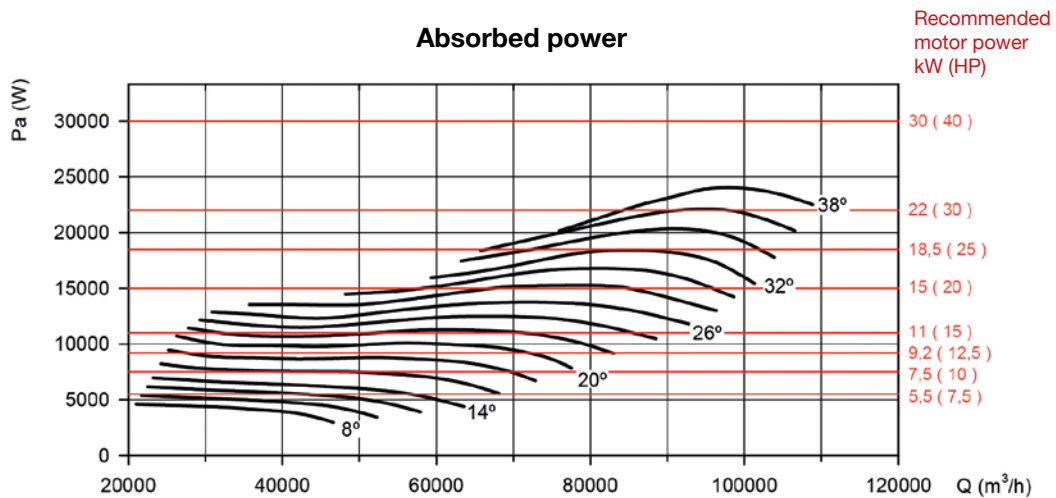

Characteristic curves

Q= Flow rate in m³/h, m³/s and cfm Pe= Static pressure in mm H₂O, Pa and inwg

Impeller diameter in cm: 125

Number of motor poles: 6

Number of blades: 12

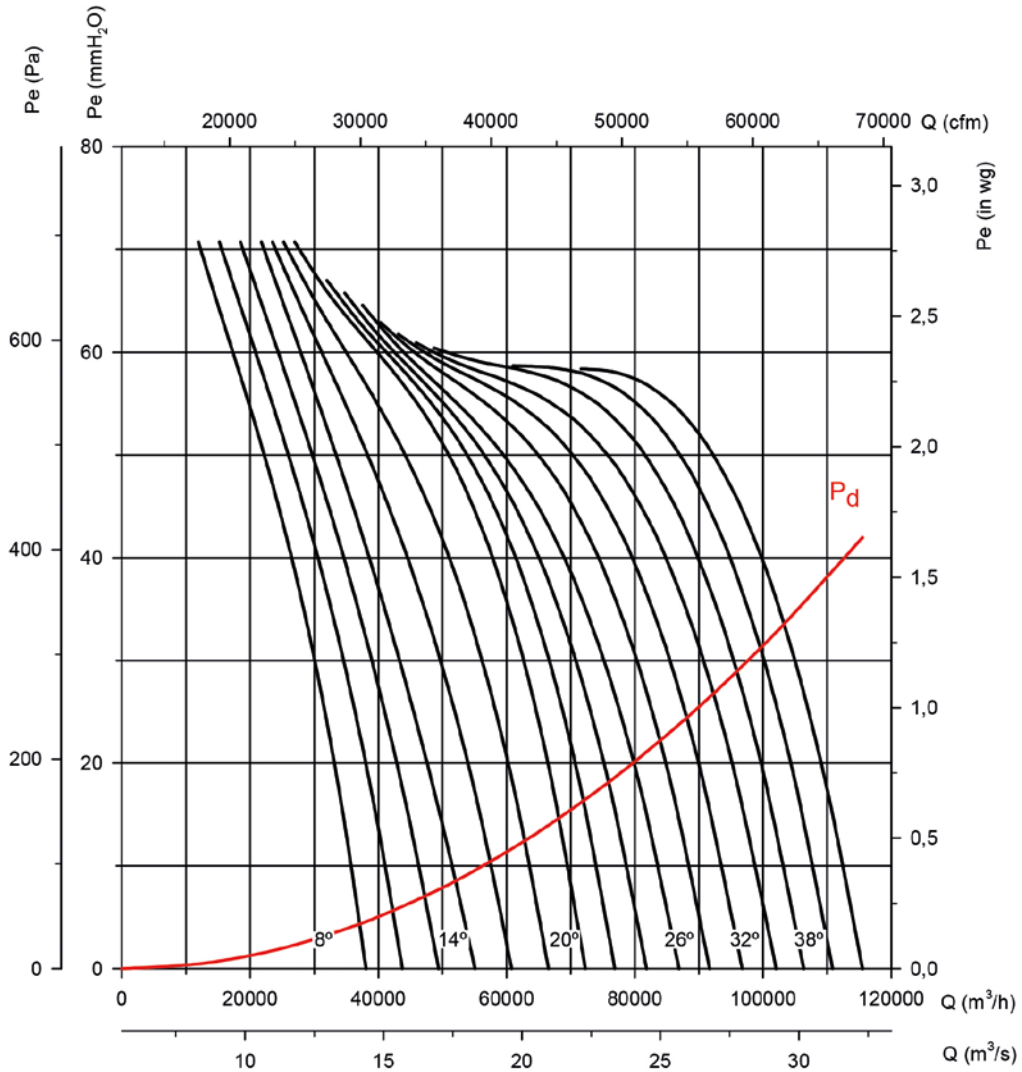

Absorbed power

Recommended motor power kW (HP)

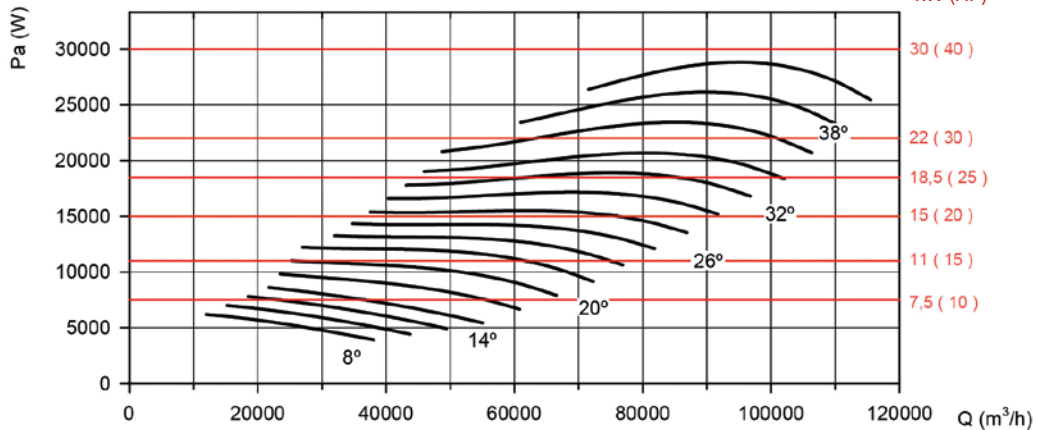

Characteristic curves

Q= Flow rate in m³/h, m³/s and cfm Pe= Static pressure in mm H₂O, Pa and inwg

Impeller diameter in cm: 140

Number of motor poles: 6

Number of blades: 6

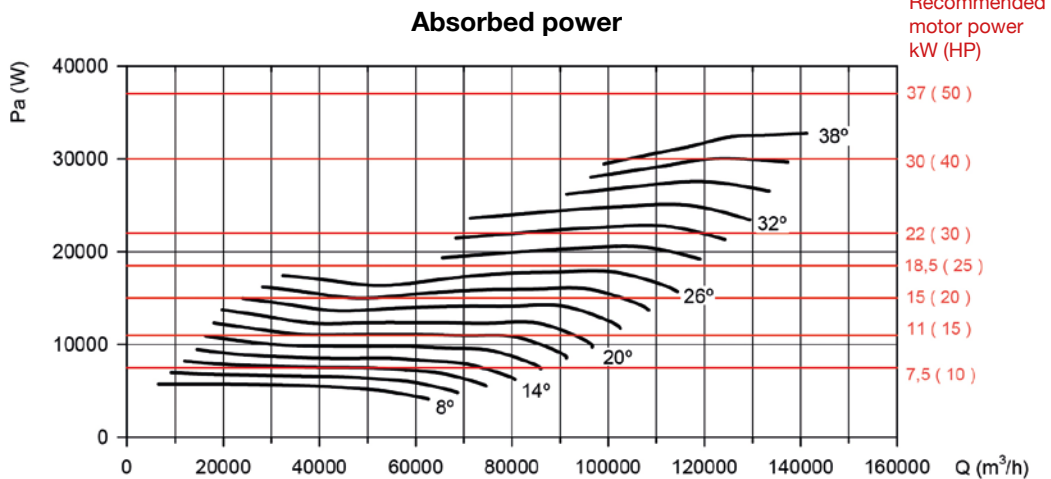
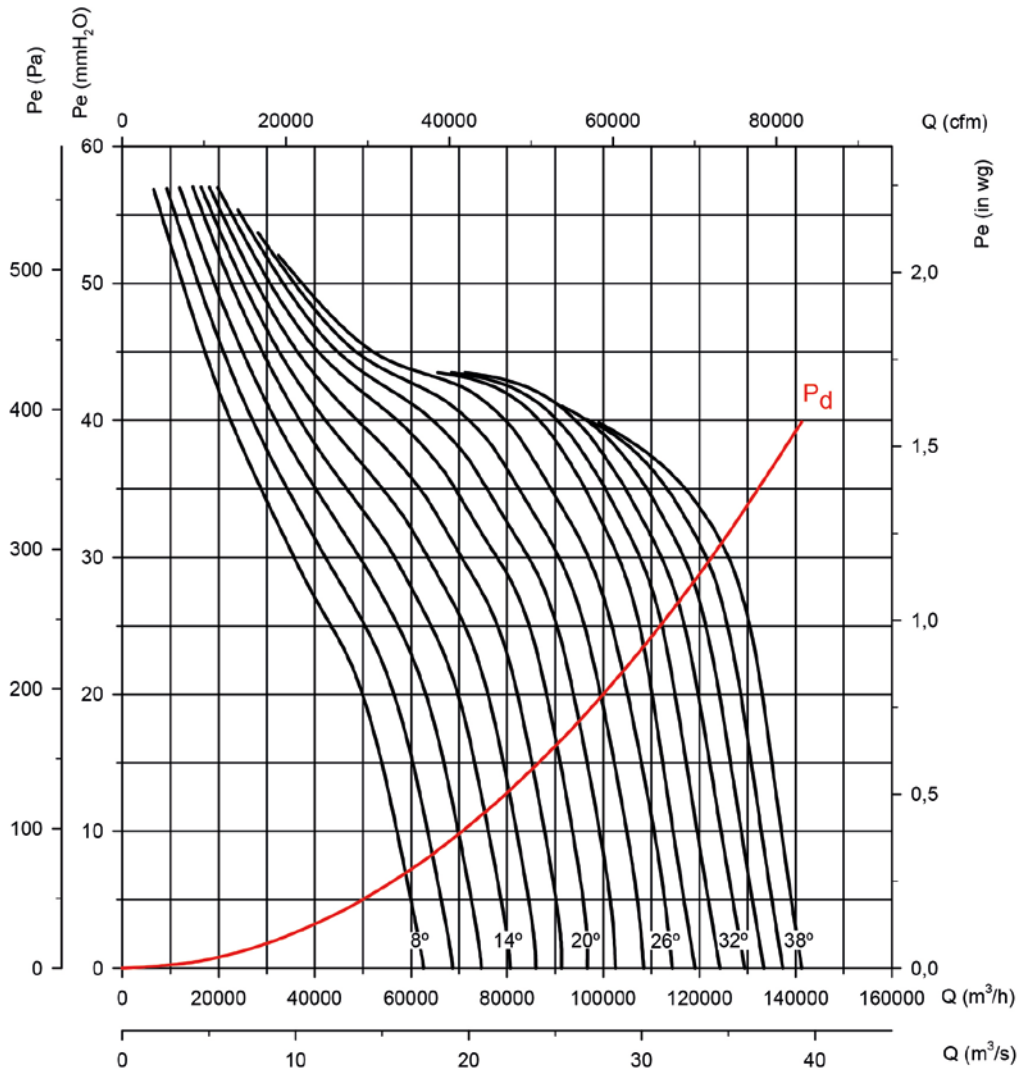

Characteristic curves

Q= Flow rate in m³/h, m³/s and cfm Pe= Static pressure in mm H₂O, Pa and inwg

Impeller diameter in cm: 140

Number of motor poles: 6

Number of blades: 9

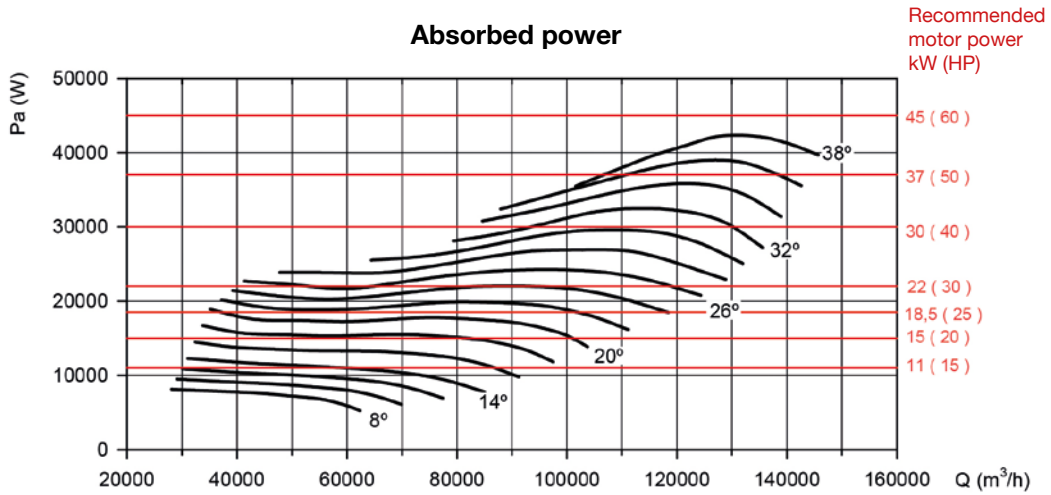
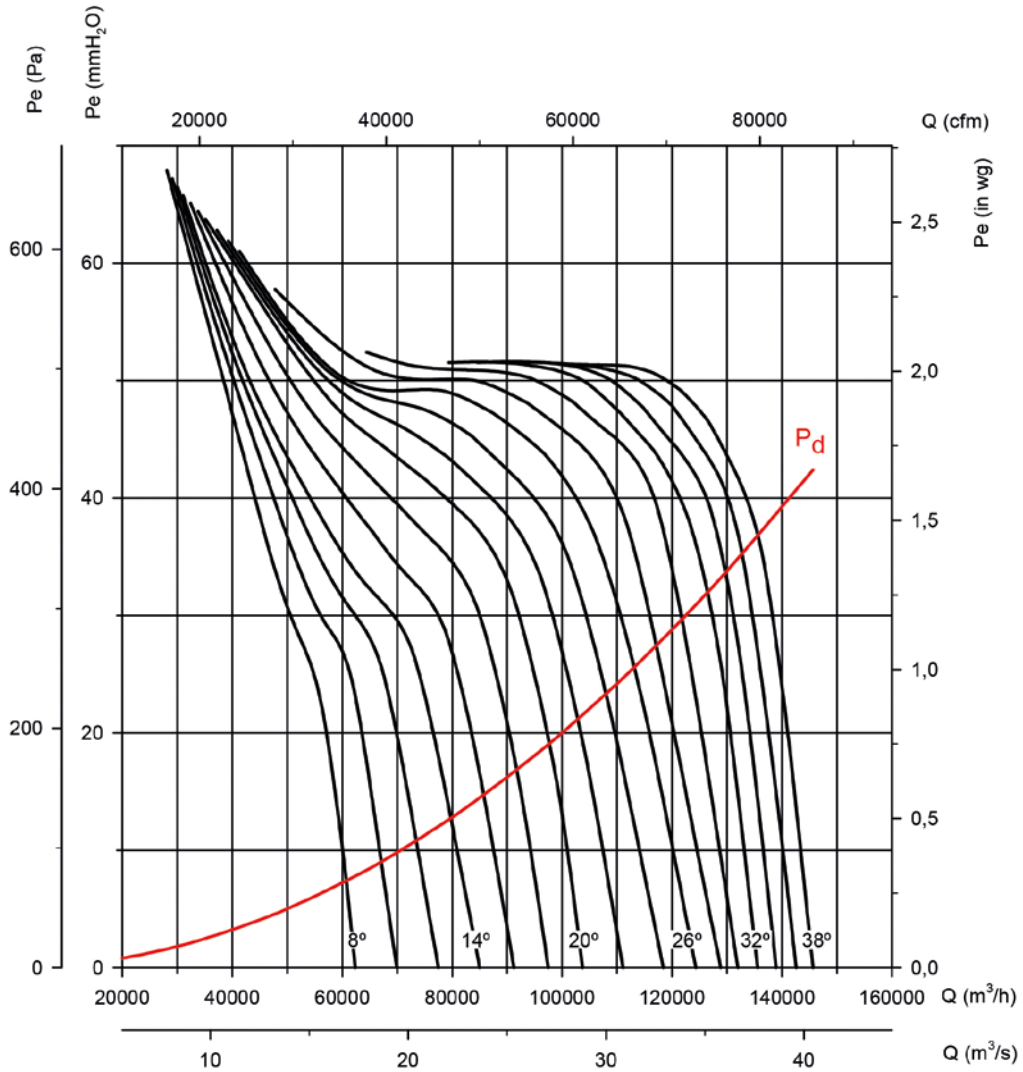

Characteristic curves

Q= Flow rate in m³/h, m³/s and cfm

Pe= Static pressure in mm H₂O, Pa and inwg

Impeller diameter in cm: 140

Number of motor poles: 6

Number of blades: 12

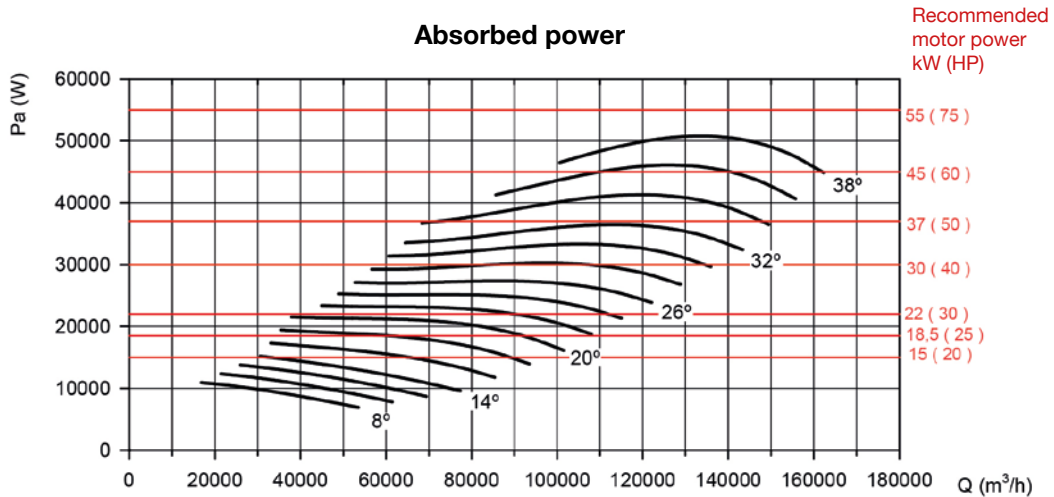
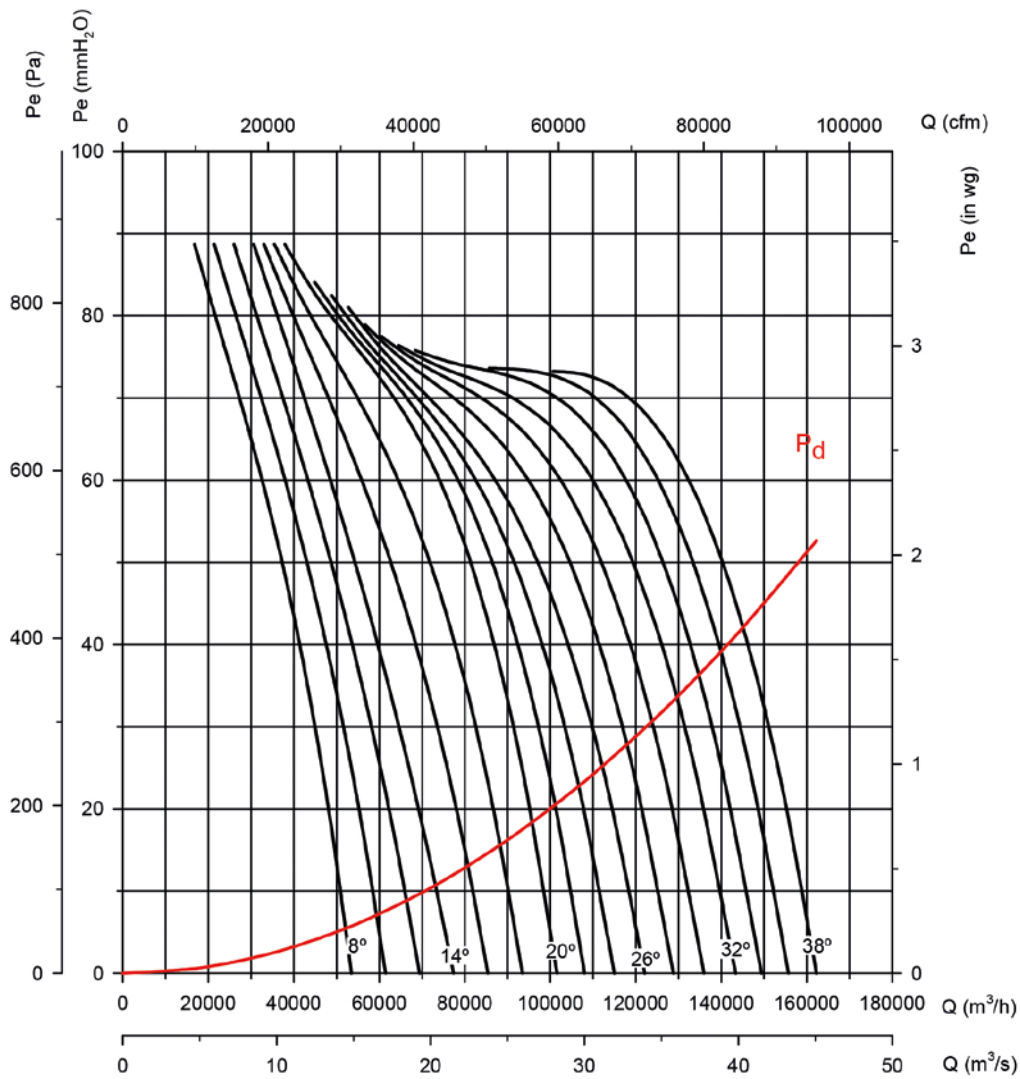

Characteristic curves

Q= Flow rate in m³/h, m³/s and cfm Pe= Static pressure in mm H₂O, Pa and inwg

Impeller diameter in cm: 160

Number of motor poles: 6

Number of blades: 6

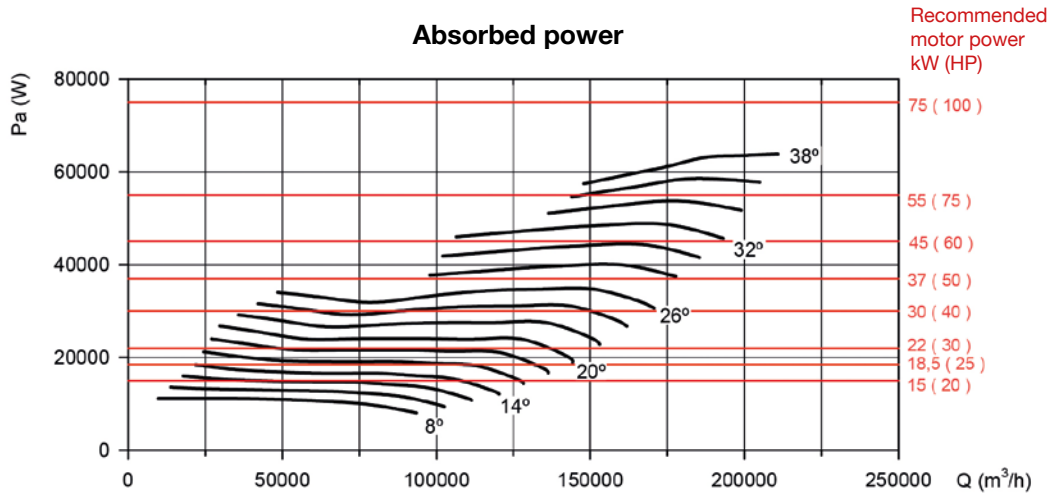
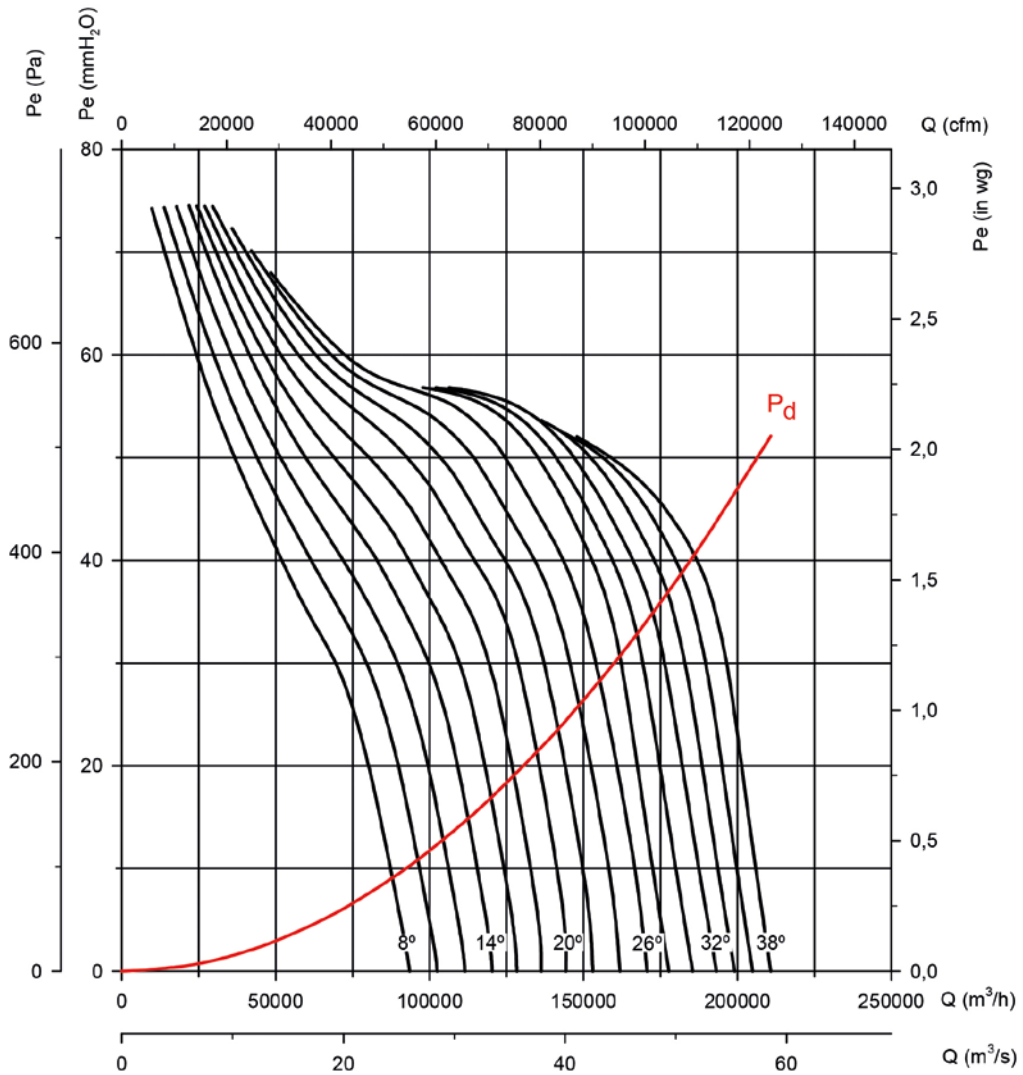

Characteristic curves

Q= Flow rate in m³/h, m³/s and cfm Pe= Static pressure in mm H₂O, Pa and inwg

Impeller diameter in cm: 160

Number of motor poles: 6

Number of blades: 9

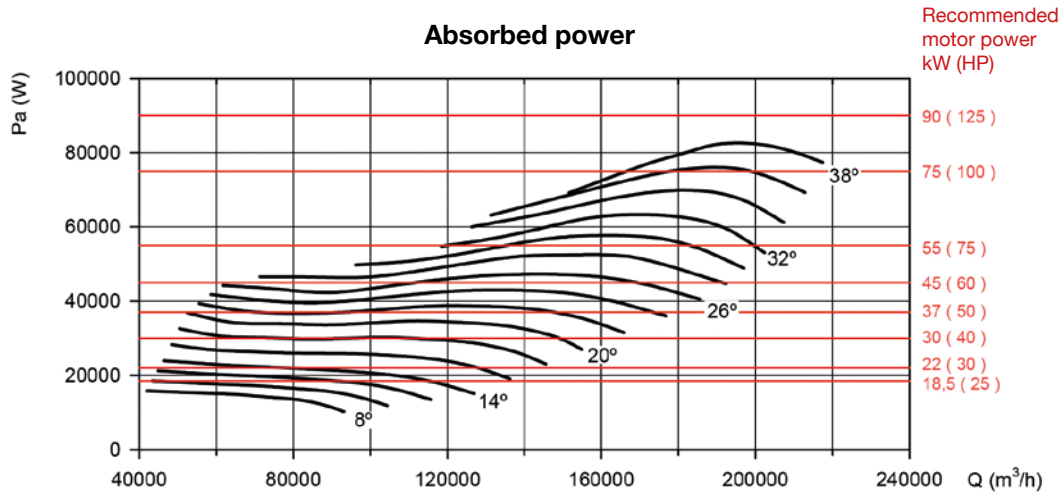
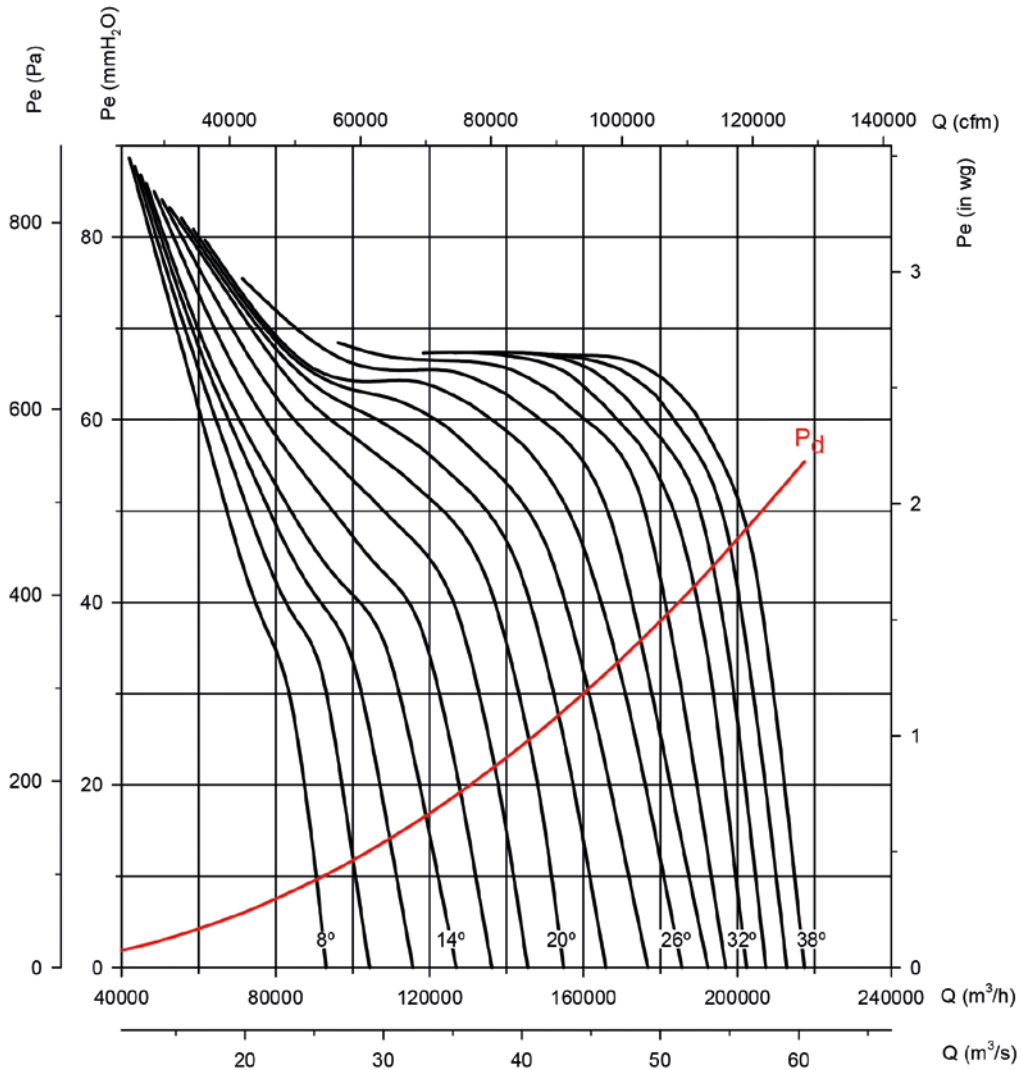

Characteristic curves

Q= Flow rate in m³/h, m³/s and cfm Pe= Static pressure in mm H₂O, Pa and inwg

Impeller diameter in cm: 160

Number of motor poles: 6

Number of blades: 12

