

# CMRS



**Extremely robust, medium pressure, single inlet centrifugal fans fitted with backward-curved impeller.**



**Fan:**

- Sheet steel casing.
- Impeller with reaction blades in extremely robust sheet steel, specially designed for transporting clean or slightly dusty air.
- Motor coupled directly.
- Fitted with inspection covers, except models 350, 400, 450, 500 and 560.

**Motor:**

- IE3 efficiency motors for powers equal to or greater than 0.75 kW except single-phase, 2-speed and 8-pole.
- Class F motors with ball bearings and IP55 protection.
- Three-phase 230/400 V - 50 Hz (up to 4 kW) and 400/690 V - 50 Hz (powers higher than 4 kW).
- Maximum temperature of air to be carried: -25 °C +120 °C.

**Finish:**

- Anti-corrosive finish of polyester resin polymerised at 190 °C, previously degreased with phosphate-free nanotechnological treatment.

**On request:**

- Special windings for different voltages.
- Fan prepared for air transmission of up to 250 °C.
- Stainless steel fan.
- ATEX-certified Category 2.
- System 8 elastic coupling.



Extremely robust, high performance reaction impeller

**Order code**

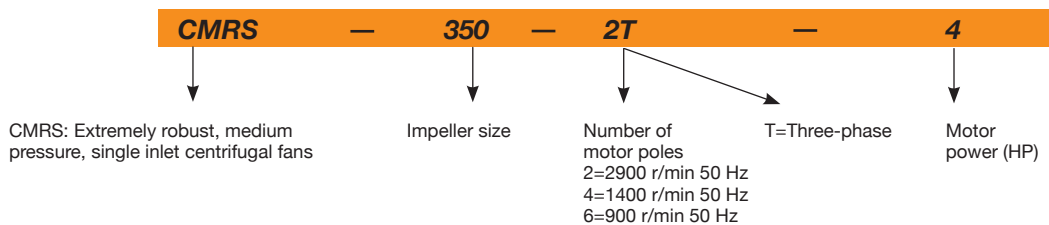

**Technical characteristics**

Model	Speed (r/min)	Max. admissible current (A)			Installed power (kW)	Maximum flow rate (m3/h)	Sound pressure level dB(A)	Approx. weight (kg)	According to ErP
		230 V	400 V	690 V					
CMRS-350-2T-4 IE3	2910	10.00	5.77		3	7750	77	81	2015
CMRS-350-4T-0.5	1380	1.84	1.06		0.37	3900	65	50	2015
CMRS-400-2T-5.5 IE3	2900	13.00	7.50		4	9700	79	101	2015
CMRS-400-2T-7.5 IE3	2930		10.10	5.86	5.5	12100	82	130	2015
CMRS-400-4T-0.75	1420	2.28	1.31		0.55	5400	67	69	2015
CMRS-450-2T-10 IE3	2935		13.90	8.06	7.5	13600	83	141	2015
CMRS-450-2T-15 IE3	2945		20.00	11.60	11	17200	84	198	2015
CMRS-450-4T-1 IE3	1420	2.82	1.62		0.75	6850	69	79	2015
CMRS-450-4T-1.5 IE3	1455	4.07	2.34		1.1	7700	70	88	2015
CMRS-500-2T-20 IE3	2945		27.70	16.10	15	19400	88	231	2015
CMRS-500-2T-25 IE3	2945		33.90	19.70	18.5	24300	89	250	2015
CMRS-500-4T-2 IE3	1440	5.41	3.11		1.5	9750	71	125	2015
CMRS-500-4T-3 IE3	1435	7.93	4.56		2.2	10850	72	130	2015
CMRS-500-6T-0.75	910	2.59	1.49		0.55	6900	61	107	2015
CMRS-560-4T-4 IE3	1440	10.70	6.15		3	13600	73	153	2015
CMRS-560-4T-5.5 IE3	1450	13.90	8.00		4	17300	73	162	2015
CMRS-560-6T-1 IE3	940	3.36	1.93		0.75	8650	62	132	2015
CMRS-560-6T-1.5 IE3	945	4.68	2.69		1.1	9650	65	141	2015
CMRS-630-4T-7.5 IE3	1465		10.30	5.97	5.5	19100	75	216	2015

**Technical characteristics**

Model	Speed (r/min)	Max. admissible current (A)			Installed power (kW)	Maximum flow rate (m <sup>3</sup> /h)	Sound pressure level dB(A)	Approx. weight (kg)	According to ErP
		230 V	400 V	690 V					
CMRS-630-4T-10 IE3	1465		13.90	8.06	7.5	24600	75	227	2015
CMRS-630-6T-2 IE3	950	6.43	3.70		1.5	12200	66	171	2015
CMRS-630-6T-3 IE3	950	9.08	5.22		2.2	15350	68	181	2015
CMRS-710-4T-15 IE3	1470		20.90	12.10	11	27550	78	352	2015
CMRS-710-4T-20 IE3	1465		27.90	16.20	15	34900	78	377	2015
CMRS-710-6T-4 IE3	970	12.00	6.91		3	17200	70	276	2015
CMRS-710-6T-5.5 IE3	960	15.60	8.99		4	21700	71	285	2015
CMRS-800-4T-25 IE3	1470		35.10	20.30	18.5	38250	81	480	2015
CMRS-800-4T-30 IE3	1470		41.00	23.80	22	48250	83	503	2015
CMRS-800-6T-7.5 IE3	970		11.20	6.49	5.5	24400	74	359	2015
CMRS-800-6T-10 IE3	975		14.80	8.58	7.5	30900	74	412	2015
CMRS-900-4T-50 IE3	1480		66.80	38.70	37	54300	85	810	2015
CMRS-900-4T-60 IE3	1475		80.90	46.90	45	69550	85	849	2015
CMRS-900-6T-15 IE3	975		21.90	12.70	11	34650	76	521	2015
CMRS-900-6T-20 IE3	975		28.20	16.30	15	42600	76	583	2015
CMRS-1000-4T-75 IE3	1480		98.60	57.20	55	76650	87	1082	2015
CMRS-1000-4T-100 IE3	1485		134.00	77.70	75	96150	88	1319	2015
CMRS-1000-6T-25 IE3	980		35.90	20.80	18.5	48750	77	783	2015
CMRS-1000-6T-30 IE3	980		42.40	24.60	22	61800	78	810	2015
CMRS-1120-6T-40 IE3	985		55.40	32.10	30	71500	80	1081	2015
CMRS-1120-6T-50 IE3	985		67.20	39.00	37	85950	80	1261	2015
CMRS-1250-6T-75 IE3	985		103.00	59.70	55	98300	83	1618	2015
CMRS-1250-6T-100 IE3	990		139.00	80.60	75	121200	84	1947	2015
CMRS-1400-6T-125 IE3	990		165.00	95.70	90	142150	87	2328	2015
CMRS-1400-6T-150 IE3	990		201.00	117.00	110	173400	88	2476	2015

**Erp. (Energy Related Products)**

Information on Directive 2009/125/EC can be downloaded from the SODECA website or the QuickFan selector programme.

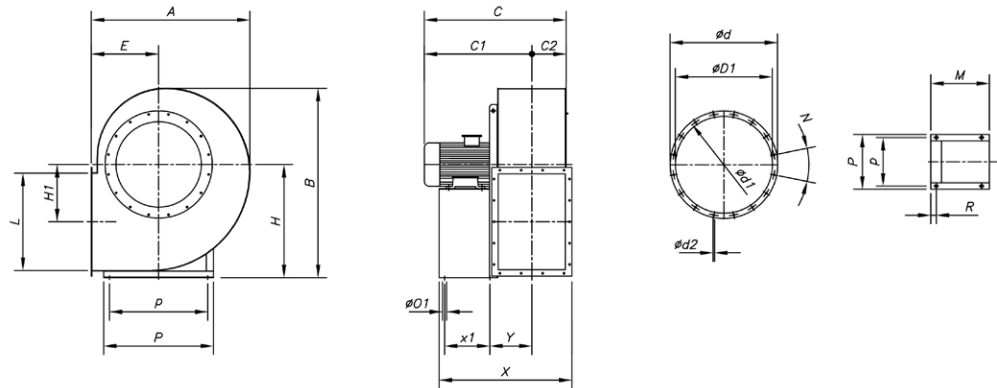
**Dimensions mm**
**CMRS-350...500**

	A	B	C	C1	C2	ØD1	Ød	Ød1	Ød2	N	E	H	H1	L	M	R	Ø01	P	p	X	x1	Y
CMRS-350-2T-4	592	743	591	459	132	360	434	405	12	8x45°	255	450	215	365	295	23	12	324	289	596	249	156
CMRS-350-4T-0.5	592	743	488	356	132	360	434	405	12	8x45°	255	450	215	365	220	14	10	225	203	521	156	183
CMRS-400-2T-5.5	666	824	638	490	148	405	491	448	12	8x45°	285	500	242	408	310	23	12	324	289	643	264	172
CMRS-400-2T-7.5	666	824	667	519	148	405	491	448	12	8x45°	285	500	243	408	360	23	12	372	337	693	314	172
CMRS-400-4T-0.75	666	824	537	389	148	405	491	448	12	8x45°	285	500	243	408	225	14	10	225	203	558	166	194
CMRS-450-2T-10	753	922	741	576	165	455	524	497	12	12x30°	320	560	273	457	360	23	12	372	337	728	314	190
CMRS-450-2T-15	753	922	804	639	165	455	524	497	12	12x30°	320	560	273	457	470	28	14	440	395	838	414	195
CMRS-450-4T-1	753	922	572	407	165	455	524	497	12	12x30°	320	560	273	457	225	14	10	225	203	593	166	212
CMRS-450-4T-1.5	753	922	597	432	165	455	524	497	12	12x30°	320	560	273	457	260	17	10	260	234	628	183	227
CMRS-500-2T-20	831	1008	845	660	185	505	580	551	12	12x30°	360	600	301	511	465	28	14	440	395	872	414	210
CMRS-500-2T-25	831	1008	944	759	185	505	580	551	12	12x30°	360	600	301	511	465	28	14	440	395	872	414	210
CMRS-500-4T-2	831	1008	636	451	185	505	580	551	12	12x30°	360	600	301	511	260	17	10	260	234	667	183	247
CMRS-500-4T-3	831	1008	697	512	185	505	580	551	12	12x30°	360	600	301	511	295	23	12	324	289	702	249	210
CMRS-500-6T-0.75	831	1008	611	426	185	505	580	551	12	12x30°	360	600	301	511	225	14	10	225	203	632	166	232

### Dimensions mm

#### CMRS-560...900

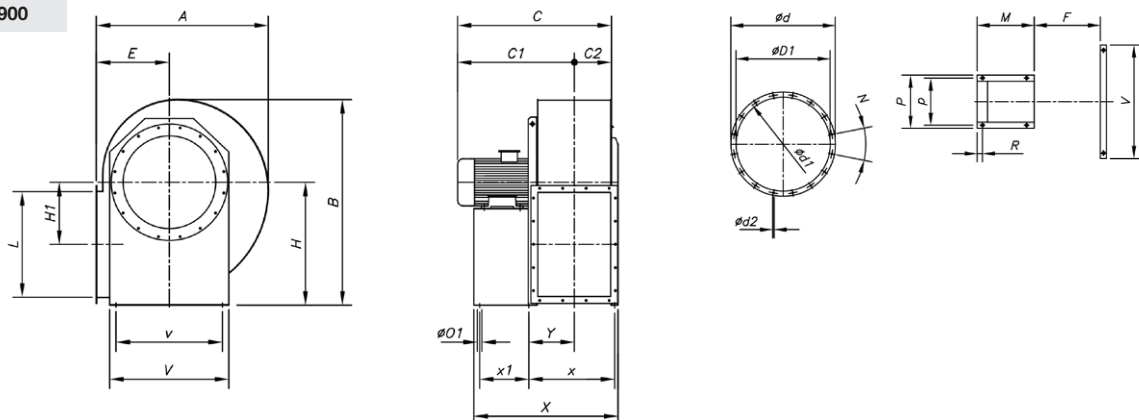

	A	B	C	C1	C2	ØD1	Ød	Ød1	Ød2	N	E	H	H1	L	F	M	R	ØO1	P	p	V	v	X	x	x1	Y
CMRS-560-4T-4	937	1138	742	534	208	565	658	629	12	12x30°	400	670	331	573	412	295	23	12	324	289	690	632	737	452	249	231
CMRS-560-4T-5.5	937	1138	757	549	208	565	658	629	12	12x30°	400	670	331	573	412	310	23	12	324	289	690	632	752	452	264	231
CMRS-560-6T-1	937	1138	681	473	208	565	658	629	12	12x30°	400	670	331	573	412	260	17	10	260	234	690	632	702	489	183	268
CMRS-560-6T-1.5	937	1138	681	473	208	565	658	629	12	12x30°	400	670	331	573	412	260	17	10	260	234	690	632	702	489	183	268
CMRS-630-4T-7.5	1053	1279	877	643	234	635	738	698	12	12x30°	450	750	374	644	462	360	23	12	372	337	780	702	862	507	314	256
CMRS-630-4T-10	1053	1279	941	707	234	635	738	698	12	12x30°	450	750	374	644	462	360	23	12	372	337	780	702	862	507	314	256
CMRS-630-6T-2	1053	1279	793	559	234	635	738	698	12	12x30°	450	750	374	644	462	295	23	12	324	289	780	702	797	507	249	256
CMRS-630-6T-3	1053	1279	808	574	234	635	738	698	12	12x30°	450	750	374	644	462	310	23	12	324	289	780	702	812	507	264	256
CMRS-710-4T-15	1177	1435	992	732	260	715	825	775	14	16x22°30'	500	850	431	719	511	477	39	19	836	734	884	772	1053	612	372	321
CMRS-710-4T-20	1177	1435	1091	831	260	715	825	775	14	16x22°30'	500	850	431	719	511	477	39	19	836	734	884	772	1053	612	372	321
CMRS-710-6T-4	1177	1435	927	667	260	715	825	775	14	16x22°30'	500	850	431	719	511	368	39	19	836	734	884	772	944	612	263	321
CMRS-710-6T-5.5	1177	1435	991	731	260	715	825	775	14	16x22°30'	500	850	431	719	511	368	39	19	836	734	884	772	944	612	263	321
CMRS-800-4T-25	1312	1592	1136	844	292	805	920	861	14	16x22°30'	560	950	482	808	574	543	39	19	926	862	965	862	1184	675	441	353
CMRS-800-4T-30	1312	1592	1174	882	292	805	920	861	14	16x22°30'	560	950	482	808	574	543	39	19	926	862	965	862	1184	675	441	353
CMRS-800-6T-7.5	1312	1592	1055	763	292	805	920	861	14	16x22°30'	560	950	482	808	574	365	39	19	926	862	965	862	1006	675	263	353
CMRS-800-6T-10	1312	1592	1055	763	292	805	920	861	14	16x22°30'	560	950	482	808	574	474	39	19	926	862	965	862	1115	675	372	353
CMRS-900-4T-50	1472	1777	1390	1063	327	905	1015	958	14	16x22°30'	630	1060	543	905	643	540	39	19	1026	962	1095	962	1270	738	441	384
CMRS-900-4T-60	1472	1777	1390	1063	327	905	1015	958	14	16x22°30'	630	1060	543	905	643	540	39	19	1026	962	1095	962	1270	738	441	384
CMRS-900-6T-15	1472	1777	1223	896	327	905	1015	958	14	16x22°30'	630	1060	543	905	643	471	39	19	1026	962	1095	962	1201	738	372	384
CMRS-900-6T-20	1472	1777	1243	916	327	905	1015	958	14	16x22°30'	630	1060	543	905	643	540	39	19	1026	962	1095	962	1270	738	441	384

#### CMRS-1000...1400

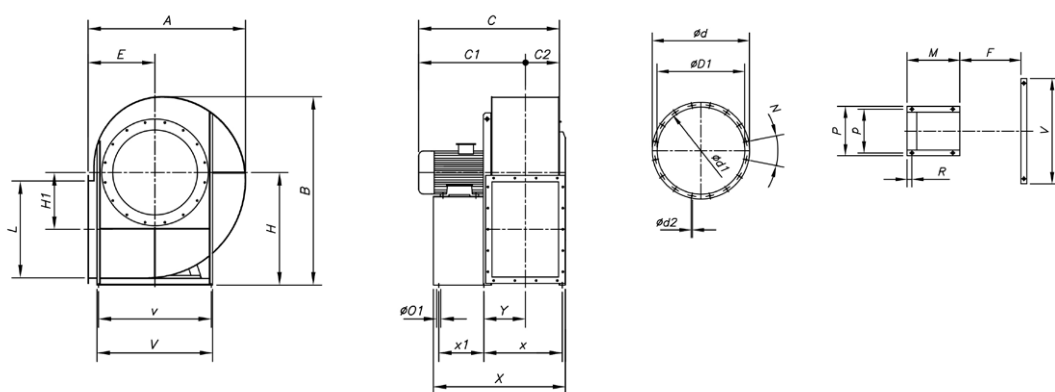

	A	B	C	C1	C2	ØD1	Ød	Ød1	Ød2	N	E	H	H1	L	F	M	R	ØO1	P	p	V	v	X	x	x1	Y
CMRS-1000-4T-75	1657	1987	1490	1127	363	1007	1115	1067	15	24x15°	710	1180	610	1014	721	600	45	19	1128	1056	1225	1056	1401	816	500	415
CMRS-1000-4T-100	1657	1987	1647	1284	363	1007	1115	1067	15	24x15°	710	1180	610	1014	721	690	45	19	1128	1056	1225	1056	1491	816	590	415
CMRS-1000-6T-25	1657	1987	1380	1017	363	1007	1115	1067	15	24x15°	710	1180	610	1014	721	500	45	19	1128	1056	1225	1056	1301	816	400	415
CMRS-1000-6T-30	1657	1987	1380	1017	363	1007	1115	1067	15	24x15°	710	1180	610	1014	721	500	45	19	1128	1056	1225	1056	1301	816	400	415
CMRS-1120-6T-40	1850	2220	1543	1141	402	1130	1250	1200	15	24x15°	800	1320	684	1130	801	550	44	20	1268	1178	1400	1178	1431	896	441	466
CMRS-1120-6T-50	1850	2220	1647	1245	402	1130	1250	1200	15	24x15°	800	1320	684	1130	801	600	45	20	1268	1178	1400	1178	1481	911	475	481
CMRS-1250-6T-75	2100	2535	1833	1381	452	1260	1380	1337	15	24x15°	900	1500	770	1267	898	690	45	20	1400	1310	1530	1310	1668	1023	565	529
CMRS-1250-6T-100	2100	2535	1927	1475	452	1260	1380	1337	15	24x15°	900	1500	770	1267	898	800	45	20	1400	1310	1530	1310	1778	1008	675	529
CMRS-1400-6T-125	2305	2815	2178	1672	506	1410	1530	1491	13	32x11°15'	1000	1700	854	1421	1006	800	60	24	1530	1450	1690	1450	1906	1152	640	603
CMRS-1400-6T-150	2305	2815	2178	1672	506	1410	1530	1491	13	32x11°15'	1000	1700	854	1421	1006	800	60	24	1530	1450	1690	1450	1906	1152	640	603

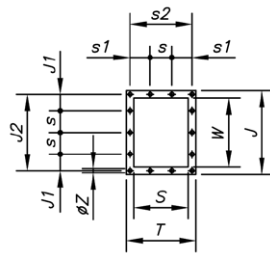
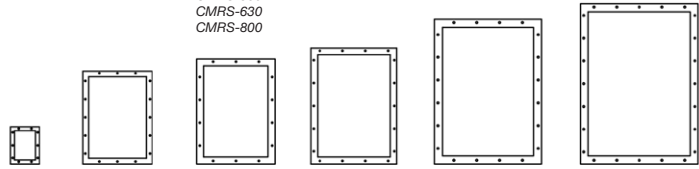
**Dimensions mm**
**Outlet nozzle**

 CMRS-350    CMRS-710    CMRS-400  
 CMRS-450    CMRS-900    CMRS-1120  
 CMRS-500    CMRS-1000  
 CMRS-560    CMRS-1250  
 CMRS-630    CMRS-1400  
 CMRS-800

	T	J	J1	J2	S	s	s1	s2	W	ØZ
CMRS-350	336	441	77	405	260	125	87	300	365	12
CMRS-400	368	484	36	448	292	125	41	332	408	12
CMRS-450	402	533	61	497	326	125	58	366	457	12
CMRS-500	441	587	88	551	365	125	77	405	511	12
CMRS-560	504	669	74	629	412	160	72	464	573	14
CMRS-630	553	738	109	698	462	160	96	513	644	14
CMRS-710	607	815	67	775	511	160	123	567	719	14
CMRS-800	689	921	135	871	574	200	119	639	808	14
CMRS-900	758	1018	84	968	643	200	54	708	905	14
CMRS-1000	835	1127	138	1077	721	200	92	785	1014	14
CMRS-1120	941	1270	105	1210	801	200	140	881	1130	18
CMRS-1250	1038	1407	73	1347	898	200	89	978	1267	18
CMRS-1400	1147	1561	150	1501	1006	200	143	1087	1421	18

**Characteristic curves**

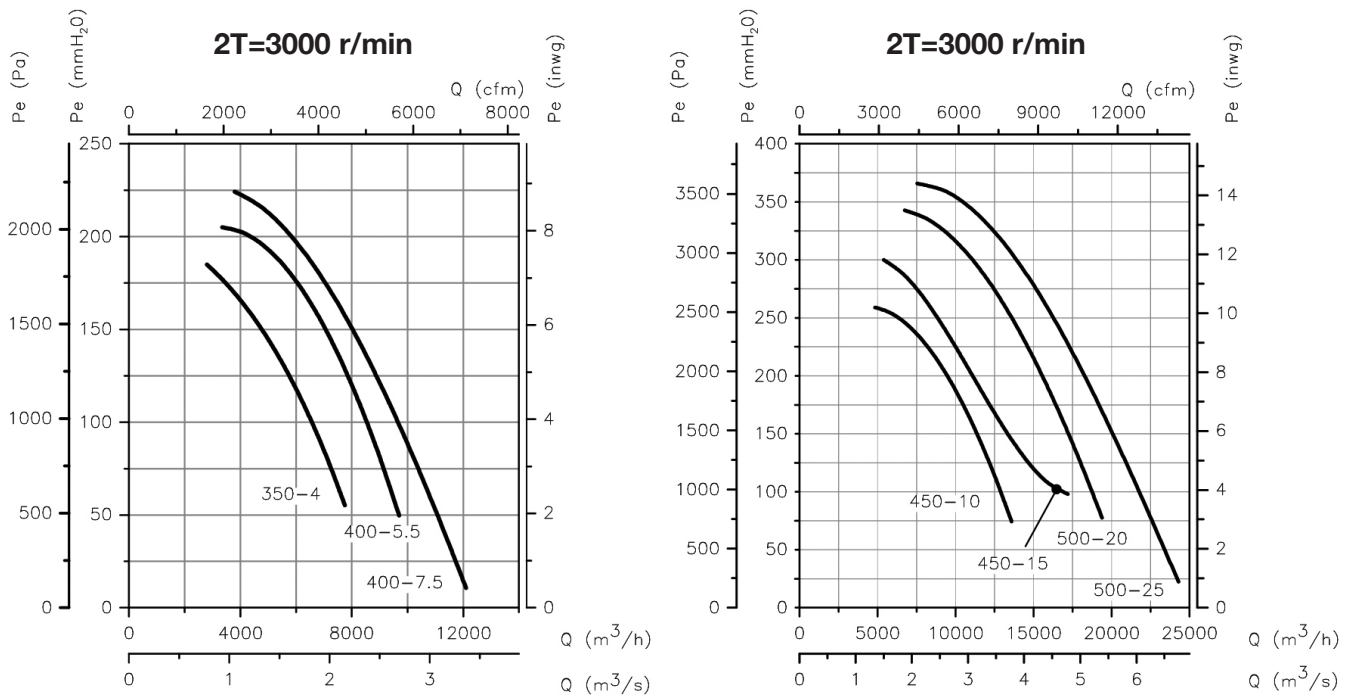
 Q= Flow rate in m<sup>3</sup>/h, m<sup>3</sup>/s and cfm

 Pe= Static pressure in mm H<sub>2</sub>O, Pa and inwg

**Characteristic curves**

Q= Flow rate in m<sup>3</sup>/h, m<sup>3</sup>/s and cfm

Pe= Static pressure in mm H<sub>2</sub>O, Pa and inwg

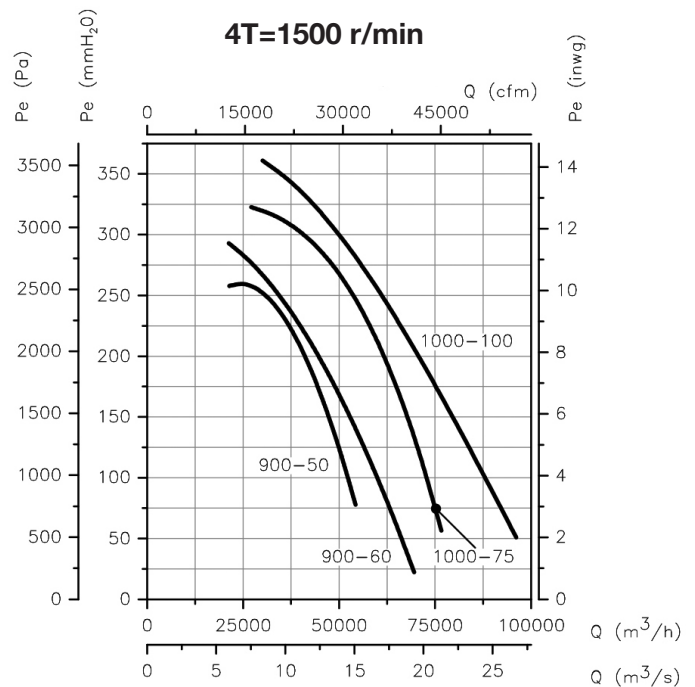
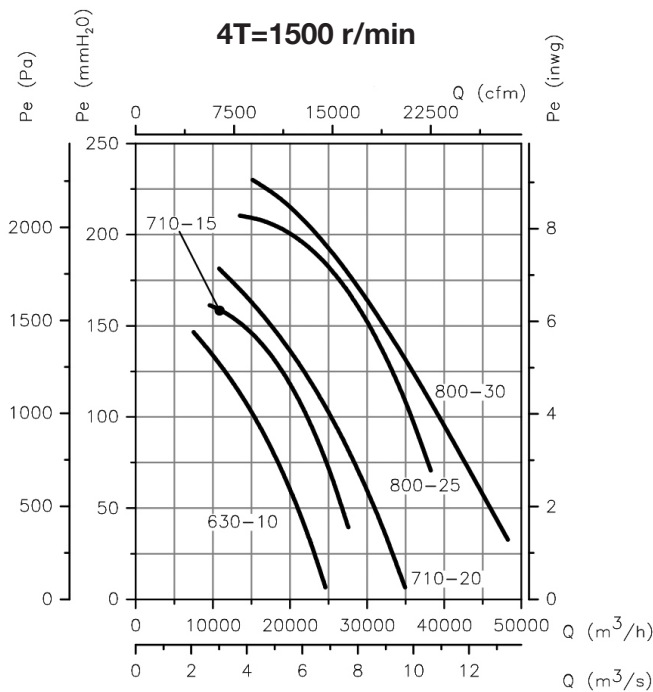
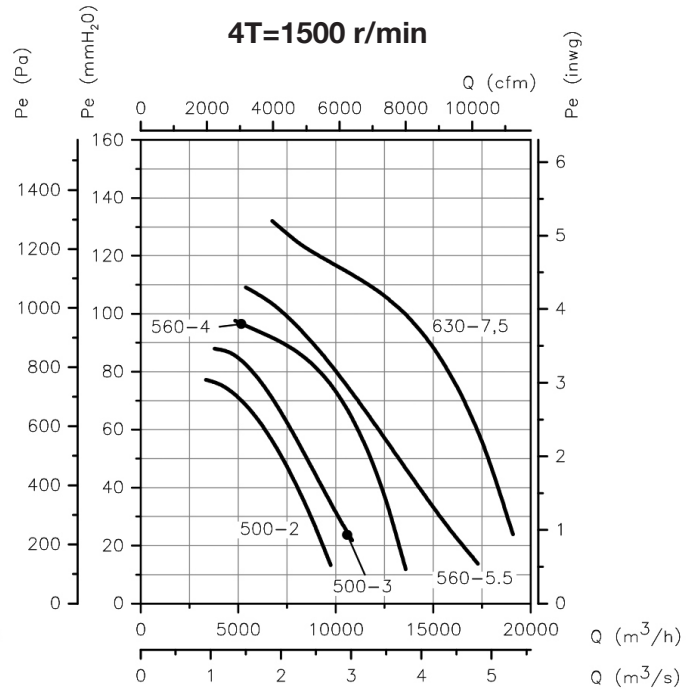
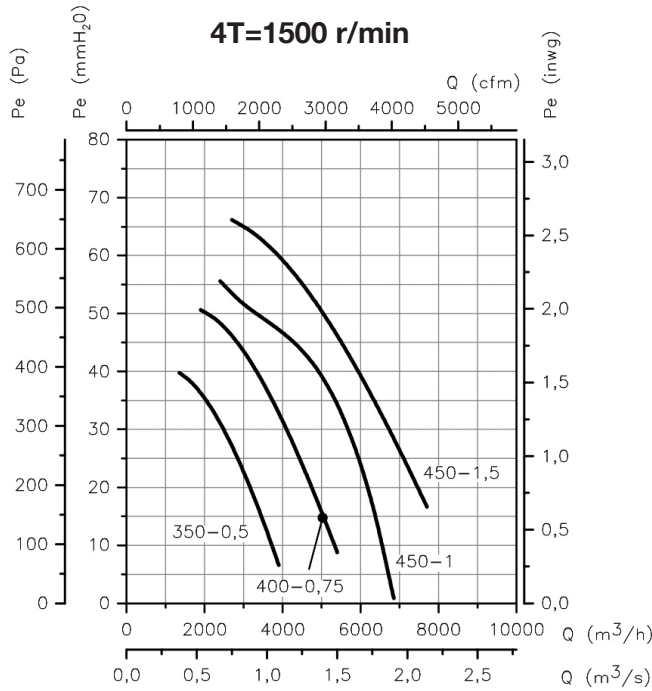

**Orientation**

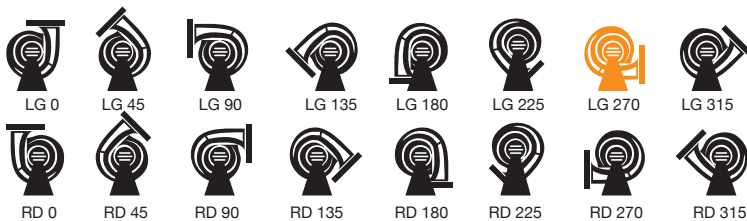

LG270 standard supply, other positions on request.  
Models 350 to 710 are adjustable.  
Special sizes in positions 180 and 225.  
Models 800 to 900 are adjustable.  
Special sizes except position 315.  
Models 1000 to 1400 are not adjustable.  
Special sizes except position 315.

**Characteristic curves**

 Q= Flow rate in m<sup>3</sup>/h, m<sup>3</sup>/s and cfm

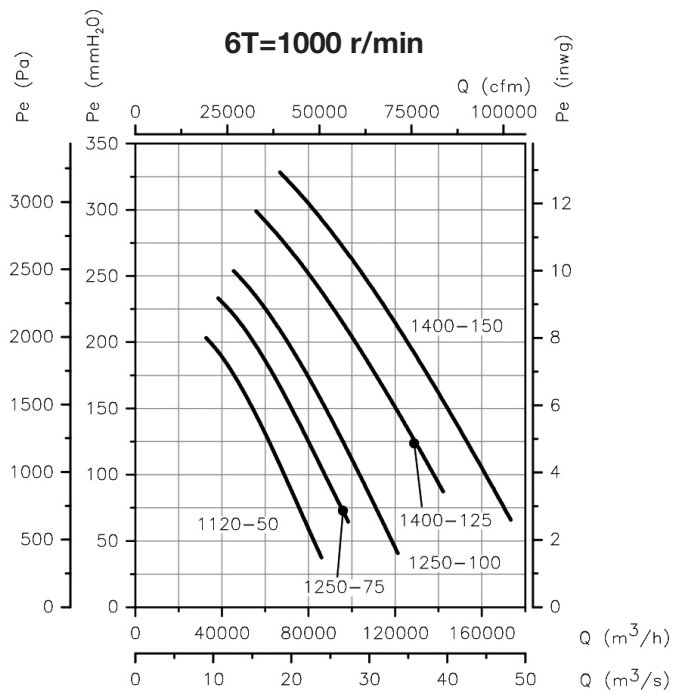
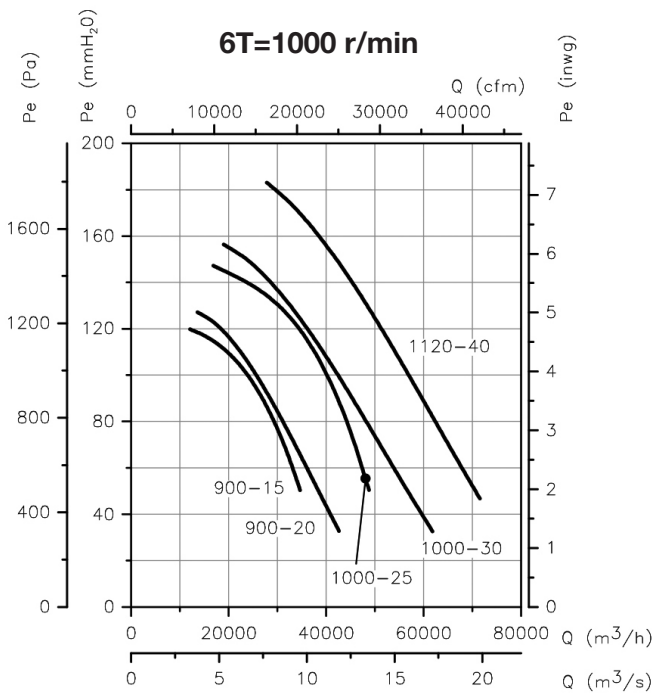
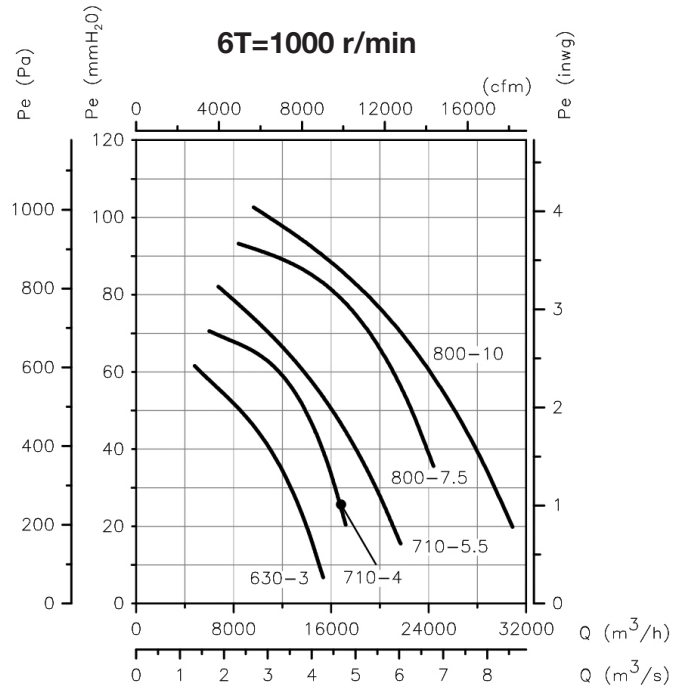
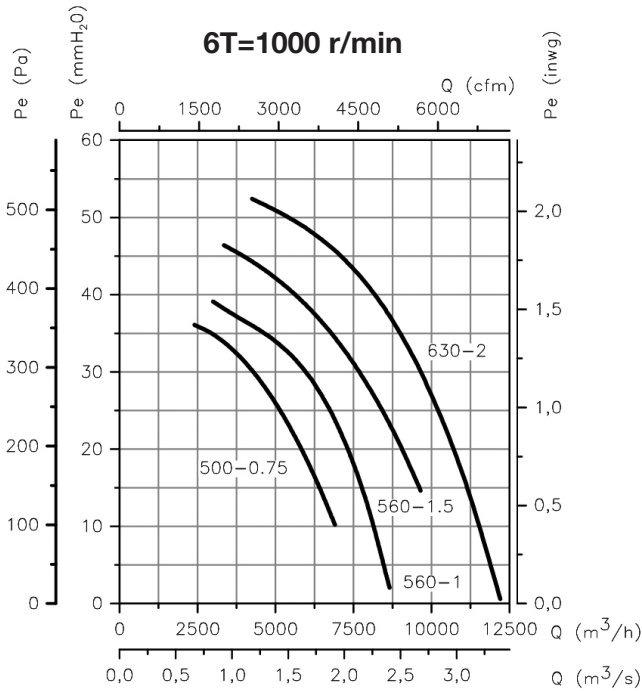
 Pe= Static pressure in mm H<sub>2</sub>O, Pa and inwg

**Accessories**

See accessories section.

