

# HTP

## High pressure tubular axial extract fans



High pressure impeller

Extremely robust, high pressure, tubular axial fans, specially designed for mining installations or in applications with large load losses.

### Fan:

- Extremely thick tubular sheet steel casing.
- Motor support welded to casing.
- High aerodynamic performance directives for pressure gains
- Optimal surface protection in high quality steel.
- High performance, cast aluminium impeller.
- Impeller to motor air direction.
- Electrical connection in external terminal box.

### Motor:

- IE3 efficiency motors for powers equal to or higher than 0.75kW except single-phase, 2-speed and 8-pole.

- Class F motors with ball bearings and IP55 protection.
- Three-phase 230/400V-50Hz (up to 4kW) and 400/690V-50Hz (powers higher than 4kW).
- Operating temperature -20°C +70°C.

### Finish:

- High protection anti-corrosive steel, special primer and high quality paint for corrosive atmospheres.

### On request:

- Standard IP55, ATEX and 2-speed motors.
- Made entirely of stainless steel.
- Made of hot dip galvanised steel.



### Order code

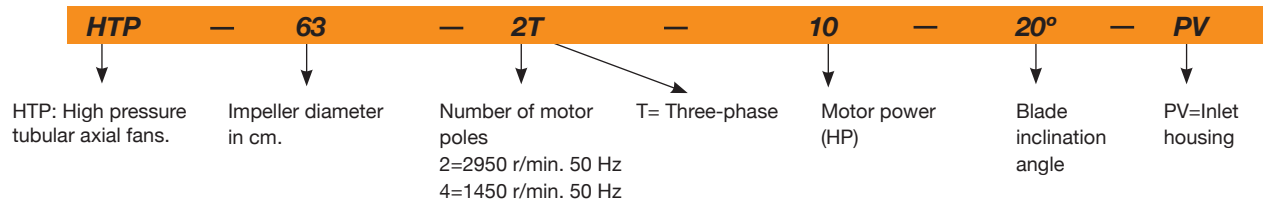

### Technical characteristics

Model	Speed (r/min)	Maximum admissible current (A)			Installed power (kW)	Maximum flow rate (m³/h)	Sound pressure level dB(A)	Approx. weight (kg)	According to ErP
		230V	400V	690V					
HTP-50-2T-4 IE3	2910	10.00	5.77		3.00	13850	86	49	2015
HTP-50-2T-5.5 IE3	2900	13.00	7.50		4.00	16450	92	65	2015
HTP-56-2T-5.5 IE3	2900	13.00	7.50		4.00	18050	97	69	2015
HTP-56-2T-10 IE3	2930		14.10	8.17	7.50	25500	89	143	2015
HTP-63-2T-10 IE3	2930		14.10	8.17	7.50	23850	94	128	2015
HTP-63-2T-15 IE3	2945		20.00	11.60	11.00	29400	94	199	2015
HTP-63-2T-20 IE3	2945		27.70	16.10	15.00	34400	97	205	2015
HTP-63-2T-25 IE3	2945		33.90	19.70	18.50	37200	98	216	2015
HTP-63-2T-30 IE3	2950		39.70	23.00	22.00	39800	99	208	2015
HTP-63-4T-1.5 IE3	1455	4.07	2.34		1.10	12850	83	92	2015
HTP-63-4T-2 IE3	1440	5.41	3.11		1.50	15650	87	93	2015
HTP-63-4T-3 IE3	1435	7.93	4.56		2.20	18600	84	101	2015
HTP-63-4T-4 IE3	1440	10.70	6.15		3.00	19900	89	104	2015
HTP-71-2T-15 IE3	2945		20.00	11.60	11.00	32850	93	216	2015
HTP-71-2T-20 IE3	2945		27.70	16.10	15.00	39250	95	222	2015
HTP-71-2T-25 IE3	2945		33.90	19.70	18.50	43450	95	233	2015
HTP-71-2T-30 IE3	2950		39.70	23.00	22.00	45500	95	225	2015
HTP-71-2T-40 IE3	2960		54.50	31.60	30.00	52550	98	333	2015
HTP-71-4T-2 IE3	1435	7.93	4.56		2.20	17500	84	110	2015
HTP-71-4T-3 IE3	1435	7.93	4.56		2.20	20650	84	118	2015
HTP-71-4T-4 IE3	1440	10.70	6.15		3.00	23950	89	121	2015

### Technical characteristics

Model	Speed (r/min)	Maximum admissible current (A)			Installed power (kW)	Maximum flow rate (m³/h)	Sound pressure level dB(A)	Approx. weight (kg)	According to ErP
		230V	400V	690V					
HTP-71-4T-5.5 IE3	1450	13.90	8.00		4.00	27400	89	127	2015
HTP-71-4T-7.5 IE3	1465		10.30	5.97	5.50	31700	113	141	2015
HTP-80-4T-4 IE3	1440	10.70	6.15		3.00	19300	91	146	2015
HTP-80-4T-5.5 IE3	1450	13.90	8.00		4.00	22850	88	152	2015
HTP-80-4T-7.5 IE3	1465		10.30	5.97	5.50	28000	109	166	2015
HTP-80-4T-10 IE3	1465		13.90	8.06	7.50	31500	87	193	2015
HTP-80-4T-15 IE3	1470		20.90	12.10	11.00	40000	91	242	2015
HTP-90-4T-7.5 IE3	1465		10.30	5.97	5.50	27450	113	196	2015
HTP-90-4T-10 IE3	1465		13.90	8.06	7.50	32500	90	223	2015
HTP-90-4T-15 IE3	1470		20.90	12.10	11.00	42200	90	272	2015
HTP-90-4T-20 IE3	1465		27.90	16.20	15.00	50050	94	283	2015
HTP-90-4T-25 IE3	1470		35.10	20.30	18.50	54550	95	326	2015
HTP-90-4T-30 IE3	1470		41.00	23.80	22.00	61750	97	326	2015
HTP-100-4T-15 IE3	1470		20.90	12.10	11.00	46100	93	307	2015
HTP-100-4T-20 IE3	1465		27.90	16.20	15.00	56300	93	318	2015
HTP-100-4T-25 IE3	1470		35.10	20.30	18.50	59900	93	361	2015
HTP-100-4T-30 IE3	1470		41.00	23.80	22.00	69900	96	361	2015
HTP-100-4T-40 IE3	1480		57.10	33.10	30.00	80500	98	429	2015
HTP-125-4T-40 IE3	1480		57.10	33.10	30.00	81000	100	531	2015
HTP-125-4T-50 IE3	1480		69.20	40.10	37.00	96800	100	602	2015
HTP-125-4T-60 IE3	1475		80.90	46.90	45.00	105050	100	658	2015
HTP-125-4T-75 IE3	1480		98.60	57.20	55.00	127800	100	664	2015
HTP-125-4T-100 IE3	1485		134.00	77.70	75.00	147350	104	784	2015
HTP-125-4T-125 IE3	1485		158.00	91.60	90.00	156800	105	823	2015



### Erp. (Energy Related Products)

Information on Directive 2009/125/EC can be downloaded from the SODECA website or the QuickFan selector programme.

### Acoustic characteristics

The indicated values are determined by measuring the sound pressure and power levels in dB(A), obtained in a free field at a distance equivalent to twice the size of the fan plus the diameter of the impeller, with a minimum of 1.5 m

Sound power spectrum Lw(A) in dB(A) per Hz frequency band

Model	LpdB(A)	63	125	250	500	1000	2000	4000	8000	Model	LpdB(A)	63	125	250	500	1000	2000	4000	8000
HTP-50-2T-4	80	57	77	85	90	92	89	82	71	HTP-80-4T-4	86	58	75	86	95	96	96	93	86
HTP-50-2T-5.5	81	58	78	86	91	93	90	83	72	HTP-80-4T-5.5	86	58	76	86	95	96	96	93	86
HTP-56-2T-5.5	86	63	83	91	96	98	95	88	77	HTP-80-4T-7.5	86	58	76	86	95	96	96	93	86
HTP-56-2T-10	87	64	84	92	97	99	96	89	78	HTP-80-4T-10	87	59	77	87	97	98	98	94	88
HTP-63-2T-10	94	70	82	92	104	105	104	99	91	HTP-80-4T-15	91	63	81	91	101	102	102	99	92
HTP-63-2T-15	94	70	82	92	104	105	104	99	91	HTP-90-4T-7.5	90	62	79	90	99	100	100	97	90
HTP-63-2T-20	97	73	85	95	107	108	107	102	94	HTP-90-4T-10	90	62	80	90	99	100	100	97	90
HTP-63-2T-25	98	74	86	96	108	109	108	103	95	HTP-90-4T-15	90	62	80	90	100	101	101	98	91
HTP-63-2T-30	99	75	87	97	109	110	109	104	96	HTP-90-4T-20	94	66	83	94	103	104	104	101	94
HTP-63-4T-1.5	79	55	67	77	89	90	89	84	76	HTP-90-4T-25	95	67	85	95	104	105	105	102	95
HTP-63-4T-2	79	55	67	77	89	90	89	84	76	HTP-90-4T-30	97	69	87	97	107	108	108	104	98
HTP-63-4T-3	83	59	71	81	93	94	93	88	80	HTP-100-4T-15	93	65	83	93	102	103	103	100	93
HTP-63-4T-4	84	60	72	82	94	95	94	89	81	HTP-100-4T-20	93	65	82	93	102	103	103	100	93
HTP-71-2T-15	93	65	83	93	102	104	103	100	93	HTP-100-4T-25	93	65	83	93	102	103	103	100	93
HTP-71-2T-20	95	67	85	95	104	106	105	102	95	HTP-100-4T-30	96	67	85	96	105	106	106	103	96
HTP-71-2T-25	95	67	85	95	104	106	105	102	95	HTP-100-4T-40	98	70	88	98	107	108	108	105	98
HTP-71-2T-30	95	67	85	95	104	106	105	102	95	HTP-125-4T-40	100	72	89	100	109	110	110	107	100
HTP-71-2T-40	98	70	88	98	107	109	108	105	98	HTP-125-4T-50	100	72	90	100	109	110	110	107	100
HTP-71-4T-2	83	55	73	83	92	93	93	90	83	HTP-125-4T-60	100	72	89	100	109	110	110	107	100
HTP-71-4T-3	83	55	72	83	92	93	93	90	83	HTP-125-4T-75	100	72	90	100	110	111	111	108	101
HTP-71-4T-4	84	56	74	84	94	95	95	91	85	HTP-125-4T-100	104	76	93	104	113	114	114	111	104
HTP-71-4T-5.5	87	59	77	87	97	98	98	95	88	HTP-125-4T-125	105	77	95	105	114	115	115	112	105
HTP-71-4T-7.5	90	62	80	90	100	101	101	97	91										

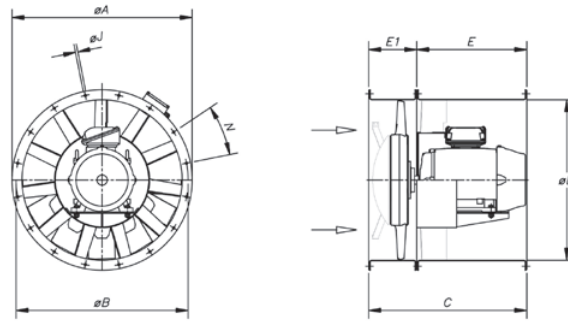
**Dimensions mm**

Model	Power	ØA	ØB	ØD	E	E1	C	ØJ	N
HTP-50-2T	4/5.5	600	560	514	-	-	400	12	12x30°
HTP-56-2T	5.5/10	660	620	560	-	-	500	12	12x30°
HTP-63-2T	10/15/20/25/30	730	690	640	650	220	870	13	12x30°
HTP-63-4T	1.5/2/3/4	730	690	640	340	220	560	13	12x30°
HTP-71-2T	15/20/25/30/40	810	770	710	700	240	940	13	16x22°30'
HTP-71-4T	2/3/4/5.5/7.5	810	770	710	420	240	660	13	16x22°30'
HTP-80-4T	4 / 5.5	900	860	800	360	240	600	15	16x22°30'
HTP-80-4T	7.5 / 10 / 15	900	860	800	600	240	840	15	16x22°30'
HTP-90-4T	7.5 / 10	1015	970	900	420	250	670	15	16x22°30'
HTP-90-4T	15 / 20 / 25 / 30	1015	970	900	650	250	900	15	16x22°30'
HTP-100-4T	15 / 20	1115	1070	1000	600	270	870	15	16x22°30'
HTP-100-4T	25 / 30 / 40	1115	1070	1000	700	270	970	15	16x22°30'
HTP-125	40 / 50 / 60 / 75	1365	1320	1250	900	300	1100	15	20x18°
HTP-125	100 / 125	1365	1320	1250	950	300	1250	15	20x18°

**Accessories**

See accessories section.



## SELECTION EXAMPLE

### Characteristic curves

Q= Flow rate in m<sup>3</sup>/h, m<sup>3</sup>/s and cfm.

Pe= Static pressure in mm H<sub>2</sub>O, Pa and inwg.

#### HTP-63-4T

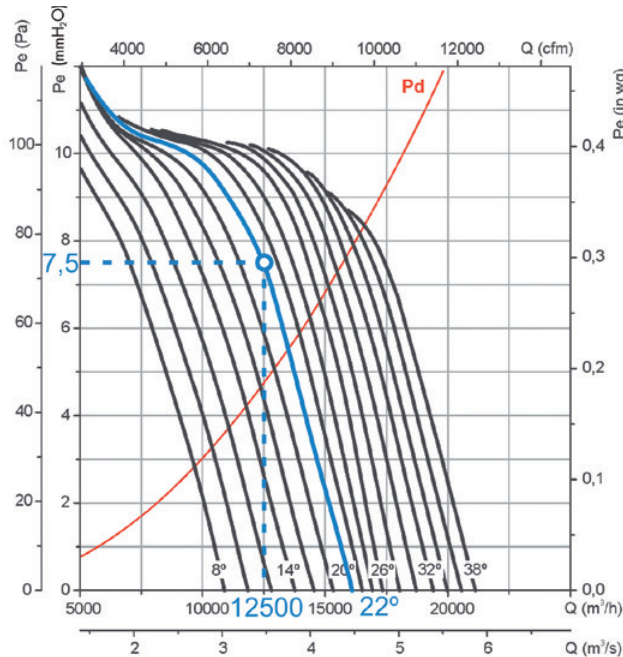

#### Starting data

- Working point:
- Flow rate: 12,500 m<sup>3</sup>/h
- Load loss: 7.5 mm H<sub>2</sub>O

#### Equipment selection steps

##### On the pressure graph:

1. Mark the working point defined by the flow rate (12,500 m<sup>3</sup>/h) and the load loss (7.5 mm H<sub>2</sub>O).
2. Select the nearest equipment curve above the working point. In this case, a blade angle curve of 22° is obtained.

##### On the power graph:

3. Mark the working point defined by the working flow rate (12,500 m<sup>3</sup>/h) and the selected blade angle curve (22°).
4. Read the absorbed power on the left power axis. Pa= 560 W at the working point.
5. Find the nearest straight red line above the working point. The installed motor power is given on the right side of the graph. In this case, 0.75 kW or 1 HP

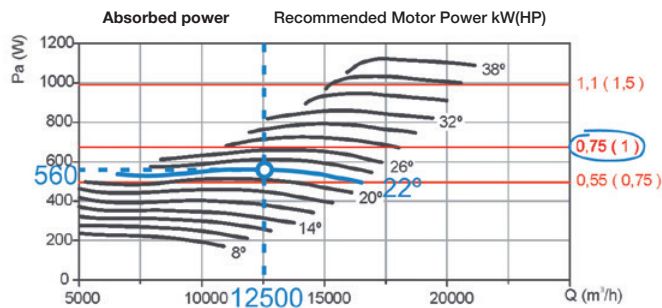

## ORDER CODE EXAMPLE

<b>HTP</b>	—	<b>63</b>	—	<b>4T</b>	—	<b>1</b>	—	<b>22°</b>
↓		↓		↓		↓		↓
Tubular, high pressure, axial extract fans		Impeller diameter in cm		Number of motor poles 4=1400 r/min. 50 Hz 6=900 r/min. 50 Hz 8=750 r/min. 50 Hz		T= Three-phase M= Single-phase		Motor power (HP)
								Blades inclination angle

**Characteristic curves**

 Q= Flow rate in m<sup>3</sup>/h, m<sup>3</sup>/s and cfm.

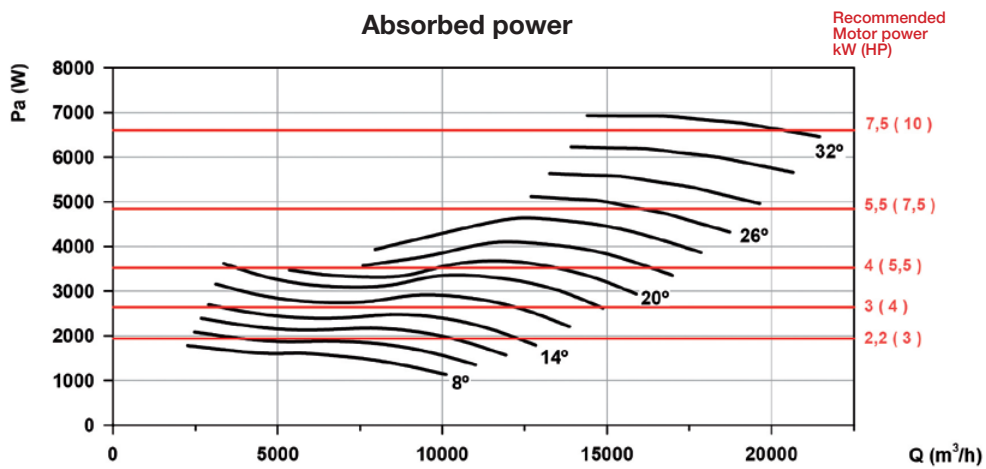
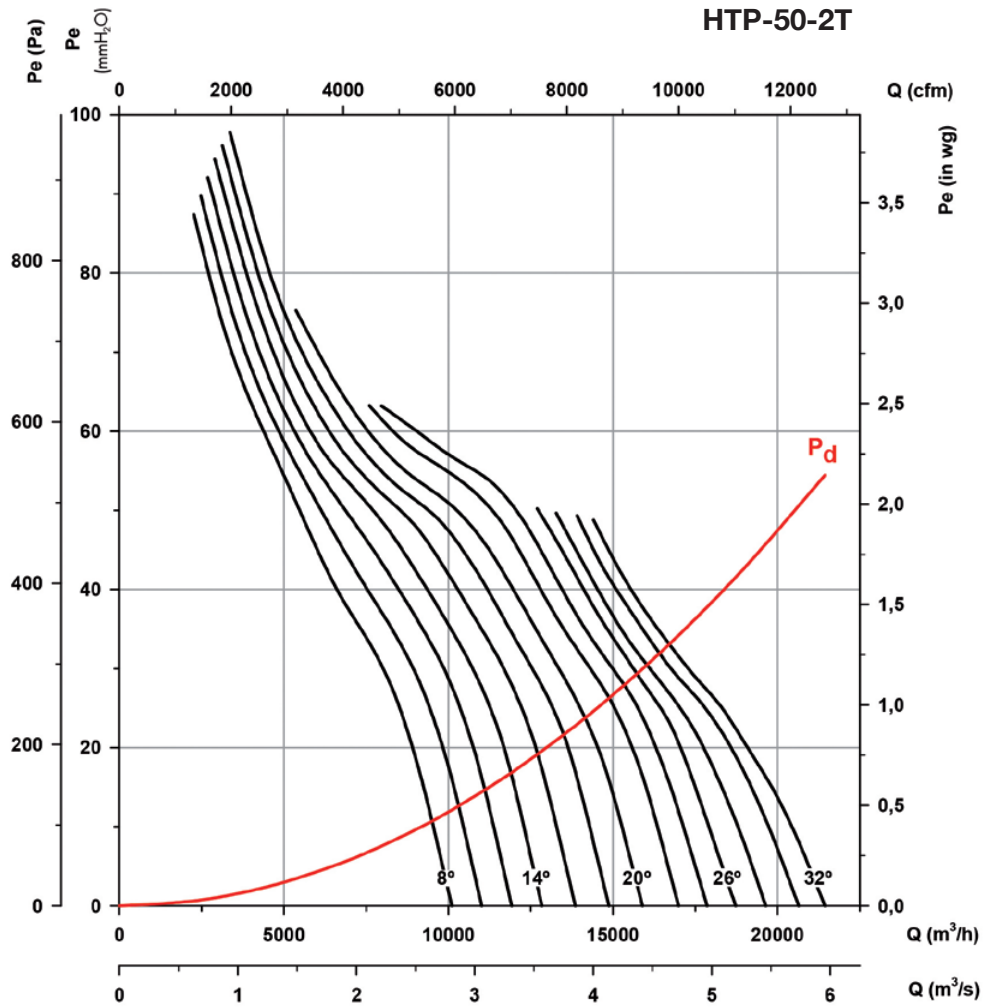
 Pe= Static pressure in mm H<sub>2</sub>O, Pa and inwg.

**Characteristic curves**

Q= Flow rate in m<sup>3</sup>/h, m<sup>3</sup>/s and cfm.

Pe= Static pressure in mm H<sub>2</sub>O, Pa and inwg.

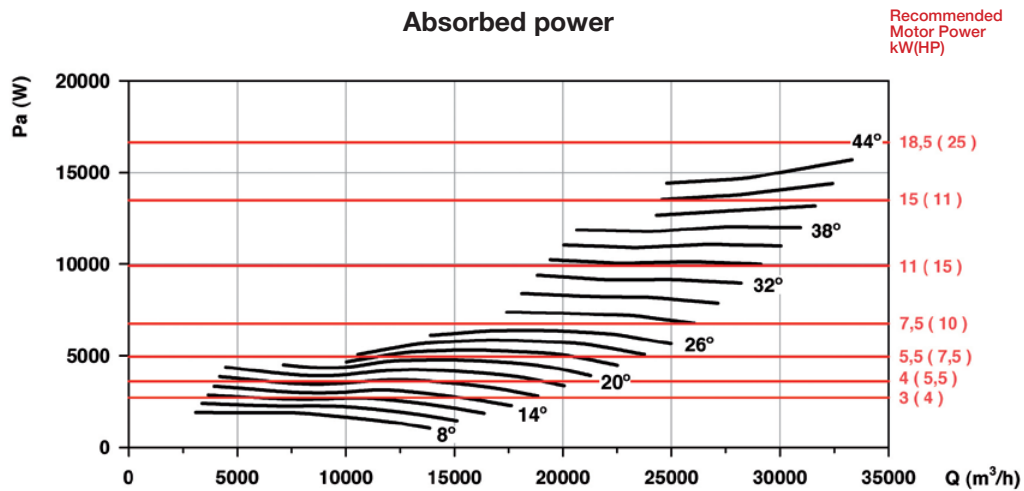
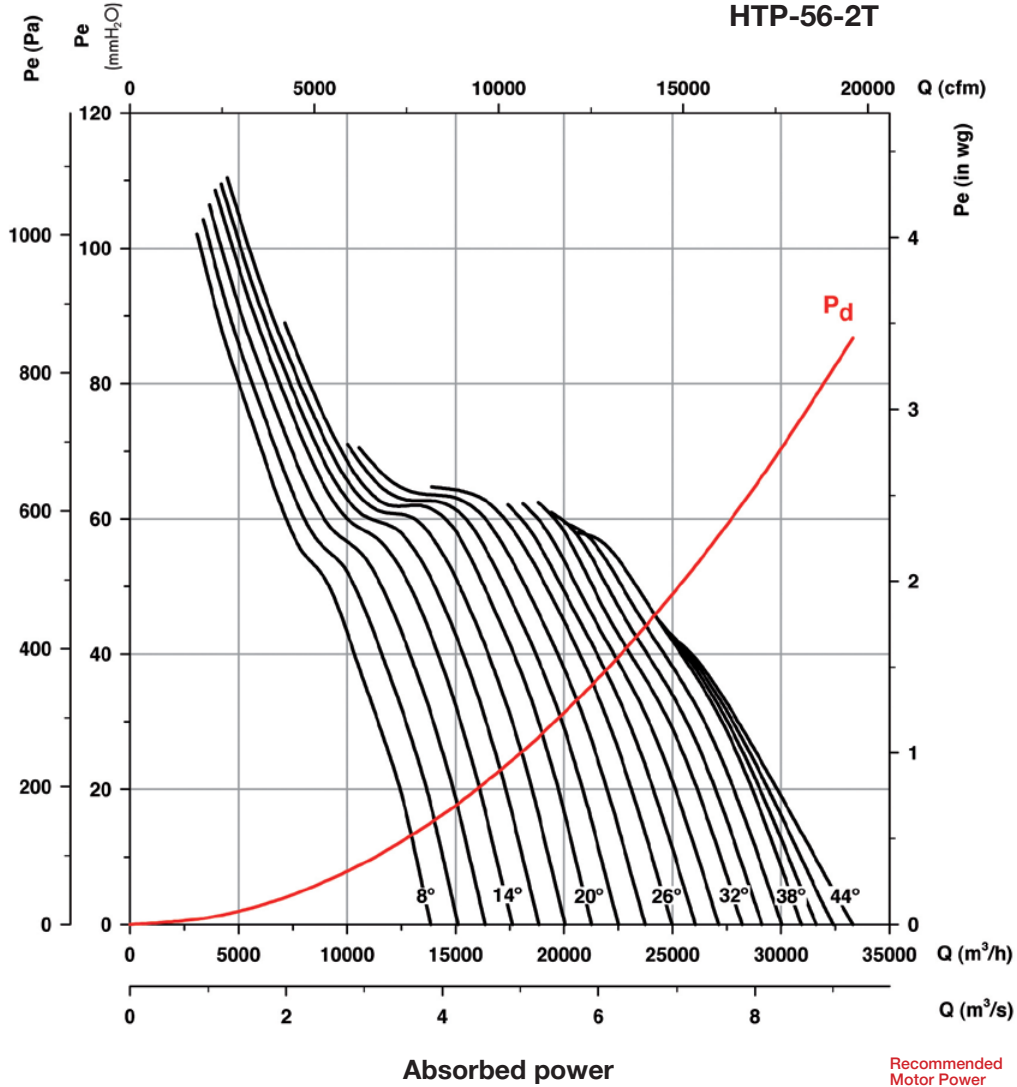



**Characteristic curves**

 Q= Flow rate in m<sup>3</sup>/h, m<sup>3</sup>/s and cfm.

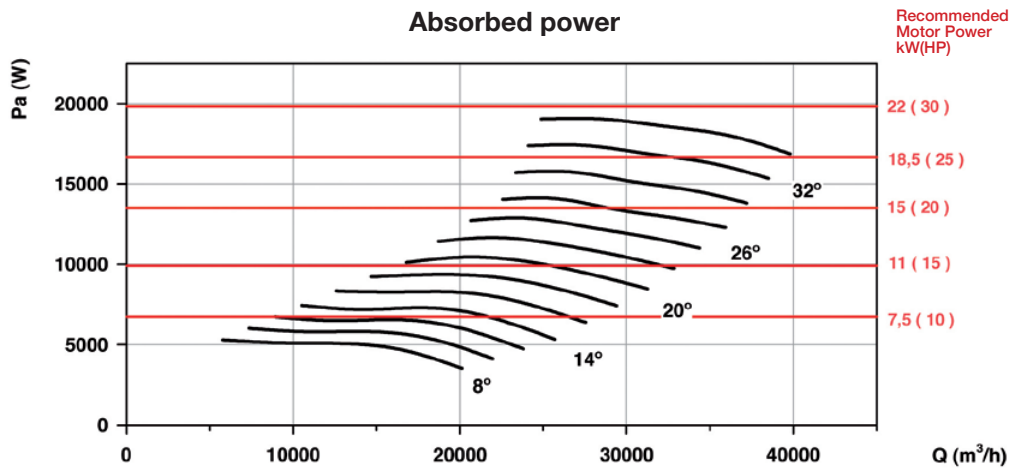
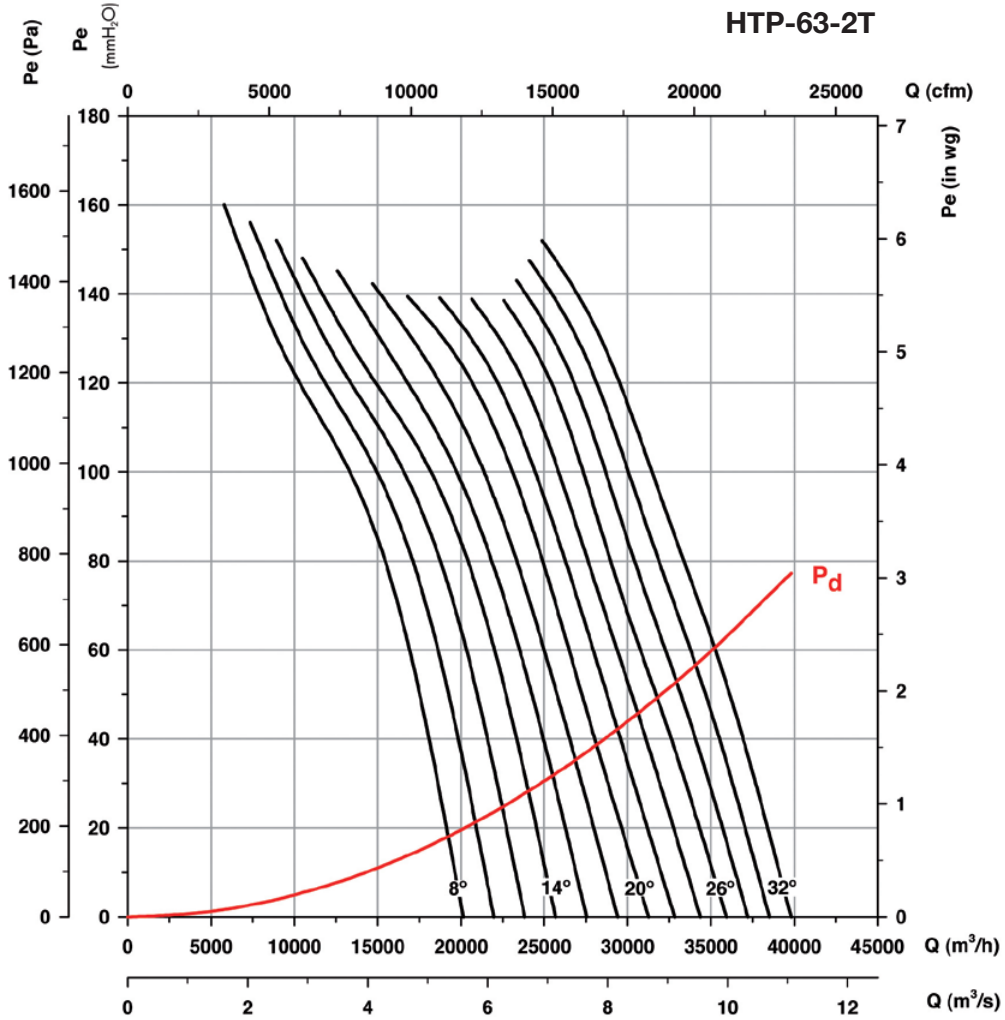
 Pe= Static pressure in mm H<sub>2</sub>O, Pa and inwg.

**Characteristic curves**

Q= Flow rate in m<sup>3</sup>/h, m<sup>3</sup>/s and cfm.

Pe= Static pressure in mm H<sub>2</sub>O, Pa and inwg.

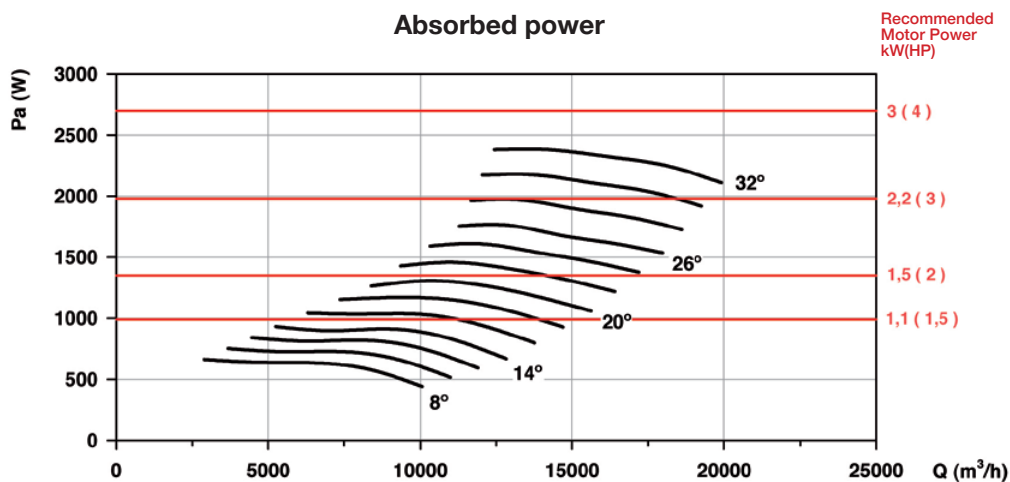
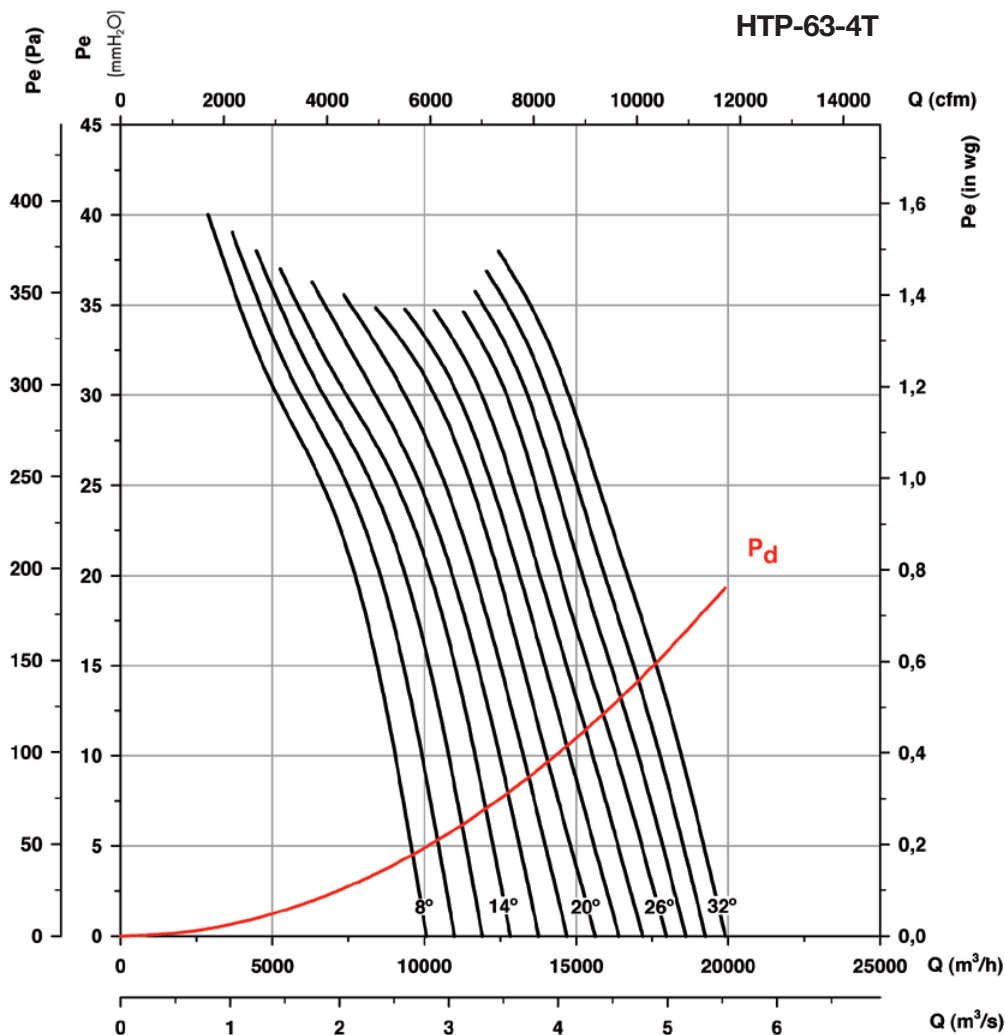



**Characteristic curves**

 Q= Flow rate in m<sup>3</sup>/h, m<sup>3</sup>/s and cfm.

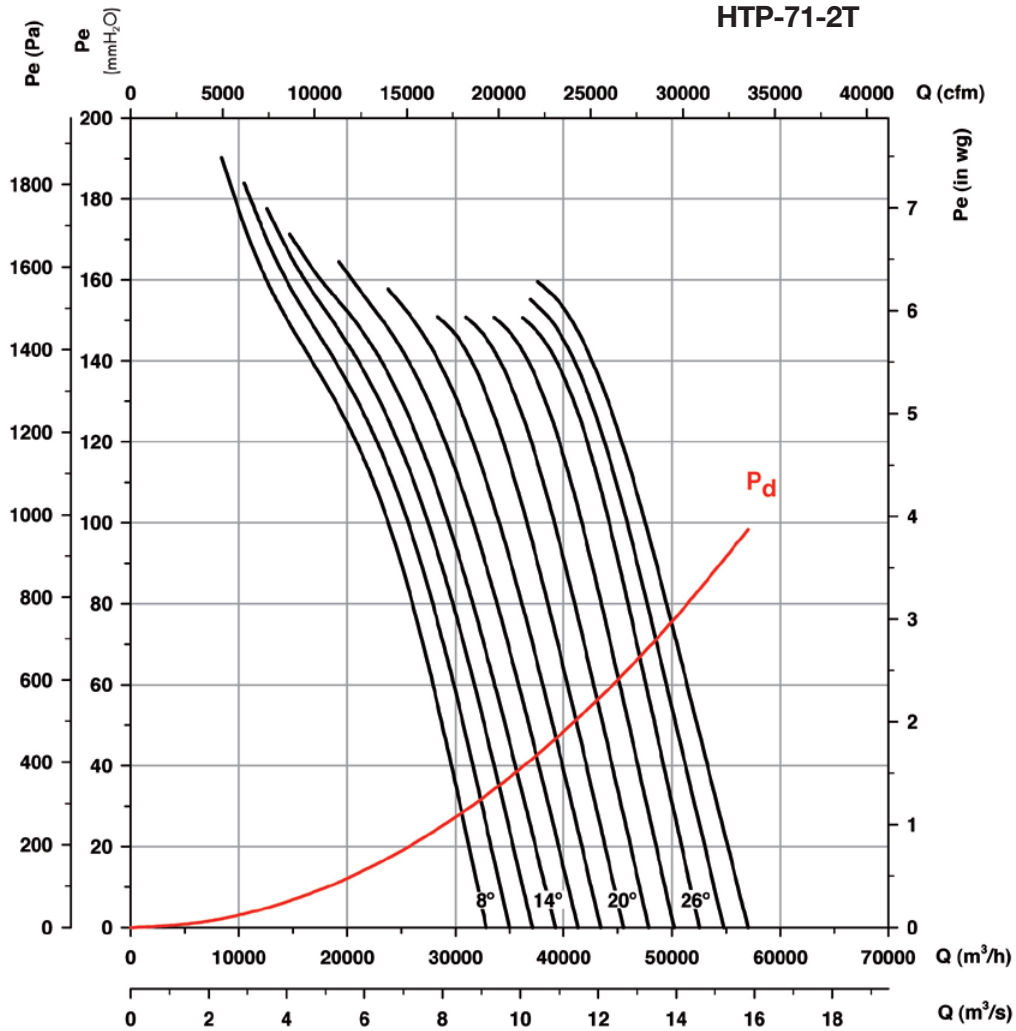
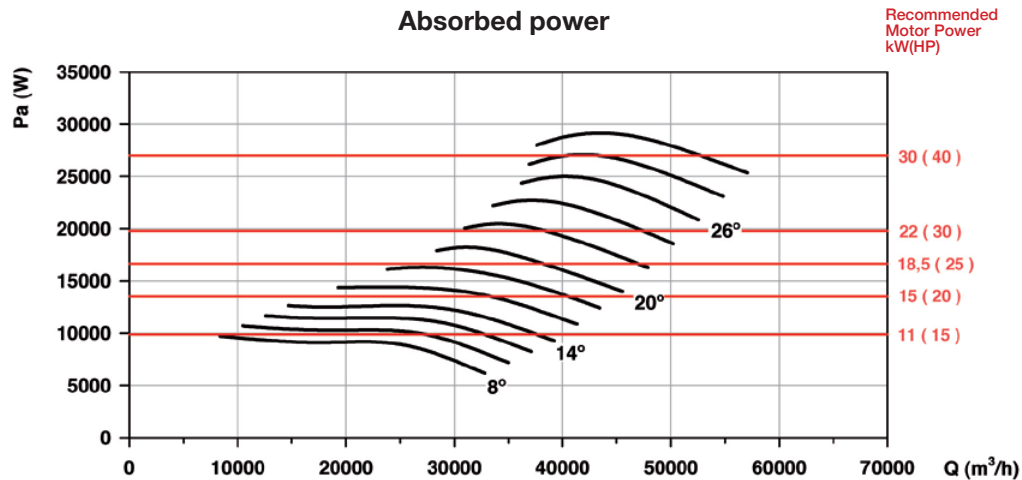
 Pe= Static pressure in mm H<sub>2</sub>O, Pa and inwg.

**Absorbed power**

**Characteristic curves**

Q= Flow rate in m<sup>3</sup>/h, m<sup>3</sup>/s and cfm.

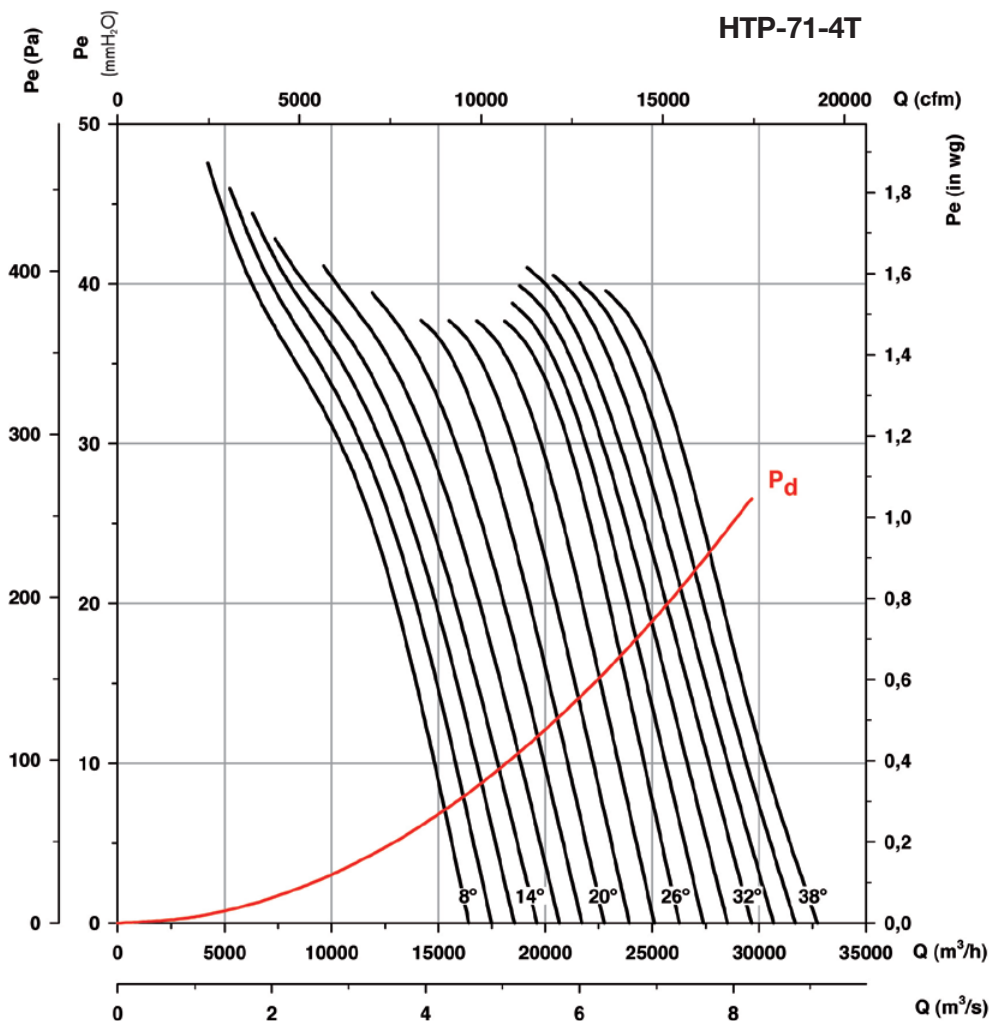
Pe= Static pressure in mm H<sub>2</sub>O, Pa and inwg.



**Absorbed power**

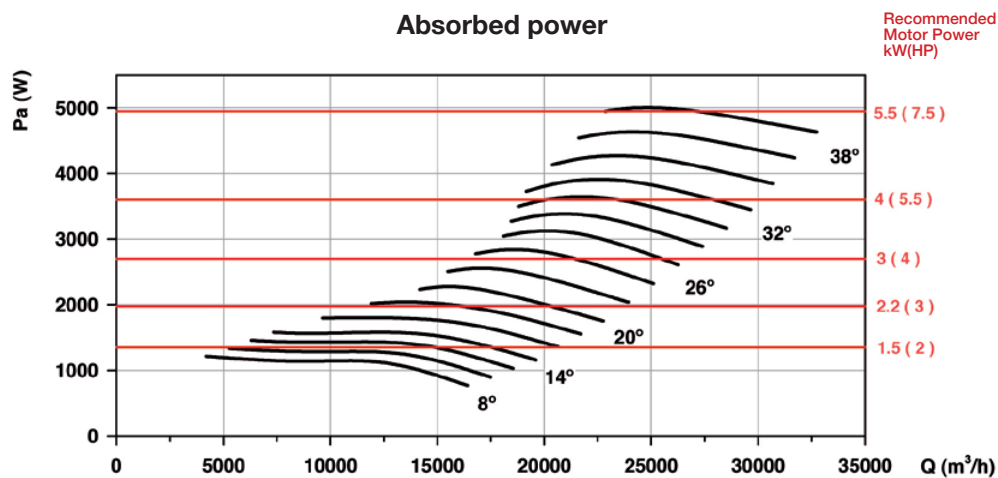

**Characteristic curves**

 Q= Flow rate in m<sup>3</sup>/h, m<sup>3</sup>/s and cfm.

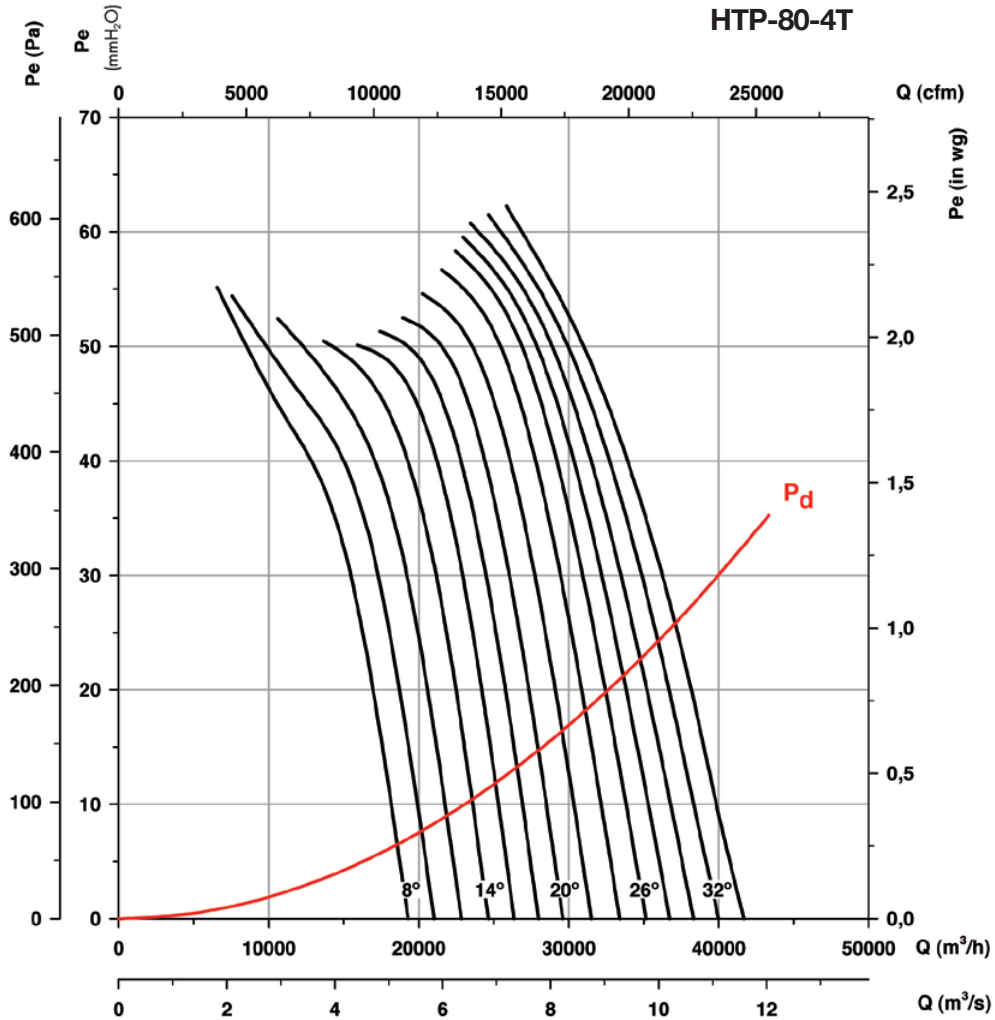
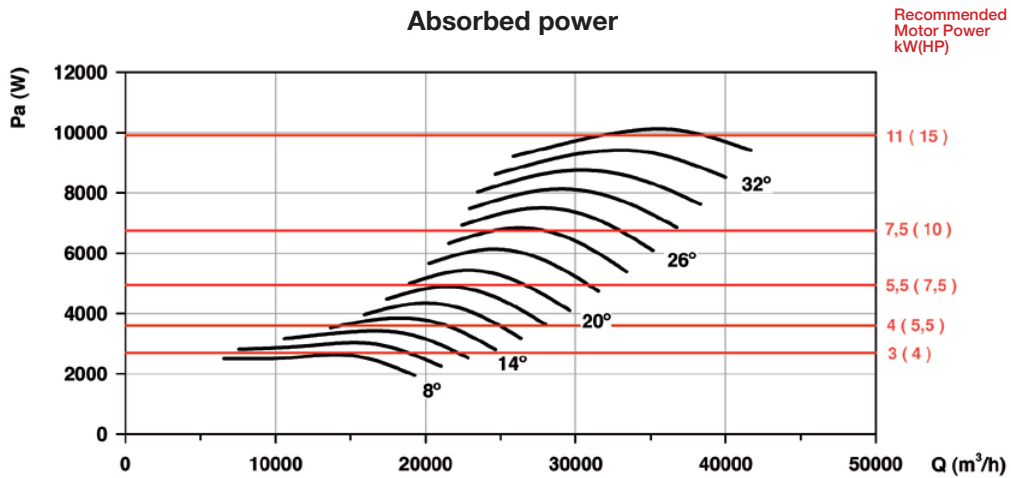
 Pe= Static pressure in mm H<sub>2</sub>O, Pa and inwg.

**Absorbed power**

 Recommended  
 Motor Power  
 kW(HP)

**Characteristic curves**

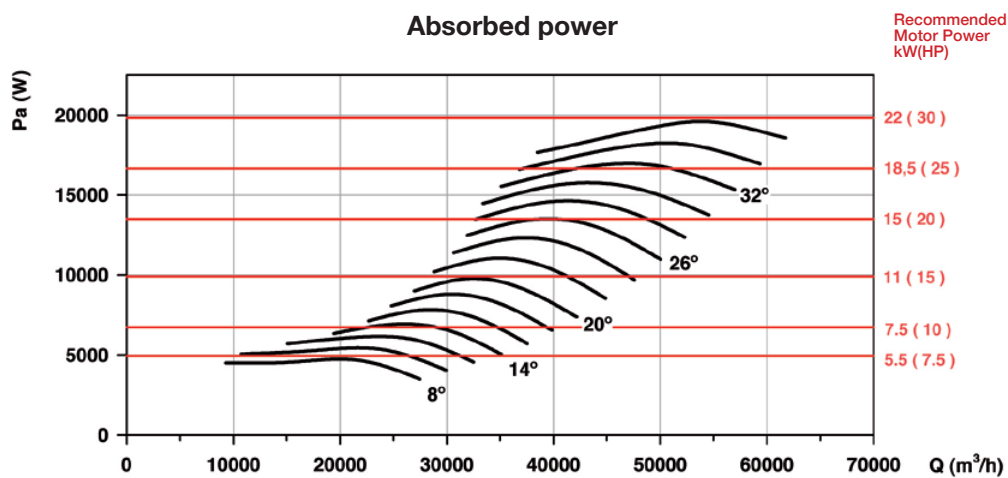
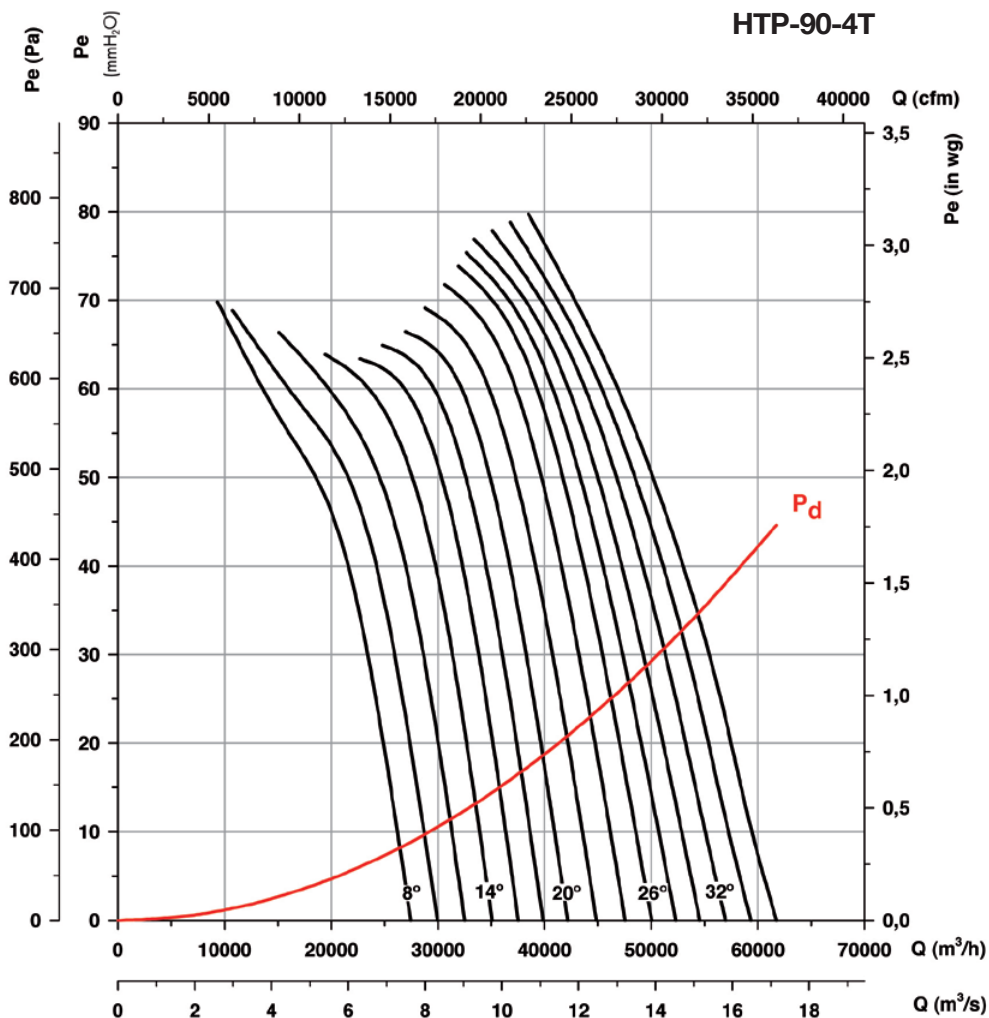
Q= Flow rate in m<sup>3</sup>/h, m<sup>3</sup>/s and cfm.

Pe= Static pressure in mm H<sub>2</sub>O, Pa and inwg.



**Characteristic curves**

 Q= Flow rate in m<sup>3</sup>/h, m<sup>3</sup>/s and cfm.

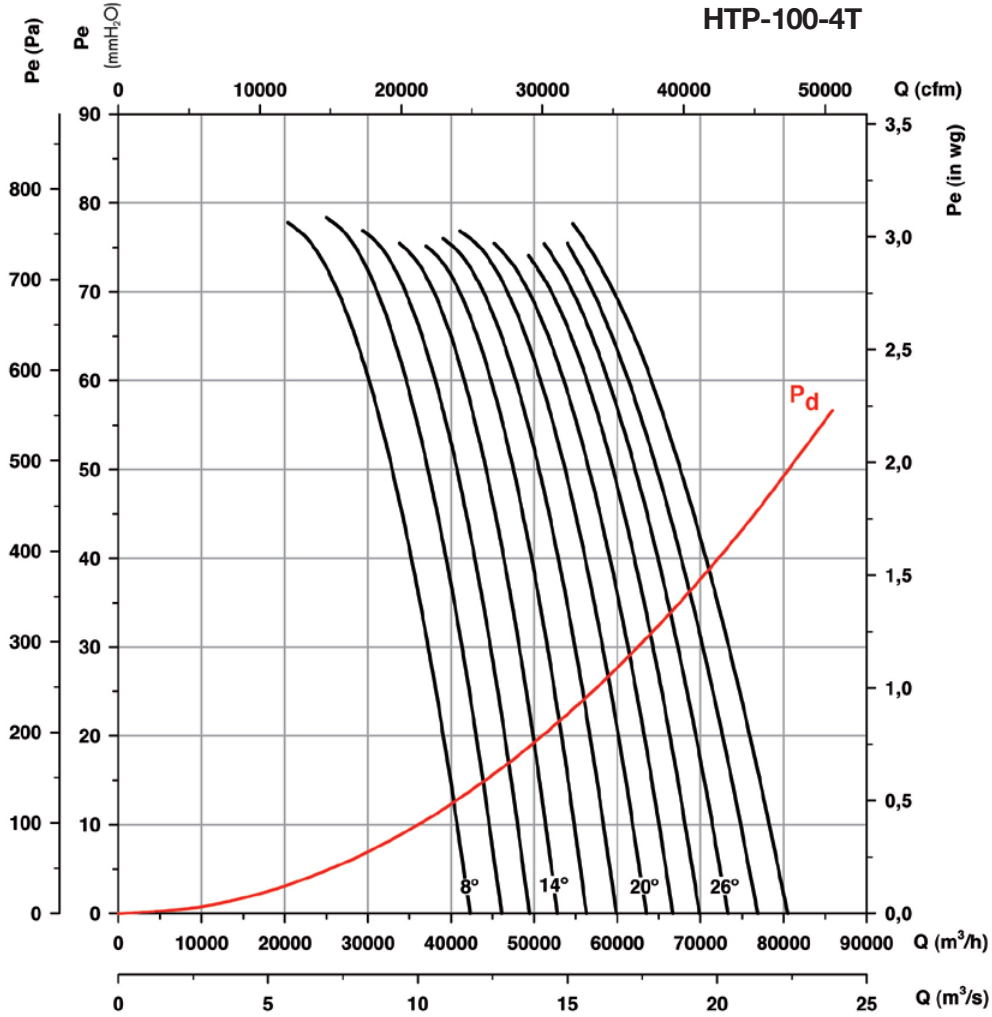
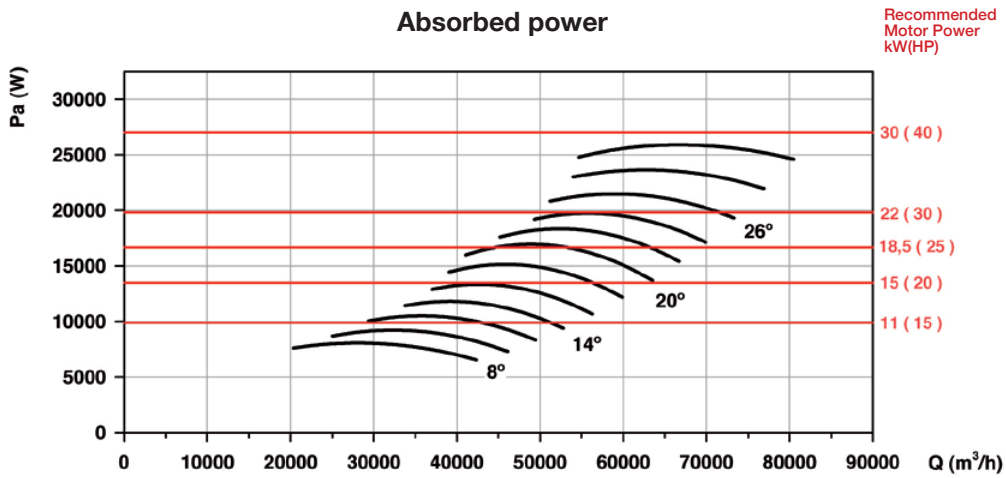
 Pe= Static pressure in mm H<sub>2</sub>O, Pa and inwg.

**Absorbed power**

**Characteristic curves**

Q= Flow rate in m<sup>3</sup>/h, m<sup>3</sup>/s and cfm.

Pe= Static pressure in mm H<sub>2</sub>O, Pa and inwg.

