

HFW

Hot dip galvanised tubular fans



Tubular axial fans designed with four support arms to reduce vibrations and fitted with an aerodynamic aluminium low-consumption impeller.

Fan:

- Airflow direction from motor to impeller.
- AL version impellers made of cast aluminium.
- Support ring made of sheet steel with double flange and cable gland for motor power supply.
- Hot dip galvanised tubular sheet steel casing.

Motor:

- IE3 efficiency motors for powers equal to or higher than 0.75kW except single-phase, 2-speed and 8-pole.

- Class F motors with ball bearings and IP55 protection.
- Three-phase 230/400V-50Hz (up to 4kW) and 400/690V-50Hz (powers higher than 4kW).
- Operating temperature: -25°C +50°C.

Finish:

- Hot dip galvanising.

On request:

- Airflow direction from impeller to motor.
- Fibreglass-reinforced polyamide PL version impellers
- 100% reversible impellers.
- Special windings for different voltages.
- ATEX-certified Category 2.

Order code

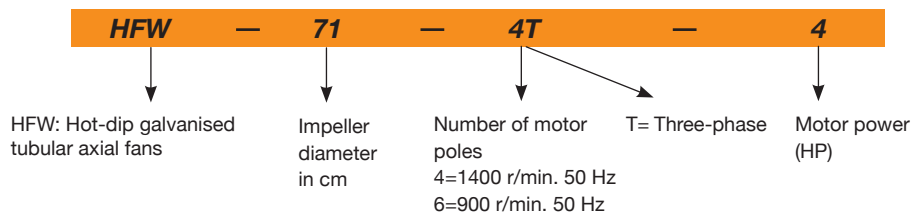

Technical characteristics

Model	Speed (r/min)	Maximum admissible current (A)			Installed power (kW)	Blade inclination angle (°)	Maximum flow rate (m ³ /h)	Sound pressure level dB(A)	Approx. weight (kg)	According to ErP
		230V	400V	690V						
HFW-56-4T-1 IE3	1420	2.82	1.62	0.75	22	11250	73	29	2015	
HFW-56-4T-1.5 IE3	1455	4.07	2.34	1.10	30	13600	74	36	2015	
HFW-56-4T-2 IE3	1440	5.41	3.11	1.50	36	15050	75	38	2015	
HFW-56-6T-0.75	910	2.59	1.49	0.55	38	10150	62	23	*	
HFW-63-4T-1 IE3	1420	2.82	1.62	0.75	14	15200	73	30	2015	
HFW-63-4T-1.5 IE3	1455	4.07	2.34	1.10	20	17800	74	36	2015	
HFW-63-4T-2 IE3	1440	5.41	3.11	1.50	24	19300	75	43	2015	
HFW-63-4T-3 IE3	1435	7.93	4.56	2.20	32	22150	76	44	2015	
HFW-63-4T-4 IE3	1440	10.70	6.15	3.00	38	24250	77	50	2015	
HFW-63-6T-0.75	910	2.59	1.49	0.55	28	13600	65	29	2015	
HFW-63-6T-1 IE3	940	3.36	1.93	0.75	38	15900	66	38	2015	
HFW-71-4T-1.5 IE3	1455	4.07	2.34	1.10	12	19500	78	39	2015	
HFW-71-4T-2 IE3	1440	5.41	3.11	1.50	14	20900	79	46	2015	
HFW-71-4T-3 IE3	1435	7.93	4.56	2.20	22	25100	81	48	2015	
HFW-71-4T-4 IE3	1440	10.70	6.15	3.00	28	27500	82	54	2015	
HFW-71-6T-0.75	910	2.59	1.49	0.55	20	16100	67	31	2015	
HFW-71-6T-1 IE3	940	3.36	1.93	0.75	26	17300	68	41	2015	
HFW-71-6T-1.5 IE3	945	4.68	2.69	1.10	34	19950	69	46	2015	
HFW-80-4T-3 IE3	1435	7.93	4.56	2.20	12	25450	82	56	2015	
HFW-80-4T-4 IE3	1440	10.70	6.15	3.00	16	30250	83	62	2015	
HFW-80-4T-5.5 IE3	1450	13.90	8.00	4.00	18	32750	84	64	2015	
HFW-80-6T-1.5 IE3	945	4.68	2.69	1.10	18	21450	72	54	2015	
HFW-80-6T-2 IE3	950	6.43	3.70	1.50	26	25950	73	58	2015	
HFW-80-6T-3 IE3	950	9.08	5.22	2.20	32	29950	74	63	2015	
HFW-90-4T-4 IE3	1440	10.70	6.15	3.00	8	33600	87	71	2015	

Technical characteristics

Model	Speed (r/min)	Maximum admissible current (A)			Installed power (kW)	Blade inclination angle (°)	Maximum flow rate (m³/h)	Sound pressure level dB(A)	Approx. weight (kg)	According to ErP
		230V	400V	690V						
HFW-90-4T-5.5 IE3	1450	13.90	8.00		4.00	12	38900	89	73	2015
HFW-90-4T-7.5 IE3	1465		10.30	5.97	5.50	18	46150	91	110	2015
HFW-90-4T-10 IE3	1455		14.20	8.20	7.50	22	50150	92	98	2015
HFW-90-6T-2 IE3	950	6.43	3.70		1.50	16	28800	77	67	2015
HFW-90-6T-3 IE3	950	9.08	5.22		2.20	24	34000	78	72	2015
HFW-90-6T-4 IE3	970	12.00	6.91		3.00	30	38900	79	92	2015
HFW-100-4T-7.5 IE3	1465		10.30	5.97	5.50	10	46850	92	118	2015
HFW-100-4T-10 IE3	1455		14.20	8.20	7.50	16	57400	93	106	2015
HFW-100-4T-15 IE3	1460		20.20	11.60	11.00	22	66300	94	129	2015
HFW-100-4T-20 IE3	1465		29.80	17.30	15.00	28	76150	95	148	2015
HFW-100-6T-3 IE3	950	9.08	5.22		2.20	16	37600	82	80	2015
HFW-100-6T-4 IE3	970	12.00	6.91		3.00	20	41150	83	100	2015
HFW-100-6T-5.5 IE3	960	15.60	8.99		4.00	26	47800	84	106	2015

* Equipment not covered by Directive 2009/125/EC

Acoustic characteristics

The indicated values are determined by measuring the sound pressure level and sound power in dB(A) obtained in a free field at a distance equivalent to twice the size of the fan plus the impeller diameter, with a minimum of 1.5 m.

Sound power spectrum Lw(A) in dB(A) per Hz frequency band

Model	63	125	250	500	1000	2000	4000	8000	Model	63	125	250	500	1000	2000	4000	8000
HFW-56-4T-1	48	68	76	81	83	80	73	62	HFW-80-4T-4	56	76	84	89	91	88	81	74
HFW-56-4T-1.5	49	69	77	82	84	81	74	63	HFW-80-4T-5.5	56	76	84	89	91	88	81	70
HFW-56-4T-2	50	70	78	83	85	82	75	64	HFW-80-6T-1.5	49	66	74	79	81	78	71	60
HFW-56-6T-0.75	37	57	65	70	72	69	62	51	HFW-80-6T-2	50	67	75	80	82	79	72	61
HFW-63-4T-1	50	70	78	83	85	82	75	64	HFW-80-6T-3	51	68	76	81	83	80	73	62
HFW-63-4T-1.5	48	68	76	81	83	80	73	65	HFW-90-4T-4	61	82	89	94	97	93	86	79
HFW-63-4T-2	52	68	76	81	83	80	73	66	HFW-90-4T-5.5	60	81	88	93	96	92	85	74
HFW-63-4T-3	53	70	78	83	85	82	77	67	HFW-90-4T-7.5	59	80	87	92	95	91	84	73
HFW-63-4T-4	54	71	79	84	86	83	78	68	HFW-90-4T-10	58	79	86	91	94	90	83	72
HFW-63-6T-0.75	42	60	68	73	75	72	65	56	HFW-90-6T-2	58	79	86	91	94	90	83	72
HFW-63-6T-1	43	62	70	75	77	74	67	57	HFW-90-6T-3	56	70	77	82	85	81	74	63
HFW-71-4T-1.5	54	74	82	87	89	86	79	69	HFW-90-6T-4	57	72	79	84	87	83	76	65
HFW-71-4T-2	53	73	81	86	88	85	78	70	HFW-100-4T-7.5	64	84	92	97	99	96	89	78
HFW-71-4T-3	58	72	80	85	87	84	77	71	HFW-100-4T-10	62	82	90	95	97	94	87	76
HFW-71-4T-4	59	73	81	86	88	85	78	72	HFW-100-4T-15	61	81	89	94	96	93	86	75
HFW-71-6T-0.75	44	63	72	74	76	73	66	55	HFW-100-4T-20	63	83	91	96	98	95	88	77
HFW-71-6T-1	45	65	73	75	77	74	67	56	HFW-100-6T-3	61	72	80	85	87	84	77	66
HFW-71-6T-1.5	46	66	71	76	78	75	68	57	HFW-100-6T-4	64	72	80	85	87	84	77	66
HFW-80-4T-3	57	77	85	90	92	89	82	73	HFW-100-6T-5.5	64	73	81	86	88	85	78	67



Erp. (Energy Related Products)

Information on Directive 2009/125/EC can be downloaded from the SODECA website or the QuickFan selector programme.

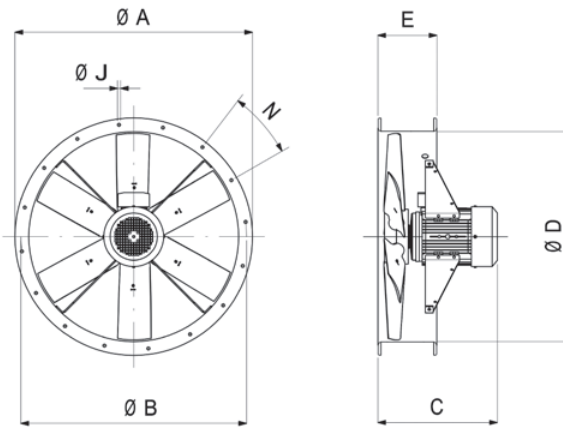
AXIAL FANS AND ROOF-MOUNTED EXTRACT FANS
Dimensions mm

Model	ØA	ØB	C										ØD	E	ØJ	N
			0.75	1	1.5	2	3	4	5.5	7.5	10	15				
HFW-56-4	665	620	-	330	380	380	-	-	-	-	-	-	560	225	12	12x30°
HFW-56-6	665	620	330	-	-	-	-	-	-	-	-	-	560	225	12	12x30°
HFW-63-4	735	690	-	379	429	429	470	470	-	-	-	-	640	225	12	12x30°
HFW-63-6	735	690	379	429	-	-	-	-	-	-	-	-	640	225	12	12x30°
HFW-71-4	815	770	-	-	389	389	430	430	-	-	-	-	710	225	12	16x22°30'
HFW-71-6	815	770	339	389	389	-	-	-	-	-	-	-	710	225	12	16x22°30'
HFW-80-4	905	860	-	-	-	-	436	436	460	-	-	-	800	225	12	16x22°30'
HFW-80-6	905	860	-	-	395	436	460	-	-	-	-	-	800	225	12	16x22°30'
HFW-90-4	1018	970	-	-	-	-	401	425	485	525	-	-	900	225	15	16x22°30'
HFW-90-6	1018	970	-	-	-	401	425	485	-	-	-	-	900	225	15	16x22°30'
HFW-100-4	1118	1070	-	-	-	-	-	-	488	528	643	703	1000	225	15	16x22°30'
HFW-100-6	1118	1070	-	-	-	-	428	488	528	-	-	-	1000	225	15	16x22°30'

Characteristic curves

 Q= Flow rate in m³/h, m³/s and cfm.

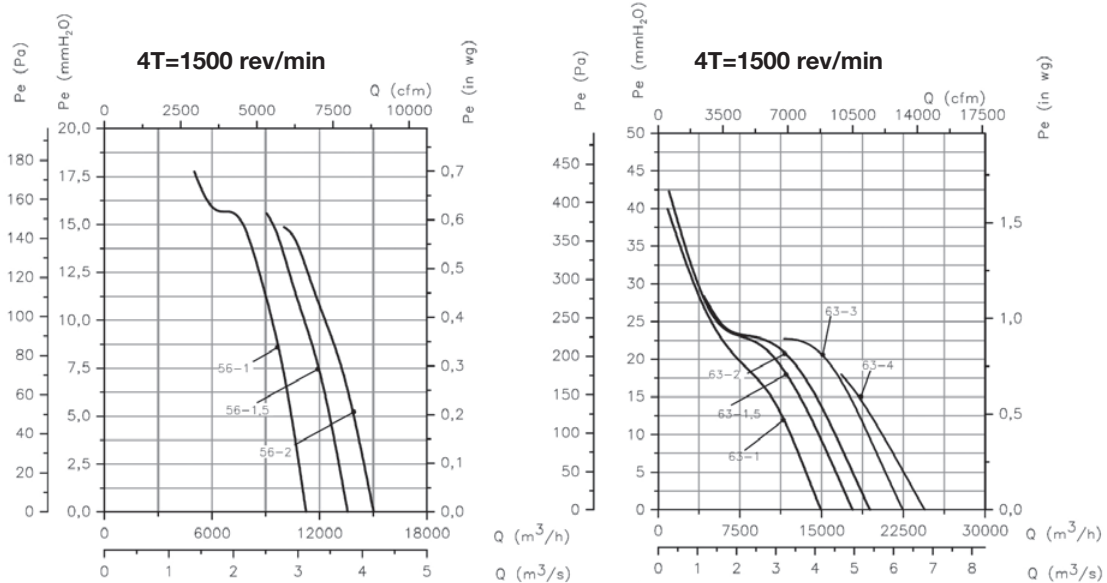
 Pe= Static pressure in mm H₂O, Pa and inwg.

Characteristic curves

Q= Flow rate in m³/h, m³/s and cfm.

Pe= Static pressure in mm H₂O, Pa and inwg.

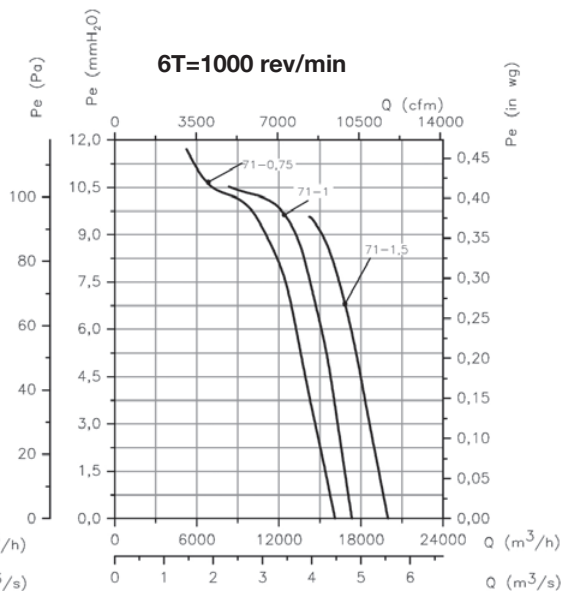
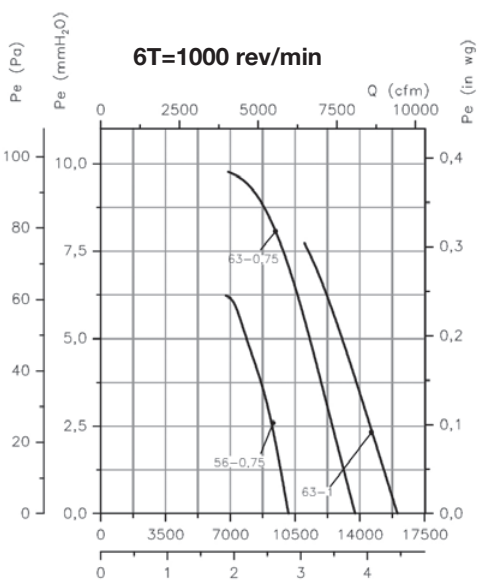
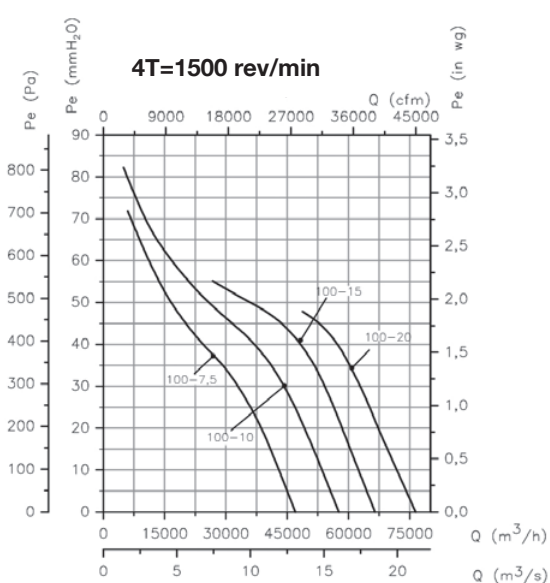
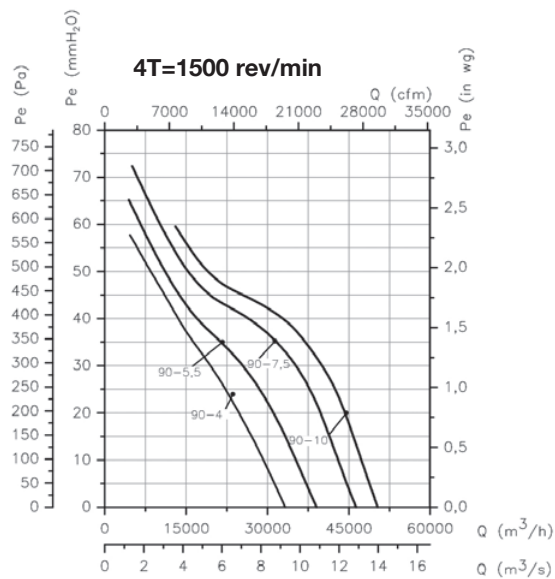
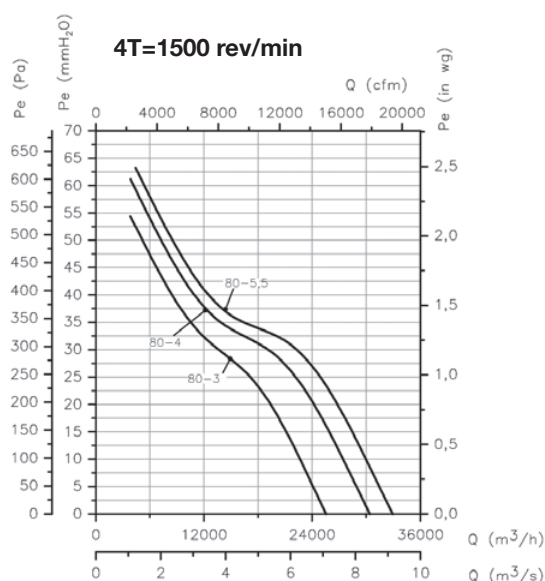
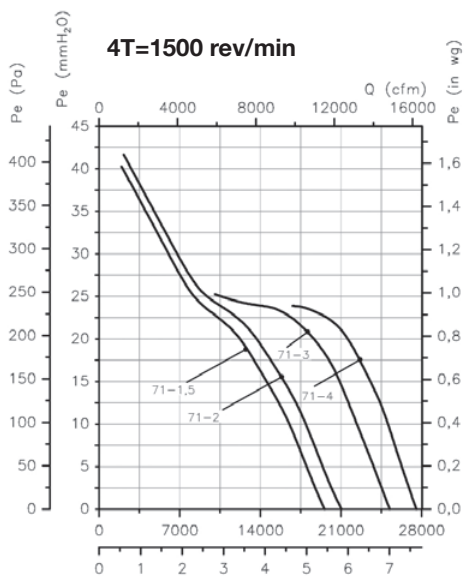

Characteristic curves

Q= Flow rate in m³/h, m³/s and cfm.

Pe= Static pressure in mm H₂O, Pa and inwg.

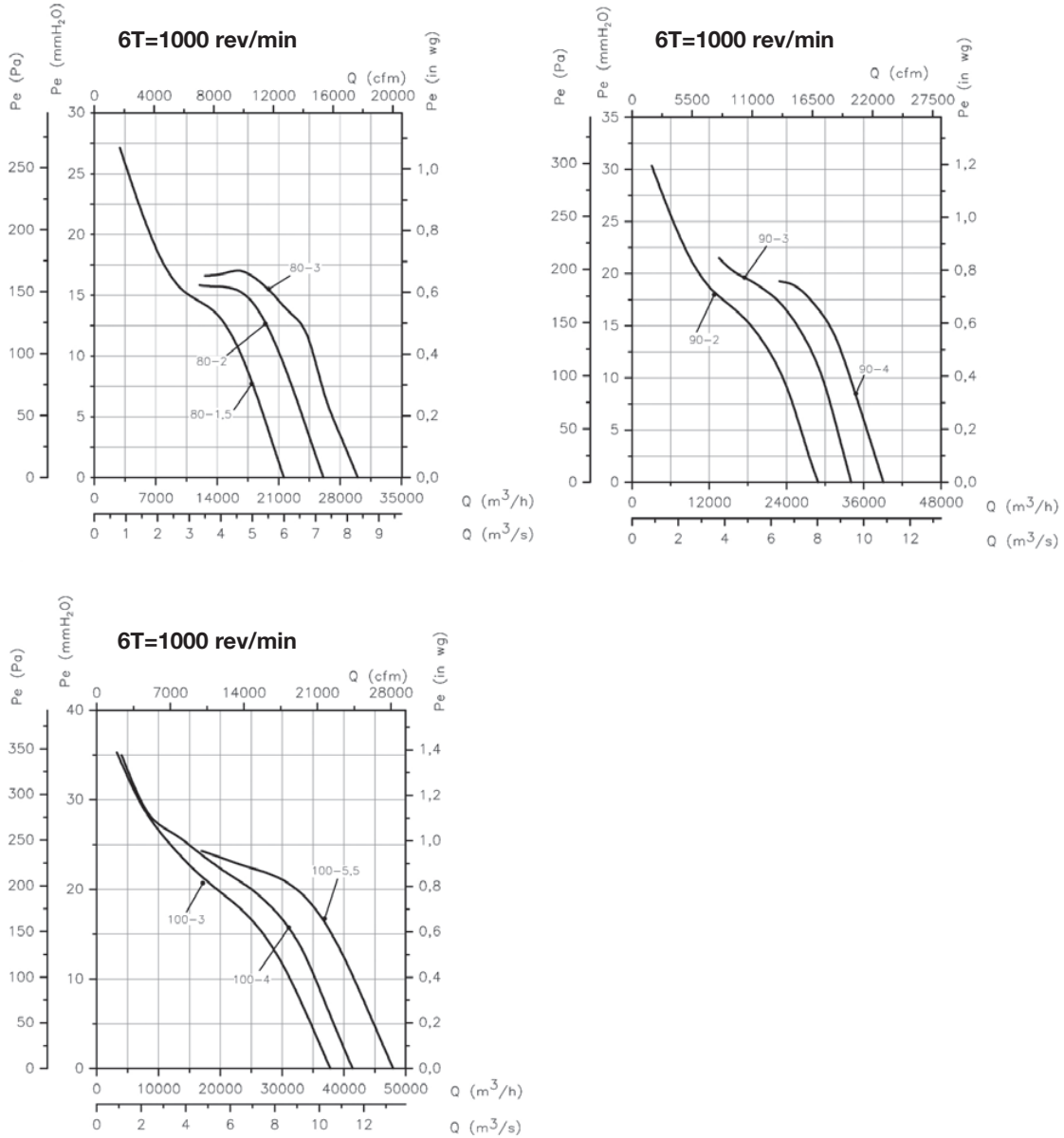

Accessories

See accessories section.

