

# Insect Control Air Curtains

Catalogue | 2018

# AIRTECNICS: The Air Curtain Specialist



Founded in 1986 and placed in Castellar del Vallès (Barcelona), Airtècnics has a large experience producing air curtains, air handling units, fan boxes, fan filter units, axial fans, centrifugal fans and other special and OEM equipment.

We export our products to more than 45 countries worldwide. Besides our own production, Airtècnics distributes a wide range of HVAC products, mostly produced by Rosenberg Group companies.

Loyal to our commitments regarding our customers, our products fulfill the highest standards of quality criteria.

We are proud of our highly qualified team composed by master engineers, designers, specialized technicians and skilled professionals, ready to assist you in any questions you may have in design, installation or service maintenance requirements.

Be sure that Airtècnics or our worldwide distributors network will give you the right solution for any air curtains application.

- Air curtains market leading
- Producing +20 years
- Exporting +45 countries
- Catalogue +25 languages
- Experimented R+D+i
- Continuous improving
- Complete range, all applications
- University knowledge collaboration

[www.airtecnicos.com](http://www.airtecnicos.com)

Find more information and our distributors list in our specialized air curtain websites:



Airtècnics headquarters in Castellar del Vallès (Spain)

Bulgarian	<a href="http://www.vazdushnizavesi.com">www.vazdushnizavesi.com</a>	Latvian	<a href="http://www.gaisaaizkari.com">www.gaisaaizkari.com</a>
Catalan	<a href="http://www.cortinesaire.com">www.cortinesaire.com</a>	Lithuanian	<a href="http://www.oruzuolaidos.com">www.oruzuolaidos.com</a>
Czech	<a href="http://www.vzduchoveclony.com">www.vzduchoveclony.com</a>	Norwegian	<a href="http://www.luftpporter.com">www.luftpporter.com</a>
Danish	<a href="http://www.lufttaepper.com">www.lufttaepper.com</a>	Polish	<a href="http://www.kurtynapowietrzna.com">www.kurtynapowietrzna.com</a>
Dutch	<a href="http://www.luchtgardijnen.com">www.luchtgardijnen.com</a>	Portuguese	<a href="http://www.cortinadeair.com">www.cortinadeair.com</a>
English	<a href="http://www.dooraircurtain.com">www.dooraircurtain.com</a>	Romanian	<a href="http://www.perdeledeair.com">www.perdeledeair.com</a>
Finnish	<a href="http://www.ilmaverho.com">www.ilmaverho.com</a>	Russian	<a href="http://www.vozdushnyezavesy.com">www.vozdushnyezavesy.com</a>
French	<a href="http://www.rideauxdair.com">www.rideauxdair.com</a>	Serbian	<a href="http://www.vazdusnezavese.com">www.vazdusnezavese.com</a>
German	<a href="http://www.luftschieieranlagen.net">www.luftschieieranlagen.net</a>	Slovenian	<a href="http://www.zracnezavese.com">www.zracnezavese.com</a>
Greek	<a href="http://www.aerokourtines.com">www.aerokourtines.com</a>	Spanish	<a href="http://www.cortinasdeaire.es">www.cortinasdeaire.es</a>
Hungarian	<a href="http://www.legfuggonyok.com">www.legfuggonyok.com</a>	Swedish	<a href="http://www.luftridaer.com">www.luftridaer.com</a>
Italian	<a href="http://www.barrieradaria.com">www.barrieradaria.com</a>	Turkish	<a href="http://www.havaperdeleri.eu">www.havaperdeleri.eu</a>

## The Rosenberg Group

Airtècnics is from 1993 fully integrated in the Rosenberg Group, an organization specializing in the design, manufacturing and distribution of equipments and components of ventilation and air conditioning with factories, subsidiaries and agencies in more than 50 countries.

Founded in 1981, with a total of 1.400 employees, 14 production sites on 4 continents, as well as 4 development centres. Rosenberg develops, produces and distributes its products worldwide.

Through a combination of human know how and innovative production technology Rosenberg products achieve a quality which meets the highest requirements.



Rosenberg headquarters in Künzelsau (Germany)

# Air Curtains Against Insects Or Fly Fans



Air curtains to prevent flies and other flying insects from entering a premise, also called “fly fans” where they can find a source of food and safe shelter.

An air curtain supplying a high velocity air stream across an opening will avoid flies and other flying insects from entering a building.

The presence of these insects in drink and food production plants, restaurants, community kitchens, supermarkets, hospitals and other food service premises, **can cause food contamination** and accordingly imperiling public health.

If besides the requirement of climate control at building doors, there is need for insects’ control, not all the air curtain models are appropriate:

- **In service entrances, the air stream must be between 5-12 cm wide, a minimum speed of 8 m/s of air 1 meter above the floor.** It is recommended to install a more powerful air curtain that the one required when just taking into account the height of the entrance.
- It is required an **air curtain with an adjustable blade that can angle the air stream away from the area to be protected.** An angle of about 20° from the vertical is usually optimal.
- It is very important to **cover the entire doorway and even slightly surpass it** so that there are no gaps for the insects to enter.

The Insect Control air curtains or fly fans can be mounted on the inside or outside of the doorway. When the building contains odours that are attractive to flying insects it is recommended that the air curtain be mounted on the outside so that odourless air is used to create the barrier.

As well as flying insects, air curtains can also discourage rodents from entering a building. Research has shown that rats, mice and other furry intruders do not like the sensation an air curtain creates on their fur and will avoid it.

## Selection Chart

The following picture shows all available models and its maximum installation height.





**Characteristics**



- Specially designed for insects control at entranceways such as food establishments and industry, hospitals or clean zones.
  - High velocity air barrier to prevent flying insects from entering a building. Up to 2m height doors according to NSF 37 standard
  - Self-supporting casing construction made of galvanized steel plate, finished in structural epoxy-polyester painting white colour RAL9016 as standard. Other colours or stainless steel are available on request.
  - Large perforated inlet grille avoiding intensive maintenance.
  - Anodized aluminium outlet vanes, airfoil shaped, adjustable from 0 to 15° each side.
  - EC Double-inlet centrifugal fans driven by an external rotor motor and low noise level, with very low consumption efficiency fans.
  - "A" type without heating, air only.
  - Includes Plug&Play Hand Auto control with 7m RJ45 cable and magnetical door contact.
- Optional: Clever control (programmable, automatic, intelligent, energy saving, Modbus RTU for BMS...).

**Specifications**

**AIR ONLY**

Model	Airflow m <sup>3</sup> /h	Power Fans 230V-50Hz kW	Current Fans 230V-50Hz A	Noise Level (5 m) dB(A)	Weight kg
FLY K 1000 A	2700	0,225	1,95	61	37
FLY K 1500 A	3600	0,300	2,60	62	56
FLY K 2000 A	5400	0,450	3,90	63	71
FLY K 2500 A	6300	0,525	4,55	64	78
FLY K 3000 A	7200	0,600	5,20	65	86

**Dimensions**

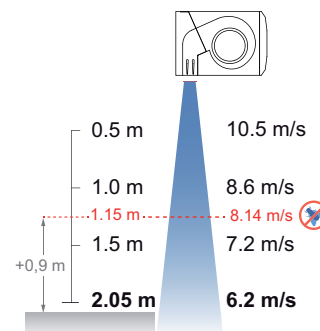
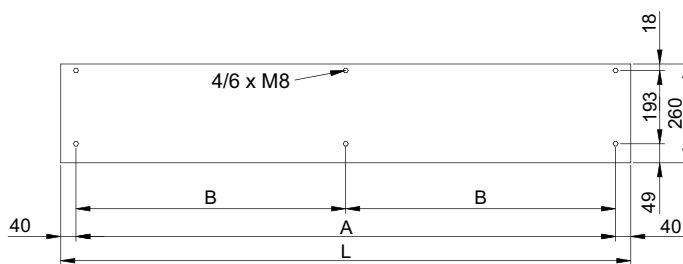
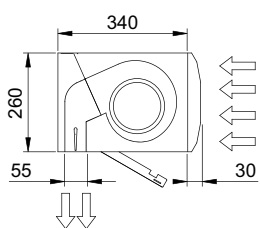

L	A	B
1000	920	-
1500	1420	710
2000	1920	960
2500	2420	1210
3000	2920	1460

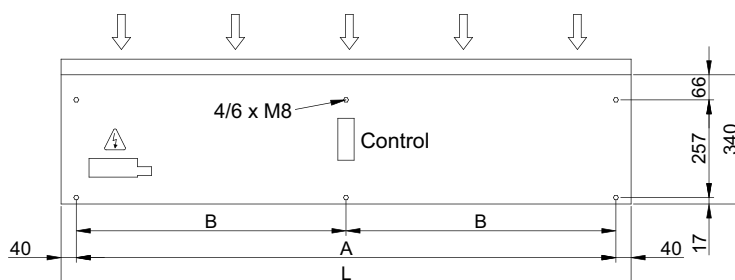

According to standard NSF-37-2012, the maximum installation height is the speed profile point at 8,14m/s plus 0,9m. So FLY K can be used until 1,15m+0,9m=2,05m.



**Characteristics**



- Specially designed for insects control at entranceways such as food establishments and industry, hospitals or clean zones.
  - High velocity air barrier to prevent flying insects from entering a building. Up to 3,5m height doors according to NSF 37 standard
  - Self-supporting casing construction made of galvanized steel plate, finished in structural epoxy-polyester painting white colour RAL9016 as standard. Other colours or stainless steel are available on request.
  - Large perforated inlet grille avoiding intensive maintenance.
  - Anodized aluminium outlet vanes, airfoil shaped, adjustable from 0 to 15° each side.
  - EC Double-inlet centrifugal fans driven by an external rotor motor and low noise level, with very low consumption efficiency fans.
  - "A" type without heating, air only.
  - Includes Plug&Play Hand Auto control with 7m RJ45 cable and magnetical door contact.
- Optional: Clever control (programmable, automatic, intelligent, energy saving, Modbus RTU for BMS...).

**Specifications**

**AIR ONLY**

Model	Airflow m <sup>3</sup> /h	Power Fans 230V-50Hz kW	Current Fans 230V-50Hz A	Noise Level (5 m) dB(A)	Weight kg
FLY KBB 1000 A	3900	0,921	4,08	67	38
FLY KBB 1500 A	5200	1,228	5,44	67,5	62
FLY KBB 2000 A	7800	1,842	8,16	68	77
FLY KBB 2500 A	9100	2,149	9,52	68,5	93
FLY KBB 3000 A	10400	2,456	10,88	69	106

**Dimensions**

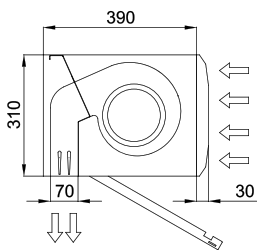

L	A	B
1000	920	-
1500	1420	710
2000	1920	960
2500	2420	1210
3000	2920	1460

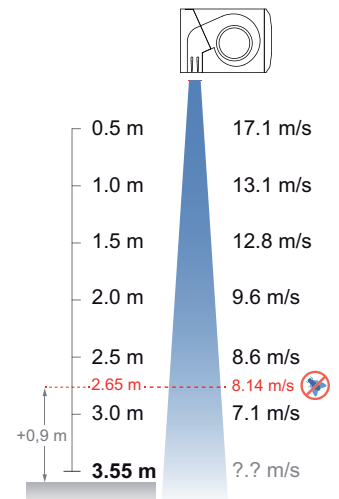
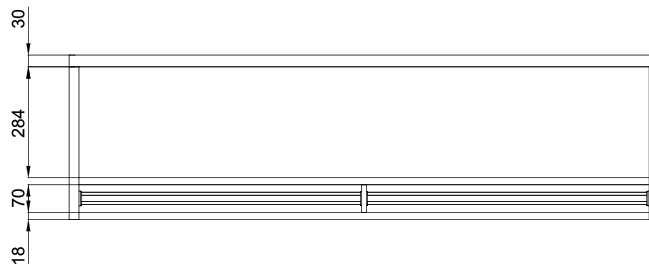
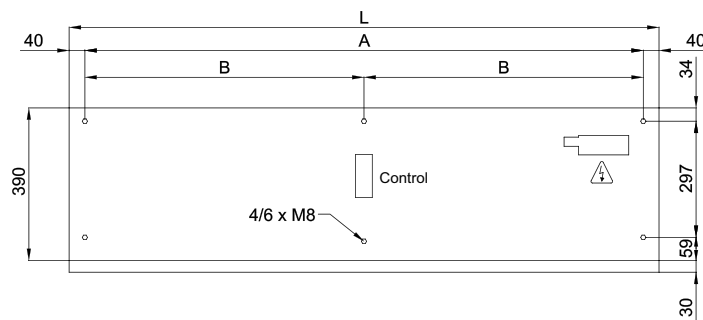

According to standard NSF-37-2012, the maximum installation height is the speed profile point at 8,14m/s plus 0,9m. So FLY KBB can be used until 2,65m+0,9m=3,55m.



**Characteristics**



- Specially designed for insects control at entranceways such as food establishments and industry, hospitals or clean zones.
  - High velocity air barrier to prevent flying insects from entering a building. Up to 3m height doors according to NSF 37 standard
  - Self-supporting casing construction made of galvanized steel plate, finished in structural epoxy-polyester painting white colour RAL9016 as standard. Other colours or stainless steel are available on request.
  - Large perforated inlet grille avoiding intensive maintenance.
  - Anodized aluminium outlet vanes, airfoil shaped, adjustable from 0 to 15° each side.
  - Double-inlet centrifugal fans driven by an external rotor motor and low noise level. 5-speed selector.
  - "A" type without heating, air only.
  - Includes Plug&Play Hand Auto control with 10m RJ45 cable and magnetical door contact.
- Optional: Clever control (programmable, automatic, intelligent, energy saving, Modbus RTU for BMS...).

**Specifications**

**AIR ONLY**

Model	Airflow m³/h	Fans Power 230V-50Hz kW	Fans Current 230V-50Hz A	Noise Level (5 m) dB(A)	Weight kg
FLY KL 1000 A	4000	1,04	4,40	63	76
FLY KL 1500 A	6000	1,56	6,60	64	114
FLY KL 2000 A	8000	2,08	8,80	65	153
FLY KL 2500 A	10000	2,60	11,00	66	187
FLY KL 3000 A	12000	3,12	13,20	67	225

**Dimensions**

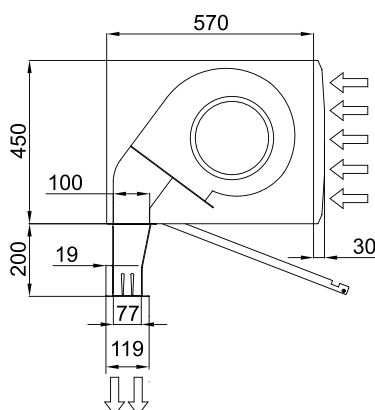
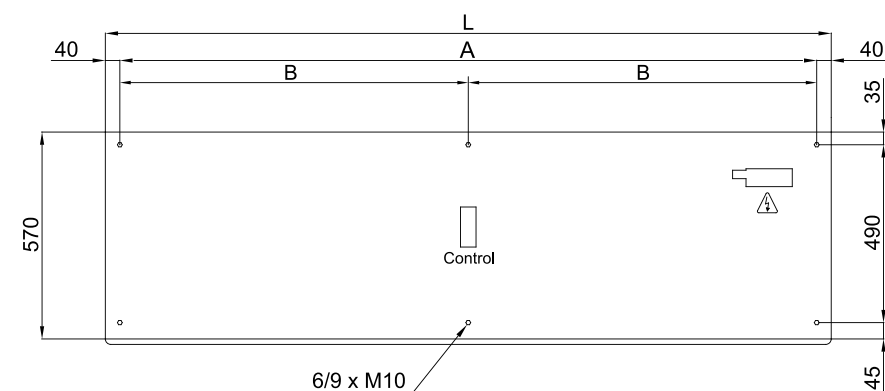

L	A	B
1000	920	-
1500	1420	710
2000	1920	960
2500	2420	1210
3000	2920	1460

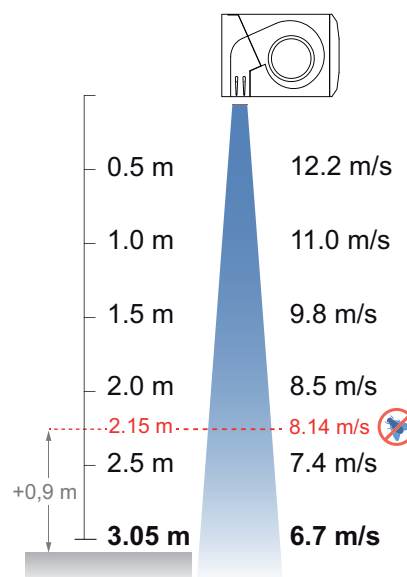

According to standard NSF-37-2012, the maximum installation height is the speed profile point at 8,14m/s plus 0,9m. So FLY KL can be used until 2,15m+0,9m=3,05m.



**Characteristics**



- Specially designed for insects control at entranceways such as food establishments and industry, hospitals or clean zones.
  - High velocity air barrier to prevent flying insects from entering a building. Up to 4m height doors according to NSF 37 standard
  - Self-supporting casing construction made of galvanized steel plate, finished in structural epoxy-polyester painting white colour RAL9016 as standard. Other colours or stainless steel are available on request.
  - Large perforated inlet grille avoiding intensive maintenance.
  - Anodized aluminium outlet vanes, airfoil shaped, adjustable from 0 to 15° each side.
  - Double-inlet centrifugal fans driven by an external rotor motor and low noise level. 5-speed selector.
  - "A" type without heating, air only.
  - Includes Plug&Play Hand Auto control with 10m RJ45 cable and magnetical door contact.
- Optional: Clever control (programmable, automatic, intelligent, energy saving, Modbus RTU for BMS...).

**Specifications**

**AIR ONLY**

Model	Airflow m <sup>3</sup> /h	Fans Power 230V-50Hz kW	Fans Current 230V-50Hz A	Noise Level (5 m) dB(A)	Weight kg
FLY KXL 1000 A	5300	1,40	6,00	65	82
FLY KXL 1500 A	7950	2,10	9,00	66	123
FLY KXL 2000 A	10600	2,80	12,00	67	165
FLY KXL 2500 A	13250	3,50	15,00	68	202
FLY KXL 3000 A	15900	4,20	18,00	69	243

**Dimensions**

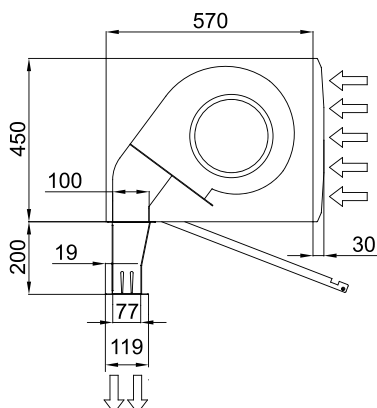
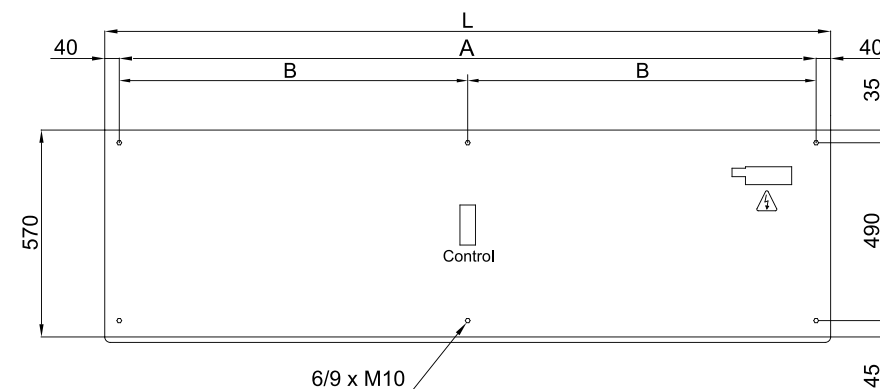

L	A	B
1000	920	-
1500	1420	710
2000	1920	960
2500	2420	1210
3000	2920	1460

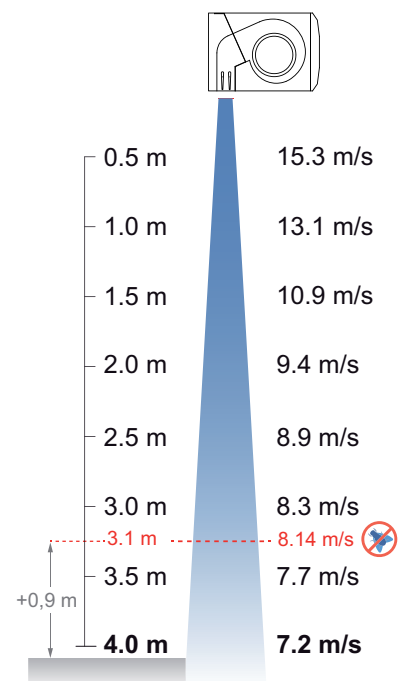

According to standard NSF-37-2012, the maximum installation height is the speed profile point at 8,14m/s plus 0,9m. So FLY KXL can be used until 3,1m+0,9m=4,0m.



The FLY DUO system consists on two air curtains with a middle shared air inlet plenum.  
This double jet system works as a closed circuit creating a separation zone at the door entrance.  
The first air jet fights directly against external insects infiltration. The air jet direction can be adjusted towards outside depending on the conditions of each installation.  
The second jet collects the possible insects infiltrations, guiding them to the central inlet plenum in order to drive them out.

**Fly Duo System With Plenum**

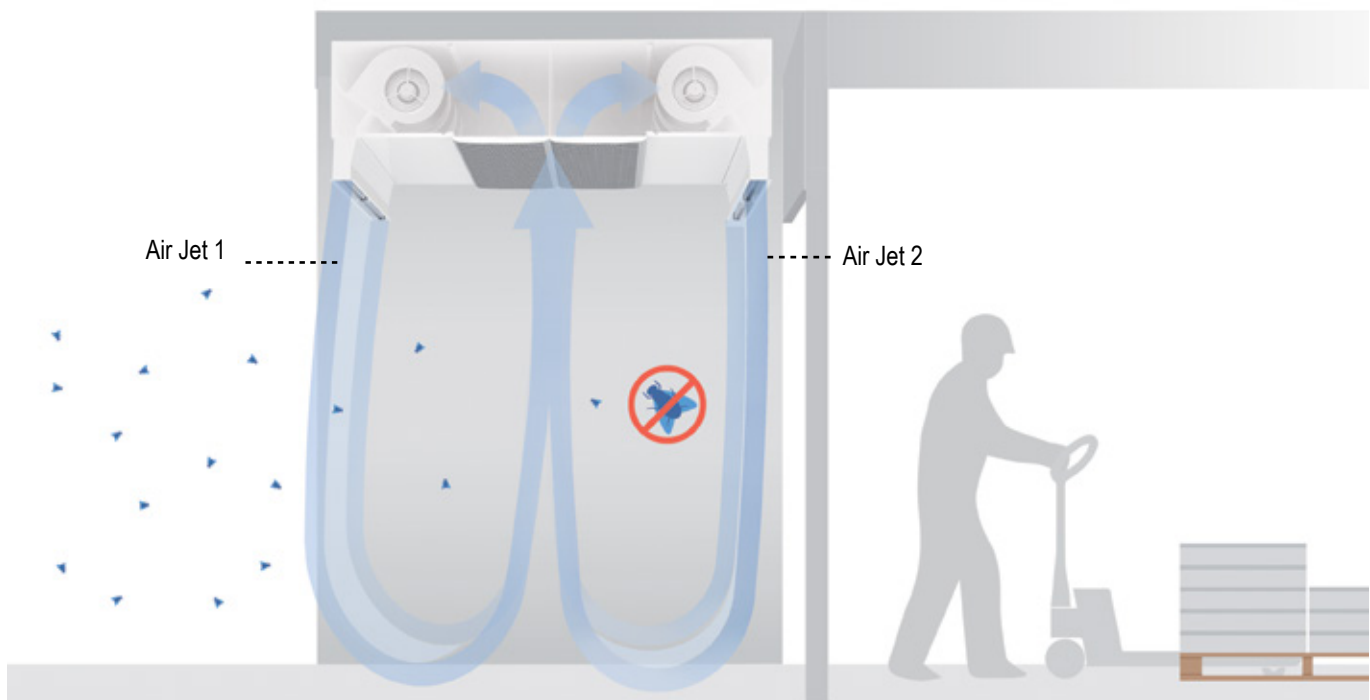

**Fly Duo System Without Plenum**

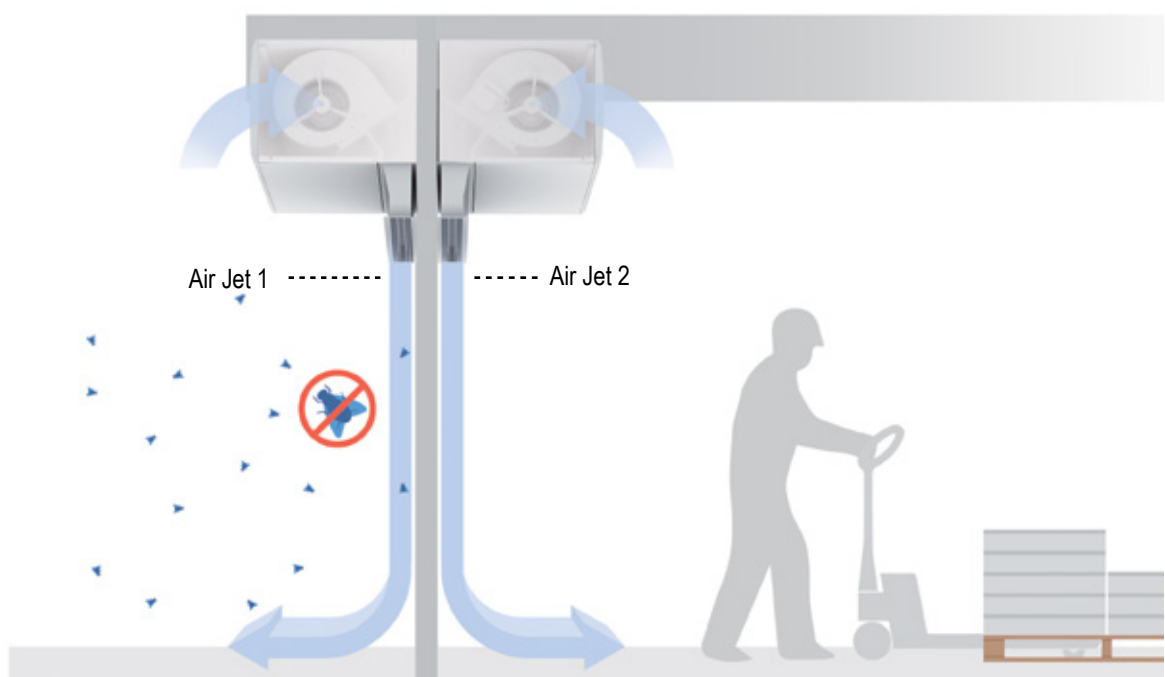



# FLY DUO SYSTEM | High Efficiency Duo System With 2 Jets Insect Control Air Curtains



## Dimensions

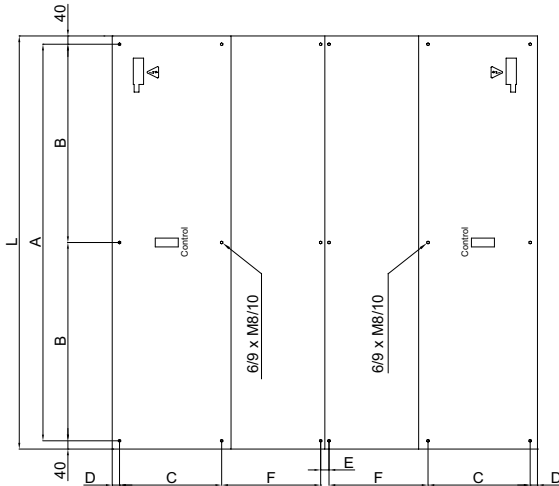
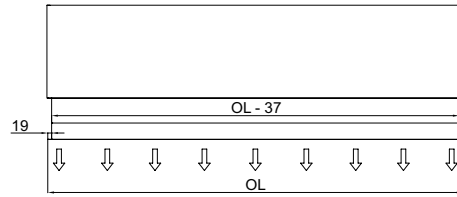
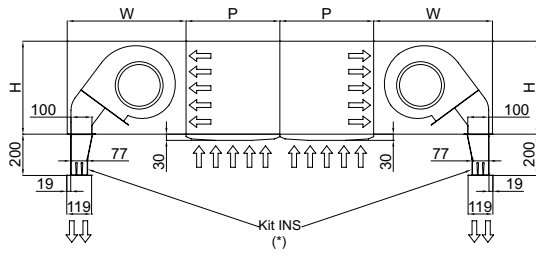

FLY Duo K - Plenum										
L	H	W	P	A	B	C	D	E	F	OL
1000	260	340	260	920	-	257	17	40	305	998
1500				1420	710					1498
2000				1920	960					1998
2500				2420	1210					2498
3000				2920	1460					2998

FLY Duo KBB - Plenum										
L	H	W	P	A	B	C	D	E	F	OL
1000	310	390	310	920	-	297	34	40	349	998
1500				1420	710					1498
2000				1920	960					1998
2500				2420	1210					2498
3000				2920	1460					2998

FLY Duo KLXL + Kit INS - Plenum										
L	H	W	P	A	B	C	D	E	F	OL
1000	450	570	450	920	-	490	35	40	475	998
1500				1420	710					1498
2000				1920	960					1998
2500				2420	1210					2498
3000				2920	1460					2998

(\* ) OD Kit Ins only for FLY KLXL configuration

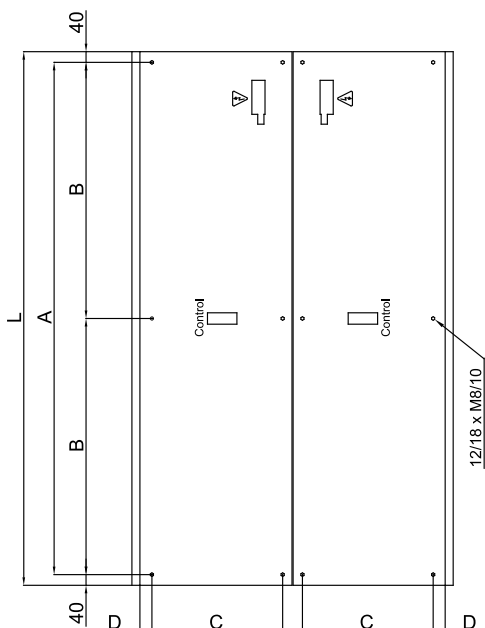
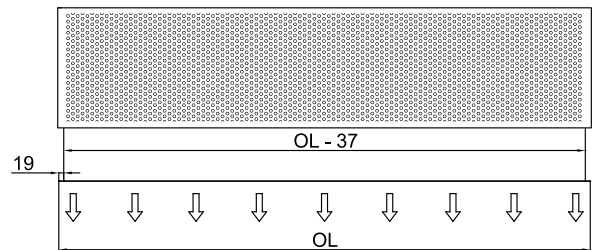
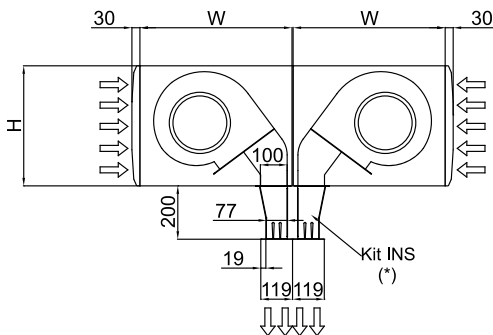

FLY Duo K							
L	H	W	A	B	C	D	OL
1000	260	340	920	-	257	66	998
1500			1420	710			1498
2000			1920	960			1998
2500			2420	1210			2498
3000			2920	1460			2998

FLY Duo KBB							
L	H	W	A	B	C	D	OL
1000	310	390	920	-	297	59	998
1500			1420	710			1498
2000			1920	960			1998
2500			2420	1210			2498
3000			2920	1460			2998

FLY Duo KLXL							
L	H	W	A	B	C	D	OL
1000	450	570	920	-	490	45	998
1500			1420	710			1498
2000			1920	960			1998
2500			2420	1210			2498
3000			2920	1460			2998

(\* ) OD Kit Ins only for FLY KLXL configuration



**Characteristics**

**Without Plenum**



**With Plenum**



- Specially designed to be installed in places with higher insect and pest control requirements with maximum screening capacity.
- System composed by two air curtains to increase the efficiency against flies. Two available configurations depending on installation conditions "Without Plenum" or "With Plenum".
- Side walls to cover from the door to the jets should be provided by others.
- Self-supporting casing construction made of galvanized steel plate, finished in structural epoxy-polyester painting white colour RAL9016 as standard. Other colours or stainless steel are available on request.
- Large perforated inlet grille avoiding intensive maintenance.
- Anodized aluminium outlet vanes, airfoil shaped, adjustable from 0 to 15° each side.
- EC Double-inlet centrifugal fans driven by an external rotor motor and low noise level, with very low consumption efficiency fans.
- "A" type without heating, air only. On option, for climate separation, the inside air curtain can be "P" type with water heated coil or "E" type with electrical shielded elements, three stages with integrated regulation.
- Includes Plug&Play Hand Auto control with 7m RJ45 cable and magnetical door contact.  
Optional: Clever control (programmable, automatic, intelligent, energy saving, Modbus RTU for BMS...).

**Specifications**

AIR ONLY					
Model	Airflow m <sup>3</sup> /h	Power Fans 230V-50Hz kW	Current Fans 230V-50Hz A	Noise Level (5 m) dB(A)	Weight kg
FLY DUO KBB 1000 A	7.800	1,842	8,16	70	-
FLY DUO KBB 1500 A	10.400	2,456	10,88	70,5	-
FLY DUO KBB 2000 A	15.600	3,684	16,32	71	-
FLY DUO KBB 2500 A	18.200	4,298	19,04	71,5	-
FLY DUO KBB 3000 A	20.800	4,912	21,76	72	-



**Characteristics**

**Without Plenum**



**With Plenum**



- Specially designed to be installed in places with higher insect and pest control requirements with maximum screening capacity.
- System composed by two air curtains to increase the efficiency against flies. Two available configurations depending on installation conditions "Without Plenum" or "With Plenum".
- Side walls to cover from the door to the jets should be provided by others.
- Self-supporting casing construction made of galvanized steel plate, finished in structural epoxy-polyester painting white colour RAL9016 as standard. Other colours or stainless steel are available on request.
- Large perforated inlet grille avoiding intensive maintenance.
- Anodized aluminium outlet vanes, airfoil shaped, adjustable from 0 to 15° each side.
- Double-inlet centrifugal fans driven by an external rotor motor and low noise level. 5-speed selector.
- "A" type without heating, air only. On option, for climate separation, the inside air curtain can be "P" type with water heated coil or "E" type with electrical shielded elements, three stages with integrated regulation.
- Includes Plug&Play Hand Auto control with 10m RJ45 cable and magnetical door contact  
Optional: Clever control (programmable, automatic, intelligent, energy saving, Modbus RTU for BMS...).

**Specifications**

AIR ONLY					
Model	Airflow m <sup>3</sup> /h	Fans Power 230V-50Hz kW	Fans Current 230V-50Hz A	Noise Level (5 m) dB(A)	Weight kg
FLY DUO KL 1000 A	8.000	2,08	8,8	66	-
FLY DUO KL 1500 A	12.000	3,12	13,2	67	-
FLY DUO KL 2000 A	16.000	4,16	17,6	68	-
FLY DUO KL 2500 A	20.000	5,20	22,0	69	-
FLY DUO KL 3000 A	24.000	6,24	26,4	70	-

AIR ONLY					
Model	Airflow m <sup>3</sup> /h	Fans Power 230V-50Hz kW	Fans Current 230V-50Hz A	Noise Level (5 m) dB(A)	Weight kg
FLY DUO KXL 1000 A	10.600	2,8	12,0	68	-
FLY DUO KXL 1500 A	15.900	4,2	18,0	69	-
FLY DUO KXL 2000 A	21.200	5,6	24,0	70	-
FLY DUO KXL 2500 A	26.500	7,0	30,0	71	-
FLY DUO KXL 3000 A	31.800	8,4	36,0	72	-

# ADVANCED REGULATION: Clever Control



The future is here with the new generation Clever control. Maximum control with maximum energy saving.

## What is Clever control?

Clever control automatically adapts the functioning of the air curtain to the entrance conditions, maintaining comfort while saving energy. It optimizes the ventilation and heating to make an efficient barrier for an optimal climate separation.



INTELLIGENT  
PROACTIVE  
REGULATION



It includes manual or automatic functioning with many different programs depending on heating type (water, electrical, heat pump or unheated) and installed temperature sensors. Special program for insect control.

## Clever kit includes:



### Clever Control

- Color TFT screen 2.8 inch
- 114 (h) x 85 (w) x 14 (d) mm
- Prepared for flush-mount installation



### PCB Power Supply

- Input: 100-240Vx1 50/60Hz (AC)
- Output: 24V 2A (DC)
- EU 2 pins / BS 3 pin plugs



### Outdoor Temperature Sensor

- Real-time temperature values
- IP65 Protection



### Intelligent PCB Box

- Electronic PCB Regulation
- 218 (w) x 140 (h) x 64 (d) mm
- Varnish Protection



### RJ11 + RJ45 Cables

- Easy Plug & Play installation
- RJ11 (4 Pins), 7m length
- RJ45 (8 Pins), provided with the air curtain



### Door Contact

- Monitoring Door Status
- Magnetic contact

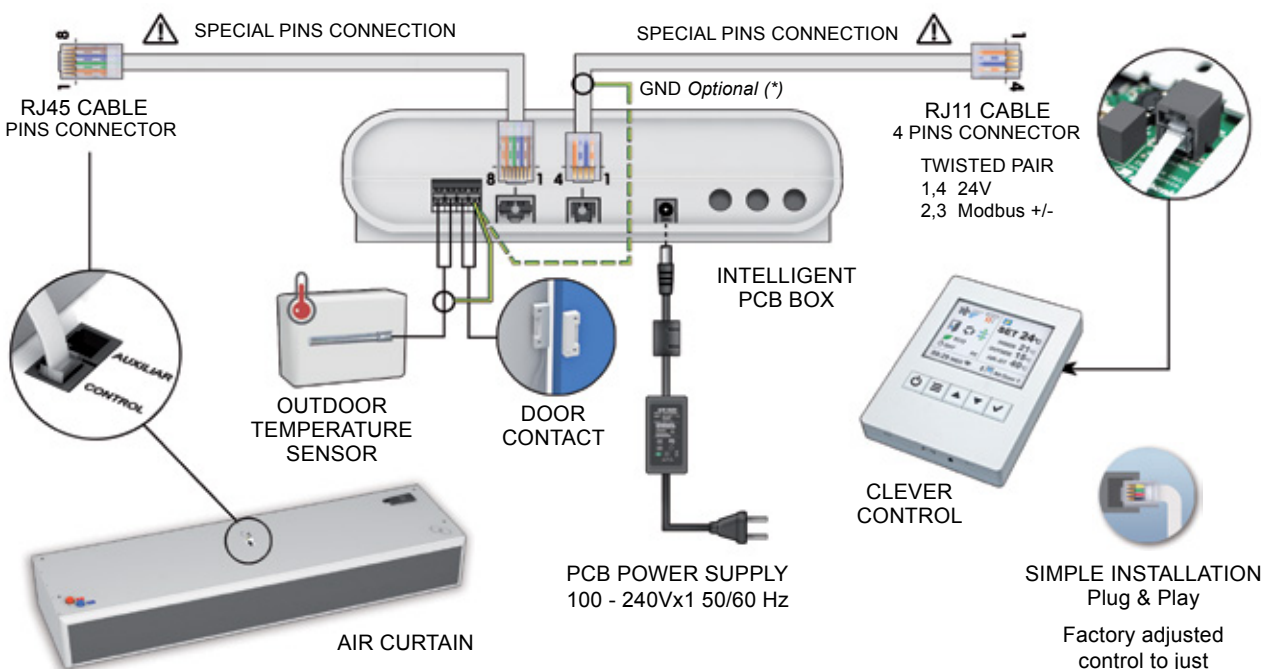

**SIMPLE INSTALLATION**  
Plug & Play  
Factory adjusted control to just switch on and run

(\*) If there are communication issues (interferences), use shielded cable connected to GND



Clever control includes lots of advanced functions and extras to fulfill all client needs.

## Advanced functions:

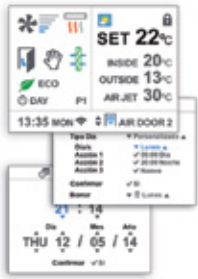

### USER FRIENDLY DESIGN

Multilanguage and easy icons for fully understanding.  
Main state screen: ventilation speed, heating, temperatures, door state, working mode and program, filter state, day/hour, timer, etc. 3 different menu configurations depending on who is managing the equipment: user, basic or advanced.



### ENERGY SAVING

3 grades of comfort and energy efficiency: "Eco" uses the less energy possible without compromising too much the comfort. "Comfort" spends more ventilation/heating to maintain / achieve quicker the Set temperature. "Medium" is in between.



### ADAPTIVE DOOR DELAY

Air curtain delay: when the door closes, the air curtain remains working at door open conditions for certain time to be ready if it opens again.

Door opening delay: the door remains closed until the air curtain achieve the nominal speed to protect against insects



### TIMER (DAY/NIGHT)

To turn ON DAY, ON NIGHT or OFF automatically the unit depending on each different day of the week or predefined groups of days.

User can select between Day or Night modes with 2 different Set temperatures in order to save energy.



### COMPATIBLE

Android or Apple smartphone application with user functions connected via WIFI.

BMS communication with Modbus RTU protocol or using digital and analogical IN/OUT to control or monitor directly the unit. Modbus TCP/Bluetooth optional modules. PC Windows program (RS485).



### FILTER ALARM

Indicates when filter needs replacing/cleaning. 2 options: by "Timer" of functioning hours or by "Pressure Sensor" switch.



### FULLY PROGRAMMABLE

All parameters can be configured at Basic or Advanced menu.

Lots of extra functions to fulfill all clients applications. Editable device names for easy identification.



### MULTI-EQUIPMENT

Clever works with different types of units: air curtains, fan heater, AHU, etc. Once programmed, PCB can work by itself without any controller. One Clever TFT can manage up to 255 different units, each one with its own program.

## Other Characteristics:

- Clever is factory adjusted according to the device/s and client requirements
- Once installed, the system checks automatically all connected units and its temperature sensors
- Different integrated programs and functions for particular applications
- Different programs depending on installed temperature sensors: inside, outside and air jet
- Able to regulate by itself the ventilation and heating depending on: door state, temperature sensors, selected working mode, grade of energy saving, program and other parameters
- Alarms: general, filter state, anti freezing, overheating, fans overheating, airflow, fire, external, heating locked, etc.
- Security control buttons lock option by code
- Modulating valve for water heated (includes 24VDC power supply)
- Multiple functions: temporized door, excessive temperature of water return, cooling mode and others

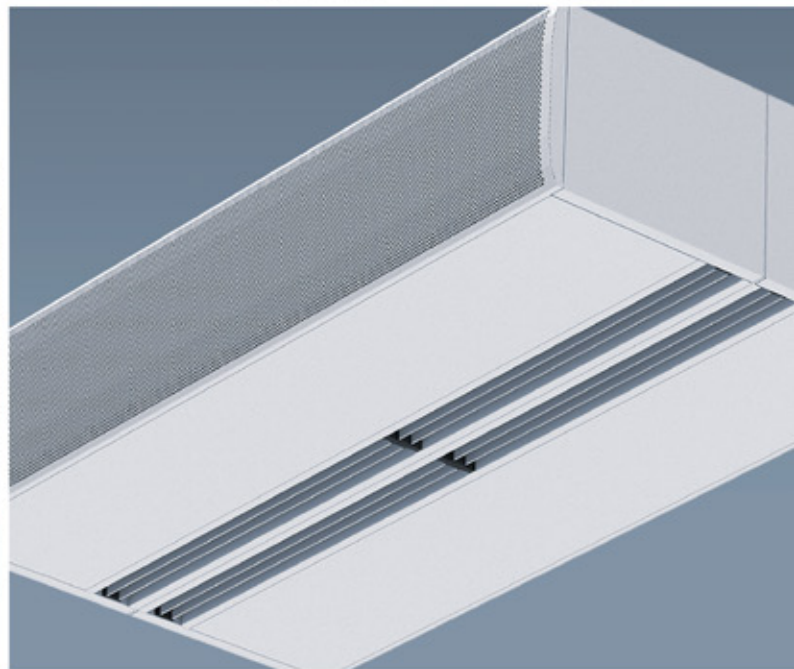
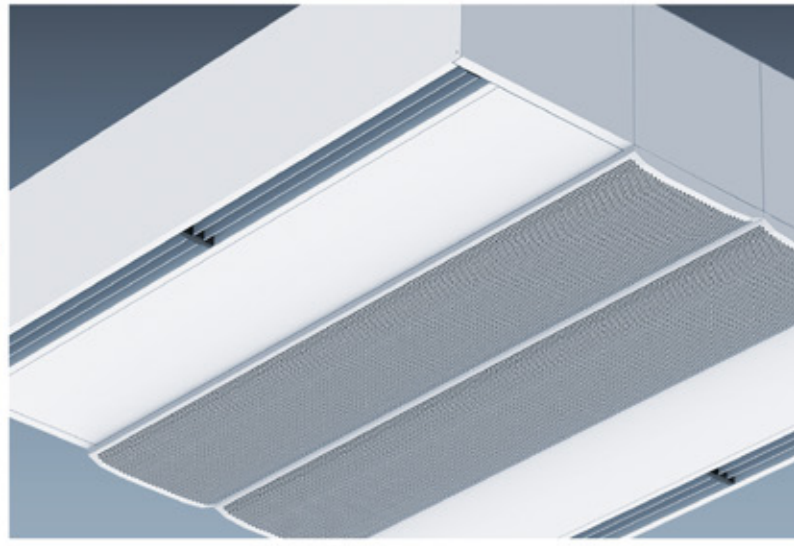
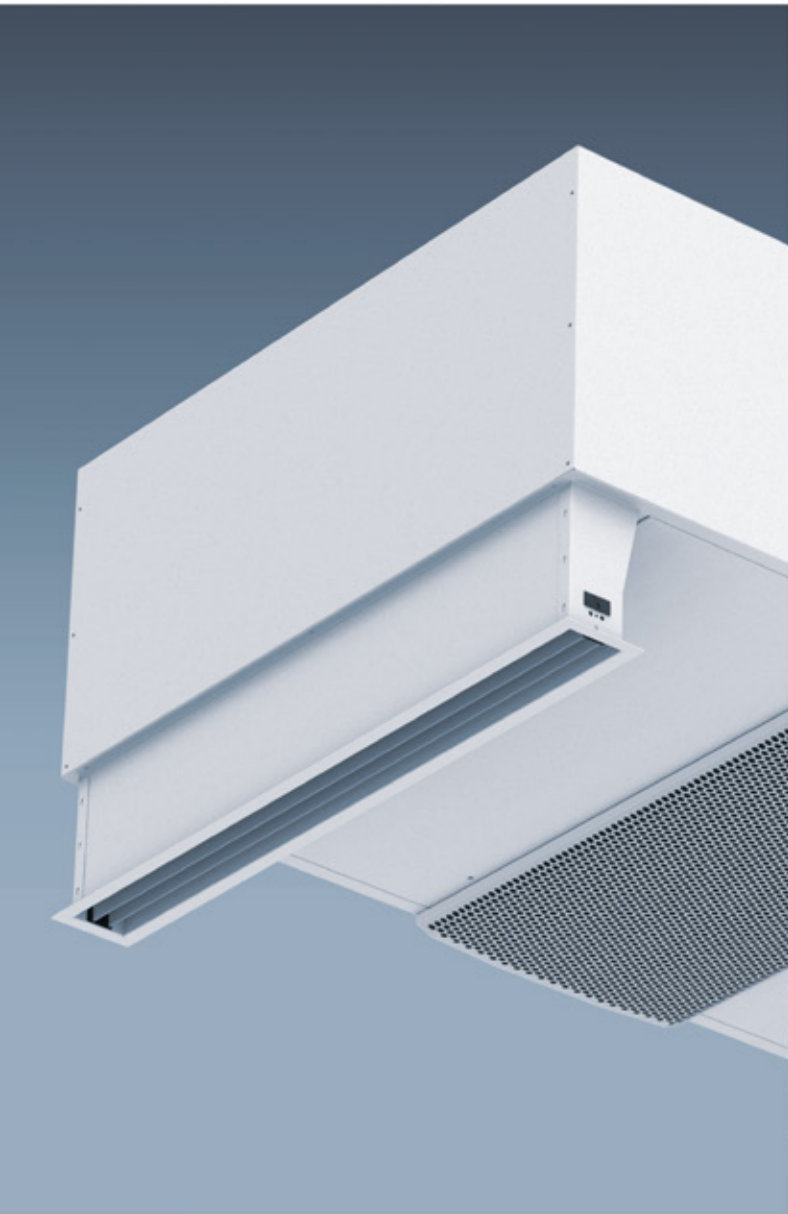

Conca de Barberà, 6 - Pol. Ind. Pla de la Bruguera  
E-08211 Castellar del Vallès (Barcelona) Spain  
☎ + 34 93 715 99 88  
airtechnics@airtechnics.com

**www.airtechnics.com**

