

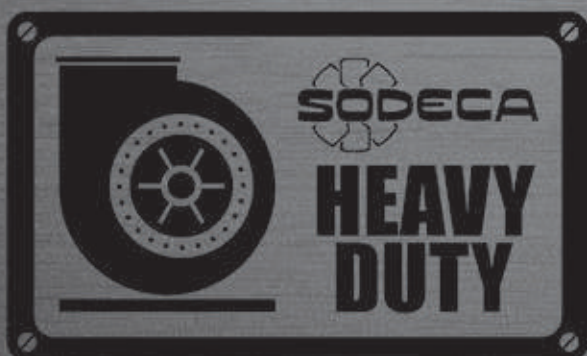

HEAVY DUTY FANS FOR INDUSTRIAL APPLICATIONS





Sodeca se ha especializado desde sus orígenes en el diseño y la fabricación de ventiladores y sus accesorios para aplicaciones industriales.

La unión de la experiencia adquirida durante décadas de trabajo con ventiladores, junto con la tecnología aportada por ingenieros distribuidos en diferentes departamentos, ha permitido que Sodeca se sitúe entre los mayores fabricantes de ventilación industrial del mundo.

Las aplicaciones industriales requieren gran capacidad de adaptación a las especificaciones de cada proyecto y flexibilidad en la fabricación, para cumplir con las necesidades reales de cada cliente.

Para cumplir con este objetivo Sodeca dispone de una línea de productos Standard y una línea de productos de fabricación especial.

La división de Heavy Duty de Sodeca se ha especializado en la construcción de ventiladores y extractores de gran formato, adaptados a las experiencias de nuestros clientes.

DIVISIÓN HEAVY DUTY

+34 93 504 16 65
divisionhd@sodeca.com



HEAVY DUTY FANS FOR INDUSTRIAL APPLICATIONS



Durante años se ha invertido de forma constante, en el desarrollo de procesos y aplicaciones internas, para conseguir la fabricación y el suministro de ventiladores industriales especiales, con un tiempo de diseño y fabricación extremadamente reducido.

El trabajo en equipo de nuestro departamento de ingeniería, junto con universidades y centros tecnológicos, así como la estrecha colaboración entre los departamentos de diseño de nuestros colaboradores externos, hace posible conseguir innovadoras soluciones de ventilación industrial en un corto plazo de tiempo.

A lo largo de nuestra historia hemos desarrollado todo tipo de tecnología en ventiladores para aplicaciones industriales que actualmente están repartidos por todo el mundo, nuestro objetivo es seguir invirtiendo en este sector para seguir siendo uno de los fabricantes de ventiladores industriales más reconocidos en el mundo.





HEAVY DUTY FANS FOR INDUSTRIAL APPLICATIONS

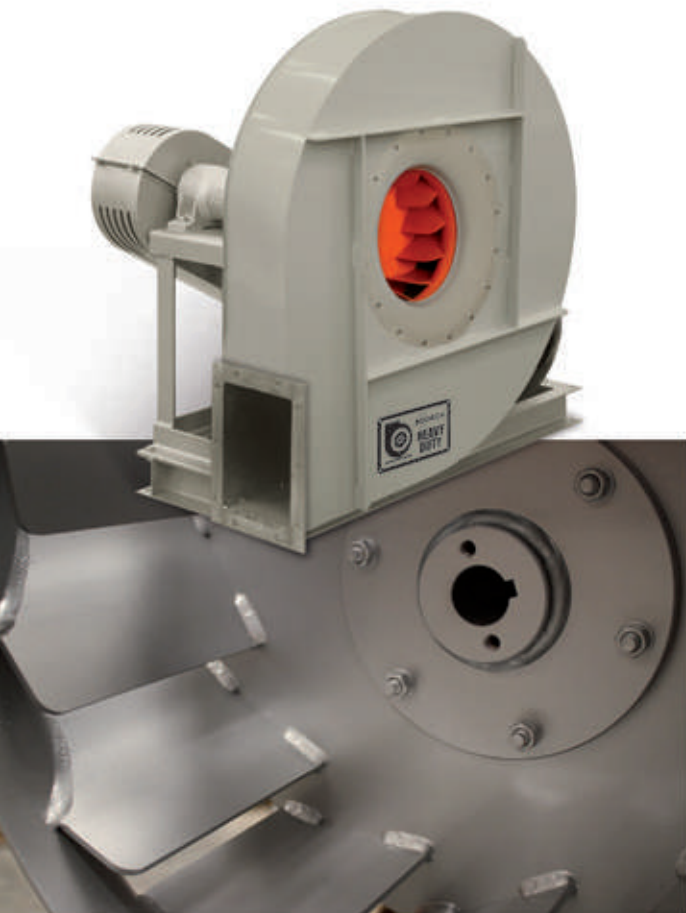

Ventiladores estudiados para satisfacer diversas exigencias de numerosos campos de aplicación industrial.

Se instalan principalmente en los sistemas de acondicionamiento civil e industrial, en las plantas de secado, en cabinas de pintura, calderas, hornos, quemadores industriales, depuración de gases, transportes de material, cementeras, atmósferas explosivas ATEX, Oil&Gas y otros.

Su versatilidad de uso y amplia gama nos permite ofrecer una solución a cada necesidad.

ROBUSTEZ

Su robusta construcción es una de sus características principales: los cojinetes se han dimensionado para una vida útil mínima de 40.000 horas; correas y poleas dimensionadas para trabajos continuados, protección de las transmisiones cerradas, bancadas soporte, los espesores de las chapas y la posición de los soportes y de los refuerzos han sido especialmente analizados para garantizar la ausencia de vibraciones.





TEMPERATURAS DE TRABAJO

Accionamiento directo, rodete calado en el eje motor, capaces de trabajar con temperaturas de 60°C en forma standard y 150°C con rodete de refrigeración.

Para ventiladores a transmisión 300°C con rodete de refrigeración y construcción especial bajo demanda hasta 450°C.

CONTROL

El control integral de todo el proceso de fabricación nos permite ofrecer la más alta calidad exigida para este tipo de producto.

Las turbinas se equilibran estática y dinámicamente utilizando equipos electrónicos según las normas de ISO 1940 grado G=2,5. Los parámetros de prestación de los ventiladores se han medido con tubos de salida según las normas UNI 7179-73 y las normas AMCA 210-85. Las prestaciones de nuestros ventiladores son de clase tolerancia 2 según las normas DIN 24 166, y Clase AN3, según normas ISO/CD 13348.2.

BAJO DEMANDA

Bajo demanda podemos ofrecer ventiladores especiales para acerías, cementeras, aplicaciones especiales, materiales especiales, alta temperatura, anti desgaste...

Válvulas de regulación de caudal en impulsión/ aspiración de accionamiento manual, neumático o eléctrico.

Formas constructivas 7 y 8 según AMCA Standard 99-2404-03 están igualmente disponibles.





HEAVY DUTY FANS FOR INDUSTRIAL APPLICATIONS



Acoplamiento elástico sistema 8
Elastic joint coupling arrangement 8

APLICACIONES INDUSTRIALES

Calderas industriales, plantas de secado, hornos, quemadores industriales, depuración de gases, transportes de material, cementeras, atmósferas explosivas ATEX, Oil&Gas, son algunas de las aplicaciones de este tipo de ventiladores.

APLICACIONES ATMÓSFERAS EXPLOSIVAS ATEX

Todos los extractores y ventiladores SODECA para atmósferas explosivas cumplen con las exigencias de la directiva europea ATEX 94/9/CE y han estado diseñados de acuerdo a la norma EN-14986 "Diseño de ventiladores para trabajar en atmósferas potencialmente explosivas".

De esta forma se garantiza la calidad de los productos y se asegura al máximo la seguridad de las personas e instalaciones.





APLICACIONES NAVALES APLICACIONES OFF-SHORE

Los extractores SODECA para aplicaciones navales & offsho-re, son reconocidos por su calidad y buen funcionamiento en estas aplicaciones, por la mayoría de constructores de barcos, así como empresas de defensa civil del mundo. Los extractores bajo demanda pueden cumplir con los diferentes requerimientos de las sociedades de clasificación y certificación. Los motores marinos utilizados están certificados por la mayoría de entidades internacionales de clasificación naval.

APLICACIONES MINERIAS Y OBRAS PÚBLICAS

Extractores axiales tubulares de alta presión y gran robustez, especialmente diseñados para instalaciones de minería, navales o aplicaciones con grandes pérdidas de carga. Ventiladores tubulares bifurcados para trasegar aire hasta 150°C en continuo.

Son algunas de nuestras variantes perfectamente adaptadas para trabajos a realizar donde las condiciones ambientales, movimientos de tierras o la difícil extracción de gases son claves para mantener la seguridad en el lugar de trabajo de los profesionales. La amplia gama de productos nos permite ofrecer soluciones para la ventilación de túneles durante y después de su proceso de construcción.



TYPE APPROVAL CERTIFICATE FOR MARINE AND OFFSHORE APPLICATIONS

Los extractores SODECA para aplicaciones navales & off-shore, son reconocidos por su calidad y buen funcionamiento en estas aplicaciones, por la mayoría de constructores de barcos, así como empresas de defensa civil del mundo. Los extractores bajo demanda pueden cumplir con los diferentes requerimientos de las sociedades de clasificación y certificación.

Los motores marinos utilizados están certificados por la mayoría de entidades internacionales de clasificación naval:

ABS:	América Bureau of shipping
BV:	Bureau Veritas
CCS:	China Classification Societies
CR:	China Corporation Register of Shipping
DNV:	Det Norske Veritas
GL:	Germanischer Lloyd
KR:	Korean Register of shipping
LR:	Lloyd's Register of Shipping
NK:	Nippon Kaiji Kyokai
RINA:	Registro Italiano Navale
RS:	Russian Maritime Register of Shipping

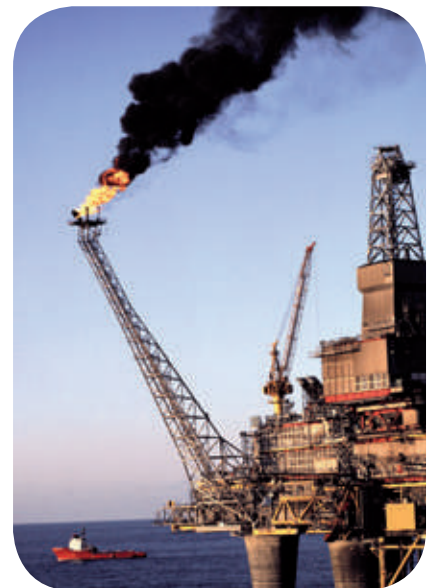

STANDARDS COMPLIANCE FOR RAILWAY AND ROLLING EQUIPMENT

Related standards:

GOST 30630.0.0-99	Environment stability test methods for machines, instruments and other industrial products.
GOST 28231-89	(IEC 68-2-47-82) Basic methods of testing for exposure to external factors. Part 2. Testing. Fastening of elements, tools and other products in the course of dynamic testing. Including shock (Ea), multiple shock (Eb), vibration (Fc and Fd), linear acceleration (Ga) and Guidance.
GOST 30630.1.1-99	Methods of testing for resistance of machinery, instruments and other technical products to externally acting mechanical factors. Determining dynamic characteristics of a structure.
GOST 30630.1.2-99	Methods of testing for resistance of machinery, instruments and other technical products to externally acting mechanical factors. Vibration testing. . Testing for stability under exposure to sinusoidal or accidental wide-band vibration. . Long-run testing for durability under exposure to sinusoidal or accidental wide-band vibration (long-run chatter testing). . Testing for durability under exposure to multiple mechanical shocks (shock strength testing).
GOST 30631-99	General requirements to machinery, instruments and other technical products with regard to resistance to externally acting mechanical factors during operation.
GOST 17516.1	1990-MAY-23 Electrotechnical articles general requirements for stability to effect of environmental mechanical factors – Incorporates Amendment 1: 11/21/1997
UNE-EN 61373	Aplicaciones Ferroviarias, Material rodante, Ensayos de choque y vibración. Railway applications. Rolling equipment. Shock and vibration tests

Vibrations

The table presented below shows the vibration requirements for mounted equipment in A-Class vehicle. Sodeca fans complies GOST vibration requirements which are the most restrictive.

EN Standard

Standard number	Vibration type	Vibration RMS X Axis [m/s ²]	Vibration RMS Y Axis [m/s ²]	Vibration RMS Z Axis [m/s ²]	Vibration frequency [Hz]
EN 61373-2011	Increased random vibrations	2,83	2,09	4,25	-
	Standard random vibrations	0,50	0,37	0,75	-

GOST Standard

Standard number	Vibration type	Vibration amplitude X Axis [m/s ²]	Vibration amplitude Y Axis [m/s ²]	Vibration amplitude Z Axis [m/s ²]	Vibration frequency [Hz]
GOST 17516.1-1990 + GOST 16692.2 & GOST 30631-1999 + GOST 30630.0.0	Long term sinusoidal vibrations	15	15	15	10-100
GOST 17516.1-1990 + GOST 16692.2 & GOST 30631-1999 + GOST 30630.0.0	Short term sinusoidal vibrations	10	10	10	10-100

The next two figures shows displacement and stress maps for a Sodeca fan under the vibration required by GOST standard in the Y axis. The test method consists in 687 repetitions 7 minutes long. The vibration is simulated with a sinusoidal acceleration of 15 m/s² amplitude and frequency 100 Hz. At the end of the test the fan has to endure 28.8 million of cycles.

Fan's displacement map after the test. The displacement that is shown in the image has been increased to make it visible. The maximum displacement is 1.06 mm.

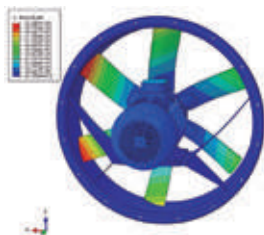

Fan's stress map after the test. The maximum stress is 69.7 MPa for steel parts and 65 MPa for aluminium parts. It is the maximum for all axes.

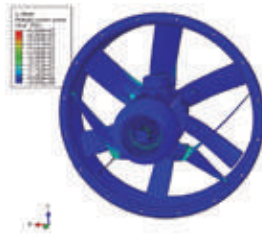

The cast aluminium's fatigue limit for 28.8 million cycles is about 80 MPa. All Aluminium parts have a stress below 65 MPa, so all this parts meet the requirements. The steel's fatigue limit is much higher than aluminium, so all steel parts meets too the requirements.

ASCAMM technology centre studies Sodeca fans to assure the compliance with GOST and EN standards for products mounted in railway and rolling equipment. ASCAMM uses numerical simulations to check the fan design under the vibration and shock conditions required by the standards.



Impacts

The table presented below shows the impact requirements for mounted equipment in A-Class vehicle. Sodeca fans complies EN-61737 impact requirements which are the most restrictive.

Impact requirements	EN 61373-2011
Acceleration X Axis [m/s ²]	50
Acceleration Y Axis [m/s ²]	30
Acceleration Z Axis [m/s ²]	30
Duration [m/s]	30

GOST 17516.1-1990 + GOST 16692.2 & GOST 30631-1999 + GOST 30630.0.0
30 m/s² (only one axis) Duration: 2-20 ms

The next two figures shows displacement and stress maps for a Sodeca fan under the impact requirement of EN-61373-2011 standard. The fan receives an impact with 30 m/s² acceleration and 30 ms duration in the Y axis.

Fan's displacement map after impact. The displacement that is shown in the image has been increased to make it visible. The maximum displacement is 0.12 mm.

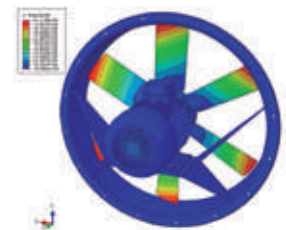

Fan's stress map after the impact. The maximum stress is 23.5 MPa for all axes; it is situated in the steel frame.

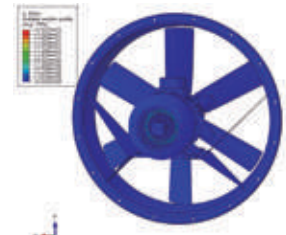

The test result confirms that the fan can resist the impact required by the standard, because 23.5 MPa is a stress value too low for steels.



ATMÓSFERAS EXPLOSIVAS ATEX

Todos los extractores y ventiladores SODECA para atmosferas explosivas cumplen con las exigencias de la directiva europea ATEX 94/9/CE y han estado diseñados de acuerdo a la norma EN-14986 "Diseño de ventiladores para trabajar en atmósferas potencialmente explosivas". De esta forma se garantiza la calidad de los productos y se asegura al máximo la seguridad de las personas e instalaciones.

CERTIFICADOS ATMÓSFERAS EXPLOSIVAS ATEX



Diseño de los ventiladores:

De acuerdo a la norma EN-14986 y para evitar la ignición en el caso de fricción o impacto entre la parte móvil y la estática, se fabrican con materiales combinables entre sí para prevenir posibles chispas.

Ventiladores centrífugos:

Para prevenir chispas generadas por la turbina:

- . Boca de aspiración de cobre
- . Casquillos de protección para proteger las uniones atornilladas/remachadas
- . Verificación de las distancias entre componentes

Ventiladores helicoidales:

- Para prevenir chispas generadas por la hélice:

- . Banda de recubrimiento de cobre o aluminio sobre la cara interior del aro
- . Verificación de las distancias entre componentes

Siguiendo la normativa, todas las partes del ventilador que no están soldadas entre sí, y están fijadas mecánicamente mediante otros sistemas, o son diferentes piezas recubiertas de pintura que pueden aislar la conductividad, están unidas mediante tomas de tierra, para evitar las diferencias de potencial entre estas partes no soldadas o pintadas.

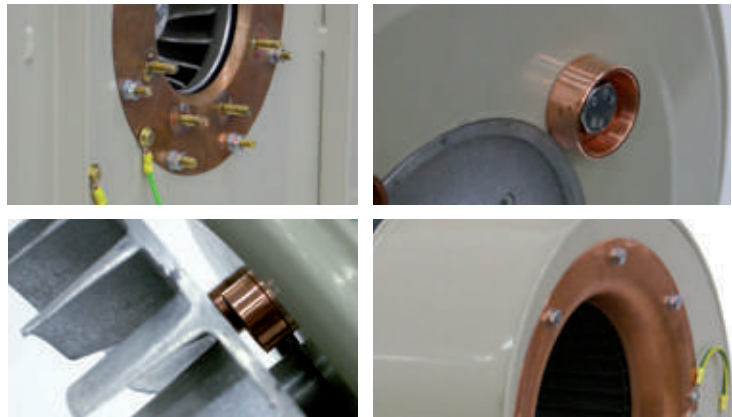

Sodeca se ha especializado desde sus orígenes en el diseño y la fabricación de ventiladores y sus accesorios para aplicaciones industriales.

La unión de la experiencia adquirida durante décadas de trabajo con ventiladores, junto con la tecnología aportada por ingenieros distribuidos en diferentes departamentos, ha permitido que Sodeca se sitúe entre los mayores fabricantes de ventilación industrial del mundo.

Las aplicaciones industriales requieren gran capacidad de adaptación a las especificaciones de cada proyecto y flexibilidad en la fabricación, para cumplir con las necesidades reales de cada cliente.

Para cumplir con este objetivo Sodeca dispone de una línea de productos Standard y una línea de productos de fabricación especial, para la construcción de ventiladores adaptados a las exigencias de nuestros clientes.

Para los diferentes proyectos podemos utilizar motores que cumplen las normativas más exigentes del mercado:

NEMA super premium efficiency

NEMA premium efficiency

NEMA high efficiency

U.L. motors

C.S.A. motors

Extractores para **ATMÓSFERAS EXPLOSIVAS ATEX**

Una zona ATEX es una mezcla de aire con **gas** inflamable, **vapor** de líquido inflamable, **niebla** de líquido combustible o **polvo** combustible, que de inflamarse lo hacen en todo su conjunto a la vez.



Sensibilidad a la inflamación de los gases:

LIE	Límite inferior de explosividad » % volumen.
LSE	Límite superior de explosividad » % volumen.
EMI	Energía mínima de Inflamación » 10-6 μ Joules
Flash Point	Temperatura mínima de un líquido forma gases inflamables
Temperatura de Ignición	Temperatura a la que inflama un gas (T1, T2, T3, T4, T5 y T6)

Sensibilidad a la inflamación de sólidos:

LIE ó CME	Concentración mínima explosiva » g/m ³
CLO	Concentración límite de Oxígeno » % volumen
EMI	Energía mínima de Inflamación » 10-3 μ Joules
TMI	Temperatura mínima de inflamación en °C: - En nube TMI n (nube de polvo en contacto con una superficie caliente). - En capa TMI c ignición de una capa de 5 mm. - (límite de T el menor de: 2/3 de TMI n o TMI c -75°C)

Resumen de definiciones de las zonas

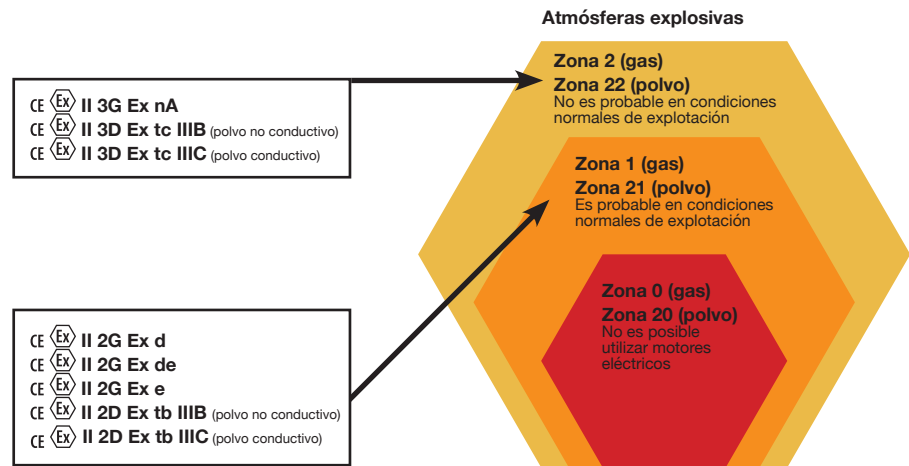

Definición de zonas:

Gases y vapores / Polvos:

- **Zona 0 / Zona 20:**
Presente continuamente, durante largos periodos de tiempo o frecuentemente. No es posible utilizar motores eléctricos.
- **Zona 1 / Zona 21:**
Es probable en condiciones normales de funcionamiento
- **Zona 2 / Zona 22:**
No es probable la creación de zona ATEX en condiciones de funcionamiento normal

Grupos y categorías de aparatos:

GRUPO I: equipos para trabajos subterráneos y de superficie de minas con peligro por grisú o polvos explosivos.

- Categoría M1: deben permanecer operativos
- Categoría M2: se debe poder cortar la alimentación de energía

GRUPO II: Otras zonas de riesgo

- Categoría 1: nivel de protección muy alto. Zona muy probable.
- Categoría 2: nivel de protección alto. Zona probable.
- Categoría 3: nivel de protección normal. Zona poco probable.

Selección de la categoría en función de la zona:

ZONA	CATEGORÍA
0 o 20	1
1 o 21	1 o 2
2 o 22	1, 2 o 3

Selección de zona en función de la categoría:

CATEGORÍA	ZONA
1	Todas
2	1, 21, 2 o 22
3	2 o 22

Grupo de explosión y clase de temperatura

Grupo de explosión	Clase de temperatura					
	T1	T2	T3	T4	T5	T6
II A	Acetona Etano Acetato etílico Cloruro de etilo Amoníaco Benceno Ácido acético	Óxido de carbono Metano Metanol Cloruro de metilo Propano Gas ciudad Tolueno	Acetato amílico-i Butano Alcohol butílico-n Ciclo-hexano Dicloroetano 1, 2 Anhídrido acético	Gasolina Carburantes Otto Carburante aviación Aceites combustib. Hexano	Acetal-dehido	
II B		Alcohol etílico Etileno Óxido de etileno	Hidrógeno sufarado	Eter etílico		
II C	Hidrógeno	Acetileno				Sulfuro de carbono

Clase de temperatura y temperatura de ignición:

Clase de temperatura	Temperatura de ignición
T1	>450°C
T2	>300°C
T3	>200°C
T4	>135°C
T5	>100°C
T6	>85°C

Valores de explosividad de sólidos combustibles

Producto	Kmax	Pmax	EMI	CLO	TMin	TIMc
Harina de maíz	127	6.7	300	--	530	460
Harina de arroz	40	6.7	>10	--	370	480
Harina de trigo	47	8.2	>300	11%	460	470
Harina de Malta	100	7.8	>10	11%	310	460
Almidón de maíz	143	10.6	>100	9%	440	400
Almidón de arroz	220	10.0	>10	--	470	390
Almidón de patata	89	9.4	>3000	--	520	570

Marcado según ATEX

Marcado de motores de acuerdo con la directiva ATEX

CE	0081	Ex	II	2	G/D
Marcado CE	Identificación del organismo certificador (Ej. LCIE)	Marcado CE para los productos Ex	Agrupamiento de aparatos eléctricos	Categoría del equipo (2 ó 3)	Gas o Polvo

Marcado según EN

Marcado estándar adicional para motores

Ex	d	II	C	T4	Gb
Aparato protegido contra explosiones	Tipo de protección	Grupos (todos excepto minas)	Grupos según Gas (necesario sólo para antideflagrantes)	Clase de temperatura	Nivel de protección contra explosión



Valores de explosividad de gases combustibles

	Grupo de gas	%vol LIE	g/mol M		Grupo de gas	%vol LIE	g/mol M
metano	I	5,0	16,04	formiato de etilo	IIA	2,7	74,08
acetato de amilo	IIA	1,1	130,19	formiato de metilo	IIA	5	60,05
acetato de butilo	IIA	1,2	116,16	gasolina		0,7	73,95
acetato de etilo	IIA	2,1	88,11	heptano	IIA	1,1	100,20
acetato de metilo	IIA	3,1	74,08	hexano	IIA	1,2	86,18
acetato de propilo	IIA	1,7	102,13	hexano	IIIA	1,2	102,18
acetona	IIA	2,2	55,06	keroseno	IIA	0,7	87,00
acetonitrilo	IIA	3,0	41,05	metilamina	IIA	4,9	31,06
ácido acético	IIA	4,0	60,05	metilciclohexano	IIA	1,1	98,19
aldehído acético	IIA	4,0	44,05	monóxido de carbono	IIA	12,5	28,01
amoníaco	IIA	15,0	17,03	naftaleno	IIA	0,9	128,17
anilina	IIA	1,2	107,13	nitroetano	IIA	4,0	75,07
benceno	IIA	1,2	78,11	nitrometano	IIA	7,1	61,04
bromobutano	IIA	2,6	137,02	nonano	IIA	0,7	128,26
bromoetano	IIA	6,7	108,97	nonano	IIIA	8,0	144,26
butano	IIA	1,5	58,12	octano	IIA	6,0	114,23
butano	IIIA	1,4	74,12	pentano	IIA	1,4	72,15
butil metil cetona	IIA	1,2	100,16	pentano	IIIA	1,2	88,15
butilamina	IIA	1,7	73,14	petróleo	IIA	1,0	87,00
ciclobutano	IIA	1,8	56,11	piridina	IIA	1,7	79,10
ciclohexano	IIA	1,2	84,16	propano	IIA	2,0	44,10
ciclohexano	IIIA	1,2	100,16	propano	IIIA	2,1	60,10
ciclohexanona	IIA	1,3	98,14	propeno (propileno)	IIA	2,0	42,08
ciclopentano	IIA	1,1	70,13	propilamina	IIA	2,0	59,11
clorobenceno	IIA	1,1	112,56	tolueno	IIA	1,2	92,14
clorobutano	IIA	1,8	92,57	trietilamina	IIA	1,2	53,15
cloroetano	IIA	3,6	64,51	trimetilamina	IIA	2,0	59,11
cloroetano	IIIA	5,0	106,97	xileno	IIA	1,0	106,17
cloroetileno(cloruro de vinilo)	IIA	3,8	62,50	1,2-epoxipropano (óxido de propileno)	IIB	1,9	58,08
clorometano	IIA	7,6	50,49	1,3,5-trioxano	IIB	3,6	90,08
cloropropano	IIA	2,6	78,54	1,3-butadieno	IIB	1,4	54,09
cloruro de acetilo	IIA	5,0	78,50	1,4-dioxano	IIB	1,9	88,11
cloruro de alilo	IIA	3,3	76,53	ácido cianhídrico	IIB	46,5	27,03
creso	IIIA	1,0	108,14	acrilato de etilo	IIB	1,7	100,12
decahidronaftaleno(decalina)	IIA	0,7	138,25	acrilato de metilo	IIB	2,4	86,09
decano	IIA	0,81	42,28	acrilonitrilo	IIB	2,8	53,06
diacetona-alcoholo	IIIA	1,8	116,16	alcohol tetrahidrofurfúrico	IIB	1,5	102,13
dicloroetano	IIA	5,6	98,96	ciclopropano	IIB	2,4	42,08
dicloroetileno	IIA	6,5	96,94	éter dibutílico	IIB	0,9	130,23
dicloropropano	IIA	3,4	112,99	éter dietílico	IIB	1,9	74,12
dietilamina	IIA	1,7	73,14	etil metil éter	IIB	2,0	60,10
dimetilamina	IIA	2,8	45,08	etileno	IIB	2,7	28,05
dimetilanilina	IIA	1,2	121,18	furano	IIB	2,3	68,08
dipropiléter	IIA		102,18	gas de coquería	IIB	5,0	
estireno	IIA	1,1	104,15	metilacetileno (propino)	IIB	1,7	40,06
etano	IIA	3,0	30,07	nitrate de isopropilo	IIB	2,0	105,09
etano	IIIA	3,3	46,07	óxido de etileno (epoxietano)	IIB	2,6	44,05
etil metil cetona	IIA	1,8	72,11	tetrahidrofurano	IIB	1,5	72,11
etilbenceno	IIA	1,0	106,17	acetileno	IIC	1,5	26,04
etilmercaptano	IIA	2,8	62,13	disulfuro de carbono	IIC	1,0	76,13
feno	IIIA	1,3	94,11	hidrógeno	IIC	4,0	2,02

EXTRACTORES HEAVY DUTY CENTRIFUGOS



EXTRACTORES HEAVY DUTY HELICOIDALES



EXTRACTORES DE TEJADO



HTMH
Extractores de cubierta multifuncional para grandes caudales

137



HTMV
Extractores de helicoidales de cubierta con salida de aire vertical

145

EXTRACTORES ATEX PARA ATMÓSFERAS EXPLOSIVAS

CERTIFICATE ATEX



EAC



**HCH/ATEX
HCT/ATEX**
Extractores helicoidales tubulares de gran robustez, con Certificación ATEX

167



HPX/ATEX
Extractores helicoidales tubulares, con motor exterior y Certificación ATEX

174



CPV/ATEX
Extractores centrífugos anticorrosivos en material plástico, con certificación ATEX

177



CMR/ATEX
Extractores centrífugos de media presión y gran robustez, equipados con turbina a reacción, con certificación ATEX

180



CAS/ATEX
Extractores centrífugos de alta presión y simple aspiración, con certificación ATEX

183



CA/ATEX
Extractores centrífugos de alta presión y simple aspiración en fundición de aluminio, con certificación ATEX

188

ACCESORIOS

191



VSD3/A-RFT VSD1/A-RFM INT Interruptor ATEX KME GMP AET PL P R RI RT RPA BTUB PV B BD BIC BAC PS MS PA PT OP ACE/ATEX REG CJACUS S Drall-Regler Válvula lamas contrapuestas

CMRS

Ventiladores centrífugos de baja presión y simple aspiración, de gran robustez, equipados con turbina con álabes hacia atrás



Ventilador:

- Envoltorio en chapa de acero
- Turbina con álabes a reacción, en chapa de acero de gran robustez, especialmente diseñada para transportar aire limpio o ligeramente polvoriento
- Motor directamente acoplado

Motor:

- Motores de eficiencia IE3 para potencias iguales o superiores a 7,5kW, excepto monofásicos, 2 velocidades y 8 polos
- Motores clase F, con rodamientos a bolas, protección IP55
- Trifásicos 230/400V-50Hz (hasta 4kW) y 400/690V-50Hz (potencias superiores a 4kW)
- Temperatura máxima del aire a transportar: -25°C + 120°C

Acabado:

- Anticorrosivo en resina de poliéster polimerizada a 190 °C, previo desengrase con tratamiento nanotecnológico libre de fosfatos.

Bajo demanda:

- Bobinados especiales para diferentes tensiones
- Ventilador preparado para transportar aire hasta 250°C
- Ventilador en acero inoxidable
- Certificación ATEX Categoría 2
- Motores de eficiencias IE2 e IE3 para cualquier potencia
- Acoplamiento elástico sistema 8

Turbina a reacción de alto rendimiento, y gran robustez

Código de pedido

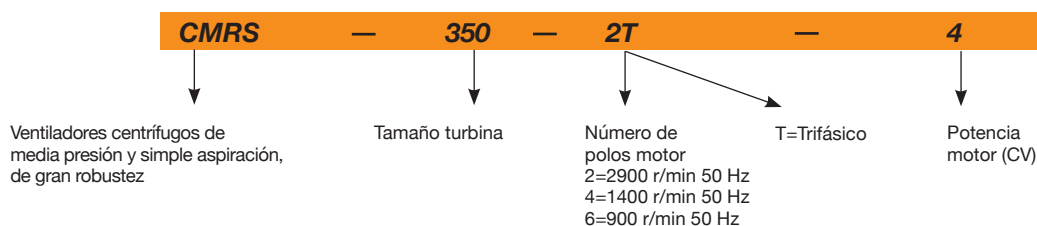

Características técnicas

Modelo	Velocidad (r/min)	Intensidad máx admisible (A)			Potencia instalada (kW)	Caudal máximo (m3/h)	Nivel Presión Sonora dB(A)	Peso aprox (Kg)	According ErP
		230 V	400 V	690 V					
CMRS-350-2T-4	2900	10,18	5,88		3,00	7750	77	77	2015
CMRS-350-4T-0.5	1380	1,84	1,06		0,37	3900	65	50	2015
CMRS-400-2T-5.5	2880	13,30	7,63		4,00	9700	79	98	2015
CMRS-400-2T-7.5	2920		10,40	6,00	5,50	12100	82	107	2015
CMRS-400-4T-0.75	1420	2,28	1,31		0,55	5400	67	69	2015
CMRS-450-2T-10 IE3	2935		13,90	8,06	7,50	13600	83	141	2015
CMRS-450-2T-15 IE3	2950		20,10	11,70	11,00	17200	84	198	2015
CMRS-450-4T-1	1410	3,10	1,79		0,75	6850	69	78	2015
CMRS-450-4T-1.5	1420	4,33	2,50		1,10	7700	70	84	2015
CMRS-500-2T-20 IE3	2950		27,10	15,70	15,00	19400	88	231	2015
CMRS-500-2T-25 IE3	2950		33,30	19,30	18,50	24300	89	250	2015
CMRS-500-4T-2	1430	5,96	3,44		1,50	9750	71	117	2015
CMRS-500-4T-3	1445	8,36	4,83		2,20	10850	72	129	2015
CMRS-500-6T-0.75	910	2,59	1,49		0,55	6900	61	107	2015
CMRS-560-4T-4	1445	10,96	6,33		3,00	13600	73	148	2015
CMRS-560-4T-5.5	1440	14,10	8,12		4,00	17300	73	160	2015
CMRS-560-6T-1	945	3,90	2,20		0,75	8650	62	129	2015
CMRS-560-6T-1.5	945	4,88	2,82		1,10	9650	65	135	2015
CMRS-630-4T-7.5	1460		10,60	6,10	5,50	19100	75	193	2015
CMRS-630-4T-10 IE3	1465		13,90	8,06	7,50	24600	75	227	2015
CMRS-630-6T-2	955	6,42	3,71		1,50	12200	66	167	2015
CMRS-630-6T-3	955	9,30	5,30		2,20	15350	68	177	2015
CMRS-710-4T-15 IE3	1470		20,70	12,00	11,00	27550	78	352	2015
CMRS-710-4T-20 IE3	1470		28,40	16,50	15,00	34900	78	377	2015
CMRS-710-6T-4	960	11,90	6,80		3,00	17200	70	276	2015
CMRS-710-6T-5.5	960	16,50	9,46		4,00	21700	71	287	2015
CMRS-800-4T-25 IE3	1470		34,90	20,20	18,50	38250	81	480	2015
CMRS-800-4T-30 IE3	1470		40,90	23,70	22,00	48250	83	503	2015
CMRS-800-6T-7.5	965		12,30	7,10	5,50	24400	74	357	2015

Características técnicas

Modelo	Velocidad (r/min)	Intensidad máx admisible (A)			Potencia instalada (kW)	Caudal máximo (m3/h)	Nivel Presión Sonora dB(A)	Peso aprox (Kg)	According ErP
		230 V	400 V	690 V					
CMRS-800-6T-10 IE3	975		14,70	8,52	7,50	30900	74	412	2015
CMRS-900-4T-50 IE3	1480		65,60	38,00	37,00	54300	85	810	2015
CMRS-900-4T-60 IE3	1480		79,40	46,00	45,00	69550	85	849	2015
CMRS-900-6T-15 IE3	975		21,50	12,50	11,00	34650	76	521	2015
CMRS-900-6T-20 IE3	975		28,00	16,20	15,00	42600	76	583	2015
CMRS-1000-4T-75 IE3	1480		96,90	56,20	55,00	76650	87	1082	2015
CMRS-1000-4T-100 IE3	1485		130,00	75,40	75,00	96150	88	1319	2015
CMRS-1000-6T-25 IE3	980		35,20	20,40	18,50	48750	77	783	2015
CMRS-1000-6T-30 IE3	980		41,70	24,20	22,00	61800	78	810	2015
CMRS-1120-6T-40 IE3	985		54,20	31,40	30,00	71500	80	1081	2015
CMRS-1120-6T-50 IE3	985		66,60	38,60	37,00	85950	80	1261	2015
CMRS-1250-6T-75 IE3	990		102,00	59,10	55,00	98300	83	1618	2015
CMRS-1250-6T-100 IE3	990		136,00	78,80	75,00	121200	84	1947	2015
CMRS-1400-6T-125 IE3	990		163,00	94,50	90,00	142150	87	2328	2015
CMRS-1400-6T-150 IE3	992		199,00	115,00	110,00	173400	88	2476	2015

Erp. Características del punto de máxima eficiencia (BEP)

MC	Categoría de medición	ηe[%]	Eficiencia
EC	Categoría de eficiencia	N	Grado de eficiencia
S	Estática	[kW]	Potencia eléctrica
T	Total	[m³/h]	Caudal
VSD	Variador de velocidad	[mmH₂O]	Presión estática o total (Según EC)
SR	Relación específica	[RPM]	Velocidad

Modelo	MC	EC	VSD	SR	ηe [%]	N	[kW]	[m³/h]	[mmH₂O]	[RPM]
CMRS-350-2T-4	B	T	NO	1,01	68,9%	74,1	3,22	5375	151,37	2909
CMRS-350-4T-0.5	B	T	NO	1,00	51,4%	66,0	0,41	2077	37,03	1410
CMRS-400-2T-5.5	B	T	NO	1,02	71,0%	74,6	4,54	7095	166,64	2883
CMRS-400-2T-7.5	B	T	NO	1,02	64,3%	66,9	5,69	6843	196,27	2928
CMRS-400-4T-0.75	B	T	NO	1,00	57,9%	70,1	0,70	3653	40,80	1425
CMRS-450-2T-10 IE3	B	T	NO	1,02	69,5%	70,4	8,23	9917	211,65	2935
CMRS-450-2T-15 IE3	B	T	NO	1,03	69,3%	69,5	9,46	9179	261,99	2960
CMRS-450-4T-1	B	T	NO	1,00	67,6%	78,5	0,90	5106	43,87	1414
CMRS-450-4T-1.5	B	T	NO	1,01	61,4%	71,1	1,20	4557	59,25	1429
CMRS-500-2T-20 IE3	B	T	NO	1,02	72,1%	71,8	14,09	14752	252,78	2956
CMRS-500-2T-25 IE3	B	T	NO	1,03	73,8%	73,3	17,06	14514	318,32	2957
CMRS-500-4T-2	B	T	NO	1,01	68,4%	76,6	1,68	6605	63,93	1435
CMRS-500-4T-3	B	T	NO	1,01	64,3%	71,2	2,22	6865	76,33	1453
CMRS-500-6T-0.75	B	T	NO	1,00	57,8%	70,1	0,67	4520	31,68	922
CMRS-560-4T-4	B	T	NO	1,01	68,5%	73,6	3,27	10166	80,96	1449
CMRS-560-4T-5.5	B	T	NO	1,01	63,4%	67,8	3,86	10373	86,71	1450
CMRS-560-6T-1	B	T	NO	1,00	62,9%	74,1	0,84	6860	28,36	953
CMRS-560-6T-1.5	B	T	NO	1,00	58,4%	67,9	1,24	6860	38,87	951
CMRS-630-4T-7.5	B	T	NO	1,01	69,8%	72,2	5,93	14449	105,24	1462
CMRS-630-4T-10 IE3	B	T	NO	1,01	69,5%	71,6	6,19	12133	130,02	1474
CMRS-630-6T-2	B	T	NO	1,00	59,6%	67,9	1,64	8230	43,60	961
CMRS-630-6T-3	B	T	NO	1,00	63,1%	70,0	2,21	11941	42,93	963
CMRS-710-4T-15 IE3	B	T	NO	1,01	69,2%	69,2	10,09	17818	143,77	1475
CMRS-710-4T-20 IE3	B	T	NO	1,02	67,6%	67,7	10,30	14917	171,44	1481
CMRS-710-6T-4	B	T	NO	1,01	67,9%	73,1	3,16	12584	62,51	965
CMRS-710-6T-5.5	B	T	NO	1,01	66,1%	70,7	3,69	12910	69,32	969
CMRS-800-4T-25 IE3	B	T	NO	1,02	76,0%	75,4	18,44	28002	183,75	1472
CMRS-800-4T-30 IE3	B	T	NO	1,02	71,9%	71,2	19,69	25219	206,07	1475
CMRS-800-6T-7.5	B	T	NO	1,01	71,4%	74,1	5,62	17719	83,15	969
CMRS-800-6T-10 IE3	B	T	NO	1,01	73,9%	76,1	6,22	19365	87,19	981
CMRS-900-4T-50 IE3	B	T	NO	1,02	72,2%	71,0	33,02	34349	254,74	1483
CMRS-900-4T-60 IE3	B	T	NO	1,03	70,2%	68,8	36,75	36275	260,99	1485
CMRS-900-6T-15 IE3	B	T	NO	1,01	78,2%	78,5	9,42	27074	99,84	980
CMRS-900-6T-20 IE3	B	T	NO	1,01	67,6%	67,6	10,60	22448	117,22	984
CMRS-1000-4T-75 IE3	B	T	NO	1,03	73,8%	72,0	54,83	53731	276,32	1481
CMRS-1000-4T-100 IE3	B	T	NO	1,03	71,7%	69,7	63,44	53731	310,63	1488
CMRS-1000-6T-25 IE3	B	T	NO	1,01	73,1%	72,6	17,19	37016	124,62	983
CMRS-1000-6T-30 IE3	B	T	NO	1,01	76,8%	76,3	17,19	38047	127,35	985
CMRS-1120-6T-40 IE3	B	T	NO	1,02	73,1%	72,1	25,10	41891	160,68	988
CMRS-1120-6T-50 IE3	B	T	NO	1,02	76,2%	75,0	30,96	46933	184,42	988



Erp. Características del punto de máxima eficiencia (BEP)

Modelo	MC	EC	VSD	SR	η_e [%]	N	[kW]	[m ³ /h]	[mmH ₂ O]	[RPM]
CMRS-1250-6T-75 IE3	B	T	NO	1,02	73,6%	72,1	42,86	55127	210,07	993
CMRS-1250-6T-100 IE3	B	T	NO	1,02	78,0%	76,2	52,11	65179	228,76	993
CMRS-1400-6T-125 IE3	B	T	NO	1,03	79,8%	77,7	74,23	83659	259,82	992
CMRS-1400-6T-150 IE3	B	T	NO	1,03	80,1%	77,6	97,25	99758	286,46	993

Dimensiones mm

CMRS-350...500

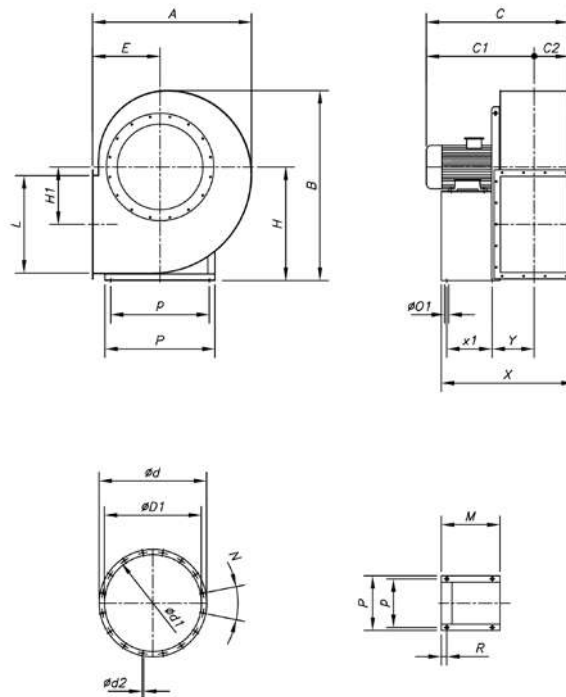

Modelo	A	B	C	C1	C2	ØD1	Ød	Ød1	Ød2	N	E	H	H1	L	M	R	ØO1	P	p	X	x1	Y
CMRS-350-2T-4	600	740	598	468	130	360	440	405	10	8X45°	255	450	216	361	310	15	12	324	294	612	240	186
CMRS-350-4T-0.5	600	740	468	338	130	360	440	405	10	8X45°	255	450	216	361	220	15	10	225	204	522	150	186
CMRS-400-2T-5.5	655	815	630	483	147	405	485	448	10	12X30°	285	500	245	404	310	15	12	324	294	644	240	202
CMRS-400-2T-7.5	655	815	692	545	147	405	485	448	10	12X30°	285	500	245	404	360	15	12	372	342	694	290	202
CMRS-400-4T-0.75	655	815	520	373	147	405	485	448	10	12X30°	285	500	245	404	225	15	10	225	204	559	155	202
CMRS-450-2T-10	735	915	726	563	163	455	535	497	10	12X30°	320	560	275	453	360	15	12	372	342	730	290	220
CMRS-450-2T-15	735	915	862	699	163	455	535	497	10	12X30°	320	560	275	453	465	25	14	440	400	835	385	220
CMRS-450-4T-1	735	915	554	391	163	455	535	497	10	12X30°	320	560	275	453	225	15	10	225	204	595	155	220
CMRS-450-4T-1.5	735	915	594	431	163	455	535	497	10	12X30°	320	560	275	453	265	15	10	260	239	635	195	220
CMRS-500-2T-20	832	1000	901	718	183	505	585	551	10	12X30°	360	600	303	507	465	25	14	440	400	875	385	240
CMRS-500-2T-25	832	1000	901	718	183	505	585	551	10	12X30°	360	600	303	507	465	25	14	440	400	875	385	240
CMRS-500-4T-2	832	1000	633	450	183	505	585	551	10	12X30°	360	600	303	507	265	15	10	260	239	675	195	240
CMRS-500-4T-3	832	1000	703	520	183	505	585	551	10	12X30°	360	600	303	507	310	15	12	324	294	720	240	240
CMRS-500-6T-0.75	832	1000	593	410	183	505	585	551	10	12X30°	360	600	303	507	225	15	10	225	204	635	155	240

Dimensiones mm

CMRS-560...900

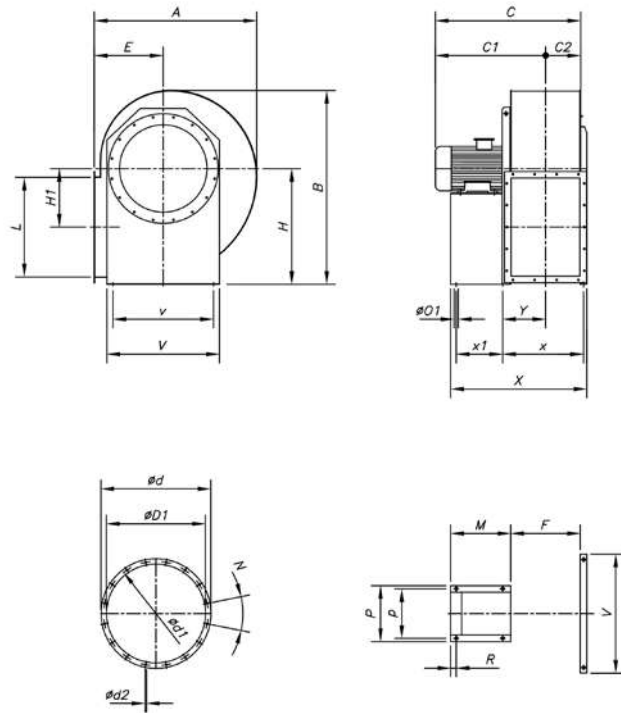

Modelo	A	B	C	C1	C2	ØD1	Ød	Ød1	Ød2	N	E	H	H1	L	F	M	R	ØO1	P	p	V	v	X	x	x1	Y
CMRS-560-4T-4	940	1126	747	542	205	565	665	629	10	12X30°	400	670	332	569	408	310	15	12	324	294	690	630	750	480	240	261
CMRS-560-4T-5.5	940	1126	747	542	205	565	665	629	10	12X30°	400	670	332	569	408	310	15	12	324	294	690	630	750	480	240	261
CMRS-560-6T-1	940	1126	677	472	205	565	665	629	10	12X30°	400	670	332	569	408	265	15	10	260	239	690	630	705	480	195	261
CMRS-560-6T-1.5	940	1126	677	472	205	565	665	629	10	12X30°	400	670	332	569	408	265	15	10	260	239	690	630	705	480	195	261
CMRS-630-4T-7.5	1052	1260	858	628	230	635	735	698	10	12X30°	450	750	373	638	457	360	15	12	372	342	778	700	857	528	290	286
CMRS-630-4T-10	1052	1260	858	628	230	635	735	698	10	12X30°	450	750	373	638	457	360	15	12	372	342	778	700	857	528	290	286
CMRS-630-6T-2	1052	1260	796	566	230	635	735	698	10	12X30°	450	750	373	638	457	310	15	10	324	294	778	700	807	528	240	286
CMRS-630-6T-3	1052	1260	796	566	230	635	735	698	10	12X30°	450	750	373	638	457	310	15	10	324	294	778	700	807	528	240	286
CMRS-710-4T-15	1160	1416	1045	788	257	715	815	775	12	16x22°30'	500	850	427	715	510	435	39	13	870	772	930	772	988	606	335	317
CMRS-710-4T-20	1160	1416	1045	788	257	715	815	775	12	16x22°30'	500	850	427	715	510	435	39	13	870	772	930	772	988	606	335	317
CMRS-710-6T-4	1160	1416	909	652	257	715	815	775	12	16x22°30'	500	850	427	715	510	320	39	13	870	772	930	772	873	606	260	277
CMRS-710-6T-5.5	1160	1416	909	652	257	715	815	775	12	16x22°30'	500	850	427	715	510	320	39	13	870	772	930	772	873	606	260	277
CMRS-800-4T-25	1312	1591	1127	840	287	805	905	861	15	16x22°30'	560	950	478	801	572	463	27	20	926	872	932	862	1095	668	409	314
CMRS-800-4T-30	1312	1591	1202	915	287	805	905	861	15	16x22°30'	560	950	478	801	572	463	27	20	926	872	932	862	1095	668	409	314
CMRS-800-6T-7.5	1312	1591	991	704	287	805	905	861	15	16x22°30'	560	950	478	801	572	303	27	20	926	872	932	862	935	668	249	314
CMRS-800-6T-10	1312	1591	1127	840	287	805	905	861	15	16x22°30'	560	950	478	801	572	418	27	20	926	872	932	862	1050	668	364	314
CMRS-900-4T-50	1470	1780	1328	1006	322	905	1005	958	15	16x22°30'	630	1060	538	898	638	540	27	20	1026	972	1145	962	1258	731	486	346
CMRS-900-4T-60	1470	1780	1328	1006	322	905	1005	958	15	16x22°30'	630	1060	538	898	638	540	27	20	1026	972	1145	962	1258	731	486	346
CMRS-900-6T-15	1470	1780	1176	854	322	905	1005	958	15	16x22°30'	630	1060	538	898	638	415	27	20	1026	972	1145	962	1133	731	361	346
CMRS-900-6T-20	1470	1780	1251	929	322	905	1005	958	15	16x22°30'	630	1060	538	898	638	460	27	20	1026	972	1145	962	1178	731	406	346

Dimensiones mm

CMRS-1000...1400

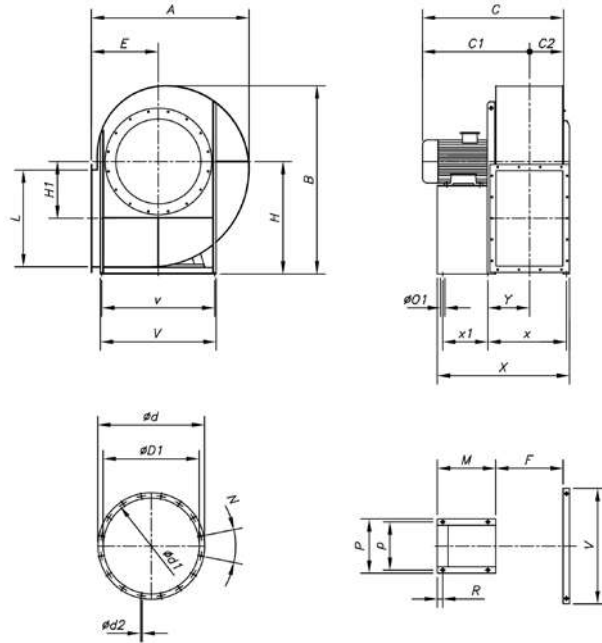

Modelo	A	B	C	C1	C2	ØD1	Ød	Ød1	Ød2	N	E	H	H1	L	F	M	R	ØO1	P	p	V	v	X	x	x1	Y
CMRS-1000-4T-75	1656	1993	1425	1065	360	1007	1107	1067	15	24x15°	710	1180	607	1007	715	600	27	20	1128	1074	1255	1056	1400	803	500	431
CMRS-1000-4T-100	1656	1993	1555	1195	360	1007	1107	1067	15	24x15°	710	1180	607	1007	715	690	27	20	1128	1074	1255	1056	1480	803	590	431
CMRS-1000-6T-25	1656	1993	1348	988	360	1007	1107	1067	15	24x15°	710	1180	607	1007	715	500	27	20	1128	1074	1255	1056	1300	803	400	431
CMRS-1000-6T-30	1656	1993	1348	988	360	1007	1107	1067	15	24x15°	710	1180	607	1007	715	500	27	20	1128	1074	1255	1056	1300	803	400	431
CMRS-1120-6T-40	1854	2222	1490	1086	404	1130	1250	1200	15	24x15°	800	1320	684	1130	801	540	45	24	1268	1178	1400	1178	1441	926	415	481
CMRS-1120-6T-50	1854	2222	1490	1086	404	1130	1250	1200	15	24x15°	800	1320	684	1130	801	600	45	24	1268	1178	1400	1178	1501	926	475	481
CMRS-1250-6T-75	2084	2517	1718	1266	452	1260	1380	1337	15	24x15°	900	1500	770	1267	898	690	45	24	1400	1310	1530	1310	1688	1023	565	529
CMRS-1250-6T-100	2084	2517	1718	1266	452	1260	1380	1337	15	24x15°	900	1500	770	1267	898	800	45	24	1400	1310	1530	1310	1798	1023	675	529
CMRS-1400-6T-125	2305	2815	2048	1542	506	1410	1530	1491	10	32x11°15'	1000	1700	854	1421	1012	799,5	60	24	1530	1450	1690	1450	1906	1152	640	603
CMRS-1400-6T-150	2305	2815	2048	1542	506	1410	1530	1491	10	32x11°15'	1000	1700	854	1421	1012	800	60	24	1530	1450	1690	1450	1906	1152	640	603

Boca de impulsión

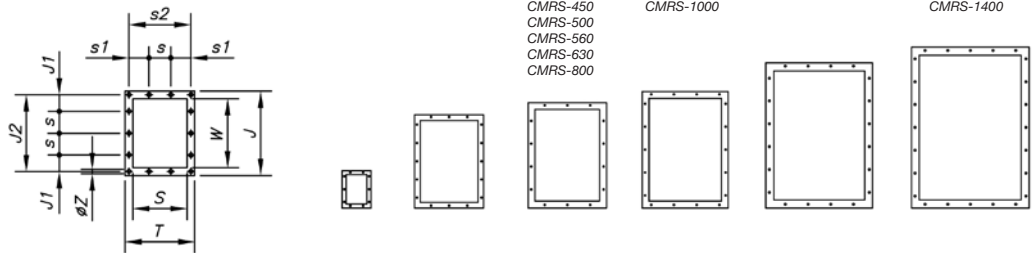

	T	J	J1	J2	S	s	s1	s2	W	ØZ
CMRS-350	336	441	77,5	405	256	125	87,5	300	361	12
CMRS-400	368	484	36,5	448	288	125	41	332	404	12
CMRS-450	402	533	61	497	322	125	58	366	453	12
CMRS-500	441	587	88	551	361	125	77,5	405	507	14
CMRS-560	504	669	74,5	629	404	160	72	464	569	14
CMRS-630	553	738	109	698	453	160	96,5	513	638	14
CMRS-710	607	815	67,5	775	507	160	123,5	567	715	14
CMRS-800	689	921	135,5	871	569	200	119,5	639	801	14
CMRS-900	758	1018	84	968	638	200	54	708	898	18
CMRS-1000	835	1127	138,5	1077	715	200	92,5	785	1007	18
CMRS-1120	941	1270	105	1210	801	200	140,5	881	1130	20
CMRS-1250	1038	1407	73,5	1347	898	200	89	978	1267	24
CMRS-1400	1147	1561	150,5	1501	1007	200	143,5	1087	1421	18

Curvas Características

Q= Caudal en m³/h, m³/s y cfm

Pe= Presión estática en mmH₂O, Pa e inwg

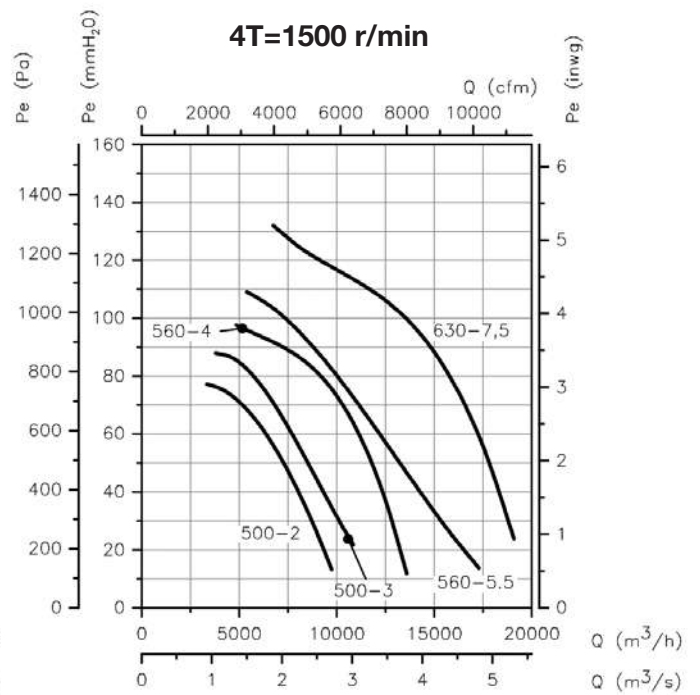
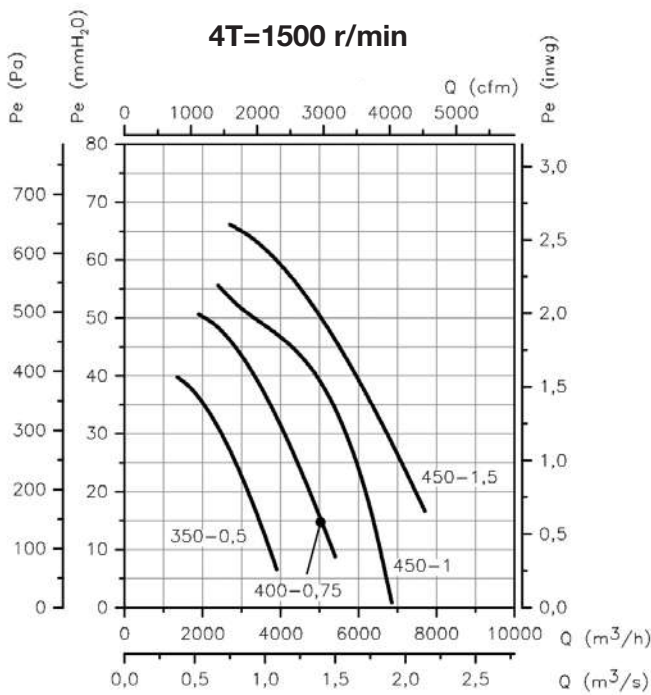
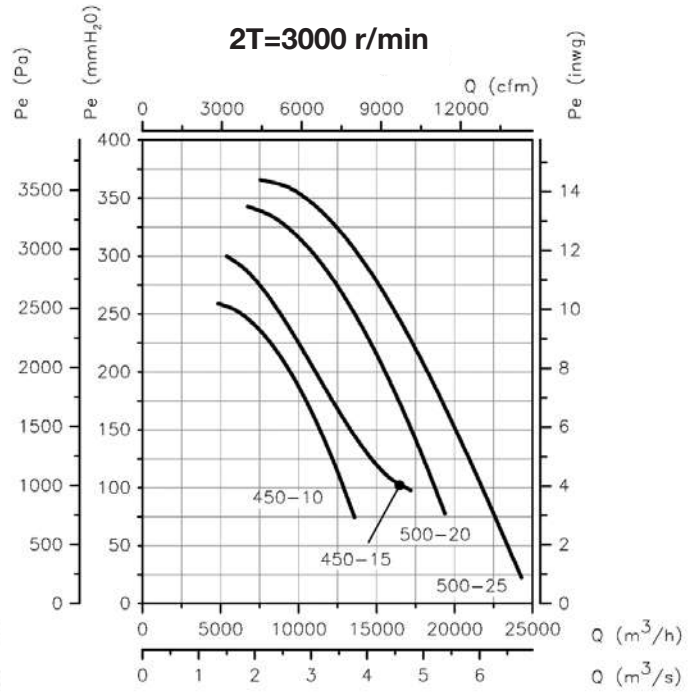
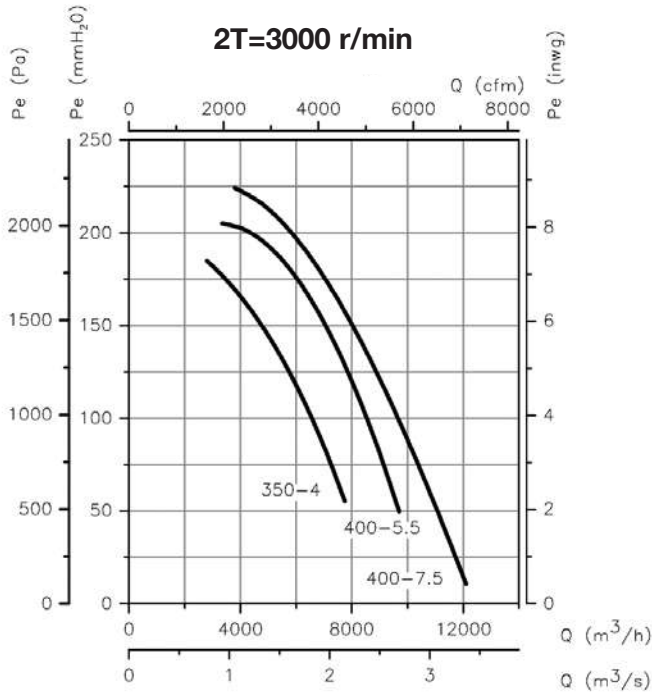

Curvas Características

Q= Caudal en m³/h, m³/s y cfm

Pe= Presión estática en mmH₂O, Pa e inwg

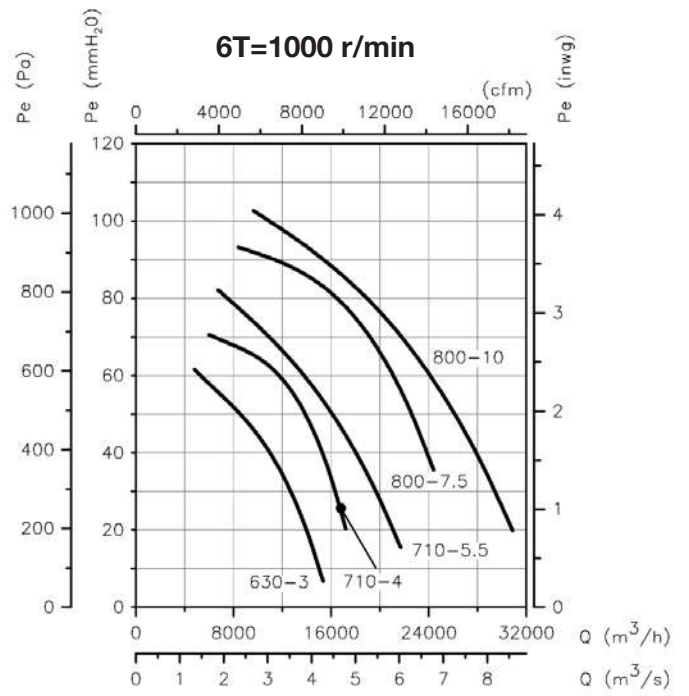
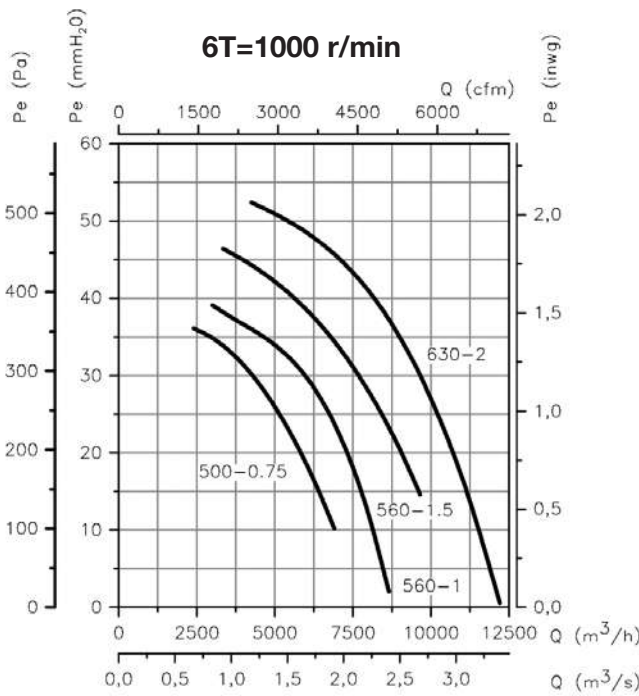
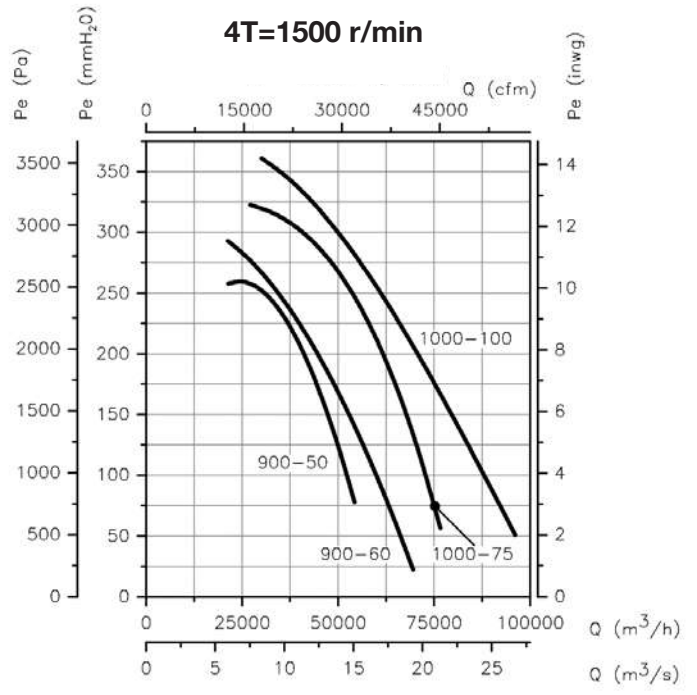
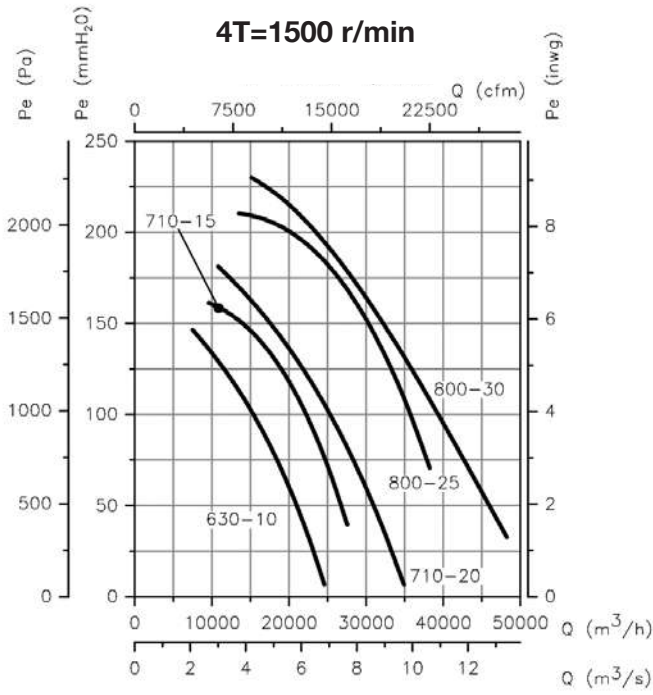

Curvas Características

Q= Caudal en m³/h, m³/s y cfm

Pe= Presión estática en mmH₂O, Pa e inwg

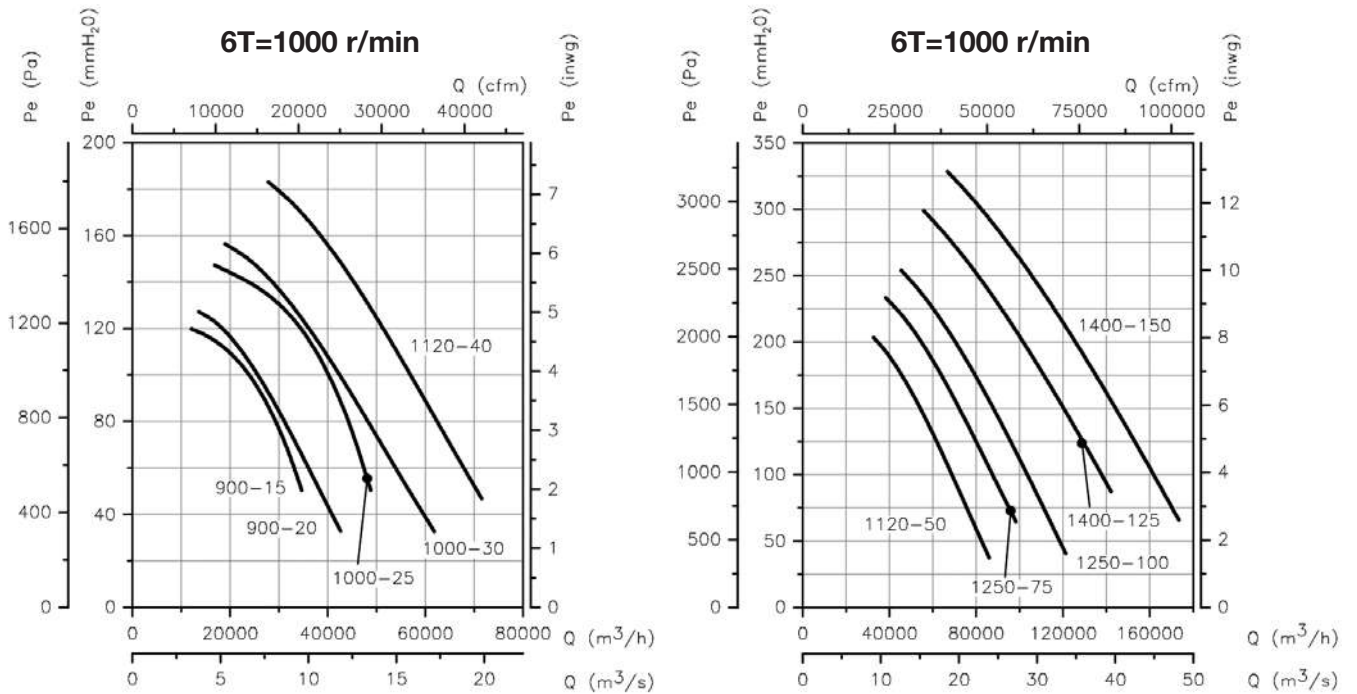

Orientaciones

Suministro estándar LG270, otras posiciones bajo demanda.
 Modelos del 350 al 710 orientables. Medidas especiales en posiciones 180 y 225.
 Modelos del 800 al 900 orientables. Medidas especiales excepto posición 315.
 Modelos del 1000 al 1400 no orientables. Medidas especiales excepto posición 315.

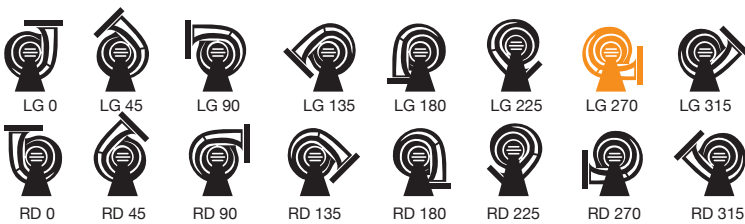

Accesorios

Ver apartado accesorios.

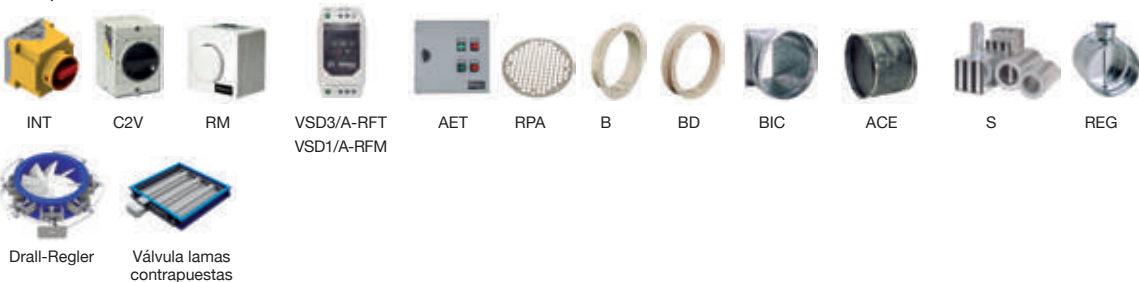

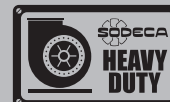

CMRS-X

Ventiladores accionados a transmisión, equipados con motor eléctrico, conjunto de poleas, correas y protectores normalizados según norma ISO-13857



Construcción de gran robustez

Ventilador:

- Envoltorio en chapa de acero
- Turbina con álabes a reacción, en chapa de acero de gran robustez, especialmente diseñada para transportar aire limpio o ligeramente polvoriento
- Motor montado sobre bancada general
- Ventilador accionado a transmisión

Motor:

- Motores eficiencia IE3
- Motores clase F, con rodamientos a bolas, protección IP55
- Trifásicos 230/400V-50Hz (hasta 4kW) y 400/690V-50Hz (potencias superiores a 4kW)
- Temperatura máxima del aire a transportar: -25°C + 120°C

polimerizada a 190 °C, previo desengrase con tratamiento nanotecnológico libre de fosfatos.

Bajo demanda:

- Bobinados especiales para diferentes tensiones
- Ventilador preparado para transportar aire hasta 250°C
- Ventilador en acero inoxidable
- Certificación ATEX Categoría 2
- Acoplamiento elástico sistema 8

Acabado:

- Anticorrosivo en resina de poliéster

Código de pedido

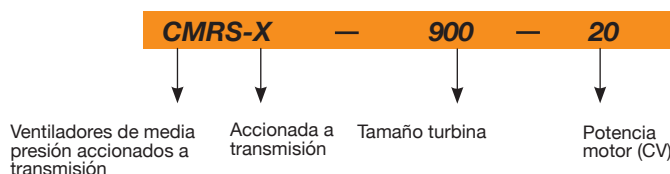

Características técnicas

Modelo	Velocidad (r/min)	Intensidad máx admisible (A)			Potencia instalada (kW)	Caudal máximo (m ³ /h)	Presión máxima (mm H ₂ O)	Peso aprox (Kg)	According ErP
		230V	400 V	690 V					
CMRS-X-350-0.75 IE3	1575	2,17	1,25		0,55	4540	55	121	2015
CMRS-X-350-1 IE3	1755	2,82	1,62		0,75	5050	65	123	2015
CMRS-X-350-1.5 IE3	1995	4,07	2,34		1,1	5740	85	133	2015
CMRS-X-350-2 IE3	2215	5,48	3,15		1,5	6370	105	136	2015
CMRS-X-350-3 IE3	2520	7,93	4,56		2,2	7260	140	145	2015
CMRS-X-350-4 IE3	2675	10,70	6,15		3	7700	155	151	2015
CMRS-X-350-5.5 IE3	3095	13,90	8,00		4	8920	210	162	2015
CMRS-X-350-7.5 IE3	3455		10,30	5,97	5,5	9950	260	187	2015
CMRS-X-350-10 IE3	3830		13,90	8,06	7,5	11030	320	196	2015
CMRS-X-350-15 IE3	4350		20,90	12,10	11	12530	410	236	2015
CMRS-X-400-0.75 IE3	1345	2,17	1,25		0,55	5560	50	129	2015
CMRS-X-400-1 IE3	1495	2,82	1,62		0,75	6170	60	131	2015
CMRS-X-400-1.5 IE3	1700	4,07	2,34		1,1	7010	75	141	2015
CMRS-X-400-2 IE3	1885	5,48	3,15		1,5	7790	95	144	2015
CMRS-X-400-3 IE3	2150	7,93	4,56		2,2	8870	125	153	2015
CMRS-X-400-4 IE3	2390	10,70	6,15		3	9860	150	159	2015
CMRS-X-400-5.5 IE3	2640	13,90	8,00		4	10890	185	170	2015
CMRS-X-400-7.5 IE3	2945		10,30	5,97	5,5	12150	230	195	2015
CMRS-X-400-10 IE3	3265		13,90	8,06	7,5	13480	285	204	2015
CMRS-X-400-15 IE3	3710		20,90	12,10	11	15310	365	244	2015
CMRS-X-450-1 IE3	1230	2,82	1,62		0,75	7050	50	146	2015
CMRS-X-450-1.5 IE3	1400	4,07	2,34		1,1	8010	65	156	2015
CMRS-X-450-2 IE3	1555	5,48	3,15		1,5	8890	80	159	2015
CMRS-X-450-3 IE3	1770	7,93	4,56		2,2	10130	105	168	2015
CMRS-X-450-4 IE3	1965	10,70	6,15		3	11260	130	174	2015
CMRS-X-450-5.5 IE3	2170	13,90	8,00		4	12440	160	185	2015
CMRS-X-450-7.5 IE3	2425		10,30	5,97	5,5	13880	200	210	2015
CMRS-X-450-10 IE3	2690		13,90	8,06	7,5	15390	245	219	2015

Características técnicas

Modelo	Velocidad (r/min)	Intensidad máx admisible (A)			Potencia instalada (kW)	Caudal máximo (m3/h)	Presión máxima (mm H ₂ O)	Peso aprox (Kg)	According ErP
		230V	400 V	690 V					
CMRS-X-450-15 IE3	3055		20,90	12,10	11	17490	320	259	2015
CMRS-X-450-20 IE3	3385		27,90	16,20	15	19400	390	281	2015
CMRS-X-500-1.5 IE3	1185	4,07	2,34		1,1	8460	55	190	2015
CMRS-X-500-2 IE3	1310	5,48	3,15		1,5	9380	70	193	2015
CMRS-X-500-3 IE3	1490	7,93	4,56		2,2	10670	90	202	2015
CMRS-X-500-4 IE3	1660	10,70	6,15		3	11880	110	208	2015
CMRS-X-500-5.5 IE3	1835	13,90	8,00		4	13130	135	219	2015
CMRS-X-500-7.5 IE3	2045		10,30	5,97	5,5	14640	170	244	2015
CMRS-X-500-10 IE3	2125		13,90	8,06	7,5	15200	180	253	2015
CMRS-X-500-15 IE3	2585		20,90	12,10	11	18470	265	293	2015
CMRS-X-500-20 IE3	2860		27,90	16,20	15	20460	325	315	2015
CMRS-X-500-25 IE3	3070		35,10	20,30	18,5	21960	375	353	2015
CMRS-X-560-2 IE3	1050	5,48	3,15		1,5	11280	55	231	2015
CMRS-X-560-3 IE3	1200	7,93	4,56		2,2	12840	75	240	2015
CMRS-X-560-4 IE3	1330	10,70	6,15		3	14280	90	246	2015
CMRS-X-560-5.5 IE3	1470	13,90	8,00		4	15780	110	257	2015
CMRS-X-560-7.5 IE3	1640		10,30	5,97	5,5	17600	140	282	2015
CMRS-X-560-10 IE3	1820		13,90	8,06	7,5	19520	170	291	2015
CMRS-X-560-15 IE3	1875		20,90	12,10	11	20080	180	331	2015
CMRS-X-560-20 IE3	2295		27,90	16,20	15	24600	270	353	2015
CMRS-X-560-25 IE3	2460		35,10	20,30	18,5	26380	310	391	2015
CMRS-X-560-30 IE3	2605		41,00	23,80	22	27940	350	408	2015
CMRS-X-630-3 IE3	1010	7,93	4,56		2,2	15860	70	294	2015
CMRS-X-630-4 IE3	1120	10,70	6,15		3	17630	85	300	2015
CMRS-X-630-5.5 IE3	1240	13,90	8,00		4	19480	105	311	2015
CMRS-X-630-7.5 IE3	1380		10,30	5,97	5,5	21730	130	336	2015
CMRS-X-630-10 IE3	1530		13,90	8,06	7,5	24100	160	345	2015
CMRS-X-630-15 IE3	1575		20,90	12,10	11	24790	170	385	2015
CMRS-X-630-20 IE3	1930		27,90	16,20	15	30360	250	407	2015
CMRS-X-630-25 IE3	2070		35,10	20,30	18,5	32560	290	445	2015
CMRS-X-630-30 IE3	2190		41,00	23,80	22	34500	325	462	2015
CMRS-X-630-40 IE3	2430		57,10	33,10	30	38260	400	505	2015
CMRS-X-710-4 IE3	840	10,70	6,15		3	18330	60	380	2015
CMRS-X-710-5.5 IE3	975	13,90	8,00		4	21210	75	391	2015
CMRS-X-710-7.5 IE3	1085		10,30	5,97	5,5	23670	95	416	2015
CMRS-X-710-10 IE3	1205		13,90	8,06	7,5	26250	120	425	2015
CMRS-X-710-15 IE3	1370		20,90	12,10	11	29820	150	465	2015
CMRS-X-710-20 IE3	1520		27,90	16,20	15	33080	190	487	2015
CMRS-X-710-25 IE3	1630		35,10	20,30	18,5	35480	215	525	2015
CMRS-X-710-30 IE3	1725		41,00	23,80	22	37590	240	542	2015
CMRS-X-710-40 IE3	1915		57,10	33,10	30	41670	300	585	2015
CMRS-X-710-50 IE3	2050		66,80	38,70	37	44700	340	732	2015
CMRS-X-800-10 IE3	940		13,90	8,06	7,5	32250	105	549	2015
CMRS-X-800-15 IE3	1060		20,90	12,10	11	36350	130	589	2015
CMRS-X-800-20 IE3	1200		27,90	16,20	15	41150	170	611	2015
CMRS-X-800-25 IE3	1290		35,10	20,30	18,5	44250	195	649	2015
CMRS-X-800-30 IE3	1370		41,00	23,80	22	46950	220	666	2015
CMRS-X-900-20 IE3	1130		27,90	16,20	15	48250	170	720	2015
CMRS-X-900-25 IE3	1200		35,10	20,30	18,5	51250	190	758	2015
CMRS-X-900-30 IE3	1280		41,00	23,80	22	54700	220	775	2015
CMRS-X-900-40 IE3	1430		57,10	33,10	30	61100	270	818	2015
CMRS-X-900-50 IE3	1520		66,80	38,70	37	64950	310	965	2015
CMRS-X-900-60 IE3	1630		80,90	46,90	45	69650	355	1000	2015
CMRS-X-1000-30 IE3	1050		41,00	23,80	22	63500	185	965	2015
CMRS-X-1000-40 IE3	1165		57,10	33,10	30	70450	230	1008	2015
CMRS-X-1000-50 IE3	1250		66,80	38,70	37	75600	260	1155	2015
CMRS-X-1000-60 IE3	1340		80,90	46,90	45	81050	300	1190	2015
CMRS-X-1000-75 IE3	1430		98,60	57,20	55	86500	345	1235	2015
CMRS-X-1000-100 IE3	1525		134,00	77,70	75	92250	390	1430	2015
CMRS-X-1120-30 IE3	880		41,00	23,80	22	73900	165	1184	2015
CMRS-X-1120-40 IE3	970		57,10	33,10	30	81500	200	1227	2015

Características técnicas

Modelo	Velocidad (r/min)	Intensidad máx admisible (A)			Potencia instalada (kW)	Caudal máximo (m ³ /h)	Presión máxima (mm H ₂ O)	Peso aprox (Kg)	According ErP
		230V	400 V	690 V					
CMRS-X-1120-50 IE3	1040		66,80	38,70	37	87350	230	1374	2015
CMRS-X-1120-60 IE3	1110		80,90	46,90	45	93250	265	1409	2015
CMRS-X-1120-75 IE3	1180		98,60	57,20	55	99100	295	1454	2015
CMRS-X-1120-100 IE3	1310		134,00	77,70	75	110050	365	1649	2015
CMRS-X-1250-40 IE3	800		57,10	33,10	30	96000	170	1383	2015
CMRS-X-1250-50 IE3	860		66,80	38,70	37	103200	195	1530	2015
CMRS-X-1250-60 IE3	920		80,90	46,90	45	110400	225	1565	2015
CMRS-X-1250-75 IE3	980		98,60	57,20	55	117600	255	1610	2015
CMRS-X-1250-100 IE3	1090		134,00	77,70	75	130800	315	1805	2015
CMRS-X-1250-125 IE3	1160		158,00	91,60	90	139200	355	1875	2015
CMRS-X-1400-50 IE3	690		66,80	38,70	37	113850	160	2078	2015
CMRS-X-1400-60 IE3	740		80,90	46,90	45	12100	180	2113	2015
CMRS-X-1400-75 IE3	790		98,60	57,20	55	130350	210	2158	2015
CMRS-X-1400-100 IE3	875		134,00	77,70	75	144400	255	2353	2015
CMRS-X-1400-125 IE3	930		158,00	91,60	90	153450	290	2423	2015
CMRS-X-1400-150 IE3	1000		193,00	112,00	110	165000	335	2698	2015
CMRS-X-1600-75 IE3	680		98,60	57,20	55	145850	195	2635	2015
CMRS-X-1600-100 IE3	750		134,00	77,70	75	160900	240	2830	2015
CMRS-X-1600-125 IE3	800		158,00	91,60	90	171600	270	2900	2015
CMRS-X-1600-150 IE3	860		193,00	112,00	110	184450	315	3175	2015
CMRS-X-1600-175 IE3	910		231,00	134,00	132	195200	350	3235	2015
CMRS-X-1600-220 IE3	970		280,00	162,00	160	208050	400	3305	2015



Erp. Características del punto de máxima eficiencia (BEP)

MC	Categoría de medición	ηe[%]	Eficiencia
EC	Categoría de eficiencia	N	Grado de eficiencia
	S Estática	[kW]	Potencia eléctrica
	T Total	[m³/h]	Caudal
VSD	Variador de velocidad	[mmH₂O]	Presión estática o total (Según EC)
SR	Relación específica	[RPM]	Velocidad

Modelo	MC	EC	VSD	SR	ηe [%]	N	[kW]	[m ³ /h]	[mmH ₂ O]	[RPM]
CMRS-X-350-0.75 IE3	C	S	NO	1,00	52,0%	64,8	0,598	2468	46,22	1575
CMRS-X-350-1 IE3	C	S	NO	1,01	53,9%	65,5	0,797	2750	57,39	1755
CMRS-X-350-1.5 IE3	C	S	NO	1,01	55,3%	65,2	1,143	3127	74,16	1995
CMRS-X-350-2 IE3	C	S	NO	1,01	56,2%	64,7	1,539	3471	91,41	2215
CMRS-X-350-3 IE3	C	S	NO	1,01	57,3%	64,1	2,224	3949	118,32	2520
CMRS-X-350-4 IE3	C	S	NO	1,01	58,4%	64,5	2,608	4192	133,32	2675
CMRS-X-350-5.5 IE3	C	S	NO	1,02	59,7%	63,9	3,953	4850	178,48	3095
CMRS-X-350-7.5 IE3	C	S	NO	1,02	61,6%	64,5	5,323	5415	222,41	3455
CMRS-X-350-10 IE3	C	S	NO	1,03	62,3%	63,8	7,173	6002	273,31	3830
CMRS-X-350-15 IE3	C	S	NO	1,04	62,3%	62,3	10,509	6817	352,57	4350
CMRS-X-400-0.75 IE3	C	S	NO	1,00	51,5%	64,2	0,609	2698	42,68	1345
CMRS-X-400-1 IE3	C	S	NO	1,01	53,4%	64,9	0,807	2999	52,73	1495
CMRS-X-400-1.5 IE3	C	S	NO	1,01	54,8%	64,6	1,157	3410	68,18	1700
CMRS-X-400-2 IE3	C	S	NO	1,01	55,6%	64,1	1,552	3781	83,83	1885
CMRS-X-400-3 IE3	C	S	NO	1,01	56,7%	63,5	2,260	4313	109,06	2150
CMRS-X-400-4 IE3	C	S	NO	1,01	57,8%	63,3	3,044	4794	134,76	2390
CMRS-X-400-5.5 IE3	C	S	NO	1,02	59,1%	63,3	4,014	5296	164,43	2640
CMRS-X-400-7.5 IE3	C	S	NO	1,02	61,1%	63,9	5,395	5907	204,62	2945
CMRS-X-400-10 IE3	C	S	NO	1,03	61,7%	63,2	7,271	6549	251,50	3265
CMRS-X-400-15 IE3	C	S	NO	1,03	61,7%	61,7	10,668	7442	324,73	3710
CMRS-X-450-1 IE3	C	S	NO	1,00	54,6%	66,0	0,818	3741	43,82	1230
CMRS-X-450-1.5 IE3	C	S	NO	1,01	56,0%	65,8	1,176	4258	56,77	1400
CMRS-X-450-2 IE3	C	S	NO	1,01	56,9%	65,3	1,586	4730	70,03	1555
CMRS-X-450-3 IE3	C	S	NO	1,01	58,0%	64,7	2,295	5383	90,74	1770
CMRS-X-450-4 IE3	C	S	NO	1,01	59,1%	64,5	3,079	5977	111,83	1965
CMRS-X-450-5.5 IE3	C	S	NO	1,01	60,4%	64,6	4,058	6600	136,38	2170
CMRS-X-450-7.5 IE3	C	S	NO	1,02	62,4%	65,2	5,482	7376	170,32	2425
CMRS-X-450-10 IE3	C	S	NO	1,02	63,1%	64,5	7,402	8182	209,58	2690
CMRS-X-450-15 IE3	C	S	NO	1,03	63,1%	63,1	10,842	9292	270,31	3055

Erp. Características del punto de máxima eficiencia (BEP)

Modelo	MC	EC	VSD	SR	η_e [%]	N	[kW]	[m ³ /h]	[mmH ₂ O]	[RPM]
CMRS-X-450-20 IE3	C	S	NO	1,03	63,1%	62,8	14,749	10295	331,86	3385
CMRS-X-500-1.5 IE3	C	S	NO	1,01	56,9%	66,3	1,253	5492	47,62	1185
CMRS-X-500-2 IE3	C	S	NO	1,01	57,8%	66,0	1,667	6072	58,20	1310
CMRS-X-500-3 IE3	C	S	NO	1,01	58,9%	65,4	2,406	6906	75,29	1490
CMRS-X-500-4 IE3	C	S	NO	1,01	60,1%	65,2	3,262	7694	93,46	1660
CMRS-X-500-5.5 IE3	C	S	NO	1,01	61,4%	65,2	4,312	8505	114,20	1835
CMRS-X-500-7.5 IE3	C	S	NO	1,01	63,4%	65,9	5,778	9478	141,83	2045
CMRS-X-500-10 IE3	C	S	NO	1,02	64,1%	66,1	6,412	9849	153,15	2125
CMRS-X-500-15 IE3	C	S	NO	1,02	64,1%	64,0	11,543	11981	226,63	2585
CMRS-X-500-20 IE3	C	S	NO	1,03	64,1%	63,7	15,633	13256	277,41	2860
CMRS-X-500-25 IE3	C	S	NO	1,03	64,8%	64,2	19,127	14229	319,64	3070
CMRS-X-560-2 IE3	C	S	NO	1,01	58,6%	67,2	1,524	6439	50,91	1050
CMRS-X-560-3 IE3	C	S	NO	1,01	59,7%	66,6	2,232	7359	66,50	1200
CMRS-X-560-4 IE3	C	S	NO	1,01	60,9%	66,5	2,980	8156	81,69	1330
CMRS-X-560-5.5 IE3	C	S	NO	1,01	62,3%	66,5	3,937	9014	99,79	1470
CMRS-X-560-7.5 IE3	C	S	NO	1,01	64,3%	67,2	5,292	10057	124,21	1640
CMRS-X-560-10 IE3	C	S	NO	1,02	65,0%	66,6	7,154	11161	152,97	1820
CMRS-X-560-15 IE3	C	S	NO	1,02	65,0%	66,1	7,822	11498	162,36	1875
CMRS-X-560-20 IE3	C	S	NO	1,03	65,0%	64,7	14,344	14073	243,24	2295
CMRS-X-560-25 IE3	C	S	NO	1,03	65,7%	65,2	17,476	15085	279,47	2460
CMRS-X-560-30 IE3	C	S	NO	1,03	65,7%	65,0	20,752	15974	313,39	2605
CMRS-X-630-3 IE3	C	S	NO	1,01	61,0%	67,6	2,322	8623	60,23	1010
CMRS-X-630-4 IE3	C	S	NO	1,01	62,2%	67,5	3,104	9562	74,06	1120
CMRS-X-630-5.5 IE3	C	S	NO	1,01	63,5%	67,6	4,122	10587	90,78	1240
CMRS-X-630-7.5 IE3	C	S	NO	1,01	65,6%	68,4	5,500	11782	112,44	1380
CMRS-X-630-10 IE3	C	S	NO	1,01	66,4%	67,7	7,414	13063	138,21	1530
CMRS-X-630-15 IE3	C	S	NO	1,02	66,4%	67,3	8,088	13447	146,46	1575
CMRS-X-630-20 IE3	C	S	NO	1,02	66,4%	66,0	14,882	16478	219,92	1930
CMRS-X-630-25 IE3	C	S	NO	1,03	67,1%	66,5	18,164	17673	252,99	2070
CMRS-X-630-30 IE3	C	S	NO	1,03	67,1%	66,3	21,509	18698	283,17	2190
CMRS-X-630-40 IE3	C	S	NO	1,04	67,8%	66,7	29,072	20747	348,63	2430
CMRS-X-710-4 IE3	C	S	NO	1,01	61,8%	68,5	2,301	10496	49,71	840
CMRS-X-710-5.5 IE3	C	S	NO	1,01	63,2%	67,9	3,521	12183	66,98	975
CMRS-X-710-7.5 IE3	C	S	NO	1,01	65,2%	68,7	4,697	13558	82,94	1085
CMRS-X-710-10 IE3	C	S	NO	1,01	66,0%	68,0	6,364	15057	102,30	1205
CMRS-X-710-15 IE3	C	S	NO	1,01	66,0%	66,3	9,353	17119	132,24	1370
CMRS-X-710-20 IE3	C	S	NO	1,02	66,0%	65,8	12,774	18993	162,78	1520
CMRS-X-710-25 IE3	C	S	NO	1,02	66,7%	66,2	15,584	20368	187,19	1630
CMRS-X-710-30 IE3	C	S	NO	1,02	66,7%	66,1	18,470	21555	209,65	1725
CMRS-X-710-40 IE3	C	S	NO	1,03	67,4%	66,4	25,001	23929	258,38	1915
CMRS-X-710-50 IE3	C	S	NO	1,03	67,4%	66,2	30,670	25616	296,09	2050
CMRS-X-800-10 IE3	C	S	NO	1,01	64,1%	66,5	5,964	15178	92,47	940
CMRS-X-800-15 IE3	C	S	NO	1,01	64,6%	65,3	8,496	17116	117,59	1060
CMRS-X-800-20 IE3	C	S	NO	1,02	65,3%	65,2	12,180	19377	150,70	1200
CMRS-X-800-25 IE3	C	S	NO	1,02	65,3%	64,9	15,131	20830	174,15	1290
CMRS-X-800-30 IE3	C	S	NO	1,02	65,4%	64,8	18,104	22122	196,42	1370
CMRS-X-900-20 IE3	C	S	NO	1,02	68,6%	68,2	15,265	24913	154,35	1130
CMRS-X-900-25 IE3	C	S	NO	1,02	69,0%	68,4	18,183	26456	174,06	1200
CMRS-X-900-30 IE3	C	S	NO	1,02	69,3%	68,5	21,973	28220	198,04	1280
CMRS-X-900-40 IE3	C	S	NO	1,03	69,7%	68,5	30,475	31527	247,18	1430
CMRS-X-900-50 IE3	C	S	NO	1,03	70,3%	68,9	36,289	33511	279,27	1520
CMRS-X-900-60 IE3	C	S	NO	1,03	70,2%	68,6	44,798	35936	321,16	1630
CMRS-X-1000-30 IE3	C	S	NO	1,02	67,2%	66,3	22,440	34574	159,98	1050
CMRS-X-1000-40 IE3	C	S	NO	1,02	67,5%	66,4	30,487	38361	196,94	1165
CMRS-X-1000-50 IE3	C	S	NO	1,02	68,1%	66,7	37,340	41160	226,73	1250
CMRS-X-1000-60 IE3	C	S	NO	1,03	68,0%	66,4	46,049	44123	260,55	1340
CMRS-X-1000-75 IE3	C	S	NO	1,03	68,2%	66,4	55,788	47087	296,73	1430
CMRS-X-1000-100 IE3	C	S	NO	1,03	68,6%	66,6	67,306	50215	337,46	1525
CMRS-X-1120-30 IE3	C	S	NO	1,01	67,6%	66,7	23,539	40277	144,94	880
CMRS-X-1120-40 IE3	C	S	NO	1,02	67,9%	66,8	31,357	44396	176,11	970
CMRS-X-1120-50 IE3	C	S	NO	1,02	68,5%	67,1	38,321	47600	202,44	1040



Erp. Características del punto de máxima eficiencia (BEP)

Modelo	MC	EC	VSD	SR	η_e [%]	N	[kW]	[m3/h]	[mmH ₂ O]	[RPM]
CMRS-X-1120-60 IE3	C	S	NO	1,02	68,5%	66,8	46,640	50804	230,61	1110
CMRS-X-1120-75 IE3	C	S	NO	1,03	68,7%	66,8	55,855	54008	260,61	1180
CMRS-X-1120-100 IE3	C	S	NO	1,03	69,0%	66,9	76,022	59958	321,20	1310
CMRS-X-1250-40 IE3	C	S	NO	1,02	69,0%	67,9	29,183	50208	147,26	800
CMRS-X-1250-50 IE3	C	S	NO	1,02	69,6%	68,3	35,947	53973	170,17	860
CMRS-X-1250-60 IE3	C	S	NO	1,02	69,6%	68,0	44,054	57739	194,75	920
CMRS-X-1250-75 IE3	C	S	NO	1,02	69,8%	68,0	53,079	61505	220,98	980
CMRS-X-1250-100 IE3	C	S	NO	1,03	70,1%	68,0	72,650	68408	273,37	1090
CMRS-X-1250-125 IE3	C	S	NO	1,03	70,3%	68,0	87,382	72801	309,61	1160
CMRS-X-1400-50 IE3	C	S	NO	1,02	68,8%	67,6	32,226	54594	149,04	690
CMRS-X-1400-60 IE3	C	S	NO	1,02	68,7%	67,3	39,794	58550	171,42	740
CMRS-X-1400-75 IE3	C	S	NO	1,02	68,9%	67,3	48,264	62506	195,37	790
CMRS-X-1400-100 IE3	C	S	NO	1,02	69,3%	67,3	65,234	69231	239,67	875
CMRS-X-1400-125 IE3	C	S	NO	1,03	69,5%	67,3	78,161	73583	270,75	930
CMRS-X-1400-150 IE3	C	S	NO	1,03	69,6%	67,2	96,969	79121	313,04	1000
CMRS-X-1600-75 IE3	C	S	NO	1,02	71,6%	69,8	55,669	90083	162,46	680
CMRS-X-1600-100 IE3	C	S	NO	1,02	72,0%	69,9	74,299	99356	197,62	750
CMRS-X-1600-125 IE3	C	S	NO	1,02	72,2%	69,8	89,983	105980	224,85	800
CMRS-X-1600-150 IE3	C	S	NO	1,03	72,3%	69,7	111,552	113929	259,84	860
CMRS-X-1600-175 IE3	C	S	NO	1,03	72,5%	69,7	131,886	120552	290,94	910
CMRS-X-1600-220 IE3	C	S	NO	1,03	72,6%	69,6	159,398	128501	330,57	970

Dimensiones mm

CMRS-X-350

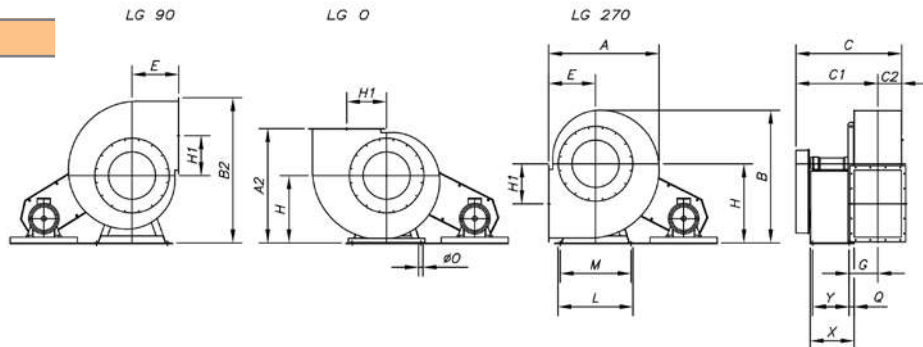

Modelo	A	A2	B	B2	C	C1	C2	E	G	Q	H	H1	L	M	øO	X	Y
CMRS-X-350	600	705	740	886,5	816	686	130	255	181	50	450	216	400	355	14	485	407

CMRS-X-400...500

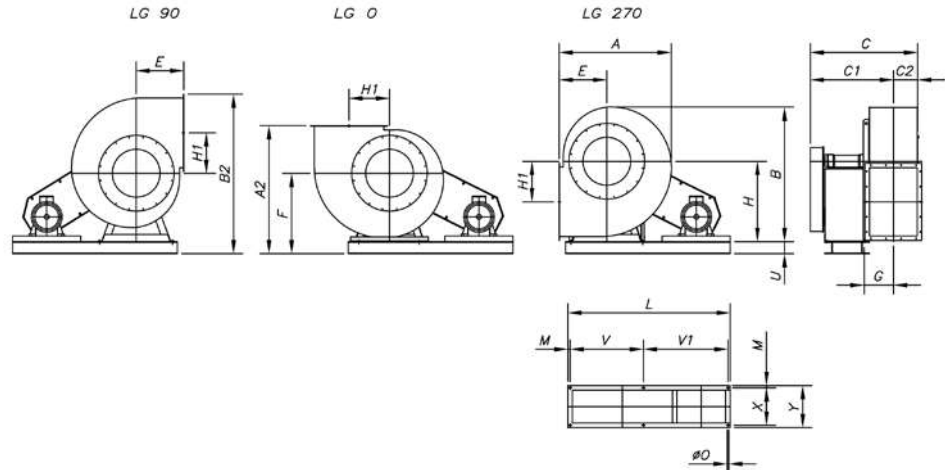

Modelo	A	A2	B	B2	C	C1	C2	E	F	G	H	H1	L	M	øO	U	V	V1	X	Y
CMRS-X-400	655	925	815	1127	869	722	147	285	640	197	500	245	1010	27	15	140	350,5	605,5	409	463
CMRS-X-450	735	1020	915	1241,5	902	739	163	320	700	215	560	275	1010	27	15	140	350,5	605,5	409	463
CMRS-X-500	832	1100	1000	1336,5	1047	864	183	360	740	235	600	303	1050	27	18	140	364	632	489	543

Dimensiones mm

CMRS-X-560...630

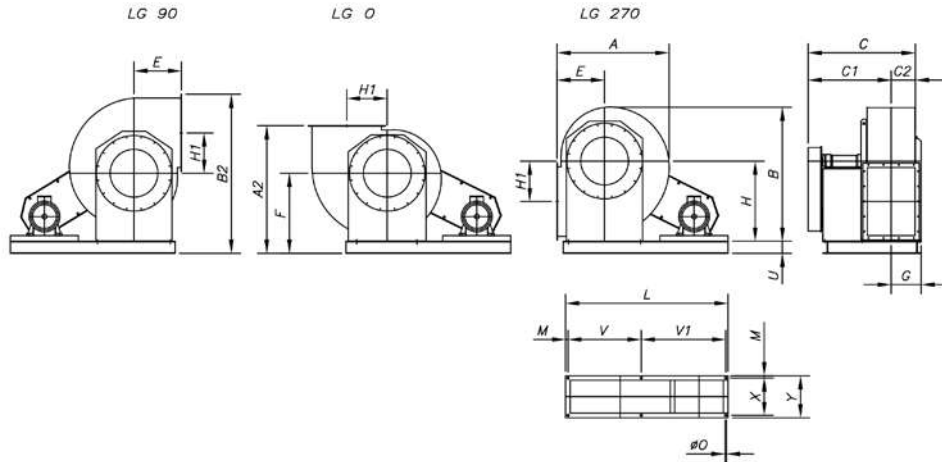

Modelo	A	A2	B	B2	C	C1	C2	E	F	G	H	H1	L	M	øO	U	V	V1	X	Y
CMRS-X-560	940	1210	1126	1476,5	1127	922	205	400	810	255	670	332	1370	27	15	140	635	681	967	1021
CMRS-X-630	1052	1340	1260	1632	1183	953	230	450	890	280	750	373	1470	27	15	140	705	711	1016	1070

CMRS-X-710...1600

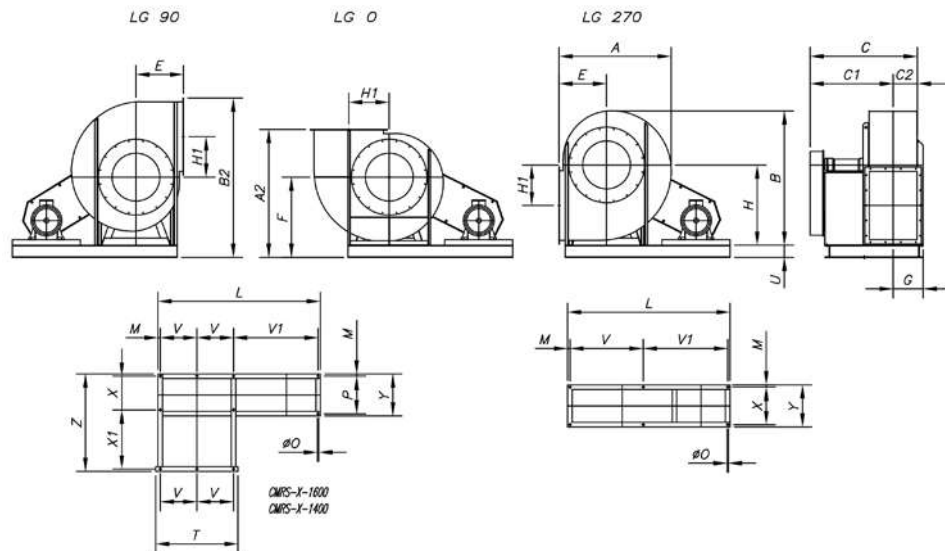

Modelo	A	A2	B	B2	C	C1	C2	E	F	G	H	H1	L	M	øO	U	T	V	V1	X	x1	Y	P	Z
CMRS-X-710	1160	1490	1416	1824,5	1283	1026	257	500	990	314	850	427	1633	27	15	140	-	772	807	1151	-	1205	-	-
CMRS-X-800	1312	1455	1591	1833,5	1344	1057	287	560	895	365	950	478	1768	27	15	140	-	867	847	1245	-	1299	-	-
CMRS-X-900	1470	1620	1780	2037	1414	1092	322	630	990	399	1060	538	2013	27	15	140	-	967	992	1314	-	1368	-	-
CMRS-X-1000	1656	1820	1993	2280,5	1612	1252	360	710	1110	458	1180	607	2164	27	15	160	-	1065	1045	1468	-	1522	-	-
CMRS-X-1120	1854	2040	2222	2559	1845	1441	404	800	1240	500	1320	684	2334	27	15	180	-	1196	1084	1732	-	1786	-	-
CMRS-X-1250	2084	2310	2517	2883,5	1941	1489	452	900	1410	549	1500	770	2630	27	15	220	-	1328	1248	1829	-	1883	-	-
CMRS-X-1400	2305	2500	2815	2934,5	2270	1764	506	1000	1500	603	1700	854	3150	35	24	180	1690	725	1630	780	1152	990	920	2000
CMRS-X-1600	2655	2800	3145	3262,5	2580	1746	568	1120	1680	685	1900	956	3340	35	28	180	1950	820	1120	920	1305	990	920	2295

Dimensiones mm

Boca de impulsión y aspiración

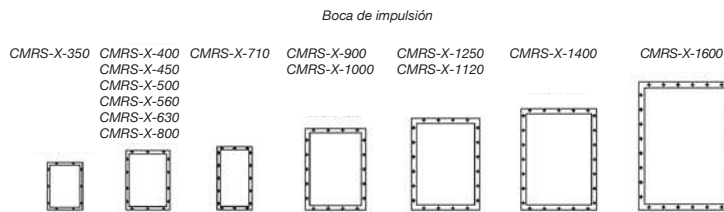
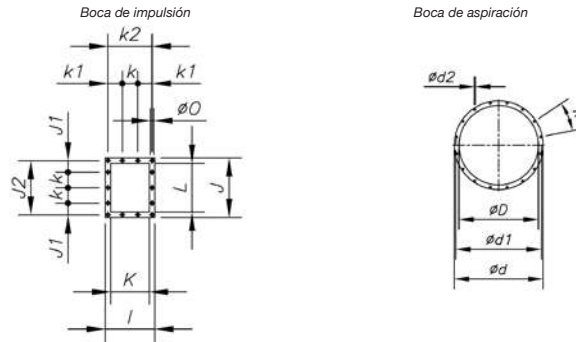

Modelo	ØD*	Ød	Ød1	Ød2	N	I	J	J1	J2	K	k	k1	k2	L	ØO
CMRS-X-350	360	440	405	10	8x45°	336	441	77,5	405	256	125	87,5	300	361	12
CMRS-X-400	405	485	448	10	12x30°	368	484	36,5	448	288	125	41	332	404	12
CMRS-X-450	455	535	497	10	12x30°	402	533	61	497	322	125	58	366	453	12
CMRS-X-500	505	585	551	10	12x30°	441	587	88	551	361	125	77,5	405	507	12
CMRS-X-560	565	665	629	10	12x30°	504	669	74,5	629	404	160	72	464	569	14
CMRS-X-630	635	735	698	12	12x30°	553	738	109	698	453	160	96,5	513	638	14
CMRS-X-710	715	815	775	12	16x22°30'	607	815	67,5	775	507	160	123,5	567	715	14
CMRS-X-800	805	905	861	12	16x22°30'	689	921	135,5	871	569	200	119,5	639	801	14
CMRS-X-900	905	1005	958	12	16x22°30'	758	1018	84	968	638	200	54	708	898	14
CMRS-X-1000	1007	1107	1067	12	24x15°	835	1127	138,5	1077	715	200	92,5	785	1007	14
CMRS-X-1120	1130	1250	1200	12	24x15°	941	1270	105	1210	801	200	140,5	881	1130	18
CMRS-X-1250	1260	1380	1337	12	24x15°	1038	1407	173,5	1347	898	200	189	978	1267	18
CMRS-X-1400	1410	1530	1491	10	32x11°15'	1147	1561	150,5	1501	1007	200	143,5	1087	1421	18
CMRS-X-1600	1610	1730	1663	12	32x11°15'	1290	1753	141,5	1683	1130	200	110	1220	1593	22

* Diámetro nominal tubería recomendada

Orientaciones

Suministro standard LG 270

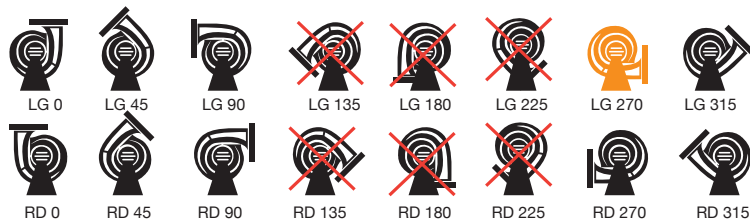

Accesorios

Ver apartado accesorios.

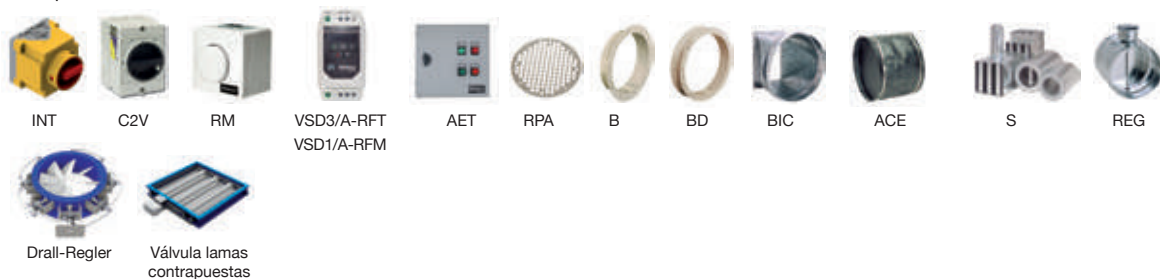

Curvas Características

Q= Caudal en m³/h, m³/s y cfm

Pe= Presión estática en mmH₂O, Pa e inwg

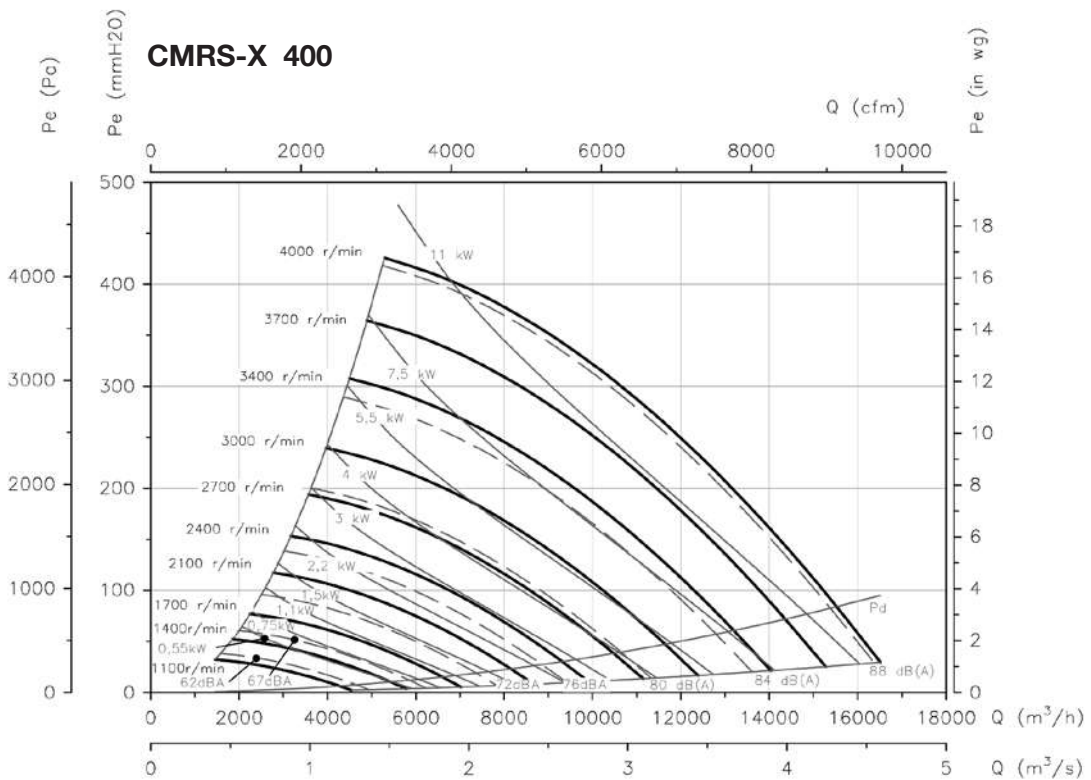
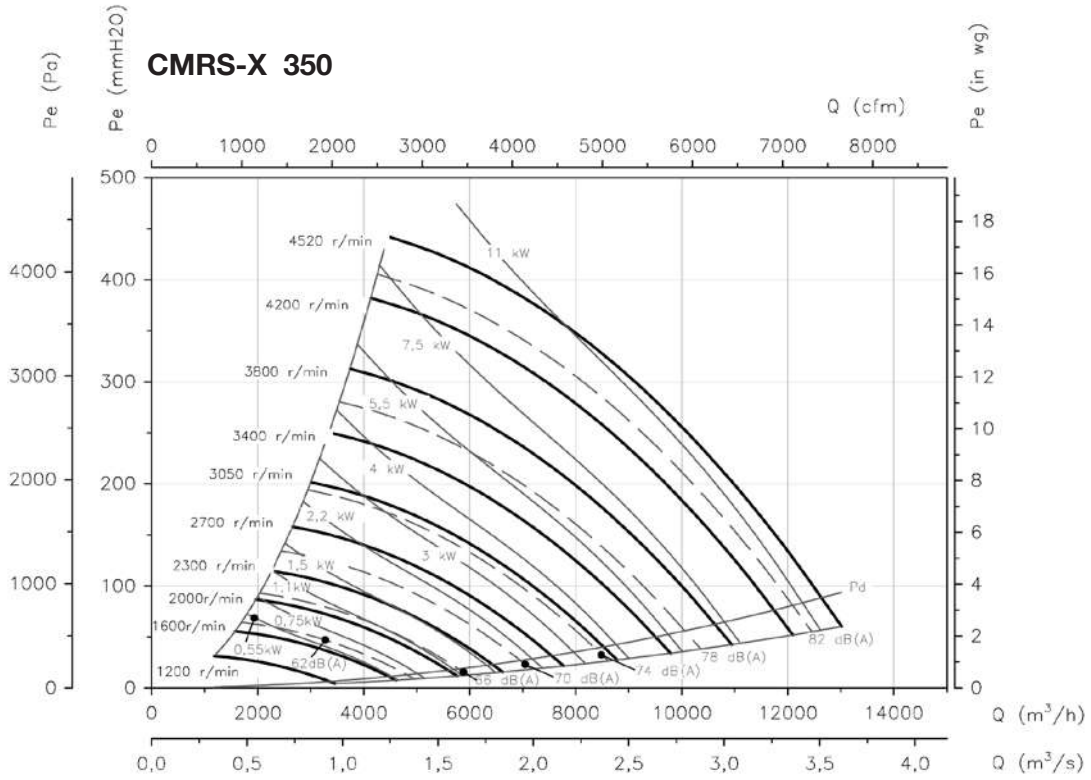



Curvas Características

Q= Caudal en m³/h, m³/s y cfm

Pe= Presión estática en mmH₂O, Pa e inwg

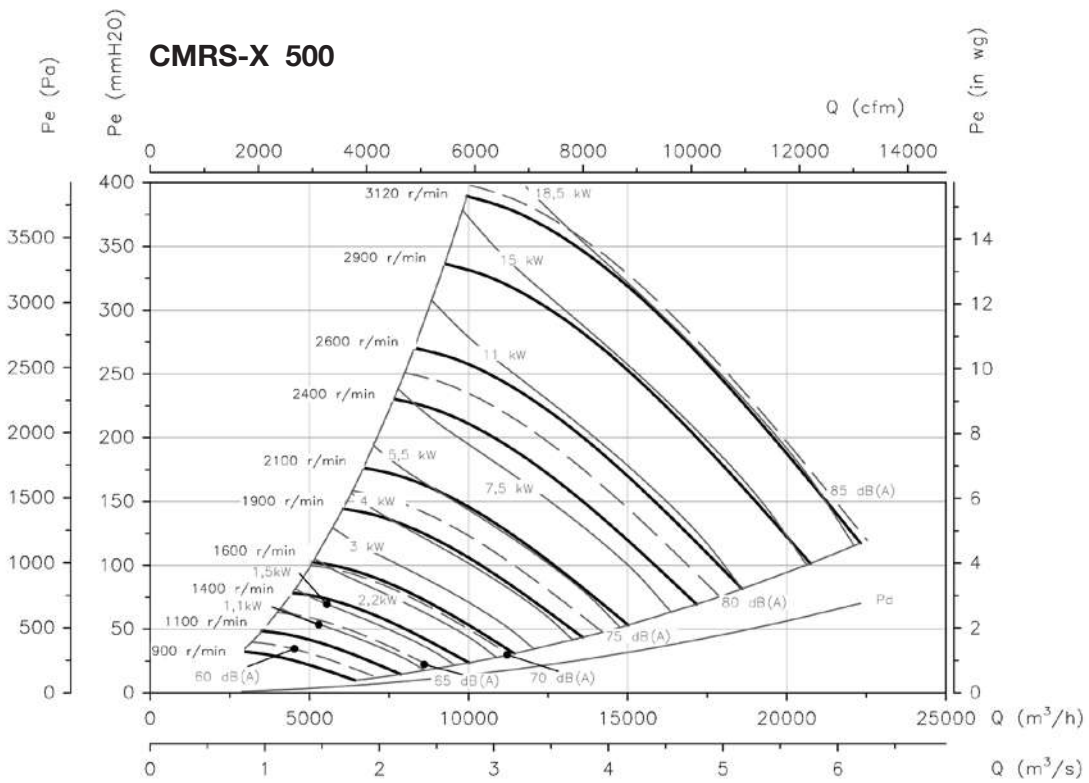
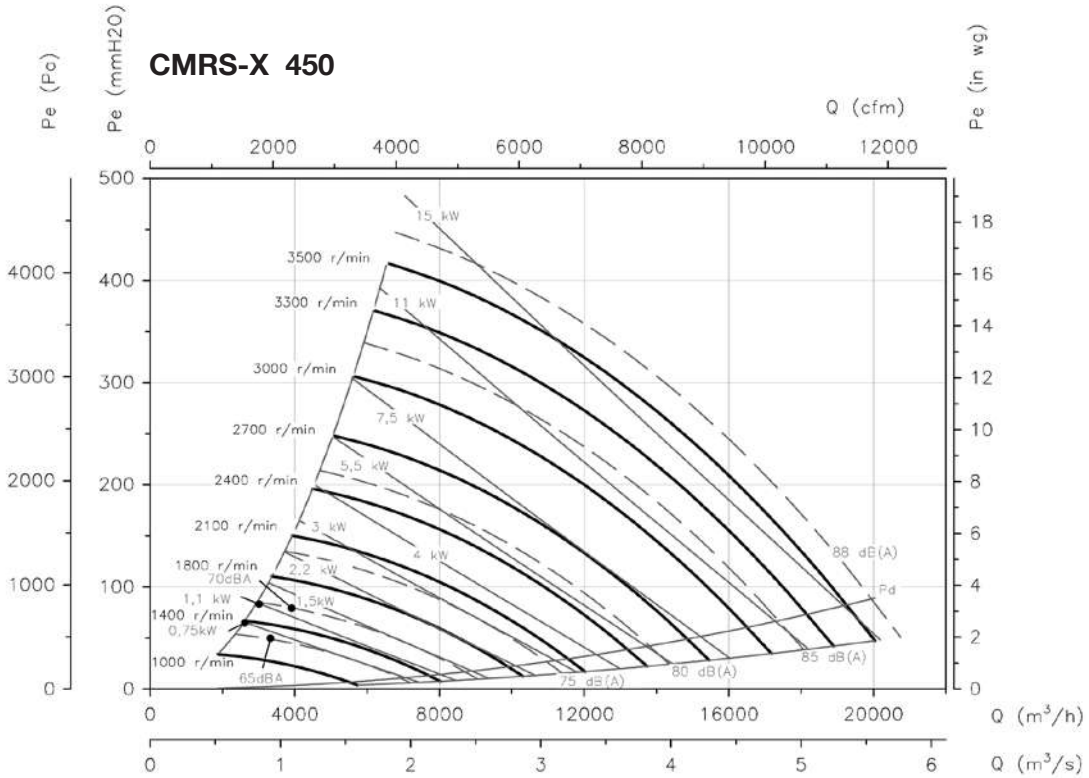

Curvas Características

Q= Caudal en m³/h, m³/s y cfm

Pe= Presión estática en mmH₂O, Pa e in wg

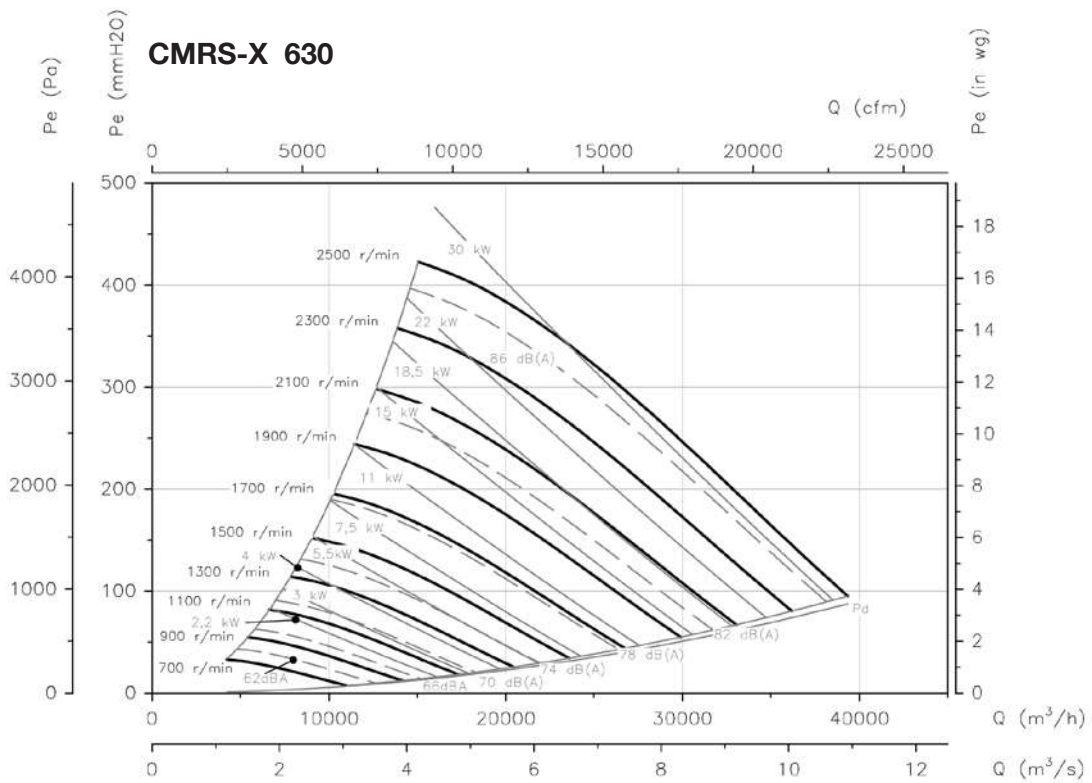
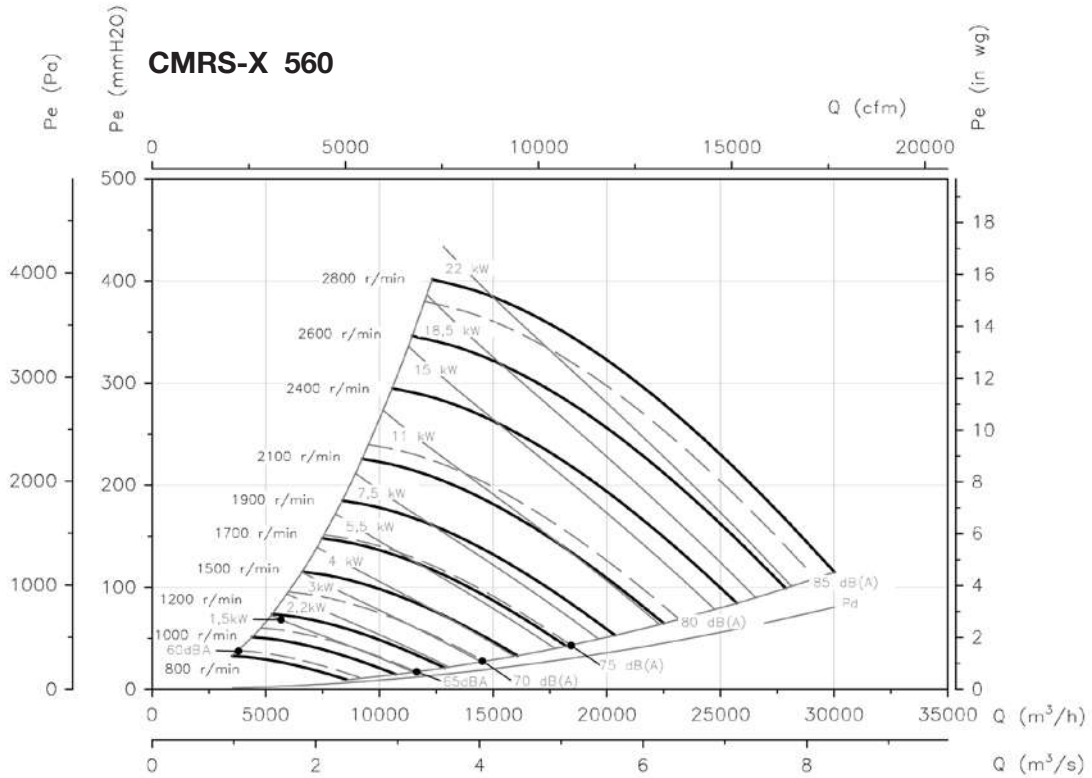



Curvas Características

Q= Caudal en m³/h, m³/s y cfm

Pe= Presión estática en mmH₂O, Pa e inwg

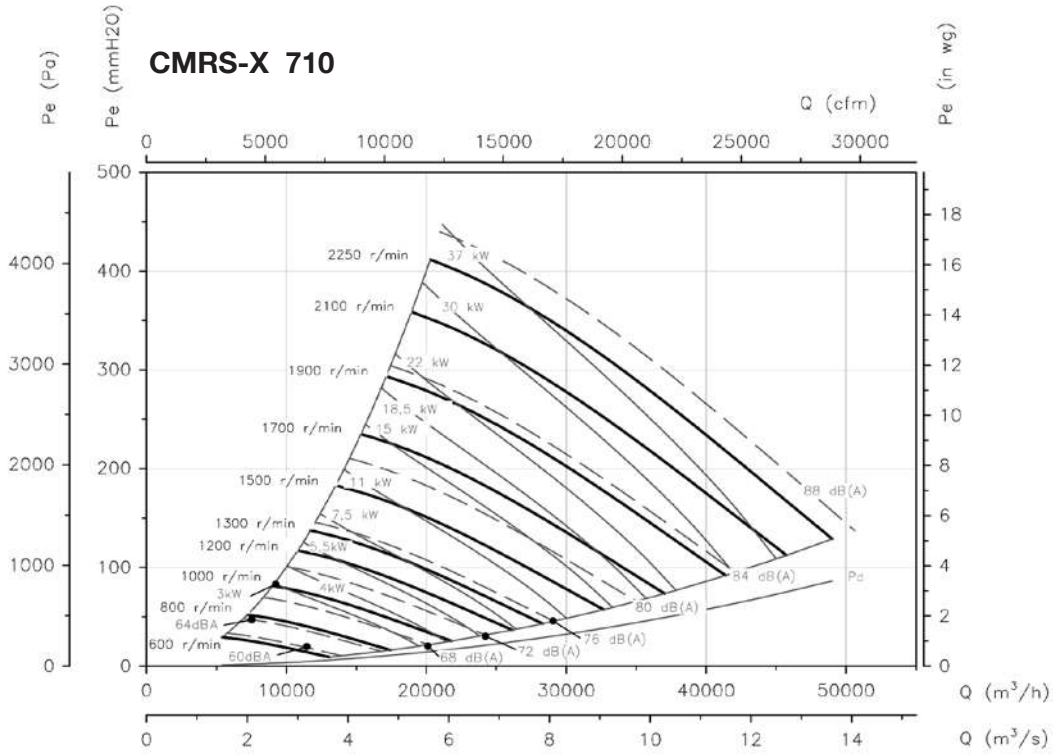

CMRS-X 800

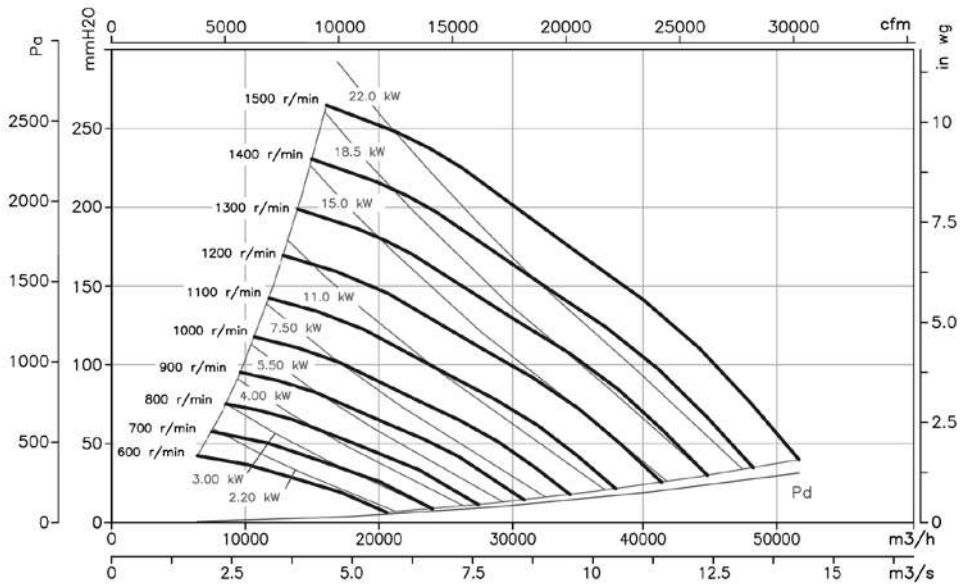

Curvas Características

Q= Caudal en m³/h, m³/s y cfm

Pe= Presión estática en mmH₂O, Pa e inwg

CMRS-X 900

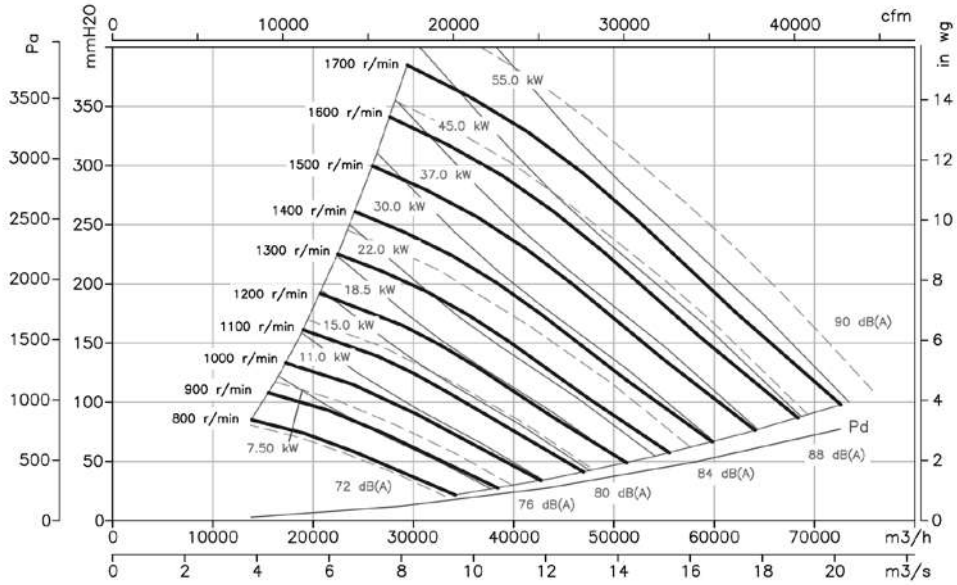

CMRS-X 1000

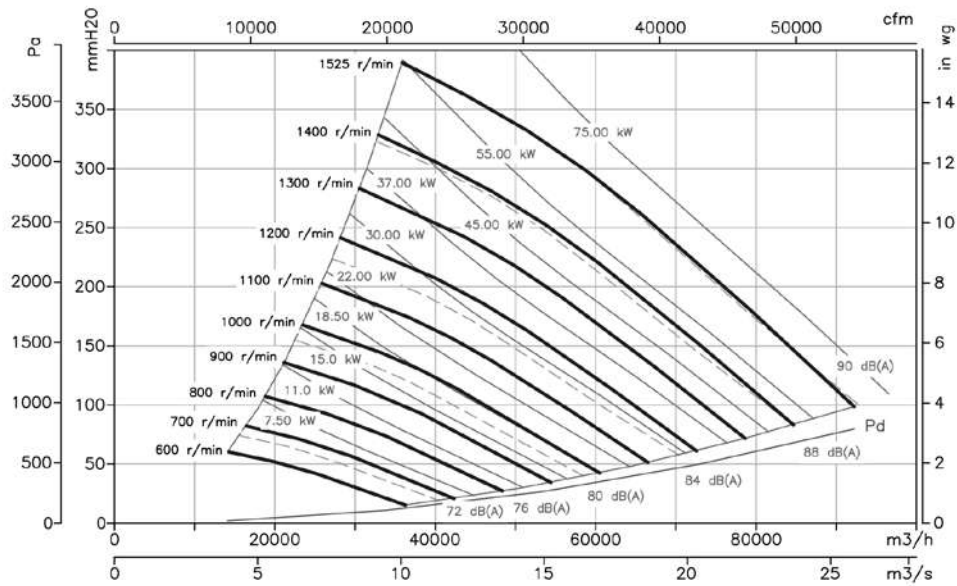

Curvas Características

Q= Caudal en m³/h, m³/s y cfm

Pe= Presión estática en mmH₂O, Pa e inwg

CMRS-X 1120

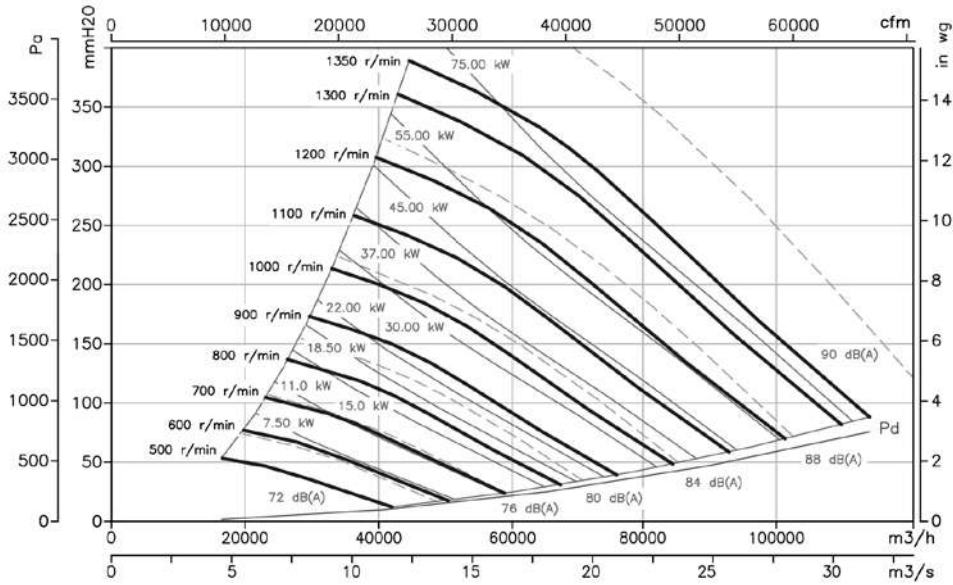

CMRS-X 1250

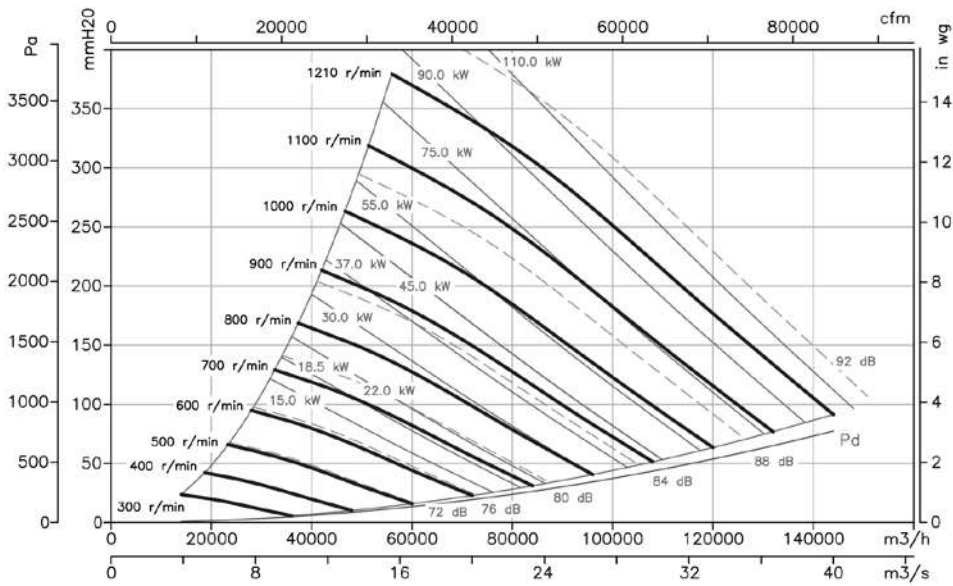

Curvas Características

Q= Caudal en m³/h, m³/s y cfm

Pe= Presión estática en mmH₂O, Pa e inwg

CMRS-X 1400

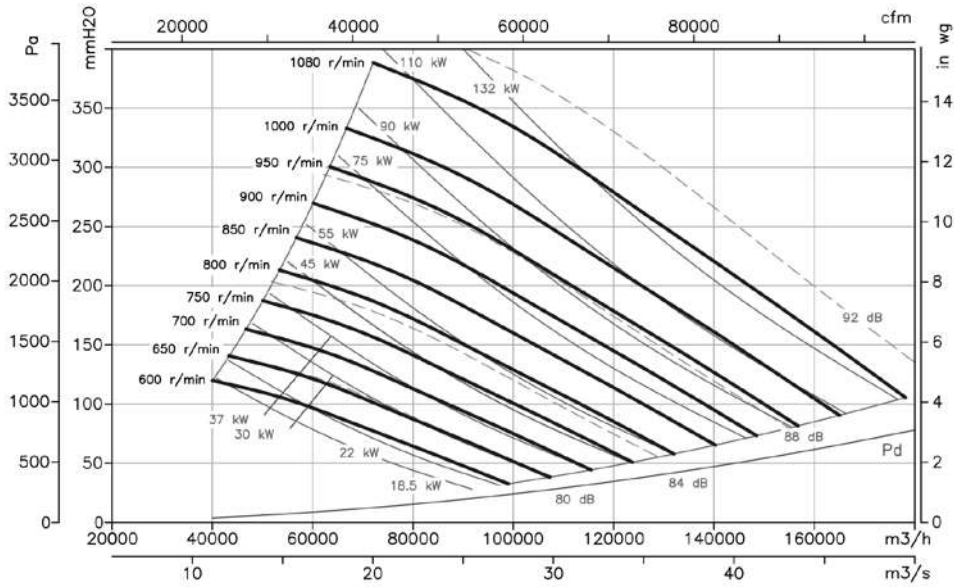

CMRS-X 1600

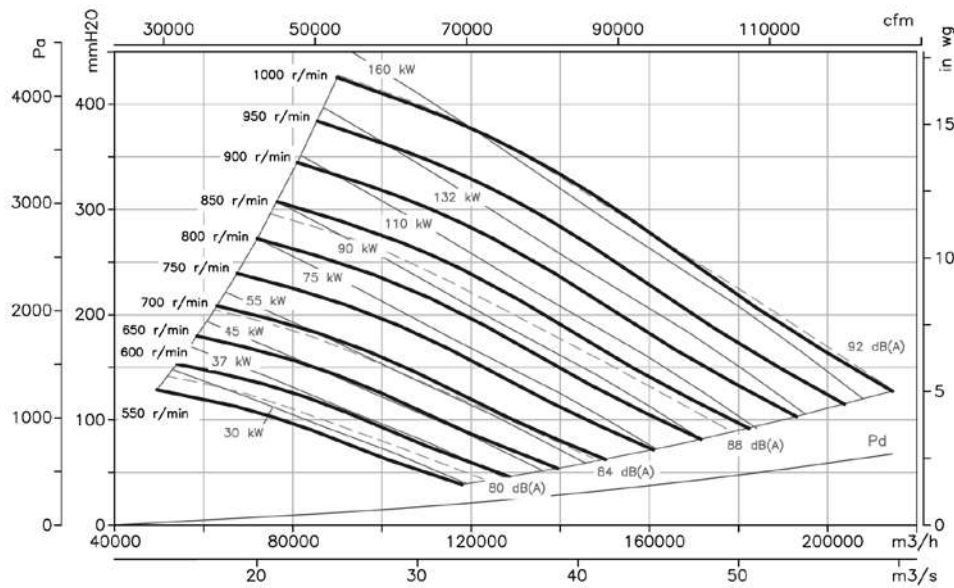

CASB



Ventiladores centrífugos de alta presión y simple aspiración de gran robustez, con envolvente y turbina en chapa de acero



Ventilador:

- Envolvente en chapa de acero
- Turbina con álabes hacia atrás, en chapa de acero de gran robustez, especialmente diseñada para transportar aire limpio y aire polvoriento o ligeramente granulado
- Motor directamente acoplado

Motor:

- Motores de eficiencia IE3 para potencias iguales o superiores a 7,5kW, excepto monofásicos, 2 velocidades y 8 polos
- Motores clase F, con rodamientos a bolas, protección IP55
- Trifásicos 230/400V-50Hz (hasta 4kW) y 400/690V-50Hz (potencias superiores a 4kW)
- Temperatura máxima del aire a transportar: -25°C + 120°C

Acabado:

- Anticorrosivo en resina de poliéster polimerizada a 190 °C, previo desengrase con tratamiento nanotecnológico libre de fosfatos.

Bajo demanda:

- Bobinados especiales para diferentes tensiones
- Ventilador preparado para transportar aire hasta 250°C
- Ventilador en acero inoxidable
- Certificación ATEX Categoría 2
- Motores de eficiencias IE2 e IE3 para cualquier potencia
- Acoplamiento elástico sistema 8

Código de pedido

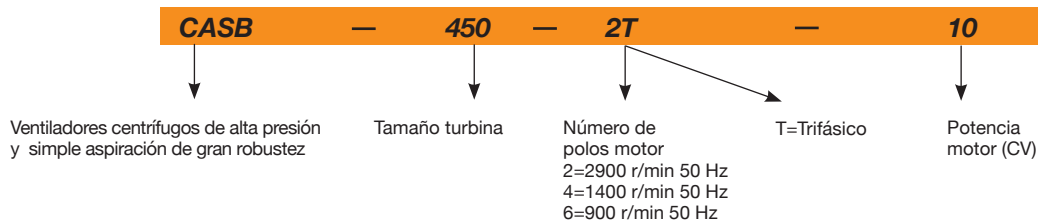

Características técnicas

Modelo	Velocidad (r/min)	Intensidad máx admisible (A)			Potencia instalada (kW)	Caudal máximo (m³/h)	Nivel Presión Sonora dB(A)	Peso aprox (Kg)	According ErP
		230 V	400 V	690 V					
CASB-350-2T-3	2860	7,75	4,48		2,20	3950	70	68	2015
CASB-400-2T-5.5	2880	13,30	7,63		4,00	5550	74	105	2015
CASB-450-2T-10 IE3	2935		13,90	8,06	7,50	7900	77	150	2015
CASB-500-2T-15 IE3	2950		20,10	11,70	11,00	10800	80	230	2015
CASB-500-4T-1.5	1420	4,33	2,50		1,10	5020	62	129	2015
CASB-560-2T-20 IE3	2950		27,10	15,70	15,00	13750	83	282	2015
CASB-560-2T-25 IE3	2950		33,30	19,30	18,50	15900	83	292	2015
CASB-560-4T-3	1445	8,36	4,83		2,20	7800	65	138	2015
CASB-630-2T-40 IE3	2965		53,50	31,00	30,00	19450	86	382	2015
CASB-630-2T-50 IE3	2965		65,60	38,00	37,00	22700	88	392	2015
CASB-630-4T-5.5	1460		10,60	6,10	5,50	10900	71	221	2015
CASB-710-4T-7.5	1460		10,60	6,10	5,50	13000	71	272	2015
CASB-710-4T-10 IE3	1465		13,90	8,06	7,50	15300	73	281	2015
CASB-800-4T-15 IE3	1470		20,70	12,00	11,00	19300	76	421	2015
CASB-800-4T-20 IE3	1470		28,40	16,50	15,00	22450	76	396	2015
CASB-800-6T-5.5	960	16,50	9,46		4,00	13700	66	337	2015
CASB-900-4T-30 IE3	1470		40,90	23,70	22,00	27550	78	581	2015
CASB-900-4T-40 IE3	1480		56,10	32,50	30,00	31800	79	672	2015
CASB-900-6T-10 IE3	975		14,70	8,52	7,50	19550	68	486	2015
CASB-1000-4T-50 IE3	1480		65,60	38,00	37,00	38600	82	752	2015
CASB-1000-4T-60 IE3	1480		79,40	46,00	45,00	42900	84	759	2015
CASB-1000-6T-15 IE3	975		21,50	12,50	11,00	26750	73	614	2015
CASB-1000-6T-20 IE3	975		28,00	16,20	15,00	29700	73	640	2015

Características técnicas

Modelo	Velocidad (r/min)	Intensidad máx admisible (A)			Potencia instalada (kW)	Caudal máximo (m³/h)	Nivel Presión Sonora dB(A)	Peso aprox (Kg)	According ErP
		230 V	400 V	690 V					
CASB-1120-4T-75 IE3	1480		96,90	56,20	55,00	55100	86	1143	2015
CASB-1120-4T-100 IE3	1485		130,00	75,40	75,00	63050	86	1215	2015
CASB-1120-6T-25 IE3	980		35,20	20,40	18,50	38000	76	969	2015
CASB-1120-6T-30 IE3	980		41,70	24,20	22,00	41600	77	991	2015
CASB-1250-4T-150 IE3	1490		192,00	111,00	110,00	78600	89	1466	2015
CASB-1250-4T-175 IE3	1490		230,00	133,00	132,00	87500	90	1537	2015
CASB-1250-6T-40 IE3	985		54,20	31,40	30,00	51550	79	1222	2015
CASB-1250-6T-50 IE3	985		66,60	38,60	37,00	57400	79	1319	2015
CASB-1400-6T-60 IE3	990		83,40	48,30	45,00	64350	81	1829	2015
CASB-1400-6T-100 IE3	990		136,00	78,80	75,00	85800	83	1951	2015



Erp. Características del punto de máxima eficiencia (BEP)

MC	Categoría de medición	ηe[%]	Eficiencia
EC	Categoría de eficiencia	N	Grado de eficiencia
S	Estática	[kW]	Potencia eléctrica
T	Total	[m³/h]	Caudal
VSD	Variador de velocidad	[mmH₂O]	Presión estática o total (Según EC)
SR	Relación específica	[RPM]	Velocidad

Modelo	MC	EC	VSD	SR	ηe [%]	N	[kW]	[m3/h]	[mmH ₂ O]	[RPM]
CASB-350-2T-3	B	T	NO	1,02	60,7%	67,3	2,32	3006	171,40	2878
CASB-400-2T-5.5	B	T	NO	1,02	64,2%	68,7	3,75	3826	230,96	2903
CASB-450-2T-10 IE3	B	T	NO	1,03	68,7%	70,4	6,90	6156	282,49	2946
CASB-500-2T-15 IE3	B	T	NO	1,03	73,0%	72,9	11,58	9875	314,16	2951
CASB-500-4T-1.5	B	T	NO	1,01	63,8%	73,0	1,33	4592	67,93	1421
CASB-560-2T-20 IE3	B	T	NO	1,03	71,7%	71,3	15,61	11911	344,81	2952
CASB-560-2T-25 IE3	B	T	NO	1,04	73,2%	72,5	19,29	12502	414,47	2951
CASB-560-4T-3	B	T	NO	1,01	66,0%	72,3	2,52	6126	99,51	1447
CASB-630-2T-40 IE3	B	T	NO	1,05	71,0%	70,0	27,66	15475	465,88	2970
CASB-630-2T-50 IE3	B	T	NO	1,05	71,7%	70,4	33,90	16822	530,04	2970
CASB-630-4T-5.5	B	T	NO	1,01	65,9%	70,1	3,95	7990	119,59	1448
CASB-710-4T-7.5	B	T	NO	1,01	66,6%	69,7	5,05	9150	134,76	1468
CASB-710-4T-10 IE3	B	T	NO	1,01	70,2%	72,2	6,44	11028	150,27	1473
CASB-800-4T-15 IE3	B	T	NO	1,02	72,0%	72,1	10,33	15811	172,74	1474
CASB-800-4T-20 IE3	B	T	NO	1,02	74,3%	74,0	14,38	17743	221,10	1473
CASB-800-6T-5.5	B	T	NO	1,01	66,4%	70,6	4,01	11226	87,08	966
CASB-900-4T-30 IE3	B	T	NO	1,03	76,2%	75,4	21,53	22394	268,67	1473
CASB-900-4T-40 IE3	B	T	NO	1,03	74,9%	73,9	26,17	23547	305,41	1484
CASB-900-6T-10 IE3	B	T	NO	1,01	73,8%	74,8	7,95	15900	135,44	976
CASB-1000-4T-50 IE3	B	T	NO	1,03	74,8%	73,7	30,82	26615	318,03	1484
CASB-1000-4T-60 IE3	B	T	NO	1,03	78,3%	76,8	42,81	34463	356,87	1482
CASB-1000-6T-15 IE3	B	T	NO	1,01	72,2%	72,2	10,64	18444	152,73	978
CASB-1000-6T-20 IE3	B	T	NO	1,02	76,0%	75,6	14,62	23848	170,89	978
CASB-1120-4T-75 IE3	B	T	NO	1,04	82,0%	80,4	46,38	31367	444,85	1484
CASB-1120-4T-100 IE3	B	T	NO	1,04	76,9%	74,7	76,43	50764	424,80	1485
CASB-1120-6T-25 IE3	B	T	NO	1,02	79,6%	79,1	15,70	21643	211,79	984
CASB-1120-6T-30 IE3	B	T	NO	1,02	74,7%	73,9	22,61	33505	185,04	981
CASB-1250-4T-150 IE3	B	T	NO	1,05	77,9%	75,4	99,42	54704	519,41	1491
CASB-1250-4T-175 IE3	B	T	NO	1,06	78,0%	75,2	130,19	65064	572,53	1490
CASB-1250-6T-40 IE3	B	T	NO	1,02	76,0%	74,9	28,75	35886	223,52	986
CASB-1250-6T-50 IE3	B	T	NO	1,02	76,5%	75,1	37,63	43240	244,32	986
CASB-1400-6T-60 IE3	B	T	NO	1,03	75,6%	74,1	41,26	42249	270,82	991
CASB-1400-6T-100 IE3	B	T	NO	1,03	77,7%	75,6	67,97	59732	324,35	991

Dimensiones mm

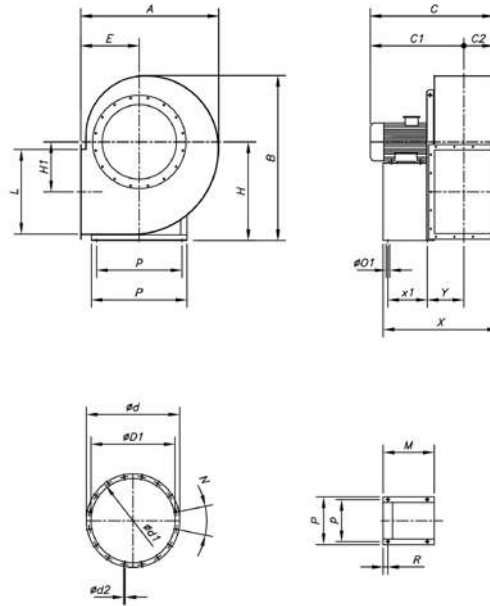
CASB-350...500



Ventilador	A	B	C	C1	C2	ØD1	Ød	Ød1	Ød2	N	E	H	H1	L	M	R	Ø01	P	p	X	x1	Y
CASB-350-2T-3	600	740	530	415	115	285	365	332	10	8X45°	255	450	253	288	225	37	10	260	234	479	133	162
CASB-400-2T-5.5	655	815	630	503	127	320	400	366	12	8X45°	285	500	286	322	280	53	12	324	289	556	197	148
CASB-450-2T-10	735	915	670	530	140	360	440	405	12	8X45°	320	560	321	361	320	43	12	372	337	622	237	171
CASB-500-2T-15	832	1000	830	671	159	405	485	448	12	12x30°	360	600	355	404	435	48	14	440	395	771	337	198
CASB-500-4T-1.5	832	1000	580	421	159	405	485	448	12	12x30°	360	600	355	404	225	47	10	260	234	561	133	203

CASB-560...630

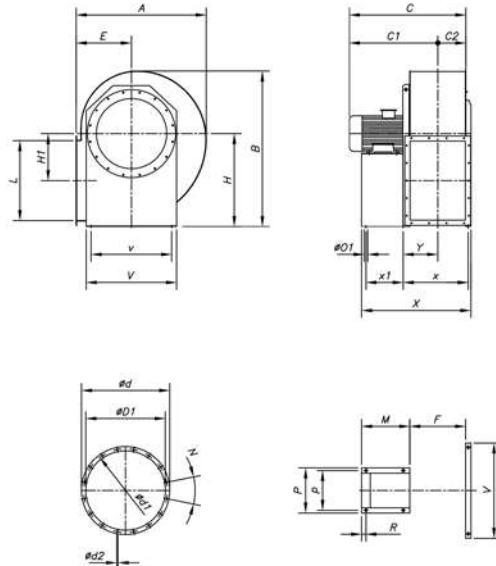

Ventilador	A	B	C	C1	C2	ØD1	Ød	Ød1	Ød2	N	E	H	H1	L	F	M	R	Ø01	P	p	V	v	X	x	x1	Y
CASB-560-2T-20	940	1126	830	650	180	455	535	497	12	12x30°	400	670	390	453	332	435	48	14	440	395	692	632	790	410	337	215
CASB-560-2T-25	940	1126	830	650	180	455	535	497	12	12x30°	400	670	390	453	332	435	48	14	440	395	692	632	790	410	337	215
CASB-560-4T-3	940	1126	655	475	180	455	535	497	12	12x30°	400	670	390	453	332	280	53	12	324	289	692	632	625	390	197	195
CASB-630-2T-40	1052	1260	1030	830	200	505	585	551	13	12x30°	450	750	439	507	361	500	39	20	568	506	762	702	914	475	381	265
CASB-630-2T-50	1052	1260	1030	830	200	505	585	551	13	12x30°	450	750	439	507	361	500	39	20	568	506	762	702	914	475	381	265
CASB-630-4T-5.5	1052	1260	725	525	200	505	585	551	13	12x30°	450	750	439	507	361	280	53	14	324	289	762	702	664	430	197	215

Dimensiones mm

CASB-710...1400

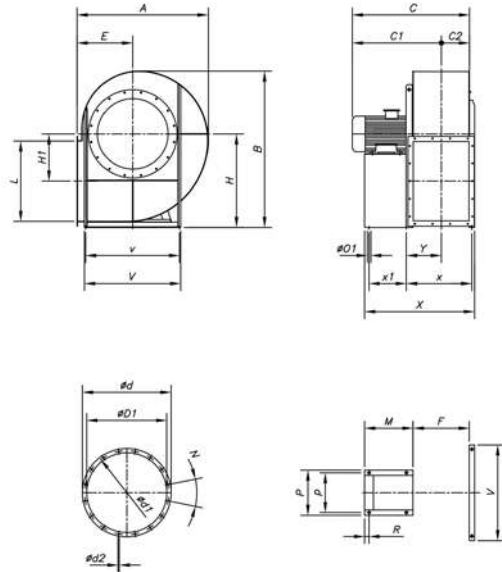

Ventilador	A	B	C	C1	C2	ØD1	Ød	Ød1	Ød2	N	E	H	H1	L	F	M	R	ØO1	P	p	V	v	X	x	x1	Y
CASB-710-4T-7.5	1189	1416	830	609	221	565	665	629	13	12x30°	500	850	500	569	404	320	59	20	826	772	915	772	764	497	201	265
CASB-710-4T-10	1189	1416	816	595	221	565	665	629	13	12x30°	500	850	500	569	404	320	59	20	826	772	915	772	764	497	201	265
CASB-800-4T-15	1340	1591	880	634	246	635	735	698	15	12x30°	560	950	560	638	453	435	59	20	926	862	1045	862	948	546	315	290
CASB-800-4T-20	1340	1591	880	634	246	635	735	698	15	12x30°	560	950	560	638	453	435	59	20	926	862	1045	862	948	546	315	290
CASB-800-6T-5.5	1340	1591	860	614	246	635	735	698	15	12x30°	560	950	560	638	453	320	59	20	926	862	1045	862	833	546	201	289
CASB-900-4T-30	1500	1780	1032	755	277	715	815	775	15	16x22°30'	630	1060	630	715	507	480	59	20	1026	962	1145	962	1047	600	361	313
CASB-900-4T-40	1500	1780	1170	893	277	715	815	775	15	16x22°30'	630	1060	630	715	507	500	39	20	1026	962	1145	962	1087	600	401	316
CASB-900-6T-10	1500	1780	997	720	277	715	815	775	15	16x22°30'	630	1060	630	715	507	435	59	20	1026	962	1145	962	1047	600	316	313
CASB-1000-4T-50	1685	1993	1240	932	308	805	905	861	15	16x22°30'	710	1180	710	801	569	550	55	20	1128	1056	1255	1056	1209	657	440	339
CASB-1000-4T-60	1685	1993	1240	932	308	805	905	861	15	16x22°30'	710	1180	710	801	569	550	55	20	1128	1056	1255	1056	1209	657	440	339
CASB-1000-6T-15	1685	1993	1115	807	308	805	905	861	15	16x22°30'	710	1180	710	801	569	435	65	20	1128	1056	1255	1056	1084	657	315	339
CASB-1000-6T-20	1685	1993	1150	842	308	805	905	861	15	16x22°30'	710	1180	710	801	569	480	65	20	1128	1056	1255	1056	1129	657	360	339
CASB-1120-4T-75	1884	2222	1500	1157	343	905	1005	958	15	16x22°30'	800	1320	800	898	638	600	65	24	1268	1178	1400	1178	1428	763	475	379
CASB-1120-4T-100	1884	2222	1540	1197	343	905	1005	958	15	16x22°30'	800	1320	800	898	638	690	45	24	1268	1178	1400	1178	1428	763	565	399
CASB-1120-6T-25	1884	2222	900	557	343	905	1005	958	15	16x22°30'	800	1320	800	898	638	500	65	24	1268	1178	1400	1178	1428	763	375	379
CASB-1120-6T-30	1884	2222	910	567	343	905	1005	958	15	16x22°30'	800	1320	800	898	638	500	65	24	1268	1178	1400	1178	1428	763	375	379
CASB-1250-4T-150	2075	2505	1678	1293	385	1008	1108	1067	10	24x15°	900	1500	900	1007	770	800	50	24	1390	1300	1540	1310	1614	840	670	437
CASB-1250-4T-175	2075	2505	1678	1293	385	1008	1108	1067	10	24x15°	900	1500	900	1007	770	800	50	24	1390	1300	1540	1310	1614	840	670	437
CASB-1250-6T-40	2075	2505	1458	1073	385	1008	1108	1067	10	24x15°	900	1500	900	1007	770	550	50	24	1390	1300	1540	1310	1364	840	420	437
CASB-1250-6T-50	2075	2505	1533	1148	385	1008	1108	1067	10	24x15°	900	1500	900	1007	770	620	50	24	1390	1300	1540	1310	1434	840	490	437
CASB-1400-6T-60	2305	2815	1745	1315	430	1130	1250	1200	10	24x15°	1000	1700	1000	1130	860	740	60	24	1530	1450	1690	1450	1640	946	580	500
CASB-1400-6T-100	2305	2815	1765	1335	430	1130	1250	1200	10	24x15°	1000	1700	1000	1130	860	800	60	24	1530	1450	1690	1450	1700	946	640	500

Dimensiones mm

Boca de impulsión

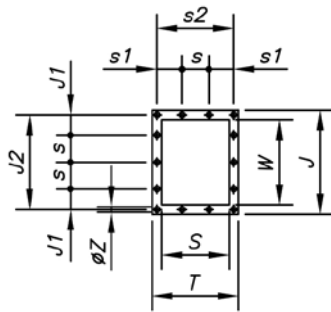

CASB-350
CASB-400
CASB-450

CASB-500
CASB-560
CASB-630
CASB-710
CASB-800
CASB-1000

CASB-900

CASB-1120
CASB-1250

CASB-1400

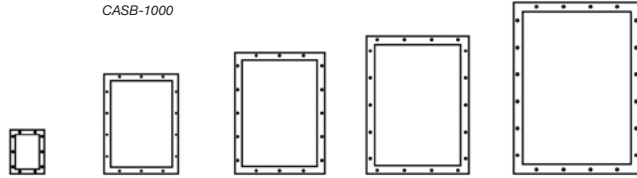

Ventilador	T	J	J1	J2	S	s	s1	s2	W	ØZ
CASB-350	285	368	41	332	205	125	62	249	288	12
CASB-400	309	402	58	366	229	125	74	273	322	12
CASB-450	336	441	78	405	256	125	88	300	361	12
CASB-500	368	484	37	448	288	125	41	332	404	12
CASB-560	402	533	61	497	322	125	58	366	453	12
CASB-630	441	587	88	551	361	125	78	405	507	12
CASB-710	504	669	75	629	404	160	72	464	569	14
CASB-800	553	738	109	698	453	160	97	513	638	14
CASB-900	607	815	68	775	507	160	124	567	715	14
CASB-1000	689	921	136	871	569	200	120	639	801	14
CASB-1120	758	1018	84	968	638	200	54	708	898	14
CASB-1250	835	1127	139	1077	715	200	93	785	1007	14
CASB-1400	941	1270	105	1210	801	200	141	881	1130	18

Curvas Características

Q= Caudal en m³/h, m³/s y cfm

Pe= Presión estática en mmH₂O, Pa e inwg

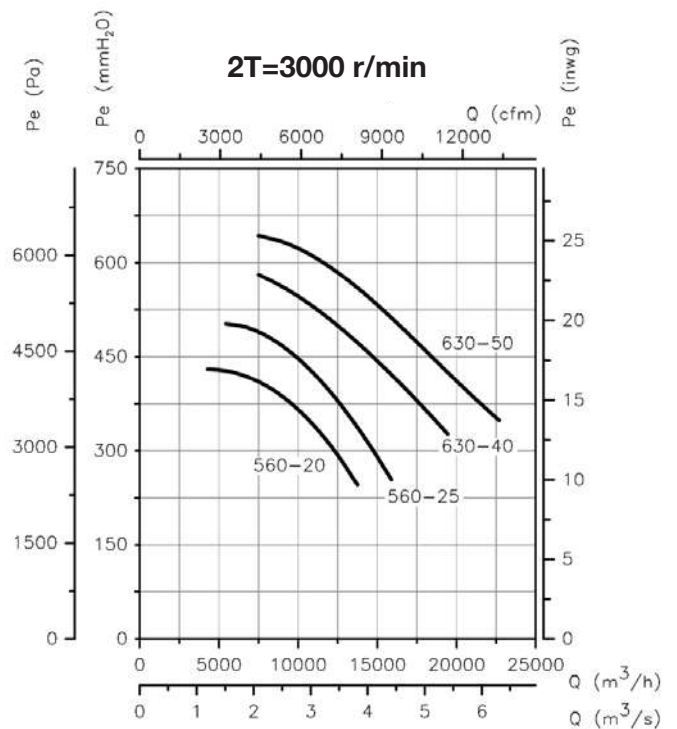
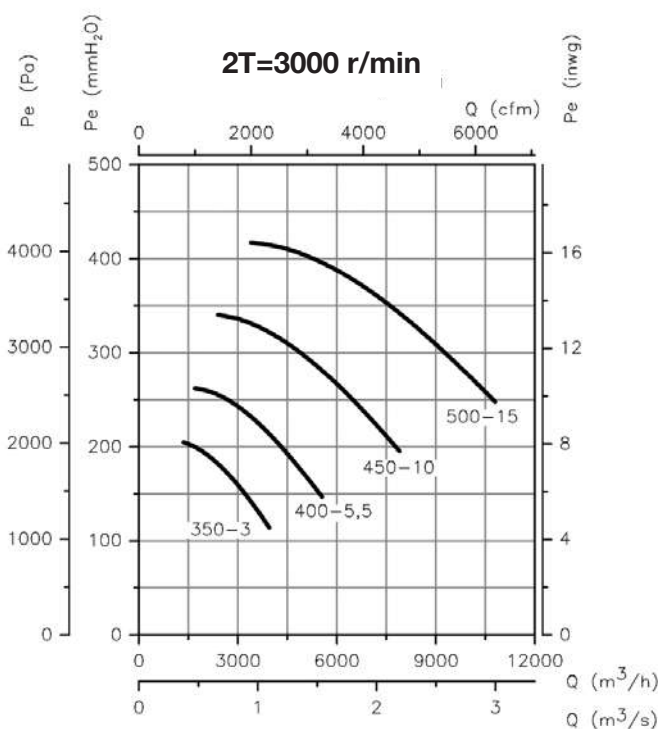

Curvas Características

Q= Caudal en m³/h, m³/s y cfm

Pe= Presión estática en mmH₂O, Pa e inwg

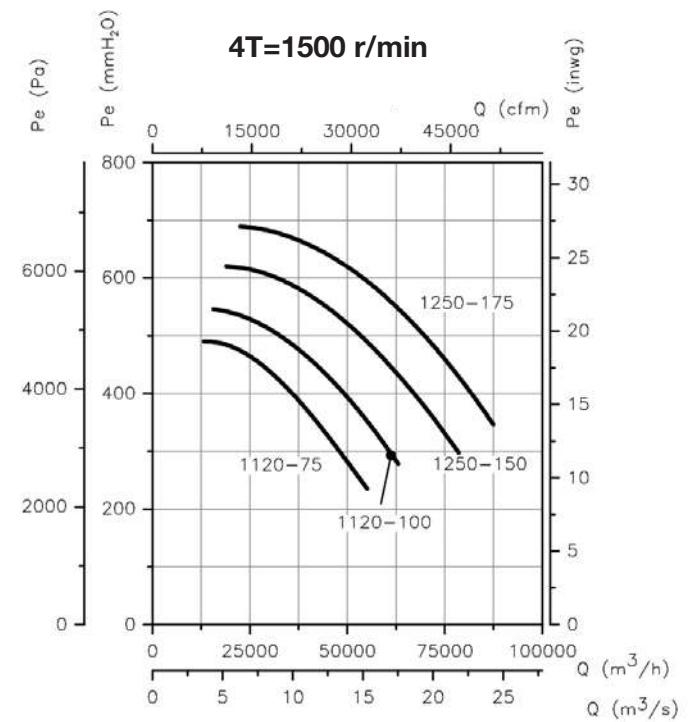
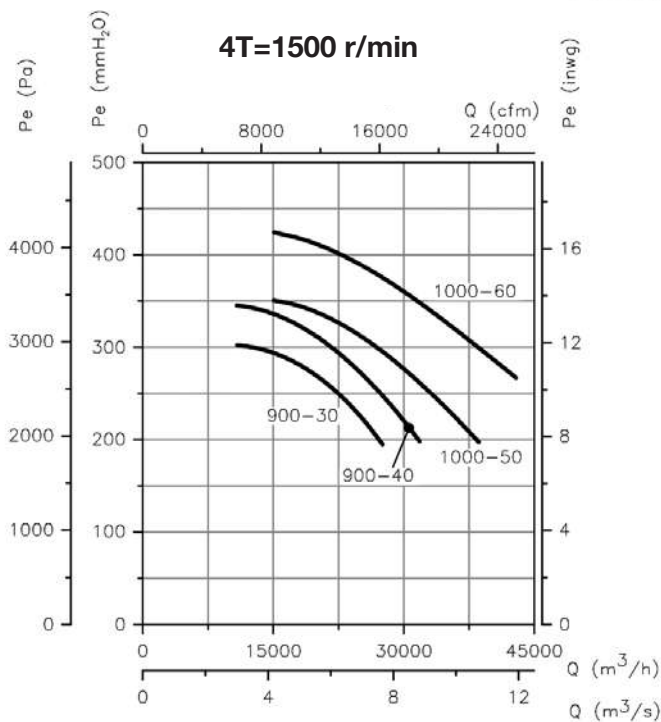
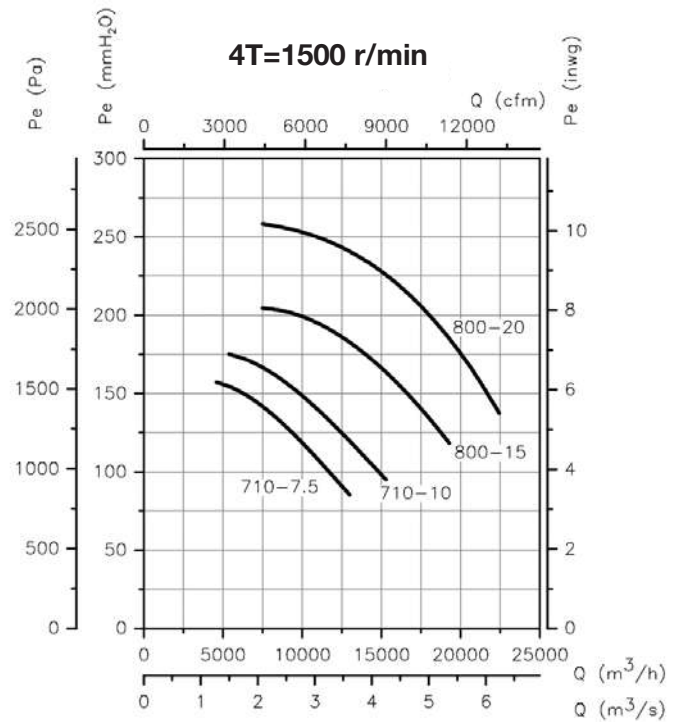
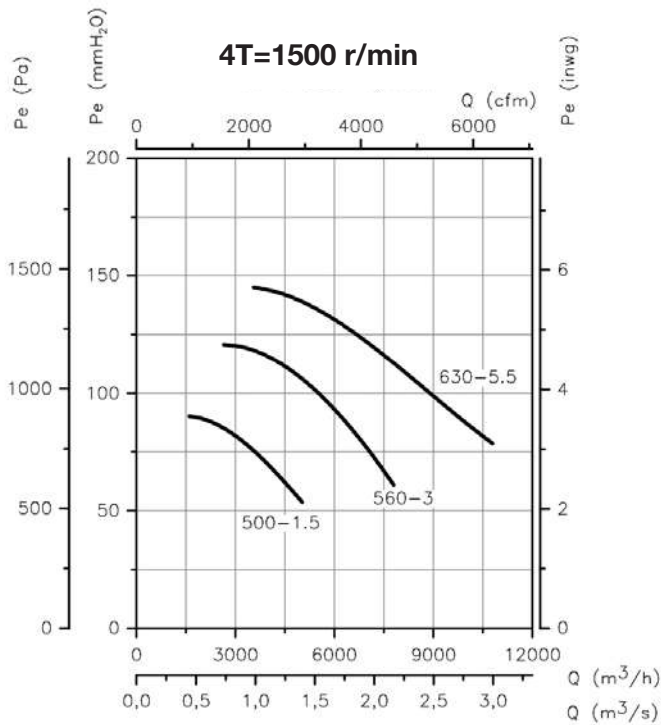

Accesorios

Ver apartado accesorios.

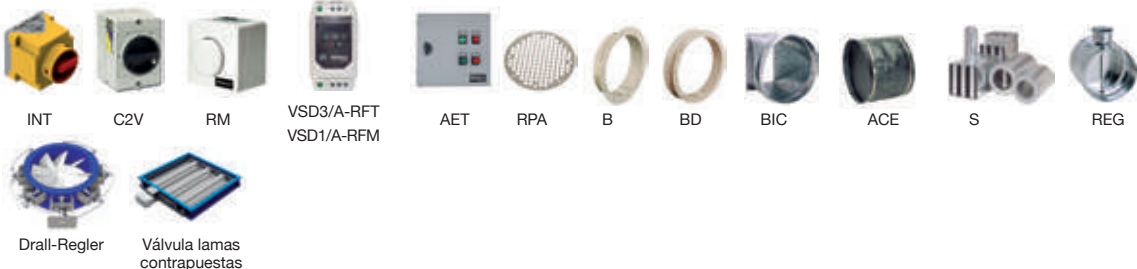

Curvas Características

Q= Caudal en m³/h, m³/s y cfm

Pe= Presión estática en mmH₂O, Pa e inwg

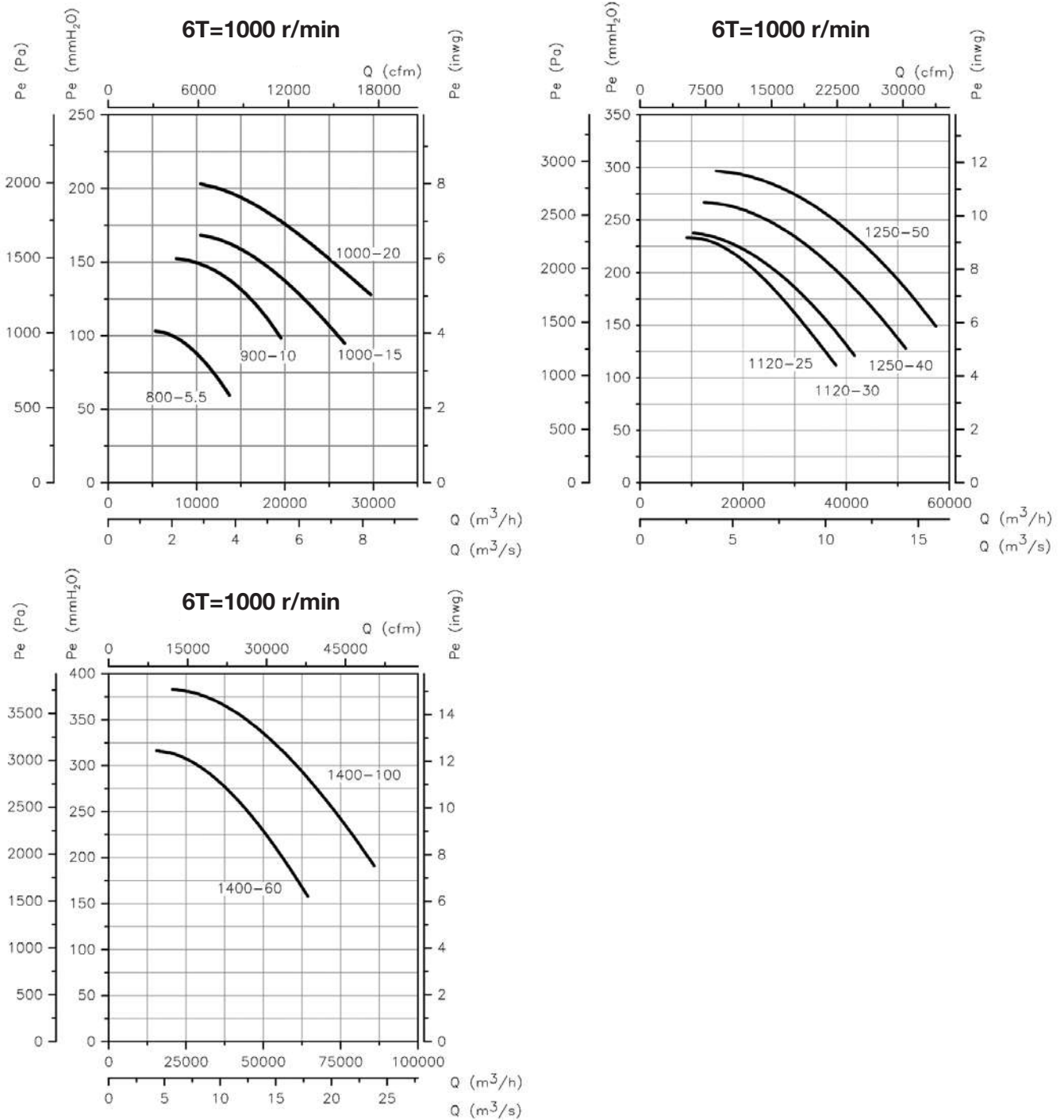

Orientaciones

Suministro estándar LG270, otras posiciones bajo demanda.
 Modelos del 350 al 630 orientables. Medidas especiales en posiciones 180 y 225.
 Modelos del 710 al 1400 no orientables. Medidas especiales excepto posición 315.

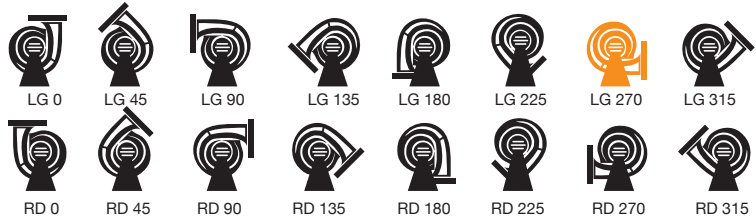

CASB-X



Ventiladores de media presión accionados a transmisión, equipados con motor eléctrico, conjunto de poleas, correas y protectores normalizados según norma ISO-13857



Ventilador:

- Envoltente en chapa de acero
- Turbina con álabes a reacción, en chapa de acero de gran robustez
- Motor montado sobre bancada general

Motor:

- Motores eficiencia IE3
- Motores clase F, con rodamientos a bolas, protección IP55
- Trifásicos 230/400V-50Hz (hasta 4kW) y 400/690V-50Hz (potencias superiores a 4kW)
- Temperatura máxima del aire a transportar: -25°C + 120°C

Bajo demanda:

- Bobinados especiales para diferentes tensiones
- Ventilador preparado para transportar aire hasta 250°C
- Ventilador en acero inoxidable
- Certificación ATEX Categoría 2
- Acoplamiento elástico sistema 8

Acabado:

- Anticorrosivo en resina de poliéster polimerizada a 190 °C, previo desengrase con tratamiento nanotecnológico libre de fosfatos.

Código de pedido

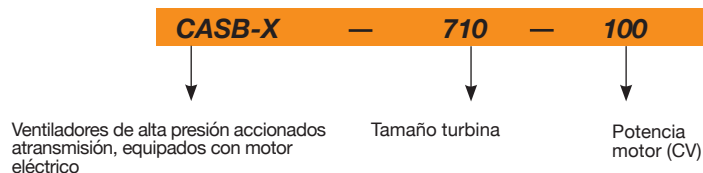

Características técnicas

Modelo	Velocidad (r/min)	Intensidad máx admisible (A)			Potencia instalada (kW)	Caudal máximo (m3/h)	Presión máxima (mm H ₂ O)	Peso (Kg)	According ErP
		230 V	400 V	690 V					
CASB-X-350-1 IE3	1995	2,82	1,62		0,75	2640	100	102	2015
CASB-X-350-1.5 IE3	2270	4,07	2,34		1,10	3000	130	112	2015
CASB-X-350-2 IE3	2520	5,48	3,15		1,50	3330	160	115	2015
CASB-X-350-3 IE3	2870	7,93	4,56		2,20	3790	210	124	2015
CASB-X-350-4 IE3	3045	10,70	6,15		3,00	4020	235	130	2015
CASB-X-350-5.5 IE3	3525	13,90	8,00		4,00	4660	315	141	2015
CASB-X-350-7.5 IE3	3935		10,30	5,97	5,50	5200	390	166	2015
CASB-X-350-10 IE3	4200		13,90	8,06	7,50	5550	445	175	2015
CASB-X-400-1.5 IE3	1915	4,07	2,34		1,10	3850	110	131	2015
CASB-X-400-2 IE3	2125	5,48	3,15		1,50	4280	135	134	2015
CASB-X-400-3 IE3	2420	7,93	4,56		2,20	4870	175	143	2015
CASB-X-400-4 IE3	2695	10,70	6,15		3,00	5420	220	149	2015
CASB-X-400-5.5 IE3	2970	13,90	8,00		4,00	5980	265	160	2015
CASB-X-400-7.5 IE3	3315		10,30	5,97	5,50	6670	330	185	2015
CASB-X-400-10 IE3	3675		13,90	8,06	7,50	7390	405	194	2015
CASB-X-400-15 IE3	3900		20,90	12,10	11,00	7840	460	234	2015
CASB-X-450-2 IE3	1720	5,48	3,15		1,50	5090	120	148	2015
CASB-X-450-3 IE3	1960	7,93	4,56		2,20	5800	155	157	2015
CASB-X-450-4 IE3	2180	10,70	6,15		3,00	6440	190	163	2015
CASB-X-450-5.5 IE3	2405	13,90	8,00		4,00	7110	230	174	2015
CASB-X-450-7.5 IE3	2685		10,30	5,97	5,50	7940	290	199	2015
CASB-X-450-10 IE3	2980		13,90	8,06	7,50	8800	355	208	2015
CASB-X-450-15 IE3	3385		20,90	12,10	11,00	10000	460	248	2015
CASB-X-450-20 IE3	3650		27,90	16,20	15,00	10790	535	270	2015
CASB-X-500-3 IE3	1640	7,93	4,56		2,20	6710	135	196	2015
CASB-X-500-4 IE3	1820	10,70	6,15		3,00	7460	165	202	2015
CASB-X-500-5.5 IE3	2010	13,90	8,00		4,00	8230	205	213	2015
CASB-X-500-7.5 IE3	2245		10,30	5,97	5,50	9190	255	238	2015
CASB-X-500-10 IE3	2325		13,90	8,06	7,50	9520	270	247	2015



Características técnicas

Modelo	Velocidad (r/min)	Intensidad máx admisible (A)			Potencia instalada (kW)	Caudal máximo (m3/h)	Presión máxima (mm H ₂ O)	Peso (Kg)	According ErP
		230 V	400 V	690 V					
CASB-X-500-15 IE3	2830		20,90	12,10	11,00	11580	400	287	2015
CASB-X-500-20 IE3	3135		27,90	16,20	15,00	12840	495	309	2015
CASB-X-500-25 IE3	3365		35,10	20,30	18,50	13770	570	347	2015
CASB-X-560-5.5 IE3	1675	13,90	8,00		4,00	9590	175	238	2015
CASB-X-560-7.5 IE3	1870		10,30	5,97	5,50	10700	220	263	2015
CASB-X-560-10 IE3	2075		13,90	8,06	7,50	11870	270	272	2015
CASB-X-560-15 IE3	2135		20,90	12,10	11,00	12210	285	312	2015
CASB-X-560-20 IE3	2610		27,90	16,20	15,00	14940	430	334	2015
CASB-X-560-25 IE3	2800		35,10	20,30	18,50	16040	495	372	2015
CASB-X-560-30 IE3	2970		41,00	23,80	22,00	16990	555	389	2015
CASB-X-560-40 IE3	3150		57,10	33,10	30,00	18040	625	432	2015
CASB-X-630-10 IE3	1685		13,90	8,06	7,50	13530	215	353	2015
CASB-X-630-15 IE3	1735		20,90	12,10	11,00	13920	230	393	2015
CASB-X-630-20 IE3	2125		27,90	16,20	15,00	17040	340	415	2015
CASB-X-630-25 IE3	2280		35,10	20,30	18,50	18290	395	453	2015
CASB-X-630-30 IE3	2415		41,00	23,80	22,00	19380	440	470	2015
CASB-X-630-40 IE3	2675		57,10	33,10	30,00	21480	540	513	2015
CASB-X-630-50 IE3	2870		66,80	38,70	37,00	23040	625	660	2015
CASB-X-630-60 IE3	2950		80,90	46,90	45,00	23680	660	695	2015
CASB-X-710-20 IE3	1690		27,90	16,20	15,00	19650	290	475	2015
CASB-X-710-25 IE3	1810		35,10	20,30	18,50	21050	335	513	2015
CASB-X-710-30 IE3	1910		41,00	23,80	22,00	22200	370	530	2015
CASB-X-710-40 IE3	2120		57,10	33,10	30,00	24650	460	573	2015
CASB-X-710-50 IE3	2280		66,80	38,70	37,00	26500	530	720	2015
CASB-X-710-60 IE3	2430		80,90	46,90	45,00	28250	605	755	2015
CASB-X-710-75 IE3	2600		98,60	57,20	55,00	30200	690	800	2015
CASB-X-710-100 IE3	2890		134,00	77,70	75,00	33600	850	995	2015
CASB-X-800-20 IE3	1380		27,90	16,20	15,00	23750	245	600	2015
CASB-X-800-25 IE3	1480		35,10	20,30	18,50	25450	280	638	2015
CASB-X-800-30 IE3	1570		41,00	23,80	22,00	27000	315	655	2015
CASB-X-800-40 IE3	1740		57,10	33,10	30,00	29900	390	698	2015
CASB-X-800-50 IE3	1850		66,80	38,70	37,00	31800	440	845	2015
CASB-X-800-60 IE3	1980		80,90	46,90	45,00	34050	505	880	2015
CASB-X-800-75 IE3	2120		98,60	57,20	55,00	36450	580	925	2015
CASB-X-800-100 IE3	2350		134,00	77,70	75,00	40400	710	1120	2015
CASB-X-900-30 IE3	1310		41,00	23,80	22,00	31450	275	770	2015
CASB-X-900-40 IE3	1460		57,10	33,10	30,00	35050	340	813	2015
CASB-X-900-50 IE3	1570		66,80	38,70	37,00	37700	395	960	2015
CASB-X-900-60 IE3	1670		80,90	46,90	45,00	40100	445	995	2015
CASB-X-900-75 IE3	1780		98,60	57,20	55,00	42750	510	1040	2015
CASB-X-900-100 IE3	1970		134,00	77,70	75,00	47300	620	1235	2015
CASB-X-900-125 IE3	2100		158,00	91,60	90,00	50400	705	1305	2015
CASB-X-900-150 IE3	2240		193,00	112,00	110,00	53750	805	1580	2015
CASB-X-1000-40 IE3	1210		57,10	33,10	30,00	39750	295	968	2015
CASB-X-1000-50 IE3	1300		66,80	38,70	37,00	42700	340	1115	2015
CASB-X-1000-60 IE3	1390		80,90	46,90	45,00	45650	390	1150	2015
CASB-X-1000-75 IE3	1480		98,60	57,20	55,00	48600	440	1195	2015
CASB-X-1000-100 IE3	1650		134,00	77,70	75,00	54200	550	1390	2015
CASB-X-1000-125 IE3	1750		158,00	91,60	90,00	57500	620	1460	2015
CASB-X-1000-150 IE3	1870		193,00	112,00	110,00	61450	705	1735	2015
CASB-X-1000-175 IE3	1980		231,00	134,00	132,00	65050	790	1795	2015
CASB-X-1120-50 IE3	1100		66,80	38,70	37,00	48050	305	1307	2015
CASB-X-1120-60 IE3	1190		80,90	46,90	45,00	52000	360	1342	2015
CASB-X-1120-75 IE3	1270		98,60	57,20	55,00	55500	410	1387	2015
CASB-X-1120-100 IE3	1400		134,00	77,70	75,00	61150	495	1582	2015
CASB-X-1120-125 IE3	1500		158,00	91,60	90,00	65500	570	1652	2015
CASB-X-1120-150 IE3	1600		193,00	112,00	110,00	69900	645	1927	2015
CASB-X-1120-175 IE3	1700		231,00	134,00	132,00	74250	730	1987	2015
CASB-X-1120-220 IE3	1800		280,00	162,00	160,00	78650	820	2057	2015
CASB-X-1250-60 IE3	980		80,90	46,90	45,00	63350	310	1625	2015

Características técnicas

Modelo	Velocidad (r/min)	Intensidad máx admisible (A)			Potencia instalada (kW)	Caudal máximo (m3/h)	Presión máxima (mm H ₂ O)	Peso (Kg)	According ErP
		230 V	400 V	690 V					
CASB-X-1250-75 IE3	1050		98,60	57,20	55,00	67900	355	1670	2015
CASB-X-1250-100 IE3	1160		134,00	77,70	75,00	75000	435	1865	2015
CASB-X-1250-125 IE3	1230		158,00	91,60	90,00	79550	485	1935	2015
CASB-X-1250-150 IE3	1320		193,00	112,00	110,00	85350	560	2210	2015
CASB-X-1250-175 IE3	1400		231,00	134,00	132,00	90550	630	2270	2015
CASB-X-1250-220 IE3	1500		280,00	162,00	160,00	97000	725	2340	2015
CASB-X-1250-270 IE3	1600		346,00	201,00	200,00	103450	825	2592	2015
CASB-X-1400-75 IE3	870		98,60	57,20	55,00	77450	300	2035	2015
CASB-X-1400-100 IE3	970		134,00	77,70	75,00	86350	370	2230	2015
CASB-X-1400-125 IE3	1030		158,00	91,60	90,00	91700	420	2300	2015
CASB-X-1400-150 IE3	1100		193,00	112,00	110,00	97900	480	2575	2015
CASB-X-1400-175 IE3	1170		231,00	134,00	132,00	104150	540	2635	2015
CASB-X-1400-220 IE3	1240		280,00	162,00	160,00	110350	610	2705	2015
CASB-X-1400-270 IE3	1340		346,00	201,00	200,00	119250	710	2957	2015
CASB-X-1600-100 IE3	760		134,00	77,70	75,00	100100	290	2625	2015
CASB-X-1600-125 IE3	810		158,00	91,60	90,00	106700	330	2695	2015
CASB-X-1600-150 IE3	870		193,00	112,00	110,00	114600	385	2970	2015
CASB-X-1600-175 IE3	920		231,00	134,00	132,00	121200	430	3030	2015
CASB-X-1600-220 IE3	980		280,00	162,00	160,00	129100	485	3100	2015
CASB-X-1600-270 IE3	1060		346,00	201,00	200,00	139650	570	3352	2015

Erp. Características del punto de máxima eficiencia (BEP)

MC	Categoría de medición	ηe[%]	Eficiencia
EC	Categoría de eficiencia	N	Grado de eficiencia
S	Estática	[kW]	Potencia eléctrica
T	Total	[m³/h]	Caudal
VSD	Variador de velocidad	[mmH₂O]	Presión estática o total (Según EC)
SR	Relación específica	[RPM]	Velocidad

Modelo	MC	EC	VSD	SR	ηe [%]	N	[kW]	[m3/h]	[mmH ₂ O]	[RPM]
CASB-X-350-1	C	S	NO	1,01	55,3%	67,1	0,747	1719	88,17	1995
CASB-X-350-1.5	C	S	NO	1,01	56,7%	66,8	1,074	1956	114,15	2270
CASB-X-350-2	C	S	NO	1,01	57,6%	66,4	1,446	2171	140,67	2520
CASB-X-350-3	C	S	NO	1,02	58,7%	65,8	2,096	2473	182,46	2870
CASB-X-350-4	C	S	NO	1,02	59,8%	66,2	2,454	2623	205,39	3045
CASB-X-350-5.5	C	S	NO	1,03	61,2%	65,7	3,725	3037	275,25	3525
CASB-X-350-7.5	C	S	NO	1,03	63,2%	66,3	5,016	3390	343,01	3935
CASB-X-350-10	C	S	NO	1,04	63,9%	66,2	6,033	3618	390,76	4200
CASB-X-400-1.5	C	S	NO	1,01	56,8%	67,0	1,072	2329	96,01	1915
CASB-X-400-2	C	S	NO	1,01	57,8%	66,6	1,441	2584	118,22	2125
CASB-X-400-3	C	S	NO	1,02	58,9%	66,0	2,089	2943	153,32	2420
CASB-X-400-4	C	S	NO	1,02	60,0%	65,8	2,828	3277	190,14	2695
CASB-X-400-5.5	C	S	NO	1,02	61,3%	65,9	3,704	3611	230,93	2970
CASB-X-400-7.5	C	S	NO	1,03	63,4%	66,5	4,986	4031	287,69	3315
CASB-X-400-10	C	S	NO	1,04	64,1%	65,9	6,720	4469	353,57	3675
CASB-X-400-15	C	S	NO	1,04	64,1%	65,1	8,031	4742	398,19	3900
CASB-X-450-2	C	S	NO	1,01	58,5%	67,1	1,514	3247	100,09	1720
CASB-X-450-3	C	S	NO	1,01	59,6%	66,5	2,198	3700	129,98	1960
CASB-X-450-4	C	S	NO	1,02	60,8%	66,3	2,966	4116	160,79	2180
CASB-X-450-5.5	C	S	NO	1,02	62,1%	66,4	3,897	4540	195,70	2405
CASB-X-450-7.5	C	S	NO	1,02	64,2%	67,1	5,249	5069	243,92	2685
CASB-X-450-10	C	S	NO	1,03	64,9%	66,5	7,098	5626	300,46	2980
CASB-X-450-15	C	S	NO	1,04	64,9%	64,9	10,403	6391	387,68	3385
CASB-X-450-20	C	S	NO	1,05	64,9%	64,7	13,043	6891	450,75	3650
CASB-X-500-3	C	S	NO	1,01	59,5%	66,5	2,171	4148	114,32	1640
CASB-X-500-4	C	S	NO	1,01	60,7%	66,3	2,909	4603	140,80	1820
CASB-X-500-5.5	C	S	NO	1,02	62,0%	66,4	3,835	5083	171,73	2010
CASB-X-500-7.5	C	S	NO	1,02	64,1%	67,1	5,173	5678	214,23	2245
CASB-X-500-10	C	S	NO	1,02	64,8%	67,4	5,683	5880	229,77	2325
CASB-X-500-15	C	S	NO	1,03	64,8%	64,8	10,249	7157	340,42	2830



Erp. Características del punto de máxima eficiencia (BEP)

Modelo	MC	EC	VSD	SR	η_e [%]	N	[kW]	[m ³ /h]	[mmH ₂ O]	[RPM]
CASB-X-500-20	C	S	NO	1,04	64,8%	64,5	13,933	7928	417,76	3135
CASB-X-500-25	C	S	NO	1,05	65,5%	65,0	17,045	8510	481,30	3365
CASB-X-560-5.5	C	S	NO	1,02	63,1%	67,6	3,760	5868	148,38	1675
CASB-X-560-7.5	C	S	NO	1,02	65,2%	68,3	5,065	6551	184,94	1870
CASB-X-560-10	C	S	NO	1,02	65,9%	67,6	6,845	7269	227,71	2075
CASB-X-560-15	C	S	NO	1,02	65,9%	67,2	7,456	7479	241,07	2135
CASB-X-560-20	C	S	NO	1,04	65,9%	65,6	13,623	9143	360,28	2610
CASB-X-560-25	C	S	NO	1,04	66,6%	66,1	16,639	9809	414,64	2800
CASB-X-560-30	C	S	NO	1,05	66,6%	65,9	19,857	10405	466,52	2970
CASB-X-560-40	C	S	NO	1,05	67,3%	66,5	23,438	11035	524,78	3150
CASB-X-630-10	C	S	NO	1,02	63,2%	65,2	6,428	8020	185,98	1685
CASB-X-630-15	C	S	NO	1,02	63,2%	64,8	7,017	8258	197,18	1735
CASB-X-630-20	C	S	NO	1,03	63,2%	63,0	12,893	10114	295,79	2125
CASB-X-630-25	C	S	NO	1,03	63,9%	63,5	15,753	10852	340,51	2280
CASB-X-630-30	C	S	NO	1,04	63,9%	63,3	18,721	11494	382,03	2415
CASB-X-630-40	C	S	NO	1,05	64,6%	63,7	25,171	12732	468,72	2675
CASB-X-630-50	C	S	NO	1,05	64,6%	63,4	31,086	13660	539,55	2870
CASB-X-630-60	C	S	NO	1,06	64,6%	63,3	33,759	14041	570,04	2950
CASB-X-710-20	C	S	NO	1,02	66,1%	65,9	12,909	13131	238,65	1690
CASB-X-710-25	C	S	NO	1,03	66,5%	66,1	15,773	14063	273,75	1810
CASB-X-710-30	C	S	NO	1,03	66,8%	66,2	18,455	14840	304,83	1910
CASB-X-710-40	C	S	NO	1,04	67,2%	66,2	25,101	16471	375,55	2120
CASB-X-710-50	C	S	NO	1,04	67,7%	66,6	30,960	17715	434,38	2280
CASB-X-710-60	C	S	NO	1,05	67,7%	66,3	37,521	18880	493,41	2430
CASB-X-710-75	C	S	NO	1,06	67,9%	66,3	45,814	20201	564,86	2600
CASB-X-710-100	C	S	NO	1,07	68,2%	66,3	62,588	22454	697,90	2890
CASB-X-800-20	C	S	NO	1,02	65,1%	65,1	11,024	11773	223,84	1380
CASB-X-800-25	C	S	NO	1,03	65,5%	65,2	13,525	12626	257,46	1480
CASB-X-800-30	C	S	NO	1,03	65,8%	65,3	16,076	13394	289,72	1570
CASB-X-800-40	C	S	NO	1,04	66,1%	65,3	21,767	14844	355,86	1740
CASB-X-800-50	C	S	NO	1,04	66,7%	65,7	25,940	15782	402,28	1850
CASB-X-800-60	C	S	NO	1,05	66,6%	65,4	31,835	16891	460,80	1980
CASB-X-800-75	C	S	NO	1,05	66,8%	65,4	38,953	18086	528,27	2120
CASB-X-800-100	C	S	NO	1,07	67,2%	65,4	52,778	20048	649,11	2350
CASB-X-900-30	C	S	NO	1,02	67,3%	66,7	17,961	18194	243,65	1310
CASB-X-900-40	C	S	NO	1,03	67,6%	66,7	24,732	20278	302,64	1460
CASB-X-900-50	C	S	NO	1,04	68,2%	67,0	30,493	21805	349,96	1570
CASB-X-900-60	C	S	NO	1,04	68,1%	66,8	36,738	23194	395,96	1670
CASB-X-900-75	C	S	NO	1,05	68,3%	66,8	44,345	24722	449,85	1780
CASB-X-900-100	C	S	NO	1,06	68,7%	66,8	59,799	27361	551,01	1970
CASB-X-900-125	C	S	NO	1,06	68,8%	66,7	72,284	29166	626,13	2100
CASB-X-900-150	C	S	NO	1,07	69,0%	66,7	87,543	31111	712,39	2240
CASB-X-1000-40	C	S	NO	1,03	69,0%	68,1	24,903	25981	242,66	1210
CASB-X-1000-50	C	S	NO	1,03	69,6%	68,4	30,621	27913	280,10	1300
CASB-X-1000-60	C	S	NO	1,03	69,5%	68,1	37,471	29846	320,22	1390
CASB-X-1000-75	C	S	NO	1,04	69,7%	68,1	45,088	31778	363,03	1480
CASB-X-1000-100	C	S	NO	1,05	70,1%	68,1	62,150	35428	451,22	1650
CASB-X-1000-125	C	S	NO	1,05	70,2%	68,1	73,993	37576	507,57	1750
CASB-X-1000-150	C	S	NO	1,06	70,4%	68,0	90,094	40152	579,57	1870
CASB-X-1000-175	C	S	NO	1,07	70,5%	68,0	106,723	42514	649,76	1980
CASB-X-1120-50	C	S	NO	1,03	68,8%	67,6	31,573	31864	250,09	1100
CASB-X-1120-60	C	S	NO	1,03	68,7%	67,2	40,017	34471	292,68	1190
CASB-X-1120-75	C	S	NO	1,03	68,9%	67,3	48,488	36788	333,36	1270
CASB-X-1120-100	C	S	NO	1,04	69,3%	67,3	64,613	40554	405,10	1400
CASB-X-1120-125	C	S	NO	1,05	69,4%	67,2	79,304	43451	465,03	1500
CASB-X-1120-150	C	S	NO	1,05	69,6%	67,2	96,045	46347	529,11	1600
CASB-X-1120-175	C	S	NO	1,06	69,7%	67,1	114,962	49244	597,31	1700
CASB-X-1120-220	C	S	NO	1,07	69,9%	67,1	136,181	52141	669,65	1800
CASB-X-1250-60	C	S	NO	1,03	70,2%	68,8	38,238	36762	267,86	980
CASB-X-1250-75	C	S	NO	1,03	70,4%	68,8	46,882	39388	307,49	1050



Erp. Características del punto de máxima eficiencia (BEP)

Modelo	MC	EC	VSD	SR	η_e [%]	N	[kW]	[m ³ /h]	[mmH ₂ O]	[RPM]
CASB-X-1250-100	C	S	NO	1,04	70,8%	68,8	62,882	43515	375,29	1160
CASB-X-1250-125	C	S	NO	1,04	70,9%	68,8	74,810	46140	421,95	1230
CASB-X-1250-150	C	S	NO	1,05	71,1%	68,7	92,269	49517	485,96	1320
CASB-X-1250-175	C	S	NO	1,06	71,2%	68,6	109,853	52518	546,65	1400
CASB-X-1250-220	C	S	NO	1,06	71,4%	68,6	134,833	56269	627,54	1500
CASB-X-1250-270	C	S	NO	1,07	71,4%	68,4	163,637	60020	714,00	1600
CASB-X-1400-75	C	S	NO	1,03	72,0%	70,3	47,212	51206	243,57	870
CASB-X-1400-100	C	S	NO	1,03	72,4%	70,4	65,092	57092	302,78	970
CASB-X-1400-125	C	S	NO	1,04	72,5%	70,3	77,770	60623	341,40	1030
CASB-X-1400-150	C	S	NO	1,04	72,7%	70,3	94,530	64743	389,38	1100
CASB-X-1400-175	C	S	NO	1,05	72,8%	70,2	113,512	68863	440,51	1170
CASB-X-1400-220	C	S	NO	1,05	73,0%	70,2	134,847	72983	494,80	1240
CASB-X-1400-270	C	S	NO	1,06	73,0%	69,9	170,174	78869	577,82	1340
CASB-X-1600-100	C	S	NO	1,03	72,8%	70,9	55,377	56107	263,55	760
CASB-X-1600-125	C	S	NO	1,03	72,9%	70,9	66,901	59798	299,37	810
CASB-X-1600-150	C	S	NO	1,03	73,1%	70,8	82,723	64227	345,36	870
CASB-X-1600-175	C	S	NO	1,04	73,2%	70,8	97,617	67919	386,20	920
CASB-X-1600-220	C	S	NO	1,04	73,4%	70,7	117,743	72348	438,22	980
CASB-X-1600-270	C	S	NO	1,05	73,4%	70,5	148,996	78254	512,69	1060

Dimensiones mm

CASB-X-350...500

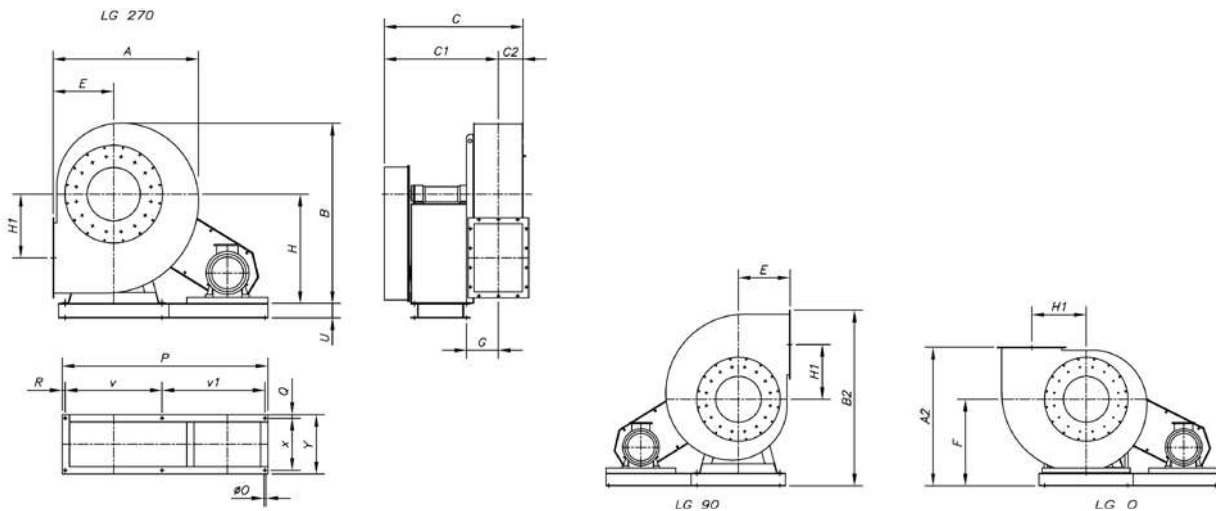

Modelo	A	A2	B	B2	C	C1	C2	E	F	G	H	H1	P	øO	U	v	v1	x	R	Q	Y
CASB-X-350	600	885	740	1067	783	668	115	255	630	157	450	253	810	14	180	355	410	407	22,5	28	463
CASB-X-400	655	965	815	1167	820	693	127	285	680	168	500	286	810	15	180	355	410	407	22,5	28	463
CASB-X-450	735	1060	915	1281,5	847	706	141	320	740	181	560	321	810	15	180	355	410	407	22,5	28	463
CASB-X-500	832	1140	1000	1377	985	828	157	360	780	198	600	355	850	18	180	364	432	477	27	33	543

Dimensiones mm

CASB-X-560...630

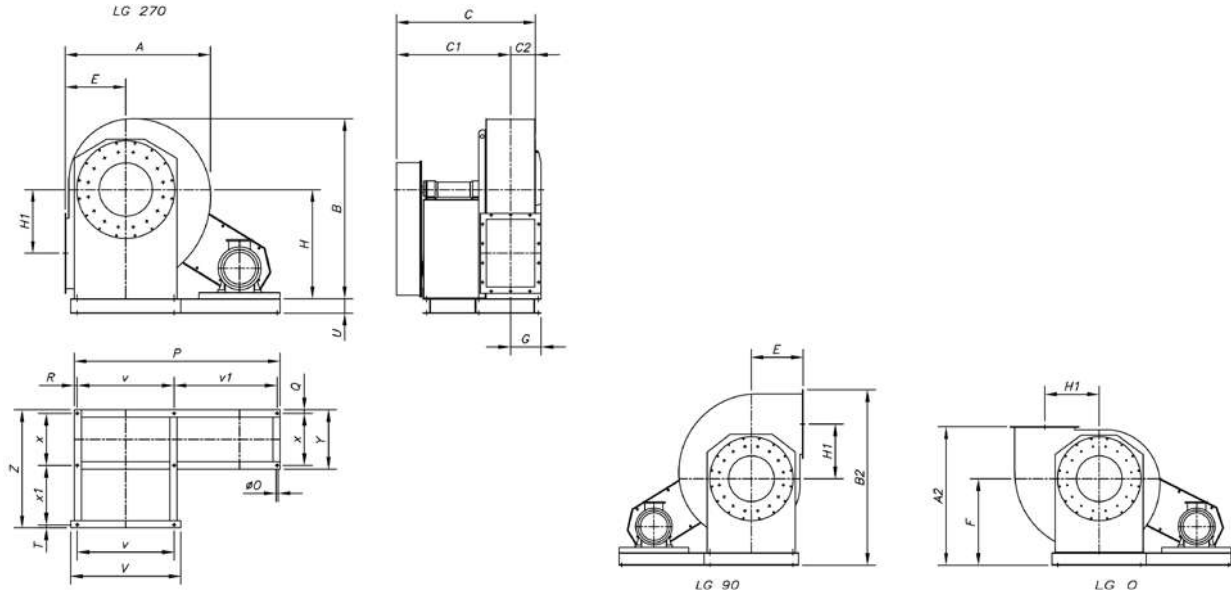

Modelo	A	A2	B	B2	C	C1	C2	E	F	G	H	H1	P	øO	U	V	v	v1	x	x1	R	Q	Y	T	Z
CASB-X-560	940	1250	1126	1506,5	1058	881	177	400	850	214	670	390	1170	18	180	692	632	478	477	410	30	33	543	23	943
CASB-X-630	1052	1380	1260	1662,5	1102	907	195	450	930	234	750	439	1270	18	180	762	702	508	477	450	30	33	543	23	983

CASB-X-710...1600

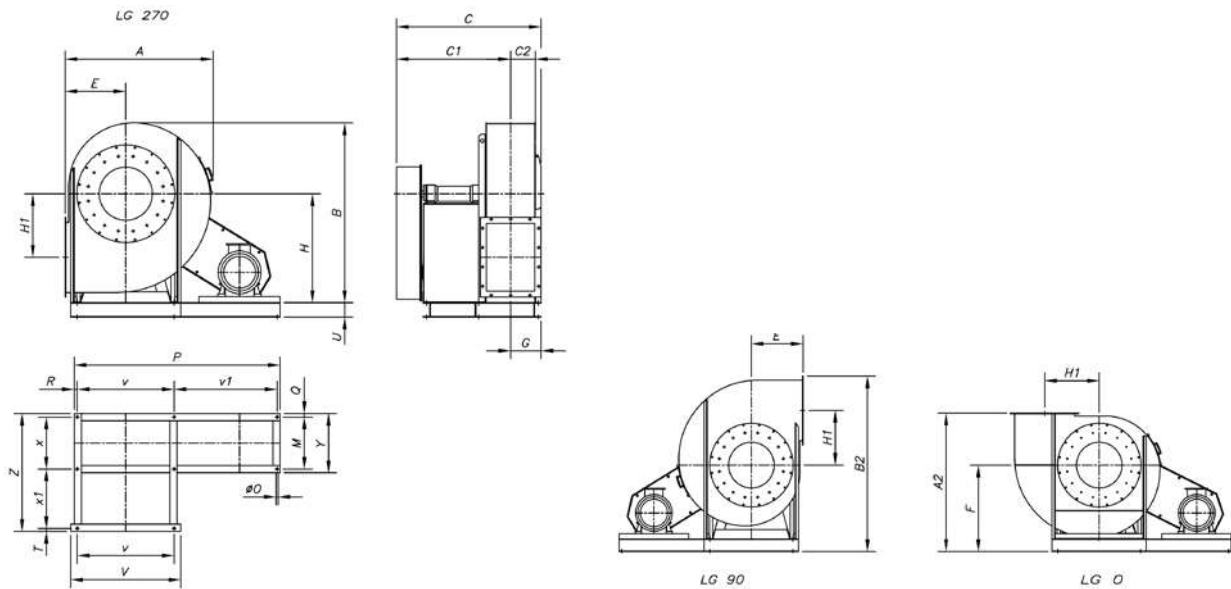

Modelo	A	A2	B	B2	C	C1	C2	E	F	G	H	H1	P	øO	U	V	v	v1	x	x1	R	Q	Y	M	T	Z
CASB-X-710	1189	1350	1416	1684,5	1241	979	216	500	850	262	850	500	1433	20	180	914	772	607	551	497	27	39	629	551	27	1114
CASB-X-800	1340	1515	1591	1884	1306	1000	241	560	955	306	950	560	1568	20	180	1044	862	642	551	546	32	39	629	551	47	1183
CASB-X-900	1500	1660	1780	2067,5	1360	1026	275	630	1030	334	1060	630	1813	20	180	1144	962	787	551	600	32	39	629	551	47	1237
CASB-X-1000	1685	1840	1993	2300,5	1565	1180	308	710	1130	385	1180	710	1964	20	180	1254	1056	836	607	657	36	45	697	607	67	1376
CASB-X-1120	1884	2100	2222	2609	1780	1361	350	800	1300	419	1320	800	2134	25	220	1400	1178	866	760	763	45	45	850	760	55	1623
CASB-X-1250	2075	2260	2505	2823,5	1895	1438	385	900	1360	457	1500	900	2600	24	180	1540	1310	1220	760	840	35	35	830	760	32	1667
CASB-X-1400	2305	2500	2815	2935	2060	1560	430	1000	1500	500	1700	1000	3150	24	180	1690	1450	1630	780	946	35	35	990	920	33	1794
CASB-X-1600	2655	2800	3145	3253,5	2350	1781	480	1120	1680	569	1900	1120	3340	28	180	1950	1640	1630	920	1073	35	35	990	920	35	2063

Dimensiones mm

Boca de impulsión y aspiración

Boca de aspiración

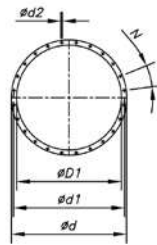

Boca de impulsión

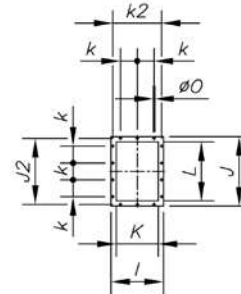

Boca de impulsión

- CASB-X-450
- CASB-X-1000
- CASB-X-900
- CASB-X-1250
- CASB-X-1400
- CASB-X-1600
- CASB-X-400
- CASB-X-800
- CASB-X-1120
- CASB-X-350
- CASB-X-710
- CASB-X-630
- CASB-X-560
- CASB-X-500

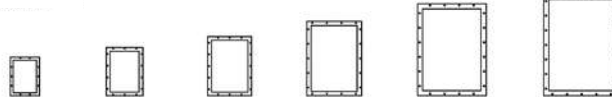

Modelo	$\varnothing D1^*$	$\varnothing d$	$\varnothing d1$	$\varnothing d2$	N	I	J	J2	K	k	k2	L	$\varnothing O$
CASB-X-350	285	365	332	12	8x45°	285	368	332	205	125	249	288	12
CASB-X-400	320	400	366	12	8x45°	309	402	366	229	125	273	322	12
CASB-X-450	360	440	405	12	8x45°	336	441	405	256	125	300	361	12
CASB-X-500	405	485	448	12	12x30°	368	484	448	288	125	332	404	12
CASB-X-560	455	535	497	12	12x30°	402	533	497	322	125	366	453	12
CASB-X-630	505	585	551	13	12x30°	441	587	551	361	125	405	507	12
CASB-X-710	565	665	629	13	12x30°	504	669	629	404	160	464	569	14
CASB-X-800	635	735	698	13	12x30°	553	738	698	453	160	513	638	14
CASB-X-900	715	815	775	15	16x22°30'	607	815	775	507	160	567	715	14
CASB-X-1000	805	905	861	15	16x22°30'	689	921	871	569	200	639	801	14
CASB-X-1120	905	1005	958	15	16x22°30'	758	1018	968	638	200	708	898	14
CASB-X-1250	1008	1108	1067	10	24x15°	835	1127	1077	715	200	785	1007	14
CASB-X-1400	1130	1250	1200	10	24x15°	941	1270	1210	801	200	881	1130	18
CASB-X-1600	1260	1380	1337	10	24x15°	1038	1407	1347	898	200	978	1267	18

* Diámetro nominal tubería recomendada

Orientaciones

Suministro standard LG 270

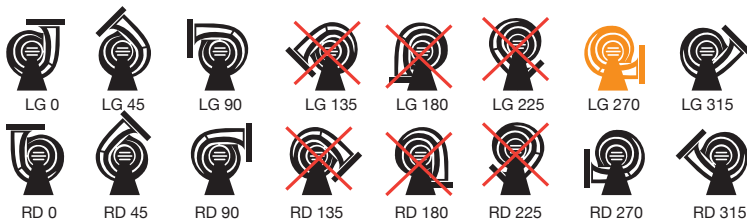

Accesorios

Ver apartado accesorios.

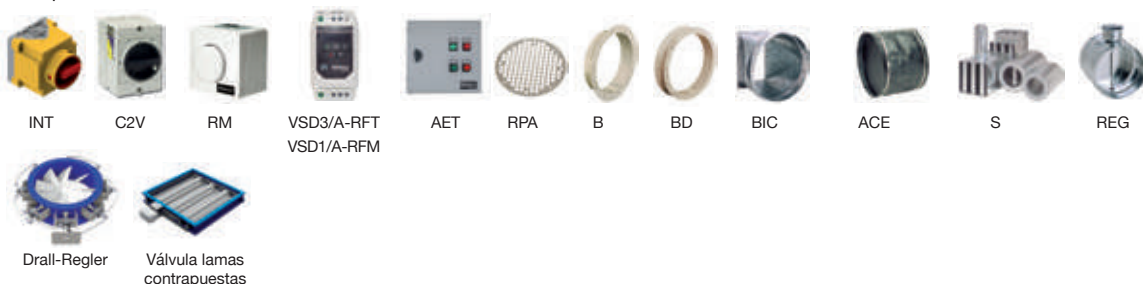

Curvas Características

Q= Caudal en m³/h, m³/s y cfm

Pe= Presión estática en mmH₂O, Pa e in wg

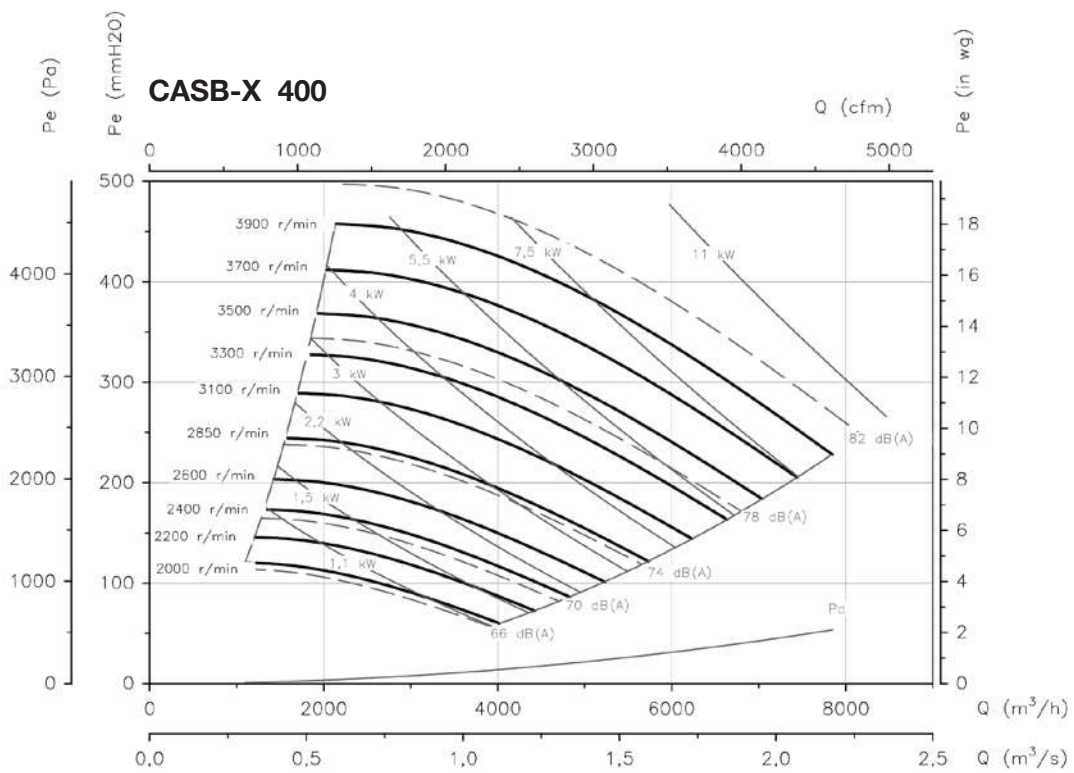
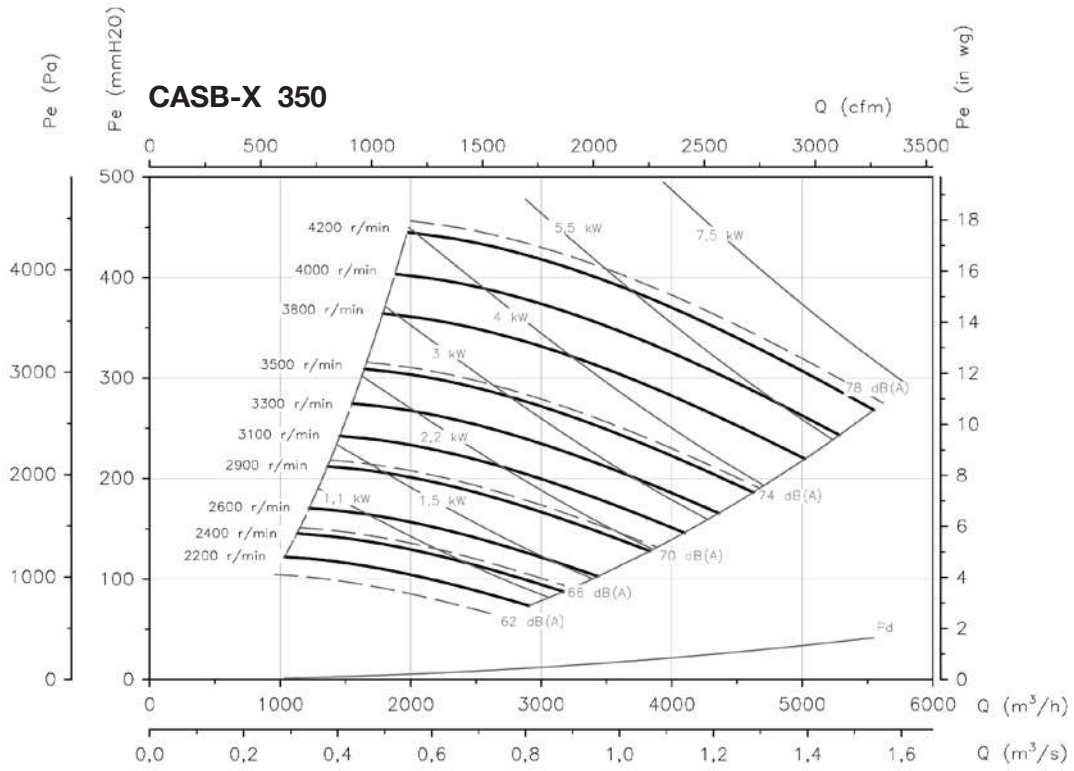

Curvas Características

Q= Caudal en m³/h, m³/s y cfm

Pe= Presión estática en mmH₂O, Pa e inwg

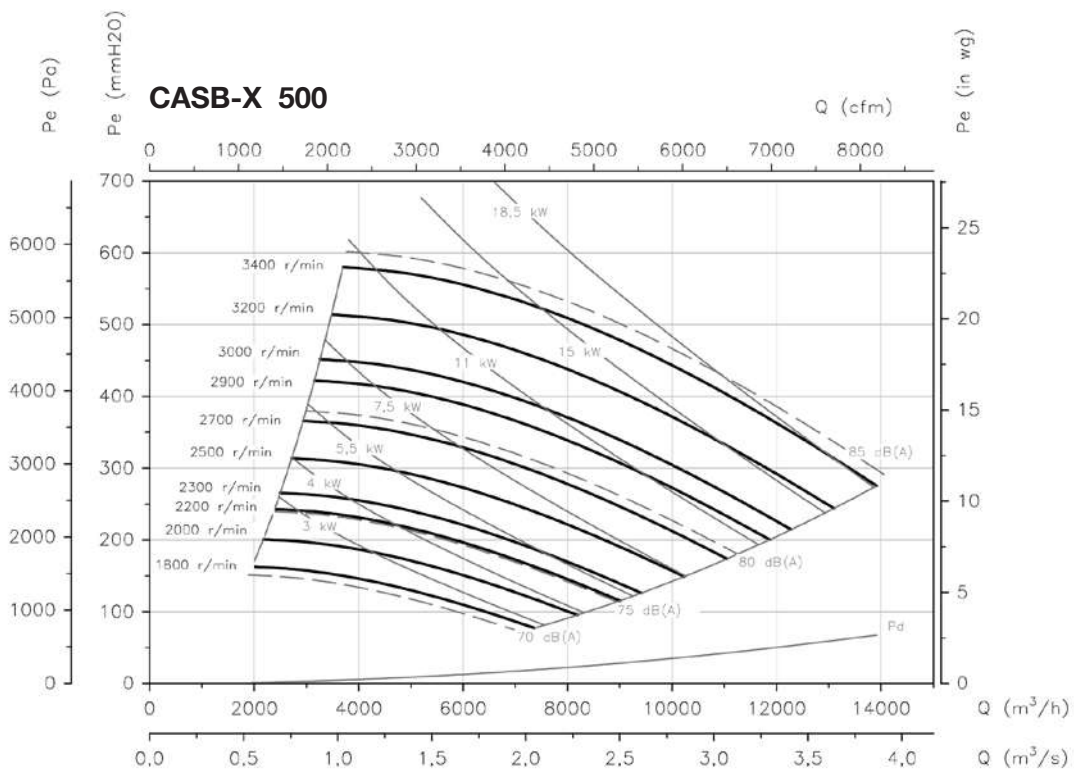
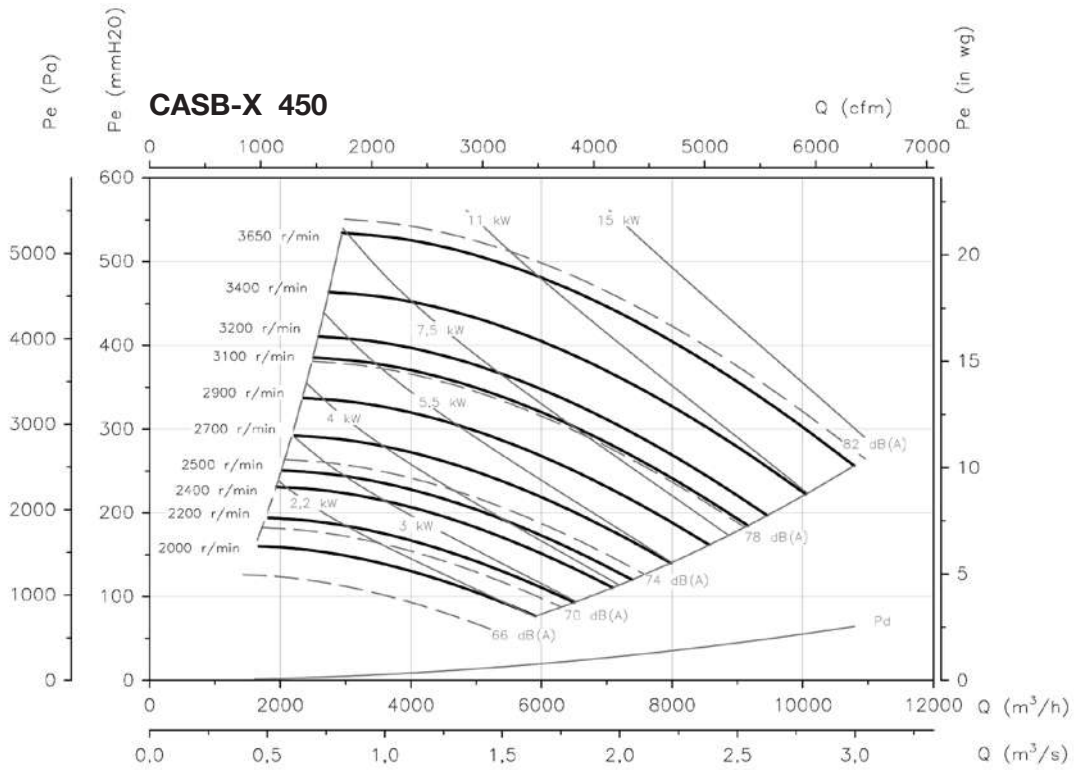

Curvas Características

Q= Caudal en m³/h, m³/s y cfm

Pe= Presión estática en mmH₂O, Pa e in wg

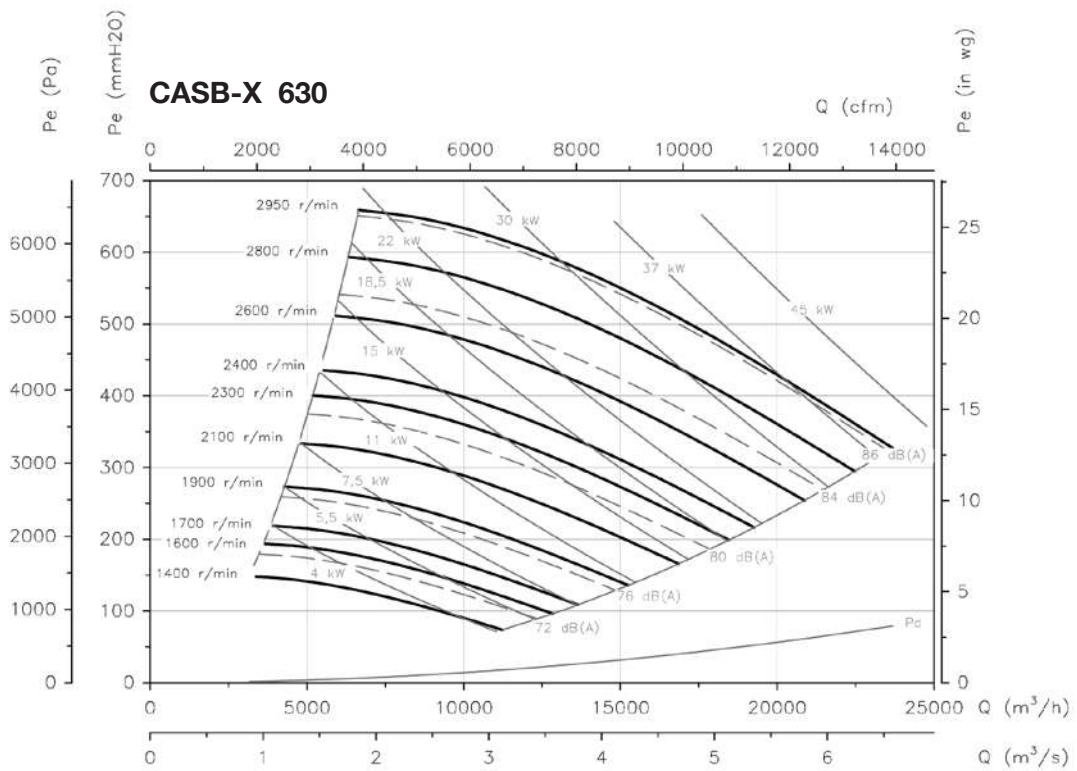
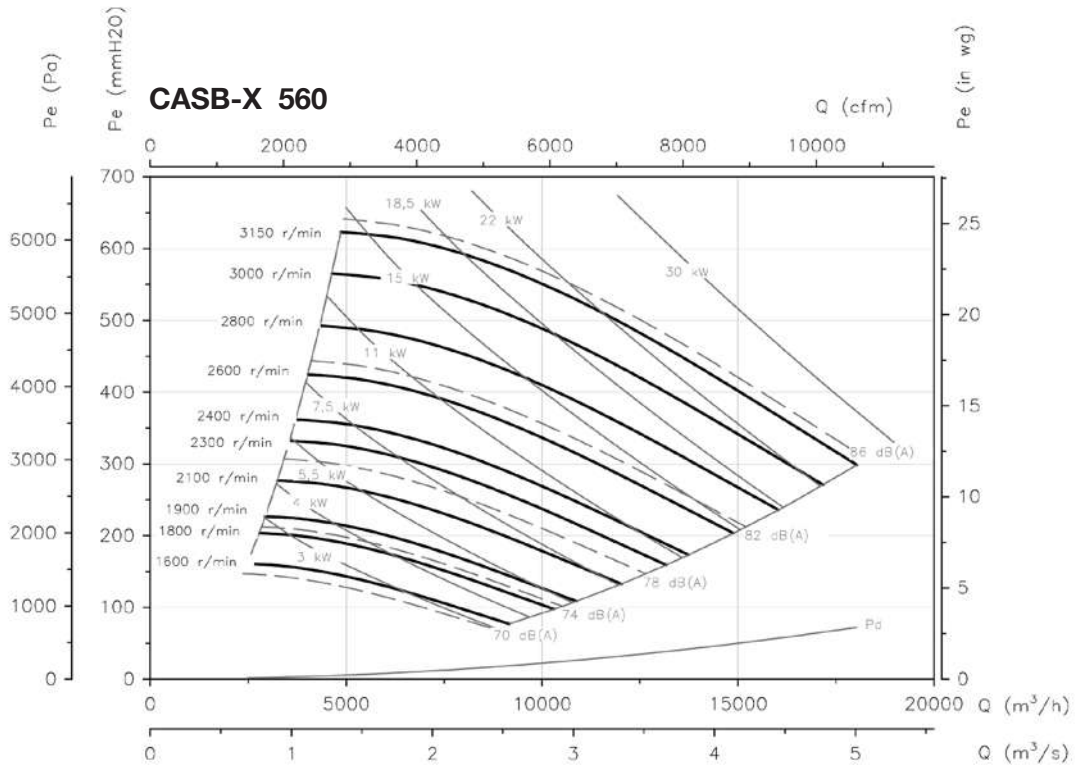

Curvas Características

Q= Caudal en m³/h, m³/s y cfm

Pe= Presión estática en mmH₂O, Pa e inwg

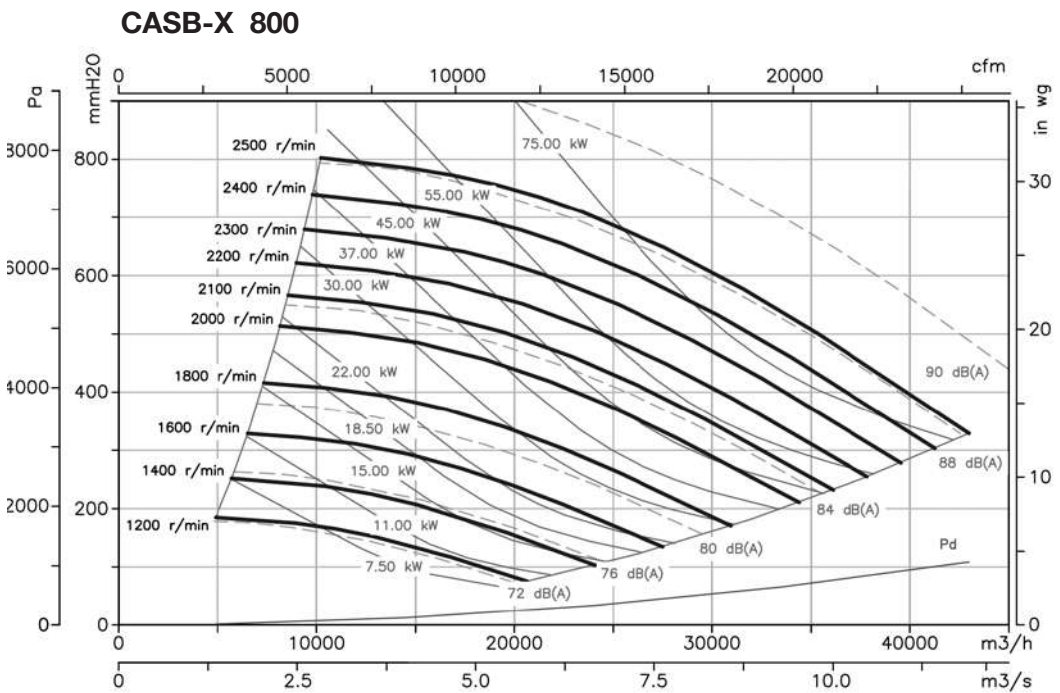
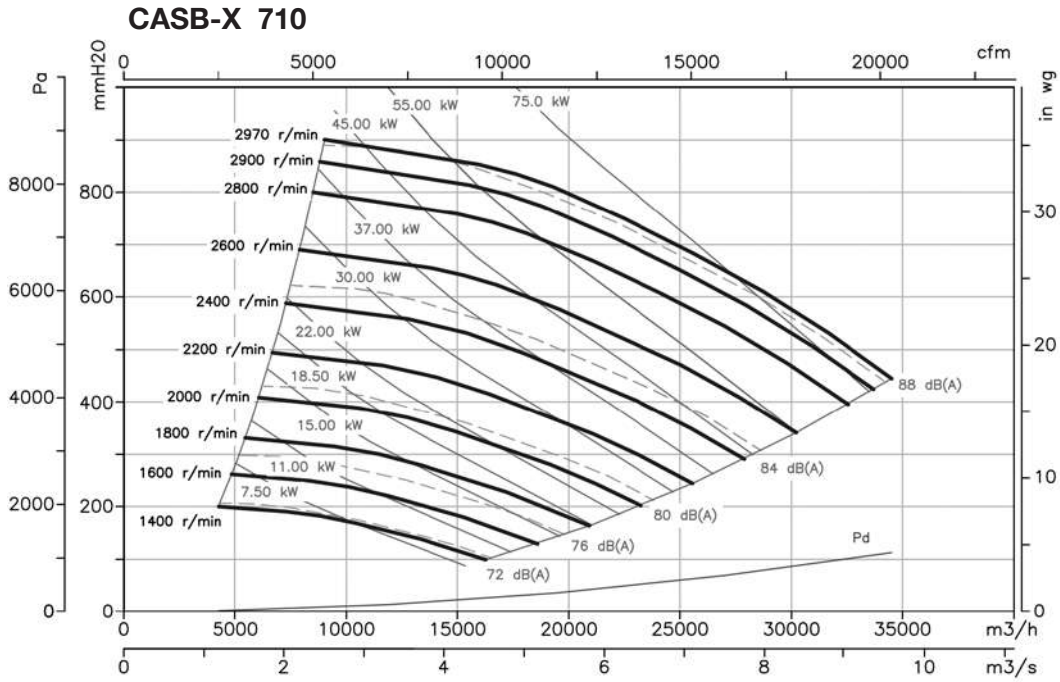



Curvas Características

Q= Caudal en m³/h, m³/s y cfm

Pe= Presión estática en mmH₂O, Pa e in wg

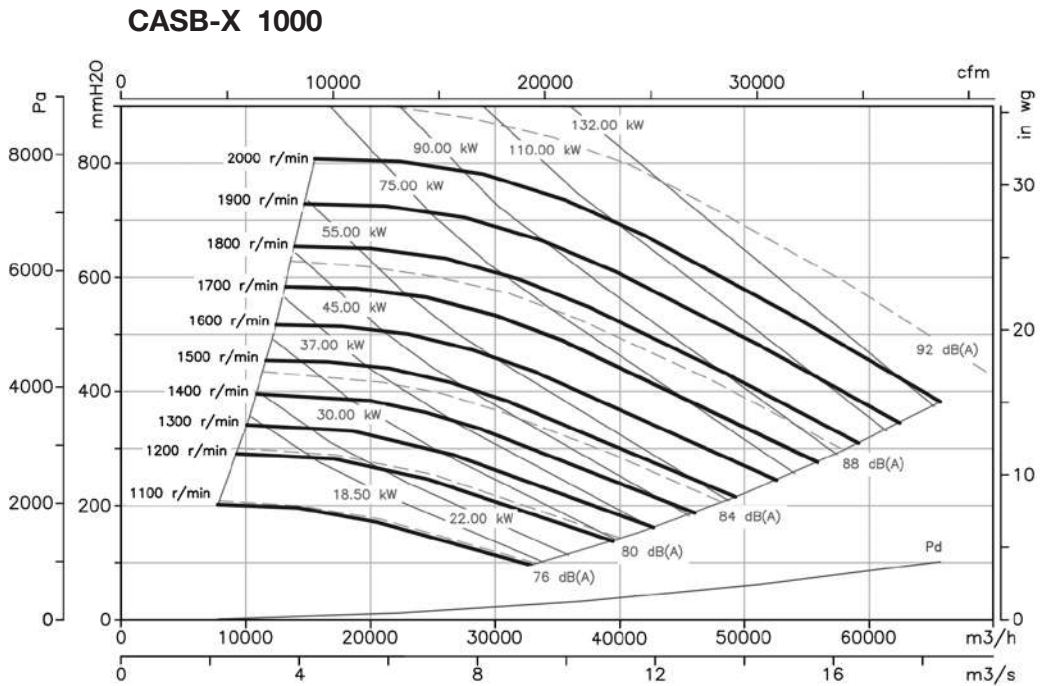
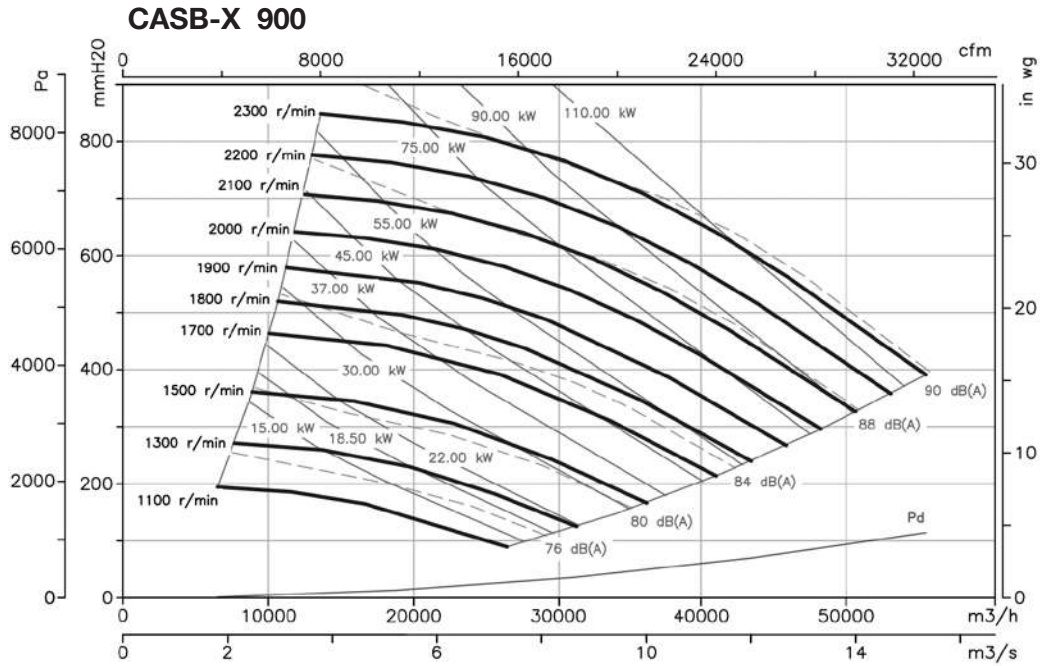

Curvas Características

Q= Caudal en m³/h, m³/s y cfm

Pe= Presión estática en mmH₂O, Pa e in wg

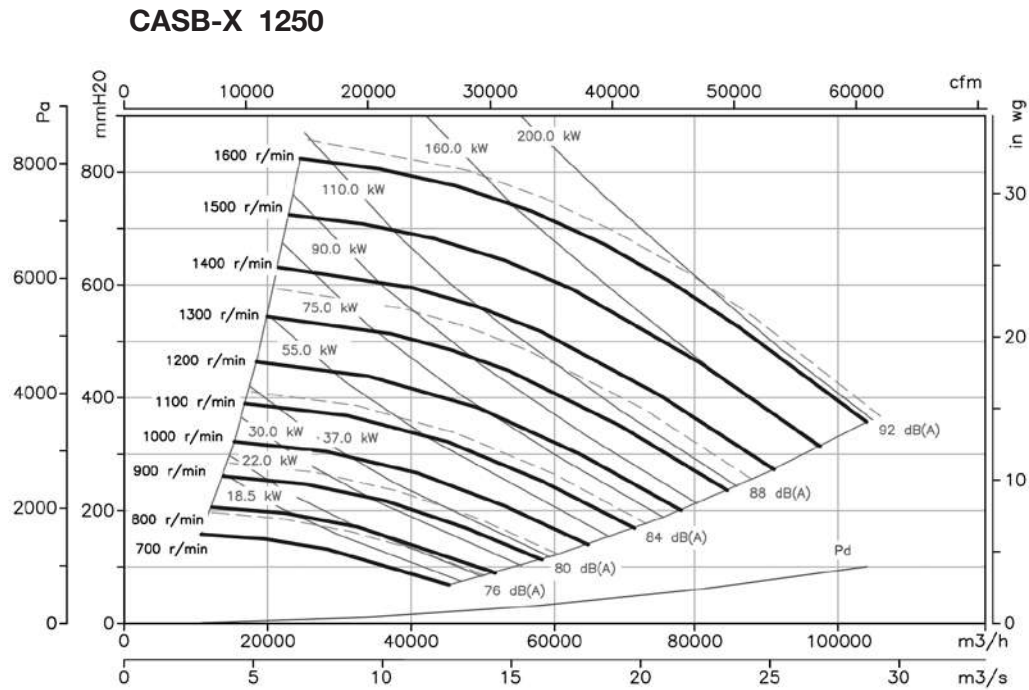
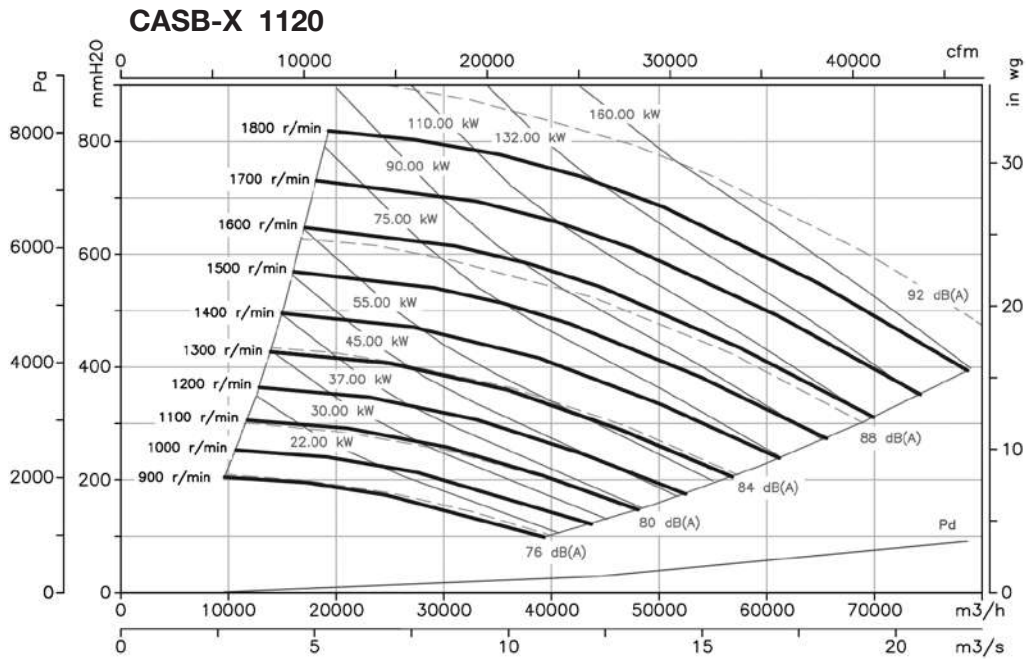



Curvas Características

Q= Caudal en m³/h, m³/s y cfm
 Pe= Presión estática en mmH₂O, Pa e in wg

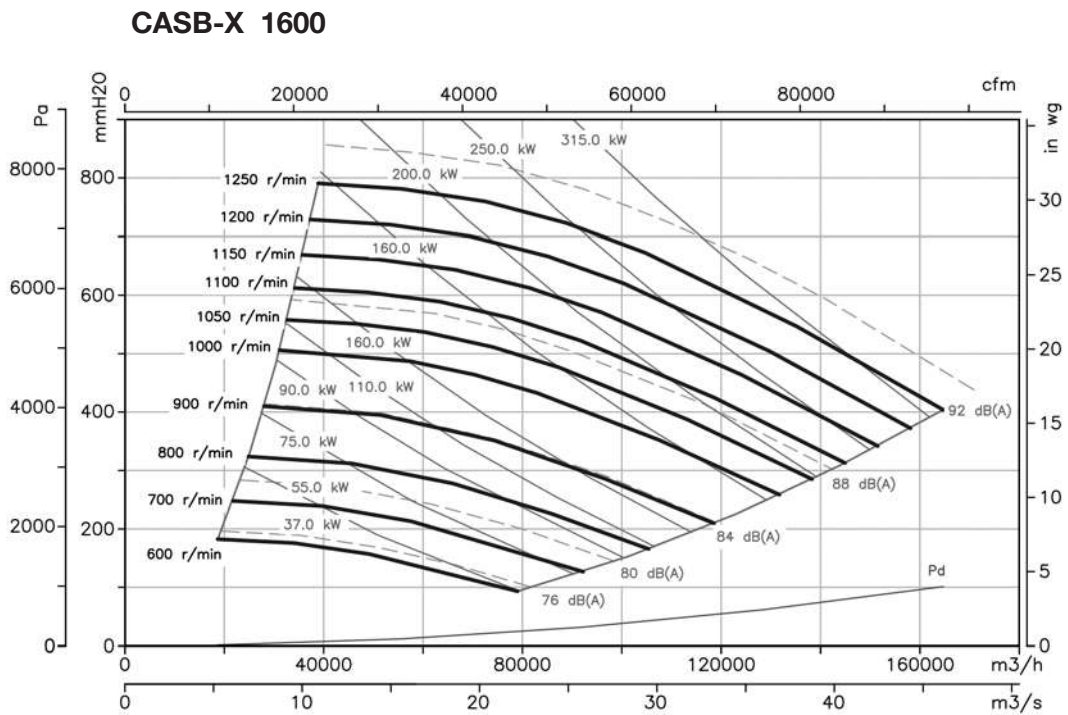
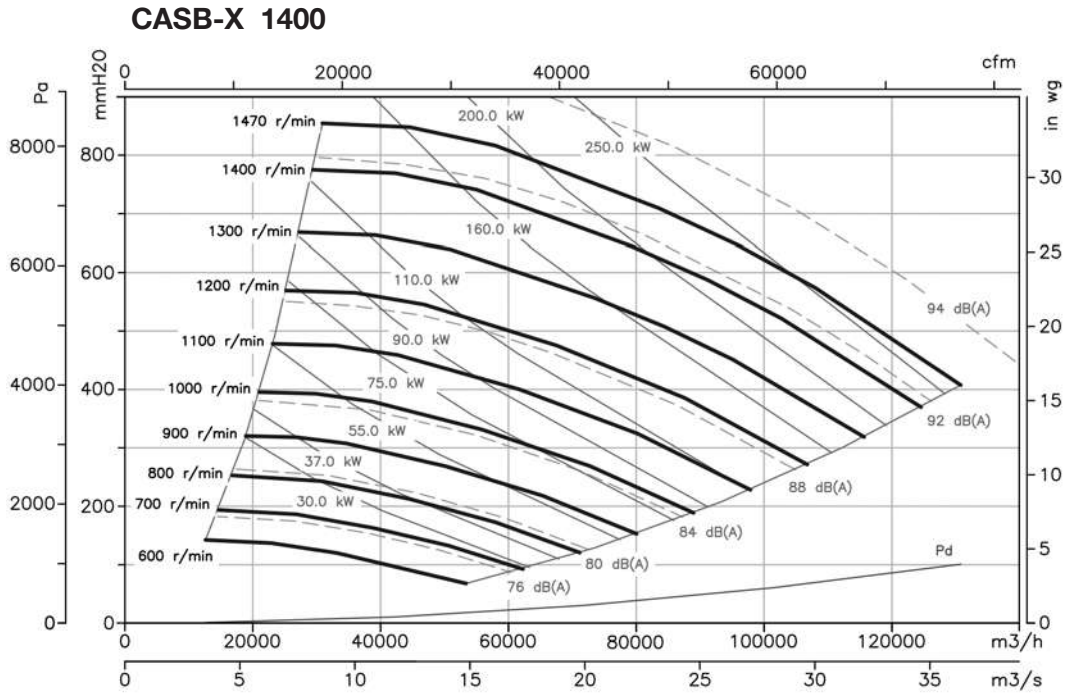

CAB



Ventiladores centrífugos de alta presión y simple aspiración de gran robustez, con envoltente y turbina en chapa de acero



Ventilador:

- Envoltente en chapa de acero
- Turbina con álabes hacia atrás, en chapa de acero de gran robustez, especialmente diseñada para transportar aire limpio y aire polvoriento o ligeramente granulado
- Motor directamente acoplado

Motor:

- Motores de eficiencia IE3 para potencias iguales o superiores a 7,5kW, excepto monofásicos, 2 velocidades y 8 polos
- Motores clase F, con rodamientos a bolas, protección IP55
- Trifásicos 230/400V-50Hz (hasta 4kW) y 400/690V-50Hz (potencias superiores a 4kW)
- Temperatura máxima del aire a transportar: -20°C + 120°C

Acabado:

- Anticorrosivo en resina de poliéster polimerizada a 190 °C, previo desengrase con tratamiento nanotecnológico libre de fosfatos.

Bajo demanda:

- Bobinados especiales para diferentes tensiones
- Ventilador preparado para transportar aire hasta 250°C
- Ventilador en acero inoxidable
- Certificación ATEX Categoría 2
- Motores de eficiencias IE2 e IE3 para cualquier potencia
- Acoplamiento elástico sistema 8

Código de pedido

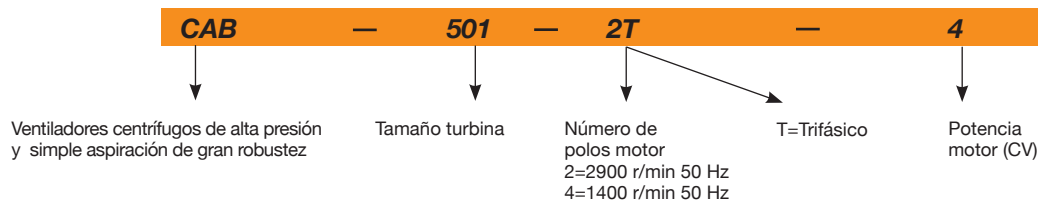

Características técnicas

Modelo	Velocidad (r/min)	Intensidad máx admisible (A)			Potencia instalada (kW)	Caudal máximo (m³/h)	Nivel Presión Sonora dB(A)	Peso aprox (Kg)	According ErP
		230 V	400 V	690 V					
CAB-501-2T-4	2880	10,30	5,92		3,00	1800	79	81	2015
CAB-501-2T-5.5	2880	13,30	7,63		4,00	2905	80	93	2015
CAB-561-2T-7.5	2910		10,60	6,14	5,50	2415	84	146	2015
CAB-561-2T-10 IE3	2930		14,10	8,17	7,50	4210	85	143	2015
CAB-562-2T-7.5	2910		10,60	6,14	5,50	3355	84	144	2015
CAB-631-2T-15 IE3	2945		19,60	11,40	11,00	5025	87	211	2015
CAB-632-2T-10 IE3	2930		14,10	8,17	7,50	3045	86	175	2015
CAB-632-2T-15 IE3	2945		19,60	11,40	11,00	6055	87	201	2015
CAB-712-2T-20 IE3	2945		27,70	16,10	15,00	5050	89	272	2015
CAB-712-2T-25 IE3	2945		33,90	19,70	18,50	6715	89	285	2015
CAB-711-2T-25 IE3	2945		33,90	19,70	18,50	5005	88	333	2015
CAB-711-2T-30 IE3	2950		39,70	23,00	22,00	7075	90	413	2015
CAB-801-2T-40 IE3	2960		54,50	31,60	30,00	7300	91	467	2015
CAB-801-2T-50 IE3	2960		67,80	39,30	37,00	9775	91	467	2015

Características técnicas

Modelo	Velocidad (r/min)	Intensidad máx admisible (A)			Potencia instalada (kW)	Caudal máximo (m³/h)	Nivel Presión Sonora dB(A)	Peso aprox (Kg)	According ErP
		230 V	400 V	690 V					
CAB-801-2T-60 IE3	2960	77,50	44,90	45,00	13150	91	603	2015	
CAB-802-2T-40 IE3	2960	54,50	31,60	30,00	8220	91	437	2015	
CAB-802-2T-50 IE3	2960	67,80	39,30	37,00	11190	92	462	2015	
CAB-901-2T-75 IE3	2960	95,60	55,40	55,00	10430	94	713	2015	
CAB-901-2T-100 IE3	2965	128,00	74,20	75,00	14935	93	808	2015	
CAB-901-4T-10 IE3	1460	13,90	8,06	7,50	6000	80	317	2015	
CAB-902-2T-60 IE3	2960	77,50	44,90	45,00	9500	93	640	2015	
CAB-902-2T-75 IE3	2960	95,60	55,40	55,00	12550	93	703	2015	
CAB-902-2T-100 IE3	2965	128,00	74,20	75,00	16785	92	798	2015	



Erp. Características del punto de máxima eficiencia (BEP)

MC	Categoría de medición	ηe[%]	Eficiencia
EC	Categoría de eficiencia	N	Grado de eficiencia
S	Estática	[kW]	Potencia eléctrica
T	Total	[m³/h]	Caudal
VSD	Variador de velocidad	[mmH₂O]	Presión estática o total (Según EC)
SR	Relación específica	[RPM]	Velocidad

Modelo	MC	EC	VSD	SR	ηe [%]	N	[kW]	[m3/h]	[mmH₂O]	[RPM]
CAB-501-2T-4	B	T	NO	1,05	67,5%	72,3	3,546	1800	488,31	2880
CAB-501-2T-5.5	B	T	NO	1,05	69,7%	74,1	3,859	2098	470,78	2900
CAB-561-2T-7.5	B	T	NO	1,06	69,0%	71,1	6,322	2416	662,40	2910
CAB-561-2T-10 IE3	B	T	NO	1,06	72,4%	74,3	6,636	2690	655,57	2944
CAB-562-2T-7.5	B	T	NO	1,05	72,8%	75,0	6,138	3354	489,06	2913
CAB-631-2T-15 IE3	B	T	NO	1,08	80,3%	80,3	11,275	4259	780,60	2948
CAB-632-2T-10 IE3	B	T	NO	1,07	75,7%	76,5	8,260	3044	753,31	2930
CAB-632-2T-15 IE3	B	T	NO	1,07	79,3%	79,4	10,118	4227	696,77	2954
CAB-712-2T-20 IE3	B	T	NO	1,10	76,0%	75,3	20,916	5908	987,94	2942
CAB-712-2T-25 IE3	B	T	NO	1,10	76,4%	75,6	21,506	5964	1010,57	2955
CAB-711-2T-25 IE3	B	T	NO	1,09	76,2%	75,7	16,268	5047	901,35	2945
CAB-711-2T-30 IE3	B	T	NO	1,08	78,9%	78,2	19,093	6714	822,92	2947
CAB-801-2T-40 IE3	-	-	-	1,12	-	-	32,848	7569	1242,33	2959
CAB-801-2T-50 IE3	-	-	-	1,12	-	-	33,678	7640	1265,95	2966
CAB-801-2T-60 IE3	-	-	-	1,13	-	-	34,601	7722	1292,44	2971
CAB-802-2T-40 IE3	-	-	-	1,12	-	-	13,819	3314	1223,88	2983
CAB-802-2T-50 IE3	-	-	-	1,12	-	-	13,991	3331	1236,54	2986
CAB-901-2T-75 IE3	-	-	-	1,16	-	-	61,994	11509	1606,22	2957
CAB-901-2T-100 IE3	-	-	-	1,16	-	-	64,313	11674	1651,43	2972
CAB-901-4T-10 IE3	B	T	NO	1,04	74,4%	75,8	7,282	5293	375,52	1465
CAB-902-2T-60 IE3	-	-	-	1,14	-	-	51,086	10595	1438,25	2957
CAB-902-2T-75 IE3	-	-	-	1,14	-	-	52,812	10712	1470,68	2964
CAB-902-2T-100 IE3	-	-	-	1,15	-	-	54,036	10813	1498,56	2976

Dimensiones mm

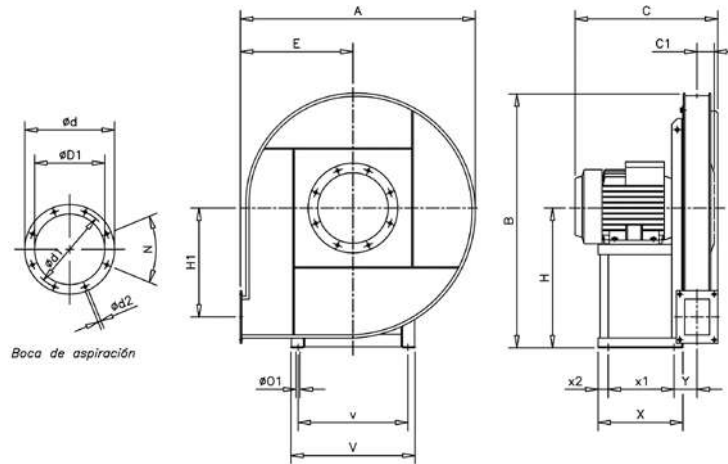

	A	B	C	C1	E	H	H1	ØD1	V	v	X	x1	x2	Y	ØD1	Ød	Ød1	Ød2	N
CAB-501-2T-4	735	800	500	77	355	450	310	12	332	300	260	200	25	104	205	275	241	11,5	8x45°
CAB-501-2T-5.5	735	800	500	77	355	450	310	12	332	300	260	200	25	104	205	275	241	11,5	8x45°
CAB-561-2T-7.5	830	895	595	87	400	500	350	12	392	360	320	250	25	122	229	299	265	11,5	8x45°
CAB-561-2T-10	830	895	595	87	400	500	350	12	392	360	320	250	25	122	229	299	265	11,5	8x45°
CAB-562-2T-7.5	830	895	595	87	400	500	350	12	392	360	320	250	25	122	229	299	265	11,5	8x45°
CAB-631-2T-15	900	990	750	100	425	560	388	14	440	400	425	340	30	142	255	325	292	11,5	8x45°
CAB-632-2T-10	900	990	610	100	425	560	388	14	440	400	425	340	30	142	255	325	292	11,5	8x45°
CAB-632-2T-15	900	990	750	100	425	560	388	14	440	400	425	340	30	142	255	325	292	11,5	8x45°
CAB-711-2T-25	1005	1115	780	110	475	630	435	14	440	400	425	340	30	152	286	366	332	11,5	8x45°
CAB-711-2T-30	1005	1115	780	110	475	630	435	14	440	400	425	340	30	152	286	366	332	11,5	8x45°
CAB-712-2T-20	1005	1115	780	110	475	630	435	14	440	400	425	340	30	152	286	366	332	11,5	8x45°
CAB-712-2T-25	1005	1115	780	110	475	630	435	14	440	400	425	340	30	152	286	366	332	11,5	8x45°
CAB-801-2T-40	1120	1250	875	120	530	710	490	16	570	510	500	385	40	183	321	401	366	11,5	8x45°
CAB-801-2T-50	1120	1250	875	120	530	710	490	16	570	510	500	385	40	183	321	401	366	11,5	8x45°
CAB-801-2T-60	1120	1250	875	120	530	710	490	16	570	510	500	385	40	183	321	401	366	11,5	8x45°
CAB-802-2T-40	1120	1250	875	120	530	710	490	16	570	510	500	385	40	183	321	401	366	11,5	8x45°
CAB-802-2T-50	1120	1250	875	120	530	710	490	16	570	510	500	385	40	183	321	401	366	11,5	8x45°
CAB-901-2T-75	1265	1410	990	135	600	800	552	21	686	615	600	460	45	217	361	486	405	11,5	8x45°
CAB-901-2T-100	1265	1410	1120	135	600	800	552	21	760	690	700	550	50	222	361	486	405	11,5	8x45°
CAB-901-4T-10	1265	1410	700	135	600	800	552	12	392	360	320	250	25	167	361	486	405	11,5	8x45°
CAB-902-2T-60	1265	1410	980	135	600	800	552	19	626	565	550	425	40	207	361	486	405	11,5	8x45°
CAB-902-2T-75	1265	1410	990	135	600	800	552	21	698	615	600	550	45	217	361	486	405	11,5	8x45°
CAB-902-2T-100	1265	1410	1120	135	600	800	552	21	760	680	700	550	50	222	361	486	405	11,5	8x45°

Dimensiones mm

Boca impulsión

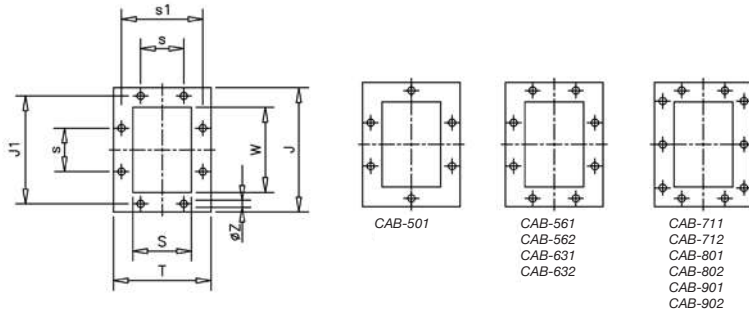

	T	J	J1	S	s	s1	W	ØZ
CAB-501-2T-4	195	250	219	125	112	167	180	11,5
CAB-501-2T-5.5	195	250	219	125	112	167	180	11,5
CAB-561-2T-7.5	210	270	241	140	112	182	200	11,5
CAB-561-2T-10	210	270	241	140	112	182	200	11,5
CAB-562-2T-7.5	210	270	241	140	112	182	200	11,5
CAB-631-2T-15	230	294	265	160	112	200	224	11,5
CAB-632-2T-10	230	294	265	160	112	200	224	11,5
CAB-632-2T-15	230	294	265	160	112	200	224	11,5
CAB-711-2T-25	250	320	292	180	112	219	250	11,5
CAB-711-2T-30	250	320	292	180	112	219	250	11,5
CAB-712-2T-20	250	320	292	180	112	219	250	11,5
CAB-712-2T-25	250	320	292	180	112	219	250	11,5
CAB-801-2T-40	280	360	332	200	125	249	280	11,5
CAB-801-2T-50	280	360	332	200	125	249	280	11,5
CAB-801-2T-60	280	360	332	200	125	249	280	11,5
CAB-802-2T-40	280	360	332	200	125	249	280	11,5
CAB-802-2T-50	280	360	332	200	125	249	280	11,5
CAB-901-2T-75	304	395	366	224	125	273	315	11,5
CAB-901-2T-100	304	395	366	224	125	273	315	11,5
CAB-901-4T-10	304	395	366	224	125	273	315	11,5
CAB-902-2T-60	304	395	366	224	125	273	315	11,5
CAB-902-2T-75	304	395	366	224	125	273	315	11,5
CAB-902-2T-100	304	395	366	224	125	273	315	11,5

Curvas Características

Q= Caudal en m³/h, m³/s y cfm

Pe= Presión estática en mmH₂O, Pa e inwg

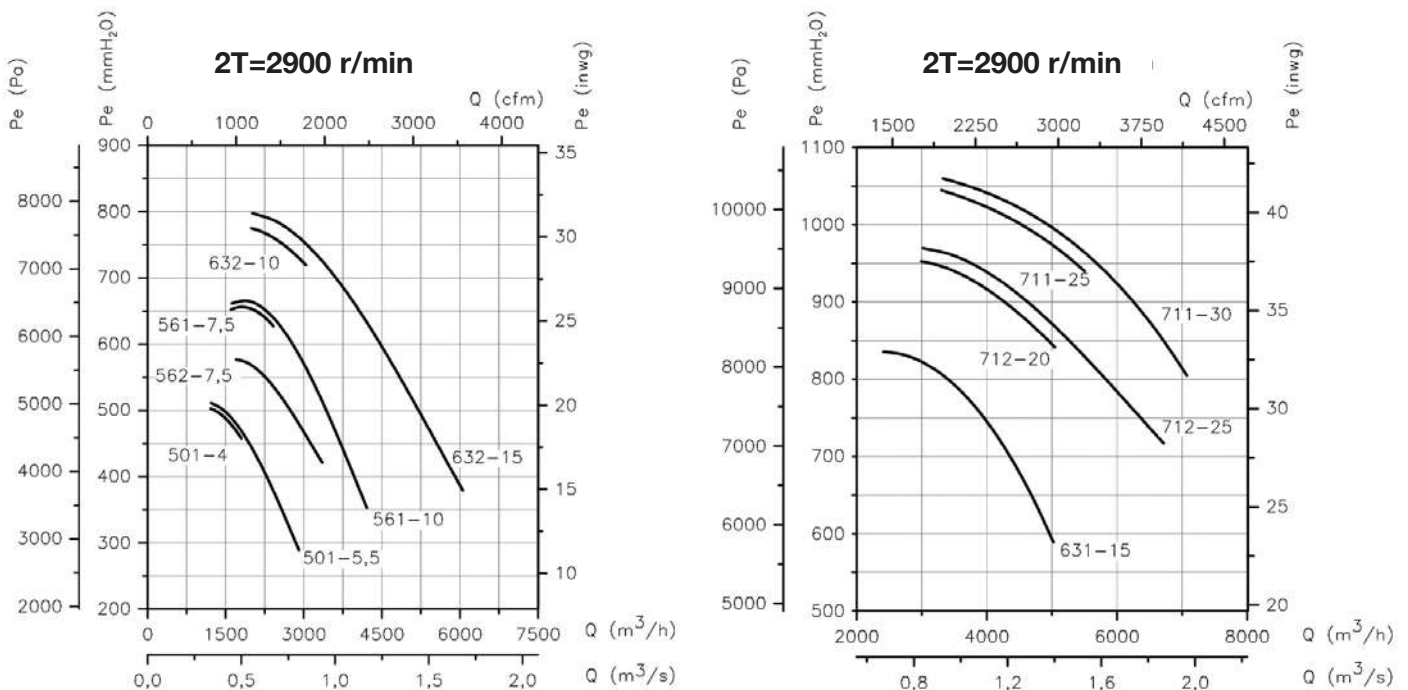

Curvas Características

Q= Caudal en m³/h, m³/s y cfm

Pe= Presión estática en mmH₂O, Pa e inwg

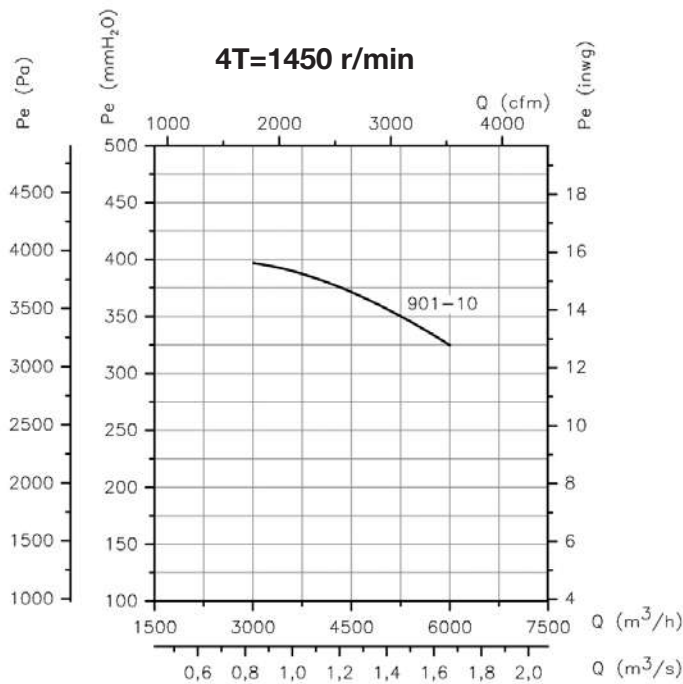
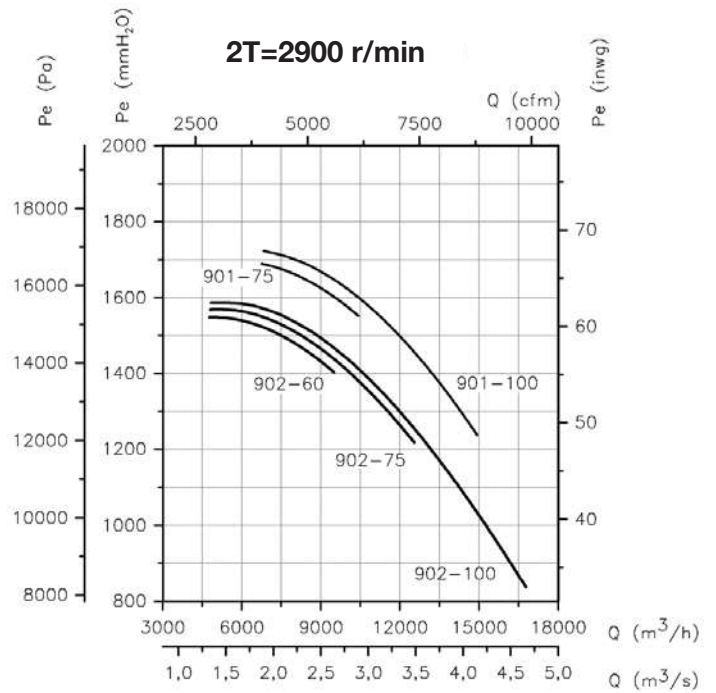
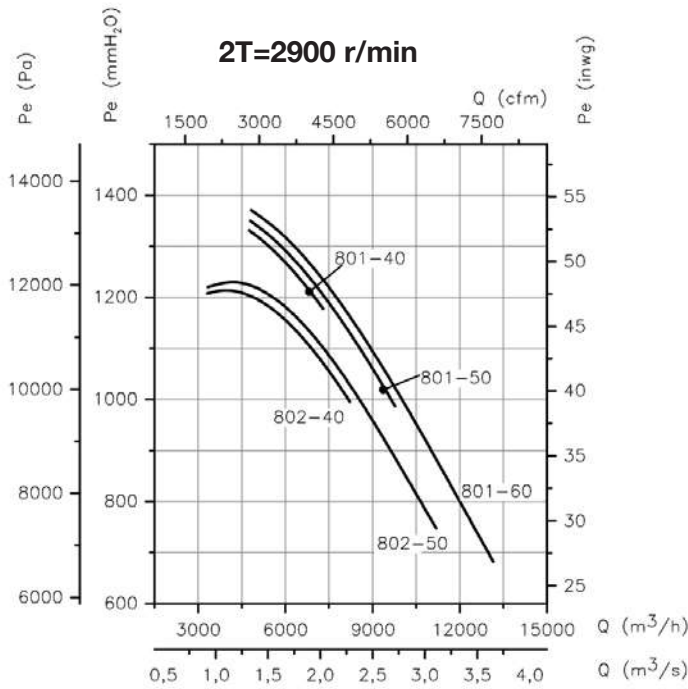

Orientaciones

Suministro estándar LG270, otras posiciones bajo demanda.
Modelos del 501 al 802 orientables. Medidas especiales en posiciones 180 y 225.
Modelos 901 y 902 orientables. Medidas especiales excepto posición 315.

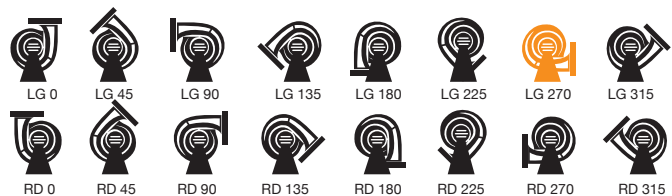

CAST



Ventiladores centrífugos de alta presión y simple aspiración con envolvente y turbina de pala recta en chapa de acero, para transporte de polvo y material sólido



Ventilador:

- Envolvente en chapa de acero
- Turbina de pala recta en chapa de acero

Motor:

- Motores de eficiencia IE3 para potencias iguales o superiores a 0,75kW, excepto monofásicos, 2 velocidades y 8 polos
- Motores clase F, con rodamientos a bolas, protección IP55
- Trifásicos 230/400V-50Hz (hasta 4kW) y 400/690V-50Hz (potencias superiores a 4kW)
- Temperatura máxima del aire a transportar: -25°C + 120°C

Acabado:

- Anticorrosivo en resina de poliéster polimerizada a 190 °C, previo desengrase con tratamiento nanotecnológico libre de fosfatos

Bajo demanda:

- Bobinados especiales para diferentes tensiones
- Ventilador preparado para transportar aire hasta 250°C
- Certificación ATEX Categoría 2
- Acoplamiento elástico sistema 8

Código de pedido

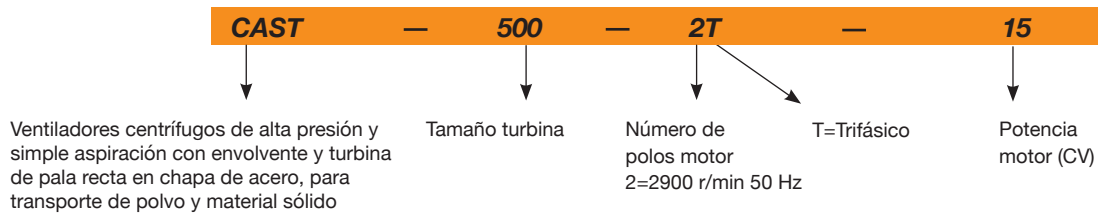

Características técnicas

Modelo	Velocidad (r/min)	Intensidad máxima admisible (A)			Potencia instalada (kW)	Caudal máximo (m³/h)	Nivel presión sonora dB(A)	Peso aprox. (Kg)
		230V	400V	690V				
CAST-400-2T-3 IE3	2870	7,70	4,43		2,20	1330	80	45
CAST-450-2T-4 IE3	2910	10,00	5,77		3,00	1330	82	60
CAST-450-2T-5.5 IE3	2900	13,00	7,50		4,00	1910	83	65
CAST-500-2T-7.5 IE3	2930		10,10	5,86	5,50	2440	85	97
CAST-500-2T-10 IE3	2935		13,90	8,06	7,50	3470	85	103
CAST-560-2T-10 IE3	2935		13,90	8,06	7,50	2690	89	135
CAST-560-2T-15 IE3	2945		20,00	11,60	11,00	4360	90	158
CAST-630-2T-20 IE3	2945		27,70	16,10	15,00	3830	93	193
CAST-630-2T-25 IE3	2945		33,90	19,70	18,50	5510	93	203
CAST-710-2T-30 IE3	2950		39,70	23,00	22,00	4790	96	253
CAST-710-2T-40 IE3	2960		54,50	31,60	30,00	6970	96	365
CAST-710-2T-50 IE3	2960		67,80	39,30	37,00	8640	96	373
CAST-800-2T-50 IE3	2960		67,80	39,30	37,00	7790	101	415
CAST-800-2T-60 IE3	2960		77,50	44,90	45,00	7770	101	472
CAST-800-2T-75 IE3	2960		95,60	55,40	55,00	11000	101	554
CAST-800-4T-10 IE3	1465		13,90	8,06	7,50	6970	81	250
CAST-900-4T-15 IE3	1470		20,90	12,10	11,00	7790	85	440
CAST-900-4T-20 IE3	1465		27,90	16,20	15,00	8610	86	478
CAST-1000-4T-25 IE3	1470		35,10	20,30	18,50	10970	88	586
CAST-1000-4T-30 IE3	1470		41,00	23,80	22,00	12300	89	646

Dimensiones mm

CAST-400...1000

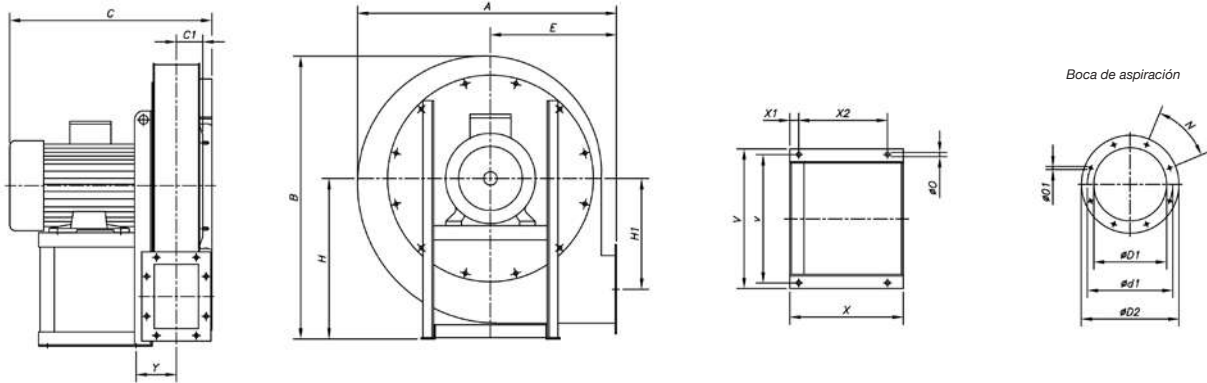

Modelo	A	B	C	C1	E	H	H1	Ø0	V	v	X	x1	x2	Y	ØD1	ØD2	Ød1	Ø01	N
CAST-400-2T-3	590	658	425	71	280	375	238	12	276	234	205	30	140	93	185	250	219	8	8x45°
CAST-450-2T-4	645	715	505	78	300	400	265	12	324	289	250	30	190	100	205	275	241	8	8x45°
CAST-450-2T-5.5	645	715	505	78	300	400	265	12	324	289	250	30	190	100	205	275	241	8	8x45°
CAST-500-2T-7.5	715	795	585	86	335	450	298	12	374	337	300	30	240	108	228	298	265	8	8x45°
CAST-500-2T-10	715	795	585	86	335	450	298	12	374	337	300	30	240	108	228	298	265	8	8x45°
CAST-560-2T-10	805	890	605	95	375	500	338	12	374	337	300	30	240	119	255	325	292	10	8x45°
CAST-560-2T-15	805	890	740	95	375	500	338	12	444	395	415	30	355	119	255	325	292	10	8x45°
CAST-630-2T-20	910	1000	760	105	425	560	381	12	444	395	415	30	355	129	285	365	332	10	8x45°
CAST-630-2T-25	910	1000	760	105	425	560	381	12	444	395	415	30	355	129	285	365	332	10	8x45°
CAST-710-2T-30	1015	1122	785	115	475	630	426	12	490	434	460	30	400	138	320	400	366	10	8x45°
CAST-710-2T-40	1015	1122	860	115	475	630	426	12	568	506	500	30	440	138	320	400	366	10	8x45°
CAST-710-2T-50	1015	1122	860	115	475	630	426	12	568	506	500	30	440	138	320	400	366	10	8x45°
CAST-800-2T-50	1140	1265	885	127	530	710	481	20	568	506	500	30	440	151	360	440	405	10	8x45°
CAST-800-2T-60	1140	1265	960	127	530	710	481	20	616	556	540	30	440	151	360	440	405	10	8x45°
CAST-800-2T-75	1140	1265	960	127	530	710	481	20	690	604	600	30	540	151	360	440	405	10	8x45°
CAST-800-4T-10	1140	1265	670	127	530	710	481	20	374	337	300	30	240	151	360	440	405	10	8x45°
CAST-900-4T-15	1285	1428	835	141	600	800	542	20	444	395	415	30	355	166	405	485	448	10	12x30°
CAST-900-4T-20	1285	1428	835	141	600	800	542	20	444	395	415	30	355	166	405	485	448	10	12x30°
CAST-1000-4T-25	1430	1590	870	163	670	900	607	20	490	434	460	30	400	182	455	535	497	10	12x30°
CAST-1000-4T-30	1430	1590	945	163	670	900	607	20	490	434	460	30	400	182	455	535	497	10	12x30°

Boca Impulsión

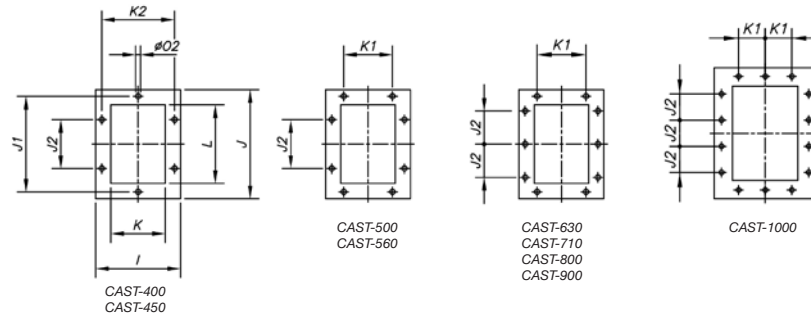

Modelo	I	J	J1	J2	K	K1	K2	L	Ø02
CAST-400	187	236	200	112	117	-	151	166	12
CAST-450	201	255	219	112	131	-	165	185	12
CAST-500	218	277	241	112	148	112	182	207	12
CAST-560	236	301	265	112	166	112	200	231	12
CAST-630	255	328	292	112	185	112	219	258	12
CAST-710	285	368	332	125	205	125	249	288	12
CAST-800	309	402	366	125	229	125	273	322	12
CAST-900	336	441	405	125	256	125	300	361	12
CAST-1000	368	484	448	125	288	125	332	404	12

Curvas Características

Q= Caudal en m³/h, m³/s y cfm

Pe= Presión estática en mmH₂O, Pa e inwg

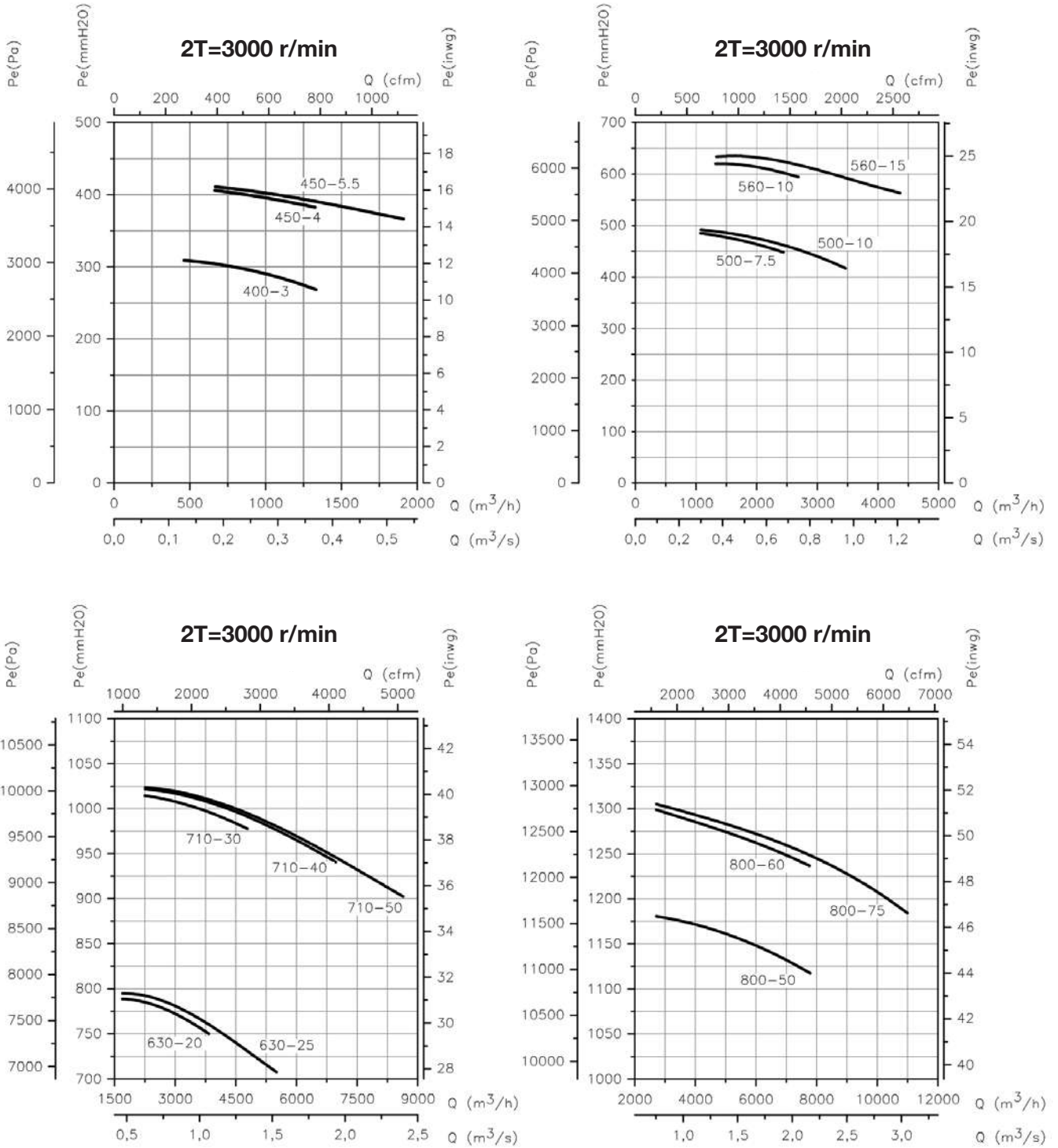

Curvas Características

Q= Caudal en m³/h, m³/s y cfm Pe= Presión estática en mmH₂O, Pa e inwg

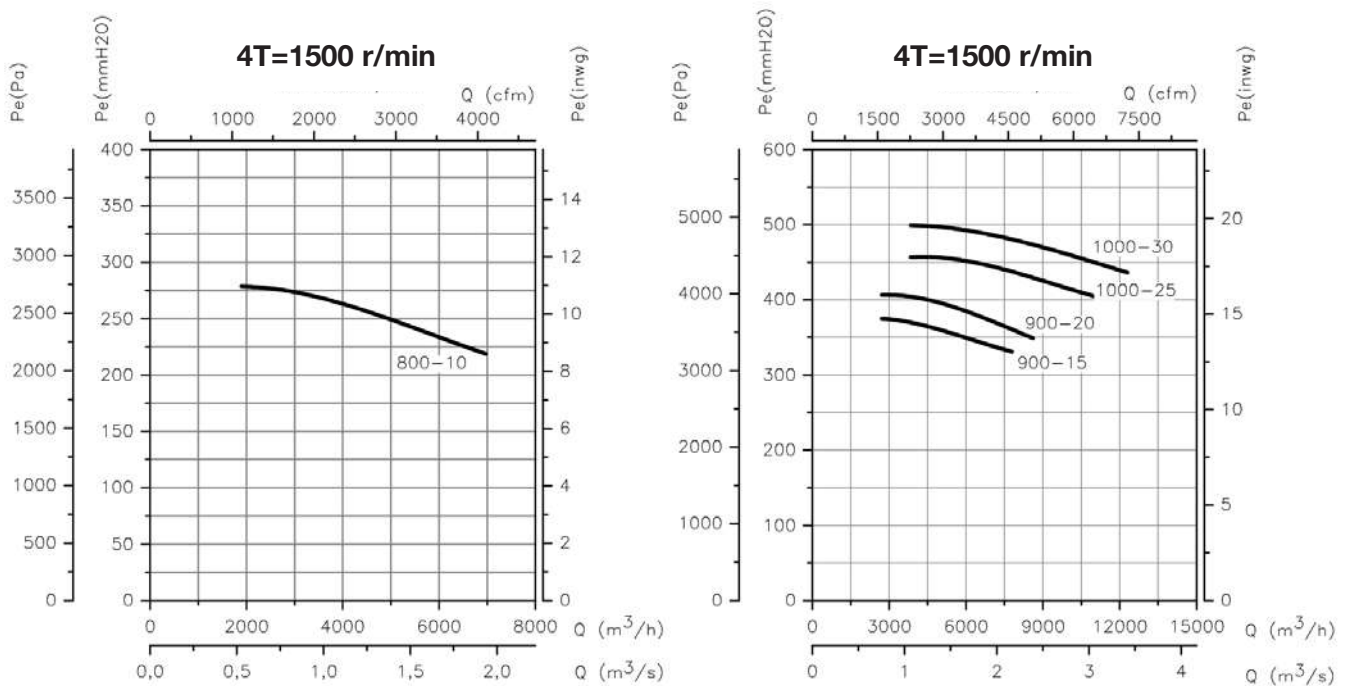

Orientaciones

Suministro estándar LG270, otras posiciones bajo demanda. Todos los modelos son orientables. Medidas especiales en posiciones 180 y 225.

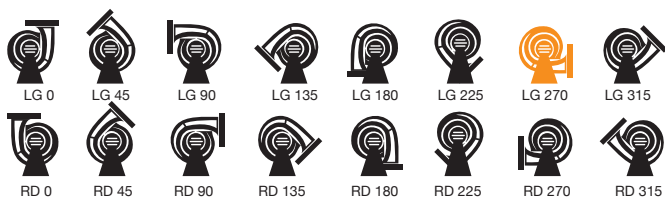

Accesorios

Ver apartado accesorios.

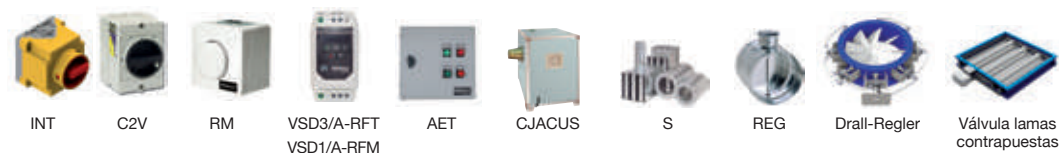



CMRH

Ventiladores accionados a transmisión, equipados con motor eléctrico, conjunto de poleas, correas y protectores normalizados según norma ISO-13857, y cajón calorifugado con fibra mineral de 150 mm, para trabajo horizontal



Engrasadores externos para facilitar el mantenimiento

Ventilador:

- Estructura en chapa de acero de gran espesor
- Turbina con álabes a reacción, en chapa de acero de gran robustez
- Grupo de transmisión con rodamientos y soporte en fundición

Motor:

- Motores de eficiencia IE2 para potencias iguales o superiores a 0,75kW e inferiores a 7,5kW, excepto monofásicos, 2 velocidades y 8 polos
- Motores de eficiencia IE3 para potencias iguales o superiores a 7,5kW, excepto monofásicos, 2 velocidades y 8 polos.
- Motores clase F, con rodamientos a bolas, protección IP55
- Trifásicos 230/400V-50Hz (hasta 4kW) y 400/690V-50Hz (potencias superiores a 4kW)

- Temperatura máxima del aire a transportar: -20°C + 300°C

Acabado:

- Tratamiento con pintura anticorrosiva

Bajo demanda:

- Bobinados especiales para diferentes tensiones
- Ventilador en acero refractario para temperaturas de hasta 400°C
- Ejecución para trabajo vertical
- Motores de eficiencias IE2 e IE3 para cualquier potencia

Código de pedido

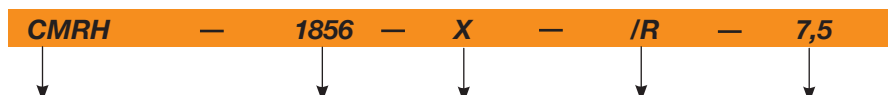

CMRH: Ventiladores accionados a transmisión, cajón calorifugado con fibra mineral de 150 mm, para trabajo horizontal

Tamaño turbina

Accionada a transmisión

Equipada con turbina de refrigeración

Potencia motor (CV)

Características técnicas

Modelo	Velocidad (r/min)	Intensidad máxima admisible (A)			Potencia instalada (kW)	Caudal máximo (m³/h)	Nivel presión sonora dB(A)	Peso aprox. (Kg)
		230V	400V	690V				
CMRH-1445-X/R-3	1700	8,36	4,83		2,20	9620	79	203
CMRH-1445-X/R-4	1910	10,96	6,33		3,00	10810	81	207
CMRH-1445-X/R-5.5	2120	14,10	8,12		4,00	12000	83	226
CMRH-1650-X/R-4	1530	10,96	6,33		3,00	9910	80	212
CMRH-1650-X/R-5.5	1720	14,10	8,12		4,00	11140	82	231
CMRH-1650-X/R-7.5	1910		11,60	6,72	5,50	12370	84	250
CMRH-1856-X/R-5.5	1365	14,10	8,12		4,00	14210	79	241
CMRH-1856-X/R-7.5	1535		11,60	6,72	5,50	15980	81	260
CMRH-1856-X/R-10 IE3	1705		14,20	8,20	7,50	17780	83	273
CMRH-2063-X/R-7.5	1365		11,60	6,72	5,50	22860	82	265
CMRH-2063-X/R-10 IE3	1515		14,20	8,20	7,50	25370	84	278
CMRH-2063-X/R-15 IE3	1700		20,20	11,60	11,00	28470	86	305
CMRH-2271-X/R-15 IE3	1370		20,20	11,60	11,00	32300	87	350
CMRH-2271-X/R-20 IE3	1540		27,50	15,90	15,00	36300	90	375
CMRH-2380-X/R-25 IE3	1280		35,00	20,00	18,50	43885	83	405
CMRH-2380-X/R-30 IE3	1365		42,00	24,00	22,00	46800	85	422

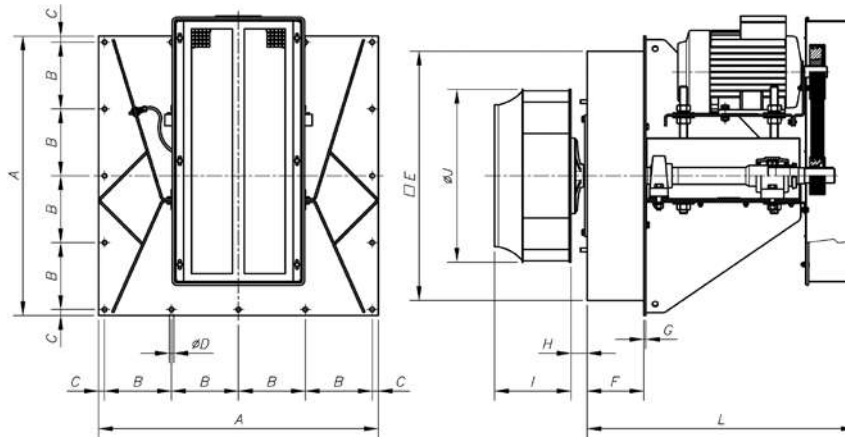
Dimensiones mm

Modelo	A	B	C	øD	E	F	G	H	I	øJ	L
CMRH-1445-X/R-3	740	177	16	12	660	150	5	43	202	458	710
CMRH-1445-X/R-4	740	177	16	12	660	150	5	43	202	458	710
CMRH-1445-X/R-5'5	740	177	16	12	660	150	5	43	202	458	710
CMRH-1650-X/R-4	740	177	16	12	660	150	5	43	224	508	710
CMRH-1650-X/R-5'5	740	177	16	12	660	150	5	43	224	508	710
CMRH-1650-X/R-7'5	740	177	16	12	660	150	5	43	224	508	710
CMRH-1856-X/R-4	800	192	16	12	720	150	5	43	245,5	573	816
CMRH-1856-X/R-5'5	800	192	16	12	720	150	5	43	245,5	573	816
CMRH-1856-X/R-7'5	800	192	16	12	720	150	5	43	245,5	573	816
CMRH-2063-X/R-7'5	800	192	16	12	720	150	5	43	274	644	816
CMRH-2063-X/R-10	800	192	16	12	720	150	5	43	274	644	816
CMRH-2063-X/R-15	800	192	16	12	720	150	5	43	274	644	816
CMRH-2271-X/R-15	970	233	20	14	870	150	5	43	295	719	817
CMRH-2271-X/R-20	970	233	20	14	870	150	5	43	295	719	817
CMRH-2380-X/R-25	970	232,5	20	14	870	150	5	53,5	400	810	902
CMRH-2380-X/R-30	970	232,5	20	14	870	150	5	53,5	400	810	902

Accesorios

Ver apartado accesorios.



INT

C2V

RM

 VSD3/A-RFT
VSD1/A-RFM

AET

ARO

VOL

Drall-Regler

 Válvula lamas
contrapuestas

Curvas Características

Q= Caudal en m³/h, m³/s y cfm

Pe= Presión estática en mmH₂O, Pa e in wg

CMRH 1445

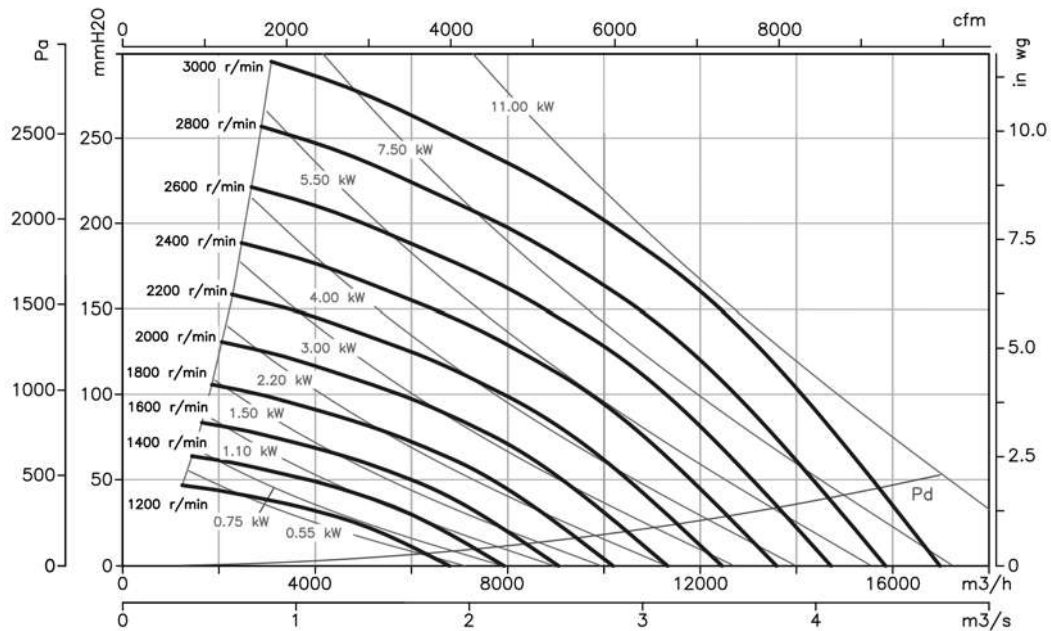

CMRH 1650

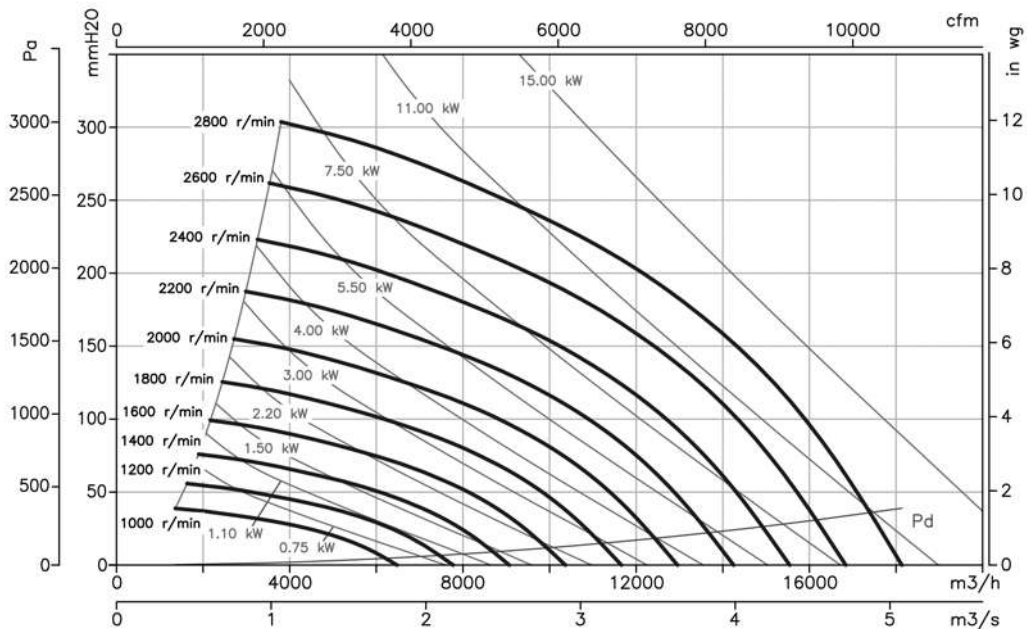

Curvas Características

Q= Caudal en m³/h, m³/s y cfm

Pe= Presión estática en mmH₂O, Pa e inwg

CMRH 1856

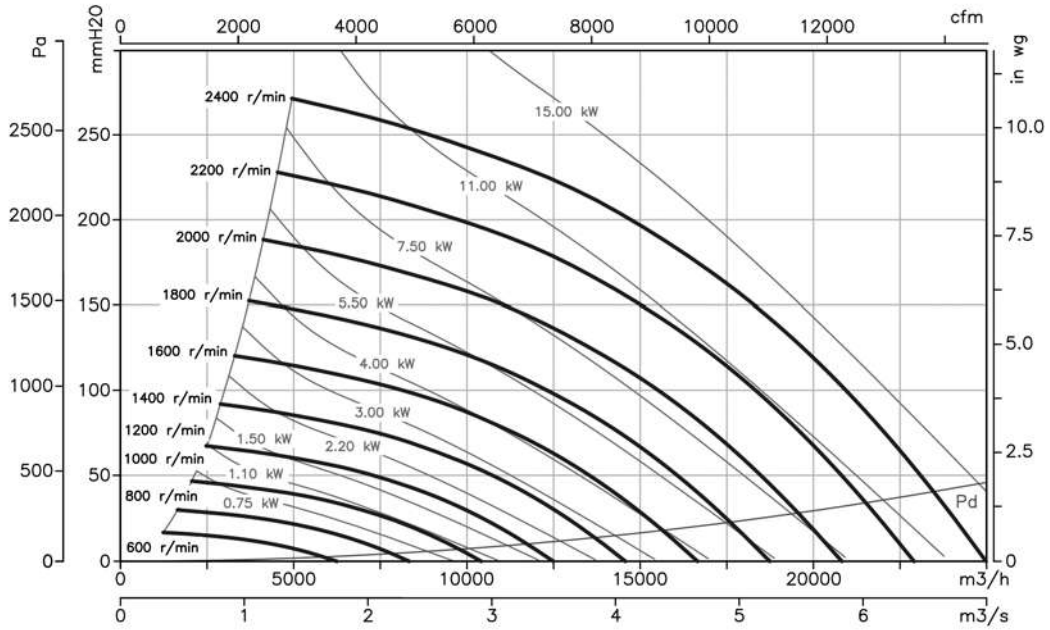

CMRH 2063

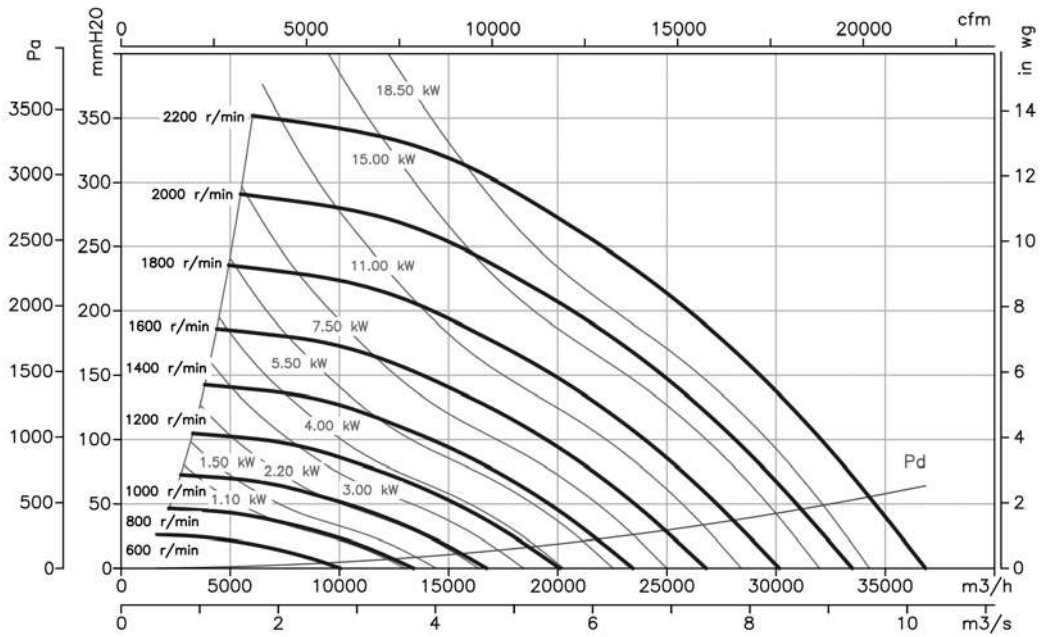

Curvas Características

Q= Caudal en m³/h, m³/s y cfm

Pe= Presión estática en mmH₂O, Pa e inwg

CMRH 2271

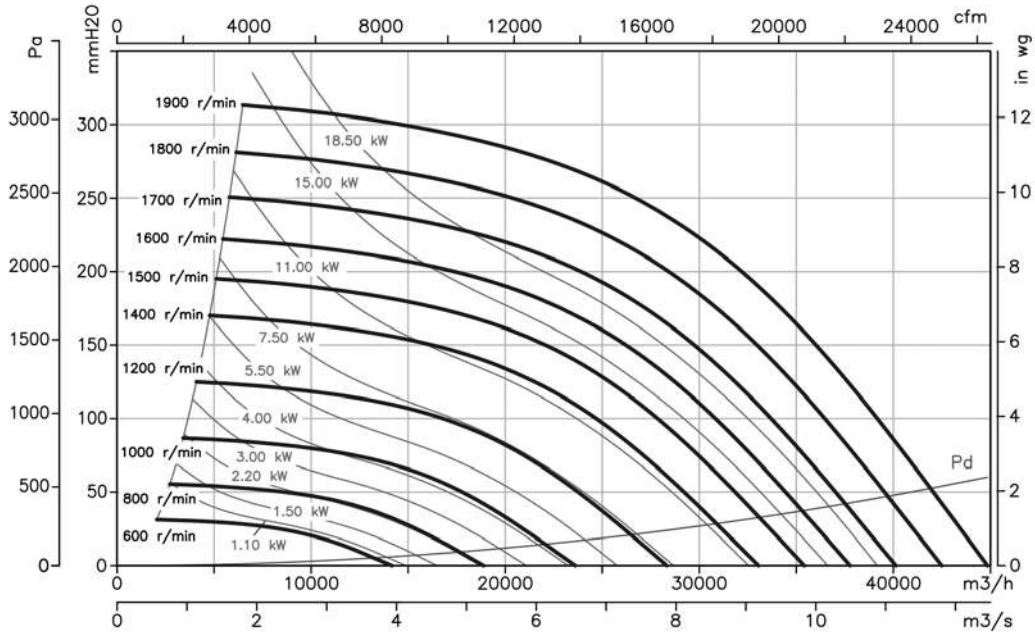

CMRH 2380

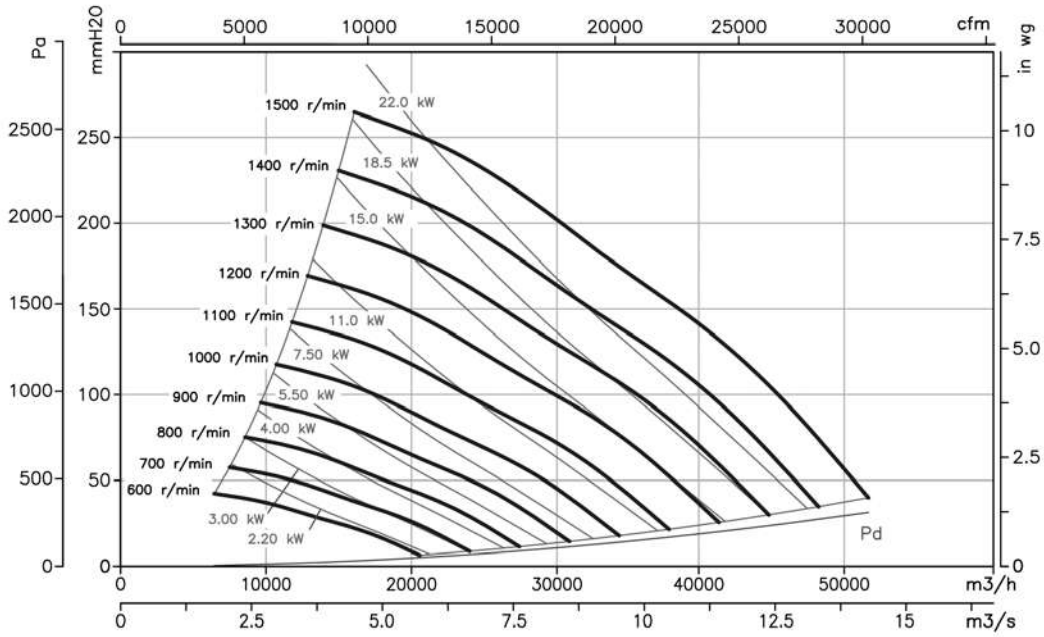



CMRG

Extractores centrífugos de media presión y simple aspiración con turbina con alabes hacia atrás, galvanizados en caliente, para trabajar en ambientes químicos, agresivos o marinos.

Ventilador:

- Envoltente en chapa de acero de gran robustez galvanizada en caliente
- Turbina con álabes a reacción, en chapa de acero de gran robustez, galvanizada en caliente
- Aro de aspiración galvanizado en caliente

Motor:

- Motores clase F, con rodamientos a bolas, protección IP55, excepto modelos monofásicos protección IP-54
- Motores de eficiencia IE3 para potencias iguales o superiores a 7,5kW, excepto monofásicos, 2 velocidades y 8 polos
- Monofásicos 230V.-50Hz y trifásicos 230/400V.-50Hz.(hasta 4 kW) y 400/690V.-50Hz.(potencias superiores a 4 kW)
- Temperatura máxima del aire a transportar: -20°C.+ 120°C.

Bajo demanda:

- Bobinados especiales para diferentes tensiones y frecuencias
- Construcción ATEX para diferentes categorías
- Motores marinos para aplicaciones navales, con certificación para servicio esencial según diferentes entidades de clasificación (BV, DNV, LR)
- Construcción en acero inoxidable
- Motores CE, NEMA, UL, CSA
- Motores de eficiencias IE2 e IE3 para cualquier potencia

Acabado:

- Anticorrosivo en acero galvanizado en caliente

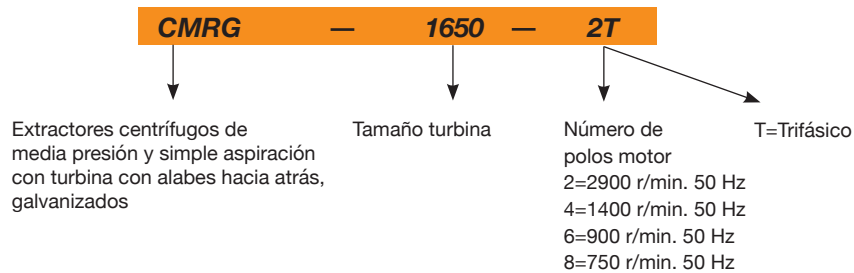
Código de pedido

Características técnicas

Modelo	Velocidad (r/min)	Intensidad máxima admisible (A)			Potencia instalada (kW)	Caudal máximo (m³/h)	Nivel presión sonora dB(A)	Peso aprox. (Kg)
		230V	400V	690V				
CMRG-1031-2T	2770	5,44	3,13		1,50	5160	80	44,3
CMRG-1135-2T	2885	7,77	4,47		2,20	7800	83	54,9
CMRG-1240-2T	2870	13,60	7,82		4,00	11100	86	93,5
CMRG-1240-4T	1410	3,10	1,79		0,75	5800	71	70,5
CMRG-1445-2T	2870		14,50	8,41	7,50	16500	87	126,0
CMRG-1445-4T	1400	4,03	2,32		1,10	8030	72	92,5
CMRG-1650-2T IE3	2945		20,00	11,60	11,00	18850	89	210,0
CMRG-1650-4T	1430	5,96	3,44		1,50	10500	74	114,0
CMRG-1650-6T	945	3,90	2,20		0,75	7410	64	114,0
CMRG-1856-4T	1445	10,96	6,33		3,00	15150	79	152,0
CMRG-1856-6T	945	4,88	2,82		1,10	10050	70	146,5
CMRG-2063-4T	1440		11,60	6,72	5,50	24450	80	226,0
CMRG-2063-6T	955	6,42	3,71		1,50	16100	71	208,5
CMRG-2063-8T	705	5,63	3,25		1,10	11600	65	210,5
CMRG-2271-4T IE3	1470		20,90	12,10	11,00	34610	85	340,0
CMRG-2271-6T	960	12,70	7,30		3,00	22750	76	293,5
CMRG-2271-8T	705	7,10	4,10		1,50	17360	69	275,5
CMRG-2380-4T IE3	1470		41,00	23,80	22,00	48000	83	431,0
CMRG-2380-6T IE3	975		14,80	8,58	7,50	30000	75	398,0
CMRG-2380-8T	705	12,82	7,40		3,00	22000	66	317,0
CMRG-2590-4T IE3	1480		69,20	40,10	37,00	54000	86	495,0
CMRG-2590-6T IE3	975		21,90	12,70	11,00	34000	76	400,0
CMRG-28100-4T IE3	1480		98,60	57,20	55,00	75000	87	618,0
CMRG-28100-6T IE3	980		35,90	20,80	18,50	48000	77	561,0

Características acústicas

Los valores indicados, se determinan mediante medidas de nivel de presión y potencia sonora en dB(A) obtenidas en campo libre a una distancia equivalente a dos veces la envergadura del ventilador más el diámetro de la turbina, con un mínimo de 1,5 mts.

Espectro de potencia sonora Lw(A) en dB(A) por banda de frecuencia en Hz

Modelo	63	125	250	500	1000	2000	4000	8000	Modelo	63	125	250	500	1000	2000	4000	8000
1031-2	65	78	78	91	86	86	86	79	2063-6	69	70	82	82	81	83	73	63
1135-2	72	79	77	89	87	93	92	79	2063-8	64	70	77	76	77	74	66	57
1240-2	68	83	81	93	90	94	96	83	2271-4	83	84	93	96	98	99	95	82
1240-4	56	70	76	79	79	80	70	59	2271-6	73	73	87	86	90	90	79	68
1445-2	73	85	83	95	93	97	99	89	2271-8	68	73	78	85	81	80	70	59
1445-4	59	72	78	83	80	83	78	64	2380-4	76	78	94	91	96	97	93	82
1650-2	73	81	85	99	97	99	99	88	2380-6	68	70	86	83	88	89	85	74
1650-4	64	74	82	84	83	85	76	66	2380-8	59	61	77	74	79	80	76	65
1650-6	53	65	72	77	73	69	62	54	2590-4	79	84	97	100	96	89	84	66
1856-4	69	78	91	87	90	91	85	71	2590-6	70	79	89	88	85	84	74	68
1856-6	61	69	81	83	80	81	71	60	28100-4	82	89	101	102	97	93	87	78
2063-4	80	85	91	93	91	88	81	73	28100-6	73	82	91	90	88	86	77	70

Dimensiones mm

CMRG-1031...2271

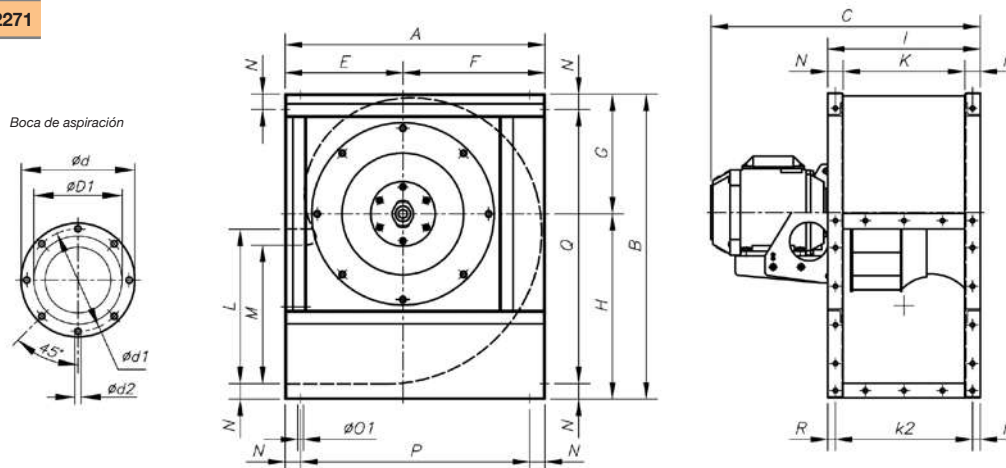

Modelo	A	B	C	øD1*	ød	ød1	ød2	E	F	G	H	I	K	k2	L	M	N	øO1	P	Q	R
CMRG-1031-2T	542	626	573,5	315	383	356	M8	250	292	245	381	320	250	285	315	276	35	11	472	556	17,5
CMRG-1135-2T	600	696	656	355	425	398	M8	275	325	273	423	350	280	315	355	310	35	11	530	626	17,5
CMRG-1240-2T	673	790	728	400	472	444	M10	305	368	310	480	395	315	355	400	358	40	11	593	710	20
CMRG-1240-4T	673	790	590	400	472	444	M10	305	368	310	480	395	315	355	400	358	40	11	593	710	20
CMRG-1445-2T	765	880	810	450	522	494	M10	350	415	339	541	445	355	403	450	404	45	11	675	790	21
CMRG-1445-4T	765	880	649	450	522	494	M10	350	415	339	541	445	355	403	450	404	45	11	675	790	21
CMRG-1650-2T	832	970	961	500	582	555	M10	375	457	378	592	490	400	450	500	445	45	13	742	880	20
CMRG-1650-4T	832	970	715	500	582	555	M10	375	457	378	592	490	400	450	500	445	45	13	742	880	20
CMRG-1650-6T	832	970	695	500	582	555	M10	375	457	378	592	490	400	450	500	445	45	13	742	880	20
CMRG-1856-4T	925	1084	832	560	645	615	M10	415	510	426	658	550	450	500	560	493	50	13	825	984	25
CMRG-1856-6T	925	1084	771	560	645	615	M10	415	510	426	658	550	450	500	560	493	50	13	825	984	25
CMRG-2063-4T	1037	1218	973	630	720	688	M10	465	572	477	741	620	500	560	630	530	60	13	917	1098	30
CMRG-2063-6T	1037	1218	893	630	720	688	M10	465	572	477	741	620	500	560	630	530	60	13	917	1098	30
CMRG-2063-8T	1037	1218	893	630	720	688	M10	465	572	477	741	620	500	560	630	530	60	13	917	1098	30
CMRG-2271-4T	1173	1375	1126	710	800	768	M12	525	648	538	837	690	560	625	710	603	65	13	1043	1245	32,5
CMRG-2271-6T	1173	1375	1039	710	800	768	M12	525	648	538	837	690	560	625	710	603	65	13	1043	1245	32,5
CMRG-2271-8T	1173	1375	1002	710	800	768	M12	525	648	538	837	690	560	625	710	603	65	13	1043	1245	32,5

* Diámetro nominal tubería recomendada

Dimensiones mm

CMRG-2380...28100

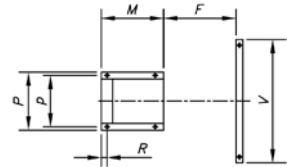
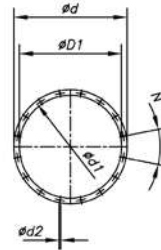
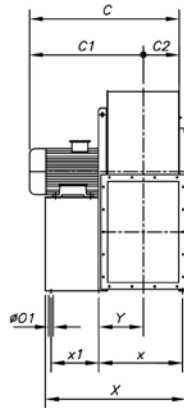
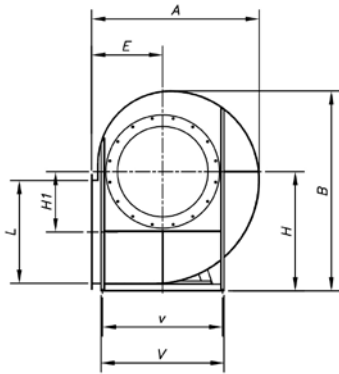

Boca de aspiración
 CMR-2380-4T
 CMR-2380-6T
 CMR-2380-8T
 CMR-2590-4T
 CMR-2590-6T

Boca de aspiración
 CMR-28100-4T
 CMR-28100-6T

Modelo	A	B	C	C1	C2	ØD1	Ød	Ød1	Ød2	E	H	H1	L	F	M	R	N	ØO1	P	p	V	v	X	x	x1	Y
CMR-2380-4T	1312	1591	1206,5	919,5	287	805	905	861	15	560	950	478	801	572	463	27	16x22°30'	20	926	872	932	862	1095	668	409	314
CMR-2380-6T	1312	1591	1131,5	844,5	287	805	905	861	15	560	950	478	801	572	418	27	16x22°30'	20	926	872	932	862	1050	668	364	314
CMR-2380-8T	1312	1591	995,5	708,5	287	805	905	861	15	560	950	478	801	572	303	27	16x22°30'	20	926	872	932	862	935	668	249	314
CMR-2590-4T	1470	1780	1332,5	1010,5	322	905	1005	958	15	630	1060	538	898	638	540	27	16x22°30'	20	1026	972	1145	962	1258	731	486	346
CMR-2590-6T	1470	1780	1180,5	858,5	322	905	1005	958	15	630	1060	538	898	638	415	27	16x22°30'	20	1026	972	1145	962	1133	731	361	346
CMR-28100-4T	1656	1993	1427	1067	360	1007	1107	1067	15	710	1180	607	1007	715	600	27	24x15°	20	1128	1074	1255	1056	1400	803	500	431
CMR-28100-6T	1656	1993	1350	990	360	1007	1107	1067	15	710	1180	607	1007	715	500	27	24x15°	20	1128	1074	1255	1056	1300	803	400	431

Boca Impulsión

CMRG-1031
 CMRG-1135
 CMRG-2590
 CMRG-28100

CMRG-622
 CMRG-625
 CMRG-728
 CMRG-731

CMRG-1240
 CMRG-1445
 CMRG-1650

CMRG-1856

CMRG-2063

CMRG-2271

CMRG-2380

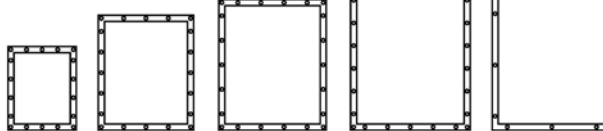
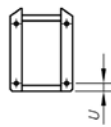
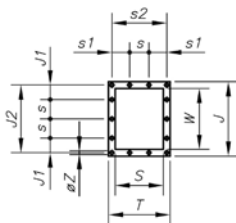

Modelo	T	J	J1	J2	S	s	s1	s2	W	Øz	U
CMRG-1031	320	385	75	350	250	100	92,5	285	315	9	-
CMRG-1135	350	425	95	390	280	100	107,5	315	355	9	-
CMRG-1240	395	480	70	440	315	100	77,5	355	400	11	-
CMRG-1445	445	540	99	498	355	100	102,5	403	450	11	-
CMRG-1650	490	590	88	550	400	125	100	450	500	11	-
CMRG-1856	550	660	55	610	450	125	125	500	560	13	-
CMRG-2063	620	750	95	690	500	125	92,5	560	630	13	-
CMRG-2271	690	840	75	775	560	125	62,5	625	710	13	-
CMRG-2380	689	921	135,5	871	569	200	119,5	639	801	14	-
CMRG-2590	758	1018	84	968	638	200	54	708	898	18	-
CMRG-28100	835	1127	138,5	1077	715	200	92,5	785	1007	18	-



Curvas Características

Q= Caudal en m³/h, m³/s y cfm.

Pe= Presión estática en mmH₂O, Pa e in wg.

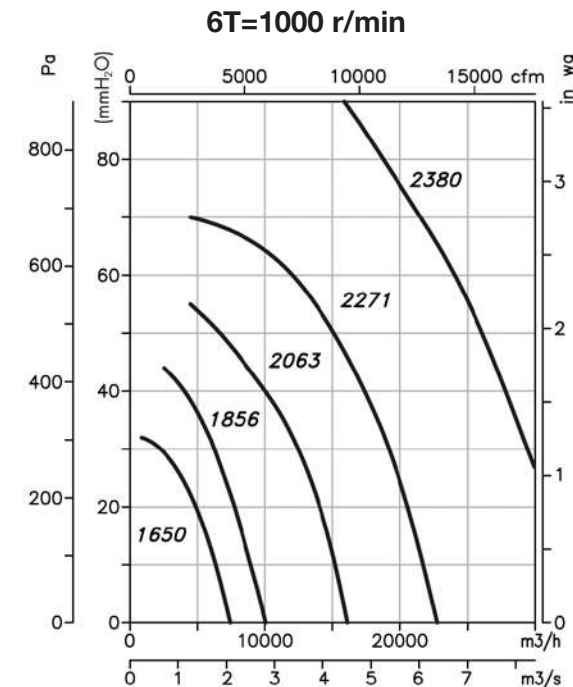
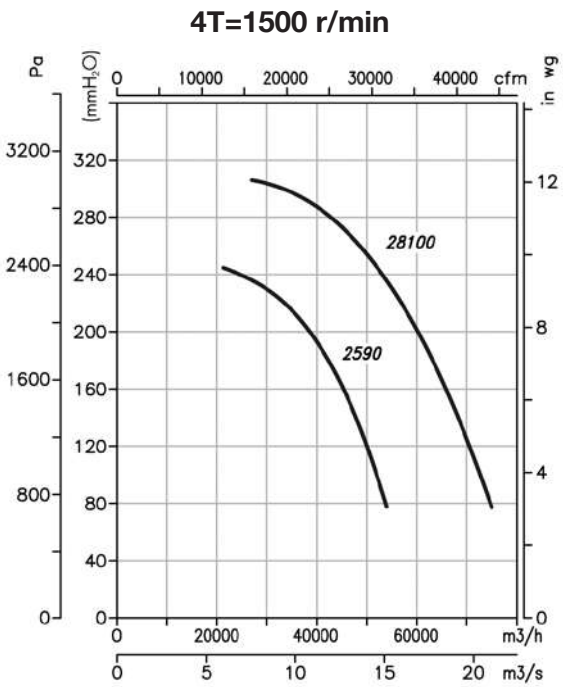
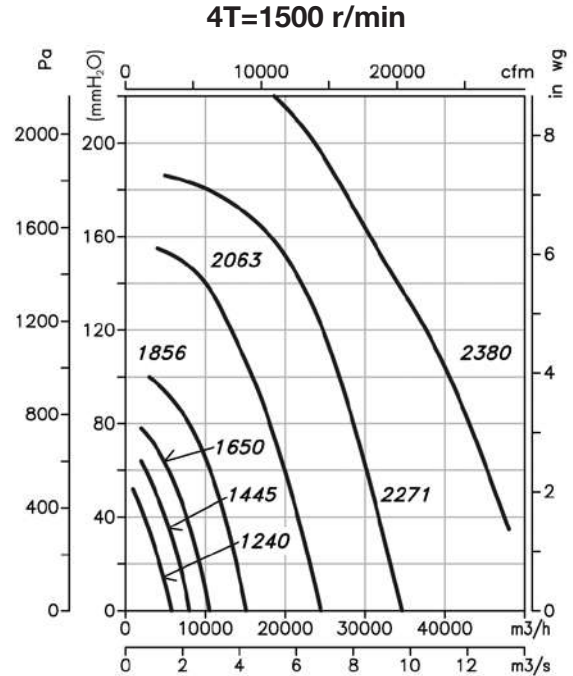
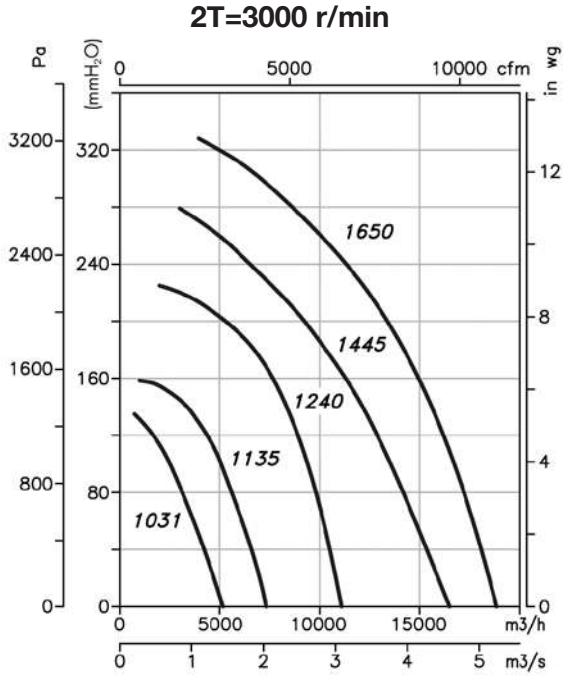

Curvas Características

Q= Caudal en m³/h, m³/s y cfm.

Pe= Presión estática en mmH2O, Pa e inwg.

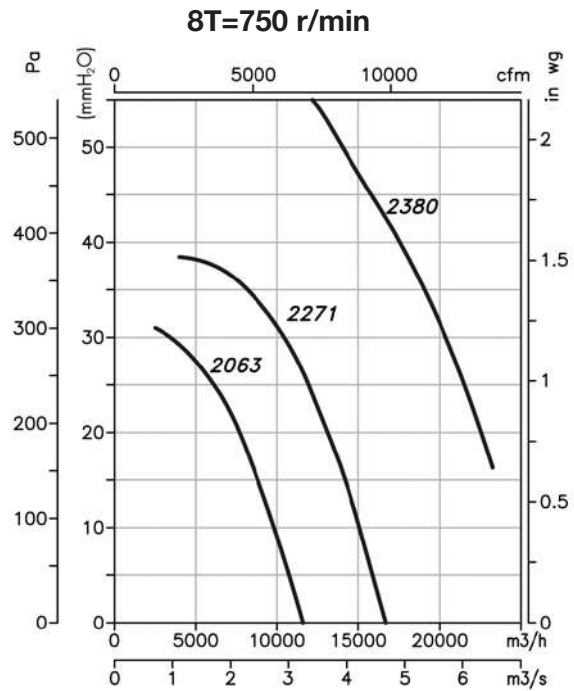
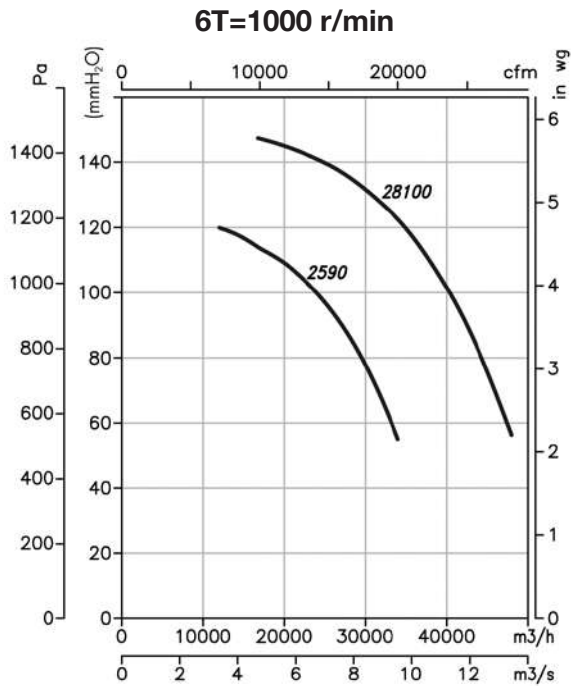

Orientaciones

Suministro standard LG 270

Modelos 2380, 2590 y 28100 orientación fija LG 270 (otras orientaciones sólo bajo demanda)

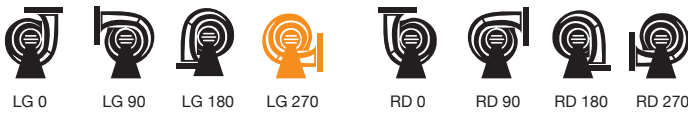

Accesorios

Ver apartado accesorios.

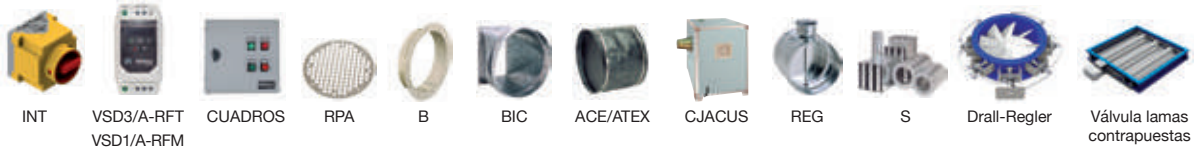

HFW



Ventiladores tubulares galvanizados en caliente

Ventiladores helicoidales tubulares diseñados con cuatro brazos soporte para reducir vibraciones y equipados con hélice de aluminio aerodinámica de bajo consumo.

Ventilador:

- Dirección aire motor-hélice.
- Hélices versión AL en fundición de aluminio.
- Aro soporte en chapa de acero con doble brida y pasacables para alimentación del motor.
- Envolvente tubular en chapa de acero galvanizado en caliente.

Motor:

- Motores de eficiencia IE2 para potencias iguales o superiores a 0,75kW e inferiores a 7,5kW, excepto monofásicos, 2 velocidades y 8 polos
- Motores de eficiencia IE3 para potencias iguales o superiores a 7,5kW, excepto monofásicos, 2 velocidades y 8 polos
- Motores clase F, con rodamientos a bolas, protección IP55.

- Trifásicos 230/400V-50Hz (hasta 4kW) y 400/690V-50Hz (potencias superiores a 4kW)
- Temperatura de trabajo : -25°C+ 50°C.

Acabado:

- Galvanizado en caliente

Bajo demanda:

- Dirección aire hélice-motor.
- Hélices versión PL en poliamida con fibra de vidrio.
- Hélices reversibles 100%.
- Bobinados especiales para diferentes tensiones.
- Certificación ATEX Categoría 2.
- Motores de eficiencias IE2 e IE3 para cualquier potencia



Código de pedido

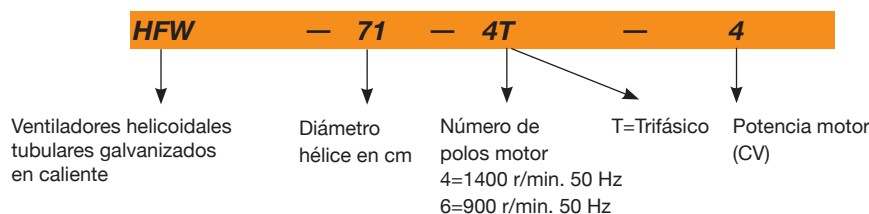

Características técnicas

Modelo	Velocidad (r/min)	Intensidad máxima admisible (A)			Potencia instalada (kW)	Ángulo inclinación palas (°)	Caudal máximo (m³/h)	Nivel presión sonora dB(A)	Peso aprox. (Kg)	According ErP
		230V	400V	690V						
HFW-56-4T-1	1410	3,10	1,79		0,75	22	11250	73	28	2015
HFW-56-4T-1,5	1400	4,03	2,32		1,10	30	13600	74	32	2015
HFW-56-4T-2	1430	5,96	3,44		1,50	36	15050	75	30	2015
HFW-56-6T-0,75	910	2,59	1,49		0,55	38	10150	62	23	*
HFW-63-4T-1	1410	3,10	1,79		0,75	14	15200	73	29	2015
HFW-63-4T-1,5	1400	4,03	2,32		1,10	20	17800	74	32	2015
HFW-63-4T-2	1430	5,96	3,44		1,50	24	19300	75	35	2015
HFW-63-4T-3	1445	8,36	4,83		2,20	32	22150	76	43	2015
HFW-63-4T-4	1445	10,96	6,33		3,00	38	24250	77	45	2015
HFW-63-6T-0,75	910	2,59	1,49		0,55	28	13600	65	29	2015
HFW-63-6T-1	945	3,90	2,20		0,75	38	15900	66	35	2015
HFW-71-4T-1,5	1400	4,03	2,32		1,10	12	19500	78	35	2015
HFW-71-4T-2	1430	5,96	3,44		1,50	14	20900	79	38	2015
HFW-71-4T-3	1445	8,36	4,83		2,20	22	25100	81	47	2015
HFW-71-4T-4	1445	10,96	6,33		3,00	28	27500	82	49	2015
HFW-71-6T-0,75	910	2,59	1,49		0,55	20	16100	67	31	2015
HFW-71-6T-1	945	3,90	2,20		0,75	26	17300	68	38	2015
HFW-71-6T-1,5	945	4,88	2,82		1,10	34	19950	69	40	2015
HFW-80-4T-3	1445	8,36	4,83		2,20	12	25450	82	55	2015
HFW-80-4T-4	1445	10,96	6,33		3,00	16	30250	83	57	2015
HFW-80-4T-5,5	1440	14,10	8,12		4,00	18	32750	84	62	2015
HFW-80-6T-1,5	945	4,88	2,82		1,10	18	21450	72	48	2015
HFW-80-6T-2	955	6,42	3,71		1,50	26	25950	73	54	2015
HFW-80-6T-3	955	9,30	5,30		2,20	32	29950	74	59	2015
HFW-90-4T-4	1445	10,96	6,33		3,00	8	33600	87	66	2015
HFW-90-4T-5,5	1440	14,10	8,12		4,00	12	38900	89	71	2015
HFW-90-4T-7,5	1440		10,60	6,14	5,50	18	46150	91	87	2015
HFW-90-4T-10 IE3	1465		8,06	13,90	7,50	22	50150	92	98	2015
HFW-90-6T-2	955	6,42	3,71		1,50	16	28800	77	63	2015
HFW-90-6T-3	955	9,30	5,30		2,20	24	34000	78	68	2015
HFW-90-6T-4	960	12,70	7,30		3,00	30	38900	79	92	2015
HFW-100-4T-7,5	1440		10,60	6,14	5,50	10	46850	92	95	2015
HFW-100-4T-10 IE3	1465		8,06	13,90	7,50	16	57400	93	106	2015
HFW-100-4T-15 IE3	1470		20,90	12,10	11,00	22	66300	94	129	2015
HFW-100-4T-20 IE3	1470		28,30	16,40	15,00	28	76150	95	148	2015
HFW-100-6T-3	955	9,30	5,30		2,20	16	37600	82	76	2015
HFW-100-6T-4	960	12,70	7,30		3,00	20	41150	83	100	2015
HFW-100-6T-5,5	960	16,50	9,46		4,00	26	47800	84	108	2015

* Equipos fuera de la Directiva 2009/125/EC

Características acústicas

Los valores indicados, se determinan mediante medidas de nivel de presión y potencia sonora en dB(A) obtenidas en campo libre a una distancia equivalente a dos veces la envergadura del ventilador más el diámetro de la hélice, con un mínimo de 1,5 mts.

Espectro de potencia sonora Lw(A) en dB(A) por banda de frecuencia en Hz

Modelo	63	125	250	500	1000	2000	4000	8000	Modelo	63	125	250	500	1000	2000	4000	8000
HFW-56-4T-1	48	68	76	81	83	80	73	62	HFW-80-4T-4	56	76	84	89	91	88	81	74
HFW-56-4T-1,5	49	69	77	82	84	81	74	63	HFW-80-4T-5,5	56	76	84	89	91	88	81	70
HFW-56-4T-2	50	70	78	83	85	82	75	64	HFW-80-6T-1,5	49	66	74	79	81	78	71	60
HFW-56-6T-0,75	37	57	65	70	72	69	62	51	HFW-80-6T-2	50	67	75	80	82	79	72	61
HFW-63-4T-1	50	70	78	83	85	82	75	64	HFW-80-6T-3	51	68	76	81	83	80	73	62
HFW-63-4T-1,5	48	68	76	81	83	80	73	65	HFW-90-4T-4	61	82	89	94	97	93	86	79
HFW-63-4T-2	52	68	76	81	83	80	73	66	HFW-90-4T-5,5	60	81	88	93	96	92	85	74
HFW-63-4T-3	53	70	78	83	85	82	77	67	HFW-90-4T-7,5	59	80	87	92	95	91	84	73
HFW-63-4T-4	54	71	79	84	86	83	78	68	HFW-90-4T-10	58	79	86	91	94	90	83	72
HFW-63-6T-0,75	42	60	68	73	75	72	65	56	HFW-90-6T-2	58	79	86	91	94	90	83	72
HFW-63-6T-1	43	62	70	75	77	74	67	57	HFW-90-6T-3	56	70	77	82	85	81	74	63
HFW-71-4T-1,5	54	74	82	87	89	86	79	69	HFW-90-6T-4	57	72	79	84	87	83	76	65
HFW-71-4T-2	53	73	81	86	88	85	78	70	HFW-100-4T-7,5	64	84	92	97	99	96	89	78
HFW-71-4T-3	58	72	80	85	87	84	77	71	HFW-100-4T-10	62	82	90	95	97	94	87	76
HFW-71-4T-4	59	73	81	86	88	85	78	72	HFW-100-4T-15	61	81	89	94	96	93	86	75
HFW-71-6T-0,75	44	63	72	74	76	73	66	55	HFW-100-4T-20	63	83	91	96	98	95	88	77
HFW-71-6T-1	45	65	73	75	77	74	67	56	HFW-100-6T-3	61	72	80	85	87	84	77	66
HFW-71-6T-1,5	46	66	71	76	78	75	68	57	HFW-100-6T-4	64	72	80	85	87	84	77	66
HFW-80-4T-3	57	77	85	90	92	89	82	73	HFW-100-6T-5,5	64	73	81	86	88	85	78	67



Erp. Características del punto de máxima eficiencia (BEP)

PN	Potencia nominal motor en kW	ηe[%]	Eficiencia
MC	Categoría de medición	N	Grado de eficiencia
EC	Categoría de eficiencia	[kW]	Potencia eléctrica
S	Estática	[m³/h]	Caudal
T	Total	[mmH₂O]	Presión estática o total (Según EC)
VSD	Variador de velocidad	[RPM]	Velocidad
SR	Relación específica		

Modelo	MC	EC	VSD	SR	ηe [%]	N	[kW]	[m3/h]	[mmH₂O]	[RPM]
HFW-56-4T-1	A	S	NO	1,00	37,2%	44,1	0,837	7959	14,38	1438
HFW-63-4T-1	C	S	NO	1,00	49,8%	56,5	0,868	9291	17,07	1436
HFW-63-4T-1.5	C	S	NO	1,00	47,9%	53,7	1,193	10625	19,76	1447
HFW-63-4T-2	C	S	NO	1,00	42,3%	47,4	1,551	12026	20,03	1449
HFW-63-4T-3	B	T	NO	1,00	61,9%	65,8	2,447	20324	27,38	1439
HFW-63-4T-4	B	T	NO	1,00	62,6%	65,9	3,020	24239	28,64	1440
HFW-63-6T-0.75	B	T	NO	1,00	57,7%	65,4	0,611	12174	10,64	949
HFW-63-6T-1	B	T	NO	1,00	57,1%	63,7	0,930	15880	12,29	942
HFW-71-4T-1.5	C	S	NO	1,00	47,9%	53,4	1,346	12330	19,20	1440
HFW-71-4T-2	C	S	NO	1,00	48,4%	53,6	1,495	13405	19,83	1450
HFW-71-4T-3	C	S	NO	1,00	42,8%	46,8	2,369	17056	21,84	1441
HFW-71-4T-4	C	S	NO	1,00	40,7%	44,0	2,976	19369	22,96	1441
HFW-71-6T-0.75	C	S	NO	1,00	40,3%	47,7	0,678	10743	9,35	944
HFW-71-6T-1	C	S	NO	1,00	38,4%	45,2	0,842	12404	9,58	947
HFW-71-6T-1.5	C	S	NO	1,00	34,0%	40,1	1,103	14226	9,69	955
HFW-80-4T-3	C	S	NO	1,00	47,0%	51,0	2,417	16923	24,69	1440
HFW-80-4T-4	C	S	NO	1,00	44,5%	47,4	3,404	20444	27,19	1432
HFW-80-4T-5.5	C	S	NO	1,00	43,6%	46,1	4,011	22304	28,78	1457
HFW-80-6T-1.5	C	S	NO	1,00	40,2%	45,9	1,224	14613	12,35	951
HFW-80-6T-2	C	S	NO	1,00	39,2%	44,0	1,764	17576	14,46	962
HFW-80-6T-3	C	S	NO	1,00	37,1%	41,1	2,317	20444	15,44	956
HFW-90-4T-4	C	S	NO	1,00	51,9%	55,2	3,028	19656	29,36	1440
HFW-90-4T-5.5	C	S	NO	1,00	50,5%	53,0	4,049	25081	29,94	1456
HFW-90-4T-7.5	C	S	NO	1,00	47,7%	49,0	6,251	31521	34,72	1465
HFW-90-4T-10 IE3	C	S	NO	1,01	46,1%	46,8	7,730	35009	37,36	1467
HFW-90-6T-2	C	S	NO	1,00	45,8%	50,8	1,625	19416	14,08	965
HFW-90-6T-3	C	S	NO	1,00	41,1%	44,8	2,615	23753	16,64	950
HFW-90-6T-4	C	S	NO	1,00	37,7%	40,6	3,515	27183	17,92	970
HFW-100-4T-7.5	C	S	NO	1,00	52,1%	53,9	5,240	30466	32,94	1471
HFW-100-4T-10 IE3	C	S	NO	1,00	48,9%	49,4	8,112	37591	38,73	1466
HFW-100-4T-15 IE3	C	S	NO	1,01	44,7%	44,3	11,841	44571	43,65	1470
HFW-100-4T-20 IE3	C	S	NO	1,01	41,3%	40,1	15,684	50259	47,37	1471
HFW-100-6T-3	C	S	NO	1,00	45,0%	48,9	2,474	24629	16,62	953
HFW-100-6T-4	C	S	NO	1,00	43,9%	47,1	3,131	27632	18,28	974
HFW-100-6T-5.5	C	S	NO	1,00	38,9%	41,2	4,429	32373	19,56	971

Dimensiones mm

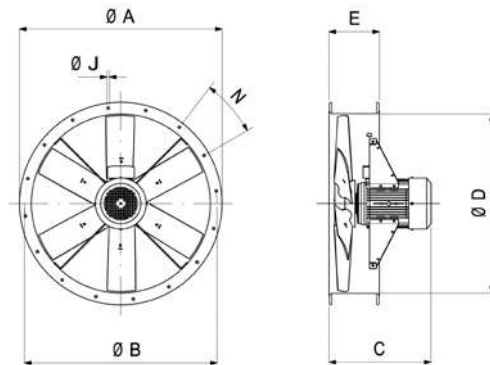

Modelo	ØA	ØB	C											ØD	E	ØJ	N
			0,75	1	1,5	2	3	4	5,5	7,5	10	15	20				
HFW-56-4	665	620	-	330	380	380	-	-	-	-	-	-	-	560	225	12	12x30°
HFW-56-6	665	620	330	-	-	-	-	-	-	-	-	-	-	560	225	12	12x30°
HFW-63-4	735	690	-	379	429	429	470	470	-	-	-	-	-	640	225	12	12x30°
HFW-63-6	735	690	379	429	-	-	-	-	-	-	-	-	-	640	225	12	12x30°
HFW-71-4	815	770	-	-	389	389	430	430	-	-	-	-	-	710	225	12	16x22°30'
HFW-71-6	815	770	339	389	389	-	-	-	-	-	-	-	-	710	225	12	16x22°30'
HFW-80-4	905	860	-	-	-	-	436	436	460	-	-	-	-	800	225	12	16x22°30'
HFW-80-6	905	860	-	-	395	436	460	-	-	-	-	-	-	800	225	12	16x22°30'
HFW-90-4	1018	970	-	-	-	-	401	425	485	525	-	-	-	900	225	15	16x22°30'
HFW-90-6	1018	970	-	-	-	401	425	485	-	-	-	-	-	900	225	15	16x22°30'
HFW-100-4	1118	1070	-	-	-	-	-	-	488	528	643	703	-	1000	225	15	16x22°30'
HFW-100-6	1118	1070	-	-	-	-	428	488	528	-	-	-	-	1000	225	15	16x22°30'

Curvas características

Q= Caudal en m³/h, m³/s y cfm.

Pe= Presión estática en mmH₂O, Pa e inwg.

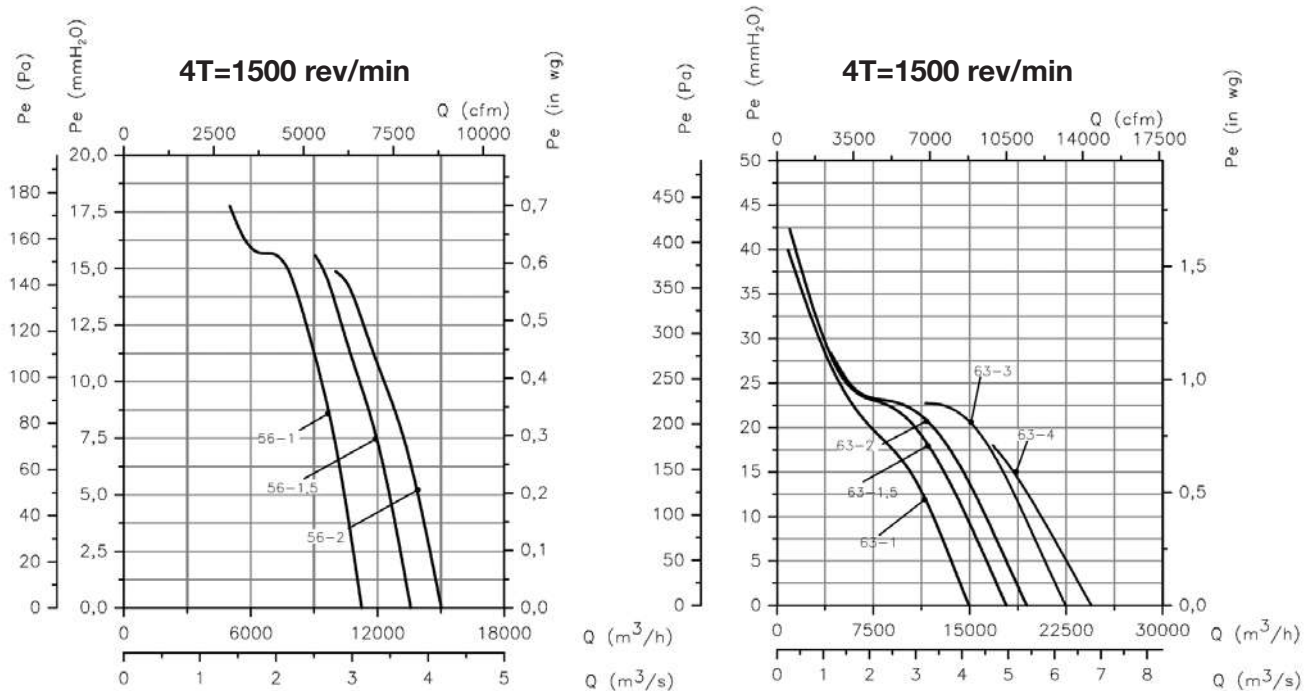

Curvas características

Q= Caudal en m³/h, m³/s y cfm.

Pe= Presión estática en mmH₂O, Pa e inwg.

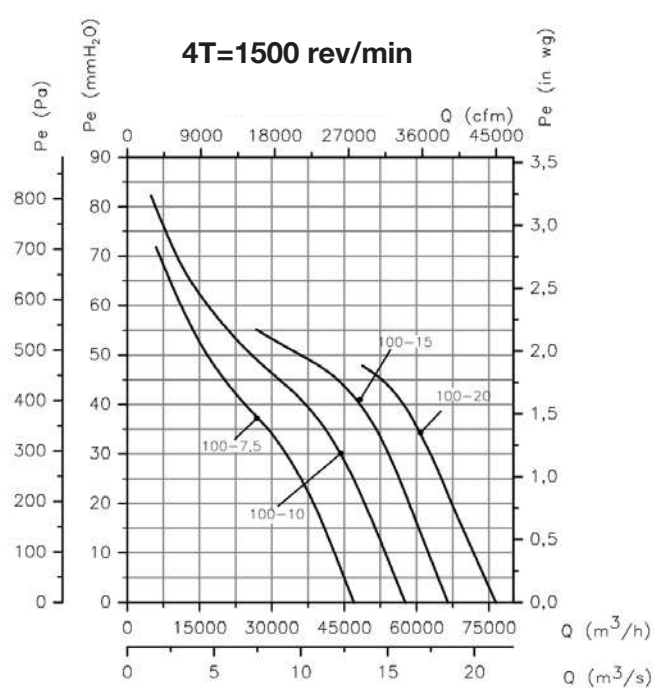
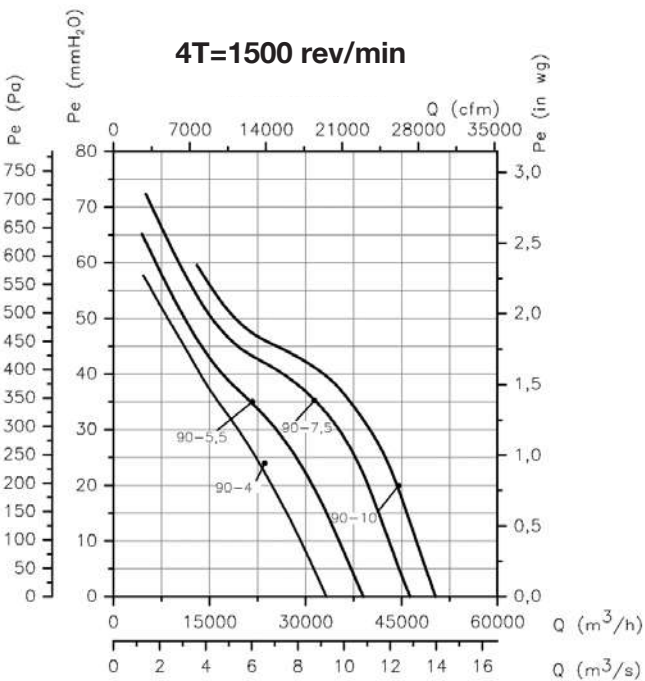
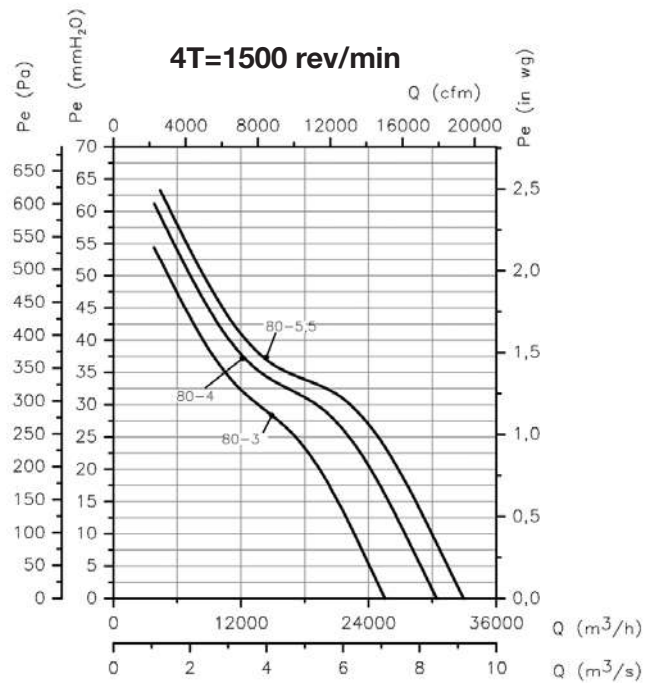
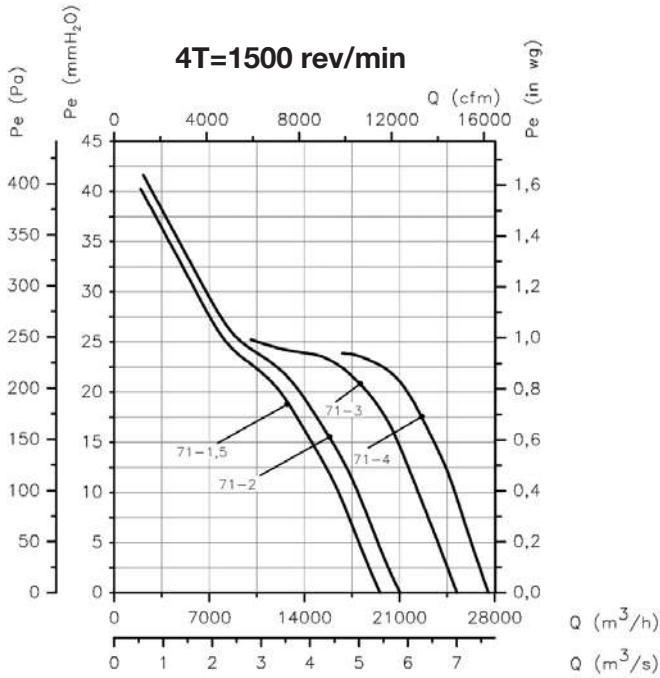

Curvas características

Q= Caudal en m³/h, m³/s y cfm.

Pe= Presión estática en mmH₂O, Pa e inwg.

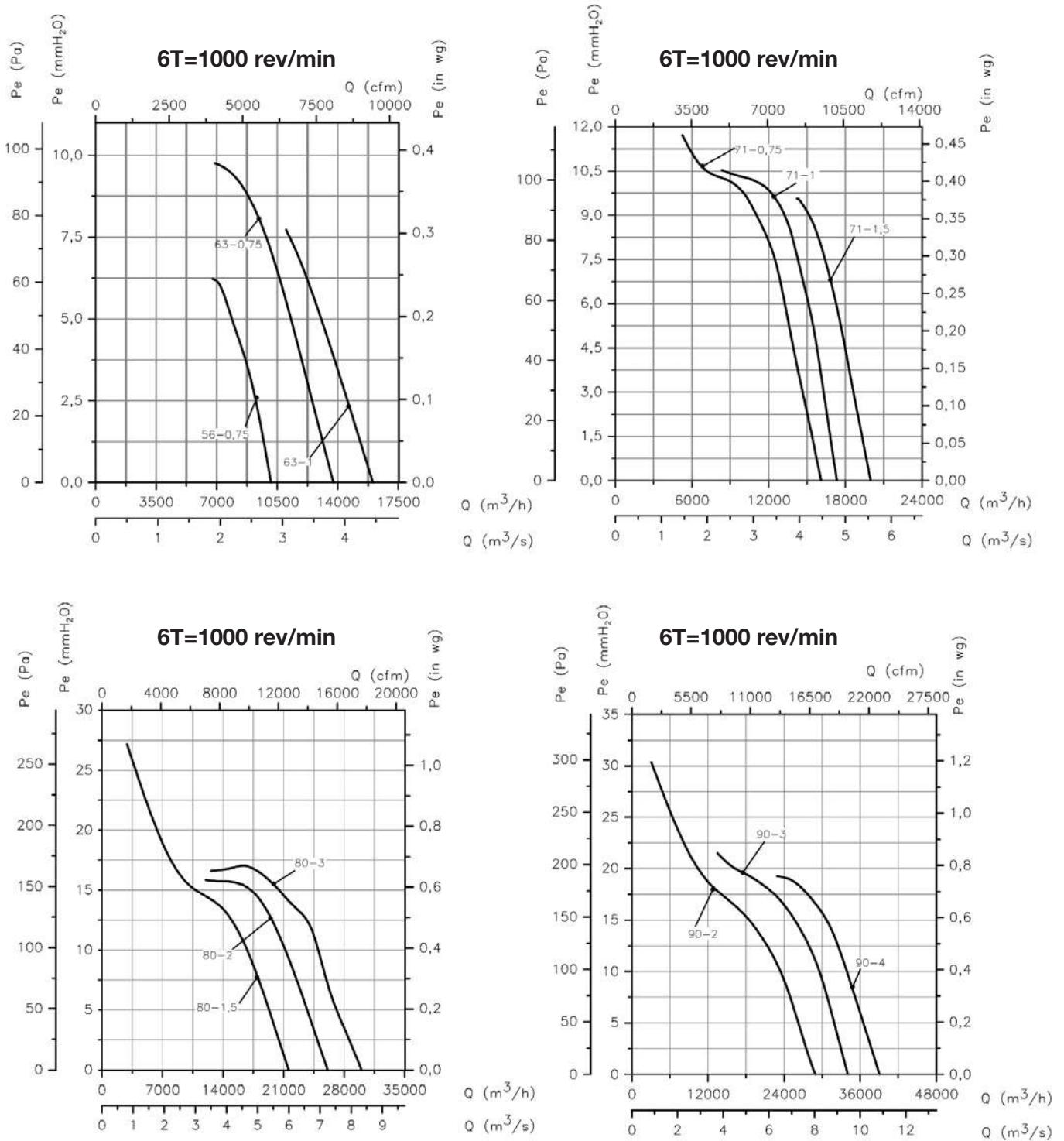

Curvas características

Q= Caudal en m³/h, m³/s y cfm. Pe= Presión estática en mmH²O, Pa e inwg.

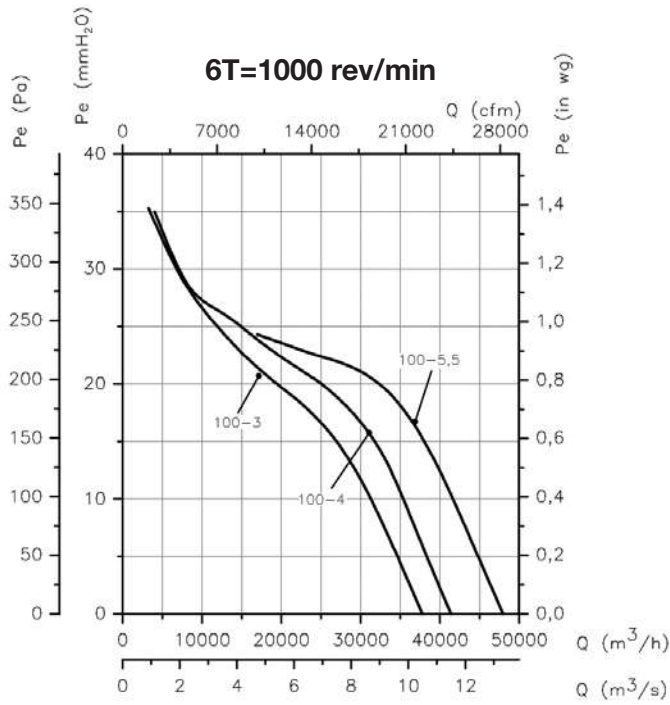

Accesorios

Ver apartado accesorios.



HTP



Hélice de alta presión

Extractores axiales tubulares de alta presión

Extractores axiales tubulares de alta presión y gran robustez, especialmente diseñados para instalaciones de minería o aplicaciones con grandes pérdidas de carga



Ventilador:

- Envoltorio tubular en chapa de acero de gran espesor
- Soporte de motor soldado al envoltorio.
- Directrices de alto rendimiento aerodinámico para ganancia de presión
- Óptima protección superficial mediante acero de alta calidad.
- Hélice de alto rendimiento, construida en fundición de aluminio
- Sentido de aire hélice-motor
- Conexión eléctrica en caja de bornes externa.

Motor:

- Motores de eficiencia IE2 para potencias iguales o superiores a 0,75kW e inferiores a 7,5kW, excepto monofásicos, 2 velocidades y 8 polos
- Motores de eficiencia IE3 para potencias iguales o superiores a 7,5kW, excepto monofásicos, 2 velocidades y 8 polos
- Motores clase F, con rodamientos a bolas, protección IP-55
- Trifásicos 230/400V-50Hz (hasta 4 kW) y 400/690V-50Hz (potencias superiores a 4 kW)
- Temperatura de trabajo -20°C + 70°C

Acabado:

- Acero de alta protección anticorrosivo, imprimación especial y pintura de alta calidad para ambientes corrosivos.

Bajo demanda:

- Motores normalizados IP-55, motores ATEX y de 2 Velocidades
- Construcción total en acero inoxidable
- Construcción en acero galvanizado en caliente
- Certificación ATEX Categoría 2
- Motores de eficiencias IE2 e IE3 para cualquier potencia



Código de pedido

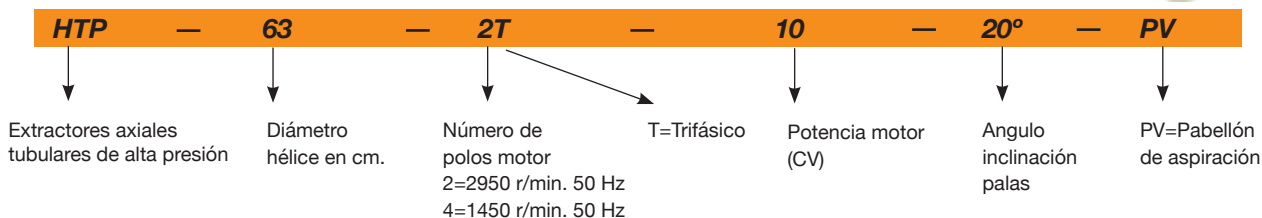

Características técnicas

Modelo	Velocidad (r/min)	Intensidad máxima admisible (A)			Potencia instalada (kW)	Caudal máximo (m³/h)	Peso aprox. (Kg)	NPS dB(A)	According ErP
		230V	400V	690V					
HTP-50-2T-4	2900	10,18	5,88	-	3,00	13850	49	82	2015
HTP-50-2T-5,5	2870	13,60	7,82	-	4,00	16450	65	83	*
HTP-56-2T-5,5	2870	13,60	7,82	-	4,00	18050	69	88	2015
HTP-56-2T-10 IE3	2930	-	14,10	8,17	7,50	25500	143	89	2015
HTP-63-2T-10 IE3	2930	-	14,10	8,17	7,50	23850	128	94	2015
HTP-63-2T-15 IE3	2945	-	20,00	11,60	11,00	29400	199	94	2015
HTP-63-2T-20 IE3	2945	-	27,70	16,10	15,00	34400	205	97	2015
HTP-63-2T-25 IE3	2945	-	33,90	19,70	18,50	37200	216	98	2015
HTP-63-2T-30 IE3	2950	-	39,70	23,00	22,00	39800	208	99	2015
HTP-63-4T-1,5	1400	4,03	2,32	-	1,10	12850	92	79	2015
HTP-63-4T-2	1430	5,96	3,44	-	1,50	15650	93	79	2015
HTP-63-4T-3	1445	8,36	4,83	-	2,20	18600	101	83	2015
HTP-63-4T-4	1445	10,96	6,33	-	3,00	19900	104	84	2015
HTP-71-2T-15 IE3	2945	-	20,00	11,60	11,00	32850	216	93	2015
HTP-71-2T-20 IE3	2945	-	27,70	16,10	15,00	39250	222	95	2015

Dimensiones mm

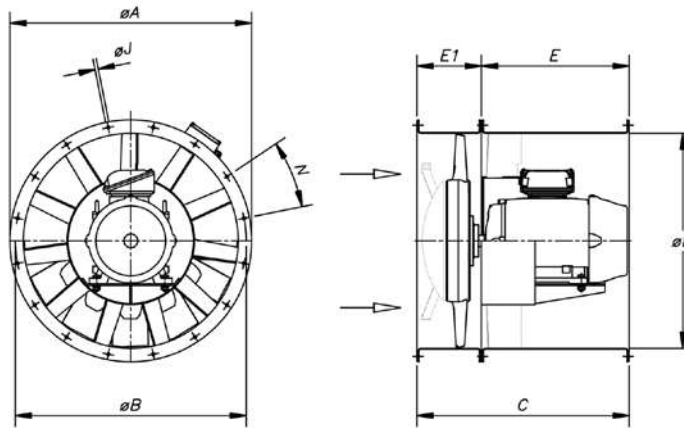

Modelo	Potencia	ØA	ØB	ØD	E	E1	C	ØJ	N
HTP-50-2T	4/5'5	600	560	514	-	-	400	12	12x30°
HTP-56-2T	5'5/10	660	620	560	-	-	500	12	12x30°
HTP-63-2T	10/15/20/25/30	730	690	640	650	220	870	13	12x30°
HTP-63-4T	1'5/2/3/4	730	690	640	340	220	560	13	12x30°
HTP-71-2T	15/20/25/30/40	810	770	710	700	240	940	13	16x22°30'
HTP-71-4T	2/3/4/5'5/7'5	810	770	710	420	240	660	13	16x22°30'
HTP-80-4T	4 / 5'5	900	860	800	360	240	600	15	16x22°30'
HTP-80-4T	7'5 / 10 / 15	900	860	800	600	240	840	15	16x22°30'
HTP-90-4T	7'5 / 10	1015	970	900	420	250	670	15	16x22°30'
HTP-90-4T	15 / 20 / 25 / 30	1015	970	900	650	250	900	15	16x22°30'
HTP-100-4T	15 / 20	1115	1070	1000	600	270	870	15	16x22°30'
HTP-100-4T	25 / 30 / 40	1115	1070	1000	700	270	970	15	16x22°30'
HTP-125	40 / 50 / 60 / 75	1365	1320	1250	900	300	1100	15	20x18°
HTP-125	100 / 125	1365	1320	1250	950	300	1250	15	20x18°

Accesorios

Ver apartado accesorios.



EJEMPLO SELECCIÓN

Curvas características

Q= Caudal en m³/h, m³/s y cfm.

Pe= Presión estática en mmH₂O, Pa e inwg.

HTP-63-4T

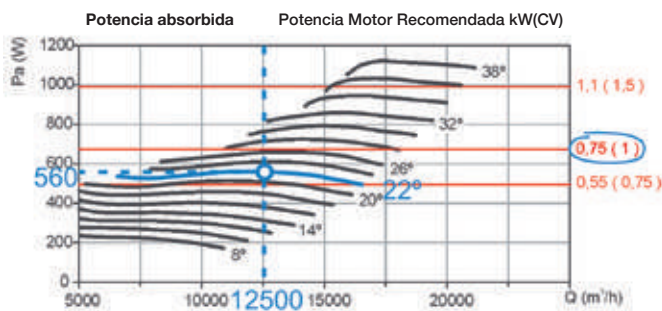
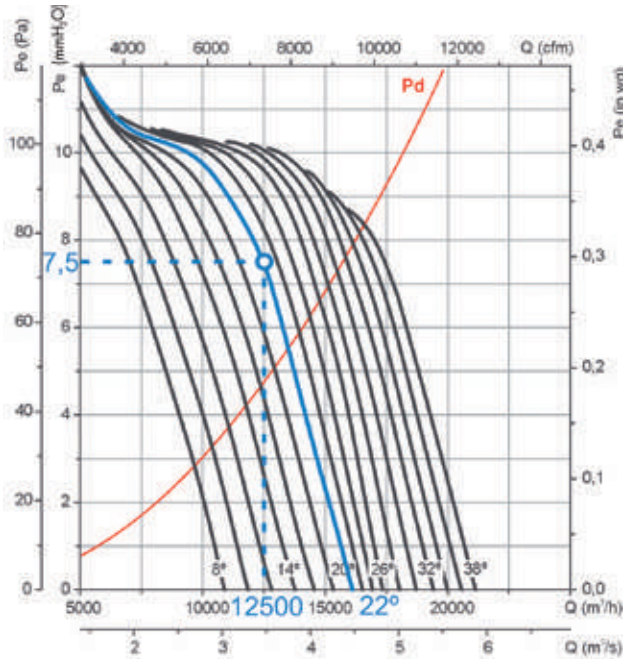

Datos de partida

- Punto de trabajo:
- Caudal: 12.500 m³/h
- Pérdida de carga: 7,5 mmH₂O

Pasos para la selección del equipo

En la gráfica de presiones:

1. Marcar el punto de trabajo, definido por el caudal de trabajo (12.500 m³/h) y la pérdida de carga (7,5 mmH₂O).
2. Escoger la curva del equipo que más se acerque por encima al punto de trabajo. En nuestro caso se obtiene una curva de 22° de ángulo de pala.

En la gráfica de potencia:

3. Marcar el punto de trabajo, definido por el caudal de trabajo (12.500 m³/h) y la curva de ángulo de pala escogido (22°).
4. Leer la potencia absorbida en el eje de potencias a la izquierda. La Pa= 560 W en el punto de trabajo.
5. Buscar recta roja que más se acerque al punto de trabajo por encima. En la parte derecha de la gráfica se obtiene el valor de potencia instalada de motor. En nuestro caso 0,75 kW o 1 CV

EJEMPLO CÓDIGO PEDIDO

HTP	—	63	—	4T	—	1	—	22°
↓		↓		↓		↓		↓
Extractores axiales tubulares de alta presión		Diámetro hélice en cm		Número de polos motor 4=1400 r/min. 50 Hz 6=900 r/min. 50 Hz 8=750 r/min. 50 Hz		Potencia motor (CV)		Angulo inclinación palas

Curvas características

Q= Caudal en m³/h, m³/s y cfm.

Pe= Presión estática en mmH₂O, Pa e inwg.

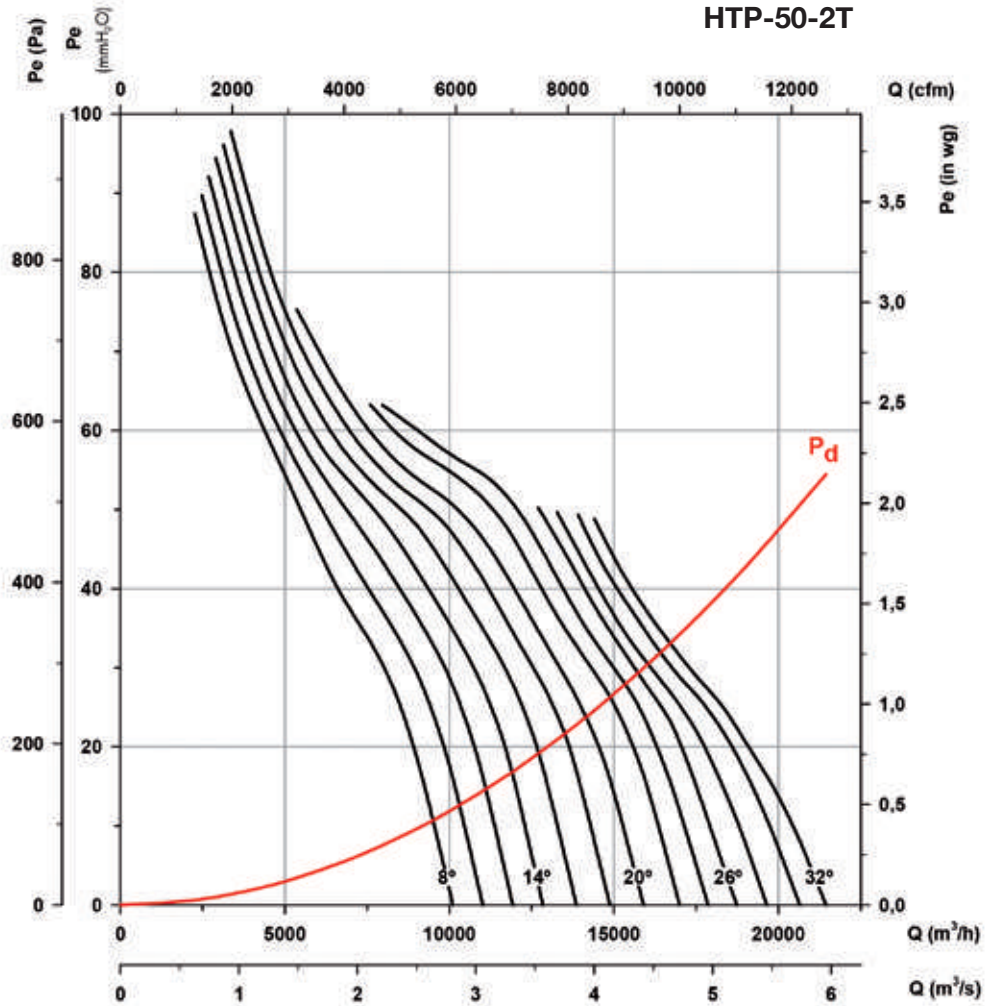

Potencia absorbida

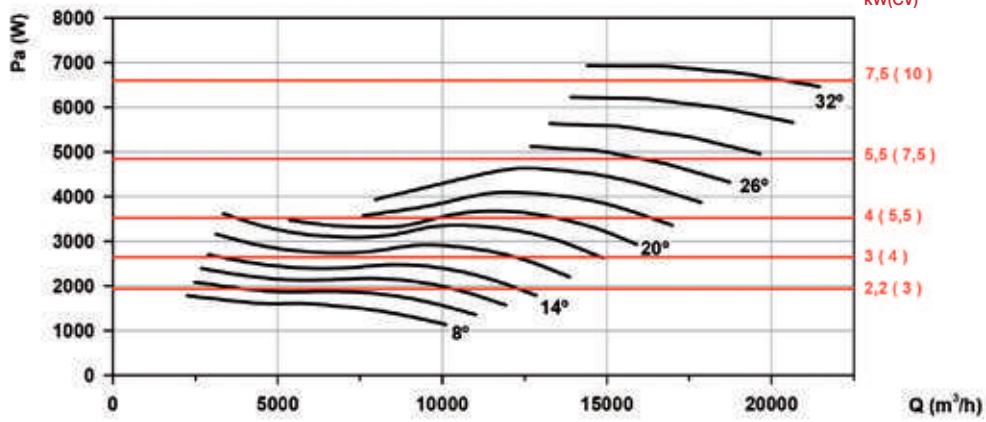

Curvas características

Q= Caudal en m³/h, m³/s y cfm.

Pe= Presión estática en mmH₂O, Pa e inwg.

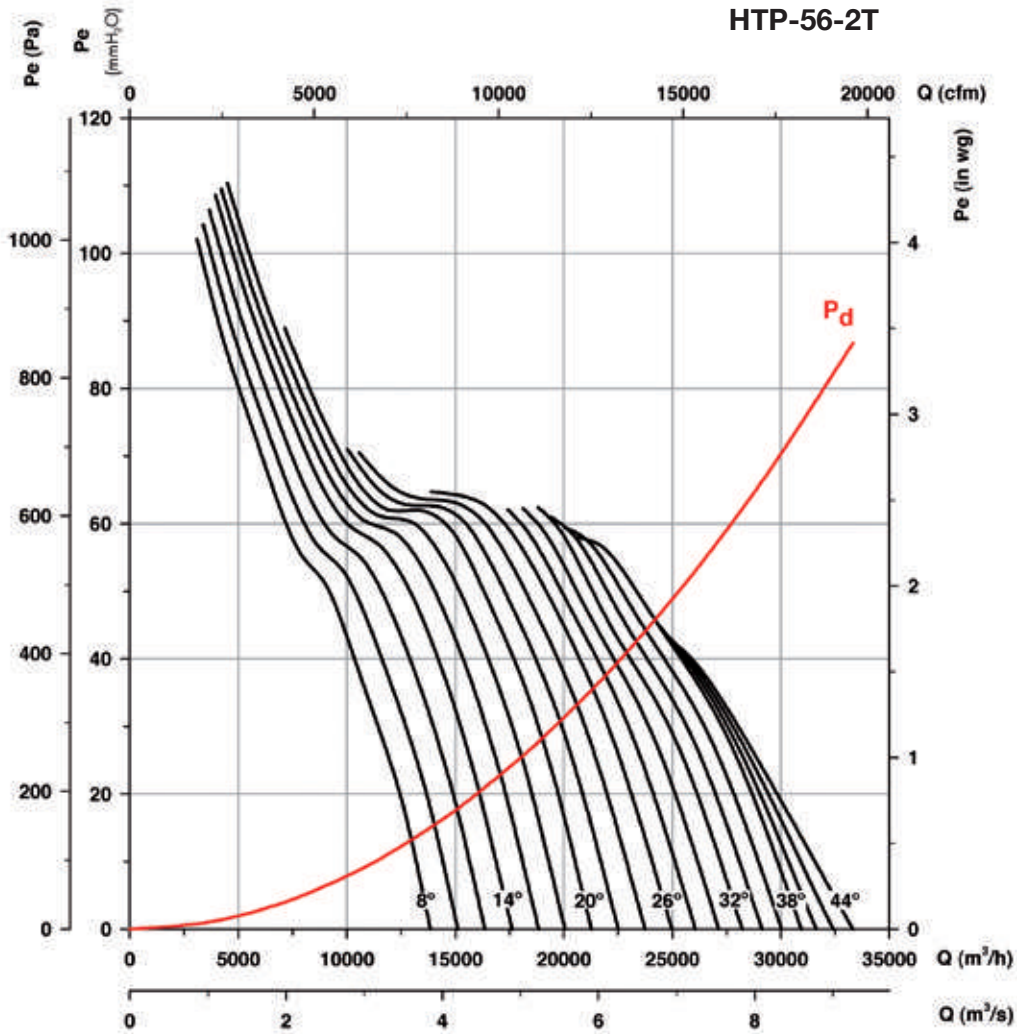

Potencia absorbida

Potencia Motor Recomendada kW(CV)

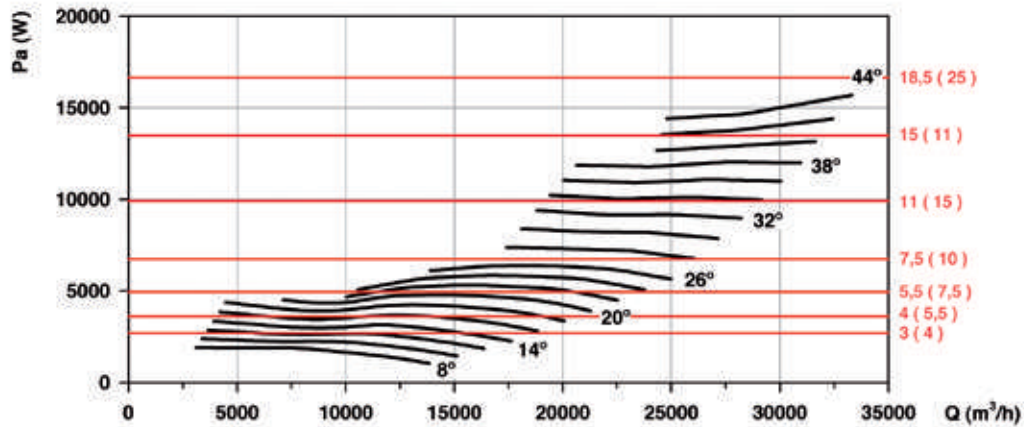

Curvas características

Q= Caudal en m³/h, m³/s y cfm.

Pe= Presión estática en mmH₂O, Pa e inwg.

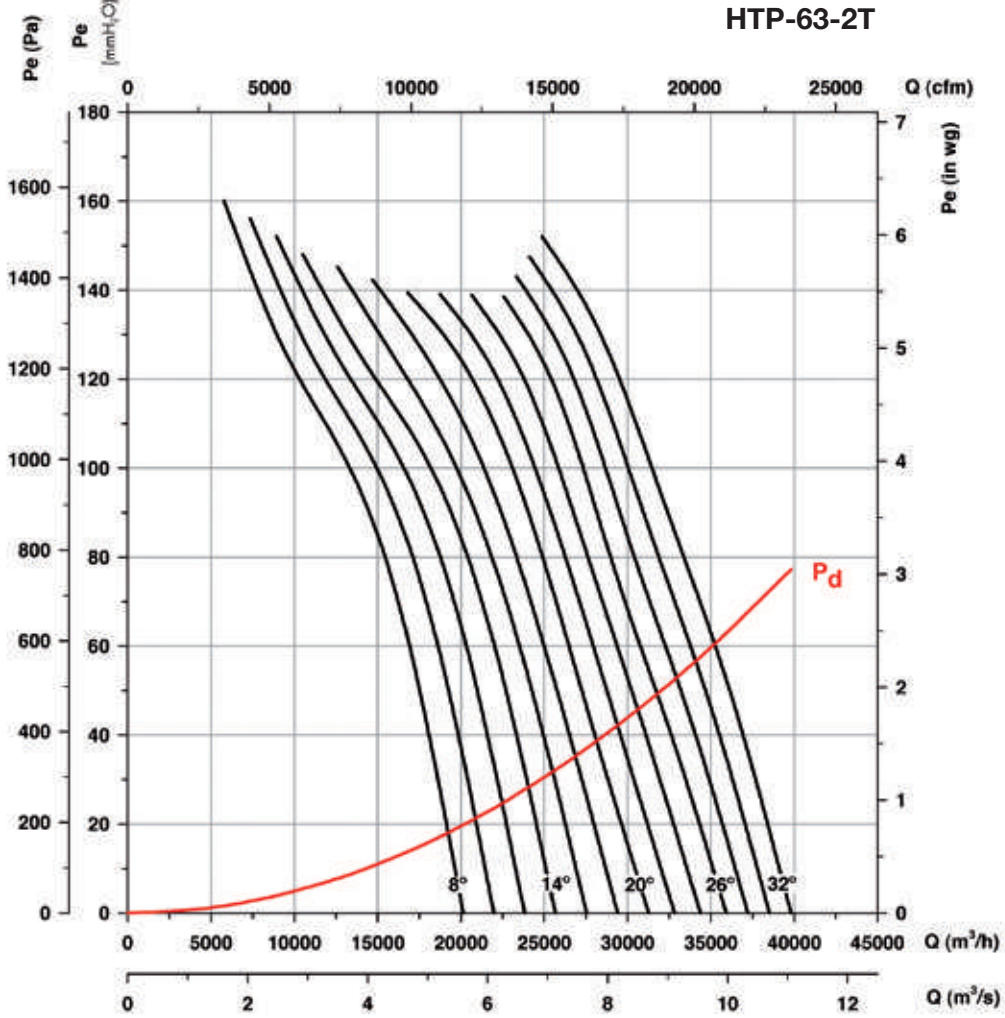

Potencia absorbida

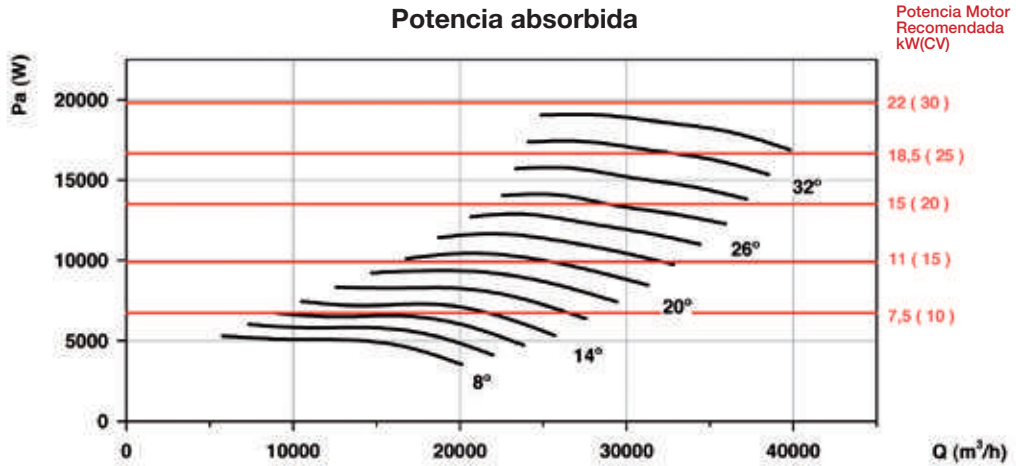

Curvas características

Q= Caudal en m³/h, m³/s y cfm.

Pe= Presión estática en mmH₂O, Pa e inwg.

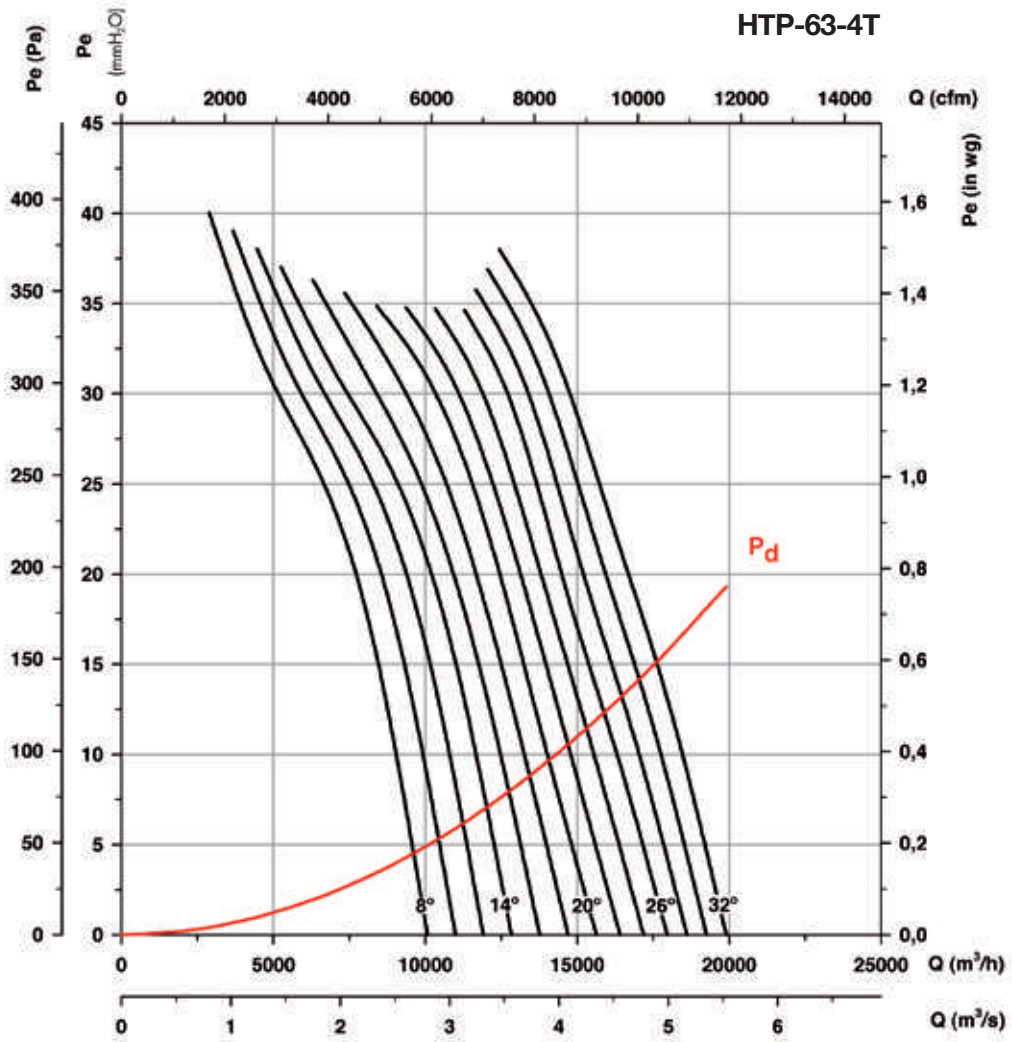

Potencia absorbida

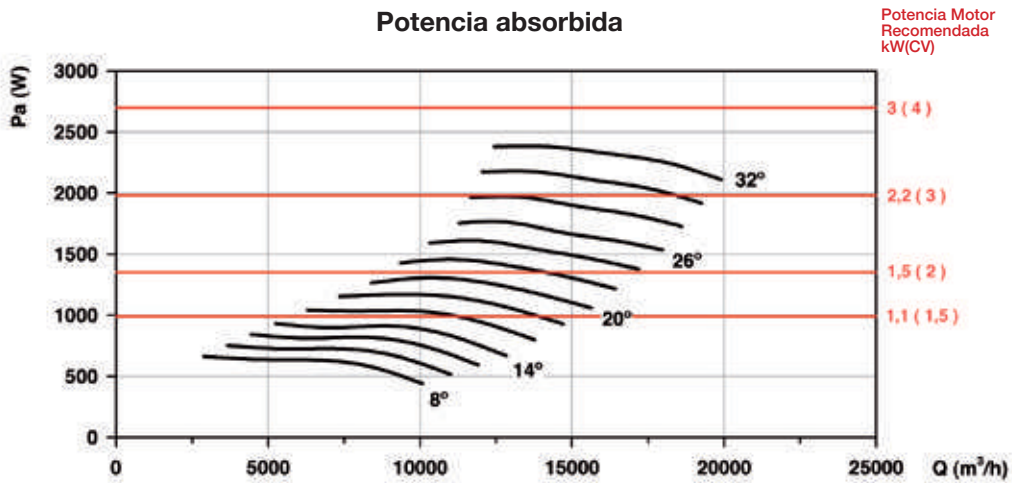

Potencia Motor Recomendada
KW(CV)

Curvas características

Q= Caudal en m³/h, m³/s y cfm.

Pe= Presión estática en mmH₂O, Pa e inwg.

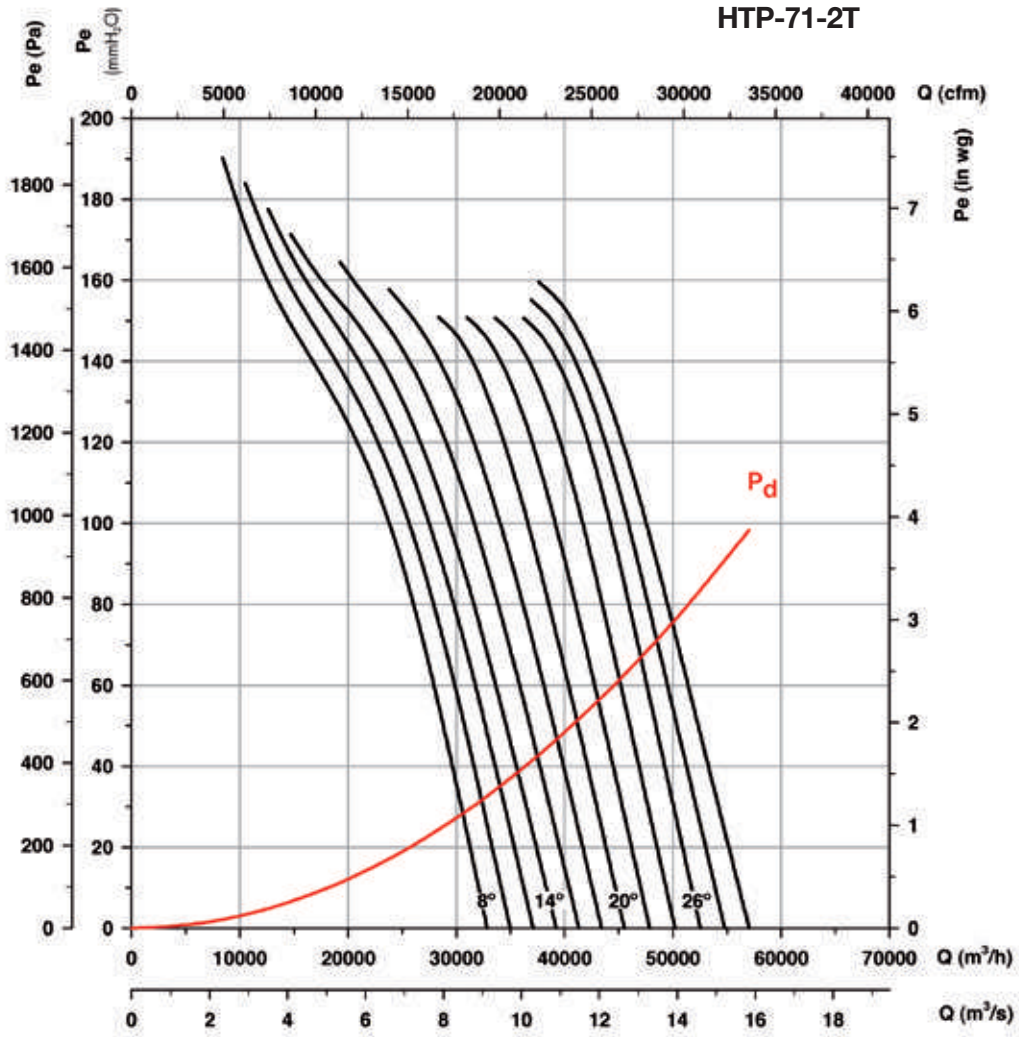

Potencia absorbida

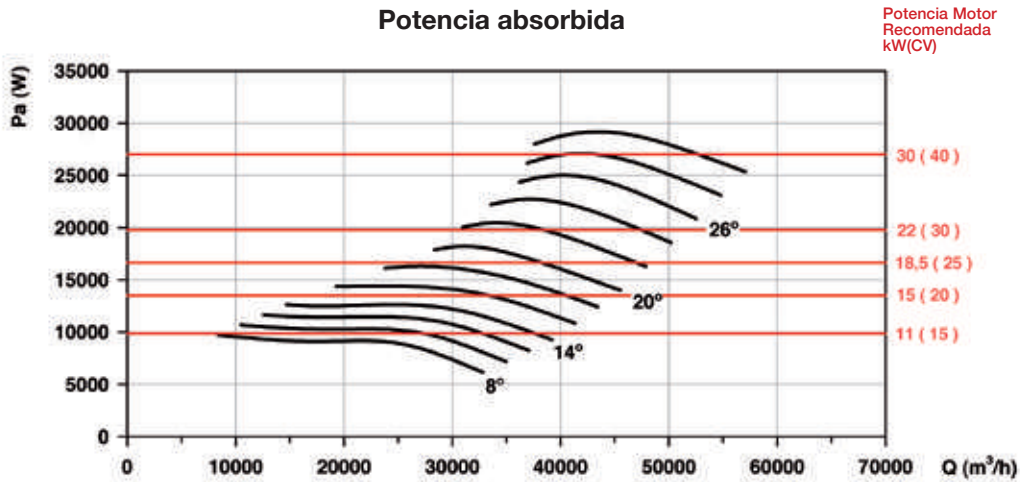

Curvas características

Q= Caudal en m³/h, m³/s y cfm.

Pe= Presión estática en mmH₂O, Pa e inwg.

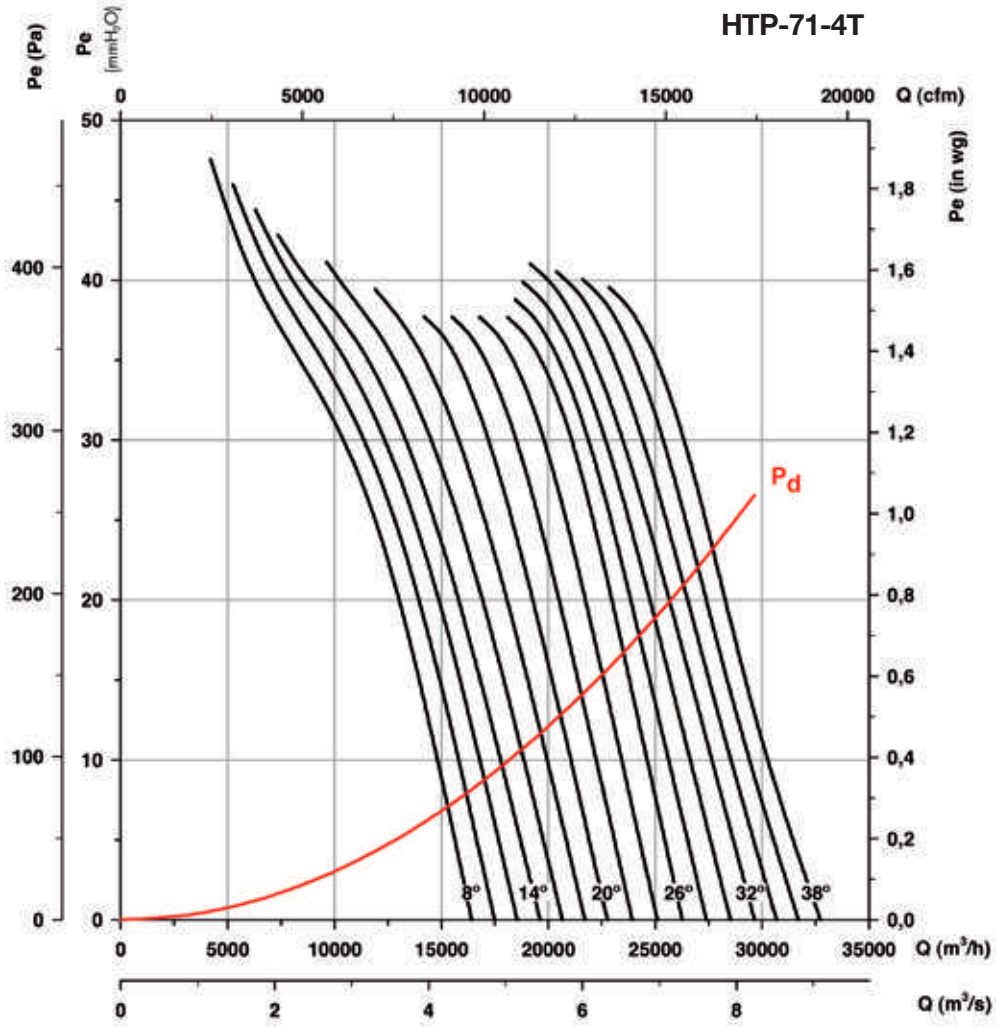

Potencia absorbida

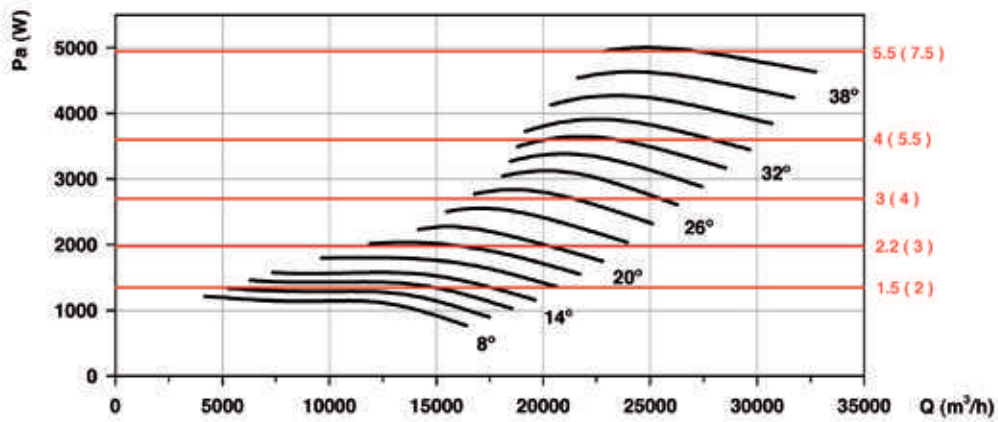

Potencia Motor Recomendada kW(CV)

Curvas características

Q= Caudal en m³/h, m³/s y cfm.

Pe= Presión estática en mmH₂O, Pa e inwg.

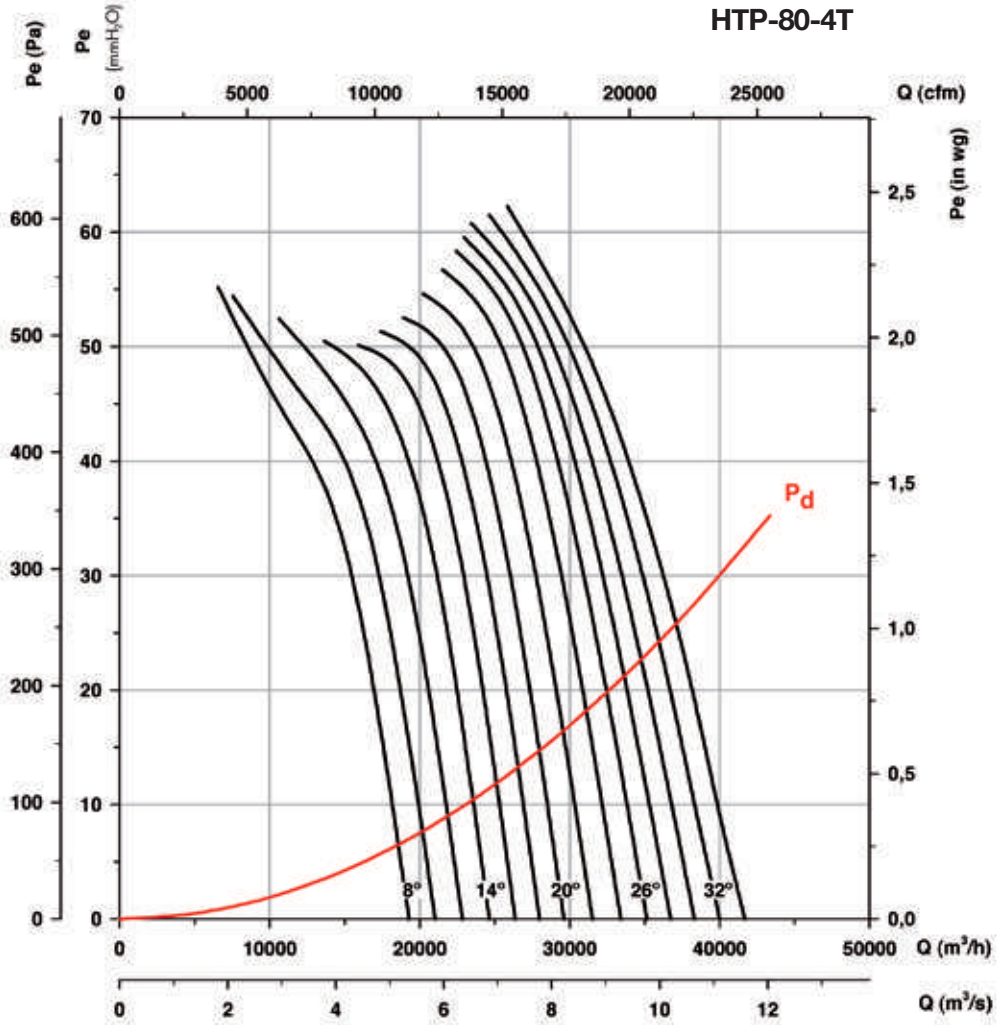

Potencia absorbida

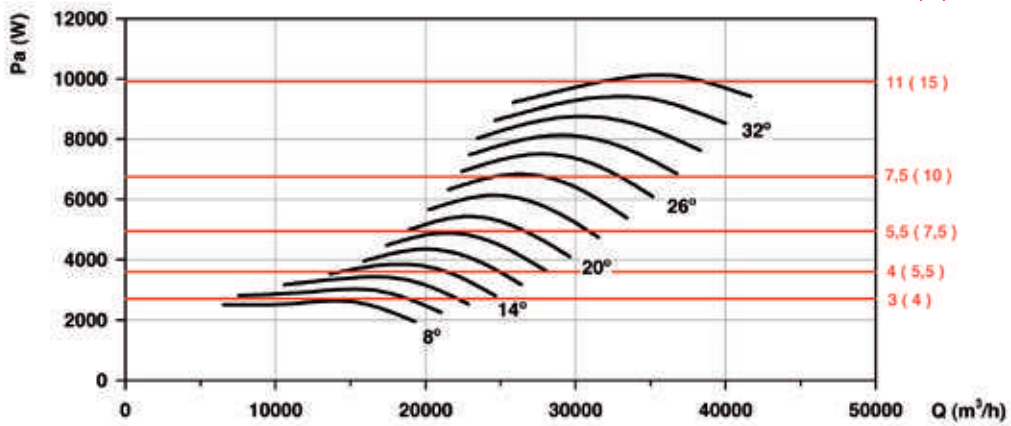

Potencia Motor Recomendada kW(CV)

Curvas características

Q= Caudal en m³/h, m³/s y cfm.

Pe= Presión estática en mmH₂O, Pa e inwg.

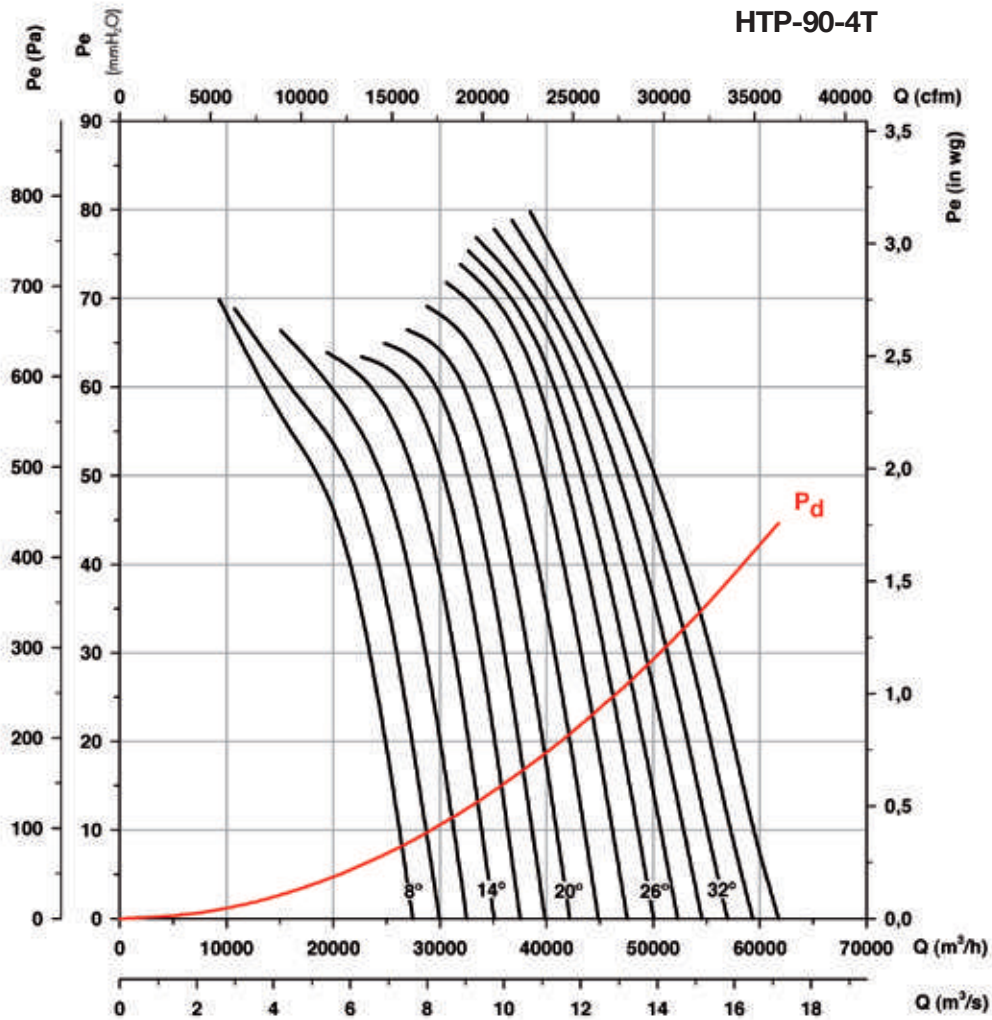

Potencia absorbida

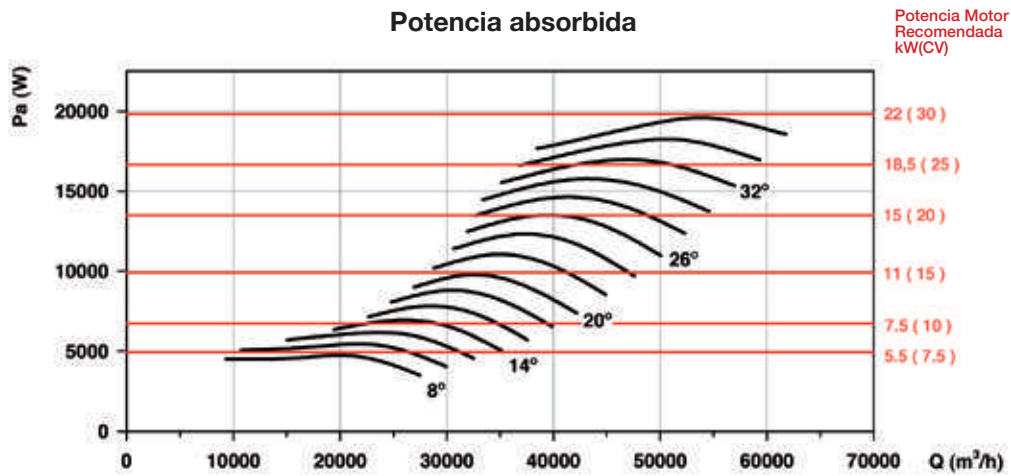

Curvas características

Q= Caudal en m³/h, m³/s y cfm.

Pe= Presión estática en mmH₂O, Pa e inwg.

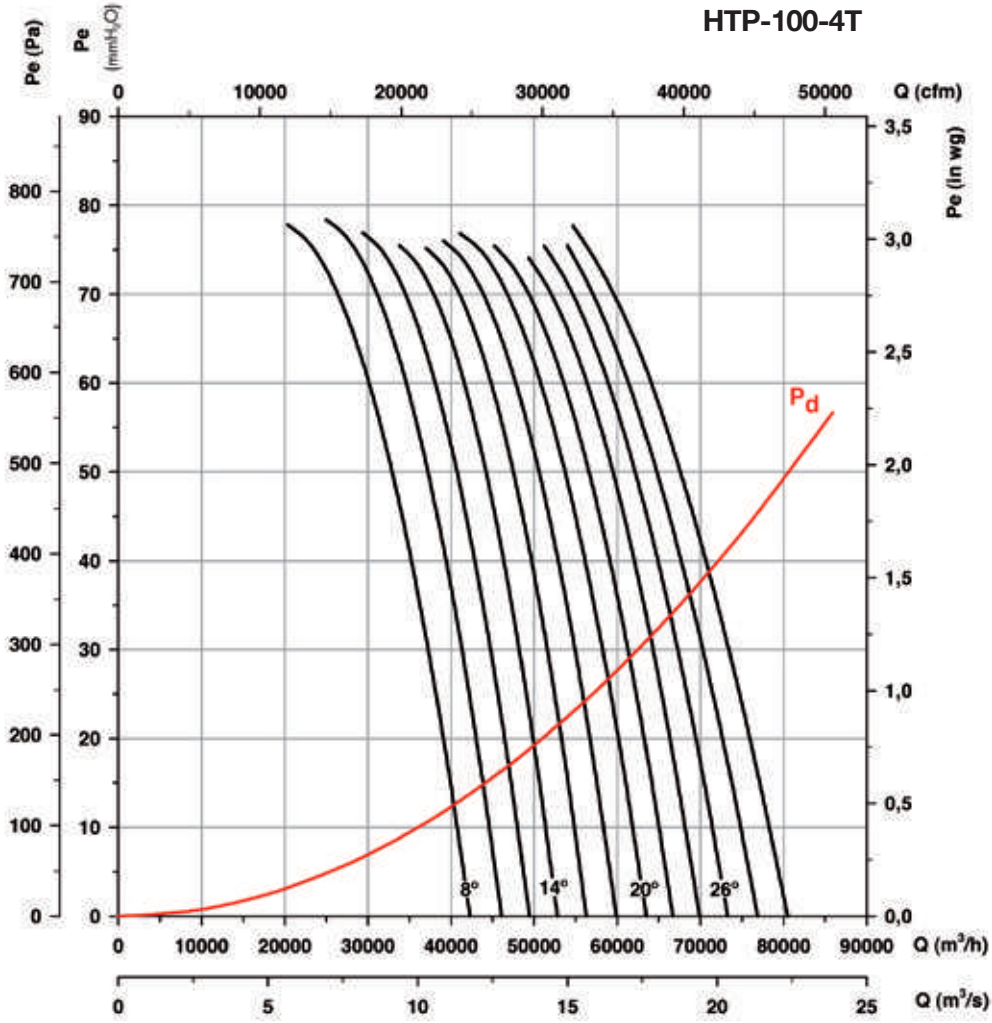

Potencia absorbida

Potencia Motor Recomendada kW(CV)

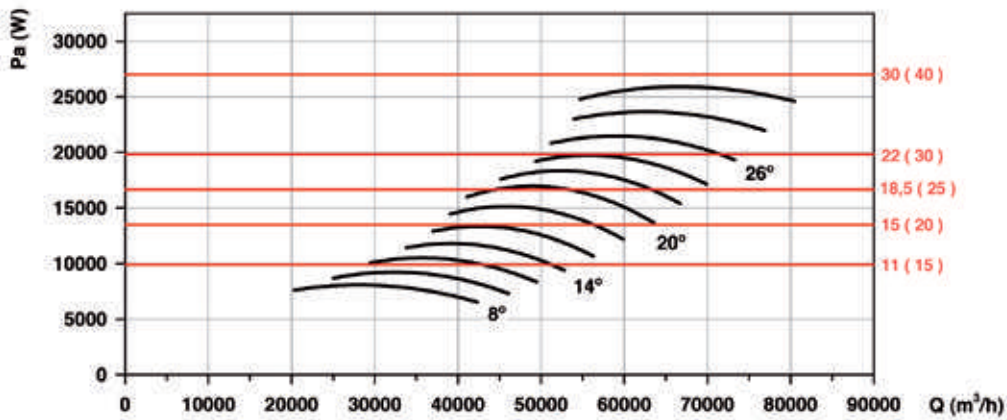

Curvas características

Q= Caudal en m³/h, m³/s y cfm.

Pe= Presión estática en mmH₂O, Pa e inwg.

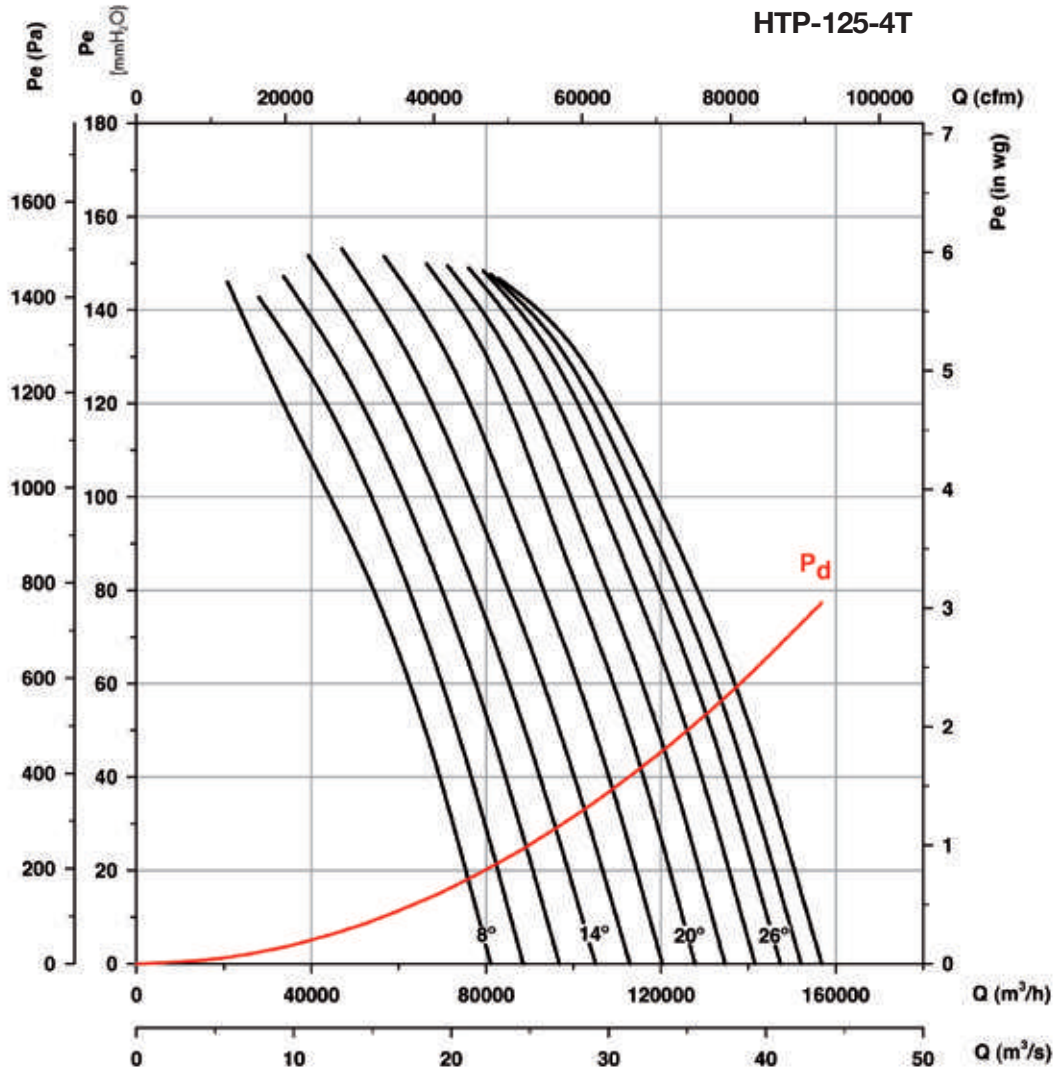

Potencia absorbida

Potencia Motor Recomendada kW(CV)

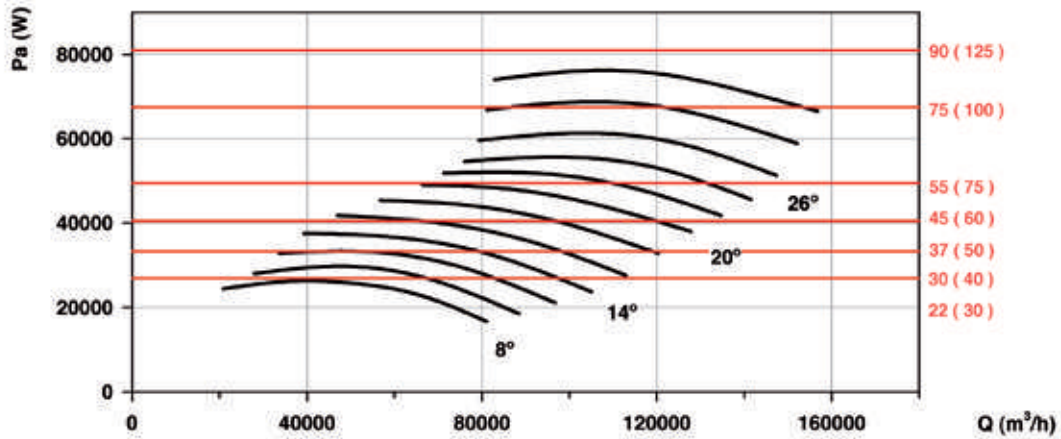

HBA



Ventiladores helicoidales tubulares bifurcados, con motor fuera del flujo de aire



Ventiladores tubulares bifurcados para trasegar aire hasta 150°C en continuo y hasta 200°C de forma esporádica.

Ventilador:

- Envoltente tubular en chapa de acero
- Hélice en fundición de aluminio
- Dirección de aire hélice-motor

Motor:

- Motores de eficiencia IE2 para potencias iguales o superiores a 0,75kW e inferiores a 7,5kW, excepto monofásicos, 2 velocidades y 8 polos
- Motores clase F, con rodamientos a bolas, protección IP-55
- Trifásicos 230/400V.-50Hz (hasta 4 kW) y 400/690V.-50Hz. (potencias superiores a 4 kW)
- Temperatura de trabajo: -25°C. + 150°C

Acabado:

- Anticorrosivo en resina de poliéster polimerizada a 190 °C, previo desengrase con tratamiento nanotecnológico libre de fosfatos.

Bajo demanda:

- Envoltente en acero inoxidable
- Acabado en galvanizado en caliente
- Bobinados especiales para diferentes tensiones y motores con PTC

Código de pedido

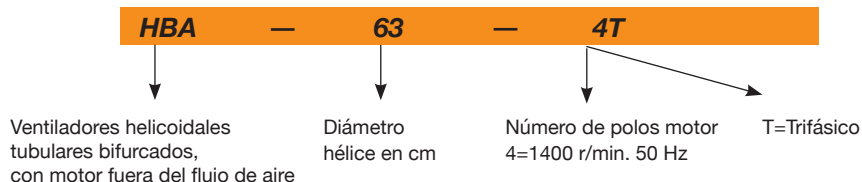

Características técnicas

Modelo	Velocidad (r/min)	Intensidad máxima admisible (A)		Potencia instalada (kW)	Caudal máximo (m³/h)	Nivel presión sonora dB(A)	Peso aprox. (Kg)
		230V	400V				
HBA-31-2T	2760	2,57	1,49	0,55	2900	77	25
HBA-31-2M	2810	3,49	-	0,55	2900	77	26
HBA-31-4T	1350	1,66	0,96	0,25	1600	66	24
HBA-31-4M	1370	2,00	-	0,25	1600	66	25
HBA-40-2T	2860	4,20	2,40	1,10	6200	82	45
HBA-40-2M	2820	6,51	-	1,10	6200	82	46
HBA-40-4T	1370	2,02	1,17	0,37	3200	75	40
HBA-45-2T	2900	10,18	5,88	3,00	8550	84	57
HBA-50-4T	1410	3,10	1,79	0,75	6750	76	73
HBA-63-4T	1400	4,03	2,32	1,10	11150	77	91
HBA-71-4T	1440	14,10	8,12	4,00	15850	79	164
HBA-71-6T	900	2,99	1,73	0,55	11200	74	140
HBA-80-6T	945	4,88	2,82	1,10	14900	77	190
HBA-100-6T	945	4,88	2,82	1,10	21700	80	260

Dimensiones mm

HBA-31...50

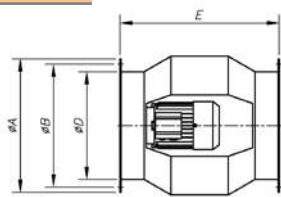

HBA-63...100

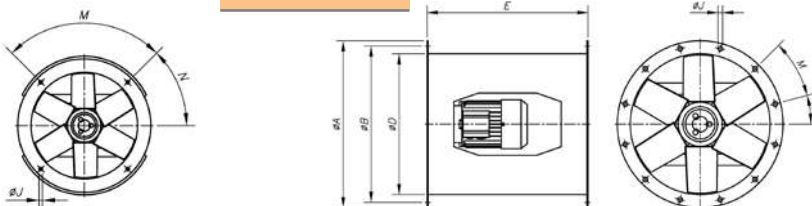

Modelo	ØA	ØB	ØD	E	ØJ	M	N
HBA-31	385	355	308	460	10	4x90°	45°
HBA-40	490	450	410	580	12	8x45°	22'5°
HBA-45	540	500	460	640	12	8x45°	22'5°
HBA-50	600	560	514	730	12	12x30°	15°
HBA-63	730	690	640	730	12	12x30°	15°
HBA-71	810	770	710	770	12	16x22'5°	11'25°
HBA-80	900	860	800	830	12	16x22'5°	11'25°
HBA-100	1115	1070	1000	1270	15	16x22'5°	11'25°

Curvas características

Q= Caudal en m³/h, m³/s y cfm.

Pe= Presión estática en mmH₂O, Pa e inwg.

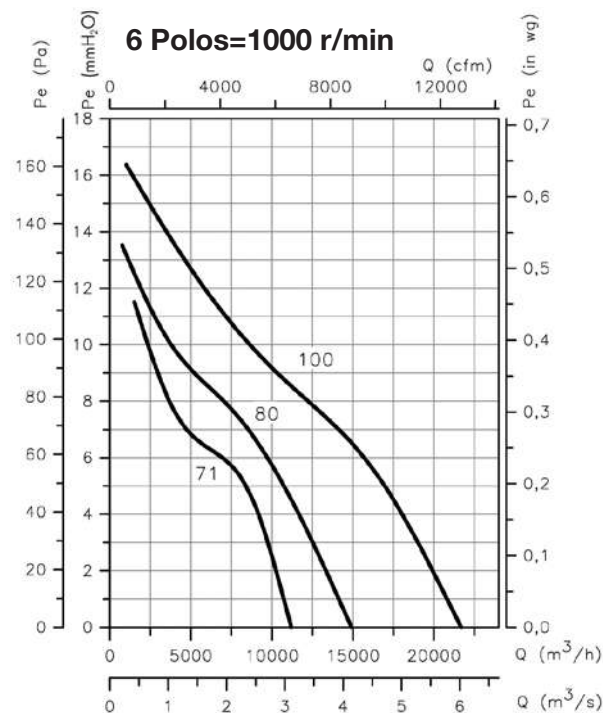
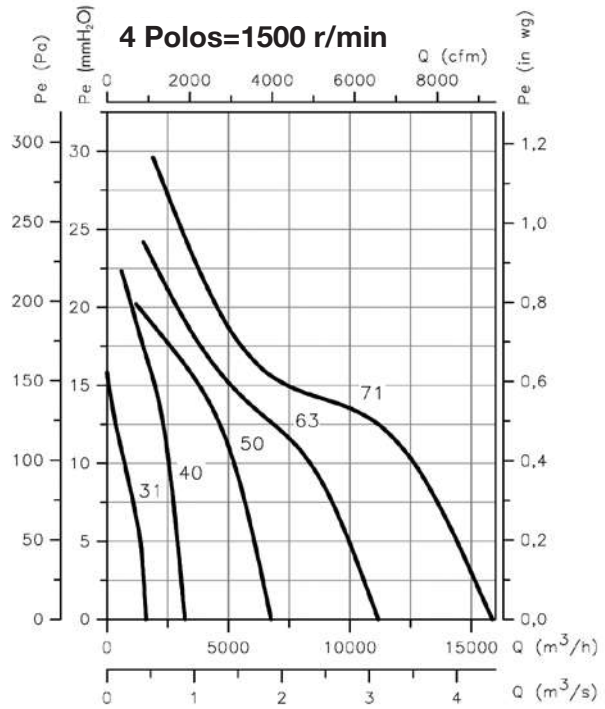
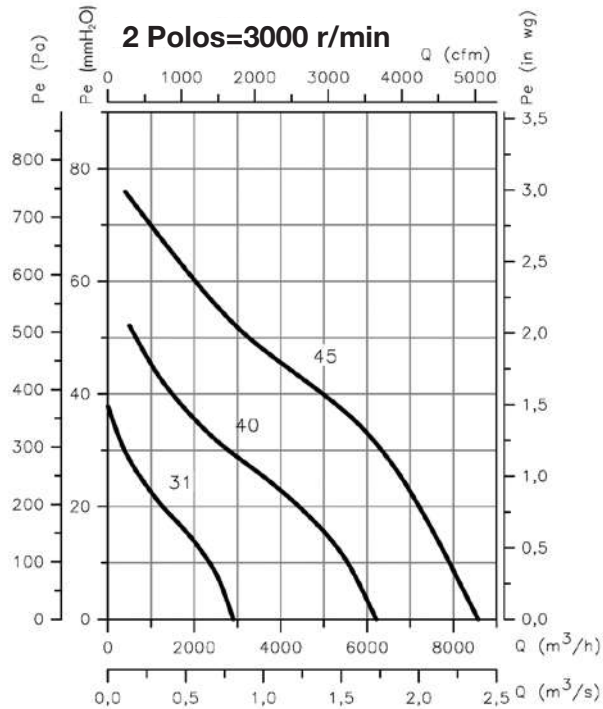

Accesorios

Ver apartado accesorios.



INT VSD3/A-RFT CUADROS RT BTUB BAC PS S
VSD1/A-RFM

HPX/SEC



Ventiladores diseñados con la mejor tecnología y experiencia para soportar las extremas condiciones de trabajo en hornos, secaderos y otras aplicaciones con temperatura y humedad



Ventilador:

- Envoltente tubular con tapa giratoria, en chapa de acero de gran grosor
- Hélices en fundición de aluminio
- Rodamientos de alta calidad, con grasa para altas temperaturas
- Soporte rodamientos con engrasadores
- Engrasadores externos en envoltente ventilador
- Dirección aire motor-hélice
- Temperatura del aire a transportar: -25°C+120°C

Motor:

- Motores de eficiencia IE3 para potencias iguales o superiores a 0,75kW, excepto monofásicos, 2 velocidades y 8 polos.
- Motores clase F, con rodamientos a bolas, protección IP55
- Monofásicos 230V-50Hz y trifásicos 230/400V-50Hz (hasta 4kW) y 400/690V-50Hz (potencias superiores a 4kW)

Acabado:

- Anticorrosivo en pintura anticatalítica

Bajo demanda:

- Dirección aire hélice-motor
- Hélices reversibles 100%
- Bobinados especiales para diferentes tensiones
- Certificación ATEX Categoría 2 (ver serie HPX/ATEX)

Código de pedido

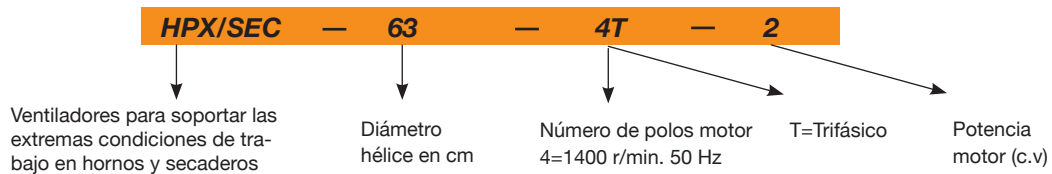

Características técnicas

Modelo	Velocidad (r/min)	Intensidad máxima admisible (A)			Potencia instalada (kW)	Ángulo inclinación palas (°)	Caudal máximo (m³/h)	Nivel presión sonora dB(A)	Peso aprox. (Kg)
		230V	400V	690V					
HPX/SEC-63-4T-1 IE3	1420	2,82	1,62	0,75	12	13800	73	61	
HPX/SEC-63-4T-1.5 IE3	1455	4,07	2,34	1,10	20	17800	74	66	
HPX/SEC-63-4T-2 IE3	1450	5,48	3,15	1,50	24	19300	75	69	
HPX/SEC-63-4T-3 IE3	1435	7,93	4,56	2,20	30	21700	76	78	
HPX/SEC-63-4T-4 IE3	1440	10,70	6,15	3,00	38	24250	77	84	
HPX/SEC-71-4T-1.5 IE3	1455	4,07	2,34	1,10	10	18100	78	81	
HPX/SEC-71-4T-2 IE3	1450	5,48	3,15	1,50	14	20900	79	85	
HPX/SEC-71-4T-3 IE3	1435	7,93	4,56	2,20	22	25100	81	93	
HPX/SEC-71-4T-4 IE3	1440	10,70	6,15	3,00	28	27500	82	99	
HPX/SEC-80-4T-3 IE3	1435	7,93	4,56	2,20	10	23200	82	106	
HPX/SEC-80-4T-4 IE3	1440	10,70	6,15	3,00	14	27900	83	112	
HPX/SEC-80-4T-5.5 IE3	1450	13,90	8,00	4,00	18	32750	84	118	
HPX/SEC-90-4T-4 IE3	1440	10,70	6,15	3,00	8	33600	87	123	
HPX/SEC-90-4T-5.5 IE3	1450	13,90	8,00	4,00	12	38900	89	129	
HPX/SEC-90-4T-7.5 IE3	1465	10,30	5,97	5,50	16	44150	91	154	
HPX/SEC-90-4T-10 IE3	1465	13,90	8,06	7,50	20	48600	92	163	
HPX/SEC-100-4T-7.5 IE3	1465	10,30	5,97	5,50	10	46850	92	164	
HPX/SEC-100-4T-10 IE3	1465	13,90	8,06	7,50	14	54900	93	173	
HPX/SEC-100-4T-15 IE3	1470	21,40	12,40	11,00	20	63200	94	218	
HPX/SEC-100-4T-20 IE3	1465	28,70	16,60	15,00	26	73200	95	220	

Características acústicas

Los valores indicados, se determinan mediante medidas de nivel de presión y potencia sonora en dB(A) obtenidas en campo libre a una distancia equivalente a dos veces la envergadura del ventilador más el diámetro de la hélice, con un mínimo de 1,5 mts.

Espectro de potencia sonora Lw(A) en dB(A) banda de frecuencia en [Hz]

Modelo	63	125	250	500	1000	2000	4000	8000	Modelo	63	125	250	500	1000	2000	4000	8000
HPX/SEC-63-4T-1 IE3	50	70	78	83	85	82	75	64	HPX/SEC-80-4T-4 IE3	56	76	84	89	91	88	81	74
HPX/SEC-63-4T-1.5 IE3	48	68	76	81	83	80	73	65	HPX/SEC-80-4T-5.5 IE3	56	76	84	89	91	88	81	70
HPX/SEC-63-4T-2 IE3	52	68	76	81	83	80	73	66	HPX/SEC-90-4T-4 IE3	61	82	89	94	97	93	86	79
HPX/SEC-63-4T-3 IE3	53	70	78	83	85	82	77	67	HPX/SEC-90-4T-5.5 IE3	60	81	88	93	96	92	85	74
HPX/SEC-63-4T-4 IE3	54	71	79	84	86	83	78	68	HPX/SEC-90-4T-7.5 IE3	59	80	87	92	95	91	84	73
HPX/SEC-71-4T-1.5 IE3	54	74	82	87	89	86	79	69	HPX/SEC-90-4T-10 IE3	58	79	86	91	94	90	83	72
HPX/SEC-71-4T-2 IE3	53	73	81	86	88	85	78	70	HPX/SEC-100-4T-7.5 IE3	64	84	92	97	99	96	89	78
HPX/SEC-71-4T-3 IE3	58	72	80	85	87	84	77	71	HPX/SEC-100-4T-10 IE3	62	82	90	95	97	94	87	76
HPX/SEC-71-4T-4 IE3	59	73	81	86	88	85	78	72	HPX/SEC-100-4T-15 IE3	61	81	89	94	96	93	86	75
HPX/SEC-80-4T-3 IE3	57	77	85	90	92	89	82	73	HPX/SEC-100-4T-20 IE3	63	83	91	96	98	95	88	77

Dimensiones mm

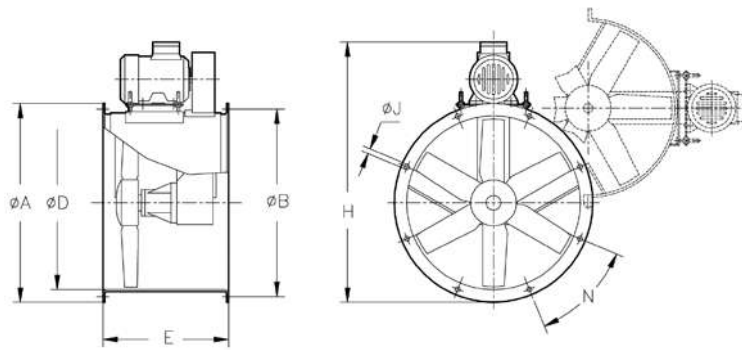

Modelo	ØA	ØB	ØD	E	H	ØJ	N
HPX/SEC-63-4T-1 IE3	730	690	640	500	915	12	12x30°
HPX/SEC-63-4T-1.5 IE3	730	690	640	500	943	12	12x30°
HPX/SEC-63-4T-2 IE3	730	690	640	500	943	12	12x30°
HPX/SEC-63-4T-3 IE3	730	690	640	500	963	12	12x30°
HPX/SEC-63-4T-4 IE3	730	690	640	500	963	12	12x30°
HPX/SEC-71-4T-1.5 IE3	810	770	710	550	1022	12	16x22°30'
HPX/SEC-71-4T-2 IE3	810	770	710	550	1022	12	16x22°30'
HPX/SEC-71-4T-3 IE3	810	770	710	550	1048	12	16x22°30'
HPX/SEC-71-4T-4 IE3	810	770	710	550	1048	12	16x22°30'
HPX/SEC-80-4T-3 IE3	900	860	800	600	1165	12	16x22°30'
HPX/SEC-80-4T-4 IE3	900	860	800	600	1165	12	16x22°30'
HPX/SEC-80-4T-5.5 IE3	900	860	800	600	1186	12	16x22°30'
HPX/SEC-90-4T-4 IE3	1015	970	900	650	1255	15	16x22°30'
HPX/SEC-90-4T-5.5 IE3	1015	970	900	650	1292	15	16x22°30'
HPX/SEC-90-4T-7.5 IE3	1015	970	900	650	1338	15	16x22°30'
HPX/SEC-90-4T-10 IE3	1015	970	900	650	1338	15	16x22°30'
HPX/SEC-100-4T-7.5 IE3	1115	1070	1000	750	1453	15	16x22°30'
HPX/SEC-100-4T-10 IE3	1115	1070	1000	750	1453	15	16x22°30'
HPX/SEC-100-4T-15 IE3	1115	1070	1000	750	1525	15	16x22°30'
HPX/SEC-100-4T-20 IE3	1115	1070	1000	750	1525	15	16x22°30'

Accesorios

Ver apartado accesorios.



INT VSD3/A-RFT VSD1/A-RFM CUADROS RT BTUB BAC PS S



Curvas características

Q= Caudal en m³/h, m³/s y cfm. Pe= Presión estática en mmH₂O, Pa e inwg.

Diámetro Hélice (cm): 63

Número de polos: 6

Número de palas: 4

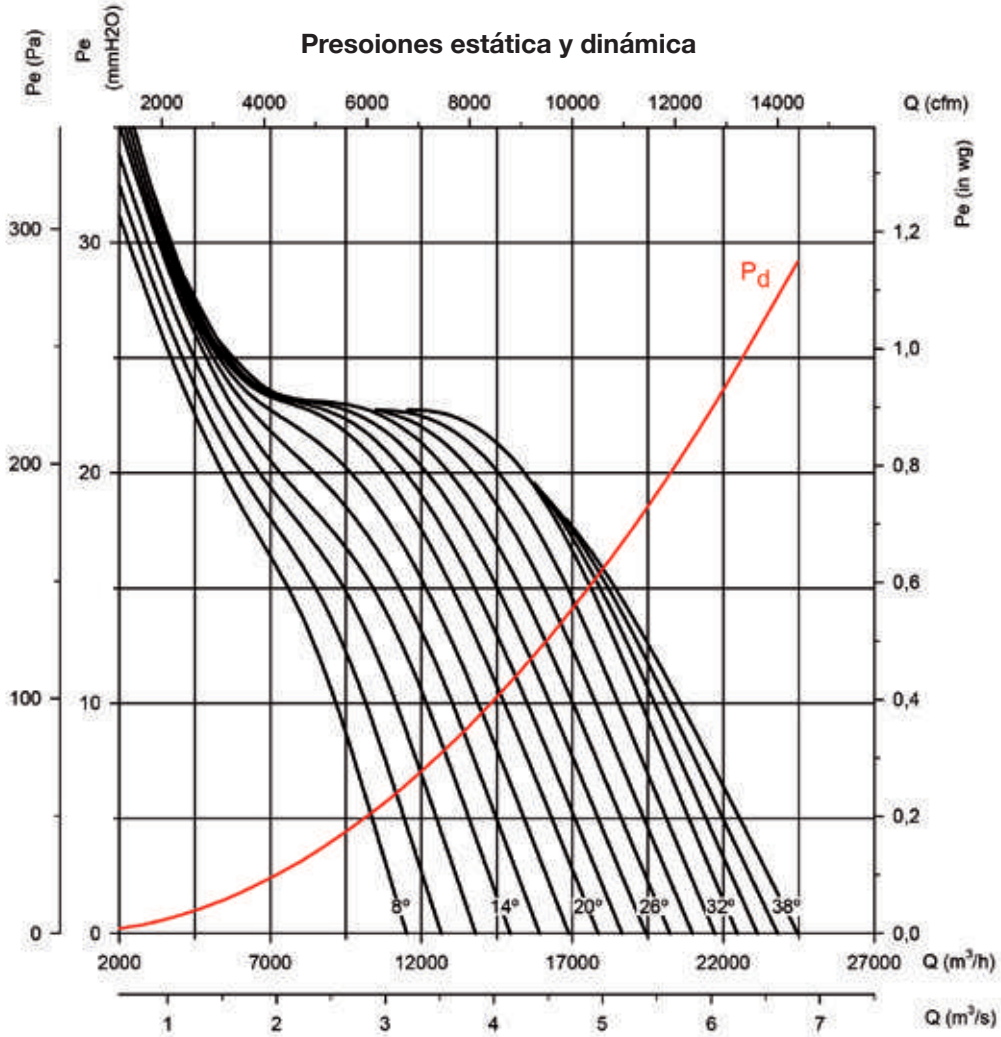

Potencia absorbida

Potencia Motor Recomendada kW(CV)

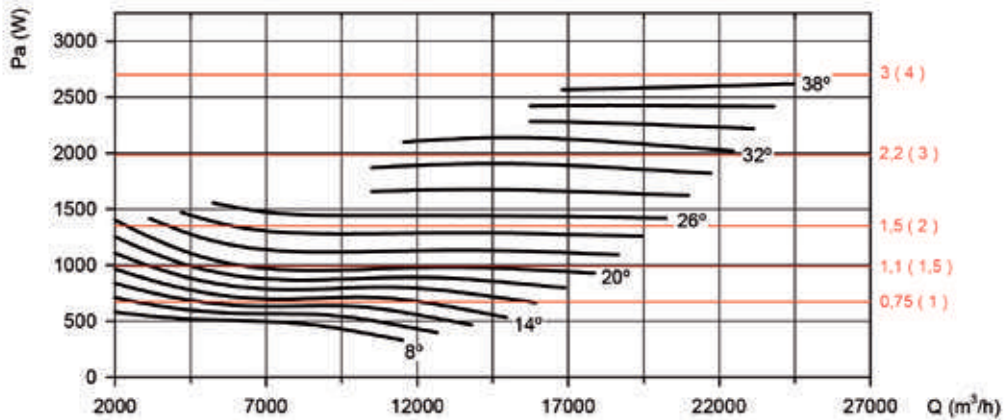

Curvas características

Q= Caudal en m³/h, m³/s y cfm. Pe= Presión estática en mmH₂O, Pa e inwg.

Diámetro Hélice (cm): 71

Número de polos: 6

Número de palas: 4

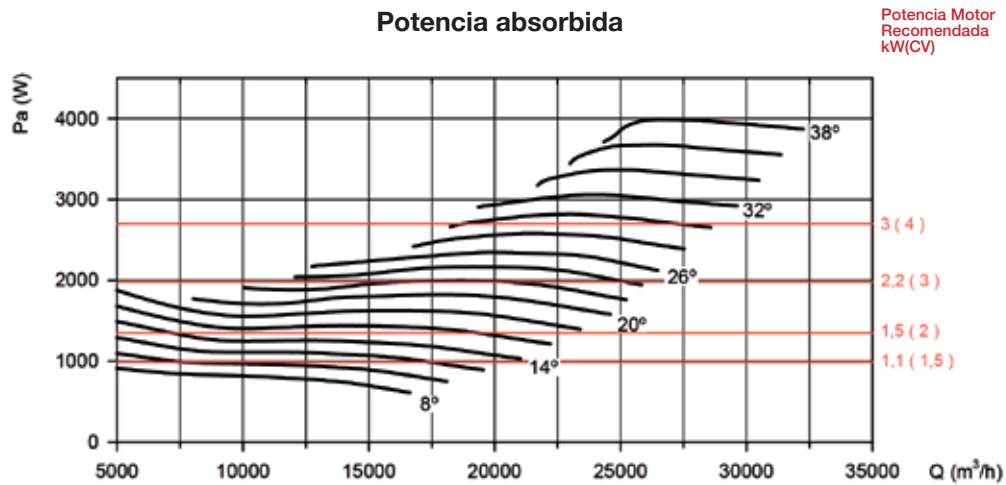
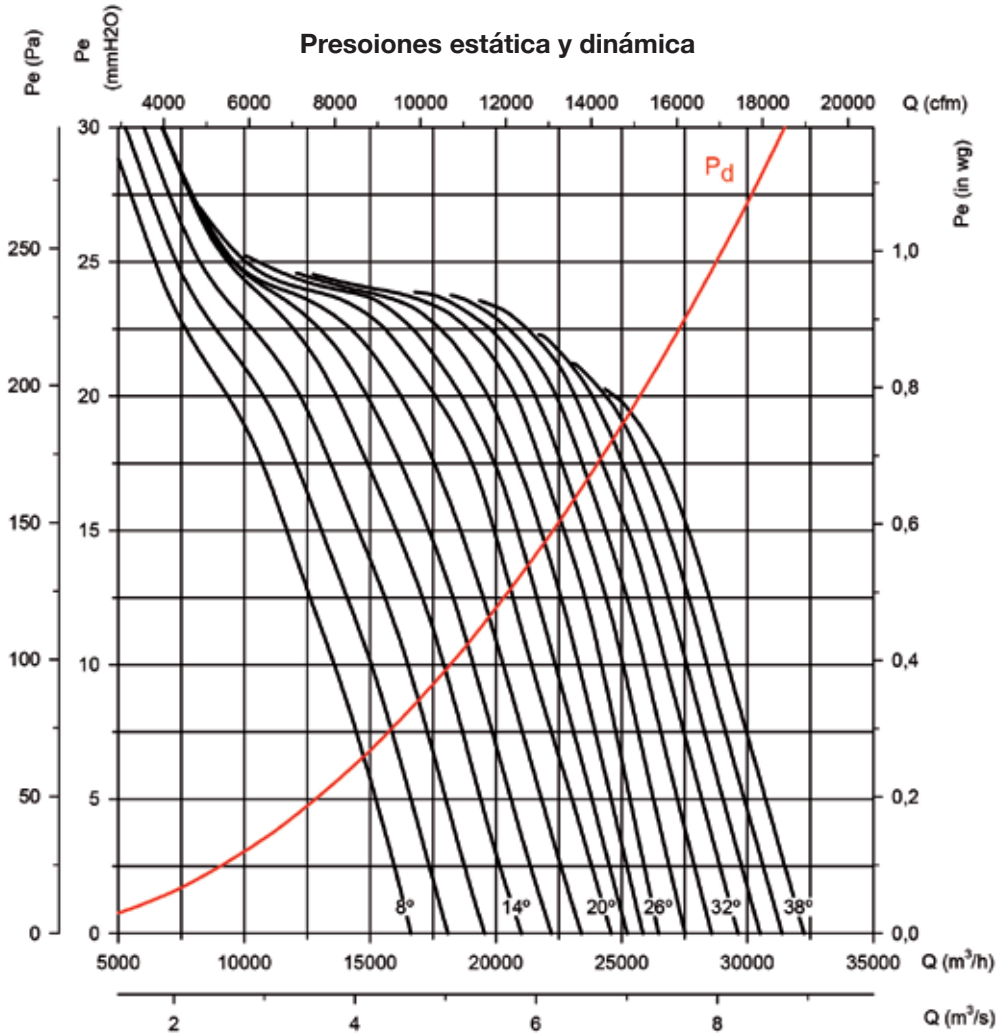



Curvas características

Q= Caudal en m³/h, m³/s y cfm. Pe= Presión estática en mmH₂O, Pa e inwg.

Diámetro Hélice (cm): 80

Número de polos: 6

Número de palas: 4

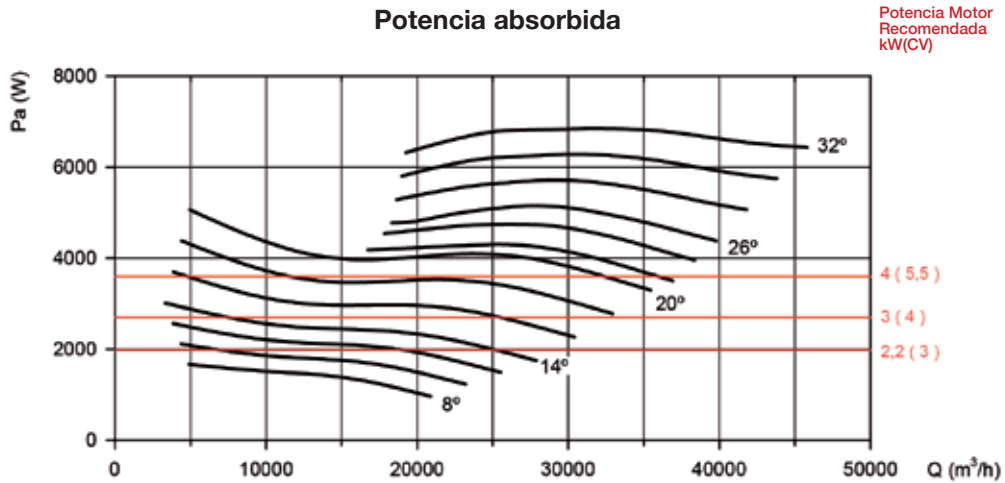
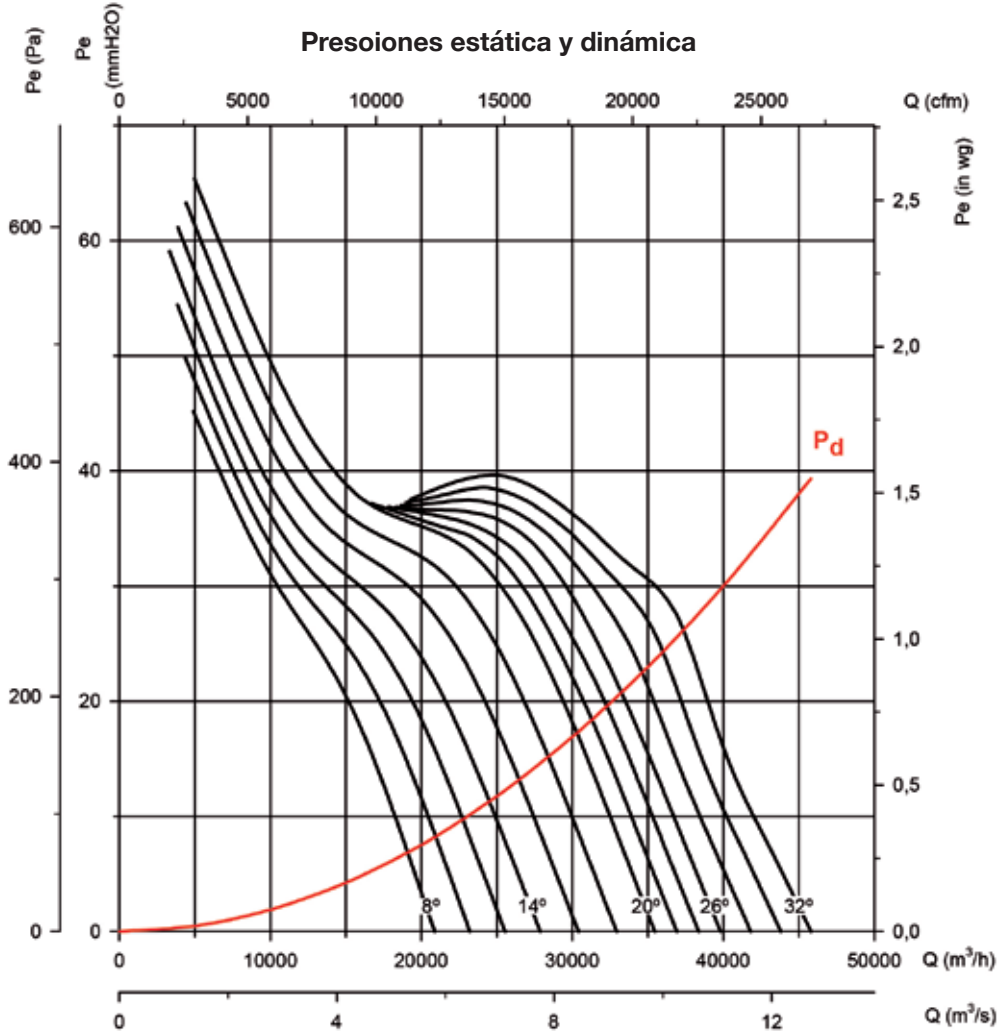

Curvas características

Q= Caudal en m³/h, m³/s y cfm. Pe= Presión estática en mmH₂O, Pa e inwg.

Diámetro Hélice (cm): 90

Número de polos: 6

Número de palas: 4

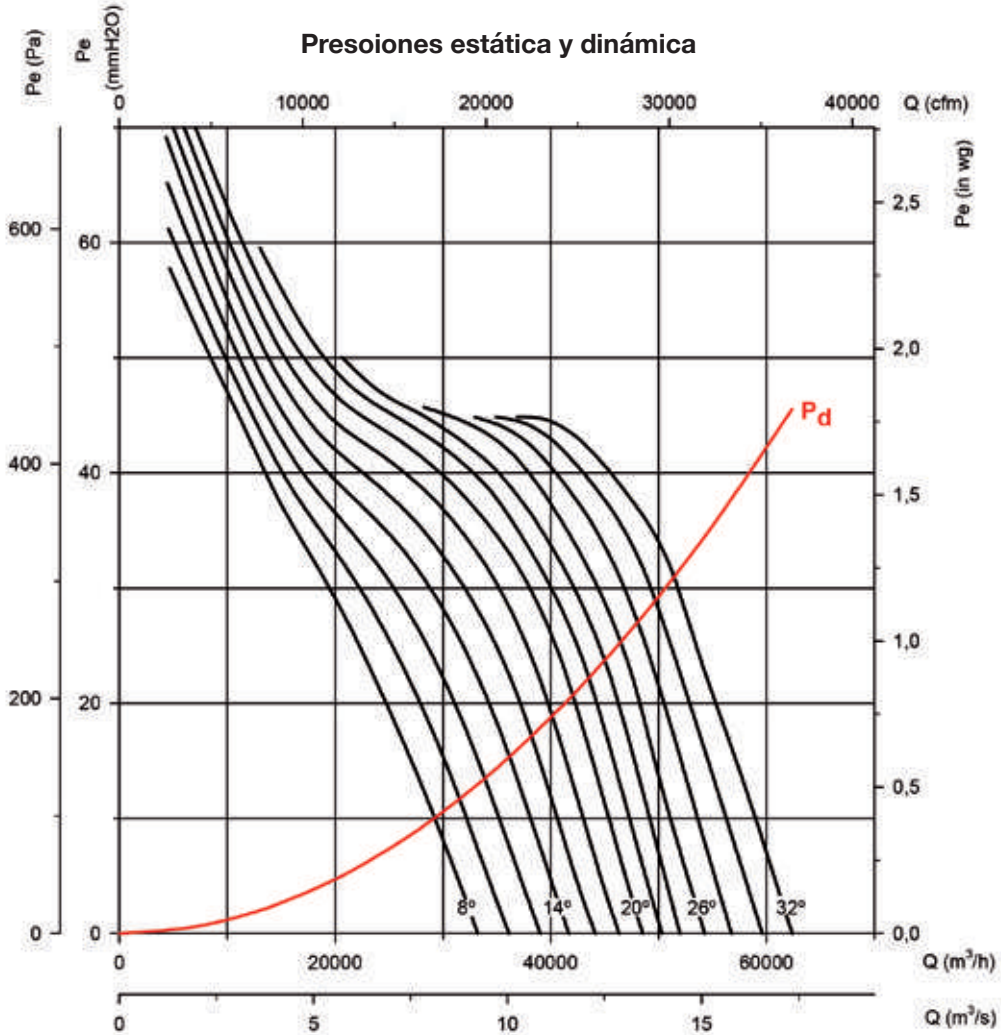

Potencia absorbida

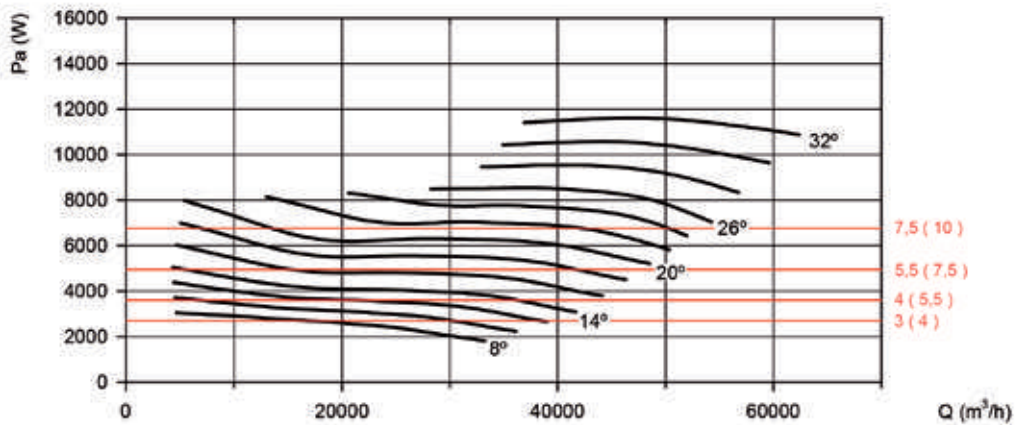

Potencia Motor Recomendada kW(CV)

Curvas características

Q= Caudal en m³/h, m³/s y cfm. Pe= Presión estática en mmH₂O, Pa e inwg.

Diámetro Hélice (cm): 100 Número de polos: 6 Número de palas: 4

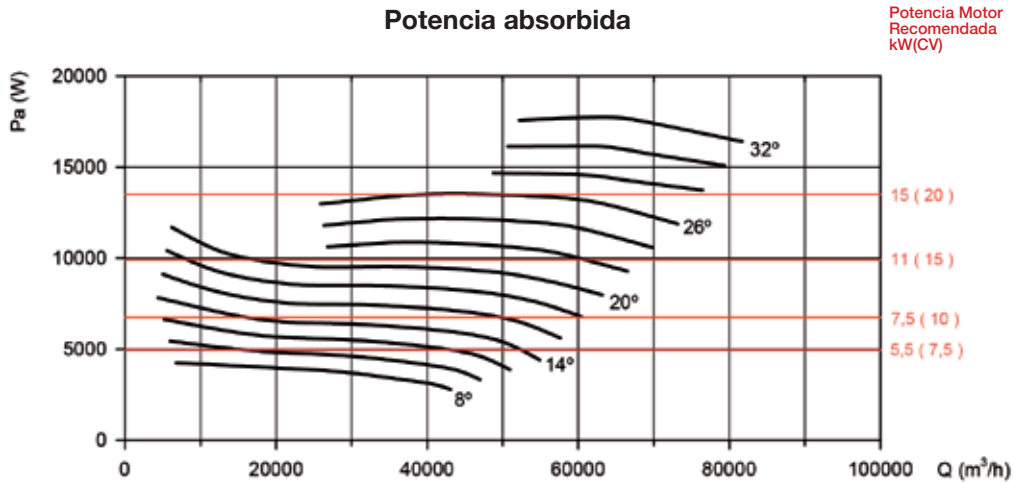
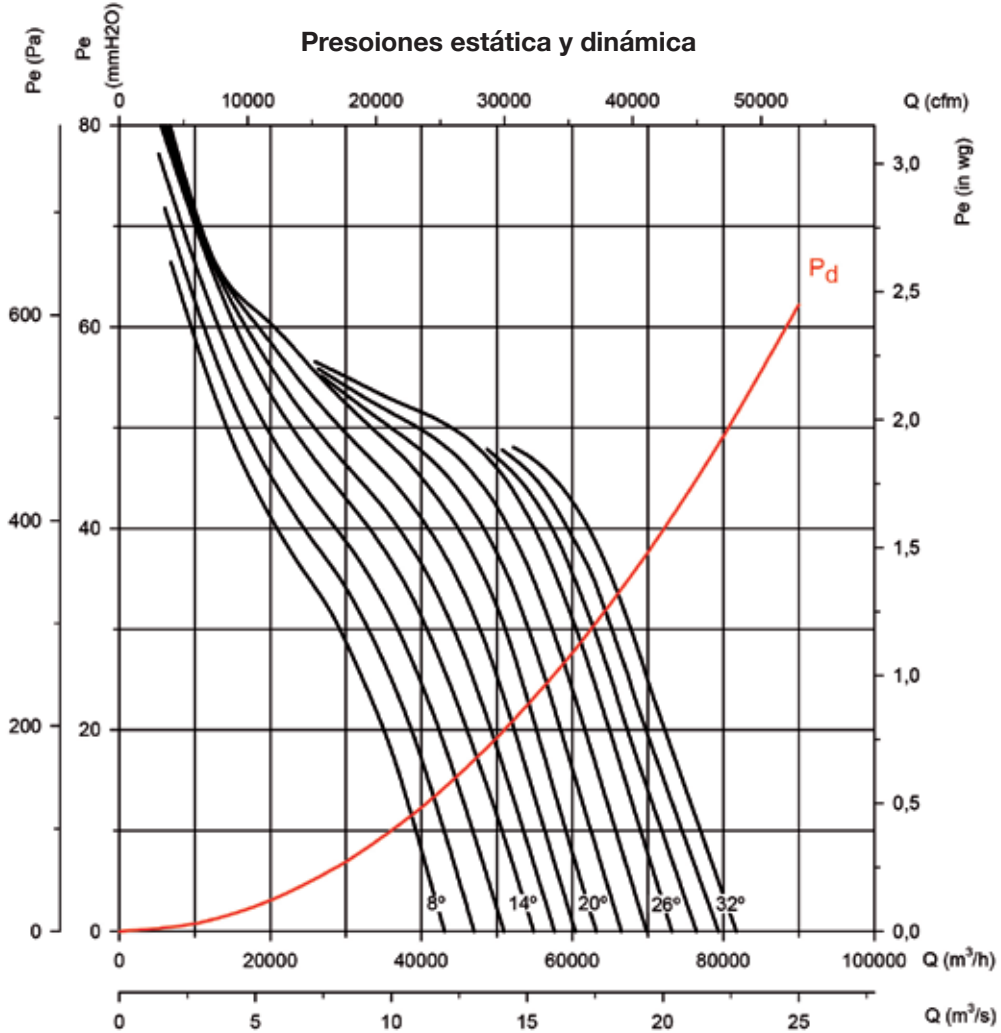

HGT HGTX

HGT: Ventiladores helicoidales tubulares de gran diámetro, con motor directo

HGTX: Ventiladores helicoidales tubulares de gran diámetro, con motor exterior

Ventiladores helicoidales tubulares, equipados con hélices de aluminio de 3, 6 ó 9 álabes con diversos ángulos de inclinación.



HGT



HGTX

Ventilador:

- Dirección aire motor-hélice
- Hélices en fundición de aluminio de 3, 6 ó 9 álabes, con ángulo de inclinación ajustable.
- Envolvente tubular en chapa de acero
- HGT: La versión standard es de carcasa corta. La versión en carcasa larga está equipada con trampilla de inspección.
- HGTX: Versión standard en carcasa larga, equipada con trampilla de inspección

Motor:

- Motores de eficiencia IE3 para potencias iguales o superiores a 7,5kW, excepto monofásicos, 2 velocidades y 8 polos
- Motores de eficiencia IE2 para potencias iguales o superiores a 0,75kW e inferiores a 7,5kW, excepto monofásicos, 2 velocidades y 8 polos
- Motores clase F, con rodamientos a bolas, protección IP55
- Trifásicos 230/400V-50Hz (hasta 4kW) y 400/690V-50Hz (potencias superiores a 4kW)
- Temperatura de trabajo:
HGT: -25°C +50°C
HGTX: -25°C +120°C

Acabado:

- Anticorrosivo en resina de poliéster polimerizada a 190 °C, previo desengrase con tratamiento nanotecnológico libre de fosfatos.

Bajo demanda:

- Dirección aire hélice-motor.
- Hélices reversibles 100%.
- Bobinados especiales para diferentes tensiones.
- Certificación ATEX Categoría 2
- HGT: Ventiladores con carcasa larga equipada con trampilla de inspección
- Motores de dos velocidades
- Motores de eficiencias IE2 e IE3 para cualquier potencia

Código de pedido

HGT — 125 — 4T — 6-20 — 10° — PV

HGT: Ventiladores helicoidales tubulares de gran diámetro, con motor directo
HGTX: Ventiladores helicoidales tubulares de gran diámetro, con motor exterior

Diámetro hélice en cm

Número de polos motor
4=1400 r/min. 50 Hz
6=900 r/min. 50 Hz
8=750 r/min. 50 Hz

Número de palas
3 palas
6 palas
9 palas

Potencia motor (CV)

Ángulo inclinación palas

PV=Paellón de aspiración



Características técnicas

Modelo	Velocidad (r/min)	Intensidad máx admisible (A)			Potencia instalada (kW)	Caudal máximo (m³/h)	Nivel presión sonora dB(A)	Peso aprox. (Kg)		According ErP
		230V	400V	690V				HGT Larga	HGTX Corta	
HGT HGTX 125-4T/3-10 IE3	1465	13,90	8,06	7,50	58150	88	227	194	358	2015
HGT HGTX 125-4T/3-15 IE3	1470	20,90	12,10	11,00	77450	89	274	246	394	2015
HGT HGTX 125-4T/3-20 IE3	1465	27,90	16,20	15,00	91400	91	285	257	405	2015
HGT HGTX 125-4T/3-25 IE3	1470	35,10	20,30	18,50	98350	91	363	320	450	2015
HGT HGTX 125-4T/3-30 IE3	1470	41,00	23,80	22,00	110500	92	363	320	450	2015
HGT HGTX 125-4T/3-40 IE3	1480	57,10	33,10	30,00	120850	93	468	425	557	2015
HGT HGTX 125-4T/3-50 IE3	1480	69,20	40,10	37,00	129000	94	551	495	622	2015
HGT HGTX 125-4T/3-60 IE3	1475	80,90	46,90	45,00	140000	95	589	533	660	2015
HGT HGTX 125-4T/6-20 IE3	1465	27,90	16,20	15,00	78300	89	294	266	414	2015
HGT HGTX 125-4T/6-25 IE3	1470	35,10	20,30	18,50	92000	90	372	329	459	2015
HGT HGTX 125-4T/6-30 IE3	1470	41,00	23,80	22,00	98100	90	372	329	459	2015
HGT HGTX 125-4T/6-40 IE3	1480	57,10	33,10	30,00	117000	92	477	433	566	2015
HGT HGTX 125-4T/6-50 IE3	1480	69,20	40,10	37,00	123700	93	560	504	631	2015
HGT HGTX 125-4T/6-60 IE3	1475	80,90	46,90	45,00	136000	94	598	542	669	2015
HGT HGTX 125-4T/6-75 IE3	1480	98,60	57,20	55,00	148000	95	614	564	700	2015
HGT HGTX 125-4T/6-100 IE3	1485	134,00	77,70	75,00	161000	96	708	658	794	2015

Características técnicas

Modelo	Velocidad (r/min)	Intensidad máx admisible (A)			Potencia instalada (kW)	Caudal máximo (m³/h)	Nivel presión sonora dB(A)	Peso aprox. (Kg)			According ErP
		230V	400V	690V				HGT Larga	HGT Corta	HGTX	
HGT HGTX 125-4T/9-25 IE3	1470		35,10	20,30	18,50	79750	88	381	338	468	2015
HGT HGTX 125-4T/9-30 IE3	1470		41,00	23,80	22,00	97000	89	381	338	468	2015
HGT HGTX 125-4T/9-40 IE3	1480		57,10	33,10	30,00	111200	91	486	442	575	2015
HGT HGTX 125-4T/9-50 IE3	1480		69,20	40,10	37,00	118350	93	569	513	640	2015
HGT HGTX 125-4T/9-60 IE3	1475		80,90	46,90	45,00	127000	94	607	551	678	2015
HGT HGTX 125-4T/9-75 IE3	1480		98,60	57,20	55,00	142000	95	623	573	709	2015
HGT HGTX 125-4T/9-100 IE3	1485		134,00	77,70	75,00	155000	99	717	667	803	2015
HGT HGTX 125-6T/3-4	960	12,70	7,33		3,00	46550	79	204	171	335	2015
HGT HGTX 125-6T/3-5.5	960	16,50	9,53		4,00	55300	80	209	176	340	2015
HGT HGTX 125-6T/3-7.5	975		11,50	6,64	5,50	64450	81	217	184	348	2015
HGT HGTX 125-6T/3-10 IE3	975		14,80	8,58	7,50	76400	83	297	269	417	2015
HGT HGTX 125-6T/3-15 IE3	975		21,90	12,70	11,00	87050	84	298	270	418	2015
HGT HGTX 125-6T/3-20 IE3	975		28,20	16,30	15,00	91700	85	407	364	494	2015
HGT HGTX 125-6T/6-5.5	960	16,50	9,53		4,00	51300	77	218	185	349	2015
HGT HGTX 125-6T/6-7.5	975		11,50	6,64	5,50	60300	77	226	193	357	2015
HGT HGTX 125-6T/6-10 IE3	975		14,80	8,58	7,50	72250	79	306	278	426	2015
HGT HGTX 125-6T/6-15 IE3	975		21,90	12,70	11,00	85450	81	307	279	427	2015
HGT HGTX 125-6T/6-20 IE3	975		28,20	16,30	15,00	92850	82	416	373	503	2015
HGT HGTX 125-6T/6-25 IE3	980		35,90	20,80	18,50	103000	84	449	405	538	2015
HGT HGTX 125-6T/9-10 IE3	975		14,80	8,58	7,50	68200	78	315	287	435	2015
HGT HGTX 125-6T/9-15 IE3	975		21,90	12,70	11,00	77550	81	316	288	436	2015
HGT HGTX 125-6T/9-20 IE3	975		28,20	16,30	15,00	92900	84	425	382	512	2015
HGT HGTX 125-6T/9-25 IE3	980		35,90	20,80	18,50	98700	85	458	414	547	2015
HGT HGTX 125-6T/9-30 IE3	980		42,40	24,60	22,00	104000	87	463	419	552	2015
HGT HGTX 125-8T/3-3	705	9,53	5,50		2,20	48800	71	209	176	340	2015
HGT HGTX 125-8T/3-4	705	12,82	7,40		3,00	54900	71	216	183	347	2015
HGT HGTX 125-8T/3-5.5	710	16,11	9,30		4,00	62100	73	249	221	369	2015
HGT HGTX 125-8T/3-7.5	725		12,70	7,33	5,50	69500	75	262	234	382	2015
HGT HGTX 125-8T/6-3	705	9,53	5,50		2,20	45700	69	218	185	349	2015
HGT HGTX 125-8T/6-4	705	12,82	7,40		3,00	51800	71	225	192	356	2015
HGT HGTX 125-8T/6-5.5	710	16,11	9,30		4,00	61500	72	258	230	378	2015
HGT HGTX 125-8T/6-7.5	725		12,70	7,33	5,50	67500	73	271	243	391	2015
HGT HGTX 125-8T/6-10	725		17,00	9,81	7,50	75500	75	301	273	421	2015
HGT HGTX 125-8T/9-4	705	12,82	7,40		3,00	48200	70	234	201	365	2015
HGT HGTX 125-8T/9-5.5	710	16,11	9,30		4,00	55200	73	267	239	387	2015
HGT HGTX 125-8T/9-7.5	725		12,70	7,33	5,50	67000	75	280	252	400	2015
HGT HGTX 125-8T/9-10	725		17,00	9,81	7,50	74750	76	310	282	430	2015
HGT HGTX 125-8T/9-15	725		21,70	12,53	11,00	80800	79	372	329	459	2015
HGT - 140-6T/3-4	960	12,70	7,33		3,00	51000	82	251	214		2015
HGT - 140-6T/3-5.5	960	16,50	9,53		4,00	56700	83	258	221		2015
HGT - 140-6T/3-7.5	975		11,50	6,64	5,50	67900	84	266	229		2015
HGT - 140-6T/3-10 IE3	975		14,80	8,58	7,50	80100	85	355	316		2015
HGT - 140-6T/3-15 IE3	975		21,90	12,70	11,00	96900	86	356	317		2015
HGT - 140-6T/3-20 IE3	975		28,20	16,30	15,00	106000	88	463	413		2015
HGT - 140-6T/6-5.5	960	16,50	9,53		4,00	58000	82	268	231		2015
HGT - 140-6T/6-7.5	975		11,50	6,64	5,50	66000	84	276	239		2015
HGT - 140-6T/6-10 IE3	975		14,80	8,58	7,50	80700	85	365	326		2015
HGT - 140-6T/6-15 IE3	975		21,90	12,70	11,00	96700	86	366	327		2015
HGT - 140-6T/6-20 IE3	975		28,20	16,30	15,00	104000	87	472	423		2015
HGT - 140-6T/6-25 IE3	980		35,90	20,80	18,50	115000	88	506	457		2015
HGT - 140-6T/6-30 IE3	980		42,40	24,60	22,00	119000	89	511	462		2015
HGT - 140-6T/9-10 IE3	975		14,80	8,58	7,50	70000	84	374	335		2015
HGT - 140-6T/9-15 IE3	975		21,90	12,70	11,00	86000	86	375	336		2015
HGT - 140-6T/9-20 IE3	975		28,20	16,30	15,00	97500	87	482	432		2015
HGT - 140-6T/9-25 IE3	980		35,90	20,80	18,50	111000	88	515	467		2015
HGT - 140-6T/9-30 IE3	980		42,40	24,60	22,00	118500	89	520	472		2015
HGT - 140-6T/9-40 IE3	985		55,40	32,10	30,00	132000	91	676	614		2015
HGT - 140-6T/9-50 IE3	985		67,20	39,00	37,00	139000	92	693	638		2015
HGT - 140-8T/3-3	705	9,53	5,50		2,20	50000	78	258	221		2015

Características técnicas

Modelo	Velocidad (r/min)	Intensidad máx admisible (A)			Potencia instalada (kW)	Caudal máximo (m³/h)	Nivel presión sonora dB(A)	Peso aprox. (Kg)		According ErP
		230V	400V	690V				HGT Larga	HGTX Corta	
HGT - 140-8T/3-4	705	12,82	7,40		3,00	57000	78	265	228	2015
HGT - 140-8T/3-5.5	710	16,11	9,30		4,00	65400	79	307	268	2015
HGT - 140-8T/3-7.5	725		12,70	7,33	5,50	77500	81	320	281	2015
HGT - 140-8T/3-10	725		17,00	9,81	7,50	86000	82	350	311	2015
HGT - 140-8T/6-3	705	9,53	5,50		2,20	47500	78	268	231	2015
HGT - 140-8T/6-4	705	12,82	7,40		3,00	57600	79	275	238	2015
HGT - 140-8T/6-5.5	710	16,11	9,30		4,00	65200	80	317	278	2015
HGT - 140-8T/6-7.5	725		12,70	7,33	5,50	73300	81	330	291	2015
HGT - 140-8T/6-10	725		17,00	9,81	7,50	82200	82	360	321	2015
HGT - 140-8T/6-15	725		21,70	12,53	11,00	94200	83	419	370	2015
HGT - 140-8T/9-4	705	12,82	7,40		3,00	47200	79	284	247	2015
HGT - 140-8T/9-5.5	710	16,11	9,30		4,00	64400	79	326	287	2015
HGT - 140-8T/9-7.5	725		12,70	7,33	5,50	69200	81	339	300	2015
HGT - 140-8T/9-10	725		17,00	9,81	7,50	78700	82	369	330	2015
HGT - 140-8T/9-15	725		21,70	12,53	11,00	94300	83	429	379	2015
HGT - 140-8T/9-20	725		31,70	18,30	15,00	103000	86	485	437	2015
HGT - 160-6T/3-5.5	960	16,50	9,53		4,00	66000	81	327	275	2015
HGT - 160-6T/3-7.5	975		11,50	6,64	5,50	76100	82	335	283	2015
HGT - 160-6T/3-10 IE3	975		14,80	8,58	7,50	84000	83	428	374	2015
HGT - 160-6T/3-15 IE3	975		21,90	12,70	11,00	102000	85	429	375	2015
HGT - 160-6T/3-20 IE3	975		28,20	16,30	15,00	127000	86	549	480	2015
HGT - 160-6T/3-25 IE3	980		35,90	20,80	18,50	136700	87	583	513	2015
HGT - 160-6T/3-30 IE3	980		42,40	24,60	22,00	145000	89	588	518	2015
HGT - 160-6T/6-10 IE3	975		14,80	8,58	7,50	75000	83	439	385	2015
HGT - 160-6T/6-15 IE3	975		21,90	12,70	11,00	93500	85	440	386	2015
HGT - 160-6T/6-20 IE3	975		28,20	16,30	15,00	120500	86	559	490	2015
HGT - 160-6T/6-25 IE3	980		35,90	20,80	18,50	130000	87	593	524	2015
HGT - 160-6T/6-30 IE3	980		42,40	24,60	22,00	140000	88	598	529	2015
HGT - 160-6T/6-40 IE3	985		55,40	32,10	30,00	158000	89	771	672	2015
HGT - 160-6T/6-50 IE3	985		67,20	39,00	37,00	171000	91	784	699	2015
HGT - 160-6T/9-15 IE3	975		21,90	12,70	11,00	87000	85	450	396	2015
HGT - 160-6T/9-20 IE3	975		28,20	16,30	15,00	104000	86	569	500	2015
HGT - 160-6T/9-25 IE3	980		35,90	20,80	18,50	127000	87	603	534	2015
HGT - 160-6T/9-30 IE3	980		42,40	24,60	22,00	135000	88	608	539	2015
HGT - 160-6T/9-40 IE3	985		55,40	32,10	30,00	147000	89	781	682	2015
HGT - 160-6T/9-50 IE3	985		67,20	39,00	37,00	165000	90	794	710	2015
HGT - 160-6T/9-60 IE3	985		84,40	48,90	45,00	177000	91	1019	920	2015
HGT - 160-6T/9-75 IE3	985		103,00	59,70	55,00	193000	92	1077	978	2015
HGT - 160-6T/9-100 IE3	990		139,00	80,60	75,00	207500	93	1232	1133	2015
HGT - 160-8T/3-3	705	9,53	5,50		2,20	54000	76	327	275	2015
HGT - 160-8T/3-4	705	12,82	7,40		3,00	57500	77	334	282	2015
HGT - 160-8T/3-5.5	710	16,11	9,30		4,00	74000	79	380	326	2015
HGT - 160-8T/3-7.5	725		12,70	7,33	5,50	83500	80	393	339	2015
HGT - 160-8T/3-10	725		17,00	9,81	7,50	97500	81	423	369	2015
HGT - 160-8T/3-15	725		21,70	12,53	11,00	115000	83	496	427	2015
HGT - 160-8T/6-4	705	12,82	7,40		3,00	70900	76	344	292	2015
HGT - 160-8T/6-5.5	710	16,11	9,30		4,00	84500	77	391	337	2015
HGT - 160-8T/6-7.5	725		12,70	7,33	5,50	77000	79	404	350	2015
HGT - 160-8T/6-10	725		17,00	9,81	7,50	95000	80	434	380	2015
HGT - 160-8T/6-15	725		21,70	12,53	11,00	109000	82	506	437	2015
HGT - 160-8T/6-20	725		31,70	18,30	15,00	123000	83	563	494	2015
HGT - 160-8T/6-25	725		35,85	20,70	18,50	130000	84	641	542	2015
HGT - 160-8T/9-7.5	725		12,70	7,33	5,50	70000	79	414	360	2015
HGT - 160-8T/9-10	725		17,00	9,81	7,50	87000	80	444	390	2015
HGT - 160-8T/9-15	725		21,70	12,53	11,00	103000	82	516	447	2015
HGT - 160-8T/9-20	725		31,70	18,30	15,00	117000	83	573	504	2015
HGT - 160-8T/9-25	725		35,85	20,70	18,50	133000	84	651	552	2015
HGT - 160-8T/9-30	725		41,60	24,02	22,00	140000	85	666	567	2015
HGT - 160-8T/9-40	730		60,79	35,10	30,00	151000	86	724	640	2015



Características acústicas

Los valores indicados, se determinan mediante medidas de nivel de presión y potencia sonora en dB(A) obtenidas en campo libre a una distancia equivalente a dos veces la envergadura del ventilador más el diámetro de la hélice, con un mínimo de 1,5 mts.

Espectro de potencia sonora Lw(A) en dB(A) por banda de frecuencia en Hz

Modelo	63	125	250	500	1000	2000	4000	8000	Modelo	63	125	250	500	1000	2000	4000	8000
125-4T/3-10	70	76	88	98	98	94	86	82	140-6T/9-10	66	84	93	92	91	87	78	73
125-4T/3-15	71	77	89	99	99	95	87	83	140-6T/9-15	67	85	94	93	92	88	79	74
125-4T/3-20	72	78	90	100	100	96	88	84	140-6T/9-20	69	87	96	95	94	90	81	76
125-4T/3-25	73	79	91	101	101	97	89	85	140-6T/9-25	70	88	97	96	95	91	82	77
125-4T/3-30	74	80	92	102	102	98	90	86	140-6T/9-30	70	88	97	96	95	91	82	77
125-4T/3-40	75	81	93	103	103	99	91	87	140-6T/9-40	71	89	98	97	96	92	83	78
125-4T/3-50	76	82	94	104	104	100	92	88	140-6T/9-50	74	92	101	100	99	95	86	81
125-4T/3-60	77	83	95	105	105	101	93	89	140-8T/3-3	60	70	78	83	82	81	68	63
125-4T/6-20	66	74	90	97	99	94	88	84	140-8T/3-4	64	74	82	87	86	85	72	67
125-4T/6-25	67	75	91	98	100	95	89	85	140-8T/3-5,5	65	75	83	88	87	86	73	68
125-4T/6-30	68	76	92	99	101	96	90	86	140-8T/3-7,5	66	76	84	89	88	87	74	69
125-4T/6-40	69	77	93	100	102	97	91	87	140-8T/3-10	68	78	86	91	90	89	76	71
125-4T/6-50	71	79	95	102	104	99	93	89	140-8T/6-3	61	73	82	86	84	78	68	65
125-4T/6-60	72	80	96	103	105	100	94	90	140-8T/6-4	63	75	84	88	86	80	70	67
125-4T/6-75	72	80	96	103	105	100	94	90	140-8T/6-5,5	64	76	85	89	87	81	71	68
125-4T/6-100	74	82	98	105	107	102	96	92	140-8T/6-7,5	65	77	86	90	88	82	72	69
125-4T/9-25	66	74	91	97	98	93	88	84	140-8T/6-10	66	78	87	91	89	83	73	70
125-4T/9-30	67	75	92	98	99	94	89	85	140-8T/6-15	68	80	89	93	91	85	75	72
125-4T/9-40	68	76	93	99	100	95	90	86	140-8T/9-4	61	72	83	88	86	82	72	67
125-4T/9-50	70	78	95	101	102	97	92	88	140-8T/9-5,5	62	73	84	89	87	83	73	68
125-4T/9-60	72	80	97	103	104	99	94	90	140-8T/9-7,5	63	74	85	90	88	84	74	69
125-4T/9-75	72	80	97	103	104	99	94	90	140-8T/9-10	64	75	86	91	89	85	75	70
125-4T/9-100	74	82	99	105	106	101	96	92	140-8T/9-15	65	76	87	92	90	86	76	71
125-6T/3-4	64	72	84	88	86	81	72	68	140-8T/9-20	67	78	89	94	92	88	78	73
125-6T/3-5,5	66	74	86	90	88	83	74	70	160-6T/3-5,5	67	77	85	90	89	88	75	70
125-6T/3-7,5	67	75	87	91	89	84	75	71	160-6T/3-7,5	68	78	86	91	90	89	76	71
125-6T/3-10	68	76	88	92	90	85	76	72	160-6T/3-10	69	79	87	92	91	90	77	72
125-6T/3-15	69	77	89	93	91	86	77	73	160-6T/3-15	70	80	88	93	92	91	78	73
125-6T/3-20	71	79	91	95	93	88	79	75	160-6T/3-20	72	82	90	95	94	93	80	75
125-6T/6-5,5	59	68	81	84	85	82	71	67	160-6T/3-25	73	83	91	96	95	94	81	76
125-6T/6-7,5	60	69	82	85	86	83	72	68	160-6T/3-30	74	84	92	97	96	95	82	77
125-6T/6-10	61	70	83	86	87	84	73	69	160-6T/6-10	67	82	91	93	90	84	76	72
125-6T/6-15	63	72	85	88	89	86	75	71	160-6T/6-15	68	83	92	94	91	85	77	73
125-6T/6-20	65	74	87	90	91	88	77	73	160-6T/6-20	70	85	94	96	93	87	79	75
125-6T/6-25	66	75	88	91	92	89	78	74	160-6T/6-25	71	86	95	97	94	88	80	76
125-6T/9-10	57	67	82	86	85	84	73	69	160-6T/6-30	71	86	95	97	94	88	80	76
125-6T/9-15	59	69	84	88	87	86	75	71	160-6T/6-40	72	87	96	98	95	89	81	77
125-6T/9-20	62	72	87	91	90	89	78	74	160-6T/6-50	74	89	98	100	97	91	83	79
125-6T/9-25	64	74	89	93	92	91	80	76	160-6T/9-15	67	85	94	93	92	88	79	74
125-6T/9-30	66	76	91	95	94	93	82	78	160-6T/9-20	68	86	95	94	93	89	80	75
125-8T/3-3	56	63	74	78	77	70	61	57	160-6T/9-25	69	87	96	95	94	90	81	76
125-8T/3-4	59	66	77	81	80	73	64	60	160-6T/9-30	70	88	97	96	95	91	82	77
125-8T/3-5,5	60	67	78	82	81	74	65	61	160-6T/9-40	71	89	98	97	96	92	83	78
125-8T/3-7,5	62	69	80	84	83	76	67	63	160-6T/9-50	72	90	99	98	97	93	84	79
125-8T/6-3	53	61	73	78	77	72	61	57	160-6T/9-60	72	90	99	98	97	93	84	79
125-8T/6-4	54	62	74	79	78	73	62	58	160-6T/9-75	73	91	100	99	98	94	85	80
125-8T/6-5,5	56	64	76	81	80	75	64	60	160-6T/9-100	75	93	102	101	100	96	87	82
125-8T/6-7,5	58	66	78	83	82	77	66	62	160-8T/3-3	61	71	79	84	83	82	69	64
125-8T/6-10	59	67	79	84	83	78	67	63	160-8T/3-4	63	73	81	86	85	84	71	66
125-8T/9-4	51	62	72	78	79	74	63	59	160-8T/3-5,5	64	74	82	87	86	85	72	67
125-8T/9-5,5	53	64	74	80	81	76	65	61	160-8T/3-7,5	65	75	83	88	87	86	73	68
125-8T/9-7,5	56	67	77	83	84	79	68	64	160-8T/3-10	66	76	84	89	88	87	74	69
125-8T/9-10	58	69	79	85	86	81	70	66	160-8T/3-15	68	78	86	91	90	89	76	71
125-8T/9-15	59	70	80	86	87	82	71	67	160-8T/6-4	60	75	84	86	83	77	69	65
140-6T/3-4	66	76	84	89	88	87	74	74	160-8T/6-5,5	61	76	85	87	84	78	70	66
140-6T/3-5,5	69	79	87	92	91	90	77	77	160-8T/6-7,5	62	77	86	88	85	79	71	67
140-6T/3-7,5	69	79	87	92	91	90	77	77	160-8T/6-10	63	78	87	89	86	80	72	68
140-6T/3-10	70	80	88	93	92	91	78	78	160-8T/6-15	65	80	89	91	88	82	74	70
140-6T/3-15	71	81	89	94	93	92	79	79	160-8T/6-20	66	81	90	92	89	83	75	71
140-6T/3-20	73	83	91	96	95	94	81	81	160-8T/6-25	68	83	92	94	91	85	77	73
140-6T/6-5,5	66	81	90	92	89	83	75	71	160-8T/9-7,5	60	78	87	86	85	81	72	67
140-6T/6-7,5	67	82	91	93	90	84	76	72	160-8T/9-10	62	80	89	88	87	83	74	69
140-6T/6-10	68	83	92	94	91	85	77	73	160-8T/9-15	63	81	90	89	88	84	75	70
140-6T/6-15	69	84	93	95	92	86	78	74	160-8T/9-20	64	82	91	90	89	85	76	71
140-6T/6-20	71	86	95	97	94	88	80	76	160-8T/9-25	65	83	92	91	90	86	77	72
140-6T/6-25	72	87	96	98	95	89	81	77	160-8T/9-30	66	84	93	92	91	87	78	73
140-6T/6-30	73	88	97	99	96	90	82	78	160-8T/9-40	68	86	95	94	93	89	80	75

Accesorios

Ver apartado accesorios.



INT

VSD3/A-RFT
VSD1/A-RFM

CUADROS

RT

PT/H

BTUB

BAC

PS

S

PV

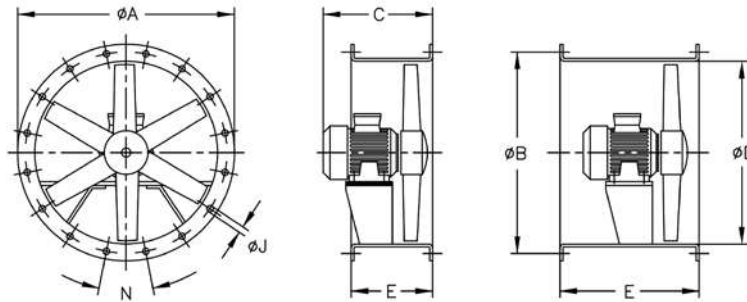
Dimensiones mm
HGT

Modelo	ØA	ØB	C (Consultar tamaño constructivo motor)							ØD	E*		ØJ	N
			132	160	180	200	225	250	280		Corta (STD)	larga		
HGT-125	1365	1320	586	-	-	-	-	-	-	1250	500	700	15	20x18°
HGT-125	1365	1320	-	700	-	-	-	-	-	1250	500	700	15	20x18°
HGT-125	1365	1320	-	-	765	825	-	-	-	1250	700	900	15	20x18°
HGT-125	1365	1320	-	-	-	-	910	-	-	1250	700	1000	15	20x18°
HGT-125	1365	1320	-	-	-	-	-	985	-	1250	700	1000	15	20x18°
HGT-125	1365	1320	-	-	-	-	-	-	1190	1250	700	1200	15	20x18°
HGT-140	1515	1470	586	-	-	-	-	-	-	1400	400	650	15	20x18°
HGT-140	1515	1470	-	700	-	-	-	-	-	1400	450	700	15	20x18°
HGT-140	1515	1470	-	-	765	825	-	-	-	1400	550	900	15	20x18°
HGT-140	1515	1470	-	-	-	-	910	-	-	1400	550	1000	15	20x18°
HGT-140	1515	1470	-	-	-	-	-	985	-	1400	600	1000	15	20x18°
HGT-160	1735	1680	586	-	-	-	-	-	-	1600	400	650	19	24x15°
HGT-160	1735	1680	-	700	-	-	-	-	-	1600	450	700	19	24x15°
HGT-160	1735	1680	-	-	765	825	-	-	-	1600	550	900	19	24x15°
HGT-160	1735	1680	-	-	-	-	910	-	-	1600	550	1000	19	24x15°
HGT-160	1735	1680	-	-	-	-	-	985	-	1600	600	1000	19	24x15°
HGT-160	1735	1680	-	-	-	-	-	-	1190	1600	700	1200	19	24x15°

* Versión estándar suministrada en carcasa corta. Bajo demanda carcasa larga con trampilla de inspección.

Tamaños constructivos motores según potencia

Polos	r/min	CV	3	4	5,5	7,5	10	15	20	25	30	40	50	60	75	100
4T	1500	-	-	-	-	-	132	160	160	180	180	200	225	225	250	280
6T	1000	-	132	132	132	160	160	180	200	200	225	250	280	280	280	280
8T	750	-	132	132	160	160	160	180	200	225	225	250	-	-	-	-

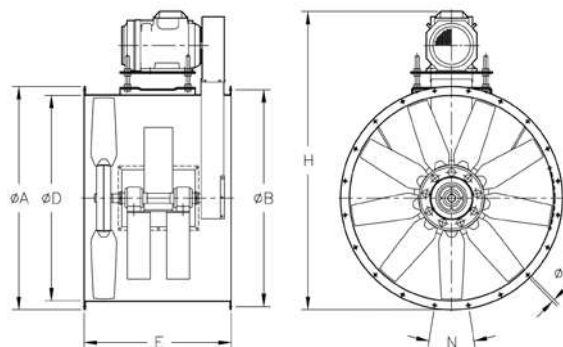
HGTX

Modelo	ØA	ØB	ØD	E	H (Consultar tamaño constructivo motor)							ØJ	N	
					132	160	180	200	225	250	280			
HGT-X 125	1365	1320	1250	900	1743	1815	1850	-	-	-	-	-	15	20x18°
HGT-X 125	1365	1320	1250	960	-	-	-	1930	1995	-	-	-	15	20x18°
HGT-X 125	1365	1320	1250	1100	-	-	-	-	-	2060	-	-	15	20x18°
HGT-X 125	1365	1320	1250	1100	-	-	-	-	-	-	2090	-	15	20x18°

Tamaños constructivos motores según potencia

Polos	r/min	CV	3	4	5,5	7,5	10	15	20	25	30	40	50	60	75	100
4T	1500	-	-	-	-	-	132	160	160	180	180	200	225	225	250	280
6T	1000	-	132	132	132	160	160	180	200	200	225	250	280	280	280	280
8T	750	-	132	132	160	160	160	180	200	225	225	250	-	-	-	-

EJEMPLO SELECCIÓN

Curvas características

Q= Caudal en m³/h, m³/s y cfm.

Pe= Presión estática en mmH₂O, Pa e inwg.

Diámetro Hélice (cm): 125

Número de polos: 8

Número de palas: 3

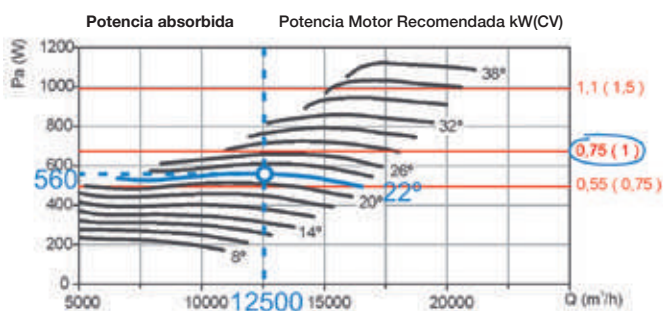
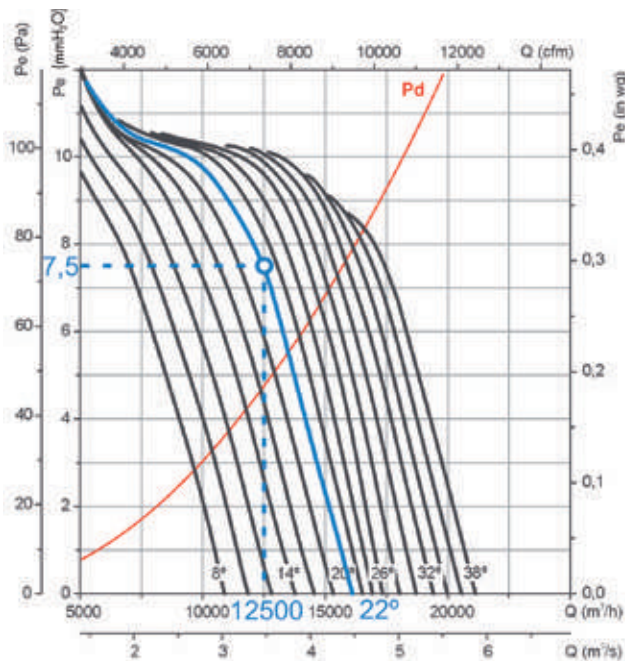

Datos de partida

- Punto de trabajo:
- Caudal: 12.500 m³/h
- Pérdida de carga: 7,5 mmH₂O

Pasos para la selección del equipo

En la gráfica de presiones:

- 1. Marcar el punto de trabajo, definido por el caudal de trabajo (12.500 m³/h) y la pérdida de carga (7,5 mmH₂O).
- 2. Escoger la curva del equipo que más se acerque por encima al punto de trabajo. En nuestro caso se obtiene una curva de 22° de ángulo de pala.

En la gráfica de potencia:

- 3. Marcar el punto de trabajo, definido por el caudal de trabajo (12.500 m³/h) y la curva de ángulo de pala escogido (22°).
- 4. Leer la potencia absorbida en el eje de potencias a la izquierda. La Pa= 560 W en el punto de trabajo.
- 5. Buscar recta roja que más se acerque al punto de trabajo por encima. En la parte derecha de la gráfica se obtiene el valor de potencia instalada de motor. En nuestro caso 0,75 kW o 1 CV

EJEMPLO CÓDIGO PEDIDO

HGT — 125 — 8T — 3 — 1 — 22

HGT: Ventiladores helicoidales tubulares de gran diámetro, con motor directo
 HGTX: Ventiladores helicoidales tubulares de gran diámetro, con motor exterior

Diámetro hélice en cm

Número de polos motor
 4=1400 r/min. 50 Hz
 6=900 r/min. 50 Hz
 8=750 r/min. 50 Hz

T=Trifásico

Número de palas
 3 palas
 6 palas
 9 palas

Potencia motor (CV)

Angulo inclinación palas

Curvas características

Q= Caudal en m³/h, m³/s y cfm. Pe= Presión estática en mmH₂O, Pa e inwg.

Diámetro Hélice (cm): 125 Número de polos: 4 Número de palas: 3

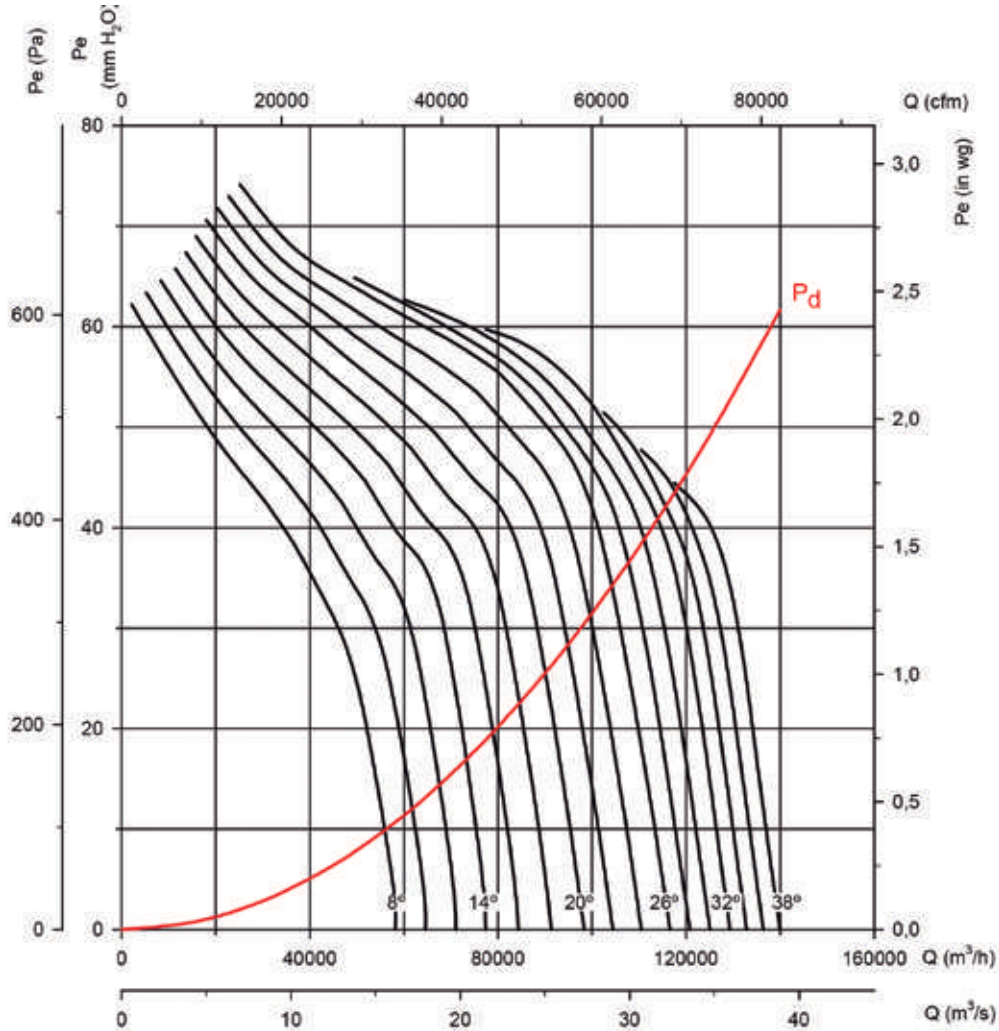

Potencia absorbida

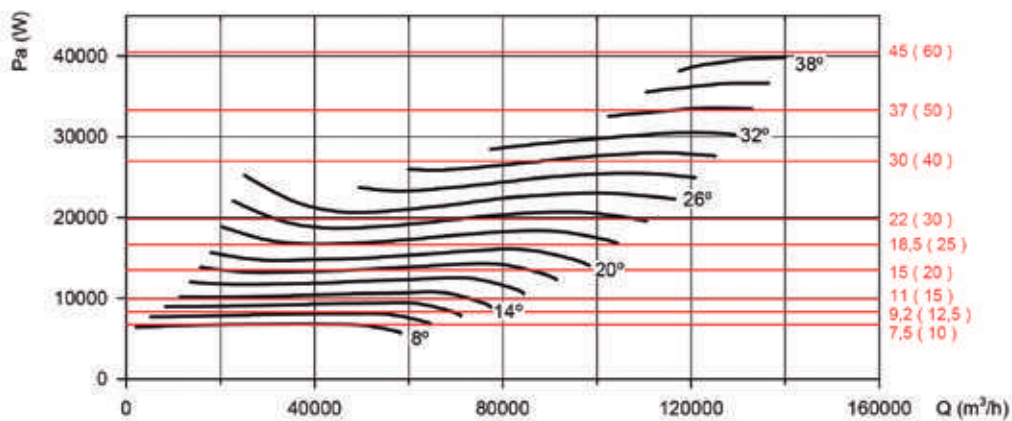

Curvas características

Q= Caudal en m³/h, m³/s y cfm. Pe= Presión estática en mmH₂O, Pa e inwg.

Diámetro Hélice (cm): 125

Número de polos: 4

Número de palas: 6

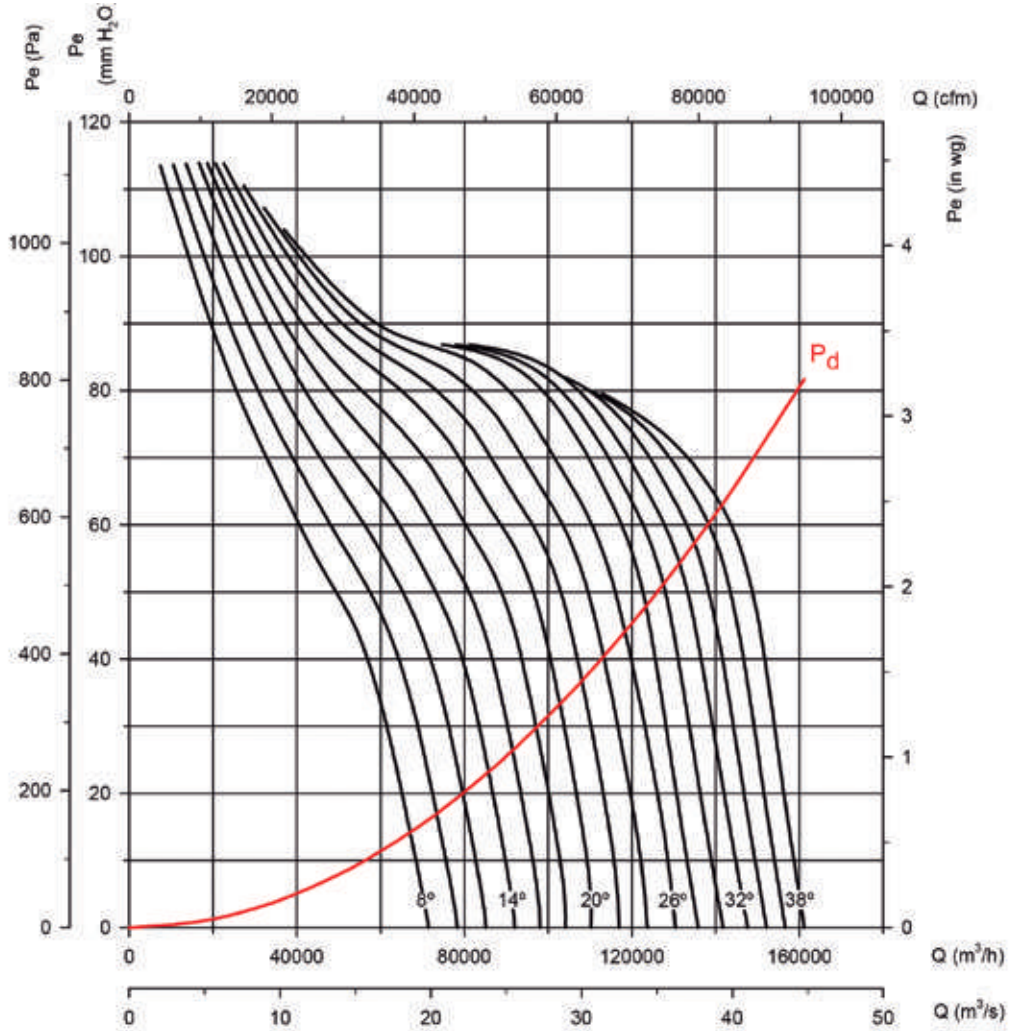

Potencia absorbida

Potencia Motor Recomendada kW(CV)

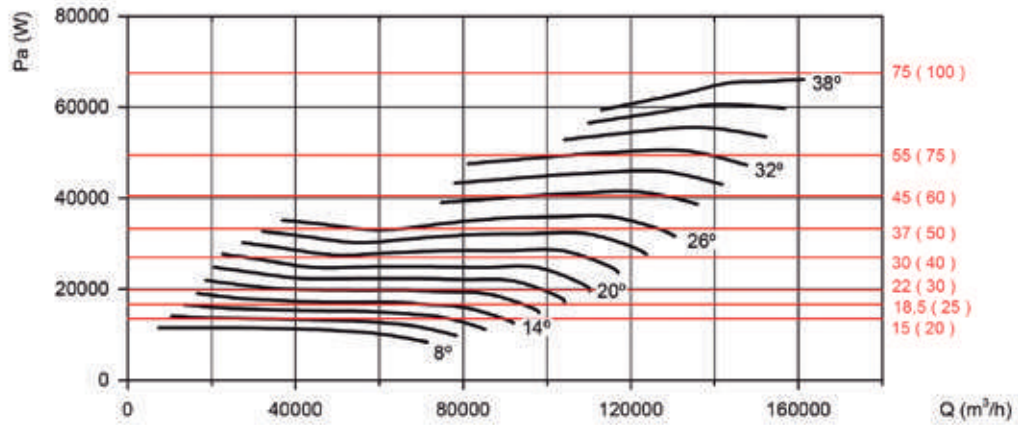

Curvas características

Q= Caudal en m³/h, m³/s y cfm. Pe= Presión estática en mmH₂O, Pa e inwg.

Diámetro Hélice (cm): 125 Número de polos: 4 Número de palas: 9

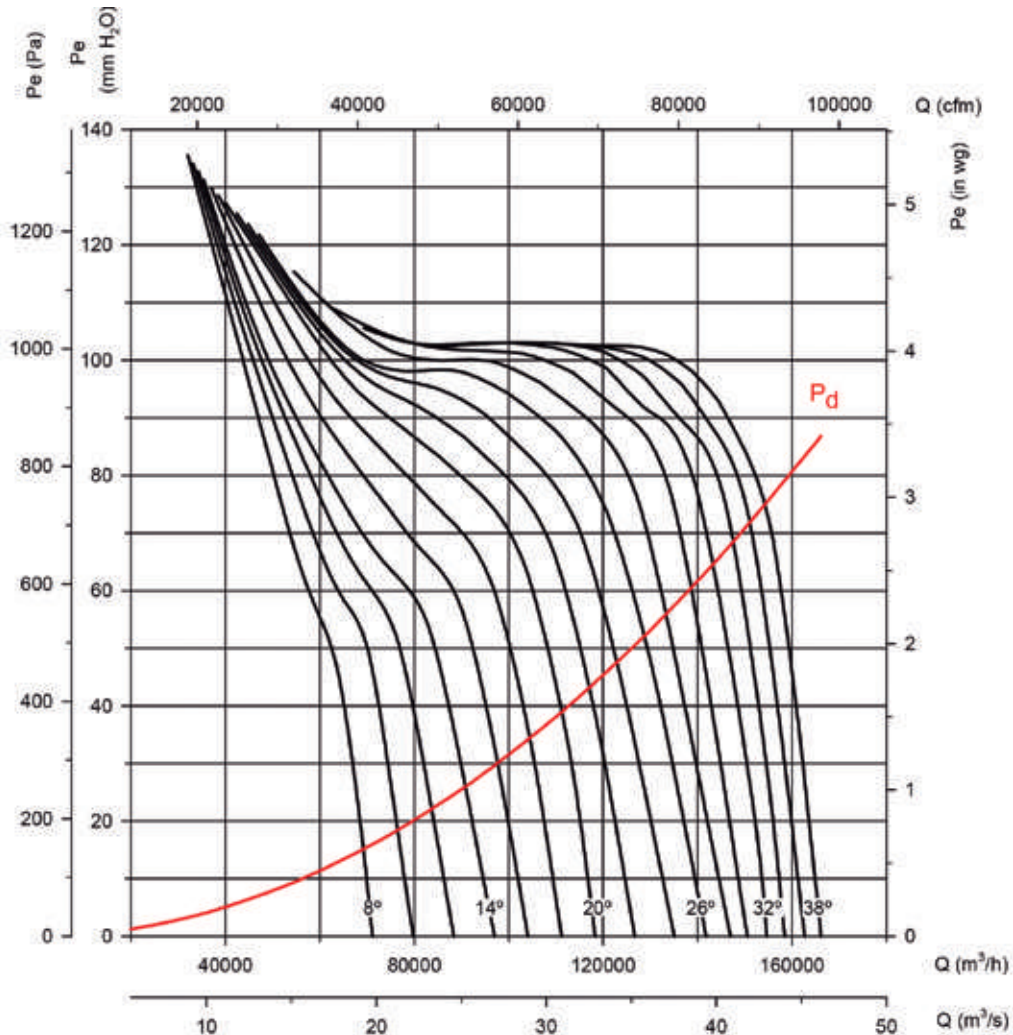

Potencia absorbida

Potencia Motor Recomendada kW(CV)

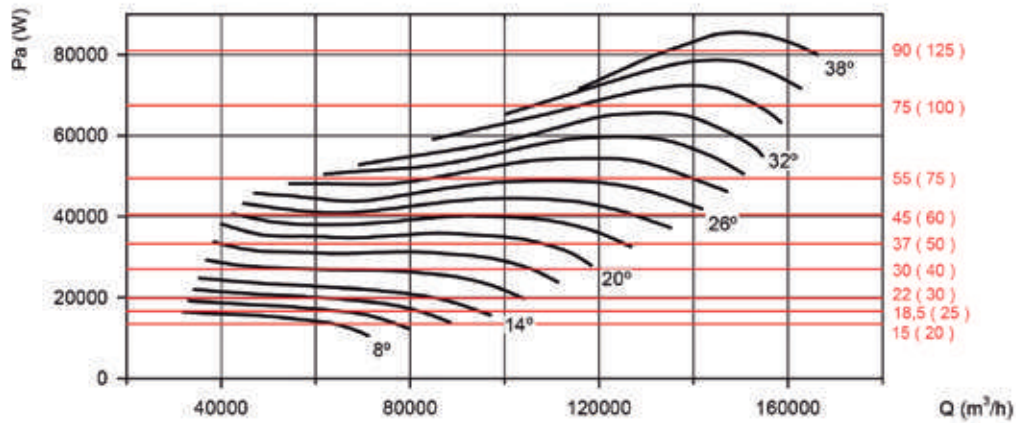



Curvas características

Q= Caudal en m³/h, m³/s y cfm. Pe= Presión estática en mmH₂O, Pa e inwg.

Diámetro Hélice (cm): 125

Número de polos: 6

Número de palas: 3

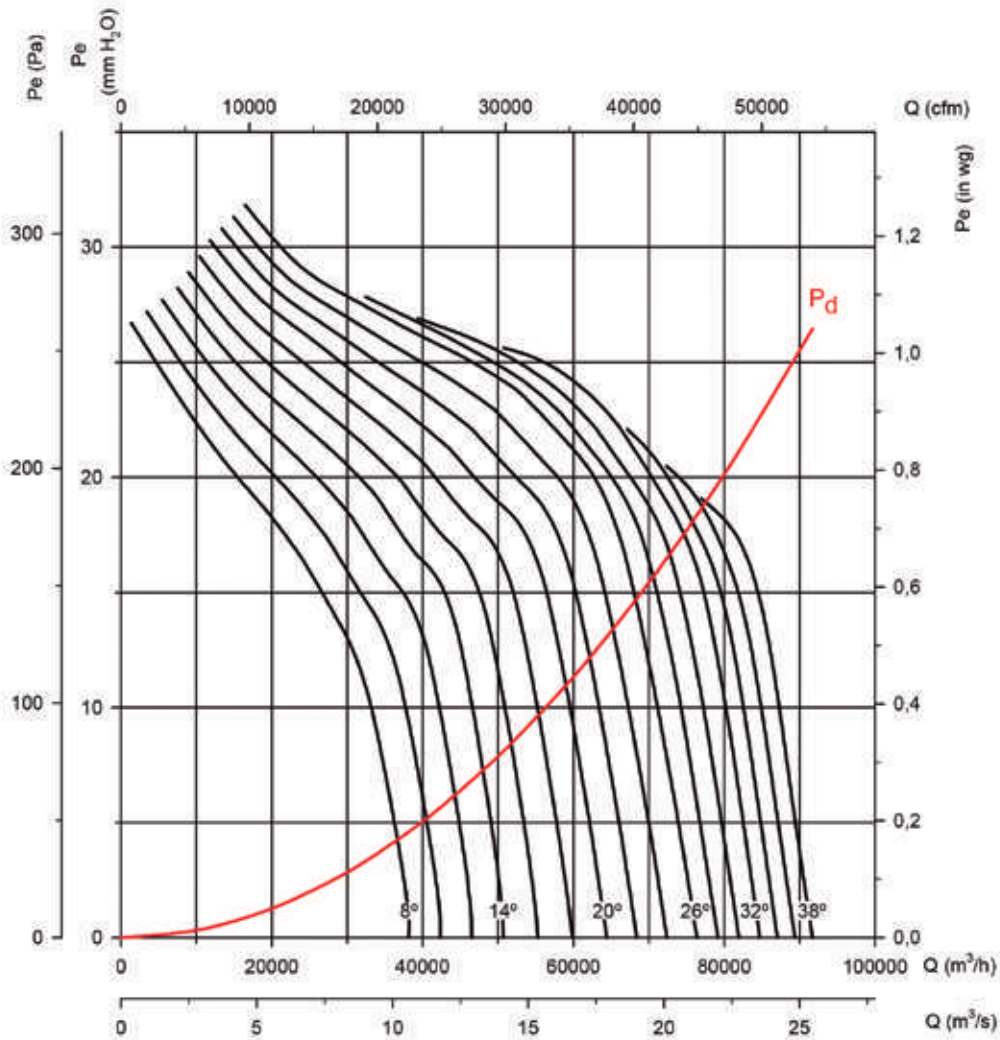

Potencia absorbida

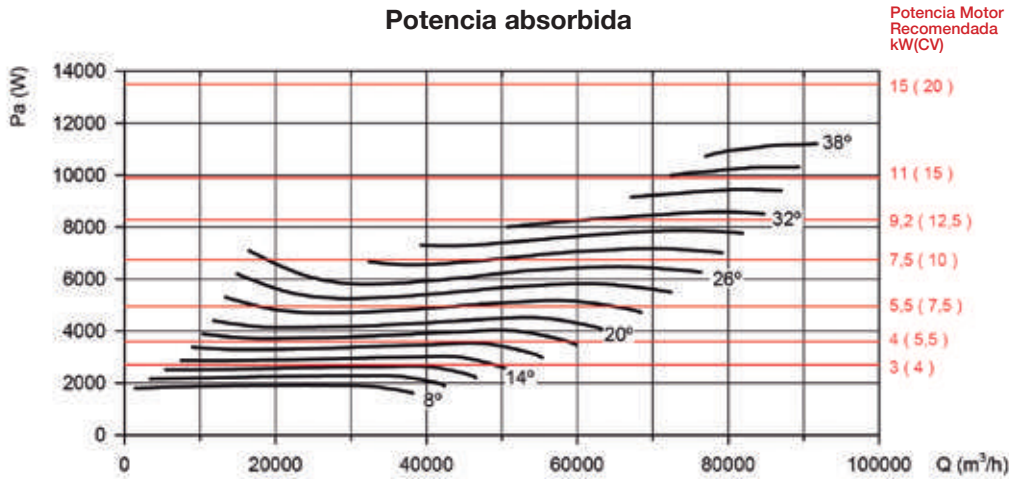

Curvas características

Q= Caudal en m³/h, m³/s y cfm. Pe= Presión estática en mmH₂O, Pa e inwg.

Diámetro Hélice (cm): 125 Número de polos: 6 Número de palas: 6

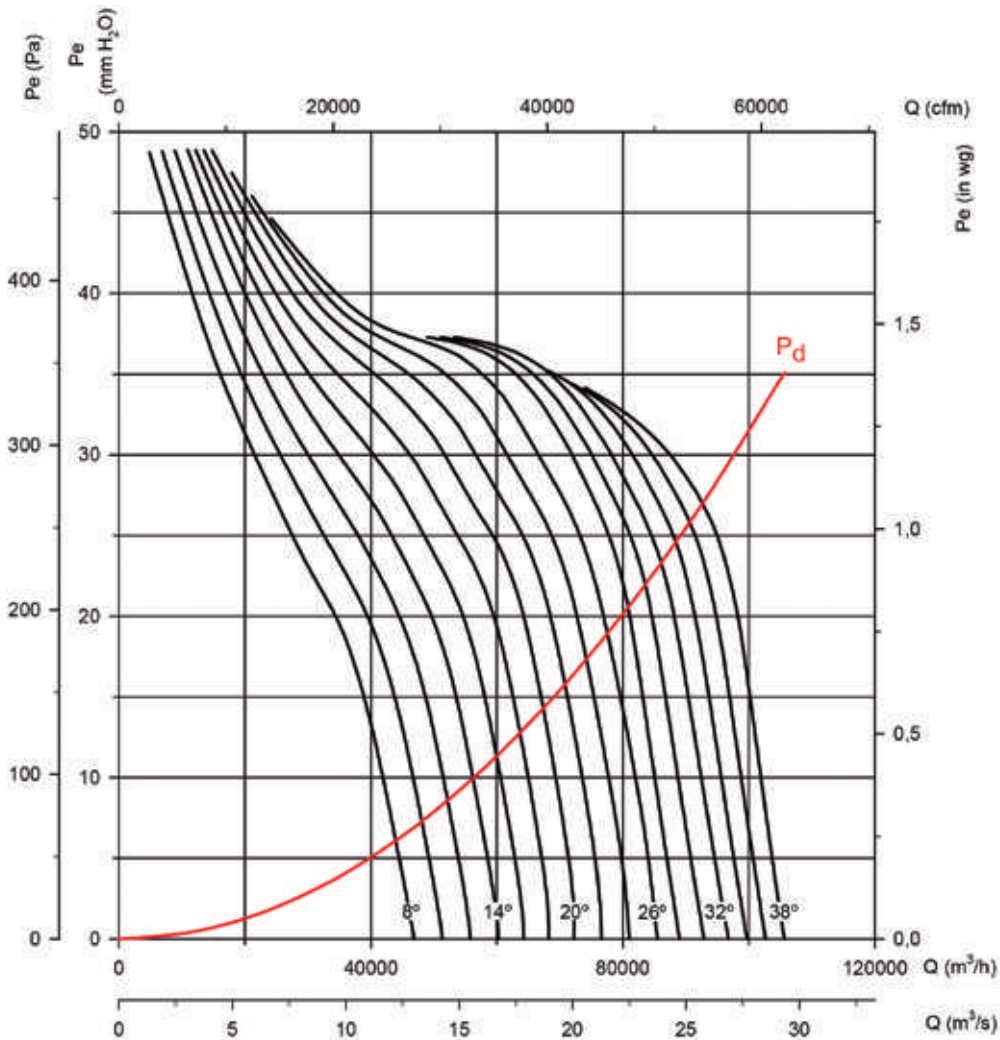

Potencia absorbida

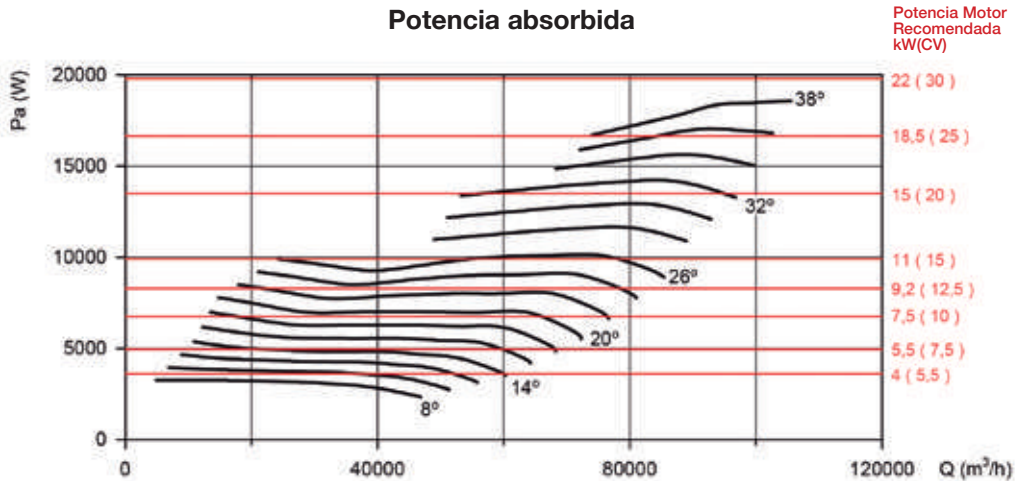



Curvas características

Q= Caudal en m³/h, m³/s y cfm. Pe= Presión estática en mmH₂O, Pa e inwg.

Diámetro Hélice (cm): 125 Número de polos: 6 Número de palas: 9

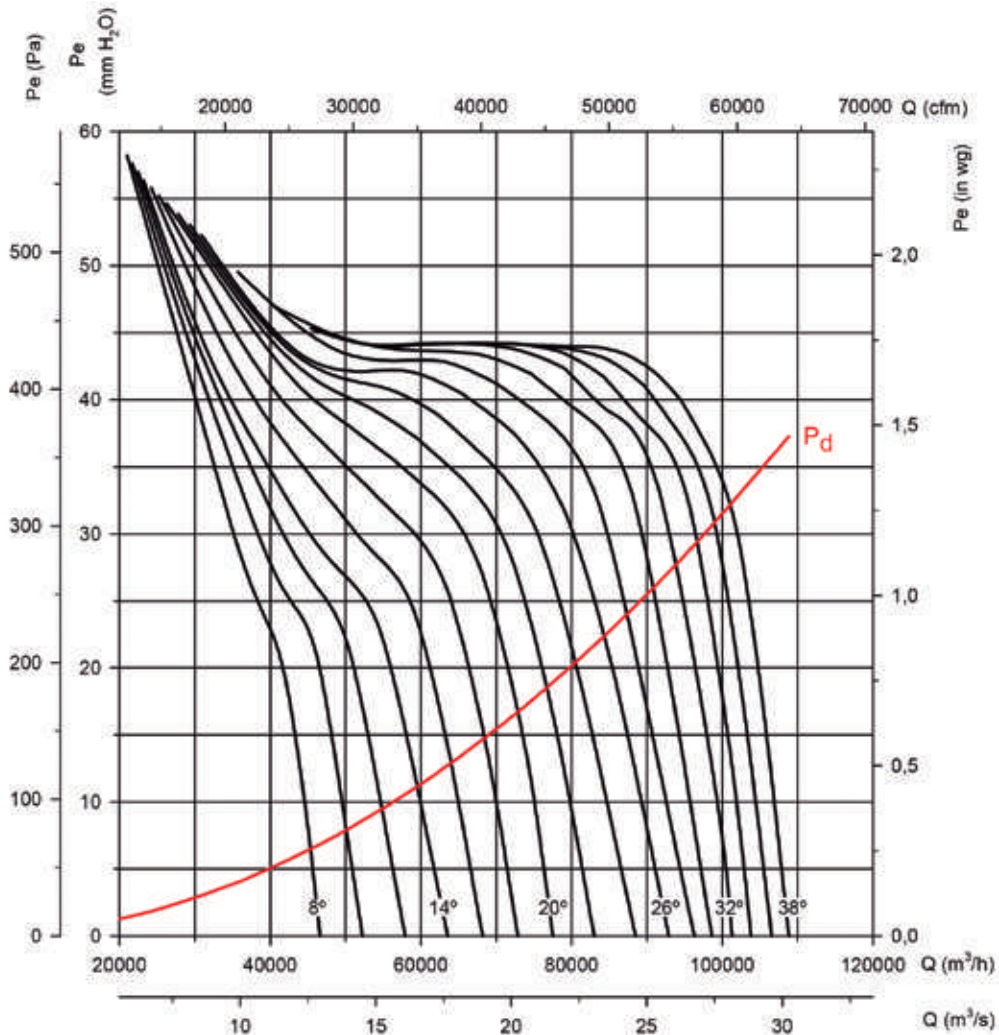

Potencia absorbida

Potencia Motor Recomendada kW(CV)

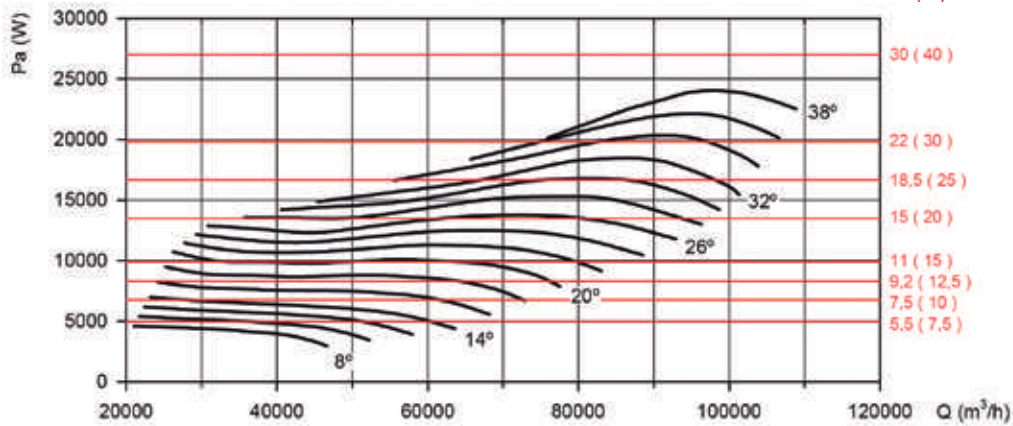

Curvas características

Q= Caudal en m³/h, m³/s y cfm. Pe= Presión estática en mmH₂O, Pa e inwg.

Diámetro Hélice (cm): 125 Número de polos: 8 Número de palas: 3

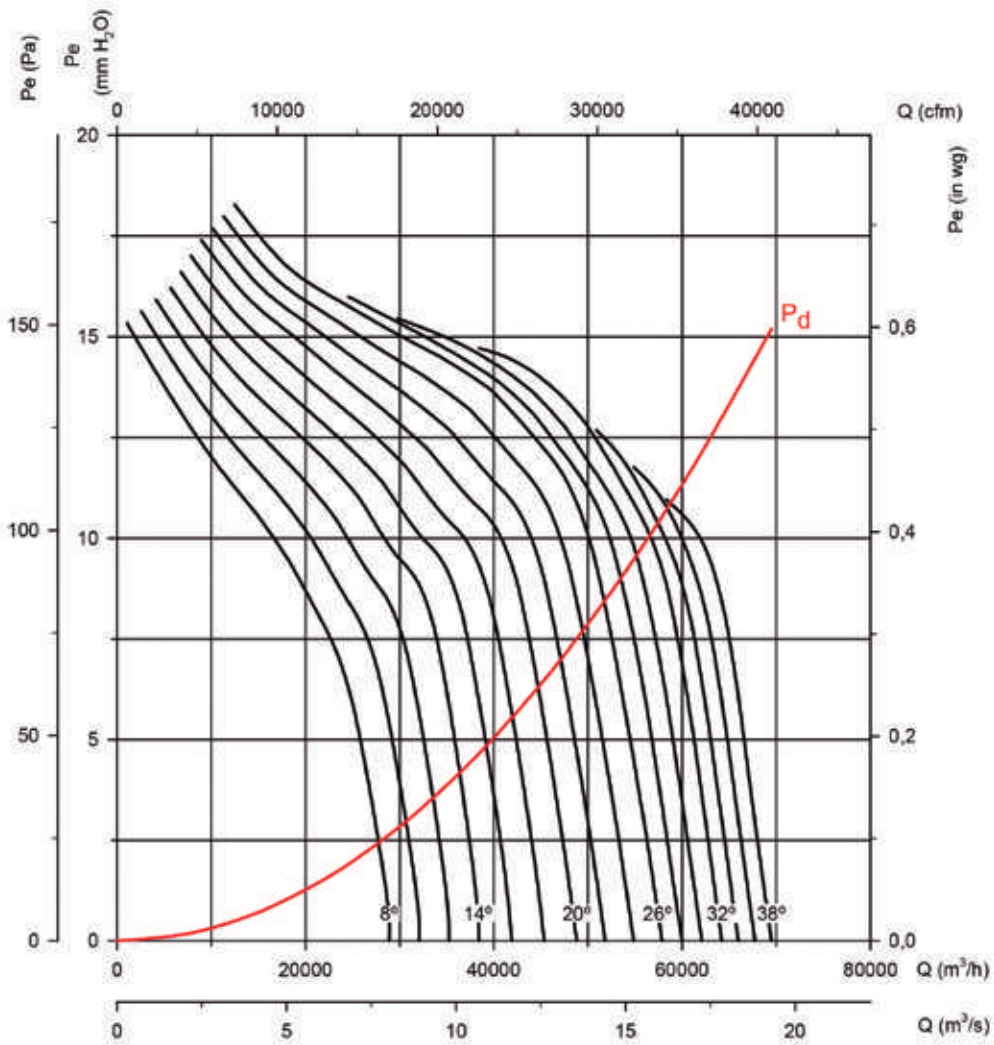

Potencia absorbida

Potencia Motor Recomendada kW(CV)

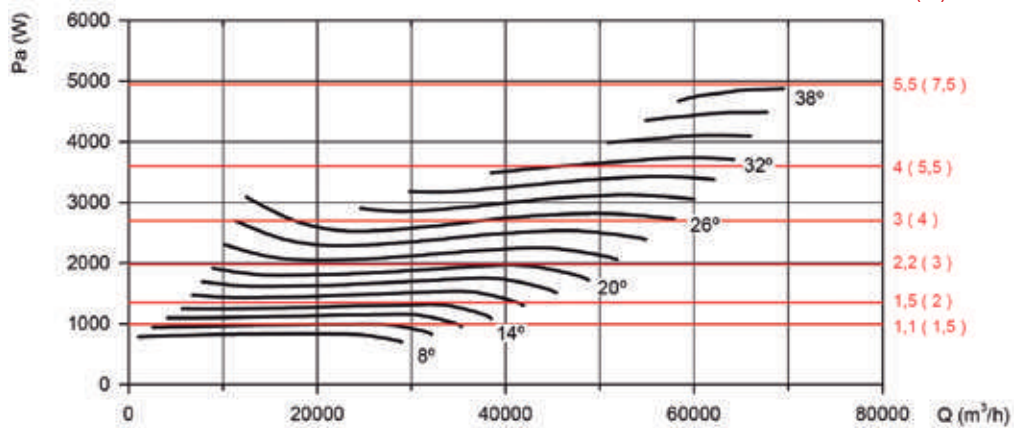

Curvas características

Q= Caudal en m³/h, m³/s y cfm. Pe= Presión estática en mmH₂O, Pa e inwg.

Diámetro Hélice (cm): 125

Número de polos: 8

Número de palas: 6

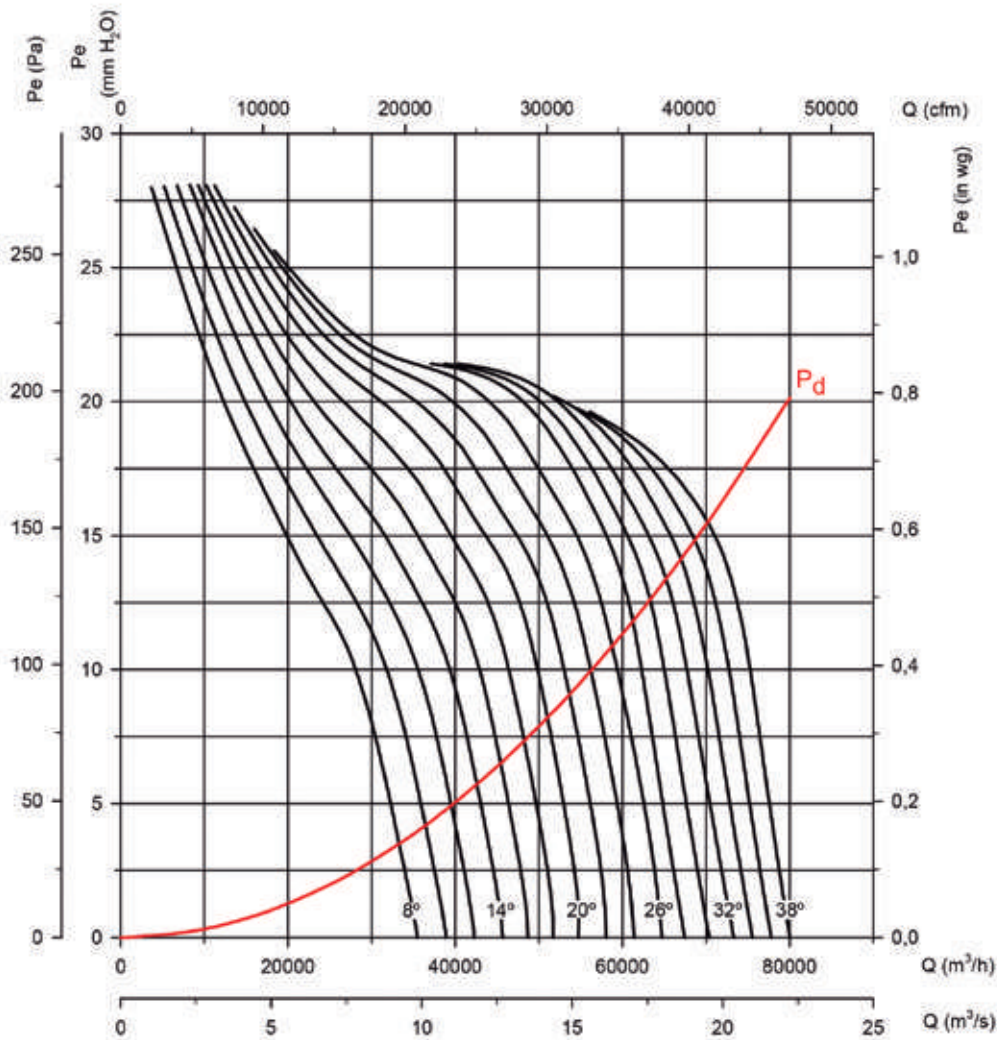

Potencia absorbida

Potencia Motor Recomendada kW(CV)

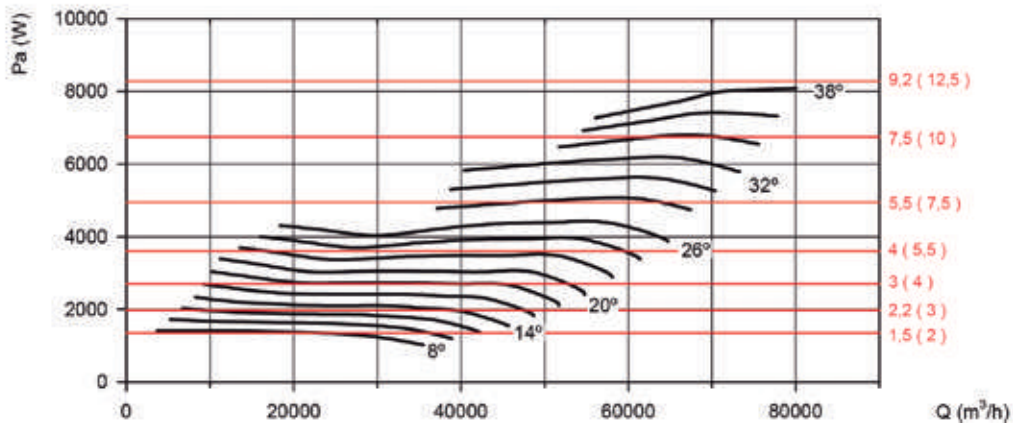

Curvas características

Q= Caudal en m³/h, m³/s y cfm. Pe= Presión estática en mmH₂O, Pa e inwg.

Diámetro Hélice (cm): 125 Número de polos: 8 Número de palas: 9

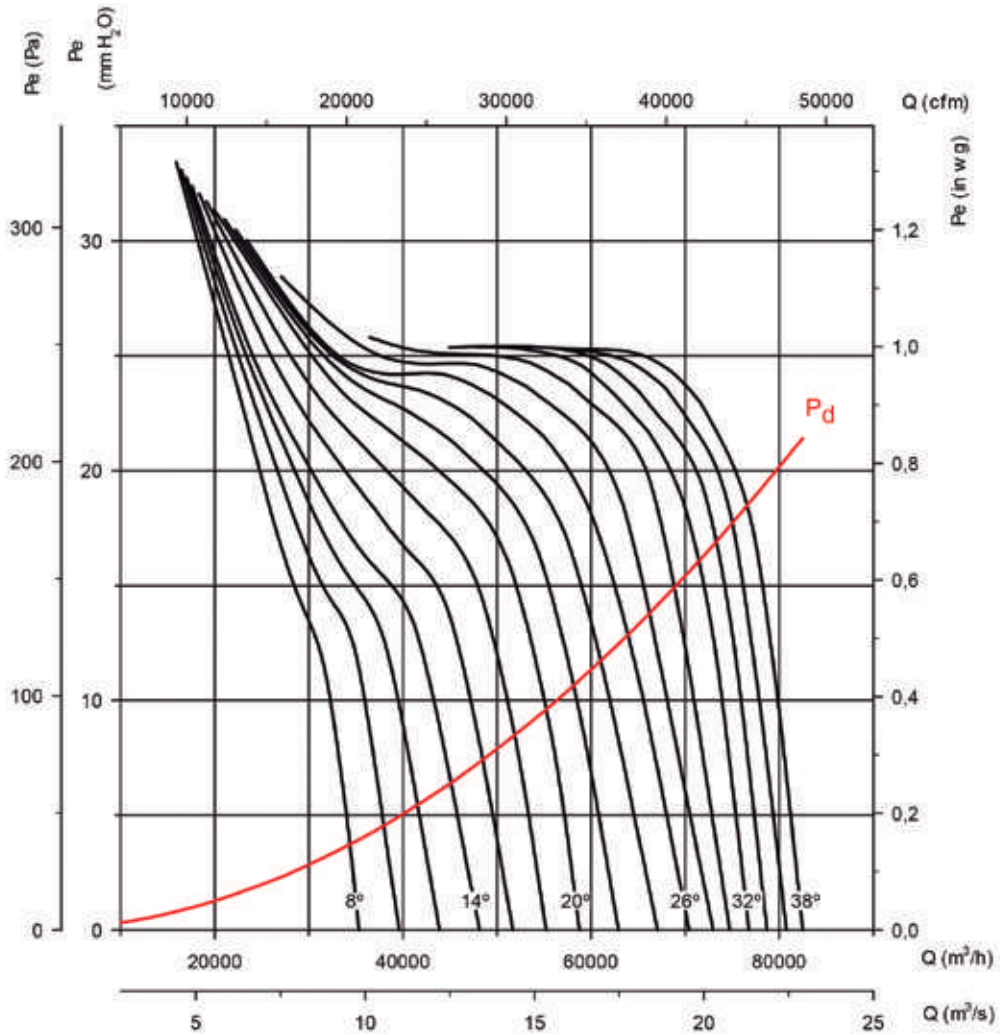

Potencia absorbida

Potencia Motor Recomendada kW(CV)

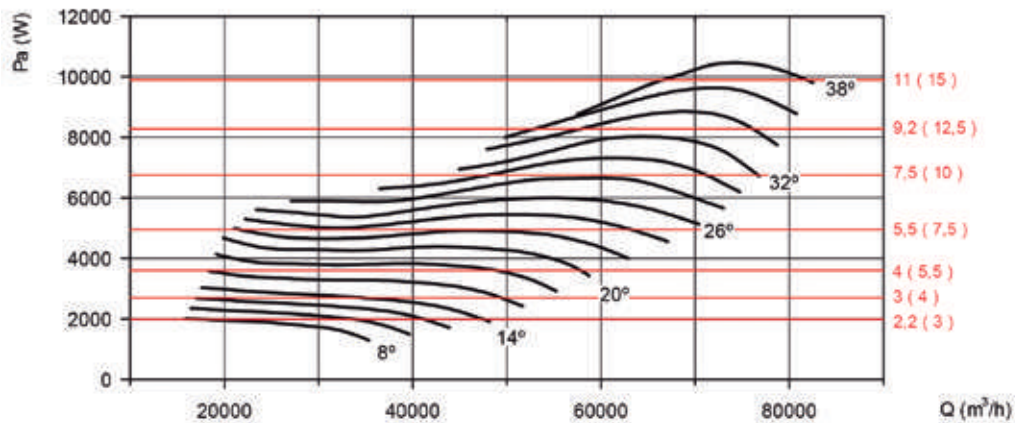



Curvas características

Q= Caudal en m³/h, m³/s y cfm. Pe= Presión estática en mmH₂O, Pa e inwg.

Diámetro Hélice (cm): 140

Número de polos: 6

Número de palas: 3

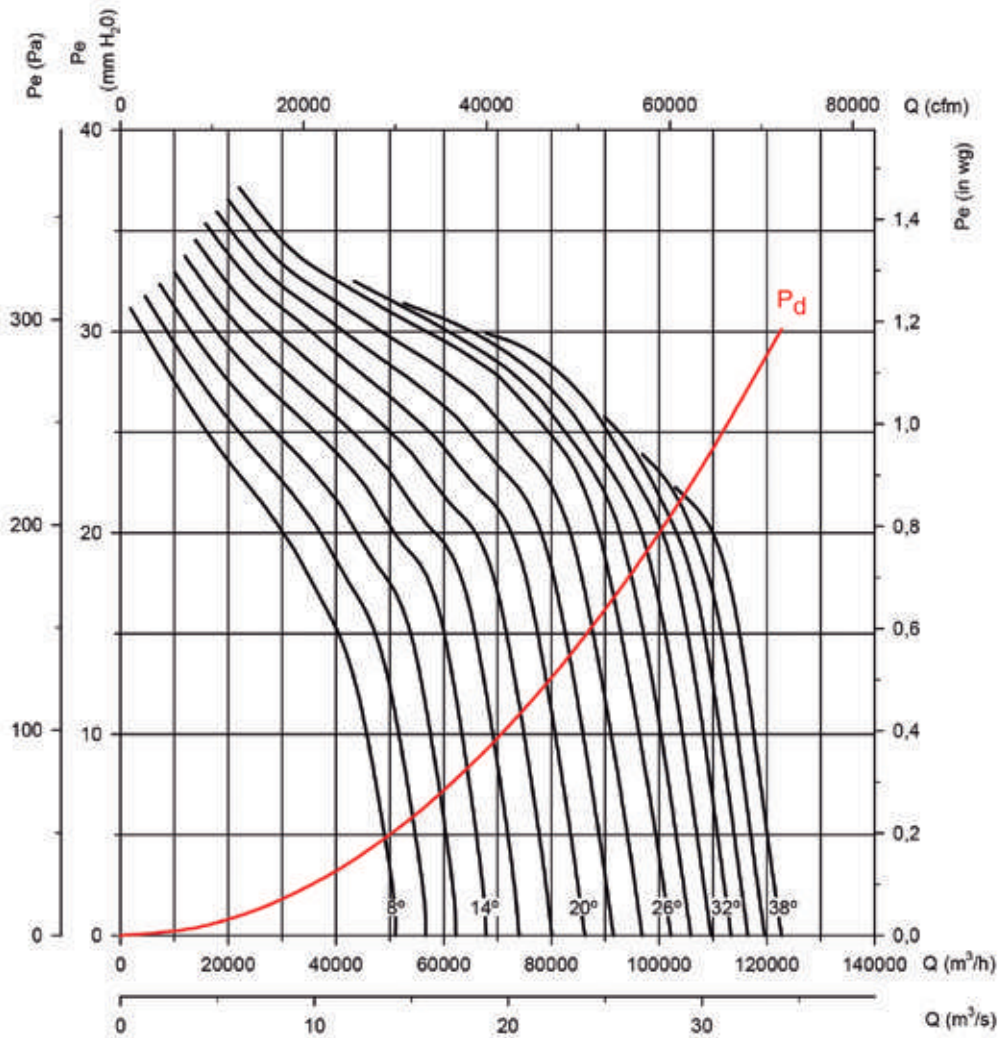

Potencia absorbida

Potencia Motor Recomendada kW(CV)

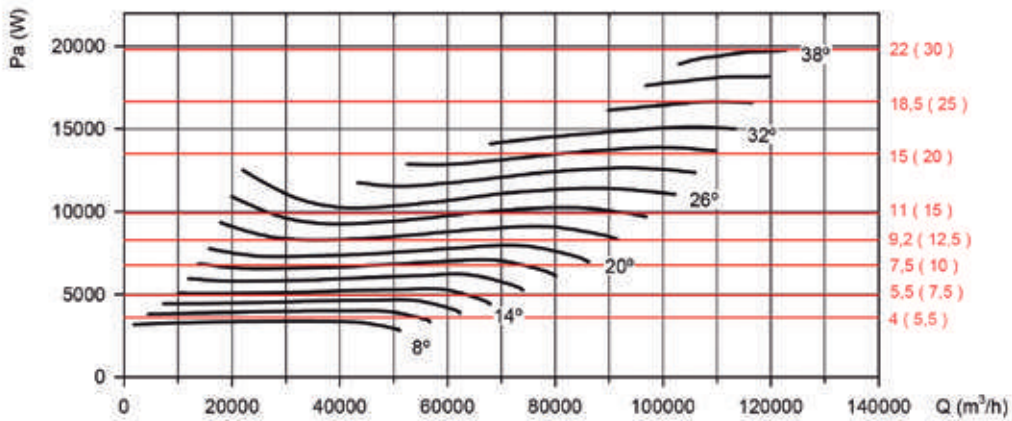

Curvas características

Q= Caudal en m³/h, m³/s y cfm. Pe= Presión estática en mmH₂O, Pa e inwg.

Diámetro Hélice (cm): 140 Número de polos: 6 Número de palas: 8

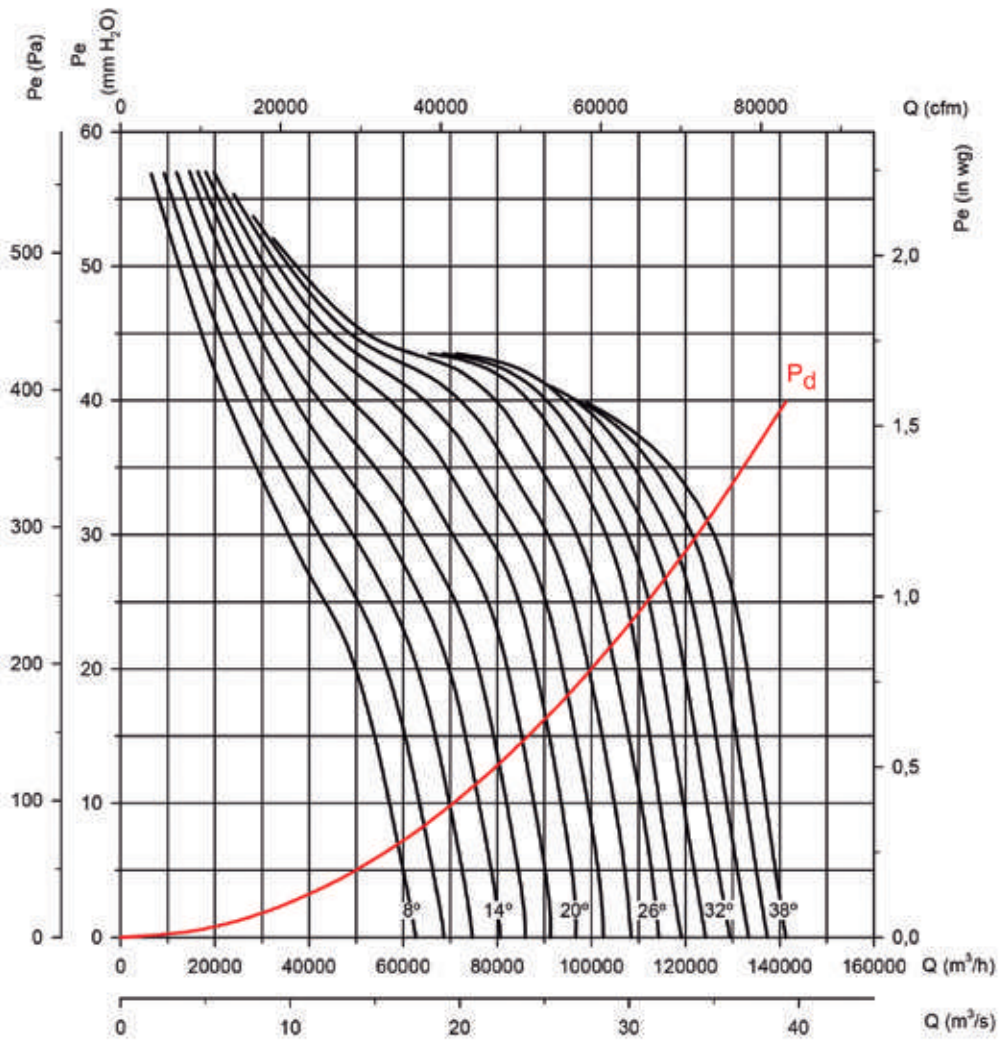

Potencia absorbida

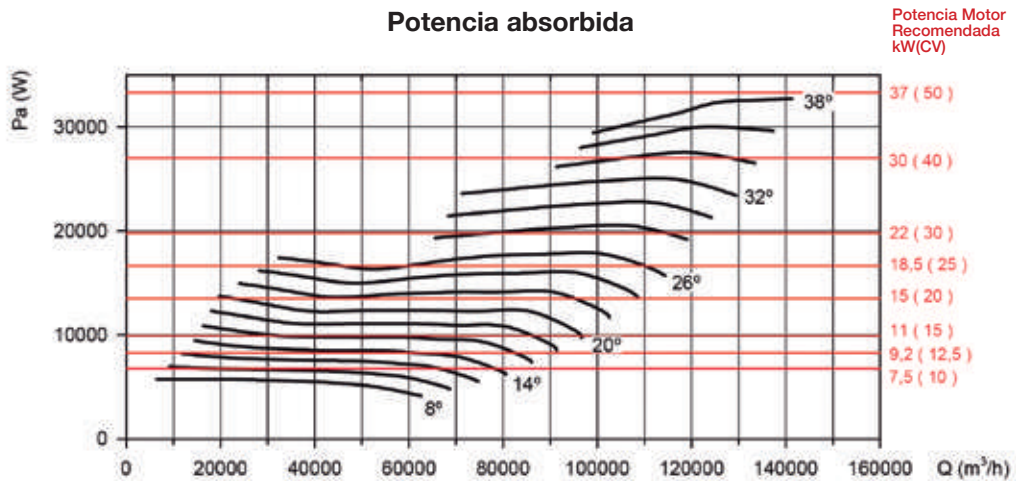

Potencia Motor Recomendada kW(CV)

Curvas características

Q= Caudal en m³/h, m³/s y cfm. Pe= Presión estática en mmH₂O, Pa e inwg.

Diámetro Hélice (cm): 140

Número de polos: 6

Número de palas: 9

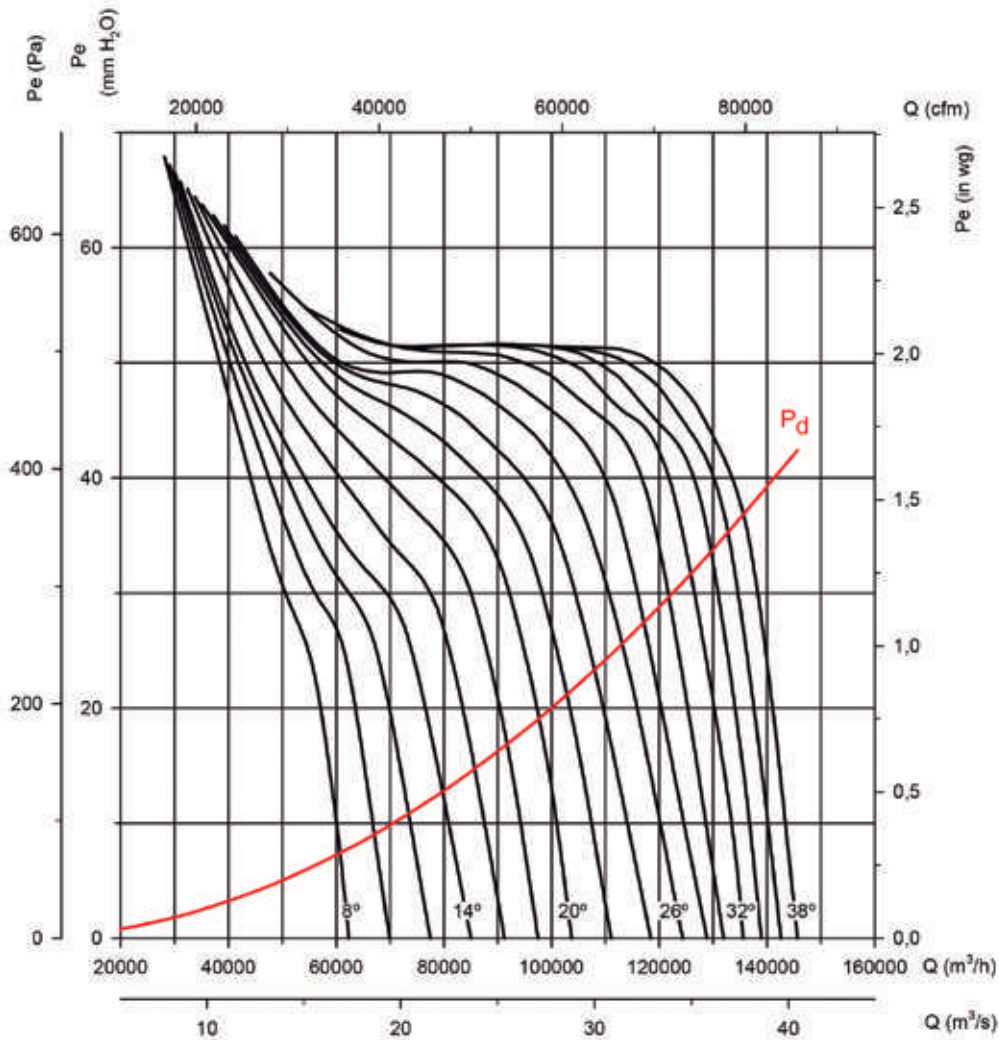

Potencia absorbida

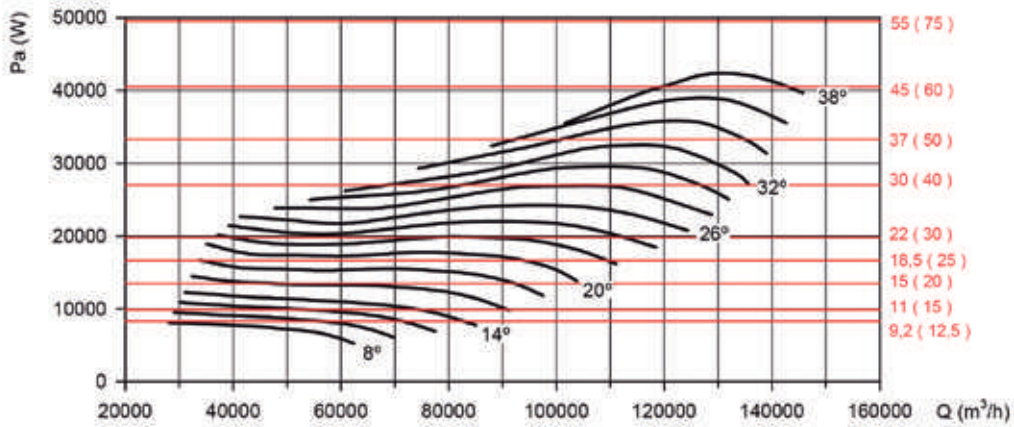

Potencia Motor Recomendada kW(CV)

Curvas características

Q= Caudal en m³/h, m³/s y cfm. Pe= Presión estática en mmH₂O, Pa e inwg.

Diámetro Hélice (cm): 140 Número de polos: 8 Número de palas: 3

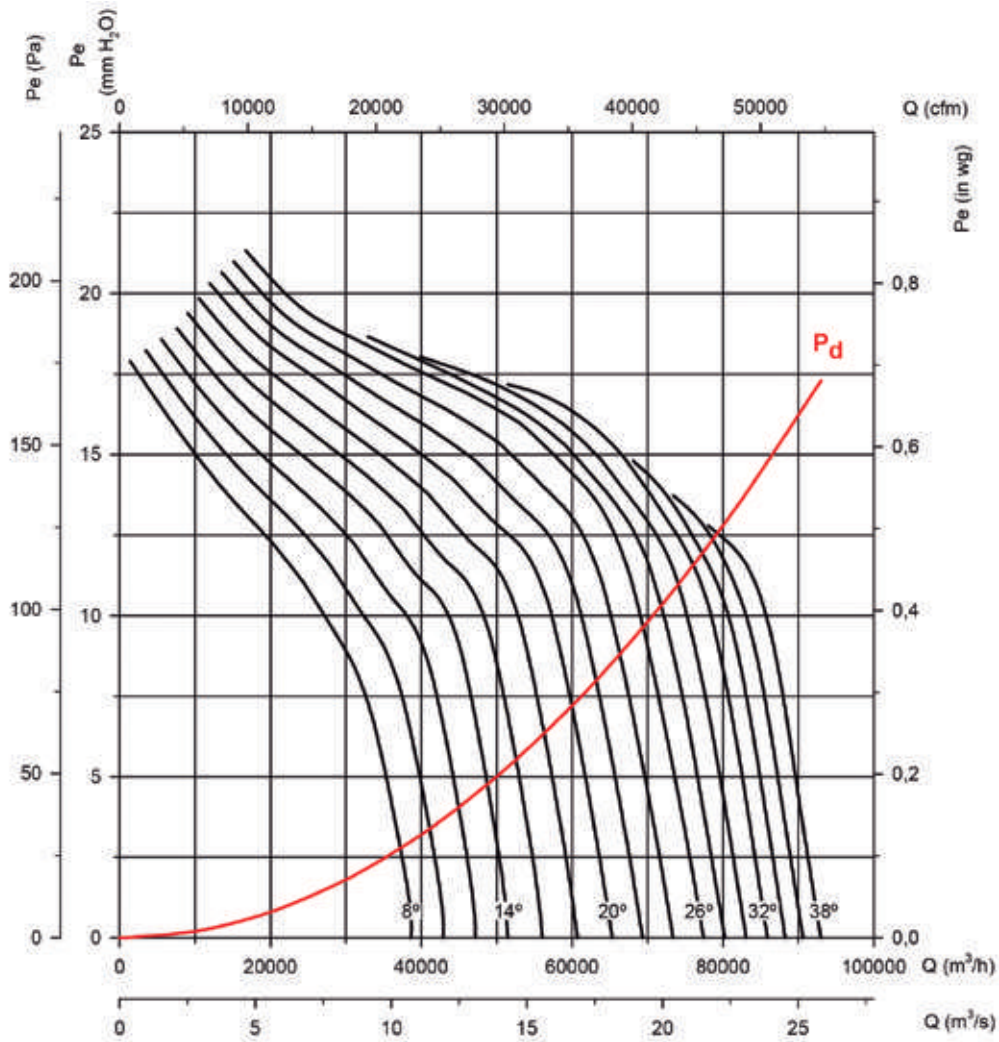

Potencia absorbida

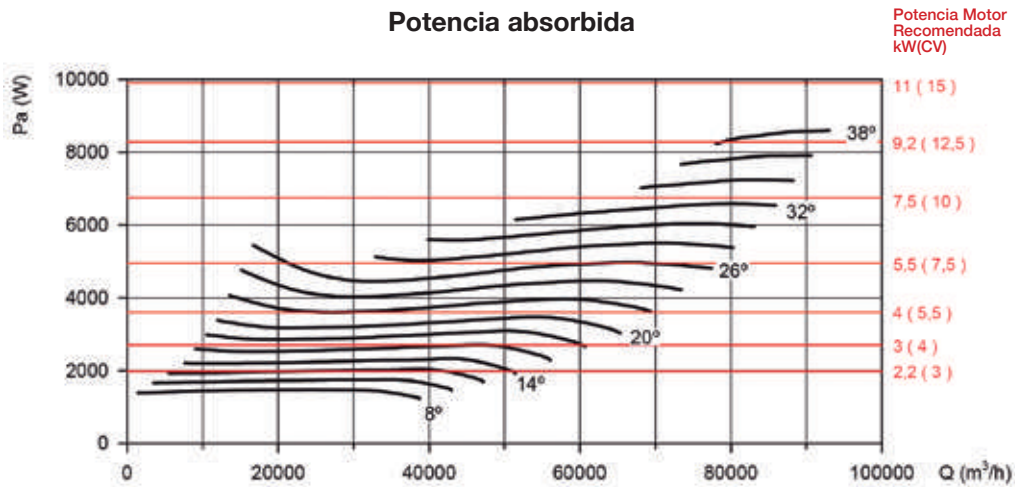



Curvas características

Q= Caudal en m³/h, m³/s y cfm. Pe= Presión estática en mmH₂O, Pa e inwg.

Diámetro Hélice (cm): 140 Número de polos: 8 Número de palas: 6

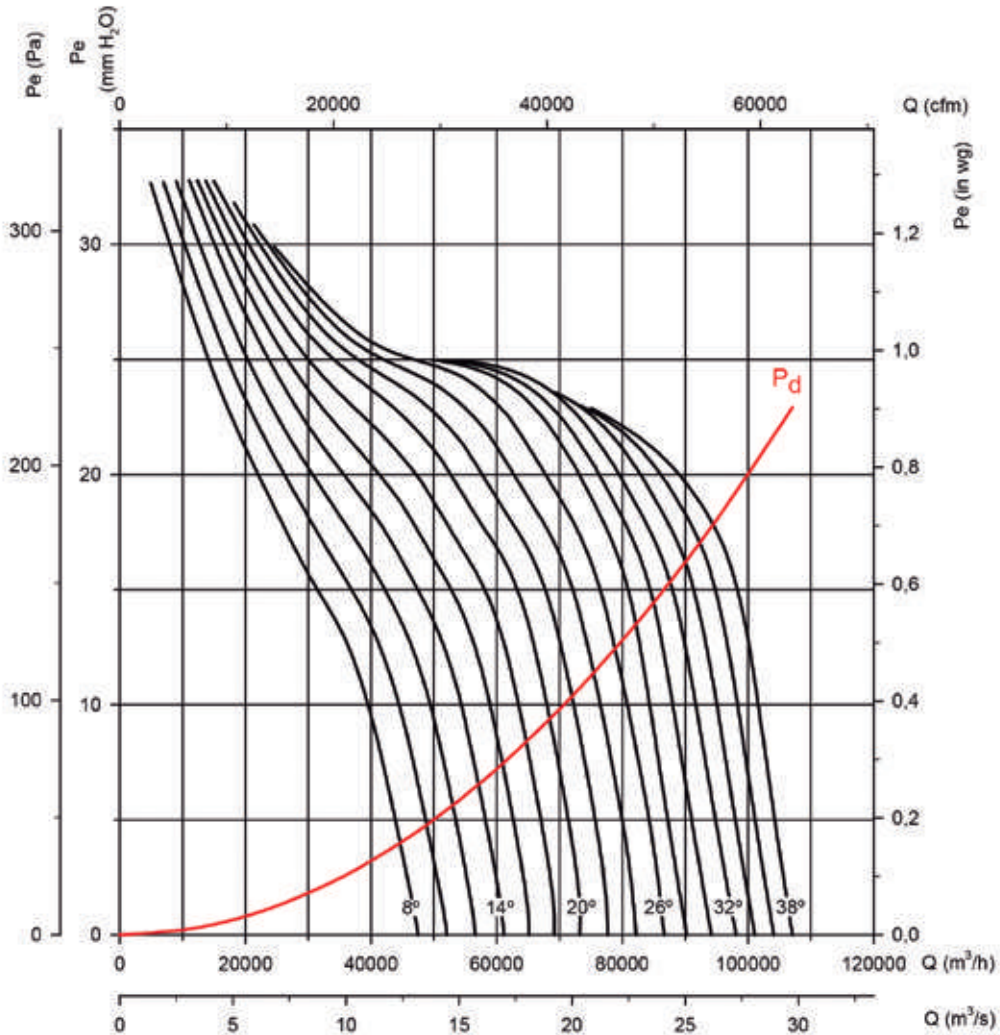

Potencia absorbida

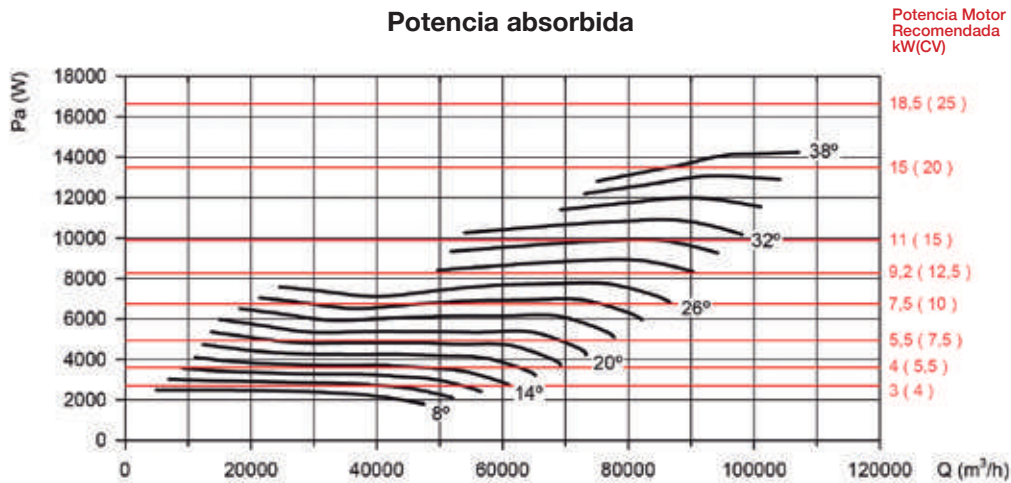

Potencia Motor Recomendada kW(CV)

Curvas características

Q= Caudal en m³/h, m³/s y cfm.

Pe= Presión estática en mmH₂O, Pa e inwg.

Diámetro Hélice (cm): 140

Número de polos: 8

Número de palas: 9

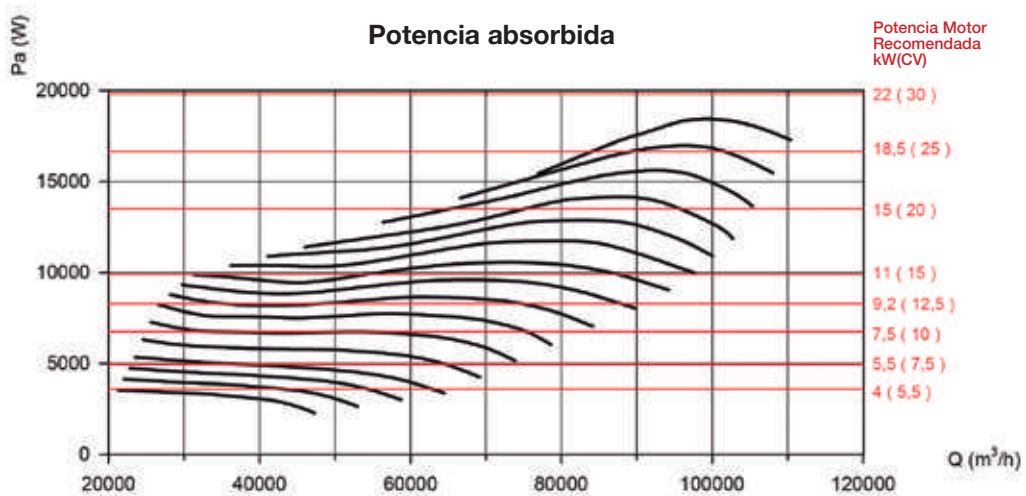
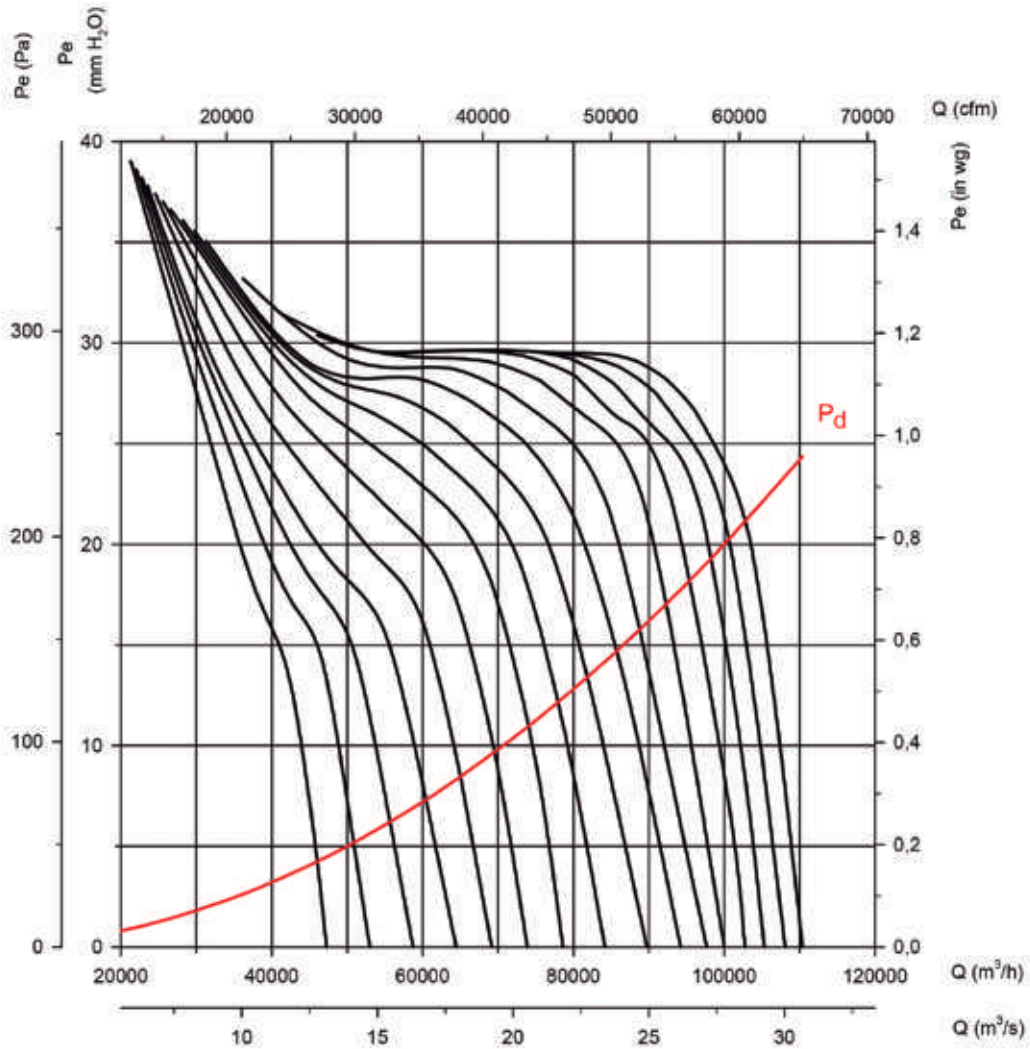



Curvas características

Q= Caudal en m³/h, m³/s y cfm. Pe= Presión estática en mmH₂O, Pa e inwg.

Diámetro Hélice (cm): 160 Número de polos: 6 Número de palas: 3

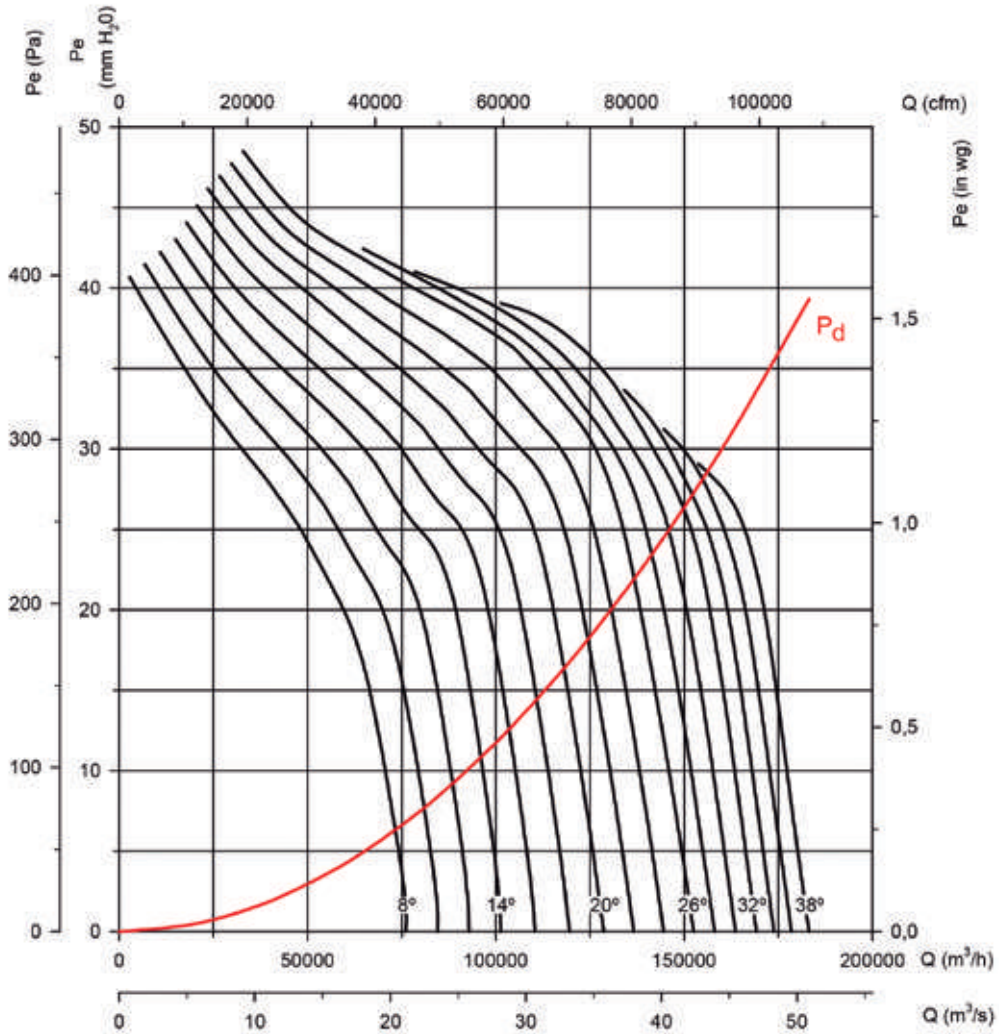

Potencia absorbida

Potencia Motor Recomendada kW(CV)

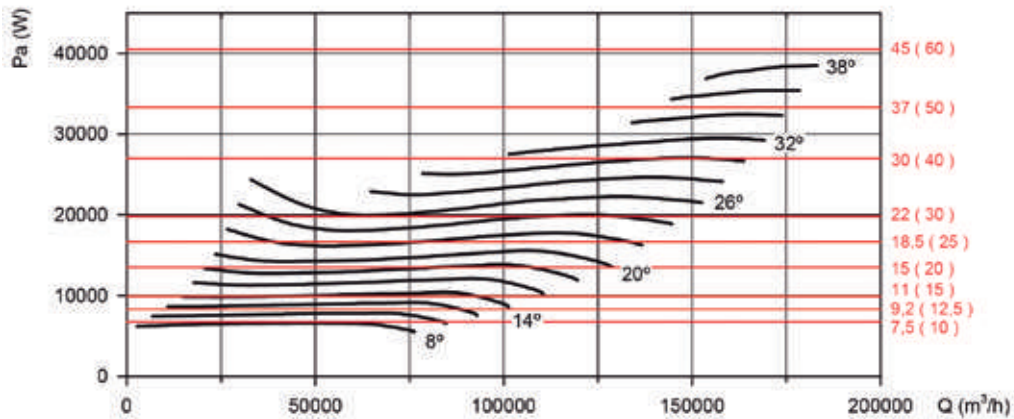

Curvas características

Q= Caudal en m³/h, m³/s y cfm. Pe= Presión estática en mmH₂O, Pa e inwg.

Diámetro Hélice (cm): 160 Número de polos: 6 Número de palas: 8

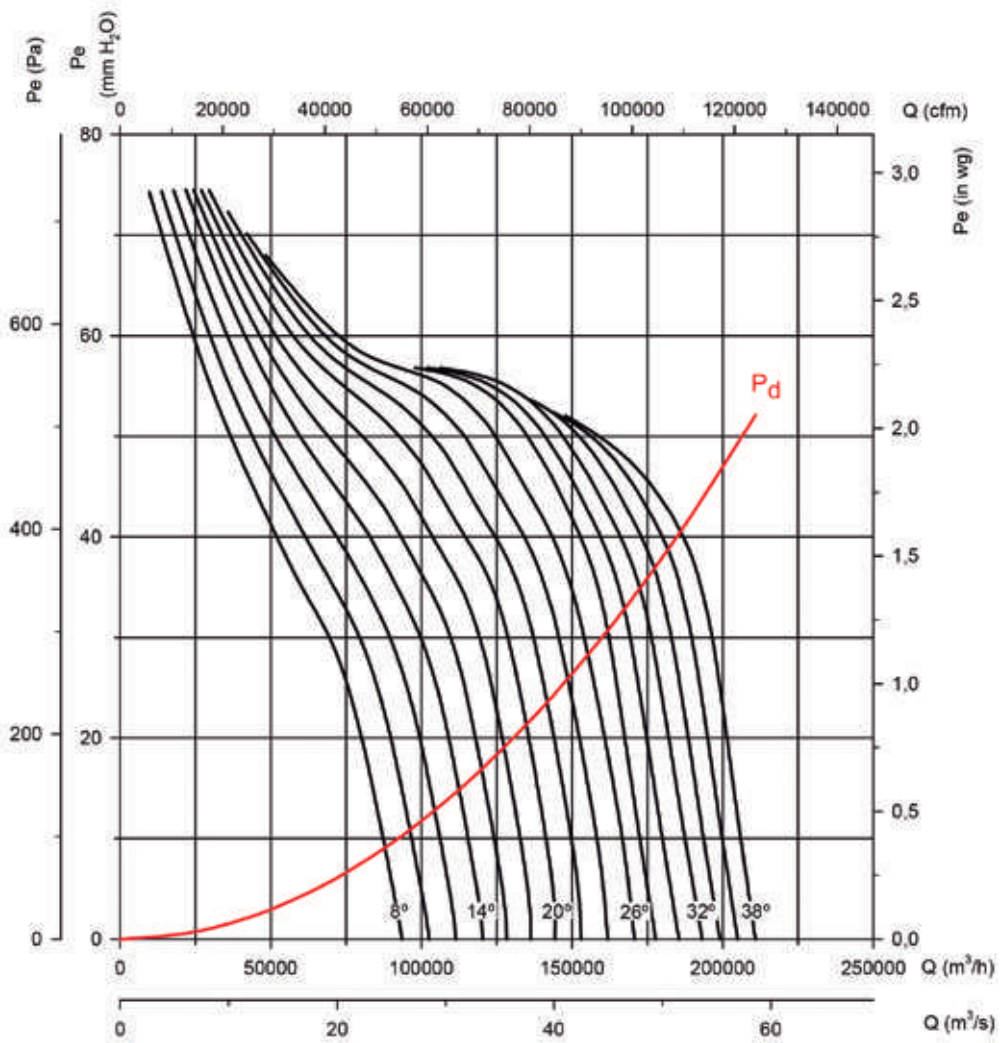

Potencia absorbida

Potencia Motor Recomendada kW(CV)

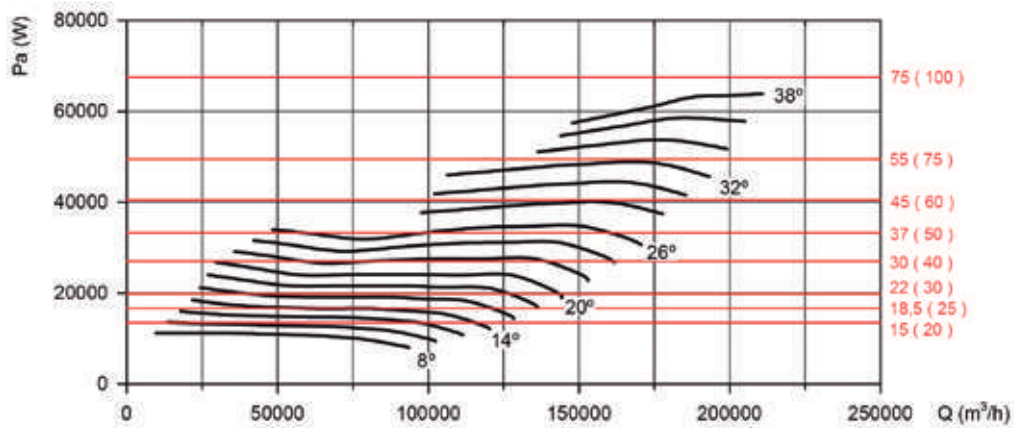

Curvas características

Q= Caudal en m³/h, m³/s y cfm. Pe= Presión estática en mmH₂O, Pa e inwg.

Diámetro Hélice (cm): 160 Número de polos: 6 Número de palas: 9

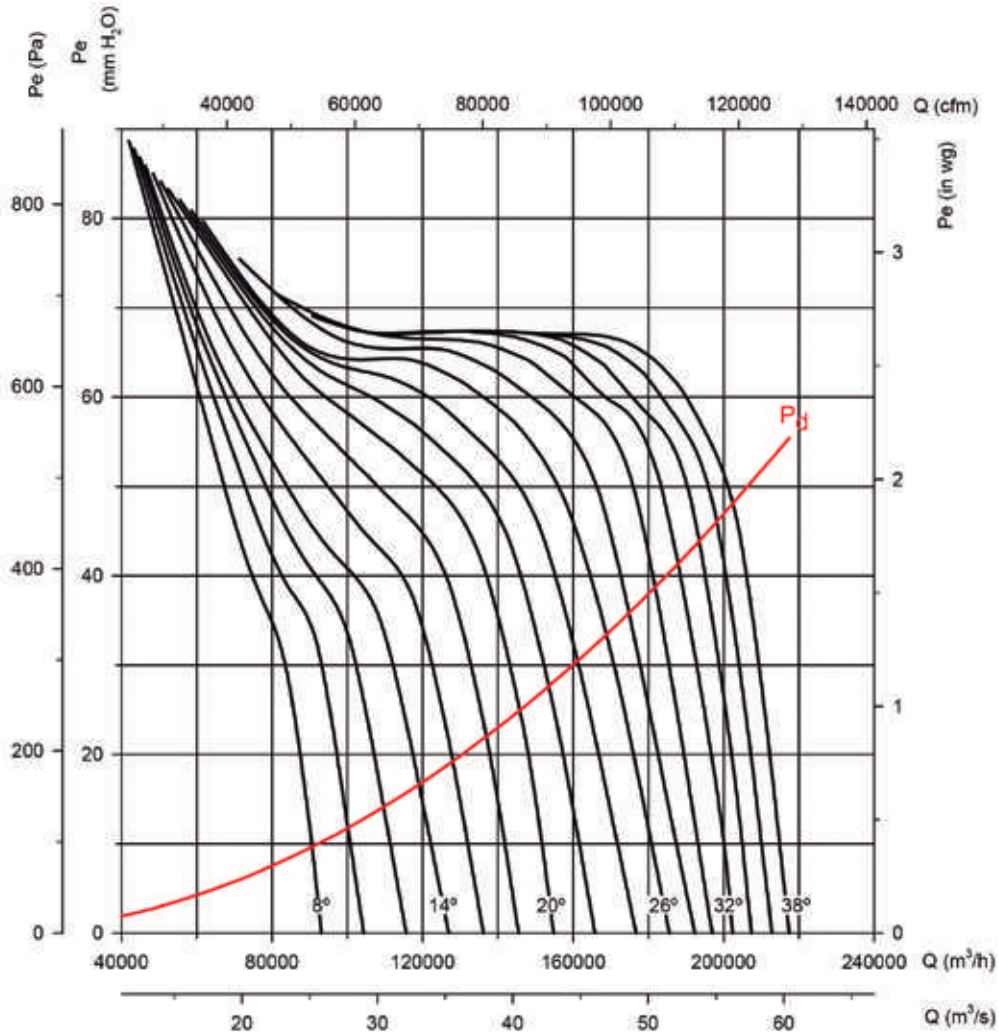

Potencia absorbida

Potencia Motor Recomendada kW(CV)

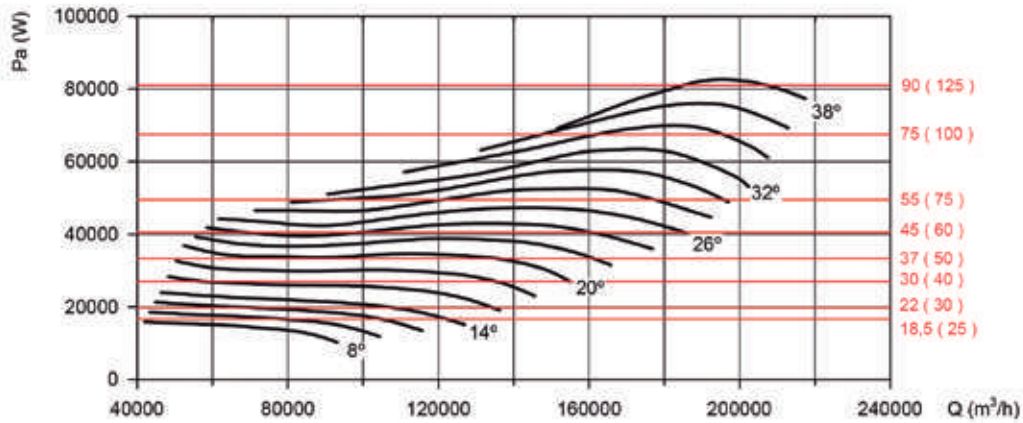

Curvas características

Q= Caudal en m³/h, m³/s y cfm. Pe= Presión estática en mmH₂O, Pa e inwg.

Diámetro Hélice (cm): 160 Número de polos: 8 Número de palas: 3

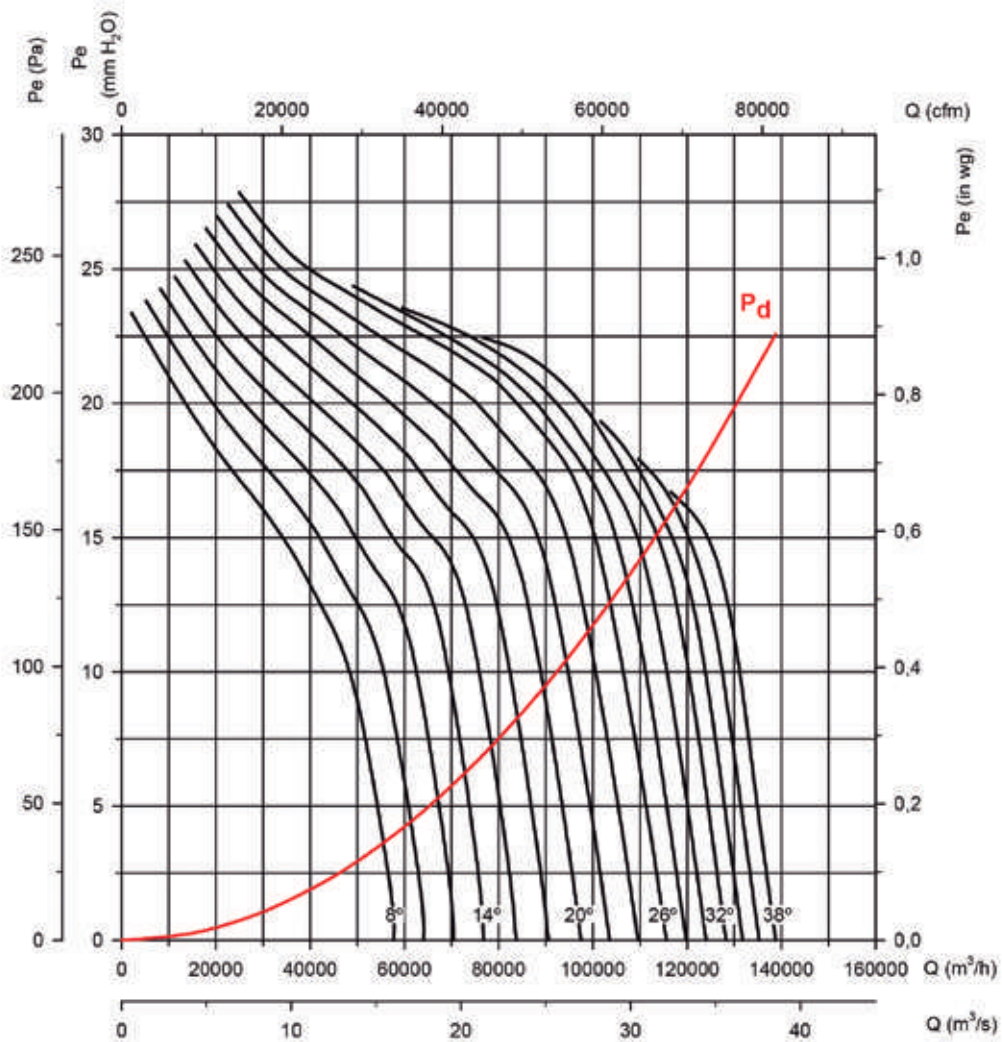

Potencia absorbida

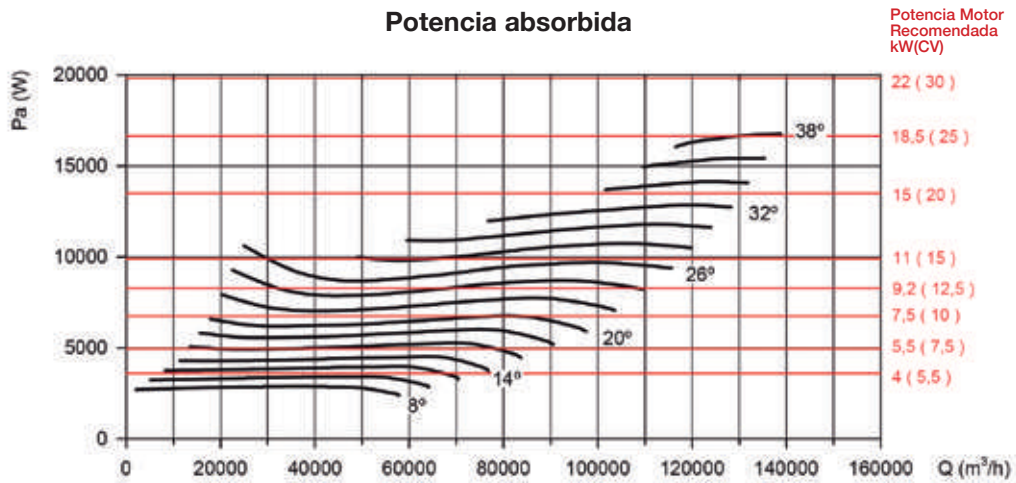

Curvas características

Q= Caudal en m³/h, m³/s y cfm. Pe= Presión estática en mmH₂O, Pa e inwg.

Diámetro Hélice (cm): 160

Número de polos: 8

Número de palas: 6

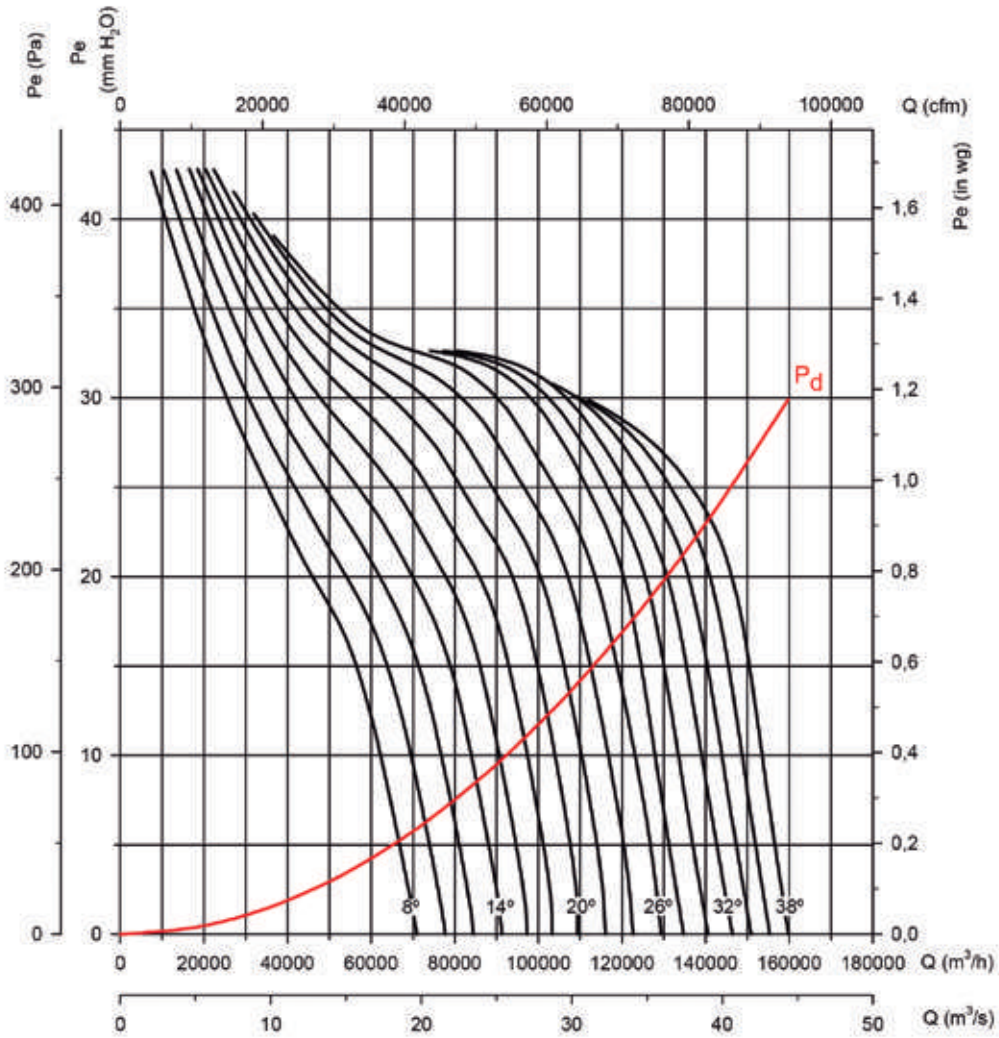

Potencia absorbida

Potencia Motor Recomendada kW(CV)

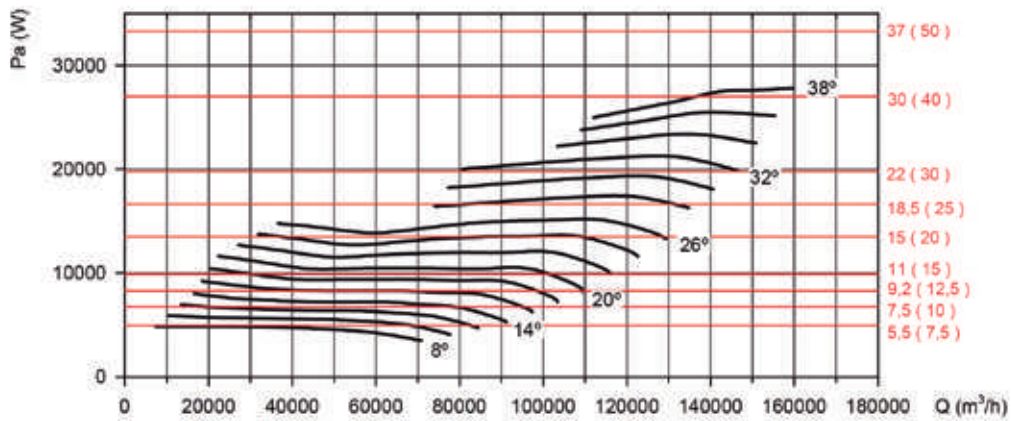

Curvas características

Q= Caudal en m³/h, m³/s y cfm. Pe= Presión estática en mmH₂O, Pa e inwg.

Diámetro Hélice (cm): 160 Número de polos: 8 Número de palas: 9

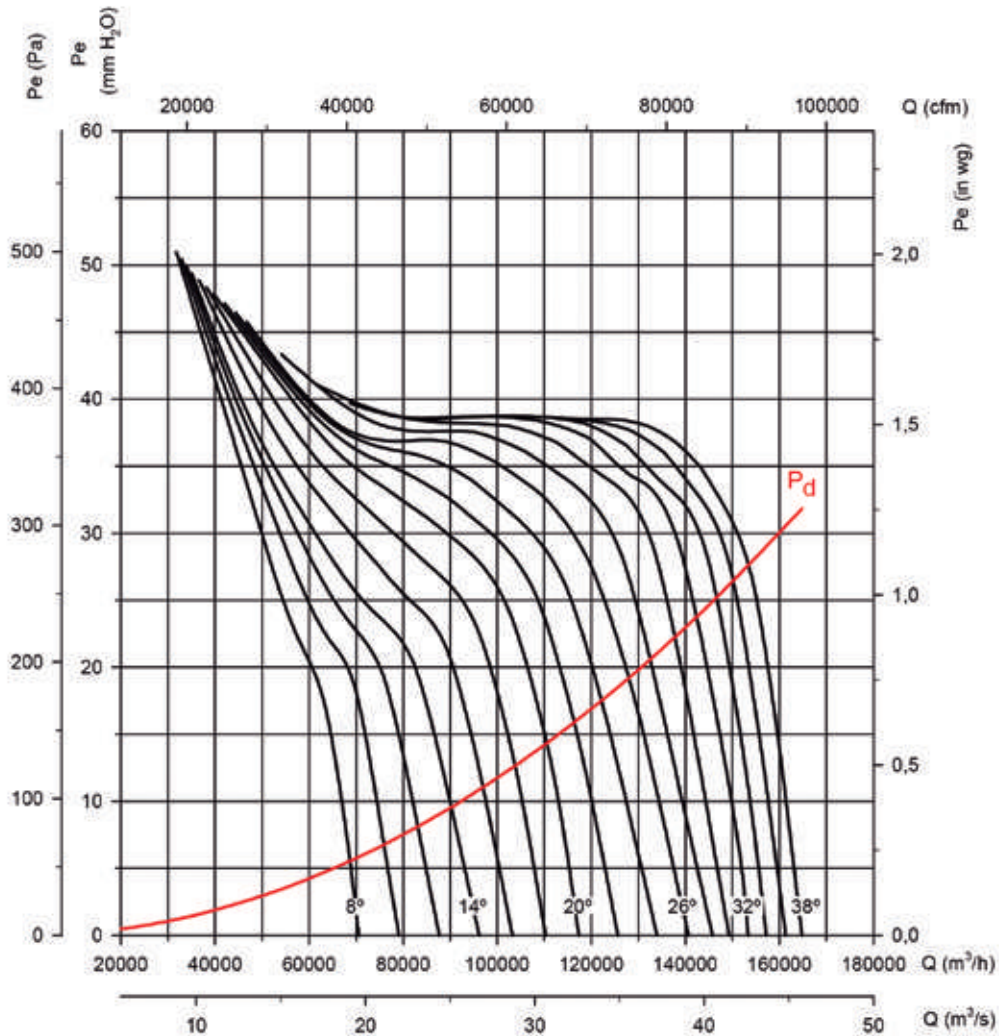

Potencia absorbida

Potencia Motor Recomendada kW(CV)

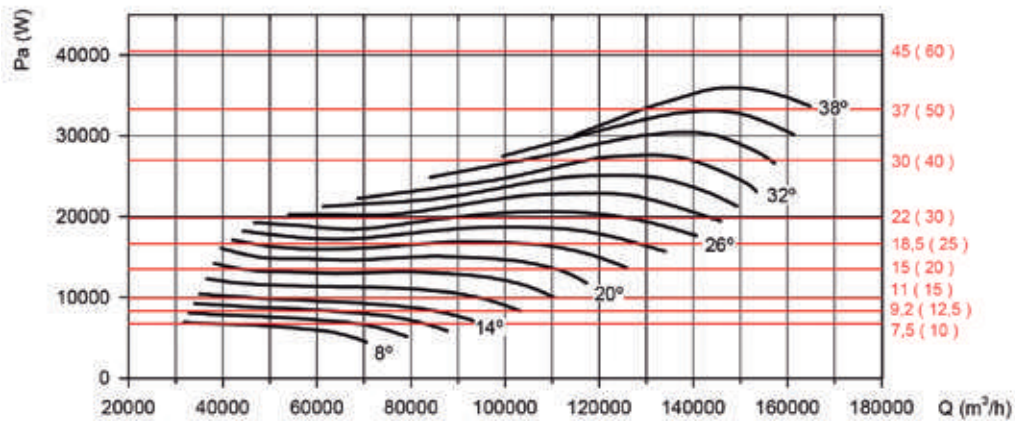

HCT/MAR



Extractores helicoidales tubulares para intercalar en conducto, de gran robustez para aplicaciones marinas y navales

Extractores helicoidales tubulares para intercalar en conducto, para trabajar en ambientes marinos y equipados con motor para servicio marino.

Ventilador:

- Envoltorio tubular en chapa de acero de gran robustez galvanizado en caliente, para intercalar entre conductos
- Hélice en fundición de aluminio
- Incorpora trampilla de inspección
- Dirección aire motor-hélice

Motor:

- Motores para servicio marino clase F, con rodamientos a bolas, protección IP55, con el cumplimiento de la clasificación para servicio naval no esencial.
- Motores de eficiencia IE3 para potencias iguales o superiores a 7,5kW, excepto monofásicos, 2 velocidades y 8 polos
- Trifásicos 230/400V.-50Hz.(hasta 4 kW) y 400/690V.-50Hz.(potencias superiores a 4 kW)
- Temperatura máxima del aire a transportar: -20°C.+ 60°C.

Acabado:

- Anticorrosivo galvanizado en caliente

Bajo demanda:

- Construcción en acero inoxidable
- Bobinados especiales para diferentes tensiones y frecuencias
- Construcción ATEX para diferentes categorías
- Motores con PTC incorporada
- Motores marinos para aplicaciones navales, con certificación para servicio esencial según diferentes entidades de clasificación (BV, DNV, LR)
- Motores de eficiencias IE2 e IE3 para cualquier potencia

Los motores marinos utilizados pueden estar certificados por la mayoría de entidades internacionales de clasificación naval:

ABS: América Bureau of shipping

BV: Bureau Veritas

CCS: China Classification Societies

CR: China Corporation Register of Shipping

DNV: Det Norske Veritas

GL: Germanischer Lloyd

KR: Korean Register of shipping

LR: Lloyd's Register of Shipping

NK: Nippon Kaiji Kyokai

RINA: Registro Italiano Navale

RS: Russian Maritime Register of Shipping

Código de pedido

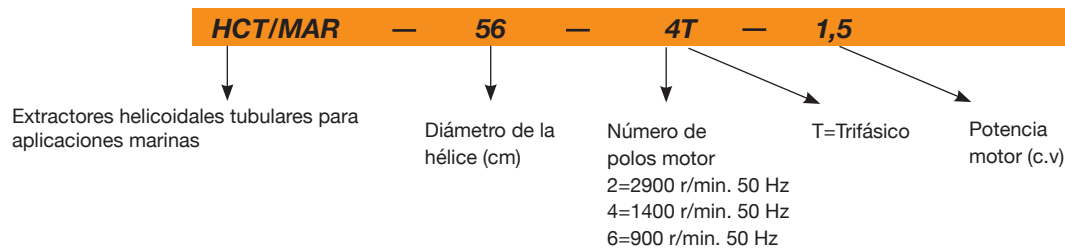

Características técnicas

Modelo	Velocidad (r/min)	Intensidad máxima admisible (A)			Potencia instalada (kW)	Caudal máximo (m³/h)	Nivel presión sonora dB(A)	Peso aprox. con motor (Kg)
		230V	400V	690V				
HCT/MAR-35-2T	2710	1,92	1,11		0,37	5750	77	13
HCT/MAR-35-4T	1320	0,65	0,38		0,09	3100	59	12
HCT/MAR-40-2T-1,5	2860	4,20	2,40		1,10	8800	84	27
HCT/MAR-40-4T-0,33	1350	1,66	0,96		0,25	5150	64	21
HCT/MAR-45-2T-2	2770	5,44	3,13		1,50	10650	86	30
HCT/MAR-45-2T-3	2885	7,77	4,47		2,20	12750	88	33
HCT/MAR-45-4T-0,5	1370	2,02	1,17		0,37	7100	68	25
HCT/MAR-50-4T-0,75	1380	2,92	1,69		0,55	10400	70	27
HCT/MAR-56-4T-0,75	1380	2,92	1,69		0,55	11050	72	32
HCT/MAR-56-4T-1	1410	3,10	1,79		0,75	12950	73	34
HCT/MAR-56-4T-1,5	1400	4,03	2,32		1,10	14000	74	36
HCT/MAR-56-4T-2	1430	5,96	3,44		1,50	15300	75	39

Dimensiones mm

HCT/MAR

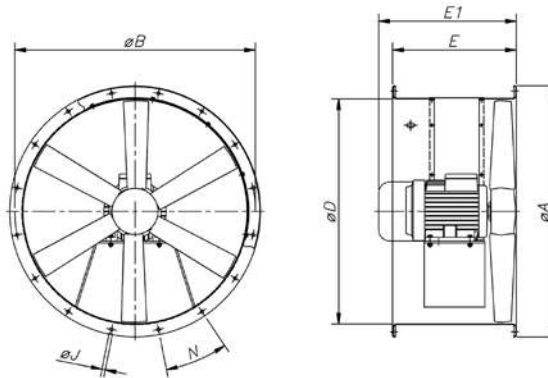

Modelo	ØA	ØB	ØD	E	E1	ØJ	N
HCT/MAR-35-2T	425	395	355	280	-	10	8x45°
HCT/MAR-35-4T	425	395	355	280	-	10	8x45°
HCT/MAR-40-2T-1,5	490	450	410	400	-	12	8x45°
HCT/MAR-40-4T-0,33	490	450	410	400	-	12	8x45°
HCT/MAR-45-2T-2	540	500	460	400	-	12	8x45°
HCT/MAR-45-2T-3	540	500	460	400	-	12	8x45°
HCT/MAR-45-4T-0,5	540	500	460	400	-	12	8x45°
HCT/MAR-50-4T-0,75	600	560	514	400	-	12	12x30°
HCT/MAR-56-4T-0,75	660	620	560	400	-	12	12x30°
HCT/MAR-56-4T-1	660	620	560	400	-	12	12x30°
HCT/MAR-56-4T-1,5	660	620	560	400	-	12	12x30°
HCT/MAR-56-4T-2	660	620	560	400	-	12	12x30°
HCT/MAR-56-6T-0,33	660	620	560	400	-	12	12x30°
HCT/MAR-56-6T-0,5	660	620	560	400	-	12	12x30°
HCT/MAR-56-6T-0,75	660	620	560	400	-	12	12x30°
HCT/MAR-63-4T-1	730	690	640	400	-	12	12x30°
HCT/MAR-63-4T-1,5	730	690	640	400	-	12	12x30°
HCT/MAR-63-4T-2	730	690	640	400	-	12	12x30°
HCT/MAR-63-4T-3	730	690	640	500	-	12	12x30°
HCT/MAR-63-4T-4	730	690	640	500	-	12	12x30°
HCT/MAR-63-6T-0,5	730	690	640	400	-	12	12x30°
HCT/MAR-63-6T-0,75	730	690	640	400	-	12	12x30°
HCT/MAR-63-6T-1	730	690	640	400	-	12	12x30°
HCT/MAR-71-4T-1,5	810	770	710	430	-	12	16x22°30'
HCT/MAR-71-4T-2	810	770	710	430	-	12	16x22°30'
HCT/MAR-71-4T-3	810	770	710	500	-	12	16x22°30'

Modelo	ØA	ØB	ØD	E	E1	ØJ	N
HCT/MAR-71-4T-4	810	770	710	500	-	12	16x22°30'
HCT/MAR-71-6T-0,75	810	770	710	430	-	12	16x22°30'
HCT/MAR-71-6T-1	810	770	710	500	-	12	16x22°30'
HCT/MAR-71-6T-1,5	810	770	710	500	-	12	16x22°30'
HCT/MAR-80-4T-3	900	860	800	500	-	12	16x22°30'
HCT/MAR-80-4T-4	900	860	800	500	-	12	16x22°30'
HCT/MAR-80-4T-5,5	900	860	800	500	-	12	16x22°30'
HCT/MAR-80-6T-1	900	860	800	500	-	12	16x22°30'
HCT/MAR-80-6T-1,5	900	860	800	500	-	12	16x22°30'
HCT/MAR-80-6T-2	900	860	800	500	-	12	16x22°30'
HCT/MAR-80-6T-3	900	860	800	500	-	12	16x22°30'
HCT/MAR-90-4T-4	1015	970	900	600	-	15	16x22°30'
HCT/MAR-90-4T-5,5	1015	970	900	600	-	15	16x22°30'
HCT/MAR-90-4T-7,5	1015	970	900	600	-	15	16x22°30'
HCT/MAR-90-4T-10	1015	970	900	600	-	15	16x22°30'
HCT/MAR-90-6T-2	1015	970	900	600	-	15	16x22°30'
HCT/MAR-90-6T-3	1015	970	900	600	-	15	16x22°30'
HCT/MAR-90-6T-4	1015	970	900	600	-	15	16x22°30'
HCT/MAR-100-4T-7,5	1115	1070	1000	600	-	15	16x22°30'
HCT/MAR-100-4T-10	1115	1070	1000	600	-	15	16x22°30'
HCT/MAR-100-4T-15	1115	1070	1000	700	-	15	16x22°30'
HCT/MAR-100-4T-20	1115	1070	1000	700	-	15	16x22°30'
HCT/MAR-100-6T-3	1115	1070	1000	600	-	15	16x22°30'
HCT/MAR-100-6T-4	1115	1070	1000	600	-	15	16x22°30'
HCT/MAR-100-6T-5,5	1115	1070	1000	600	-	15	16x22°30'

Curvas Características

Ver curvas características de la serie HCT/ATEX

HTMH



Extractores de cubierta multifuncional para grandes caudales



Extractores de cubierta multifuncionales de robusta construcción para extracción de grandes caudales

Ventilador:

- Base soporte en chapa de acero galvanizada pintada
- Hélices orientables en fundición de aluminio
- Rejilla de protección contra contactos según norma UNE-EN ISO 12499
- Sombbrero en chapa de acero galvanizada pintada, con salida de aire natural.

Motor:

- Motores de eficiencia IE2 para potencias iguales o superiores a 0,75kW e inferiores a 7,5kW, excepto monofásicos, 2 velocidades y 8 polos
- Motores de eficiencia IE3 para potencias iguales o superiores a 7,5kW, excepto monofásicos, 2 velocidades y 8 polos
- Motores clase F, con rodamientos a bolas, protección IP55, de 1 ó 2 velocidades según modelo
- Trifásicos 230/400V.-50Hz.(hasta 4 kW) y 400/690V.-50Hz.(potencias superiores a 4 kW)
- Temperatura de trabajo : -25°C.+ 50°C.

Acabado:

- Anticorrosivo en resina de poliéster polimerizada a 190 °C, previo desengrase con tratamiento nanotecnológico libre de fosfatos.
- Calidad acabado superficial C4H

Bajo demanda:

- Motores ATEX y de 2 Velocidades
- Construcción total en acero inoxidable
- Construcción en acero galvanizado en caliente
- Motores marinos para aplicaciones navales, con certificación para servicio esencial según diferentes entidades de clasificación (BV, DNV, LR)
- Motores CE, NEMA, UL, CSA
- Calidad acabado superficial C5M
- Motores de eficiencias IE2 e IE3 para cualquier potencia

Código de pedido

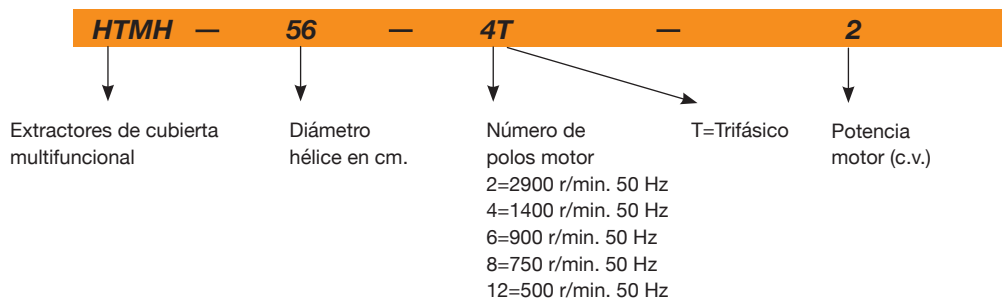

Características técnicas

Modelo	Velocidad (r/min)	Intensidad máxima admisible (A)			Potencia instalada (kW)	Caudal máximo (m³/h)	Nivel presión sonora dB(A)		Peso aprox. (Kg)	According ErP
		230V	400V	690V			Aspiración	Descarga		
HTMH-56-4T-1	1410	2,83	1,63		0,75	10545	62	59	67	2015
HTMH-56-4T-1.5	1400	4,03	2,32		1,10	11400	63	60	69	2015
HTMH-56-6T-0.75	910	2,59	1,49		0,55	8170	51	49	67	2015
HTMH-63-4T-1.5	1400	4,03	2,32		1,10	13870	65	62	81	2015
HTMH-63-4/8T-1.5	1440 / 710		2,90 / 1,30		1,10 / 0,25	13870 / 6935	65 / 50	62 / 47	79	2015
HTMH-63-4T-2	1440	5,67	3,26		1,50	15485	66	63	87	2015
HTMH-63-4/8T-2	1420 / 700		3,50 / 1,50		1,50 / 0,37	15485 / 7742	66 / 51	63 / 48	80	2015
HTMH-63-4T-3	1435	8,07	4,64		2,20	17955	67	64	96	2015
HTMH-63-4/8T-3	1430 / 710		4,90 / 1,70		2,20 / 0,45	17955 / 8977	67 / 52	64 / 49	86	2015
HTMH-63-6T-0.75	910	2,59	1,49		0,55	10260	56	54	79	2015
HTMH-63-6T-1	925	3,39	1,95		0,75	11305	57	55	84	2015
HTMH-71-4T-2	1440	5,67	3,26		1,50	16150	69	66	93	2015
HTMH-71-4/8T-2	1420 / 700		3,50 / 1,50		1,50 / 0,37	16150 / 8075	69 / 54	66 / 51	86	2015
HTMH-71-4T-3	1435	8,07	4,64		2,20	18430	71	68	101	2015

Características técnicas

Modelo	Velocidad (r/min)	Intensidad máxima admisible (A)			Potencia instalada (kW)	Caudal máximo (m³/h)	Nivel presión sonora dB(A)		Peso aprox. (Kg)	According ErP
		230V	400V	690V			Aspiración	Descarga		
HTMH-71-4/8T-3	1430 / 710		4,90 / 1,70		2,20 / 0,45	18430 / 9215	71 / 56	68 / 53	91	2015
HTMH-71-4T-4	1420	10,70	6,17		3,00	22610	72	69	104	2015
HTMH-71-4/8T-4	1430 / 710		6,50 / 2,30		3,00 / 0,60	22610 / 11305	72 / 57	69 / 54	98	2015
HTMH-71-6T-1	925	3,39	1,95		0,75	13205	58	56	90	2015
HTMH-71-6T-1.5	925	4,83	2,78		1,10	16245	59	57	94	2015
HTMH-80-4T-4	1420	10,70	6,17		3,00	27600	73	70	127	2015
HTMH-80-4/8T-4	1430 / 710		6,50 / 2,30		3,00 / 0,60	27600 / 13800	73 / 58	70 / 55	121	2015
HTMH-80-4T-5.5	1440	14,10	8,12		4,00	30176	74	71	136	2015
HTMH-80-4/8T-5.5	1430 / 710		8,20 / 2,90		4,00 / 0,80	30176 / 15088	74 / 59	71 / 56	125	2015
HTMH-80-6T-1.5	925	4,83	2,78		1,10	19412	62	60	117	2015
HTMH-80-6T-2	940	6,45	3,71		1,50	22172	63	61	122	2015
HTMH-80-6T-3	955	10,30	5,94		2,20	24932	64	62	132	2015
HTMH-90-4T-5.5	1440	14,10	8,12		4,00	35052	79	76	158	2015
HTMH-90-4/8T-5.5	1430 / 710		8,20 / 2,90		4,00 / 0,80	35052 / 17526	79 / 64	76 / 61	147	2015
HTMH-90-4T-7.5	1460		10,50	6,09	5,50	38456	81	78	176	2015
HTMH-90-4/8T-7.5	1450 / 720		11,80 / 3,80		5,50 / 1,10	38456 / 19228	81 / 66	78 / 63	166	2015
HTMH-90-4T-10 IE3	1465		13,90	8,06	7,50	41308	82	79	194	2015
HTMH-90-4/8T-9	1460 / 725		15,30 / 5,40		7,50 / 1,50	41308 / 20654	82 / 67	79 / 64	175	2015
HTMH-90-6T-3	955	10,30	5,94		2,20	29256	68	66	154	2015
HTMH-90-6/12T-3	940 / 470		5,60 / 2,20		2,20 / 0,37	29256 / 14628	68 / 53	66 / 51	148	2015
HTMH-90-6T-4	960	12,70	7,30		3,00	32016	69	67	177	2015
HTMH-90-6/12T-4	960 / 480		9,00 / 3,50		3,00 / 0,55	32016 / 16008	69 / 54	67 / 52	166	2015
HTMH-90-8T-1	705	4,68	2,70		0,75	17020	61	60	139	2015
HTMH-90-8T-2	705	7,10	4,10		1,50	19596	63	62	150	2015
HTMH-100-4T-7.5	1460		10,50	6,09	5,50	40756	84	81	200	2015
HTMH-100-4/8T-7.5	1450 / 720		11,80 / 3,80		5,50 / 1,10	40756 / 20378	84 / 69	81 / 66	190	2015
HTMH-100-4T-10 IE3	1465		13,90	8,06	7,50	47564	85	82	218	2015
HTMH-100-4/8T-9	1460 / 725		15,30 / 5,40		7,50 / 1,50	44528 / 22264	84 / 69	81 / 66	199	2015
HTMH-100-4T-15 IE3	1470		20,90	12,10	11,00	51336	86	83	253	2015
HTMH-100-6T-3	955	10,30	5,94		2,20	32476	74	72	178	2015
HTMH-100-6/12T-3	940 / 470		5,60 / 2,20		2,20 / 0,37	32476 / 16238	74 / 59	72 / 57	172	2015
HTMH-100-6T-4	960	12,70	7,30		3,00	35420	75	73	201	2015
HTMH-100-6T-5.5	960	16,50	9,46		4,00	40020	76	74	208	2015
HTMH-100-6/12T-5.5	970 / 480		11,00 / 4,00		4,00 / 0,65	40020 / 20010	76 / 61	74 / 59	200	2015
HTMH-125-4T/3-10 IE3	1465		13,90	8,06	7,50	55250	75	72	337	2015
HTMH-125-4T/3-15 IE3	1470		21,40	12,40	11,00	72150	76	73	382	2015
HTMH-125-4T/3-20 IE3	1465		28,70	16,60	15,00	83120	78	75	377	2015
HTMH-125-4T/6-15 IE3	1470		21,40	12,40	11,00	66800	76	73	398	2015
HTMH-125-4T/6-20 IE3	1465		28,70	16,60	15,00	72900	76	73	393	2015
HTMH-125-4T/9-20 IE3	1465		28,70	16,60	15,00	76310	75	72	408	2015
HTMH-125-6T/6-5.5	960	16,50	9,46		4,00	47760	63	61	343	2015
HTMH-125-6T/6-7.5	960		12,80	7,42	5,50	55600	63	61	347	2015
HTMH-125-6T/6-10 IE3	970		14,80	8,58	7,50	66170	65	63	369	2015
HTMH-125-6T/6-15 IE3	970		22,00	12,80	11,00	76380	67	65	399	2015
HTMH-125-6T/9-7.5	960		12,80	7,42	5,50	50000	64	62	362	2015
HTMH-125-6T/9-10 IE3	970		14,80	8,58	7,50	59340	64	62	384	2015
HTMH-125-6T/9-15 IE3	970		22,00	12,80	11,00	71890	67	65	414	2015
HTMH-125-6T/9-20 IE3	975		28,00	16,20	15,00	83660	70	68	467	2015
HTMH-125-8T/6-4	705	12,82	7,40		3,00	47510	56	55	328	2015
HTMH-125-8T/6-5.5	710	16,11	9,30		4,00	52770	58	57	345	2015
HTMH-125-8T/6-7.5	710		12,00	7,20	5,50	60410	60	59	361	2015
HTMH-125-8T/6-10	725		16,00	9,50	7,50	66030	61	60	389	2015
HTMH-125-8T/9-5.5	710	16,11	9,30		4,00	51330	58	57	360	2015
HTMH-125-8T/9-7.5	710		12,00	7,20	5,50	54480	61	60	376	2015
HTMH-125-8T/9-10	725		16,00	9,50	7,50	65660	63	62	404	2015
HTMH-125-8T/9-15	720		24,00	13,80	11,00	73870	64	63	426	2015



Erp. Características del punto de máxima eficiencia (BEP)

MC	Categoría de medición	ηe [%]	Eficiencia
EC	Categoría de eficiencia	N	Grado de eficiencia
S	Estática	[kW]	Potencia eléctrica
T	Total	[m³/h]	Caudal
VSD	Variador de velocidad	[mmH₂O]	Presión estática o total (Según EC)
SR	Relación específica	[RPM]	Velocidad

Modelo	MC	EC	VSD	SR	ηe [%]	N	[kW]	[m³/h]	[mmH₂O]	[RPM]
HTMH-56-4T-1	C	S	NO	1,00	35,4%	42,1	0,85	7901	14,07	1418
HTMH-56-4T-1,5	B	T	NO	1,00	48,5%	54,4	1,16	11340	18,14	1414
HTMH-56-6T-0,75	B	T	NO	1,00	42,7%	50,8	0,52	9212	8,77	934
HTMH-63-4T-1,5	C	S	NO	1,00	48,2%	54,3	1,11	10387	18,88	1418
HTMH-63-4/8T-1,5	C	S	NO	1,00	41,3%	46,8	1,38	10605	19,68	1447
HTMH-63-4T-2	C	S	NO	1,00	42,4%	47,6	1,54	12016	20,00	1449
HTMH-63-4/8T-2	C	S	NO	1,00	37,2%	42,1	1,70	11892	19,59	1434
HTMH-63-4T-3	B	T	NO	1,00	62,4%	66,6	2,19	19423	25,86	1446
HTMH-63-4/8T-3	B	T	NO	1,00	56,0%	59,9	2,42	19373	25,73	1442
HTMH-63-6T-0,75	B	T	NO	1,00	56,1%	64,1	0,55	11393	9,86	937
HTMH-63-6T-1	B	T	NO	1,00	54,9%	61,8	0,80	13916	11,57	939
HTMH-71-4T-2	C	S	NO	1,00	48,5%	53,8	1,49	13409	19,84	1450
HTMH-71-4/8T-2	C	S	NO	1,00	42,6%	47,5	1,65	13275	19,45	1436
HTMH-71-4T-3	C	S	NO	1,00	44,7%	48,9	2,16	16356	21,67	1446
HTMH-71-4/8T-3	C	S	NO	1,00	40,1%	44,0	2,39	16314	21,56	1443
HTMH-71-4T-4	B	T	NO	1,00	68,4%	71,8	2,87	23676	30,48	1434
HTMH-71-4/8T-4	B	T	NO	1,00	61,6%	64,8	3,24	23797	30,80	1441
HTMH-71-6T-1	B	T	NO	1,00	62,4%	69,3	0,82	14945	12,60	938
HTMH-71-6T-1,5	B	T	NO	1,00	59,2%	65,1	1,15	18001	13,88	939
HTMH-80-4T-4	C	S	NO	1,00	46,9%	50,1	3,22	20108	27,62	1426
HTMH-80-4/8T-4	C	S	NO	1,00	42,3%	45,1	3,64	20222	27,93	1434
HTMH-80-4T-5,5	C	S	NO	1,00	45,5%	47,7	4,55	23694	32,11	1441
HTMH-80-4/8T-5,5	C	S	NO	1,00	43,3%	45,4	4,70	23552	31,72	1432
HTMH-80-6T-1,5	C	S	NO	1,00	38,9%	44,4	1,36	15261	12,68	928
HTMH-80-6T-2	B	T	NO	1,00	61,3%	65,9	1,85	24165	17,21	941
HTMH-80-6T-3	B	T	NO	1,00	64,9%	68,9	2,29	26615	20,53	961
HTMH-90-4T-5,5	C	S	NO	1,00	51,0%	53,2	4,50	27512	30,65	1441
HTMH-90-4/8T-5,5	C	S	NO	1,00	48,6%	50,7	4,64	27348	30,28	1433
HTMH-90-4T-7,5	C	S	NO	1,00	47,8%	49,1	6,35	31725	35,17	1459
HTMH-90-4/8T-7,5	C	S	NO	1,00	43,0%	44,0	6,93	31525	34,73	1450
HTMH-90-4T-10 IE3	C	S	NO	1,01	46,3%	47,0	7,81	35188	37,75	1466
HTMH-90-4/8T-9	C	S	NO	1,00	43,0%	43,6	7,86	33548	36,97	1462
HTMH-90-6T-3	C	S	NO	1,00	42,8%	46,8	2,40	23147	16,33	959
HTMH-90-6/12T-3	C	S	NO	1,00	37,5%	41,2	2,64	22863	15,94	947
HTMH-90-6T-4	B	T	NO	1,00	63,7%	66,9	3,21	32972	22,77	964
HTMH-90-6/12T-4	B	T	NO	1,00	55,3%	58,1	3,70	32972	22,77	964
HTMH-90-8T-1	C	S	NO	1,00	36,4%	42,7	1,04	15838	8,76	708
HTMH-90-8T-2	B	T	NO	1,00	58,5%	63,9	1,40	24325	12,38	718
HTMH-100-4T-7,5	C	S	NO	1,00	50,5%	51,7	6,31	33024	35,42	1460
HTMH-100-4/8T-7,5	C	S	NO	1,00	45,4%	46,4	6,89	32817	34,98	1450
HTMH-100-4T-10 IE3	C	S	NO	1,00	49,0%	49,6	8,18	37734	39,02	1465
HTMH-100-4/8T-9	C	S	NO	1,00	45,8%	46,4	7,93	35548	37,50	1462
HTMH-100-4T-15 IE3	C	S	NO	1,01	44,9%	44,8	11,93	44732	43,97	1470
HTMH-100-6T-3	C	S	NO	1,00	45,4%	49,2	2,51	24808	16,87	957
HTMH-100-6/12T-3	C	S	NO	1,00	39,8%	43,3	2,75	24492	16,44	945
HTMH-100-6T-4	C	S	NO	1,00	41,1%	43,8	3,72	29458	19,07	958
HTMH-100-6T-5,5	B	T	NO	1,00	61,3%	63,3	4,86	44005	24,89	959
HTMH-100-6/12T-5,5	B	T	NO	1,00	56,5%	58,2	5,44	44437	25,38	968
HTMH-125-4T/3-10 IE3	C	S	NO	1,00	52,3%	53,2	7,59	41511	35,13	1468
HTMH-125-4T/3-15 IE3	C	S	NO	1,01	56,1%	56,0	11,80	57655	42,19	1471
HTMH-125-4T/3-20 IE3	C	S	NO	1,01	55,2%	54,9	15,29	67316	46,06	1472
HTMH-125-4T/6-15 IE3	C	S	NO	1,01	57,8%	57,8	11,81	48508	51,71	1471
HTMH-125-4T/6-20 IE3	C	S	NO	1,01	56,9%	56,7	14,20	52757	56,25	1474
HTMH-125-4T/9-20 IE3	C	S	NO	1,01	70,4%	70,1	17,44	37304	120,90	1474
HTMH-125-6T/6-5,5	C	S	NO	1,00	53,1%	55,5	4,28	34565	24,14	972
HTMH-125-6T/6-7,5	C	S	NO	1,00	54,7%	56,3	5,53	41832	26,55	974



Erp. Características del punto de máxima eficiencia (BEP)

Modelo	MC	EC	VSD	SR	η_e [%]	N	[kW]	[m ³ /h]	[mmH ₂ O]	[RPM]
HTMH-125-6T/6-10 IE3	C	S	NO	1,00	55,2%	55,9	7,84	53067	29,95	972
HTMH-125-6T/6-15 IE3	C	S	NO	1,00	51,2%	51,2	11,09	61349	34,01	972
HTMH-125-6T/9-7,5	C	S	NO	1,00	57,2%	58,8	5,67	36967	32,26	973
HTMH-125-6T/9-10 IE3	C	S	NO	1,00	55,1%	56,2	6,74	48390	28,19	976
HTMH-125-6T/9-15 IE3	C	S	NO	1,00	50,9%	50,9	11,00	61885	33,25	973
HTMH-125-6T/9-20 IE3	C	S	NO	1,01	49,7%	49,5	15,00	69606	39,35	968
HTMH-125-8T/6-4	C	S	NO	1,00	47,4%	50,3	3,53	38680	15,89	709
HTMH-125-8T/6-5,5	C	S	NO	1,00	46,8%	49,1	4,42	42659	17,80	715
HTMH-125-8T/6-7,5	C	S	NO	1,00	45,5%	47,0	5,87	50667	19,37	727
HTMH-125-8T/6-10	B	T	NO	1,00	65,4%	66,1	7,79	65294	28,66	727
HTMH-125-8T/9-5,5	C	S	NO	1,00	44,6%	46,7	4,79	43462	18,07	712
HTMH-125-8T/9-7,5	C	S	NO	1,00	46,5%	48,0	5,75	48507	20,26	728
HTMH-125-8T/9-10	C	S	NO	1,00	45,9%	46,7	7,65	55731	23,16	728
HTMH-125-8T/9-15	B	T	NO	1,00	67,6%	67,6	10,90	72088	37,51	728

Datos del punto de máxima eficiencia del ventilador interno

Dimensiones mm

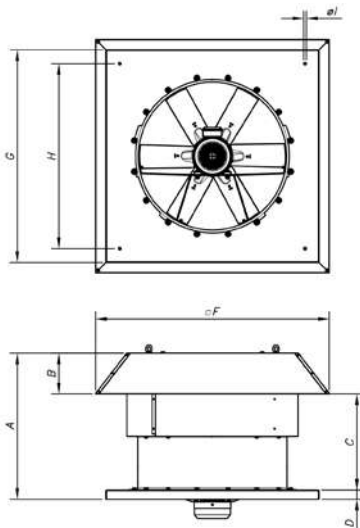

Modelo	A	B	C	D	F	G	H	I
HTMH-56	650	185	465	40	960	900	750	14
HTMH-63	680	215	465	40	1092	1000	850	14
HTMH-71	760	195	565	40	1120	1000	850	14
HTMH-80	790	215	575	50	1252	1150	1000	14
HTMH-90	910	232	678	50	1380	1150	1000	14
HTMH-100	1055	252	803	50	1527	1250	1100	14
HTMH-125	1170	310	859	50	1802	1600	1450	17

Validación de la presión sonora según distancia

El nivel sonoro puede variar dependiendo de la estructura de la cubierta o tejado.

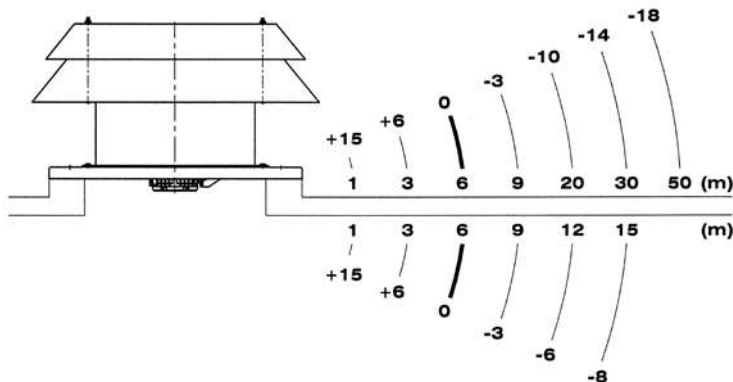

Accesorios

Ver apartado accesorios



Curvas características

Q= Caudal en m³/h, m³/s y cfm.

Pe= Presión estática en mmH₂O, Pa e inwg.

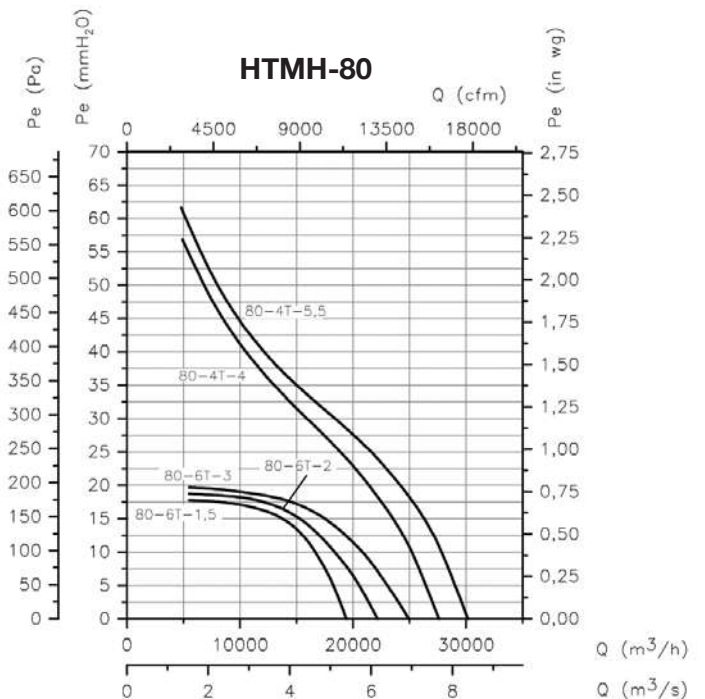
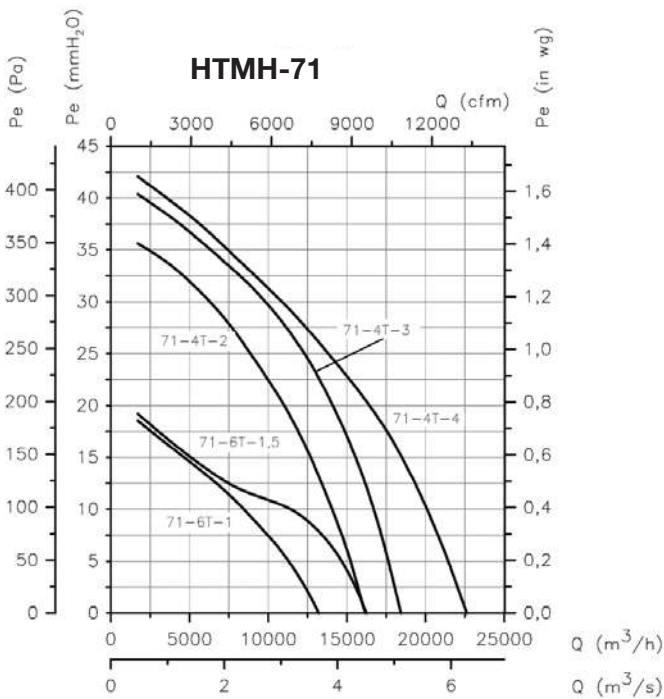
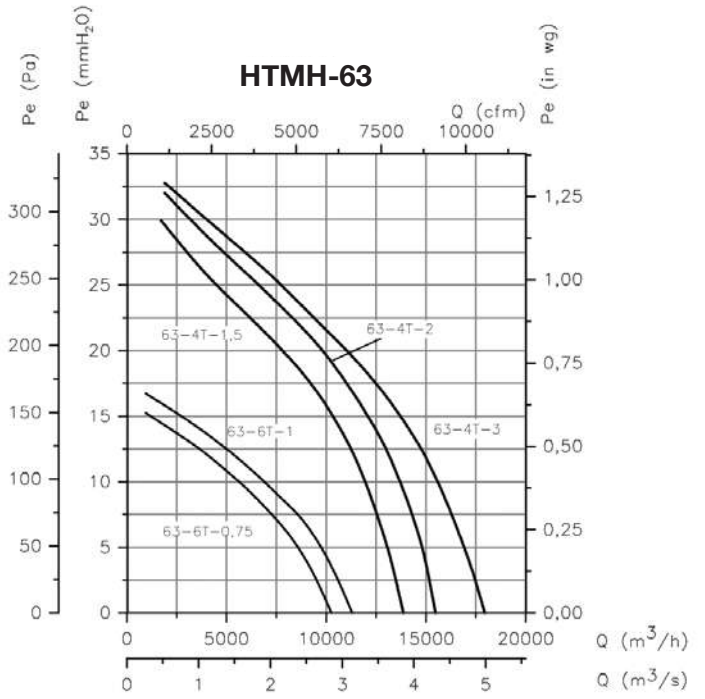
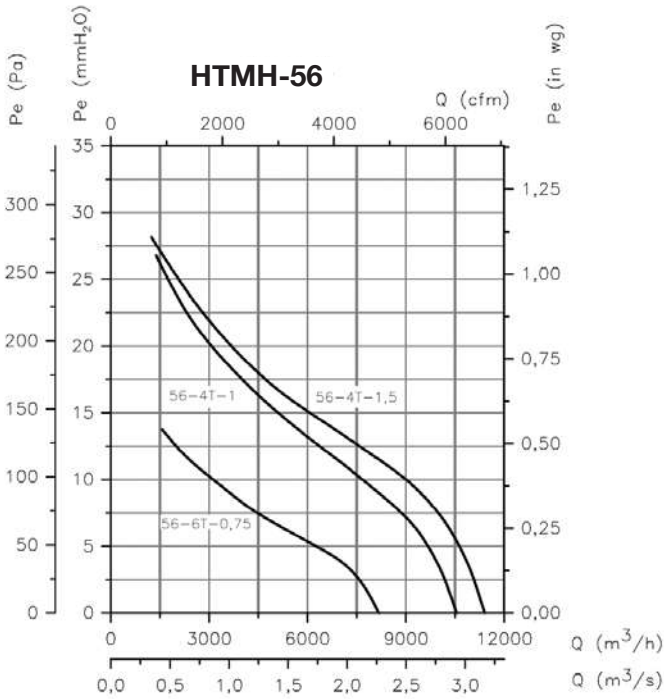

Curvas características

Q= Caudal en m³/h, m³/s y cfm.

Pe= Presión estática en mmH₂O, Pa e in wg.

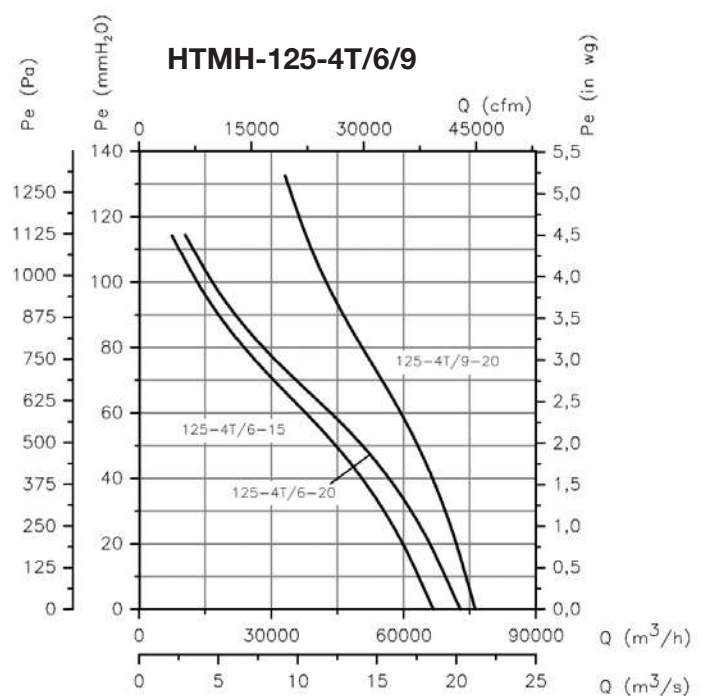
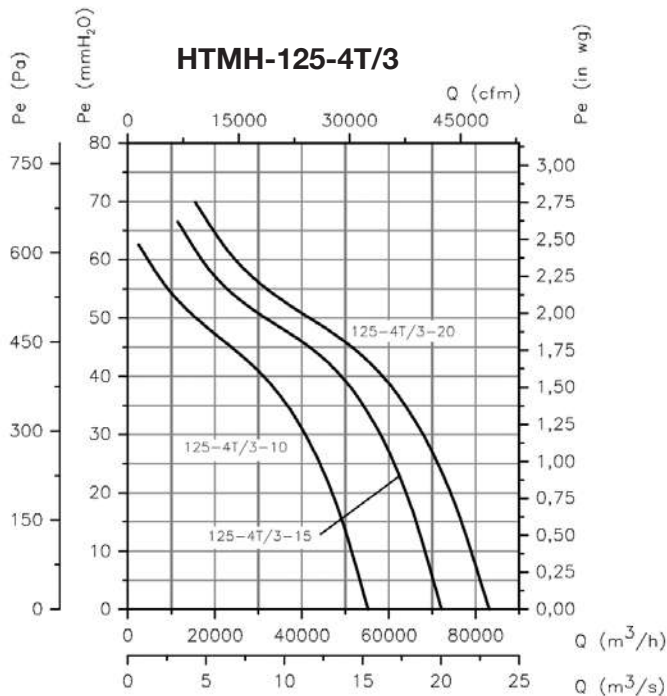
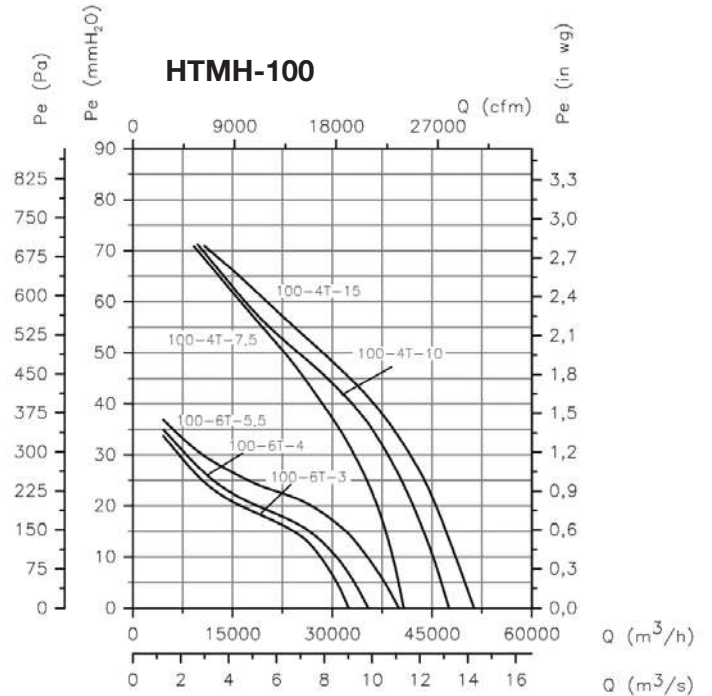
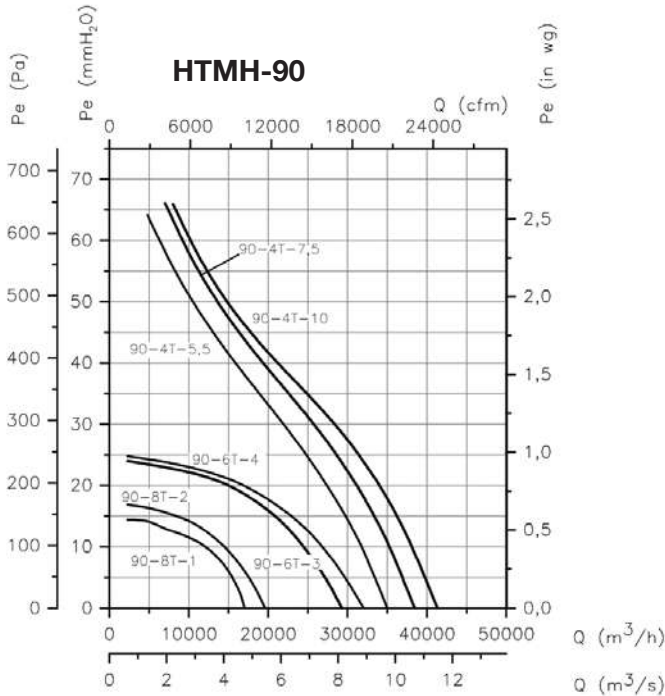

Curvas características

Q= Caudal en m³/h, m³/s y cfm.

Pe= Presión estática en mmH₂O, Pa e in wg.

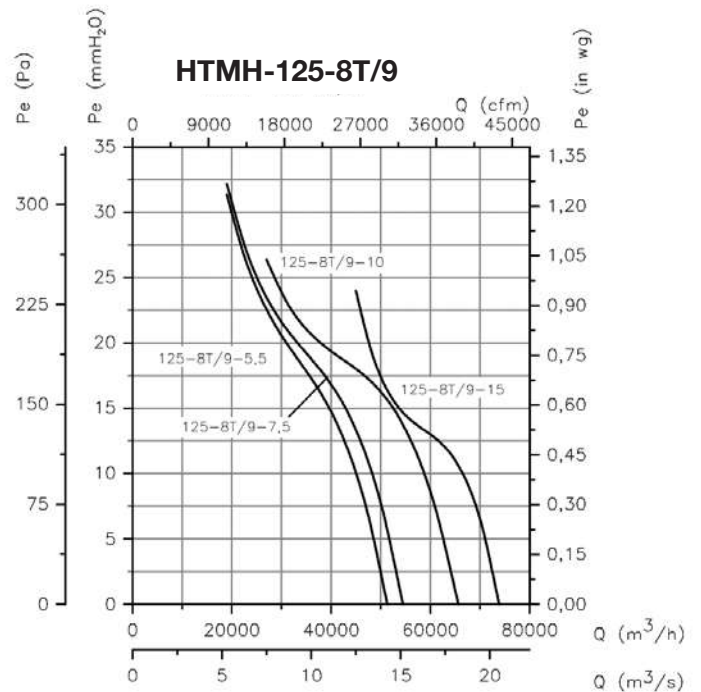
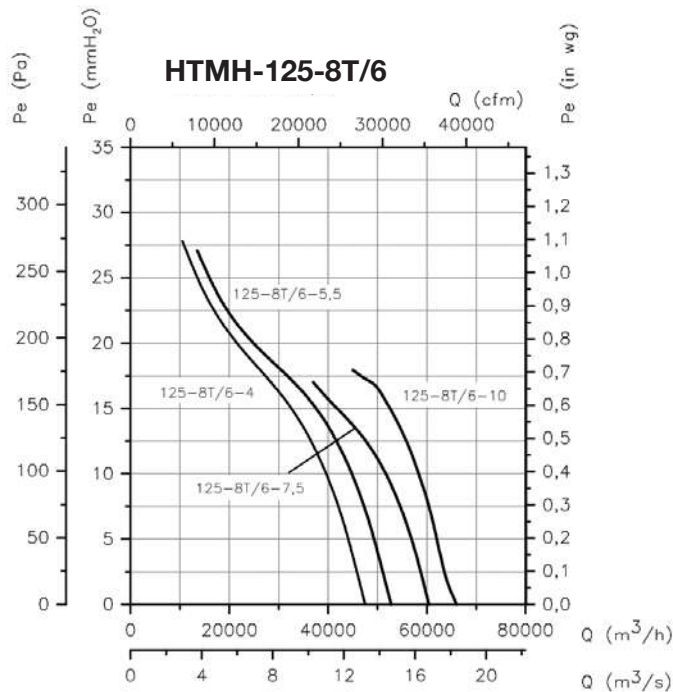
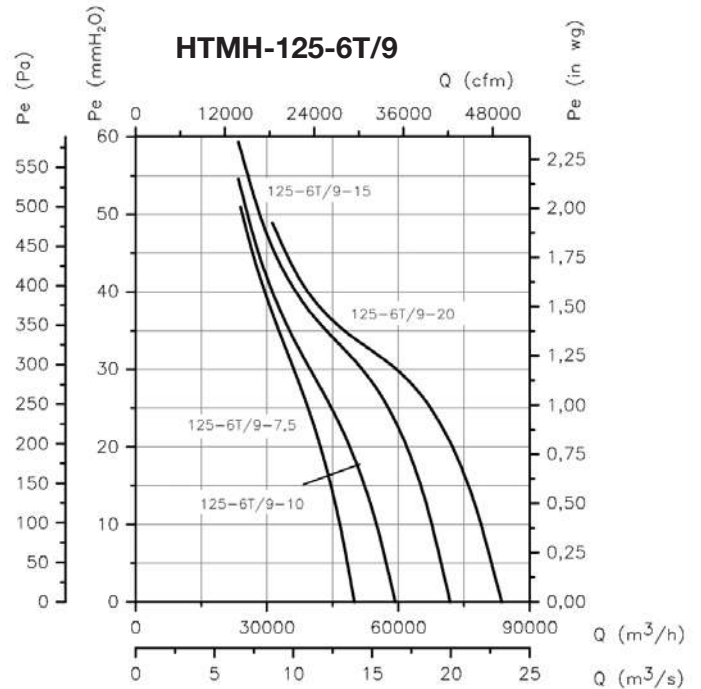
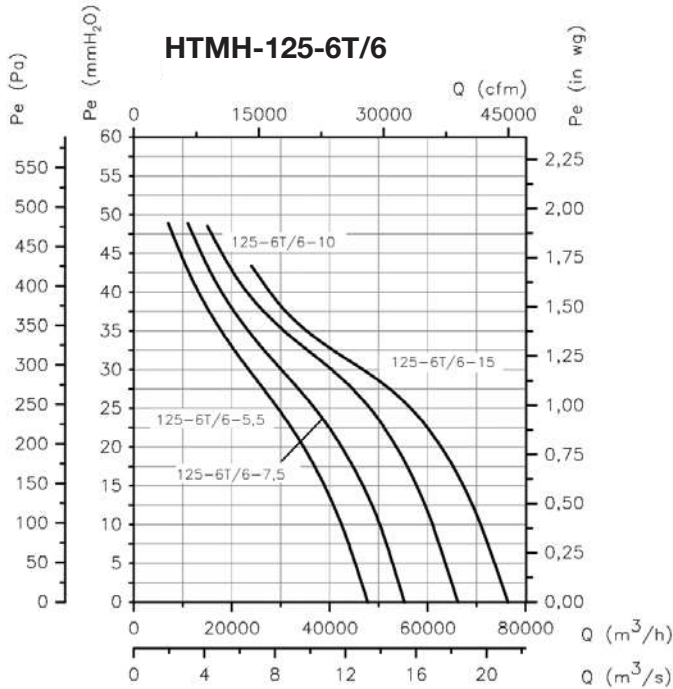

HTMV



Extractores helicoidales de cubierta con salida de aire vertical



Extractores helicoidales de cubierta con salida de aire vertical, diseñados para la extracción de gran cantidad de aire en naves industriales o similares.

Ventilador:

- Base soporte en chapa de acero galvanizada y tratamiento anticorrosivo
- Hélices orientables en fundición de aluminio.
- Rejilla de protección contra contactos según norma UNE-EN ISO 12499.
- Compuerta antiretorno en chapa de aluminio para evitar la entrada de agua cuando el ventilador no está en funcionamiento.
- Dirección aire motor-hélice.

Motor:

- Motores clase F, con rodamientos a bolas, protección IP55.
- Motores de eficiencia IE3 para potencias iguales o superiores a 0,75kW, excepto monofásicos, 2 velocidades y 8 polos
- Trifásicos 230/400V.-50Hz. (hasta 4 kW) y 400/690V.-50Hz. (potencias superiores a 4 kW)
- Temperatura máxima del aire a transportar: -20°C+ 40°C

Acabado:

- Anticorrosivo en resina de poliéster polimerizada a 190°C, previo desengrase con tratamiento nanotecnológico libre de fosfatos

Bajo demanda:

- Extractores con motor de 2 velocidades.
- Ventiladores de 2 y 8 polos según diámetro.
- Bobinados especiales para diferentes tensiones y frecuencias
- Construcción total en acero inoxidable
- Construcción en acero galvanizado en caliente

Código de pedido

De tamaño 56 a tamaño 100

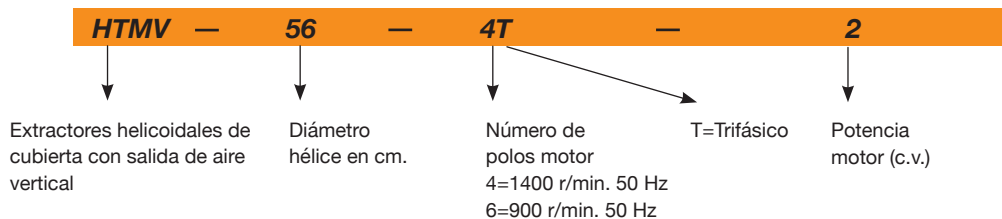

Tamaño 125

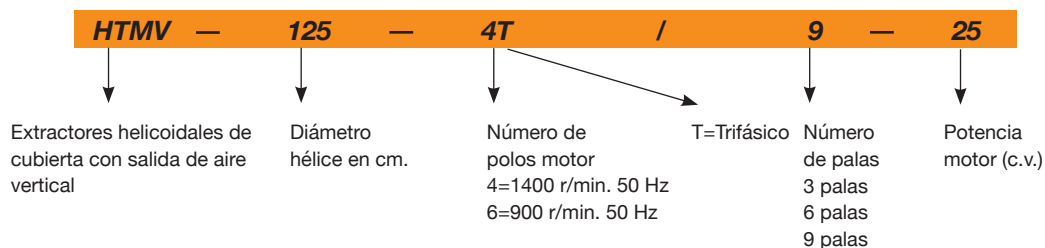

Características técnicas

Modelo	Velocidad (r/min)	Intensidad máxima admisible (A)			Potencia instalada (kW)	Caudal máximo (m³/h)	Nivel presión (1) sonora dB(A)		Peso aprox. (Kg)	According ErP
		230V	400V	690V			Aspiración	Descarga		
HTMV-56-4T-1 IE3	1420	2,82	1,62		0,75	11250	63	58	61	2015
HTMV-56-4T-1.5 IE3	1455	4,07	2,34		1,1	13600	64	59	60	2015
HTMV-56-4T-2 IE3	1440	5,41	3,11		1,5	15050	65	60	71	2015
HTMV-56-6T-0.75	900	2,99	1,73		0,55	10150	52	48	60	2015
HTMV-63-4T-1.5 IE3	1455	4,07	2,34		1,1	17800	63	59	69	2015
HTMV-63-4T-2 IE3	1440	5,41	3,11		1,5	19300	63	59	81	2015
HTMV-63-4T-3 IE3	1435	7,93	4,56		2,2	22150	65	61	83	2015
HTMV-63-4T-4 IE3	1440	10,7	6,15		3	24250	66	62	93	2015
HTMV-63-6T-0.75	900	2,99	1,73		0,55	13600	55	51	70	2015

Características técnicas

Modelo	Velocidad (r/min)	Intensidad máxima admisible (A)			Potencia instalada (kW)	Caudal máximo (m³/h)	Nivel presión (1) sonora dB(A)		Peso aprox. (Kg)	According ErP
		230V	400V	690V			Aspiración	Descarga		
HTMV-63-6T-1 IE3	940	3,36	1,93		0,75	15900	57	53	72	2015
HTMV-71-4T-2 IE3	1440	5,41	3,11		1,5	20900	68	64	88	2015
HTMV-71-4T-3 IE3	1435	7,93	4,56		2,2	25100	67	63	90	2015
HTMV-71-4T-4 IE3	1440	10,7	6,15		3	27500	68	64	100	2015
HTMV-71-6T-0.75	900	2,99	1,73		0,55	16100	56	53	77	2015
HTMV-71-6T-1 IE3	940	3,36	1,93		0,75	17300	57	53	79	2015
HTMV-71-6T-1.5 IE3	945	4,68	2,69		1,1	19950	58	54	90	2015
HTMV-80-4T-4 IE3	1440	10,7	6,15		3	30250	71	67	122	2015
HTMV-80-4T-5.5 IE3	1450	13,9	8		4	32750	71	67	125	2015
HTMV-80-6T-1.5 IE3	945	4,68	2,69		1,1	21450	61	57	112	2015
HTMV-80-6T-2 IE3	950	6,43	3,7		1,5	25950	62	58	120	2015
HTMV-80-6T-3 IE3	950	9,08	5,22		2,2	29950	63	59	122	2015
HTMV-90-4T-5.5 IE3	1450	13,9	8		4	38900	75	71	138	2015
HTMV-90-4T-7.5 IE3	1465		10,3	5,97	5,5	46150	74	70	185	2015
HTMV-90-4T-10 IE3	1465		13,9	8,06	7,5	50150	73	69	141	2015
HTMV-90-6T-2 IE3	950	6,43	3,7		1,5	28800	64	60	133	2015
HTMV-90-6T-3 IE3	950	9,08	5,22		2,2	34000	65	60	136	2015
HTMV-90-6T-4 IE3	970	12	6,91		3	38900	66	62	172	2015
HTMV-100-4T-7.5 IE3	1465		10,3	5,97	5,5	46850	79	75	196	2015
HTMV-100-4T-10 IE3	1465		13,9	8,06	7,5	57400	77	73	152	2015
HTMV-100-4T-15 IE3	1470		21,4	12,4	11	66300	76	72	231	2015
HTMV-100-4T-20 IE3	1465		28,7	16,6	15	76150	78	74	222	2015
HTMV-100-6T-3 IE3	950	9,08	5,22		2,2	37600	67	64	148	2015
HTMV-100-6T-4 IE3	970	12	6,91		3	41150	67	62	184	2015
HTMV-100-6T-5.5 IE3	960	15,6	8,99		4	47800	68	64	177	2015
HTMV-125-4T/3-25 IE3	1470		33,6	19,5	18,5	98350	81	76	428	2015
HTMV-125-4T/3-30 IE3	1475		40,6	23,5	22	110350	82	77	443	2015
HTMV-125-4T/3-40 IE3	1480		55,9	32,4	30	125000	83	78	489	2015
HTMV-125-4T/6-25 IE3	1470		33,6	19,5	18,5	92550	80	75	437	2015
HTMV-125-4T/6-30 IE3	1475		40,6	23,5	22	98850	80	75	452	2015
HTMV-125-4T/6-40 IE3	1480		55,9	32,4	30	117450	82	77	497	2015
HTMV-125-4T/6-50 IE3	1480		69,2	40,1	37	131050	83	78	537	2015
HTMV-125-4T/9-25 IE3	1470		33,6	19,5	18,5	79650	78	73	446	2015
HTMV-125-4T/9-30 IE3	1475		40,6	23,5	22	88300	79	74	461	2015
HTMV-125-4T/9-40 IE3	1480		55,9	32,4	30	104050	81	76	506	2015
HTMV-125-4T/9-50 IE3	1480		69,2	40,1	37	118400	83	78	546	2015
HTMV-125-6T/3-4 IE3	970	12	6,91		3	46750	70	65	280	2015
HTMV-125-6T/3-5.5 IE3	960	15,6	8,99		4	55400	70	66	273	2015
HTMV-125-6T/3-7.5 IE3	970		11,2	6,49	5,5	68400	71	67	251	2015
HTMV-125-6T/3-10 IE3	970		14,8	8,58	7,5	79150	73	69	270	2015
HTMV-125-6T/3-15 IE3	970		22	12,8	11	87150	74	70	323	2015
HTMV-125-6T/3-20 IE3	975		28	16,2	15	91650	75	71	429	2015
HTMV-125-6T/6-5.5 IE3	960	15,6	8,99		4	51500	66	62	282	2015
HTMV-125-6T/6-7.5 IE3	970		11,2	6,49	5,5	60650	66	62	260	2015
HTMV-125-6T/6-10 IE3	970		14,8	8,58	7,5	72650	68	64	279	2015
HTMV-125-6T/6-15 IE3	970		22	12,8	11	85850	70	66	332	2015
HTMV-125-6T/6-20 IE3	975		28	16,2	15	92850	71	67	438	2015
HTMV-125-6T/9-10 IE3	970		14,8	8,58	7,5	63500	68	64	288	2015
HTMV-125-6T/9-15 IE3	970		22	12,8	11	77550	71	67	341	2015
HTMV-125-6T/9-20 IE3	975		28	16,2	15	92950	74	70	447	2015

(1) Los valores de los niveles sonoros, son presiones en dB(A) medidos a 6 metros, en campo libre.

Características acústicas

Los valores indicados, se determinan mediante medidas de nivel de presión y potencia sonora en dB (A) obtenidas en campo libre a una distancia de 6 mts.

Espectro de potencia sonora Lw(A) en dB(A) banda de frecuencia en [Hz]

Valores tomados a la aspiración con caudal máximo.

Modelo	63	125	250	500	1000	2000	4000	8000
56-4-1	48	68	76	81	83	80	73	62
56-4-1.5	49	69	77	82	84	81	74	63
56-4-2	50	70	78	83	85	82	75	64
56-6-0.75	37	57	65	70	72	69	62	51
63-4-1.5	48	68	76	81	83	80	73	65
63-4-2	52	68	76	81	83	80	73	66
63-4-3	53	70	78	83	85	82	77	67
63-4-4	54	71	79	84	86	83	78	68
63-6-0.75	42	60	68	73	75	72	65	56
63-6-1	43	62	70	75	77	74	67	57
71-4-2	53	73	81	86	88	85	78	70
71-4-3	58	72	80	85	87	84	77	71
71-4-4	59	73	81	86	88	85	78	72
71-6-0.75	44	63	72	74	76	73	66	55
71-6-1	45	65	73	75	77	74	67	56
71-6-1.5	46	66	71	76	78	75	68	57
80-4-4	56	76	84	89	91	88	81	74
80-4-5.5	56	76	84	89	91	88	81	74
80-6-1.5	49	66	74	79	81	78	71	60
80-6-2	50	67	75	80	82	79	72	61
80-6-3	51	68	76	81	83	80	73	62
90-4-5.5	60	81	88	93	96	92	85	74
90-4-7.5	59	80	87	92	95	91	84	73
90-4-10	58	79	86	91	94	90	83	72
90-6-2	49	70	77	82	85	81	74	63
90-6-3	56	70	77	82	85	81	74	63
90-6-4	57	72	79	84	87	83	76	65
100-4-7.5	64	84	92	97	99	96	89	78
100-4-10	62	82	90	95	97	94	87	76
100-4-15	61	81	89	94	96	93	86	75
100-4-20	63	83	91	96	98	95	88	77
100-6-3	61	72	80	85	87	84	77	66
100-6-4	64	72	80	85	87	84	77	66
100-6-5.5	64	73	81	86	88	85	78	67
125-4/3-25	73	79	91	101	101	97	89	85
125-4/3-30	74	80	92	102	102	98	90	86
125-4/3-40	75	81	93	103	103	99	91	87
125-4/6-25	68	76	92	99	101	96	90	86
125-4/6-30	68	76	92	99	101	96	90	86
125-4/6-40	70	78	94	101	103	98	92	88
125-4/6-50	71	79	95	102	104	99	93	89
125-4/9-25	66	74	91	97	98	93	88	84
125-4/9-30	67	75	92	98	99	94	89	85
125-4/9-40	69	77	94	100	101	96	91	87
125-4/9-50	71	79	96	102	103	98	93	89
125-6/3-4	66	74	86	90	88	83	74	70
125-6/3-5.5	66	74	86	90	88	83	74	70
125-6/3-7.5	67	75	87	91	89	84	75	71
125-6/3-10	69	77	89	93	91	86	77	73
125-6/3-15	70	78	90	94	92	87	78	74
125-6/3-20	71	79	91	95	93	88	79	75
125-6/6-5.5	60	69	82	85	86	83	72	68
125-6/6-7.5	60	69	82	85	86	83	72	68
125-6/6-10	62	71	84	87	88	85	74	70
125-6/6-15	64	73	86	89	90	87	76	72
125-6/6-20	65	74	87	90	91	88	77	73
125-6/9-10	58	68	83	87	86	85	74	70
125-6/9-15	61	71	86	90	89	88	77	73
125-6/9-20	64	74	89	93	92	91	80	76

Valores tomados a la descarga con caudal máximo.

Modelo	63	125	250	500	1000	2000	4000	8000
56-4-1	43	63	71	76	78	75	68	57
56-4-1.5	44	64	72	77	79	76	69	58
56-4-2	45	65	73	78	80	77	70	59
56-6-0.75	33	53	61	66	68	65	58	47
63-4-1.5	44	64	72	77	79	76	69	60
63-4-2	47	64	72	77	79	76	69	61
63-4-3	48	66	74	79	81	78	73	62
63-4-4	49	67	75	80	82	79	74	63
63-6-0.75	38	56	64	69	71	68	61	52
63-6-1	39	58	66	71	73	70	63	53
71-4-2	49	69	77	82	84	81	74	65
71-4-3	53	68	76	81	83	80	73	67
71-4-4	54	69	77	82	84	81	74	68
71-6-0.75	40	60	68	71	73	70	63	52
71-6-1	41	61	69	71	73	70	63	52
71-6-1.5	42	62	67	72	74	71	64	53
80-4-4	52	72	80	85	87	84	77	69
80-4-5.5	52	72	80	85	87	84	77	70
80-6-1.5	45	62	70	75	77	74	67	56
80-6-2	46	63	71	76	78	75	68	57
80-6-3	47	64	72	77	79	76	69	58
90-4-5.5	56	77	84	89	92	88	81	70
90-4-7.5	55	76	83	88	91	87	80	69
90-4-10	54	75	82	87	90	86	79	68
90-6-2	45	66	73	78	81	77	70	59
90-6-3	52	66	73	78	81	77	70	59
90-6-4	53	68	75	80	83	79	72	61
100-4-7.5	60	80	88	93	95	92	85	74
100-4-10	58	78	86	91	93	90	83	72
100-4-15	57	77	85	90	92	89	82	71
100-4-20	59	79	87	92	94	91	84	73
100-6-3	58	69	77	82	84	81	74	63
100-6-4	59	67	75	80	82	79	72	61
100-6-5.5	60	69	77	82	84	81	74	63
125-4/3-25	68	74	86	96	96	92	84	80
125-4/3-30	69	75	87	97	97	93	85	81
125-4/3-40	70	76	88	98	98	94	86	82
125-4/6-25	63	71	87	94	96	91	85	81
125-4/6-30	63	71	87	94	96	91	85	81
125-4/6-40	65	73	89	96	98	93	87	83
125-4/6-50	66	74	90	97	99	94	88	84
125-4/9-25	61	69	86	92	93	88	83	79
125-4/9-30	62	70	87	93	94	89	84	80
125-4/9-40	64	72	89	95	96	91	86	82
125-4/9-50	66	74	91	97	98	93	88	84
125-6/3-4	61	69	81	85	83	78	69	65
125-6/3-5.5	62	70	82	86	84	79	70	66
125-6/3-7.5	63	71	83	87	85	80	71	67
125-6/3-10	65	73	85	89	87	82	73	69
125-6/3-15	66	74	86	90	88	83	74	70
125-6/3-20	67	75	87	91	89	84	75	71
125-6/6-5.5	56	65	78	81	82	79	68	64
125-6/6-7.5	56	65	78	81	82	79	68	64
125-6/6-10	58	67	80	83	84	81	70	66
125-6/6-15	60	69	82	85	86	83	72	68
125-6/6-20	61	70	83	86	87	84	73	69
125-6/9-10	54	64	79	83	82	81	70	66
125-6/9-15	57	67	82	86	85	84	73	69
125-6/9-20	60	70	85	89	88	87	76	72

Dimensiones mm

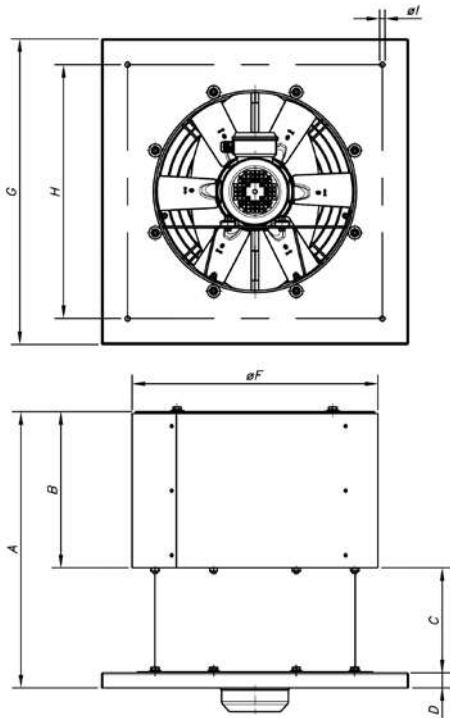

Modelo	A	B	C	D	ØF	G	H	ØI
HTMV-56	770	438	244	40	686	900	750	14
HTMV-63	810	475	244	40	753	1000	850	14
HTMV-71	890	510	292	40	833	1000	850	14
HTMV-80	950	555,5	292	50	923	1150	1000	14
HTMV-90	1040	611	338	40	1031	1150	1000	14
HTMV-100	1197	659	438	50	1128	1250	1100	14
HTMV-125	1373	785,5	488	50	1376	1600	1450	17

Accesorios

Ver apartado accesorios



INT



AET



VSD



RT



PA



MS

Curvas características

Q= Caudal en m³/h, m³/s y cfm.

Pe= Presión estática en mmH₂O, Pa e inwg.

56-4T

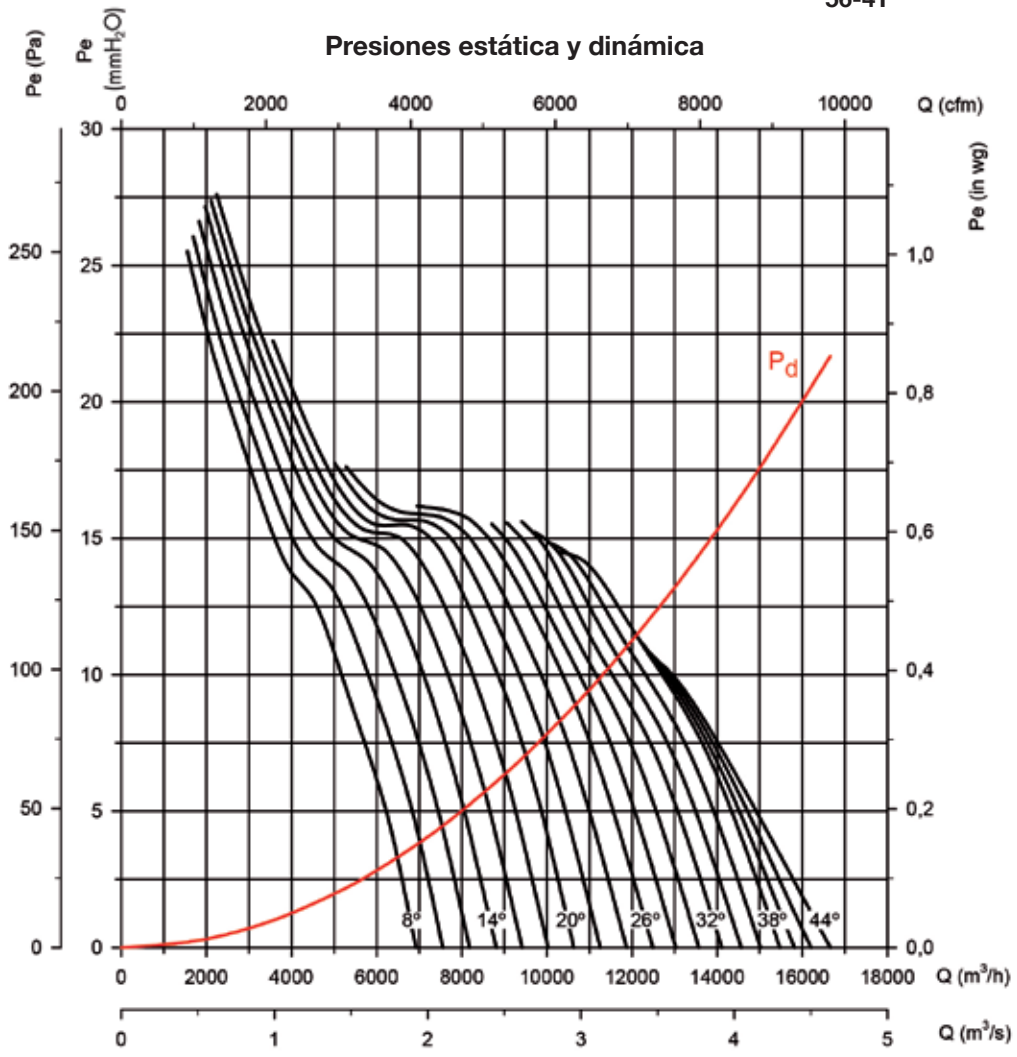

Potencia absorbida

Potencia Motor
Recomendada
kW(CV)

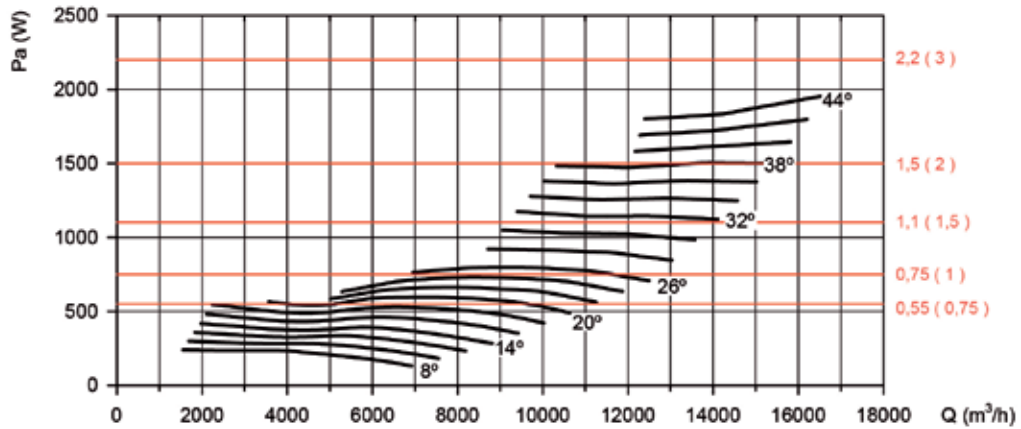

Curvas características

Q= Caudal en m³/h, m³/s y cfm.

Pe= Presión estática en mmH₂O, Pa e inwg.

56-6T

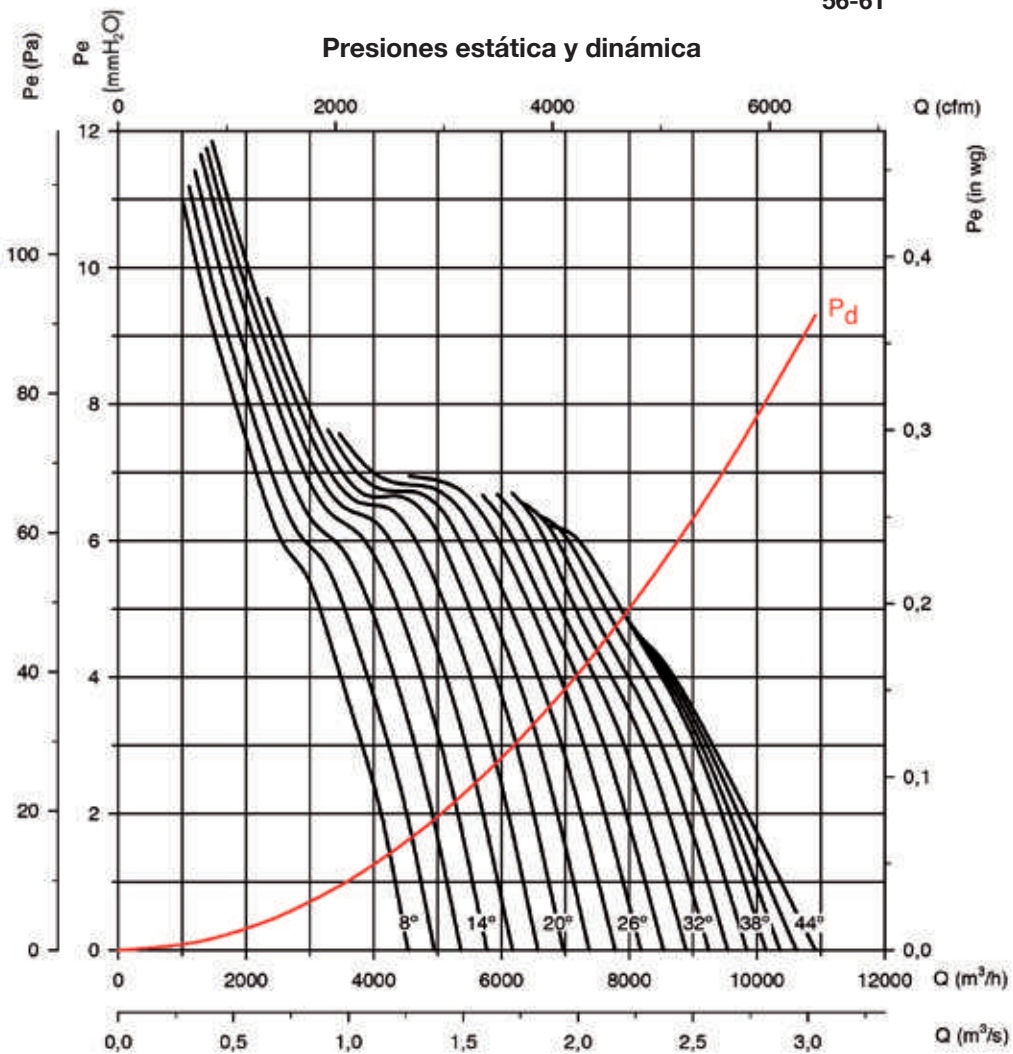

Potencia absorbida

Potencia Motor Recomendada kW(CV)

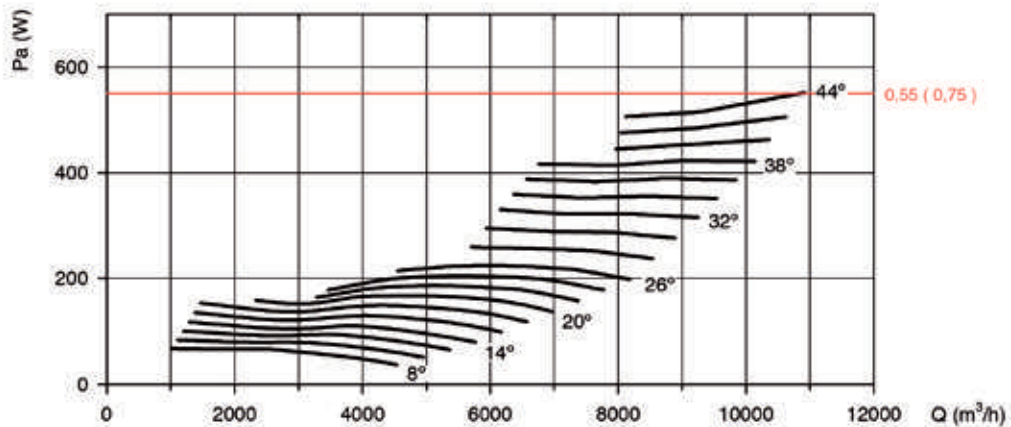

Curvas características

Q= Caudal en m³/h, m³/s y cfm.

Pe= Presión estática en mmH₂O, Pa e inwg.

63-4T

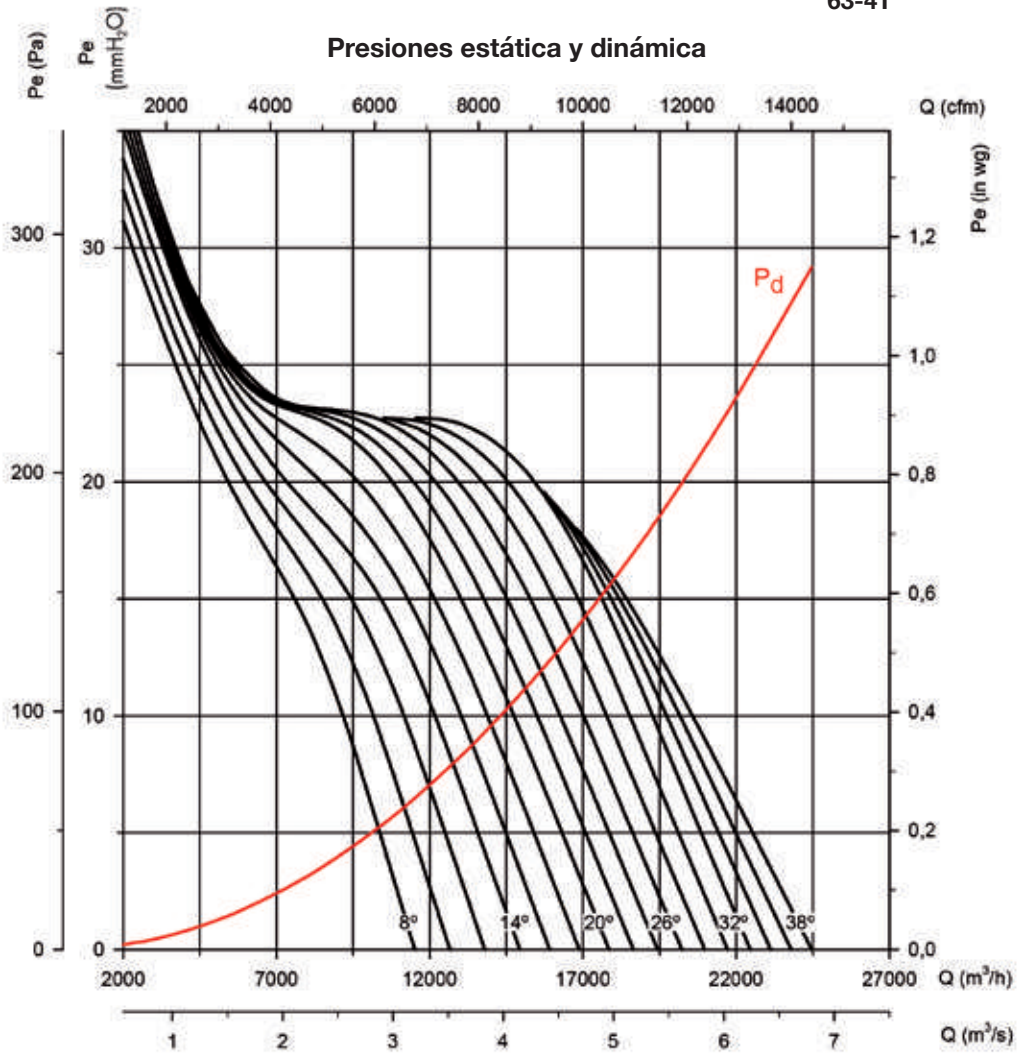

Potencia absorbida

Potencia Motor
Recomendada
kW(CV)

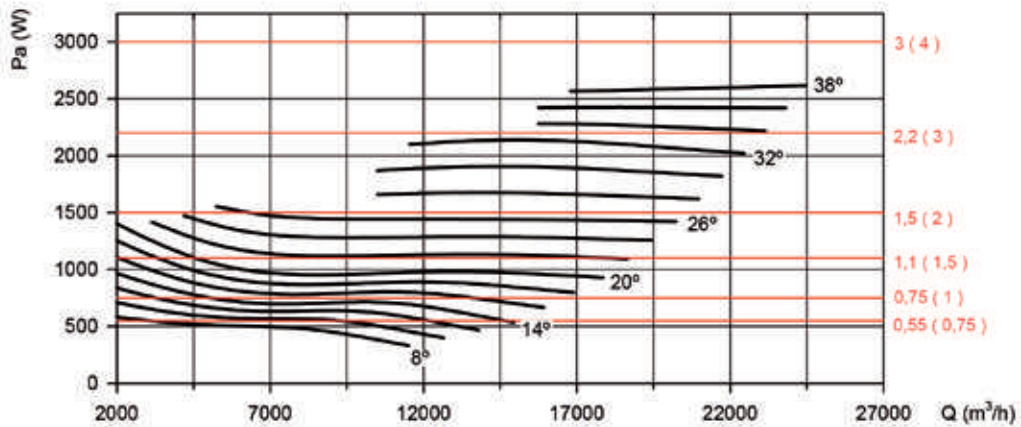

Curvas características

Q= Caudal en m³/h, m³/s y cfm.

Pe= Presión estática en mmH₂O, Pa e inwg.

63-6T

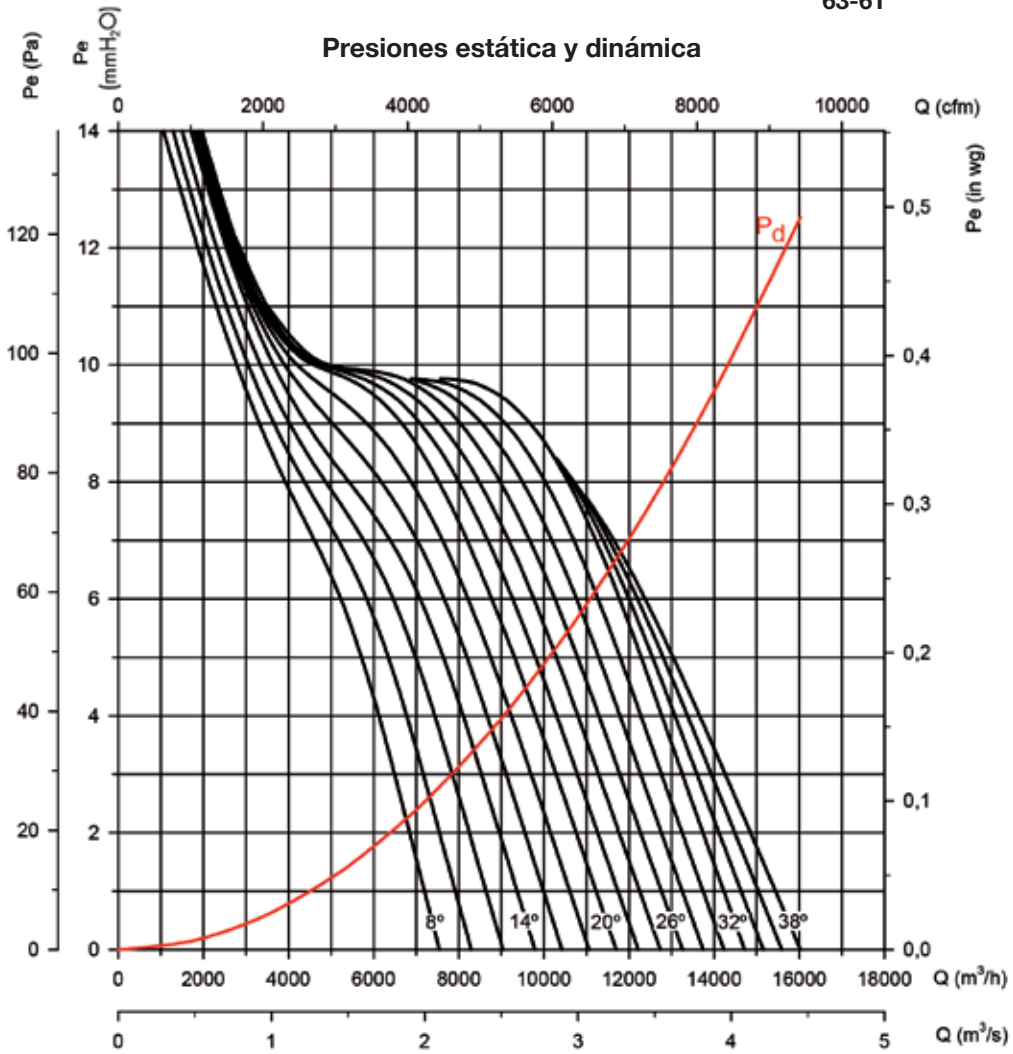

Potencia absorbida

Potencia Motor
Recomendada
kW(CV)

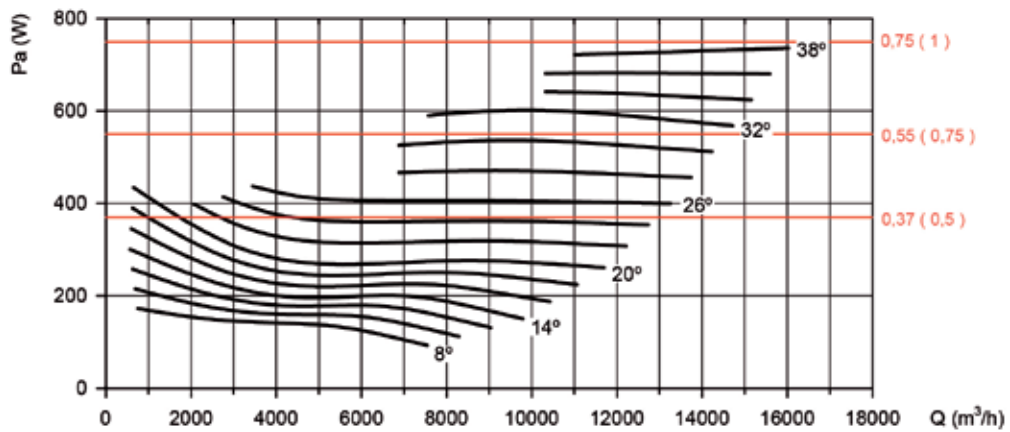

Curvas características

Q= Caudal en m³/h, m³/s y cfm.

Pe= Presión estática en mmH₂O, Pa e inwg.

71-4T

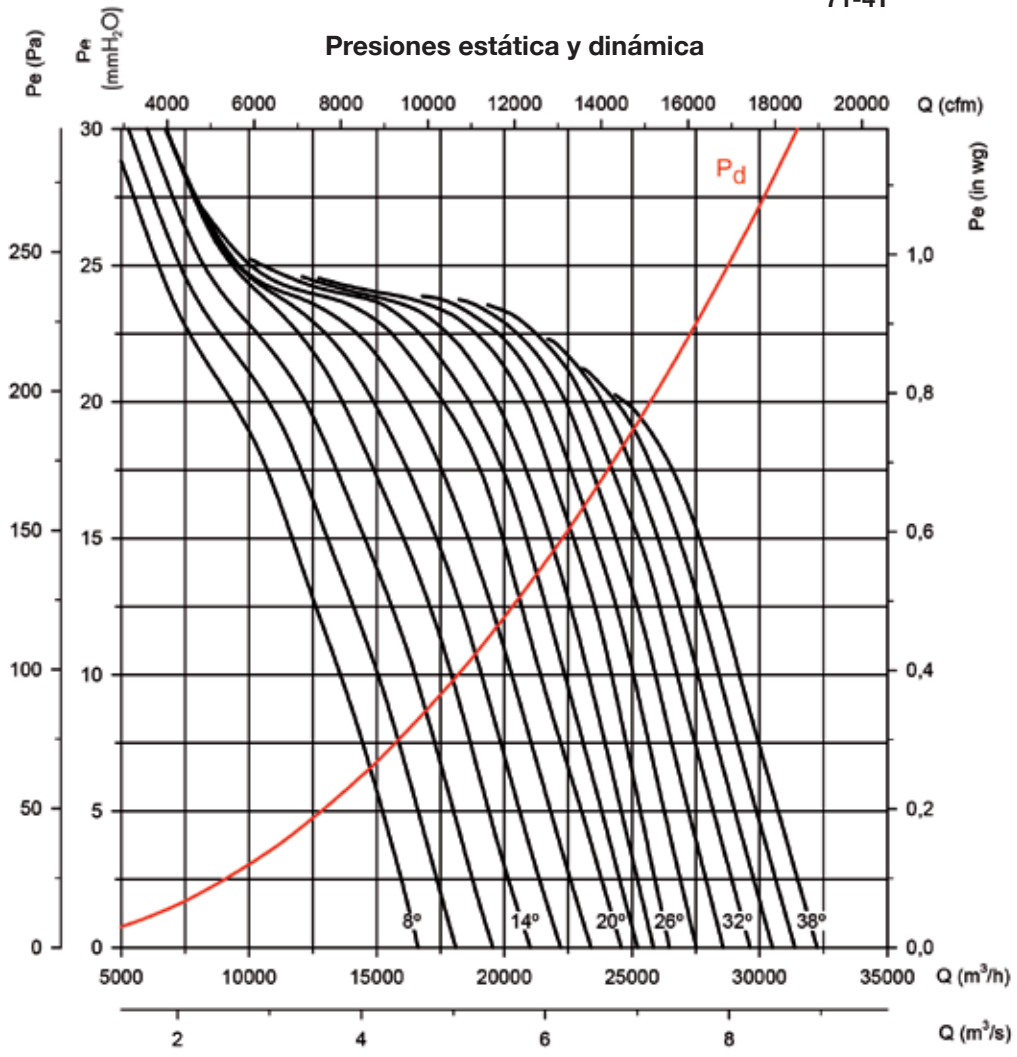

Potencia absorbida

Potencia Motor
Recomendada
kW(CV)

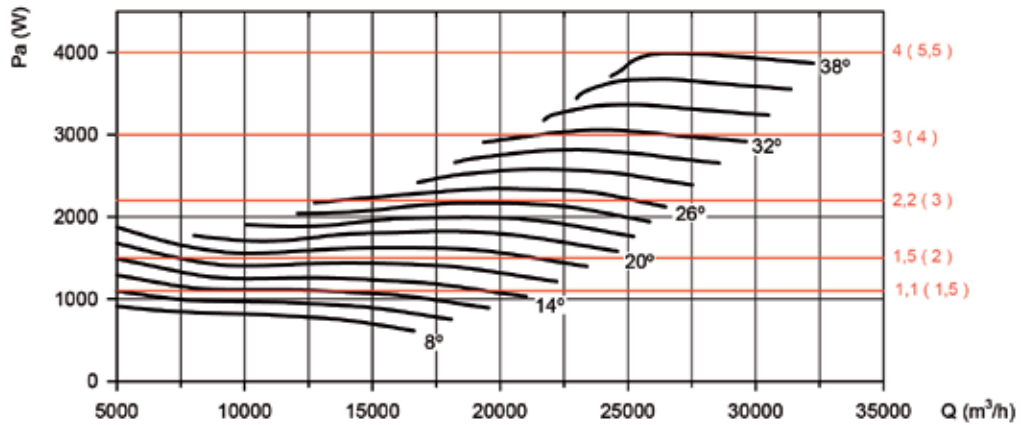

Curvas características

Q= Caudal en m³/h, m³/s y cfm.

Pe= Presión estática en mmH₂O, Pa e inwg.

71-6T

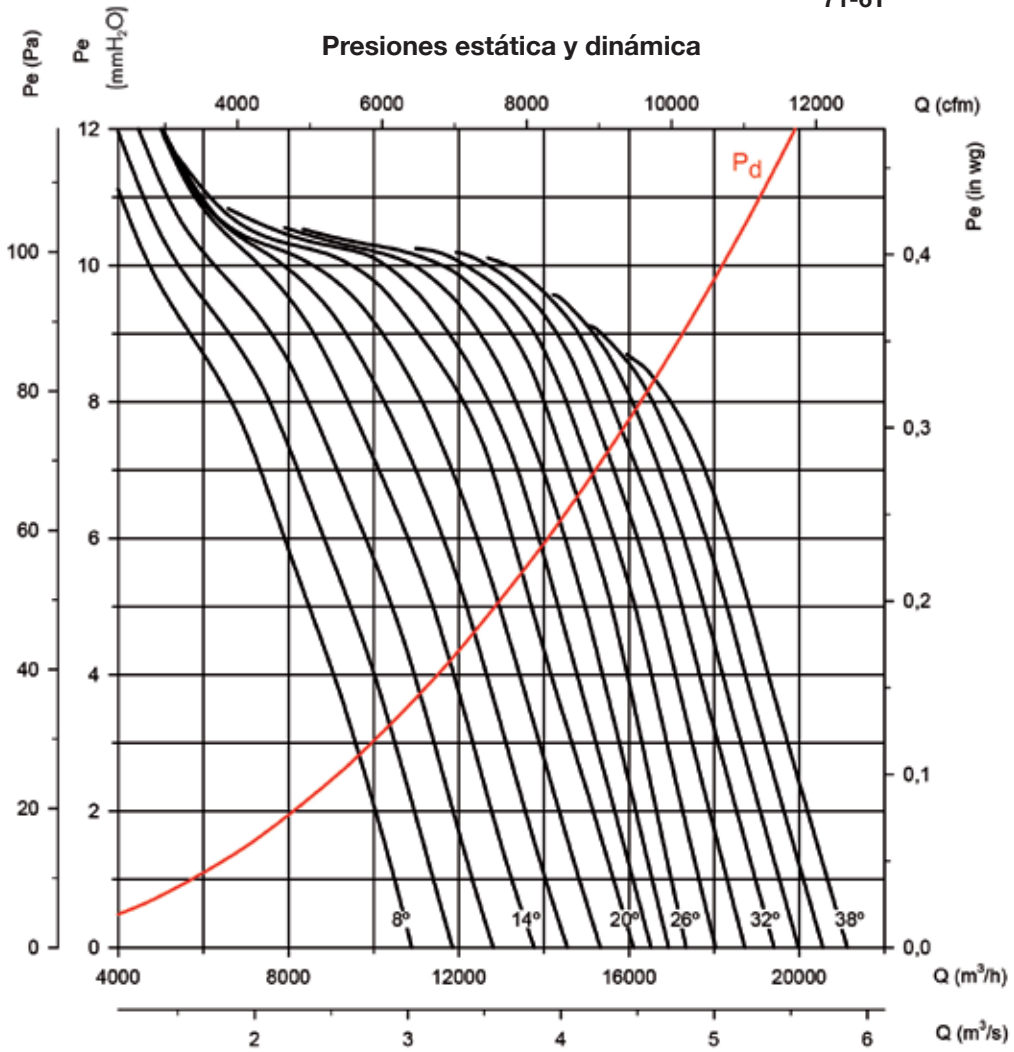

Potencia absorbida

Potencia Motor Recomendada kW(CV)

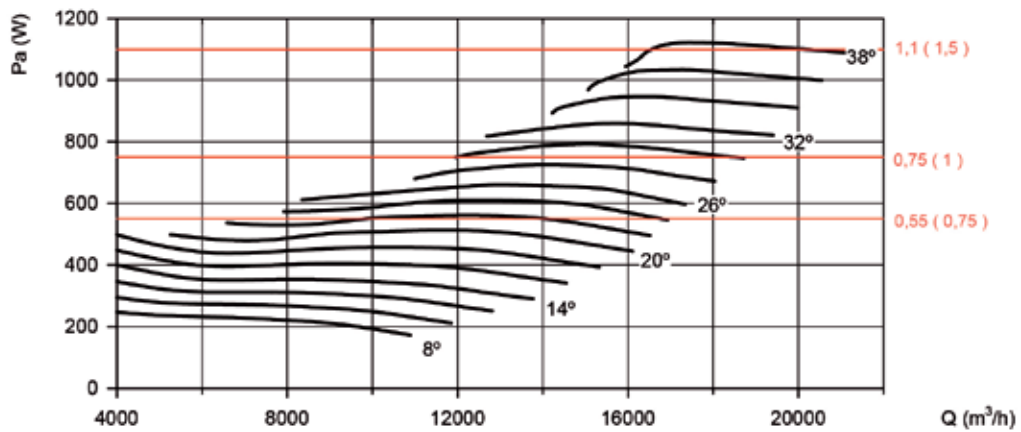

Curvas características

Q= Caudal en m³/h, m³/s y cfm.

Pe= Presión estática en mmH₂O, Pa e inwg.

80-4T

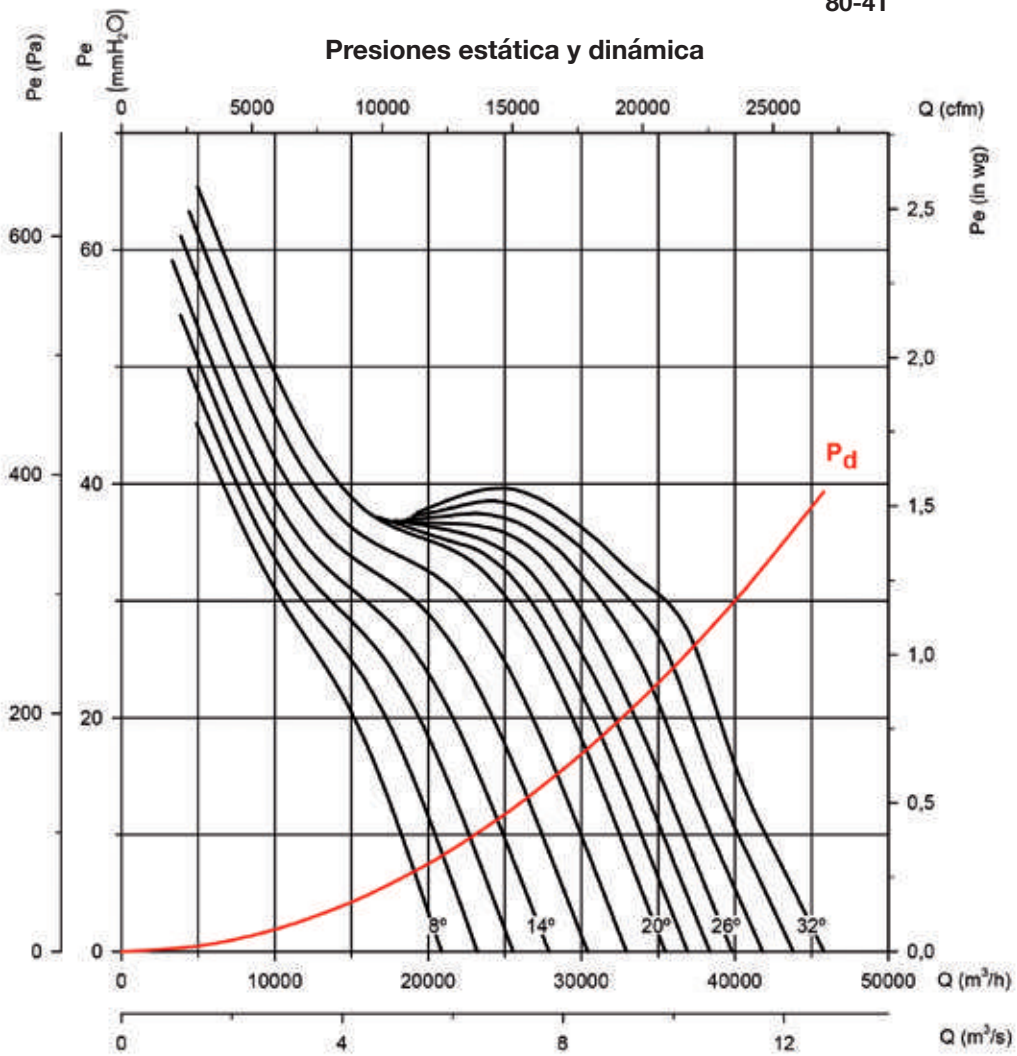

Potencia absorbida

Potencia Motor Recomendada
kW(CV)

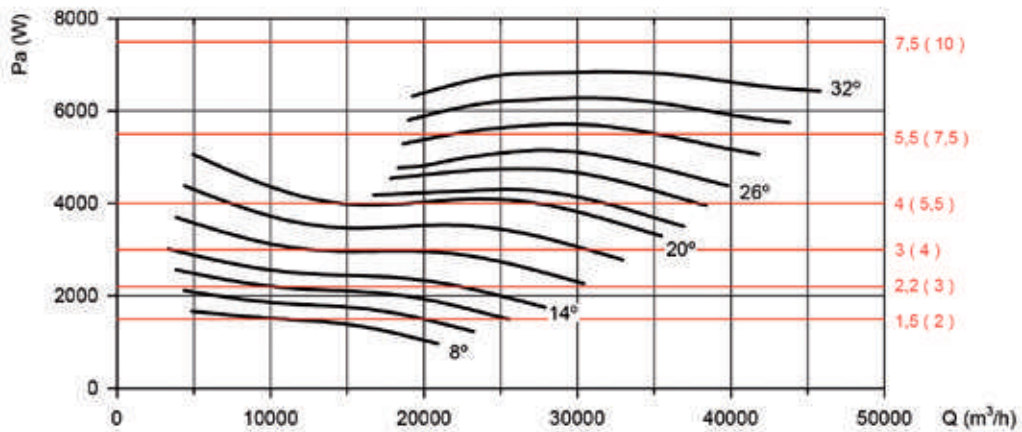

Curvas características

Q= Caudal en m³/h, m³/s y cfm.

Pe= Presión estática en mmH₂O, Pa e inwg.

80-6T

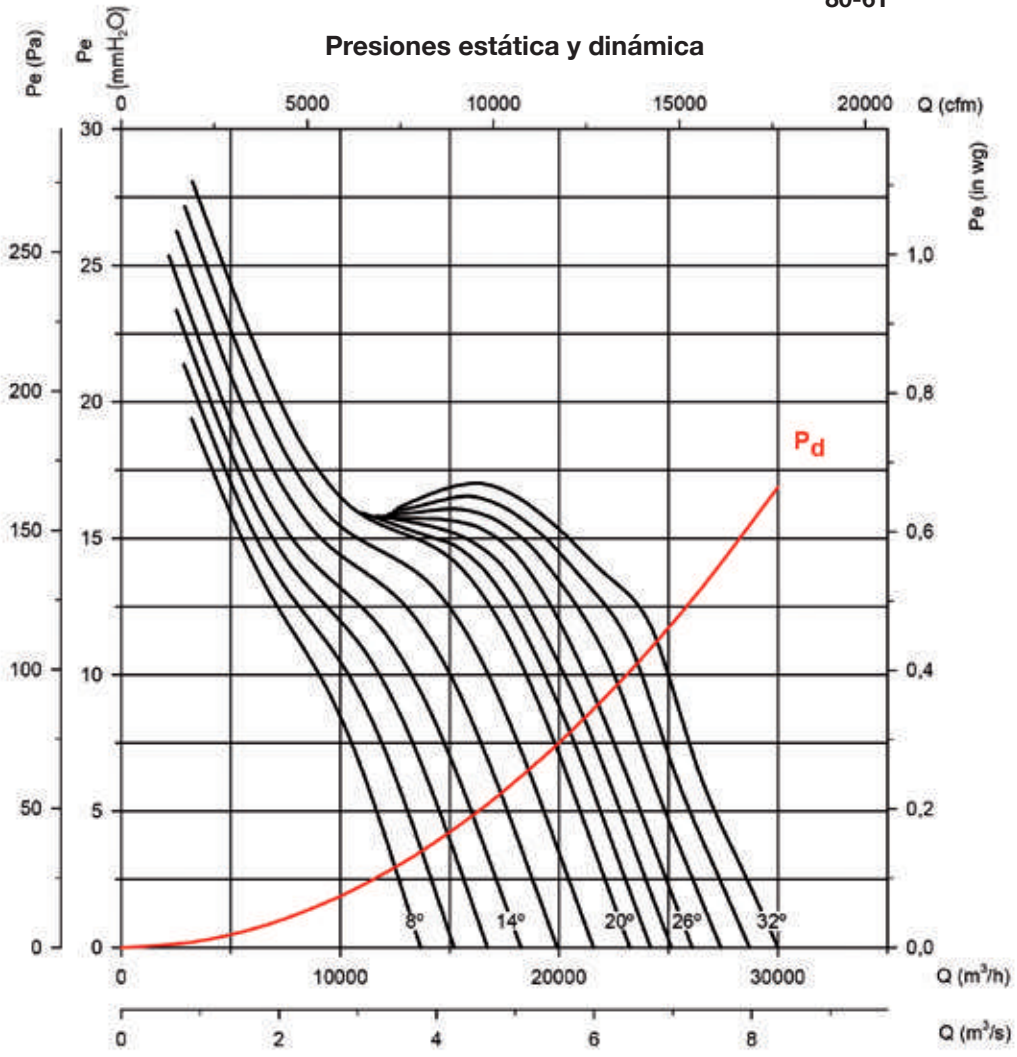

Potencia absorbida

Potencia Motor Recomendada kW(CV)

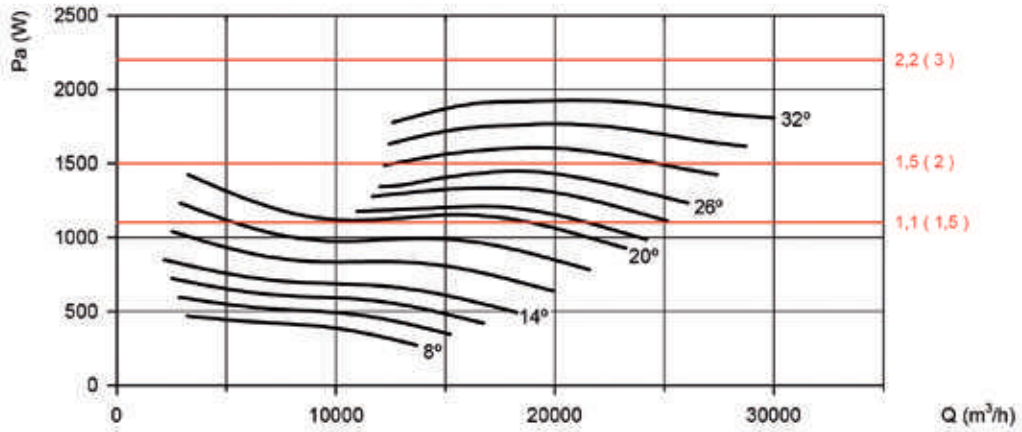

Curvas características

Q= Caudal en m³/h, m³/s y cfm.

Pe= Presión estática en mmH₂O, Pa e inwg.

90-4T

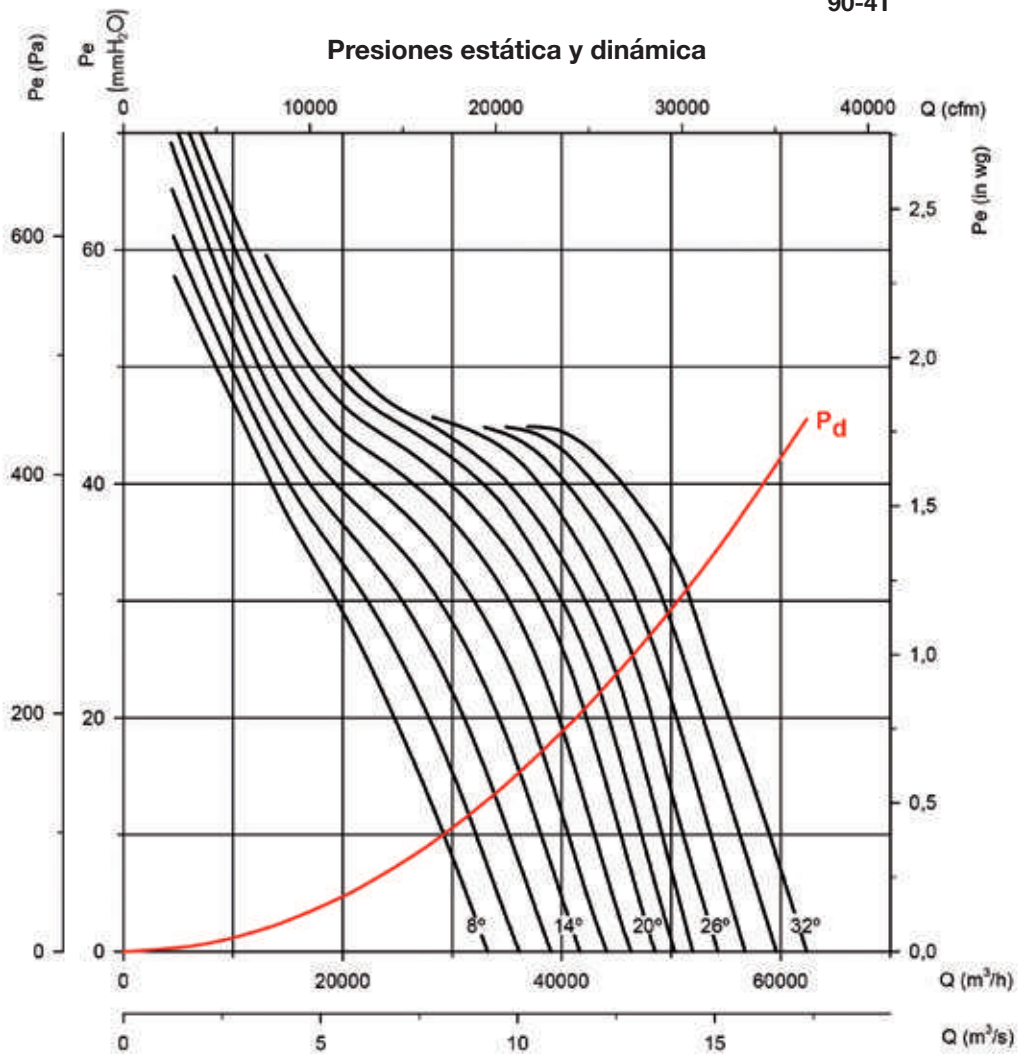

Potencia absorbida

Potencia Motor Recomendada kW(CV)

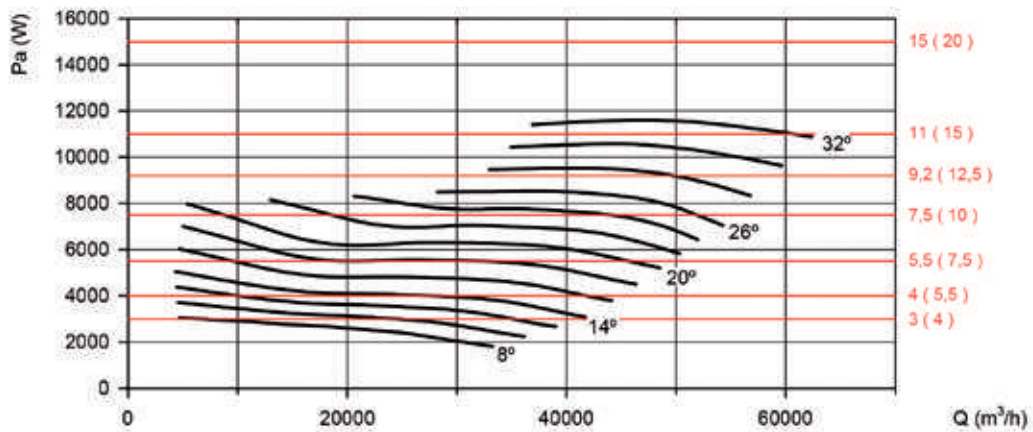

Curvas características

Q= Caudal en m³/h, m³/s y cfm.

Pe= Presión estática en mmH₂O, Pa e inwg.

90-6T

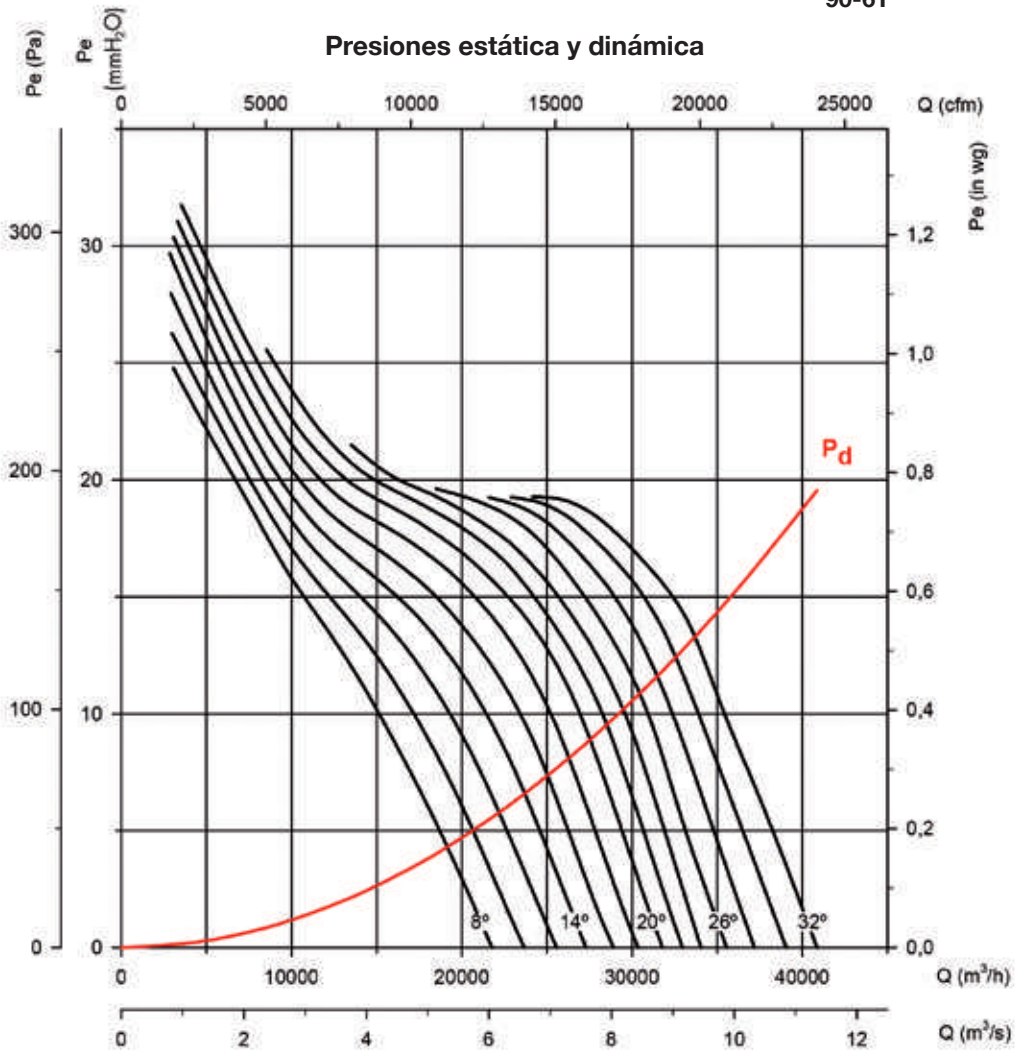

Potencia absorbida

Potencia Motor Recomendada kW(CV)

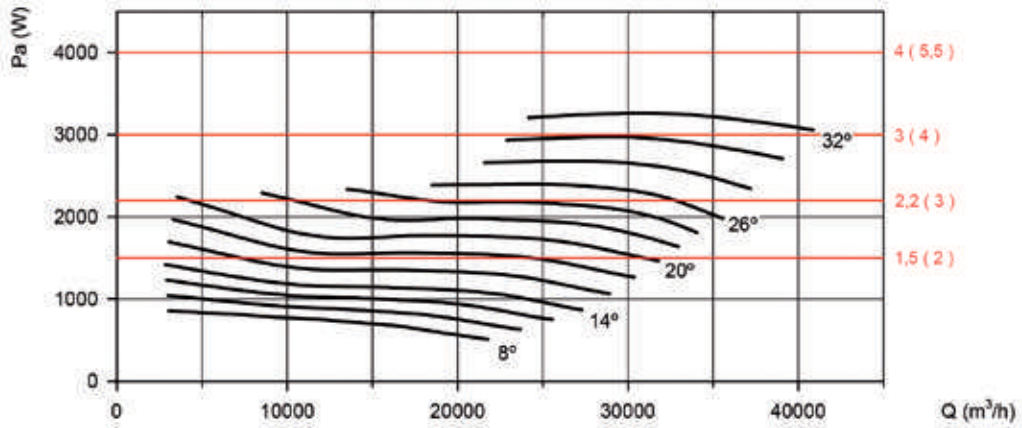

Curvas características

Q= Caudal en m³/h, m³/s y cfm.

Pe= Presión estática en mmH₂O, Pa e inwg.

100-4T/6

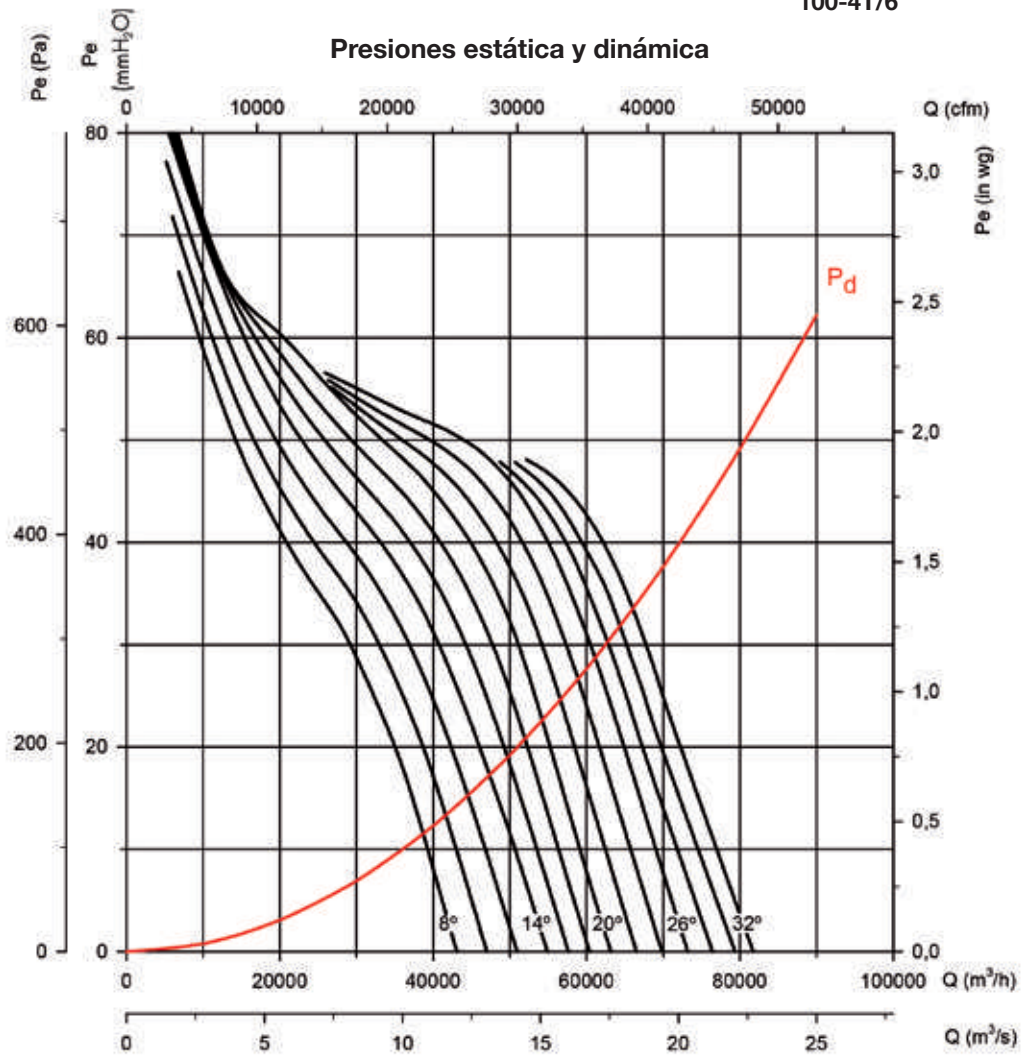

Potencia absorbida

Potencia Motor Recomendada kW(CV)

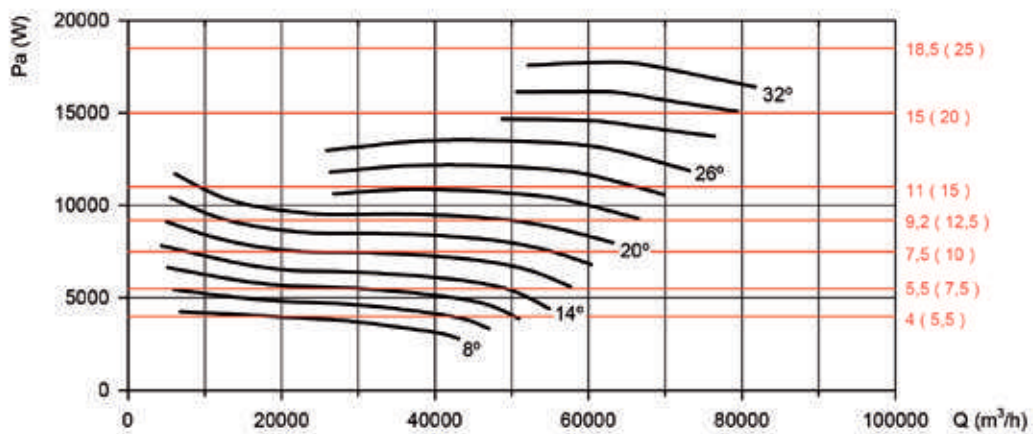

Curvas características

Q= Caudal en m³/h, m³/s y cfm.

Pe= Presión estática en mmH₂O, Pa e inwg.

100-6T/6

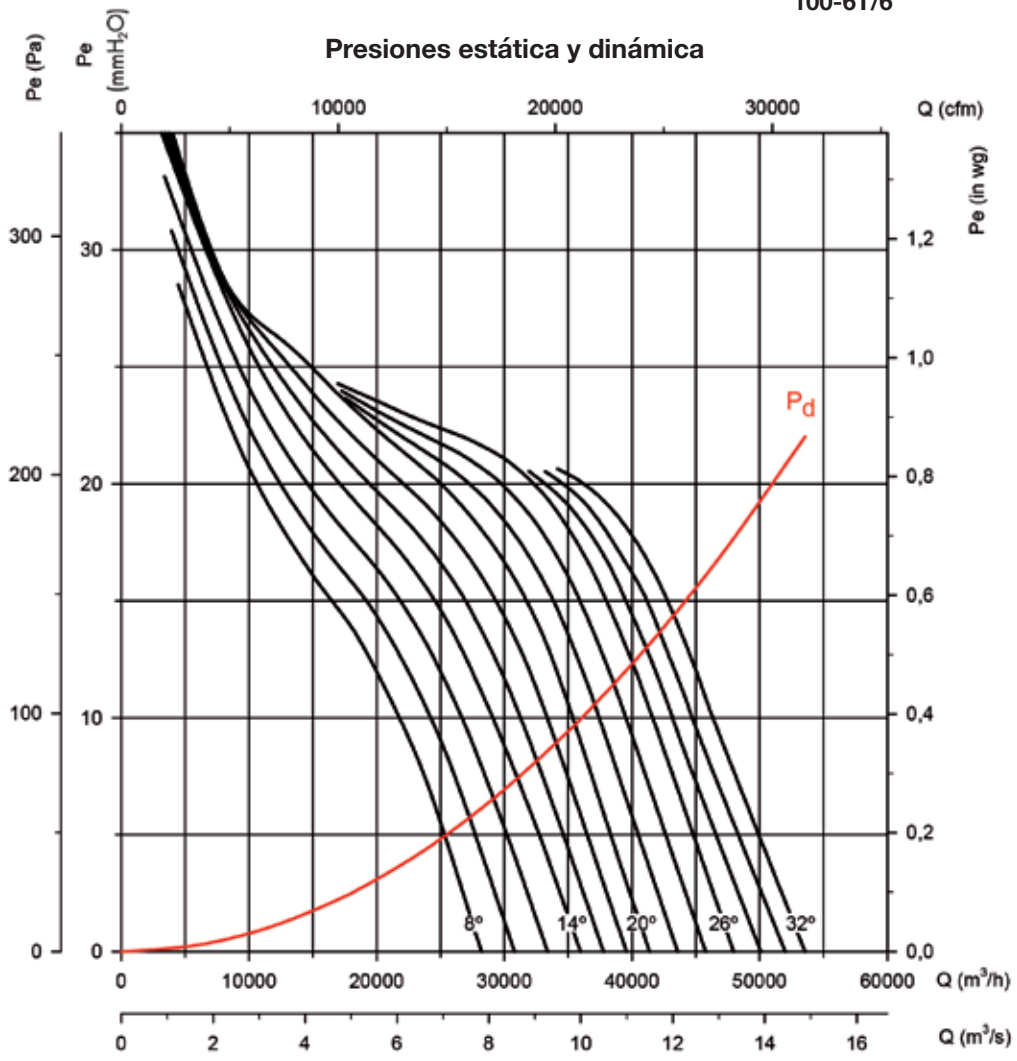

Potencia absorbida

Potencia Motor Recomendada kW(CV)

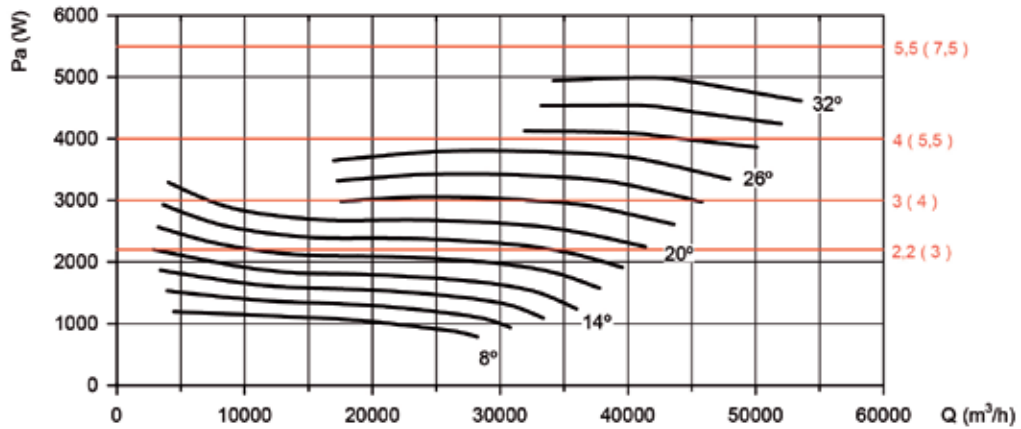

Curvas características

Q= Caudal en m³/h, m³/s y cfm.

Pe= Presión estática en mmH₂O, Pa e inwg.

125-4T/3

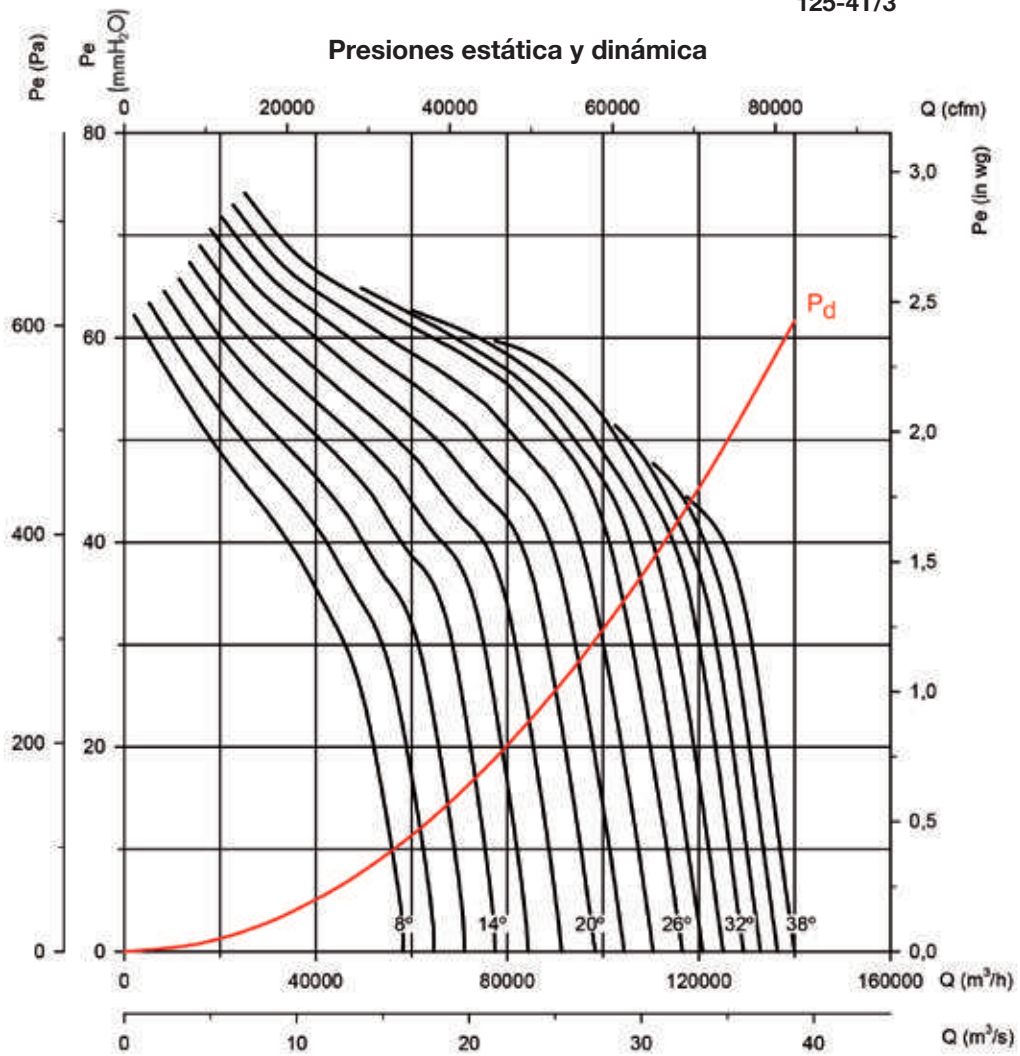

Potencia absorbida

Potencia Motor
Recomendada
kW(CV)

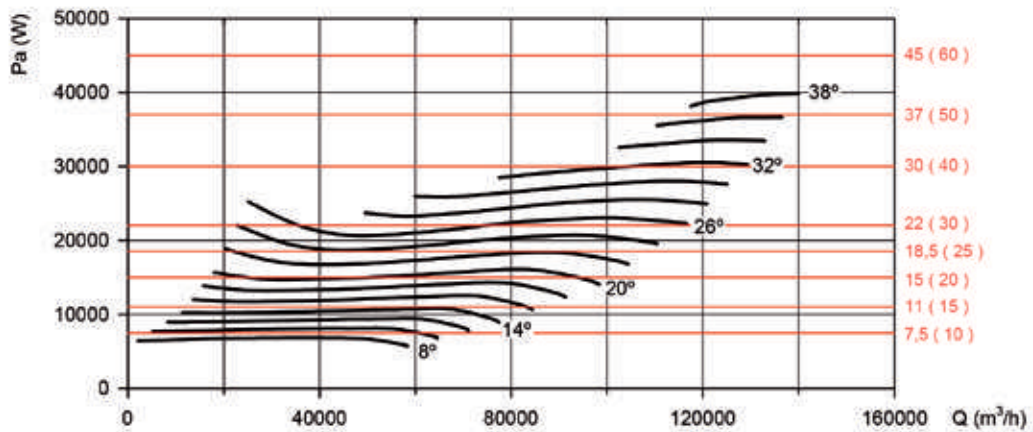

Curvas características

Q= Caudal en m³/h, m³/s y cfm.

Pe= Presión estática en mmH₂O, Pa e inwg.

125-4T/6

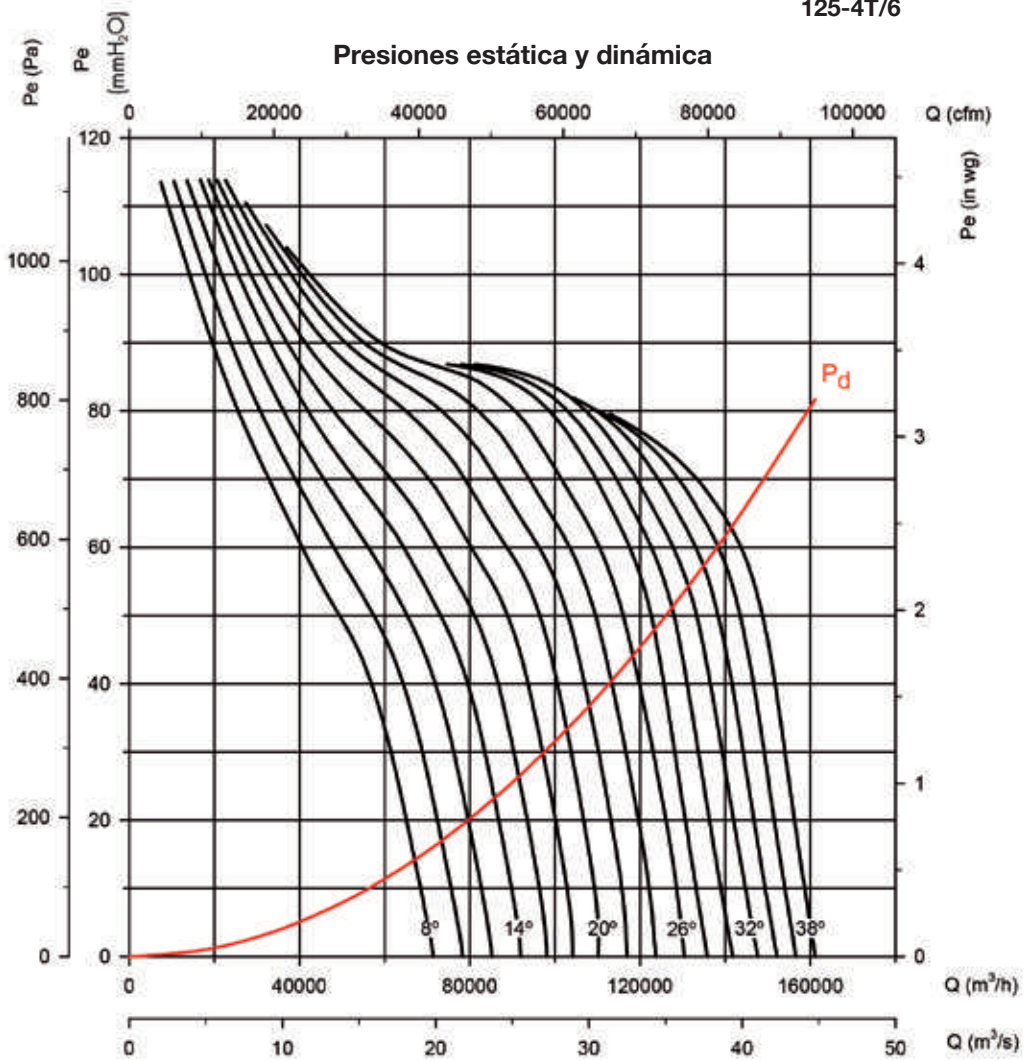

Potencia absorbida

Potencia Motor Recomendada kW(CV)

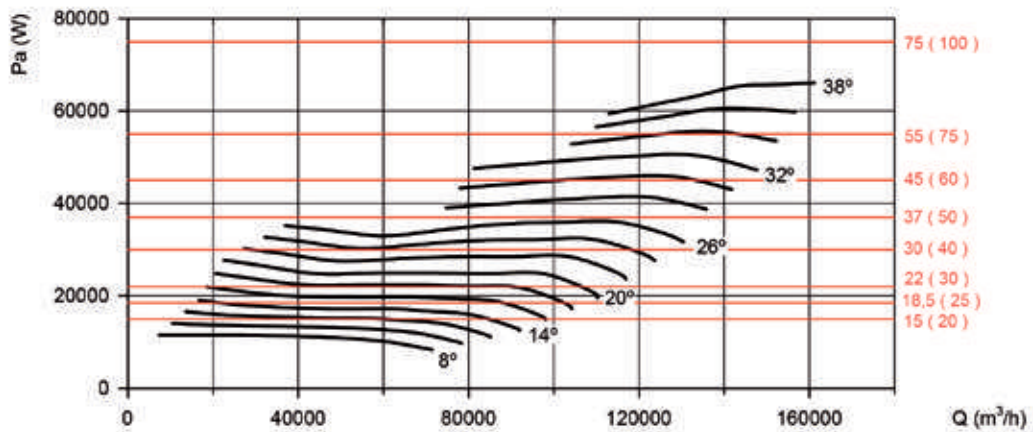

Curvas características

Q= Caudal en m³/h, m³/s y cfm.

Pe= Presión estática en mmH₂O, Pa e inwg.

125-4T/9

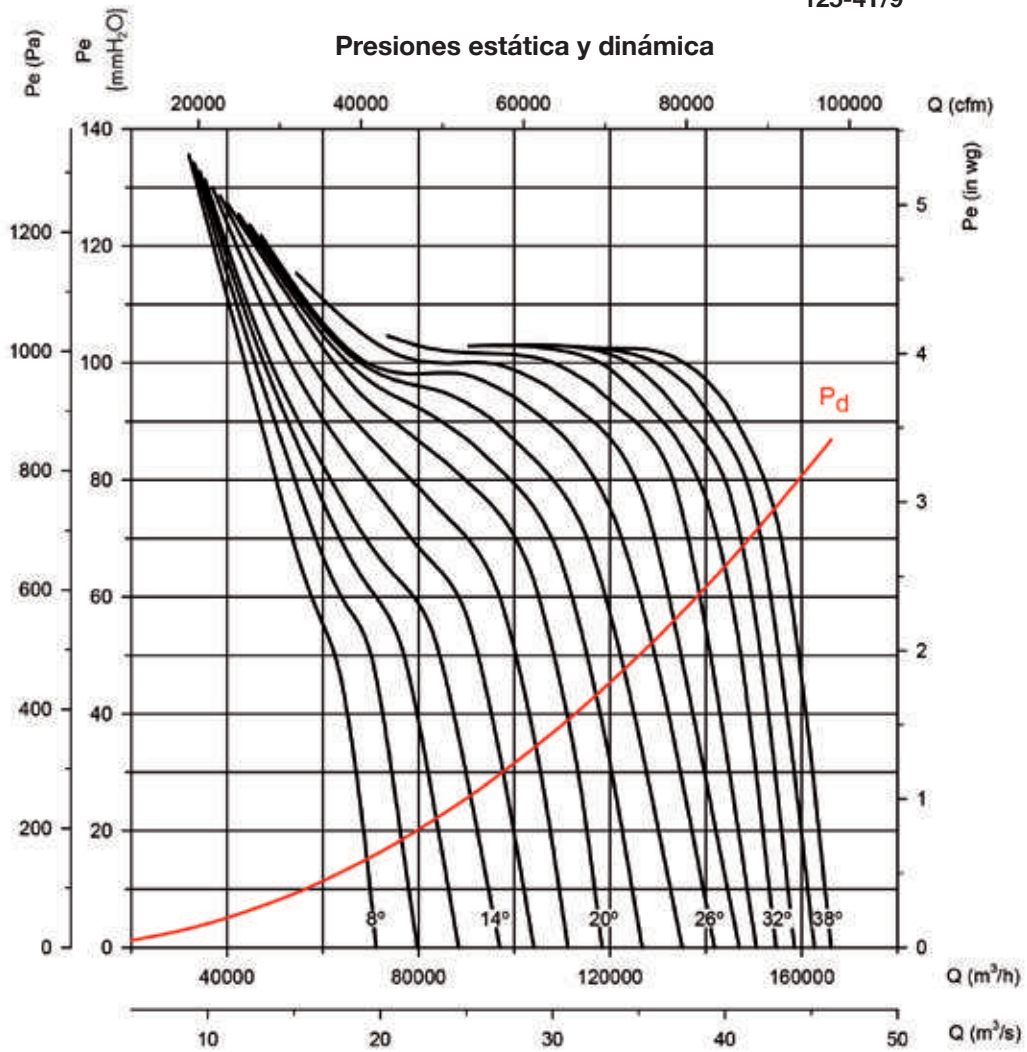

Potencia absorbida

Potencia Motor Recomendada
kW(CV)

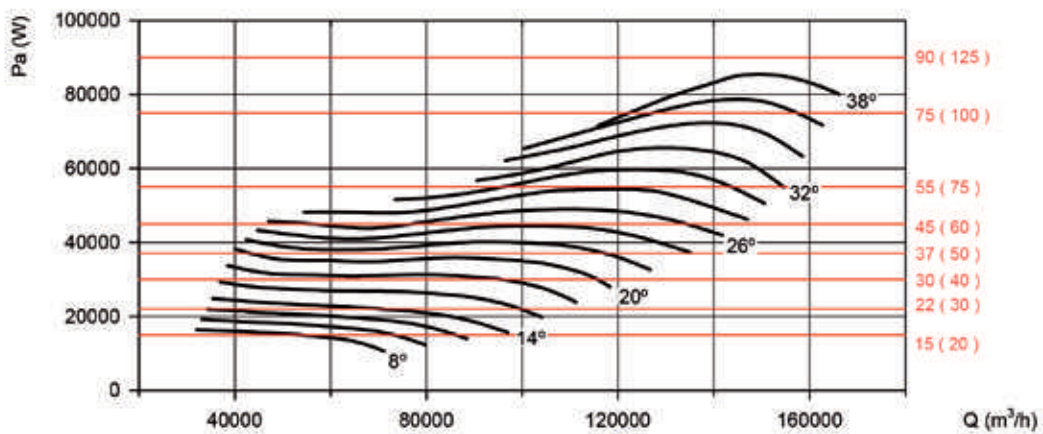

Curvas características

Q= Caudal en m³/h, m³/s y cfm.

Pe= Presión estática en mmH₂O, Pa e inwg.

125-6T/3

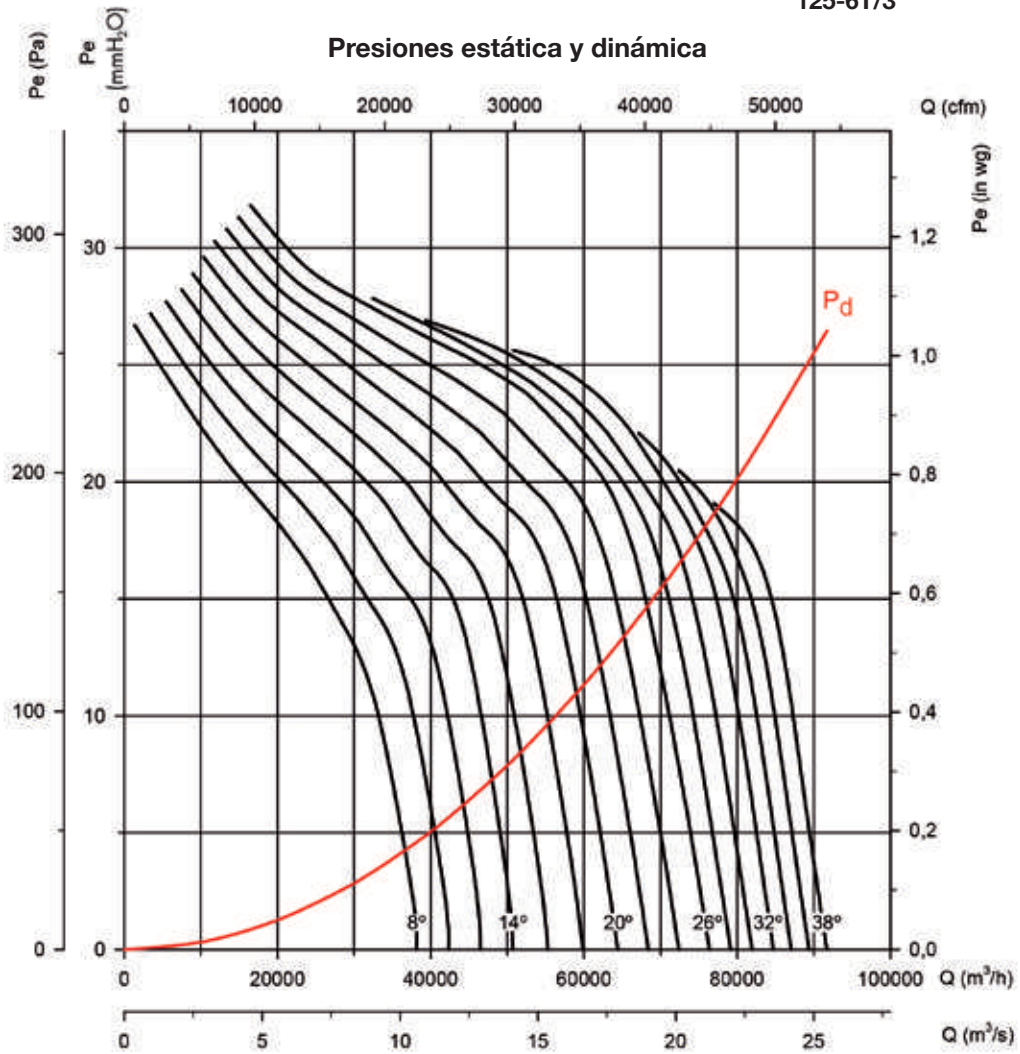

Potencia absorbida

Potencia Motor Recomendada kW(CV)

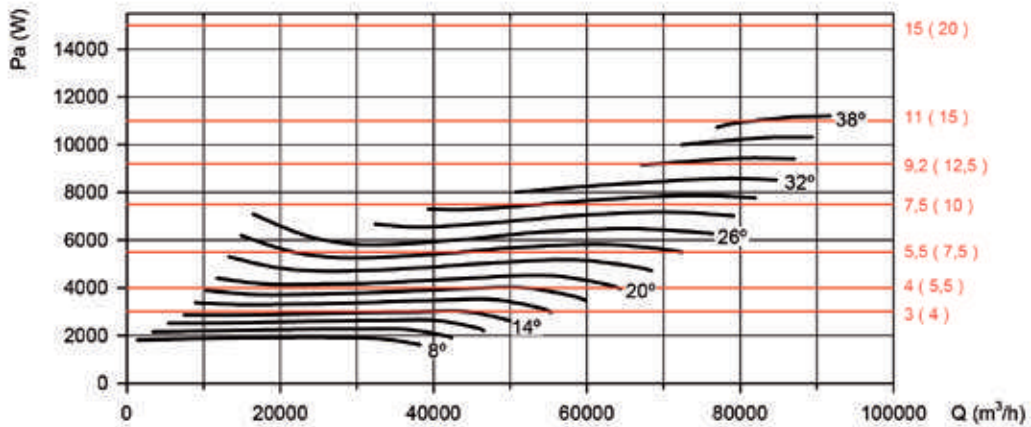

Curvas características

Q= Caudal en m³/h, m³/s y cfm.

Pe= Presión estática en mmH₂O, Pa e inwg.

125-6T/6

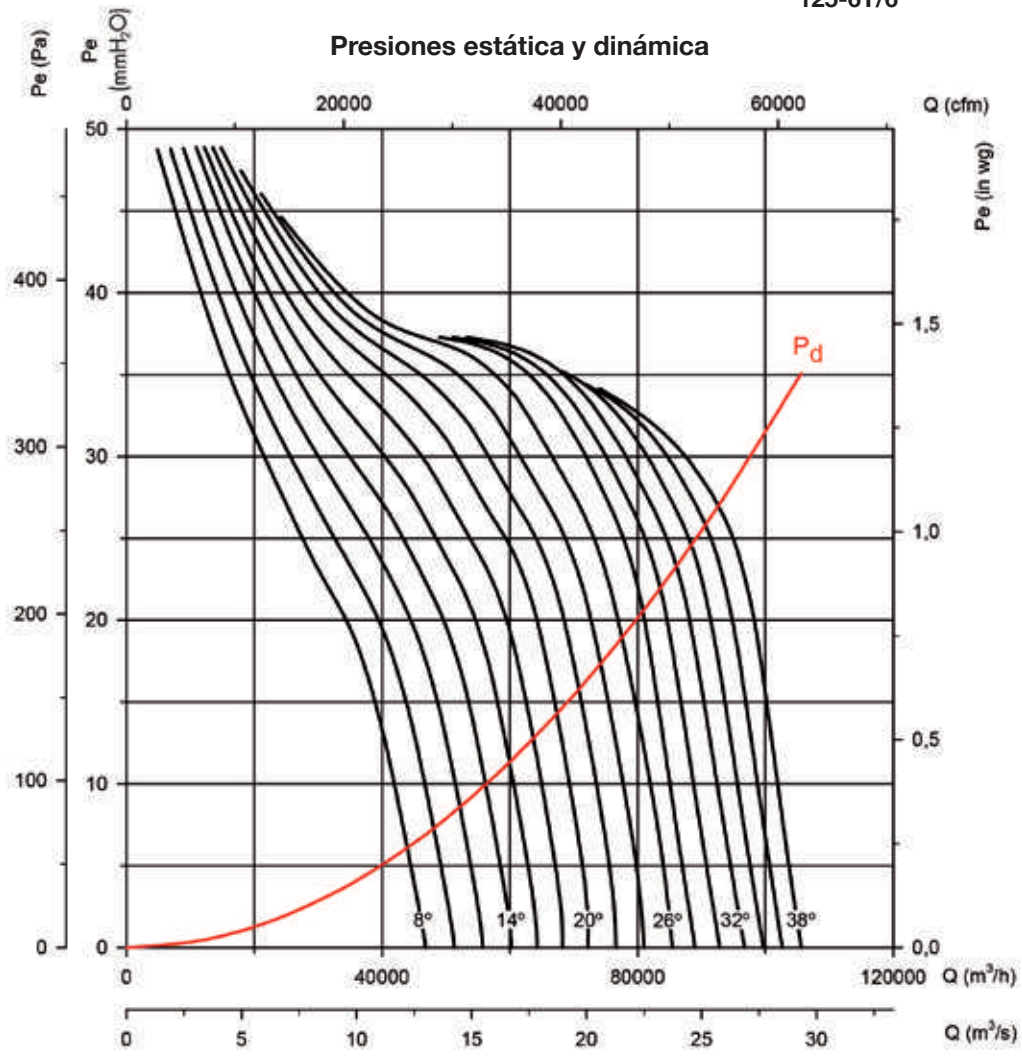

Potencia absorbida

Potencia Motor Recomendada kW(CV)

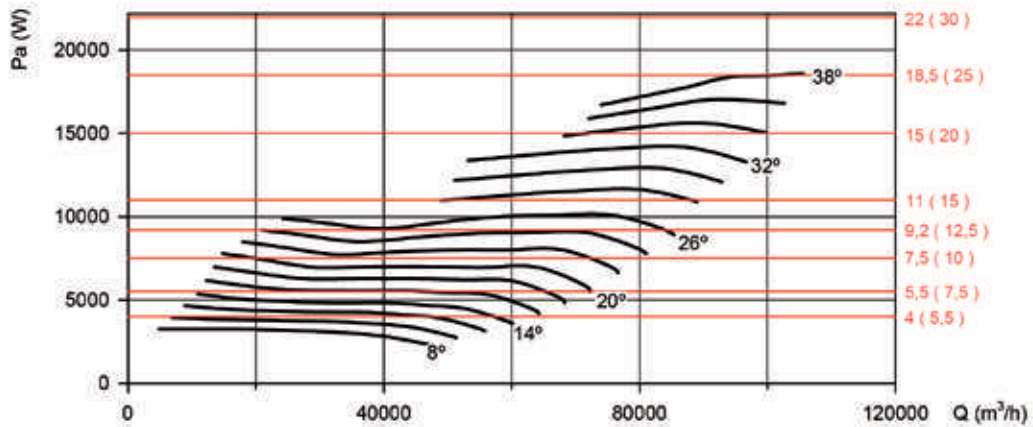

Curvas características

Q= Caudal en m³/h, m³/s y cfm.

Pe= Presión estática en mmH₂O, Pa e inwg.

125-6T/9

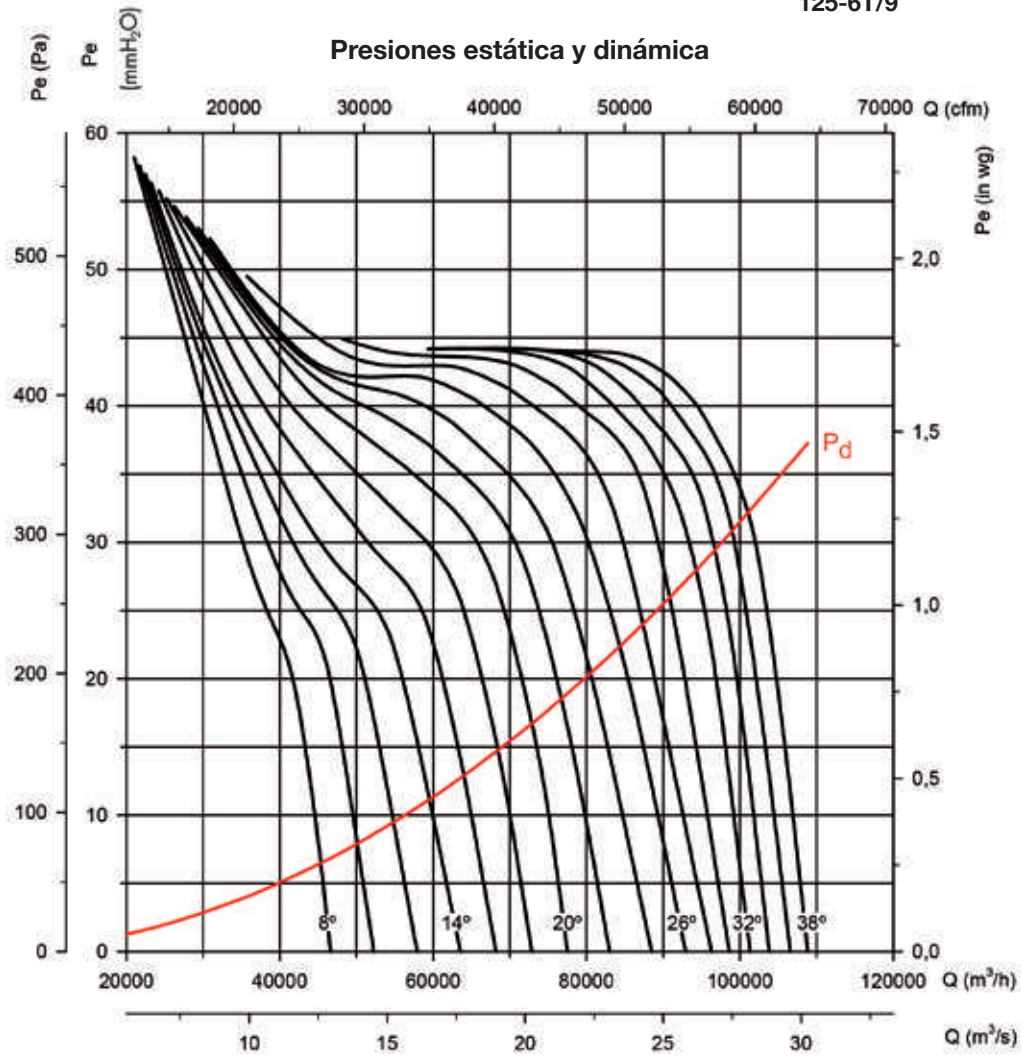

Potencia absorbida

Potencia Motor Recomendada kW(CV)

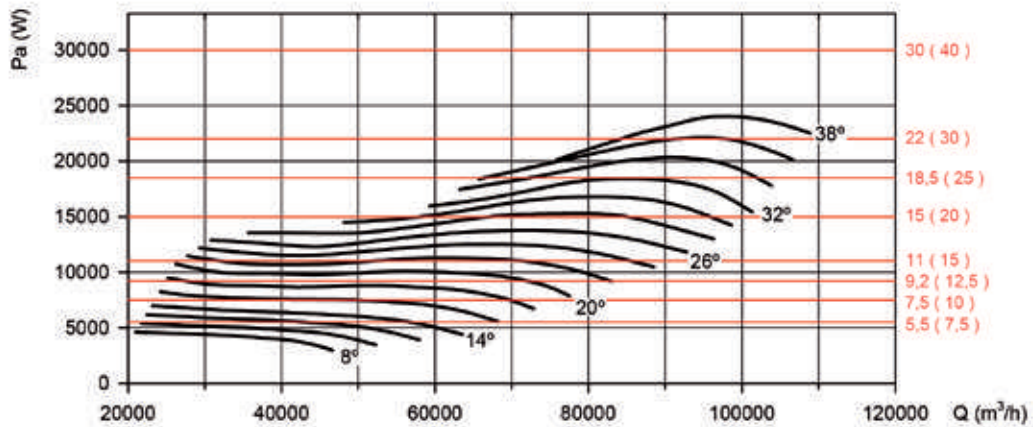

HCH/ATEX HCT/ATEX

HCH/ATEX: Extractores helicoidales murales de gran robustez, con Certificación ATEX

HCT/ATEX: Extractores helicoidales tubulares de gran robustez, con Certificación ATEX



HCH/ATEX



HCT/ATEX

Extractores helicoidales circulares (HCH) o tubulares (HCT), y Certificación ATEX con motor antiexplosivo CEE ExII2G Ex e, antideflagrante CEE ExII2G Ex d, Ex tc, o Ex tb para trabajar en atmósferas explosivas.

Ventilador:

- HCH/ATEX: Aro soporte en chapa de acero, con banda de aluminio en la zona de la hélice según norma EN-14986
- HCT/ATEX: Envoltorio tubular en chapa de acero, con banda de aluminio en la zona de la hélice según norma EN-14986
- Hélice en fundición de aluminio
- Incorpora trampilla de inspección (HCT)
- Dirección aire motor-hélice

Motor:

- Motores clase F, con rodamientos a bolas con certificación ATEX, antiexplosivos Ex e, antideflagrante Ex d, Ex tc, o Ex tb
- Trifásicos 230/400V.-50Hz.(hasta 4 kW) y 400/690V.-50Hz. (potencias superiores a 4 kW)
- Temperatura de trabajo: -20°C.+ 40°C.

Ex "e" marcado: $\text{CE} \text{Ex} \text{II 2G Ex e}$
 Ex "d" marcado: $\text{CE} \text{Ex} \text{II 2G Ex d}$
 Ex tc marcado: $\text{CE} \text{Ex} \text{II 3D Ex tc}$
 Ex tb marcado: $\text{CE} \text{Ex} \text{II 2D Ex tb}$
Organismo notificado: L.O.M.
Nº de identificación:
LOM3ATEX0157

Acabado:

- Anticorrosivo con pintura ATEX, libre de componentes férricos, en resina de poliéster polimerizada a 190 °C, previo desengrase con tratamiento nanotecnológico libre de fosfatos

Bajo demanda:

- Motores con PTC incorporada
- Bobinados especiales para diferentes tensiones y frecuencias
- Construcción ATEX para diferentes categorías
- Extractores con motor de 2 velocidades
- Motores monofásicos antideflagrantes Ex d

Código de pedido

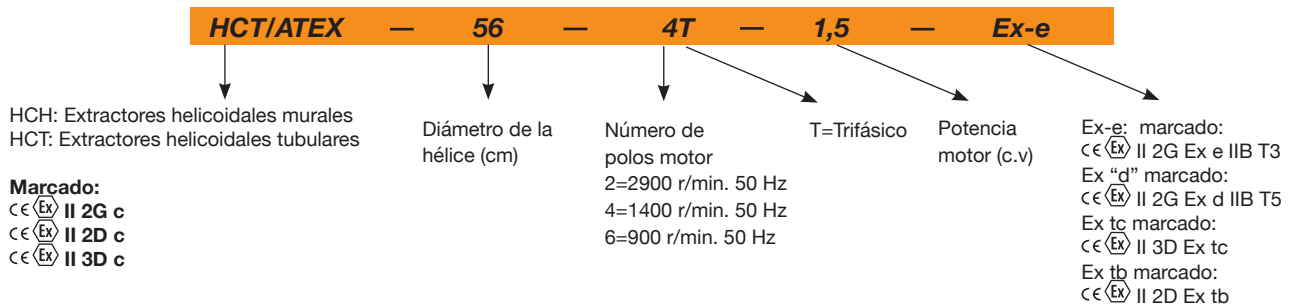

Características técnicas

Modelo	Velocidad (r/min)	Intensidad máxima admisible (A)			Potencia instalada (kW)	Caudal máximo (m³/h)	Nivel presión sonora dB(A)	Peso aprox. con motor (Kg)	
		230V	400V	690V				Ex-e	Ex-d
HCH/ATEX HCT/ATEX 35-2T	2770	2,08	1,20		0,37	5750	77	13	23
HCH/ATEX HCT/ATEX 35-4T	1400	1,28	0,74		0,12	3100	59	12	19
HCH/ATEX HCT/ATEX 40-2T-1,5	2850	4,50	2,60		1,10	8800	84	27	40
HCH/ATEX HCT/ATEX 40-4T-0,33	1370	2,08	1,20		0,25	5150	64	21	30
HCT/ATEX 45-2T-2	2800	6,24	3,60		1,50	10650	86	30	49
HCT/ATEX 45-2T-3	2860	8,66	5,00		2,20	12750	88	33	54
HCH/ATEX HCT/ATEX 45-4T-0,5	1370	2,60	1,50		0,37	7100	68	25	33
HCT/ATEX 50-4T-0,75	1410	2,94	1,70		0,55	10400	70	27	41
HCH/ATEX HCT/ATEX 56-4T-0,75	1410	2,94	1,70		0,55	11050	72	32	46
HCH/ATEX HCT/ATEX 56-4T-1	1410	3,81	2,20		0,75	12950	73	34	47
HCH/ATEX HCT/ATEX 56-4T-1,5	1410	5,20	3,00		1,10	14000	74	36	55
HCH/ATEX HCT/ATEX 56-4T-2	1400	6,93	4,00		1,50	15300	75	39	59
HCH/ATEX HCT/ATEX 56-6T-0,33	910	2,42	1,40		0,25	8500	61	31	39
HCH/ATEX HCT/ATEX 56-6T-0,5	935	2,77	1,60		0,37	9300	61	34	43
HCH/ATEX HCT/ATEX 56-6T-0,75	930	3,46	2,00		0,55	10000	62	34	47
HCH/ATEX HCT/ATEX 63-4T-1	1410	3,81	2,20		0,75	14150	73	43	56
HCH/ATEX HCT/ATEX 63-4T-1,5	1410	5,20	3,00		1,10	17000	74	45	64
HCH/ATEX HCT/ATEX 63-4T-2	1400	6,93	4,00		1,50	18900	75	48	68
HCH/ATEX HCT/ATEX 63-4T-3	1410	9,01	5,20		2,20	22100	76	53	76
HCH/ATEX HCT/ATEX 63-4T-4	1440	12,30	7,10		3,00	25400	77	56	79

Características técnicas

Modelo	Velocidad (r/min)	Intensidad máxima admisible (A)			Potencia instalada (kW)	Caudal máximo (m³/h)	Nivel presión sonora dB(A)	Peso aprox. con motor (Kg)	
		230V	400V	690V				Ex-e	Ex-d
HCH/ATEX HCT/ATEX 63-6T-0,5	935	2,77	1,60		0,37	12150	64	43	52
HCH/ATEX HCT/ATEX 63-6T-0,75	930	3,46	2,00		0,55	12750	65	43	56
HCH/ATEX HCT/ATEX 63-6T-1	930	4,16	2,40		0,75	13800	66	45	64
HCH/ATEX HCT/ATEX 71-4T-1,5	1410	5,20	3,00		1,10	19750	78	51	70
HCH/ATEX HCT/ATEX 71-4T-2	1400	6,93	4,00		1,50	21100	79	54	74
HCH/ATEX HCT/ATEX 71-4T-3	1410	9,01	5,20		2,20	23950	81	60	83
HCH/ATEX HCT/ATEX 71-4T-4	1440	12,30	7,10		3,00	29400	82	63	86
HCH/ATEX HCT/ATEX 71-6T-0,75	930	3,46	2,00		0,55	15150	67	49	62
HCH/ATEX HCT/ATEX 71-6T-1	930	4,16	2,40		0,75	17250	68	51	70
HCH/ATEX HCT/ATEX 71-6T-1,5	910	5,89	3,40		1,10	20950	69	54	75
HCH/ATEX HCT/ATEX 80-4T-3	1410	9,01	5,20		2,20	28000	82	69	92
HCH/ATEX HCT/ATEX 80-4T-4	1440	12,30	7,10		3,00	32700	83	72	95
HCH/ATEX HCT/ATEX 80-4T-5,5	1450	15,76	9,10		4,00	37200	84	74	98
HCH/ATEX HCT/ATEX 80-6T-1	930	4,16	2,40		0,75	20600	71	60	79
HCH/ATEX HCT/ATEX 80-6T-1,5	910	5,89	3,40		1,10	24250	72	63	84
HCH/ATEX HCT/ATEX 80-6T-2	940	7,62	4,40		1,50	28000	73	71	95
HCH/ATEX HCT/ATEX 80-6T-3	940	9,35	5,40		2,20	32500	74	74	98
HCH/ATEX HCT/ATEX 90-4T-4	1440	12,30	7,10		3,00	37750	87	87	110
HCH/ATEX HCT/ATEX 90-4T-5,5	1450	15,76	9,10		4,00	41850	89	90	114
HCH/ATEX HCT/ATEX 90-4T-7,5	1440		12,00	6,93	5,50	47000	91	103	142
HCH/ATEX HCT/ATEX 90-4T-10	1448		16,30	9,41	7,50	53000	92	111	145
HCH/ATEX HCT/ATEX 90-6T-2	940	7,62	4,40		1,50	30000	77	86	110
HCH/ATEX HCT/ATEX 90-6T-3	940	9,35	5,40		2,20	35000	78	90	114
HCH/ATEX HCT/ATEX 90-6T-4	945	14,72	8,50		3,00	40000	79	102	142
HCH/ATEX HCT/ATEX 100-4T-7,5	1440		12,00	6,93	5,50	52500	92	115	154
HCH/ATEX HCT/ATEX 100-4T-10	1448		16,30	9,41	7,50	58500	93	122	156
HCH/ATEX HCT/ATEX 100-4T-15	1460		23,80	13,74	11,00	68000	94	159	256
HCH/ATEX HCT/ATEX 100-4T-20	1450		30,60	17,67	15,00	71850	95	178	279
HCH/ATEX HCT/ATEX 100-6T-3	940	9,35	5,40		2,20	40500	82	101	125
HCH/ATEX HCT/ATEX 100-6T-4	945	14,72	8,50		3,00	46950	83	113	153
HCH/ATEX HCT/ATEX 100-6T-5,5	950	18,88	10,90		4,00	52000	84	120	156

Dimensiones mm

HCH/ATEX

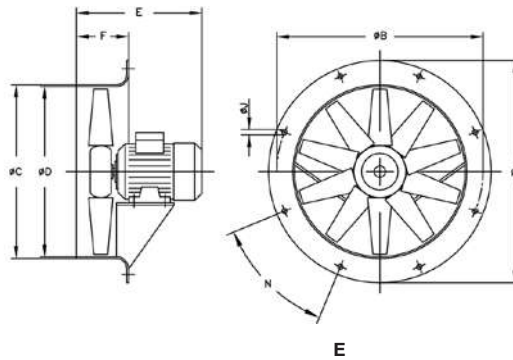

Modelo	ØA	ØB	ØC	ØD	E															F	ØJ	N
					0,16	0,33	0,5	0,75	1	1,5	2	3	4	5,5	7,5	10	15	20				
HCH-35-2	425	395	358	355	--	--	285	--	--	--	--	--	--	--	--	--	--	110	10	8x45°		
HCH-35-4	425	395	358	355	257	--	--	--	--	--	--	--	--	--	--	--	--	110	10	8x45°		
HCH-40-2	490	450	414	410	--	--	--	--	314	--	--	--	--	--	--	--	--	120	12	8x45°		
HCH-40-4	490	450	414	410	--	305	--	--	--	--	--	--	--	--	--	--	--	120	12	8x45°		
HCH-45-4	540	500	464	460	--	--	295	--	--	--	--	--	--	--	--	--	--	120	12	8x45°		
HCH-45-6	540	500	464	460	--	295	--	--	--	--	--	--	--	--	--	--	--	120	12	8x45°		
HCH-56-4	660	620	564	560	--	--	--	316	316	330	354	--	--	--	--	--	--	120	12	12x30°		
HCH-56-6	660	620	564	560	--	298	316	316	--	--	--	--	--	--	--	--	--	120	12	12x30°		
HCH-63-4	730	690	645	640	--	--	--	--	332	340	366	420	420	--	--	--	--	150	12	12x30°		
HCH-63-6	730	690	645	640	--	--	332	332	340	--	--	--	--	--	--	--	--	150	12	12x30°		
HCH-71-4	810	770	715	710	--	--	--	--	--	334	360	430	430	--	--	--	--	150	12	16x22°30'		
HCH-71-6	810	770	715	710	--	--	--	323	334	360	--	--	--	--	--	--	--	150	12	16x22°30'		
HCH-80-4	900	860	805	800	--	--	--	--	--	--	425	425	445	--	--	--	--	180	12	16x22°30'		
HCH-80-6	900	860	805	800	--	--	--	--	360	386	425	445	--	--	--	--	--	180	12	16x22°30'		
HCH-90-4	1015	970	906	900	--	--	--	--	--	--	--	436	430	465	465	--	--	180	12	16x22°30'		
HCH-90-6	1015	970	906	900	--	--	--	--	--	436	430	465	--	--	--	--	--	180	12	16x22°30'		
HCH-100-4	1115	1070	1006	1000	--	--	--	--	--	--	--	--	--	480	503	612	612	200	15	16x22°30'		
HCH-100-6	1115	1070	1006	1000	--	--	--	--	--	--	440	503	503	--	--	--	--	200	15	16x22°30'		

Las medidas corresponden a la versión Ex "e"

Dimensiones mm

HCT/ATEX

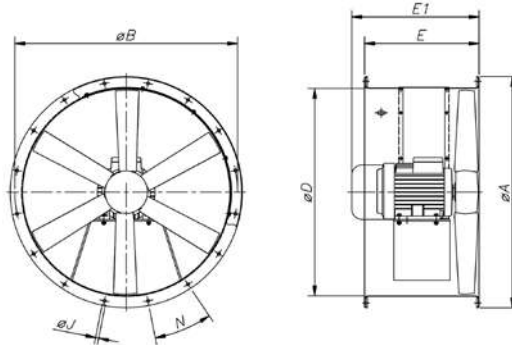

Modelo	$\varnothing A$	$\varnothing B$	D	E	E1	$\varnothing J$	N
HCT-35-2T/ATEX	425	395	355	280	306	10	8x45°
HCT-35-4T/ATEX	425	395	355	280	322	10	8x45°
HCT-40-2T-1,5/ATEX	490	450	410	400	400	12	8x45°
HCT-40-4T-0,33/ATEX	490	450	410	400	400	12	8x45°
HCT-45-2T-2/ATEX	540	500	460	400	422	12	8x45°
HCT-45-2T-3/ATEX	540	500	460	400	422	12	8x45°
HCT-45-4T-0,5/ATEX	540	500	460	400	400	12	8x45°
HCT-50-4T-0,75/ATEX	600	560	514	400	400	12	12x30°
HCT-56-4T-0,75/ATEX	660	620	560	400	400	12	12x30°
HCT-56-4T-1/ATEX	660	620	560	400	400	12	12x30°
HCT-56-4T-1,5/ATEX	660	620	560	400	422	12	12x30°
HCT-56-4T-2/ATEX	660	620	560	400	422	12	12x30°
HCT-56-6T-0,33/ATEX	660	620	560	400	400	12	12x30°
HCT-56-6T-0,5/ATEX	660	620	560	400	400	12	12x30°
HCT-56-6T-0,75/ATEX	660	620	560	400	400	12	12x30°
HCT-63-4T-1/ATEX	730	690	640	400	400	12	12x30°
HCT-63-4T-1,5/ATEX	730	690	640	400	422	12	12x30°
HCT-63-4T-2/ATEX	730	690	640	400	422	12	12x30°
HCT-63-4T-3/ATEX	730	690	640	500	500	12	12x30°
HCT-63-4T-4/ATEX	730	690	640	500	500	12	12x30°
HCT-63-6T-0,5/ATEX	730	690	640	400	400	12	12x30°
HCT-63-6T-0,75/ATEX	730	690	640	400	400	12	12x30°
HCT-63-6T-1/ATEX	730	690	640	400	422	12	12x30°
HCT-71-4T-1,5/ATEX	810	770	710	430	442	12	16x22°30'
HCT-71-4T-2/ATEX	810	770	710	430	442	12	16x22°30'
HCT-71-4T-3/ATEX	810	770	710	500	500	12	16x22°30'

Modelo	$\varnothing A$	$\varnothing B$	D	E	E1	$\varnothing J$	N
HCT-71-4T-4/ATEX	810	770	710	500	500	12	16x22°30'
HCT-71-6T-0,75/ATEX	810	770	710	430	430	12	16x22°30'
HCT-71-6T-1/ATEX	810	770	710	500	442	12	16x22°30'
HCT-71-6T-1,5/ATEX	810	770	710	500	442	12	16x22°30'
HCT-80-4T-3/ATEX	900	860	800	500	500	12	16x22°30'
HCT-80-4T-4/ATEX	900	860	800	500	500	12	16x22°30'
HCT-80-4T-5,5/ATEX	900	860	800	500	519	12	16x22°30'
HCT-80-6T-1/ATEX	900	860	800	500	500	12	16x22°30'
HCT-80-6T-1,5/ATEX	900	860	800	500	500	12	16x22°30'
HCT-80-6T-2/ATEX	900	860	800	500	500	12	16x22°30'
HCT-80-6T-3/ATEX	900	860	800	500	519	12	16x22°30'
HCT-90-4T-4/ATEX	1015	970	900	600	600	15	16x22°30'
HCT-90-4T-5,5/ATEX	1015	970	900	600	600	15	16x22°30'
HCT-90-4T-7,5/ATEX	1015	970	900	600	636	15	16x22°30'
HCT-90-4T-10/ATEX	1015	970	900	600	716	15	16x22°30'
HCT-90-6T-2/ATEX	1015	970	900	600	600	15	16x22°30'
HCT-90-6T-3/ATEX	1015	970	900	600	600	15	16x22°30'
HCT-90-6T-4/ATEX	1015	970	900	600	636	15	16x22°30'
HCT-100-4T-7,5/ATEX	1115	1070	1000	600	636	15	16x22°30'
HCT-100-4T-10/ATEX	1115	1070	1000	600	716	15	16x22°30'
HCT-100-4T-15/ATEX	1115	1070	1000	700	738	15	16x22°30'
HCT-100-4T-20/ATEX	1115	1070	1000	700	738	15	16x22°30'
HCT-100-6T-3/ATEX	1115	1070	1000	600	600	15	16x22°30'
HCT-100-6T-4/ATEX	1115	1070	1000	600	636	15	16x22°30'
HCT-100-6T-5,5/ATEX	1115	1070	1000	600	716	15	16x22°30'

Las medidas corresponden a la versión Ex "e"

Características acústicas

Los valores indicados, se determinan mediante medidas de nivel de presión y potencia sonora en dB(A) obtenidas en campo libre a una distancia equivalente a dos veces la envergadura del ventilador más el diámetro de la hélice, con un mínimo de 1,5 mts.

Espectro de potencia sonora Lw(A) en dB(A) banda de frecuencia en [Hz]

Modelo	63	125	250	500	1000	2000	4000	8000
35-2T	48	63	82	81	82	81	76	67
35-4T	30	45	64	63	64	63	58	49
40-2T-1.5	55	70	89	88	89	88	83	74
40-4T-0.33	35	50	69	68	69	68	63	54
45-2T-2	51	68	80	88	93	93	89	82
45-2T-3	53	70	82	90	95	95	91	84
45-4T-0.5	33	50	62	70	75	75	71	64
50-4T-0.75	37	54	67	74	79	80	75	68
56-4T-0.75	47	67	75	80	82	79	72	61
56-4T-1	48	68	76	81	83	80	73	62
56-4T-1.5	49	69	77	82	84	81	74	63
56-4T-2	50	70	78	83	85	82	75	64
56-6T-0.33	36	56	64	69	71	68	61	50
56-6T-0.5	36	56	64	69	71	68	61	50
56-6T-0.75	37	57	65	70	72	69	62	51
63-4T-1	50	70	78	83	85	82	75	64
63-4T-1.5	51	71	79	84	86	83	76	65
63-4T-2	52	72	80	85	87	84	77	66
63-4T-3	53	73	81	86	88	85	78	67
63-4T-4	54	74	82	87	89	86	79	68
63-6T-0.5	41	61	69	74	76	73	66	55
63-6T-0.75	42	62	70	75	77	74	67	56
63-6T-1	43	63	71	76	78	75	68	57
71-4T-1.5	55	75	83	88	90	87	80	69
71-4T-2	56	76	84	89	91	88	81	70
71-4T-3	58	78	86	91	93	90	83	72

Modelo	63	125	250	500	1000	2000	4000	8000
71-4T-4	59	79	87	92	94	91	84	73
71-6T-0,75	44	64	72	77	79	76	69	58
71-6T-1	45	65	73	78	80	77	70	59
71-6T-1,5	46	66	74	79	81	78	71	60
80-4T-2	59	79	87	92	94	91	84	73
80-4T-4	60	80	88	93	95	92	85	74
80-4T-5,5	61	81	89	94	96	93	86	75
80-6T-1	48	68	76	81	83	80	73	62
80-6T-1,5	49	69	77	82	84	81	74	63
80-6T-2	50	70	78	83	85	82	75	64
80-6T-3	51	71	79	84	86	83	76	65
80-4T-4	65	86	93	98	101	97	90	79
90-4T-5,5	67	88	95	100	103	99	92	81
90-4T-7,5	69	90	97	102	105	101	94	83
90-4T-10	70	91	98	103	106	102	95	84
90-6T-2	55	76	83	88	91	87	80	69
90-6T-3	56	77	84	89	92	88	81	70
90-6T-4	57	78	85	90	93	89	82	71
100-4T-7,5	72	92	100	105	107	104	97	86
100-4T-10	73	93	101	106	108	105	98	87
100-4T-15	74	94	102	107	109	106	99	88
100-4T-20	75	95	103	108	110	107	100	89
100-6T-3	62	82	90	95	97	94	87	76
100-6T-4	63	83	91	96	98	95	88	77
100-6T-5,5	64	84	92	97	99	96	89	78



Curvas características

Q= Caudal en m³/h, m³/s y cfm.

Pe= Presión estática en mmH2O, Pa e in wg.

2 Polos=3000 r/min

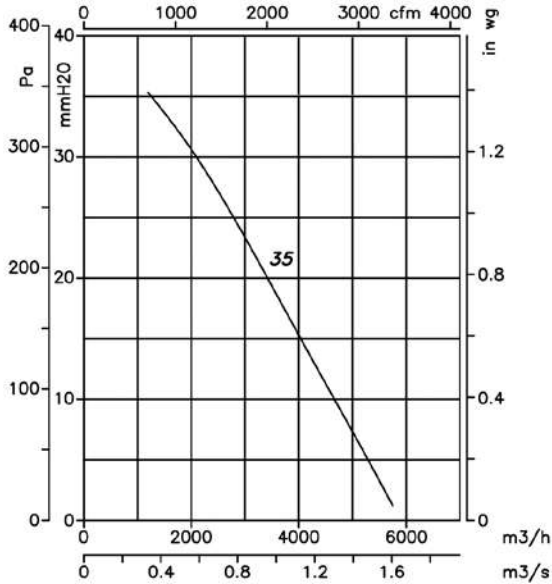

2 Polos=3000 r/min

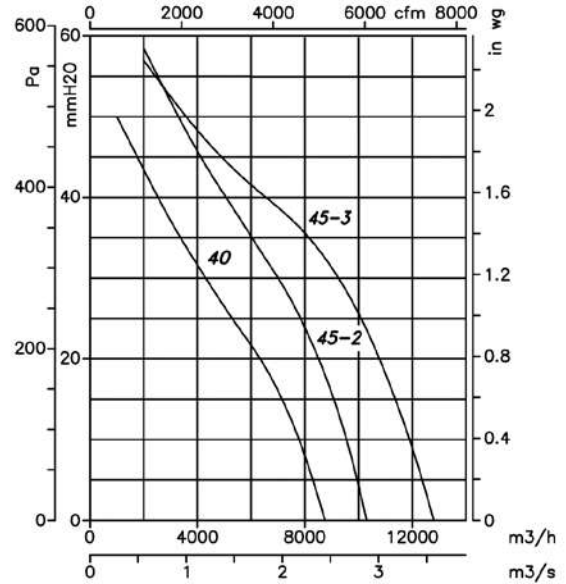

4 Polos=1500 r/min

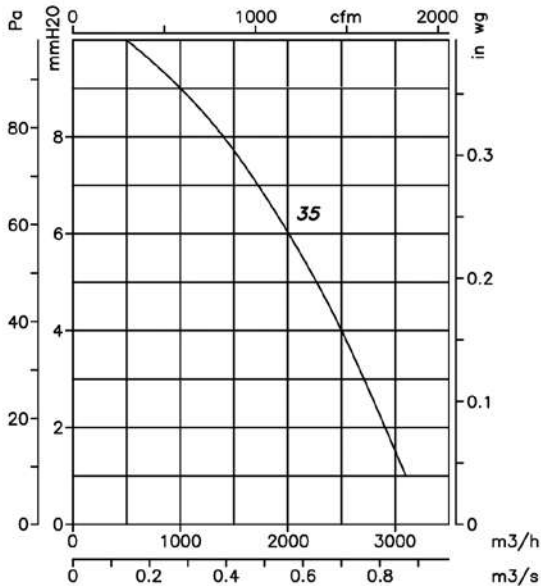

4 Polos=1500 r/min

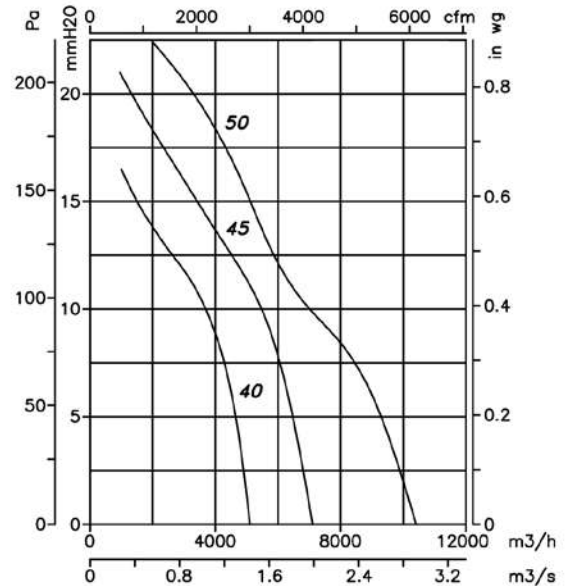

Curvas características

Q= Caudal en m³/h, m³/s y cfm.

Pe= Presión estática en mmH₂O, Pa e inwg.

4 Polos=1500 r/min

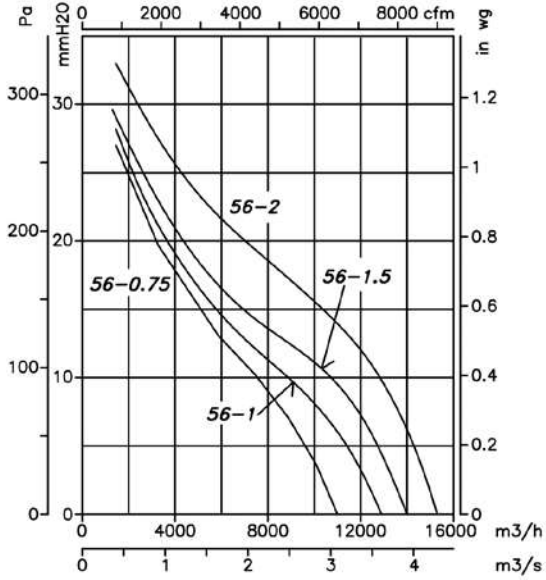

4 Polos=1500 r/min

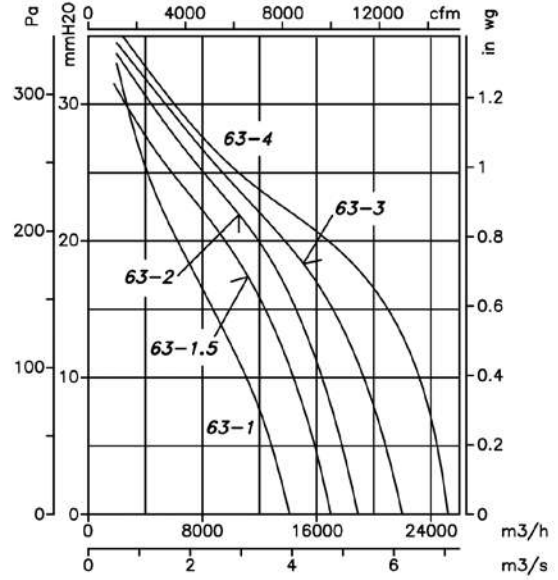

4 Polos=1500 r/min

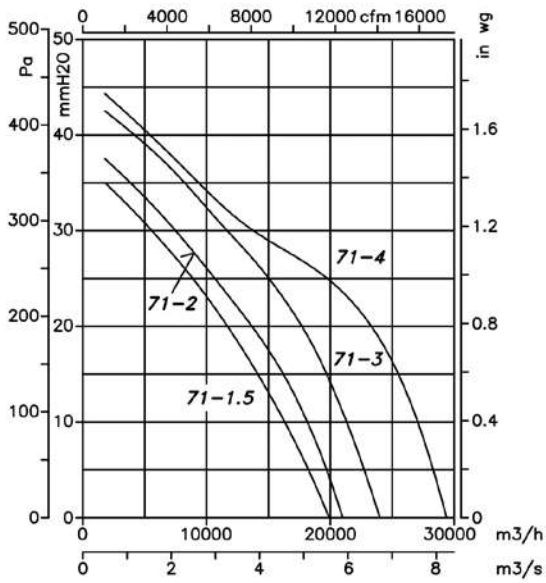

4 Polos=1500 r/min

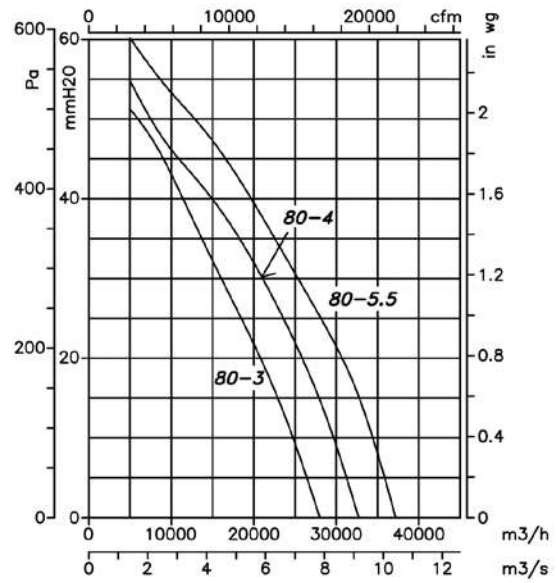



Curvas características

Q= Caudal en m³/h, m³/s y cfm.

Pe= Presión estática en mmH₂O, Pa e in wg.

4 Polos=1500 r/min

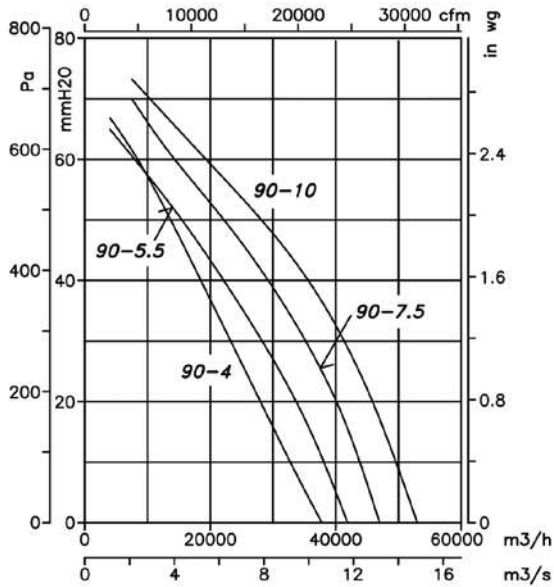

4 Polos=1500 r/min

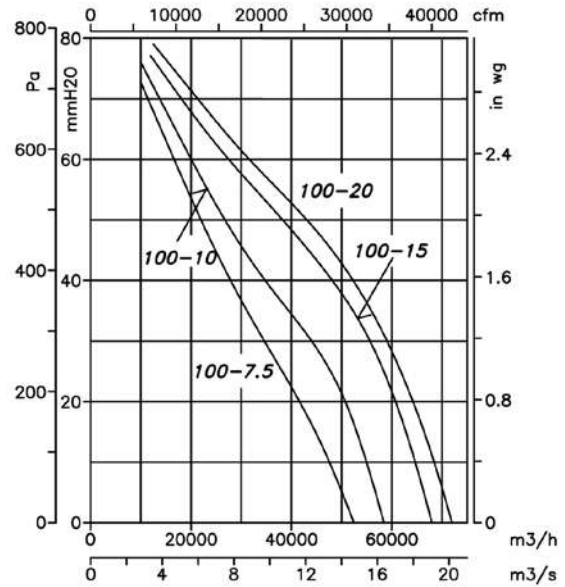

6 Polos=1000 r/min

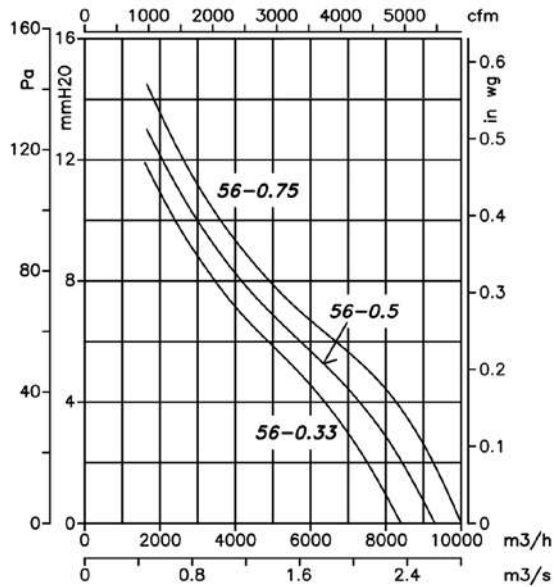

6 Polos=1000 r/min

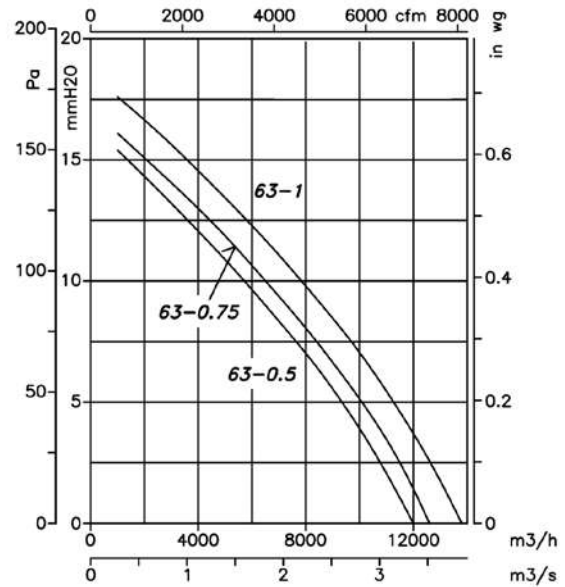

Curvas características

Q= Caudal en m³/h, m³/s y cfm.

Pe= Presión estática en mmH₂O, Pa e inwg.

6 Polos=1000 r/min

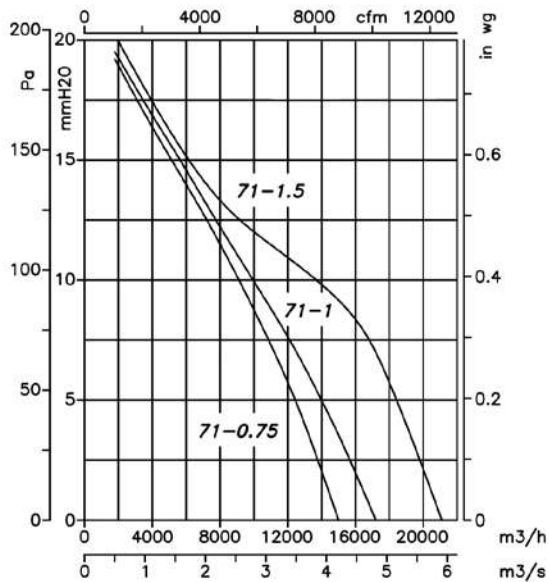

6 Polos=1000 r/min

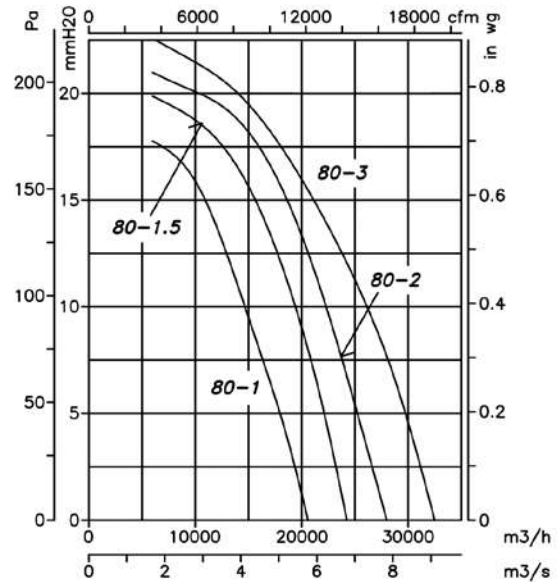

6 Polos=1000 r/min

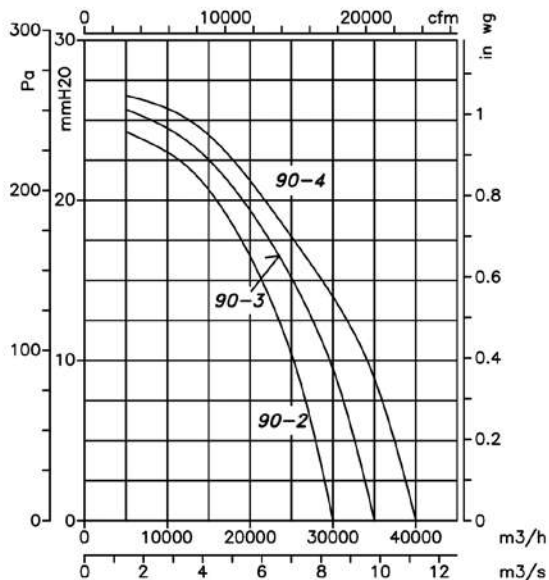

6 Polos=1000 r/min

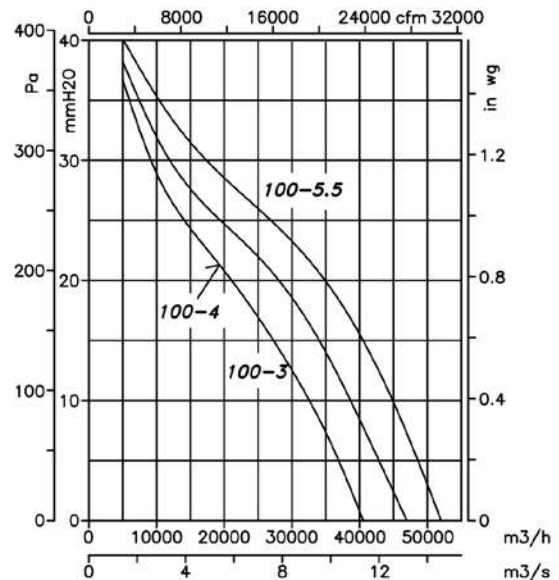

Accesorios

Ver apartado accesorios.



HPX/ATEX

Extractores helicoidales tubulares, con motor exterior y Certificación ATEX

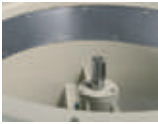

Banda de aluminio para prevenir chispas según norma EN-14986:2007

Extractores helicoidales tubulares, accionados a transmisión, con apertura de envoltorio hasta 180° para trabajar en atmósferas explosivas.

Ventilador:

- Envoltorio tubular en chapa de acero, con banda de aluminio en la zona de la hélice según norma EN-14986
- Hélices en fundición de aluminio
- Protector correas y poleas con recubrimiento de cobre para evitar chispas
- Grupo de transmisión estanco (IP66) con sistema de doble retén
- Dirección aire motor-hélice
- Temperatura del aire a transportar -20°C.+ 120°C.

Motor:

- Motores clase F, con rodamientos a bolas, protección IP55, con certificación ATEX, antiexplosivos Ex"e", antideflagrantes Ex"d", Ex tc, o Ex tb
- Trifásicos 230/400V.-50Hz.(hasta 4 kW) y 400/690V.-50Hz.(potencias superiores a 4 kW)



Ex "e" marcado: $\text{C} \llcorner \text{Ex} \text{ II 2G Ex e}$
 Ex "d" marcado: $\text{C} \llcorner \text{Ex} \text{ II 2G Ex d}$
 Ex "n" marcado: $\text{C} \llcorner \text{Ex} \text{ II 3G}$
 Ex tc marcado: $\text{C} \llcorner \text{Ex} \text{ II 3D Ex tc}$
 Ex tb marcado: $\text{C} \llcorner \text{Ex} \text{ II 2D Ex tb}$
 Organismo notificado: L.O.M.
 N° de identificación:
 LOM3ATEX0132

Acabado:

- Anticorrosivo con pintura ATEX, libre de componentes férricos, en resina de poliéster polimerizada a 190 °C, previo desengrase con tratamiento nanotecnológico libre de fosfatos

Bajo demanda:

- Motores con PTC incorporada
- Bobinados especiales para diferentes tensiones y frecuencias
- Construcción ATEX para diferentes categorías
- Extractores con motor de 2 velocidades
- Versión "nA" equipados con motores ATEX Ex nA

Código de pedido

HPX/ATEX — 63 — 4T — 2 — Ex-e

Extractores helicoidales tubulares, con motor exterior y Certificación ATEX

Diámetro de la hélice (cm)

Número de polos motor

2=2900 r/min. 50 Hz
4=1400 r/min. 50 Hz

T=Trifásico
M=Monofásico

Potencia motor (c.v.)

Ex-e: marcado:

$\text{C} \llcorner \text{Ex} \text{ II 2G Ex e IIB T3}$
 Ex "d" marcado:
 $\text{C} \llcorner \text{Ex} \text{ II 2G Ex d IIB T5}$
 Ex tc marcado:
 $\text{C} \llcorner \text{Ex} \text{ II 3D Ex tc}$
 Ex tb marcado:
 $\text{C} \llcorner \text{Ex} \text{ II 2D Ex tb}$

Marcado:

$\text{C} \llcorner \text{Ex} \text{ II 2G c}$
 $\text{C} \llcorner \text{Ex} \text{ II 3G c}$
 $\text{C} \llcorner \text{Ex} \text{ II 2D c}$
 $\text{C} \llcorner \text{Ex} \text{ II 3D c}$

Características técnicas

Modelo	Velocidad (r/min)	Intensidad máxima admisible (A)			Potencia instalada (kW)	Caudal máximo (m³/h)	Nivel presión sonora dB(A)	Peso aprox. (Kg)
		230V	400V	690V				
HPX/ATEX-35-2T-0,75	2710	2,94	1,70		0,55	4750	77	22
HPX/ATEX-35-4T-0,33	1370	2,08	1,20		0,25	2500	60	20
HPX/ATEX-45-4T-0,33	1370	2,08	1,20		0,25	6300	69	32
HPX/ATEX-45-4T-0,50	1370	2,60	1,50		0,37	6600	70	36
HPX/ATEX-50-4T-0,75	1410	2,94	1,70		0,55	9000	70	33
HPX/ATEX-50-4T-1	1410	3,81	2,20		0,75	10800	71	34
HPX/ATEX-56-4T-0,75	1410	2,94	1,70		0,55	11300	72	36
HPX/ATEX-56-4T-1	1410	3,81	2,20		0,75	12200	73	36
HPX/ATEX-56-4T-1,5	1410	5,20	3,00		1,10	14500	75	39
HPX/ATEX-63-4T-1,5	1410	5,20	3,00		1,10	16000	74	59
HPX/ATEX-63-4T-2	1400	6,93	4,00		1,50	17500	78	63
HPX/ATEX-71-4T-1,5	1410	5,20	3,00		1,10	20300	78	74
HPX/ATEX-71-4T-2	1400	6,93	4,00		1,50	22500	79	77
HPX/ATEX-71-4T-3	1410	9,01	5,20		2,20	24000	81	85
HPX/ATEX-80-4T-3	1410	9,01	5,20		2,20	29000	83	95
HPX/ATEX-80-4T-4	1440	12,30	7,10		3,00	32000	84	100
HPX/ATEX-80-4T-5,5	1450	15,76	9,10		4,00	40500	84	106
HPX/ATEX-90-4T-5,5	1450	15,76	9,10		4,00	44000	89	118
HPX/ATEX-90-4T-7,5	1440		12,00	6,93	5,50	51000	91	132
HPX/ATEX-100-4T-10	1448		16,30	9,41	7,50	63000	93	159
HPX/ATEX-100-4T-15	1460		23,80	13,74	11,00	68000	94	181

Características acústicas

Los valores indicados, se determinan mediante medidas de nivel de presión y potencia sonora en dB(A) obtenidas en campo libre a una distancia equivalente a dos veces la envergadura del ventilador más el diámetro de la hélice, con un mínimo de 1,5 mts.

Espectro de potencia sonora Lw(A) en dB(A) banda de frecuencia en [Hz]

Modelo	63	125	250	500	1000	2000	4000	8000	Modelo	63	125	250	500	1000	2000	4000	8000
35-2-0,75	48	63	82	81	82	81	76	67	71-4-1,5	55	75	83	88	90	87	80	69
35-4-0,33	31	46	65	64	65	64	59	50	71-4-2	56	76	84	89	91	88	81	70
45-4-0,33	40	55	74	73	74	73	68	59	71-4-3	65	76	86	92	93	88	77	73
45-4-0,50	41	56	75	74	75	74	69	60	80-4-3	60	80	88	93	95	92	85	74
50-4-0,75	44	58	77	77	78	76	72	63	80-4-4	61	81	89	94	96	93	86	75
50-4-1	45	59	78	78	79	77	73	64	80-4-5,5	68	79	89	95	96	91	80	76
56-4-0,75	47	67	75	80	82	79	72	61	90-4-5,5	67	88	95	100	103	99	92	81
56-4-1	48	68	76	81	83	80	73	62	90-4-7,5	69	90	97	102	105	101	94	83
56-4-1,5	57	68	78	84	85	80	69	65	100-4-10	73	93	100	106	108	105	98	87
63-4-1,5	51	71	79	84	86	83	76	65	100-4-15	74	94	101	107	109	106	99	88
63-4-2	62	73	83	89	90	85	74	70									

Dimensiones mm

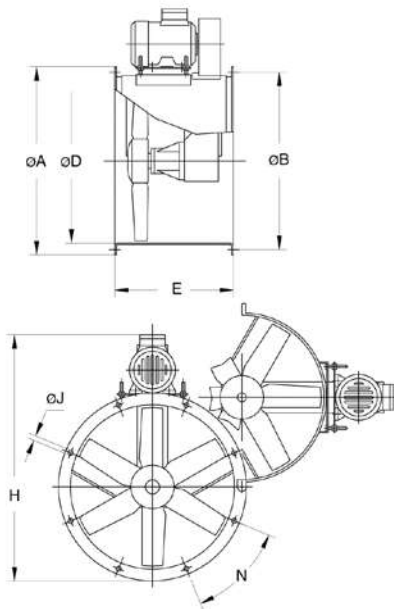

Modelo	ØA	ØB	ØD	E	H	ØJ	N
HPX-35-2T-0,75	425	395	355	380	606	10	8x45°
HPX-35-4T-0,16	425	395	355	380	609	10	8x45°
HPX-45-4T-0,33	540	500	460	420	740	12	8x45°
HPX-45-4T-0,50	540	500	460	420	728	12	8x45°
HPX-50-4T-0,75	600	560	512	420	803	12	12x30°
HPX-50-4T-1	600	560	512	420	803	12	12x30°
HPX-56-4T-0,75	660	620	560	450	848	12	12x30°
HPX-56-4T-1	660	620	560	450	848	12	12x30°
HPX-56-4T-1,5	600	620	560	450	870	12	12x30°
HPX-63-4T-1,5	730	690	640	500	950	12	12x30°
HPX-63-4T-2	730	690	640	500	950	12	12x30°
HPX-71-4T-1,5	810	770	710	550	1017	12	16x22°30'
HPX-71-4T-2	810	770	710	550	1017	12	16x22°30'
HPX-71-4T-3	810	770	710	550	1035	12	16x22°30'
HPX-80-4T-3	900	860	800	600	1173	12	16x22°30'
HPX-80-4T-4	900	860	800	600	1173	12	16x22°30'
HPX-80-4T-5,5	900	860	800	600	1200	12	16x22°30'
HPX-90-4T-5,5	1015	970	900	650	1320	15	16x22°30'
HPX-90-4T-7,5	1015	970	900	650	1320	15	16x22°30'
HPX-100-4T-10	1115	1070	1000	750	1483	15	16x22°30'
HPX-100-4T-15	1115	1070	1000	750	1513	15	16x22°30'

Curvas características

Q= Caudal en m³/h, m³/s y cfm.

Pe= Presión estática en mmH2O, Pa e inwg.

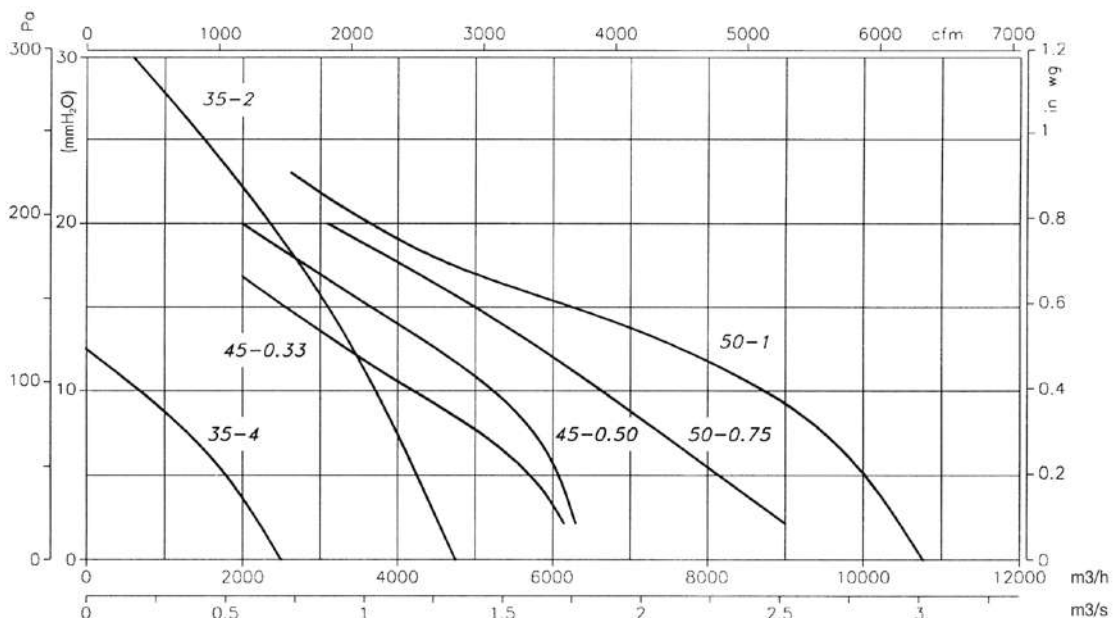

Curvas características

Q= Caudal en m³/h, m³/s y cfm.

Pe= Presión estática en mmH₂O, Pa e inwg.

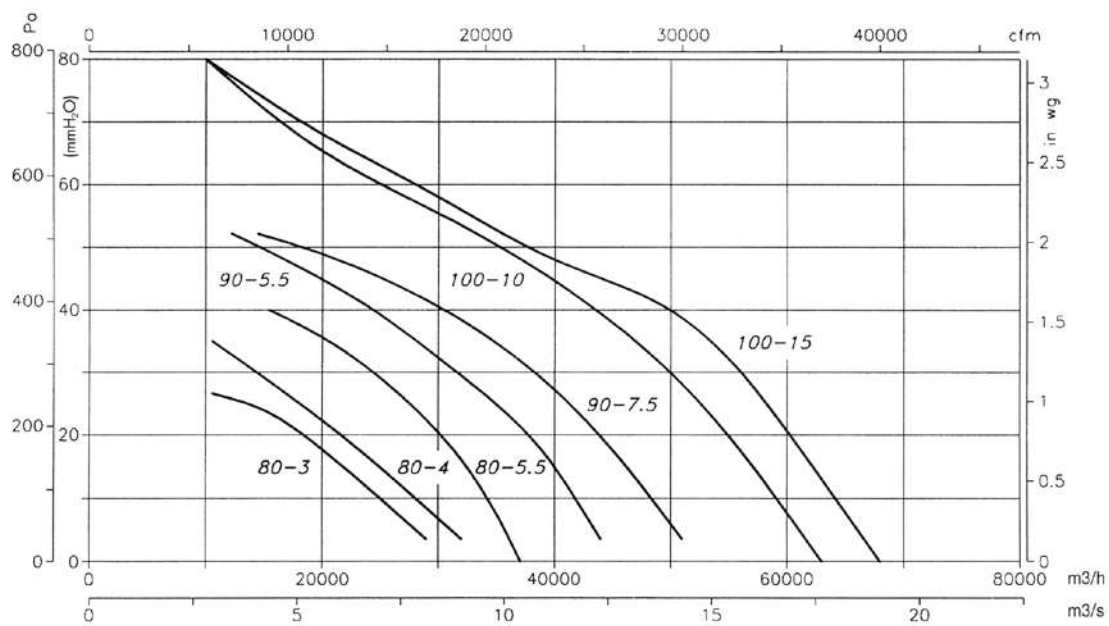
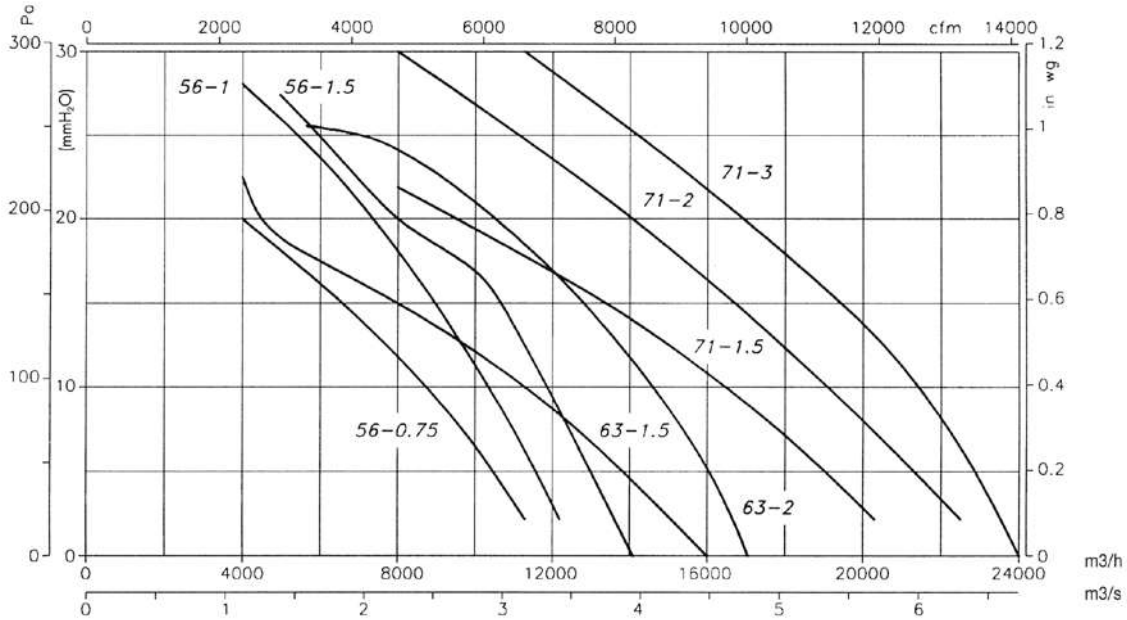

Accesorios

Ver apartado accesorios.



CPV/ATEX *Extractores centrífugos anticorrosivos en material plástico, con certificación ATEX*



Extractores centrífugos de simple aspiración fabricados en material plástico antiestático ATEX, para trabajar en atmósferas explosivas, con motor antiexplosivo CEE ExII3G Ex e o antideflagrante CEE ExII3G Ex d

Ex "e" marcado: CEE II 3G Ex e
 Ex "d" marcado: CEE II 3G Ex d

Ventilador:

- Envoltorio en material plástico antiestático ATEX
- Turbina con álabes hacia adelante, en material plástico antiestático ATEX

Motor:

- Motores clase F, con rodamientos a bolas, protección IP55, con certificación ATEX, antiexplosivos Ex"e" o antideflagrantes Ex"d"
- Trifásicos 230/400V.-50Hz.(hasta 4 kW) y 400/690V.-50Hz.(potencias superiores a 4 kW)
- Temperatura máxima del aire a transportar: -20°C.+ 80°C.

Acabado:

- Anticorrosivo en material plástico ATEX

Bajo demanda:

- Motores con PTC incorporada
- Bobinados especiales para diferentes tensiones y frecuencias
- Construcción ATEX para diferentes categorías

Código de pedido

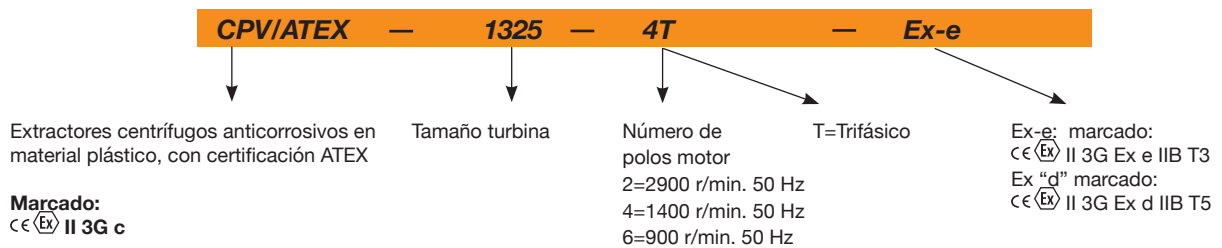

Características técnicas

Modelo	Velocidad (r/min)	Intensidad máxima admisible (A)		Potencia instalada (kW)	Caudal máximo (m³/h)	Nivel presión sonora dB(A)	Peso aprox. (Kg)
		230V	400V				
CPV/ATEX-815-2T	2770	2,08	1,20	0,37	950	75	14,0
CPV/ATEX-815-4T	1370	2,08	1,20	0,25	450	58	14,0
CPV/ATEX-1020-2T	2820	3,46	2,00	0,75	2000	81	19,5
CPV/ATEX-1020-4T	1370	2,08	1,20	0,25	1250	65	19,5
CPV/ATEX-1020-6T	910	2,42	1,40	0,25	750	53	19,5
CPV/ATEX-1325-2T	2860	8,66	5,00	2,20	3250	87	27,0
CPV/ATEX-1325-4T	1370	2,60	1,50	0,37	2300	69	27,0
CPV/ATEX-1325-6T	910	2,42	1,40	0,25	1400	59	27,0
CPV/ATEX-1630-4T	1400	6,93	4,00	1,50	4500	75	34,5
CPV/ATEX-1630-6T	930	3,46	2,00	0,55	2700	63	34,5

Características acústicas

Los valores indicados, se determinan mediante medidas de nivel de presión y potencia sonora en dB(A) obtenidas en campo libre a una distancia equivalente a dos veces la envergadura del ventilador más el diámetro de la turbina, con un mínimo de 1,5 mts.

Espectro de potencia sonora Lw(A) en dB(A) por banda de frecuencia en Hz

Modelo	63	125	250	500	1000	2000	4000	8000	Modelo	63	125	250	500	1000	2000	4000	8000
815-2	56	69	77	81	81	77	73	65	1325-2	70	83	91	95	96	92	88	79
815-4	39	52	60	64	64	60	56	48	1325-4	52	65	73	77	78	74	70	61
1020-2	62	75	83	87	87	83	79	71	1325-6	42	55	63	67	68	64	60	51
1020-4	46	59	67	71	71	67	63	55	1630-4	60	73	81	85	86	82	78	69
1020-6	34	47	55	59	59	55	51	43	1630-6	48	61	69	73	74	70	66	57

Dimensiones mm

CPV-815...1630

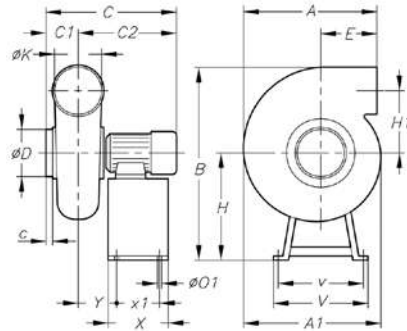

Modelo	A	A1	B	C	C1	C2	c	øD	E	H	H1	øK	øO1	V	v	X	x1	Y
CPV/ATEX-815	307	335	521	360	100	260	30	125	100	281	177,5	125	8	355	335	180	160	90
CPV/ATEX-1020-2T	340	397	593	445,5	116	329,5	32	160	100	290	223	160	8	355	335	180	160	127,5
CPV/ATEX-1020-4/6T	340	397	584	422,5	116	306,5	32	160	100	281	223	160	8	355	335	180	160	122,5
CPV/ATEX-1325-2T	413	505	735	494	130	364	35	200	103	370	265	200	8	400	380	180	160	125
CPV/ATEX-1325-4/6T	413	505	716	432,5	130	302,5	35	200	103	351	265	200	8	400	380	180	160	113,5
CPV/ATEX-1630-4T	480	602	890	536,5	145	391,5	35	250	117	440	323	250	8	450	430	240	220	142,5
CPV/ATEX-1630-6T	480	602	880	503	145	358	35	250	117	430	323	250	8	450	430	240	220	138

Curvas características

Q= Caudal en m³/h, m³/s y cfm.

Pe= Presión estática en mmH₂O, Pa e inwg.

2T=3000 r/min.

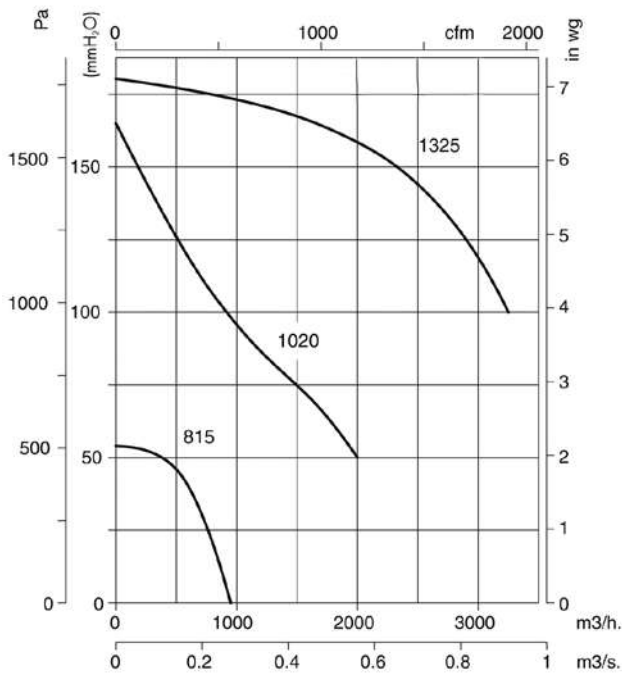

4T=1500 r/min.

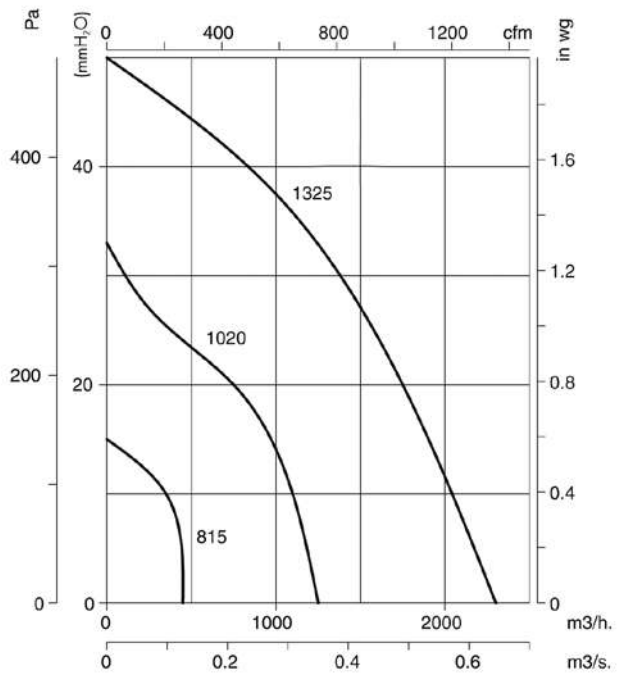

Curvas características

Q= Caudal en m³/h, m³/s y cfm.

Pe= Presión estática en mmH₂O, Pa e inwg.

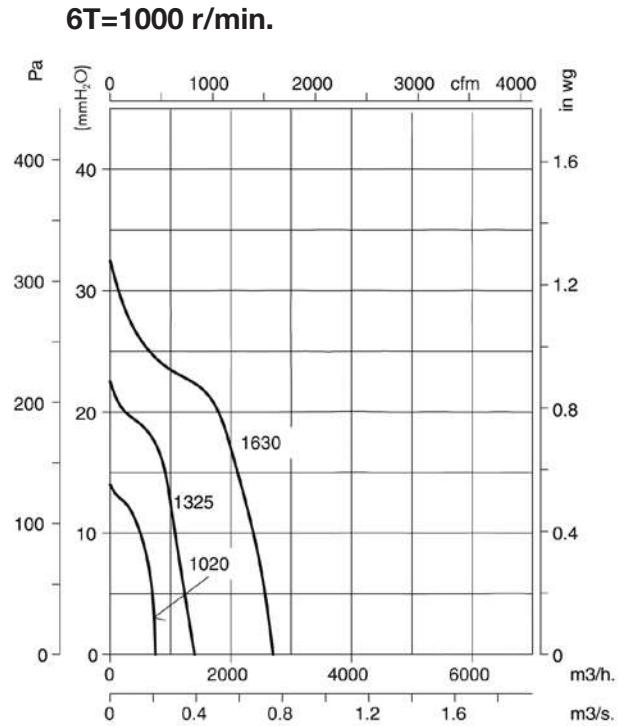
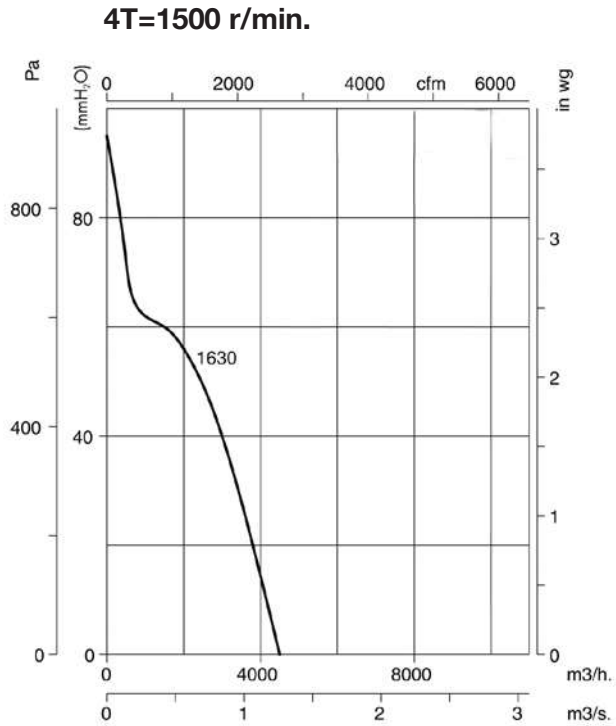

Orientaciones

Suministro standard LG 90



Accesorios

Ver apartado accesorios.



CMR/ATEX *Extractores centrífugos de media presión y gran robustez, equipados con turbina a reacción, con certificación ATEX*



Extractores centrífugos de media presión y simple aspiración, de gran robustez, para trabajar en atmósferas explosivas.

Ventilador:

- Envoltente en chapa de acero
- Turbina con álabes a reacción, en chapa de acero de gran robustez
- Aro de aspiración antichispas en cobre o aluminio

Motor:

- Motores clase F, con rodamientos a bolas, protección IP55, con certificación ATEX, antiexplosivos Ex"e" o antideflagrantes Ex"d"
- Trifásicos 230/400V.-50Hz.(hasta 4 kW) y 400/690V.-50Hz.(potencias superiores a 4 kW)
- Temperatura máxima del aire a transportar: -20°C.+ 80°C.



Ex "e" marcado: $\text{C}\text{E}\text{C}\text{E}\text{X}$ II 2G Ex e
 Ex "d" marcado: $\text{C}\text{E}\text{C}\text{E}\text{X}$ II 2G Ex d
 Ex tc marcado: $\text{C}\text{E}\text{C}\text{E}\text{X}$ II 3D Ex tc
 Ex tb marcado: $\text{C}\text{E}\text{C}\text{E}\text{X}$ II 2D Ex tb
 Organismo notificado: L.O.M.
 N° de identificación:
 LOM3ATEX147

Acabado:

- Anticorrosivo con pintura ATEX, libre de componentes férricos, en resina de poliéster polimerizada a 190 °C, previo desengrase con tratamiento nanotecnológico libre de fosfatos

Bajo demanda:

- Motores con PTC incorporada
- Bobinados especiales para diferentes tensiones y frecuencias
- Construcción ATEX para diferentes categorías
- Construcción en acero inoxidable

Código de pedido

CMR/ATEX — 1650 — 2T — 5,5 — Ex tb

Extractores centrífugos de media presión y gran robustez, equipados con turbina a reacción, con certificación ATEX

Marcado:

$\text{C}\text{E}\text{C}\text{E}\text{X}$ II 2G c
 $\text{C}\text{E}\text{C}\text{E}\text{X}$ II 2D c
 $\text{C}\text{E}\text{C}\text{E}\text{X}$ II 3D c

Tamaño turbina

Número de polos motor

2=2900 r/min. 50 Hz
 4=1400 r/min. 50 Hz
 6=900 r/min. 50 Hz

T=Trifásico

Potencia motor (c.v)

Ex-e marcado: $\text{C}\text{E}\text{C}\text{E}\text{X}$ II 2G Ex e IIB T3
 Ex "d" marcado: $\text{C}\text{E}\text{C}\text{E}\text{X}$ II 2G Ex d IIB T5
 Ex tc marcado: $\text{C}\text{E}\text{C}\text{E}\text{X}$ II 3D Ex tc
 Ex tb marcado: $\text{C}\text{E}\text{C}\text{E}\text{X}$ II 2D Ex tb

Características técnicas

Modelo	Velocidad (r/min)	Intensidad máxima (A)			Potencia instalada (kW)	Caudal máximo (m³/h)	Nivel presión sonora dB(A)	Peso aprox. con motor (Kg)	
		230V	400V	690V				Ex-e	Ex-d
CMR-1240-4T/ATEX	1410	3,81	2,20		0,75	5800	71	70	84
CMR-1445-2T/ATEX	2880		15,70	9,06	7,50	16500	87	141	163
CMR-1445-4T/ATEX	1410	5,20	3,00		1,10	8030	72	93	112
CMR-1650-2T/ATEX	2930		22,00	12,70	11,00	18850	89	178	258
CMR-1650-4T/ATEX	1400	6,93	4,00		1,50	10500	74	114	134
CMR-1650-6T/ATEX	930	4,16	2,40		0,75	7410	64	111	130
CMR-1856-4T/ATEX	1440	12,30	7,10		3,00	15150	79	152	175
CMR-1856-6T/ATEX	910	5,89	3,40		1,10	10050	70	145	166
CMR-2063-4T/ATEX	1440		12,00	6,93	5,50	24450	80	225	264
CMR-2063-6T/ATEX	940	7,62	4,40		1,50	16100	71	209	233
CMR-2271-4T/ATEX	1460		23,80	13,74	11,00	34610	85	315	412
CMR-2271-6T/ATEX	945	14,72	8,50		3,00	22750	76	280	320
CMR-2380-4T/ATEX	1465		42,00	24,00	22,00	48000	83	416	495
CMR-2380-6T/ATEX	965		16,40	9,47	7,50	30000	75	363	441

Características acústicas

Los valores indicados, se determinan mediante medidas de nivel de presión y potencia sonora en dB(A) obtenidas en campo libre a una distancia equivalente a dos veces la envergadura del ventilador más el diámetro de la turbina, con un mínimo de 1,5 mts.

Espectro de potencia sonora Lw(A) en dB(A) banda de frecuencia en [Hz]

Modelo	Lp dB (A)	63	125	250	500	1000	2000	4000	8000	Modelo	Lp dB (A)	63	125	250	500	1000	2000	4000	8000
CMR-1240-4T/ATEX	71	56	70	76	79	79	80	70	59	CMR-1856-6T/ATEX	70	61	69	81	83	80	81	71	60
CMR-1445-2T/ATEX	87	73	85	83	95	93	97	99	89	CMR-2063-4T/ATEX	80	80	85	91	93	91	88	81	73
CMR-1445-4T/ATEX	72	59	72	78	83	80	83	78	64	CMR-2063-6T/ATEX	71	69	70	82	82	81	83	73	63
CMR-1650-2T/ATEX	89	73	81	85	99	97	99	99	88	CMR-2271-4T/ATEX	85	83	84	93	96	98	99	95	82
CMR-1650-4T/ATEX	74	64	74	82	84	83	85	76	66	CMR-2271-6T/ATEX	76	73	73	87	86	90	90	79	68
CMR-1650-6T/ATEX	64	53	65	72	77	73	69	62	54	CMR-2380-4T/ATEX	83	76	78	94	91	96	97	93	82
CMR-1856-4T/ATEX	79	69	78	91	87	90	91	85	71	CMR-2380-6T/ATEX	75	68	70	86	83	88	89	85	74

Dimensiones mm

CMR-1240...2271

Boca de aspiración

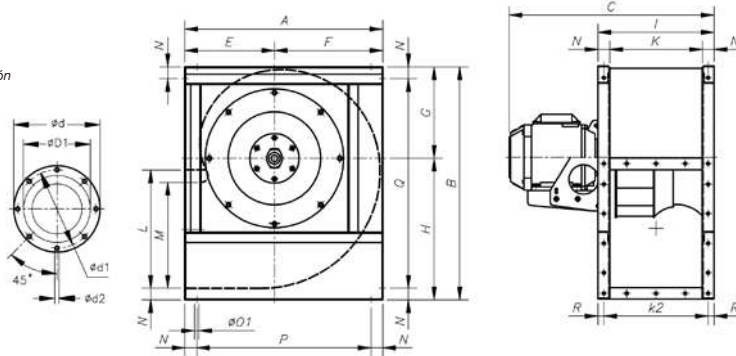

Ex-"e" Ex-"d"

Modelo	A	B	C	C	ØD1*	Ød	Ød1	Ød2	E	F	G	H	I	K	k2	L	M	N	Ø01	P	Q	R
CMR-1240-4T/ATEX	673	790	596	638	400	472	444	M.10	305	368	310	480	395	315	355	400	358	40	11	593	710	20
CMR-1445-2T/ATEX	765	880	774	857	450	522	494	M.10	350	415	339	541	445	355	403	450	404	45	11	675	790	21
CMR-1445-4T/ATEX	765	880	679	687	450	522	494	M.10	350	415	339	541	445	355	403	450	404	45	11	675	790	21
CMR-1650-2T/ATEX	832	970	945,5	1018	500	582	555	M.10	375	457	378	592	490	400	450	500	445	45	13	742	880	20
CMR-1650-4T/ATEX	832	970	724,5	724,5	500	582	555	M.10	375	457	378	592	490	400	450	500	445	45	13	742	880	20
CMR-1650-6T/ATEX	832	970	724,5	724,5	500	582	555	M.10	375	457	378	592	490	400	450	500	445	45	13	742	880	20
CMR-1856-4T/ATEX	925	1084	798	889	560	645	615	M.10	415	510	426	658	550	450	500	560	493	50	13	825	984	25
CMR-1856-6T/ATEX	925	1084	780,5	809	560	645	615	M.10	415	510	426	658	550	450	500	560	493	50	13	825	984	25
CMR-2063-4T/ATEX	1037	1218	937	1020	630	720	688	M.10	465	572	477	741	620	500	560	630	530	60	13	917	1098	30
CMR-2063-6T/ATEX	1037	1218	839	930	630	720	688	M.10	465	572	477	741	620	500	560	630	530	60	13	917	1098	30
CMR-2271-4T/ATEX	1173	1375	1129	1201	710	800	768	M.12	525	648	538	837	690	560	625	710	603	65	13	1043	1245	32,5
CMR-2271-6T/ATEX	1173	1375	973	1056	710	800	768	M.12	525	648	538	837	690	560	625	710	603	65	13	1043	1245	32,5

*Diámetro nominal tubería recomendada

CMR-1240...2380

CMR-1031
CMR-1135
CMR-2590
CMR-28100

CMR-622
CMR-625
CMR-728
CMR-731

CMR-1240
CMR-1445
CMR-1650

CMR-1856

CMR-2063

CMR-2271

CMR-2380

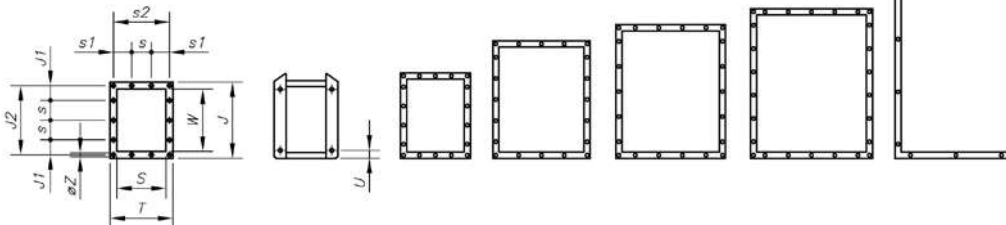

Modelo	T	J	J1	J2	S	s	s1	s2	W	Øz	U
CMR-1240/ATEX	395	480	70	440	315	100	77,5	355	400	11	-
CMR-1445/ATEX	445	540	99	498	355	100	102,5	403	450	11	-
CMR-1650/ATEX	490	590	88	550	400	125	100	450	500	11	-
CMR-1856/ATEX	550	660	55	610	450	125	125	500	560	13	-
CMR-2063/ATEX	620	750	95	690	500	125	92,5	560	630	13	-
CMR-2271/ATEX	690	840	75	775	560	125	62,5	625	710	13	-
CMR-2380/ATEX	689	921	135,5	871	569	200	119,5	639	801	14	-

CMR-2380

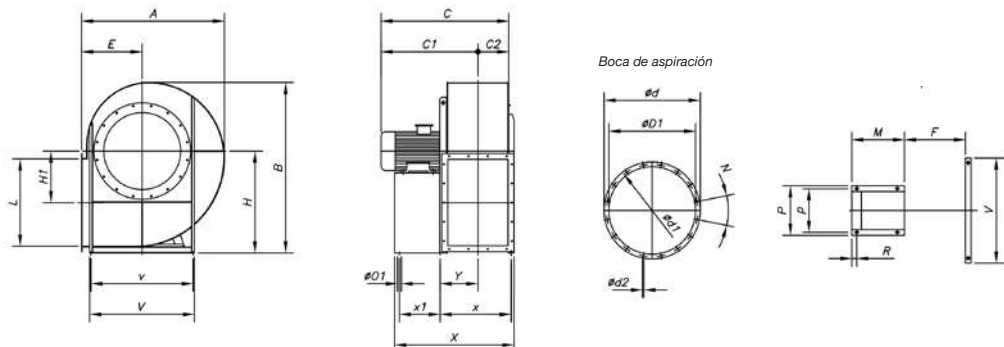

EEEx-"e" EEEx-"d"

Modelo	A	B	C	C1	C	C1	C2	ØD1*	Ød	Ød1	Ød2	E	H	H1	L	F	M	R	N	Ø01	P	p	V	v	X	x	x1	Y
CMR-2380-4T/ATEX	1312	1591	1260	973	1124	837	287	805	905	861	15	560	950	478	801	572	463	27	16x22°30'	20	926	872	932	862	1095	668	409	314
CMR-2380-6T/ATEX	1312	1591	1105	818	1152	865	287	805	905	861	15	590	950	478	801	572	418	27	16x22°30'	20	926	872	932	862	1050	668	364	314

*Diámetro nominal tubería recomendada

Curvas Características

Q= Caudal en m³/h, m³/s y cfm.

Pe= Presión estática en mmH₂O, Pa e in wg.

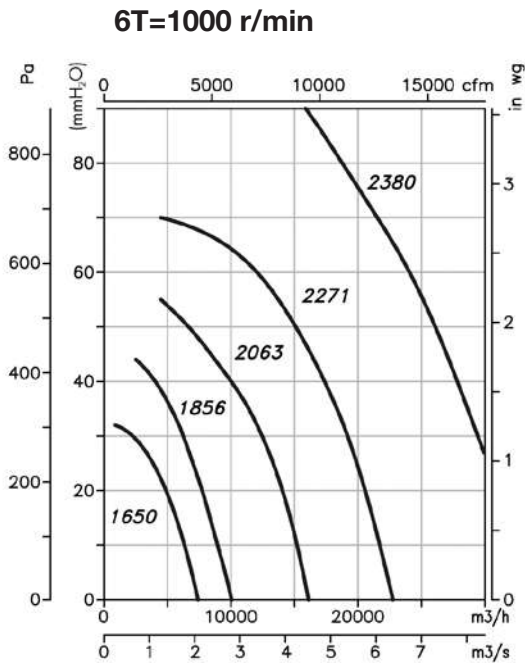
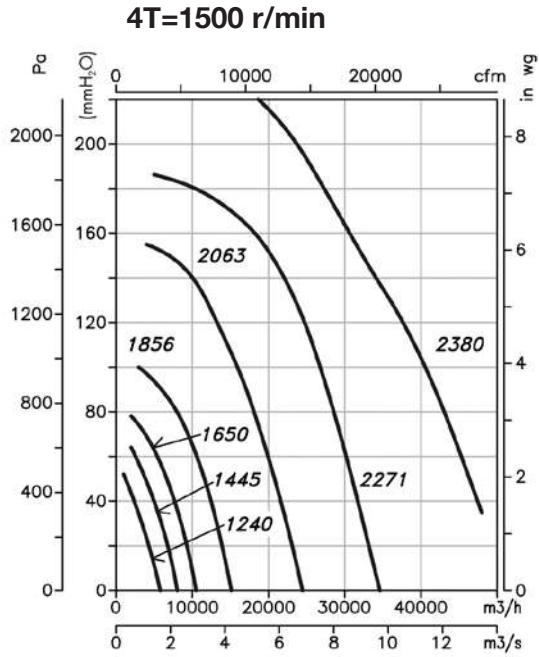
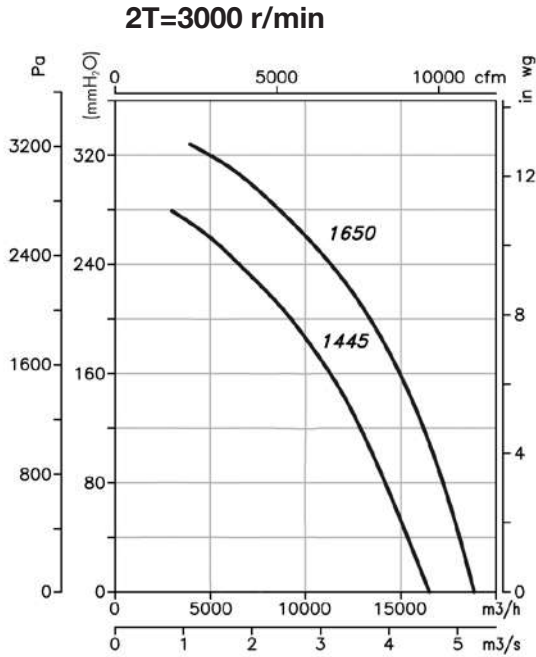

Orientaciones

Suministro standard LG 270



Accesorios

Ver apartado accesorios.



CAS/ATEX

Extractores centrífugos de alta presión y simple aspiración, con certificación ATEX



Extractores centrífugos de alta presión y Certificación ATEX con motor antiexplosivo CEE ExII2G Ex e, antideflagrante CEE ExII2G Ex d, Ex tc, o Ex tb para trabajar en atmósferas explosivas.

Ventilador:

- Envoltorio en chapa de acero
- Turbina con álabes hacia atrás, en chapa de acero galvanizado, excepto modelos 242-248-254-260-640-645-650 con turbina en fundición de aluminio.
- Aro de aspiración antichispas en cobre o aluminio

Motor:

- Motores clase F, con rodamientos a bolas con certificación ATEX, antiexplosivos Ex e, antideflagrante Ex d, Ex tc, o Ex tb
- Trifásicos 230/400V.-50Hz.(hasta 4 kW) y 400/690V.-50Hz.(potencias superiores a 4 kW)
- Temperatura máxima del aire a transportar: -20°C.+ 80°C.



Ex "e" marcado: CEE (Ex) II 2G Ex e
 Ex "d" marcado: CEE (Ex) II 2G Ex d
 Ex tc marcado: CEE (Ex) II 3D Ex tc
 Ex tb marcado: CEE (Ex) II 2D Ex tb
Organismo notificado: L.O.M.
Nº de identificación: LOM4ATEX007

Acabado:

- Anticorrosivo con pintura ATEX, libre de componentes férricos, en resina de poliéster polimerizada a 190 °C, previo desengrase con tratamiento nanotecnológico libre de fosfatos

Bajo demanda:

- Motores con PTC incorporada
- Bobinados especiales para diferentes tensiones y frecuencias
- Construcción ATEX para diferentes categorías
- Extractores con motor de 2 velocidades

Código de pedido

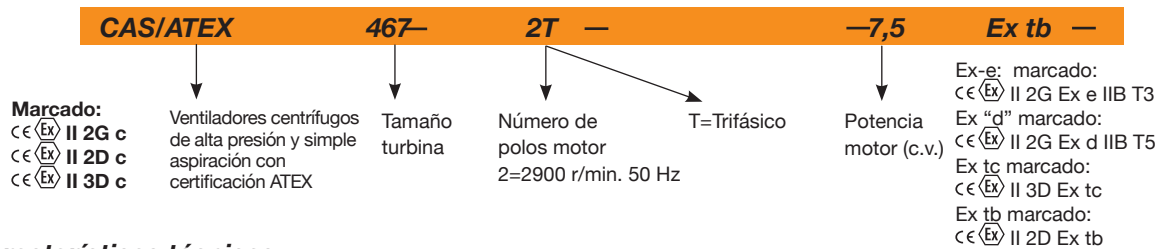

Características técnicas

Modelo	Velocidad (r/min)	Intensidad máxima admisible (A)			Potencia instalada (kW)	Caudal máximo (m³/h)	Nivel presión sonora dB(A)	Peso aprox. (Kg)
		230V	400V	690V				
CAS/ATEX-242-2T-0,33	2740	1,73	1,00		0,25	450	73	30,0
CAS/ATEX-242-2T-0,5	2770	2,08	1,20		0,37	650	73	31,0
CAS/ATEX-248-2T-0,75	2710	2,94	1,70		0,55	420	74	43,5
CAS/ATEX-248-2T-1	2820	3,46	2,00		0,75	500	75	45,0
CAS/ATEX-248-2T-1,5	2850	4,50	2,60		1,10	990	76	46,5
CAS/ATEX-254-2T-1,5	2850	4,50	2,60		1,10	600	76	56,5
CAS/ATEX-254-2T-2	2800	6,24	3,60		1,50	800	78	61,5
CAS/ATEX-254-2T-3	2860	8,66	5,00		2,20	1300	80	63,0
CAS/ATEX-260-2T-2	2800	6,24	3,60		1,50	500	77	75,0
CAS/ATEX-260-2T-3	2860	8,66	5,00		2,20	900	79	78,0
CAS/ATEX-463-2T-5,5	2910	15,42	8,90		4,00	1150	82	88,5
CAS/ATEX-463-2T-7,5	2880		10,50	6,09	5,50	2000	83	95,5
CAS/ATEX-467-2T-7,5	2880		10,50	6,09	5,50	1550	84	117,5
CAS/ATEX-467-2T-10	2880		15,70	9,06	7,50	2600	85	122,5
CAS/ATEX-571-2T-10	2880		15,70	9,06	7,50	2000	86	144,0
CAS/ATEX-571-2T-15	2930		22,00	12,70	11,00	3450	87	175,0
CAS/ATEX-640-2T-2	2800	6,24	3,60		1,50	2600	77	51,5
CAS/ATEX-645-2T-3	2860	8,66	5,00		2,20	2000	76	62,5
CAS/ATEX-645-2T-4	2845	12,12	7,00		3,00	3000	81	69,5
CAS/ATEX-650-2T-5,5	2910	15,42	8,90		4,00	3500	81	89,0
CAS/ATEX-650-2T-7,5	2880		10,50	6,09	5,50	4750	83	96,0
CAS/ATEX-852-2T-7,5	2880		10,50	6,09	5,50	3500	81	96,0
CAS/ATEX-852-2T-10	2880		15,70	9,06	7,50	5500	85	101,0
CAS/ATEX-856-2T-15	2930		22,00	12,70	11,00	7500	85	157,5
CAS/ATEX-863-2T-15	2930		22,00	12,70	11,00	4000	84	168,0
CAS/ATEX-863-2T-20	2935		27,40	15,90	15,00	7000	86	179,0
CAS/ATEX-971-2T-25	2930		32,40	18,70	18,50	5800	87	299,0
CAS/ATEX-971-2T-30	2935		38,00	22,00	22,00	8100	88	324,0
CAS/ATEX-971-2T-40	2940		50,00	29,00	30,00	12000	89	380,0
CAS/ATEX-1250-2T-15/A	2930		22,00	12,70	11,00	12000	84	220,0

Dimensiones mm

CAS/ATEX-1250...2080

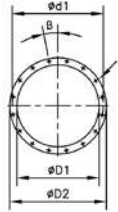

Boca de aspiración

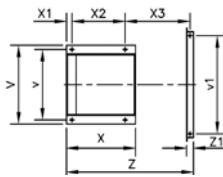
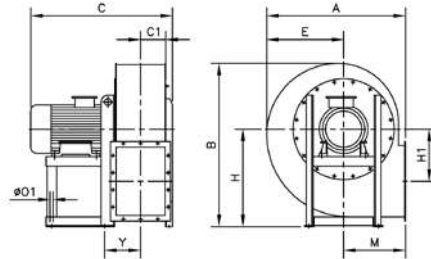

n° taladros

Boca de impulsión
CAS-1250-2T-15/A
CAS-1456-2T-25/A
CAS-1663-2T-50/A

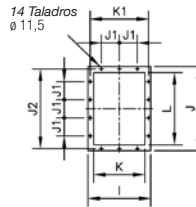

Boca de impulsión
CAS-1671-2T-60/A
CAS-2071-2T-100/A
CAS-2080-2T-125/A

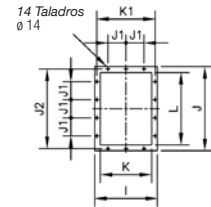

Modelo	A	B	C	C1	$\phi D1$	$\phi D2$	$\phi d1$	$x \phi$	β	E	H	H1	I	J	J1	J2	K	K1	L	M	$\phi O1$	V	v	v1	X	X1	X2	X3	Y	Z	Z1
CAS/ATEX-1250-2T-15/A	865	1055	885	160	361	441	405	8x11,5	22°30'	490	630	365	360	480	125	448	280	332	400	355	14	440	400	-	425	30	340	-	202	-	-
CAS/ATEX-1456-2T-25/A	970	1185	920	179	406	486	448	12x11,5	15°	550	710	410	395	530	125	497	315	366	450	400	14	440	400	-	425	30	340	-	219	-	-
CAS/ATEX-1663-2T-50/A	1010	1280	1035	183	568	668	629	16x11,5	11°15'	450	800	380	435	580	125	551	355	405	500	450	16	570	510	-	500	40	385	-	263	-	-
CAS/ATEX-1671-2T-60/A	1130	1340	1160	206	638	738	698	16x13	11°15'	630	800	430	500	660	160	629	400	464	560	500	19	626	565	800	550	40	425	530	292	1025	60
CAS/ATEX-2071-2T-100/A	1130	1340	1290	206	638	738	698	16x13	11°15'	630	800	430	500	660	160	629	400	464	560	500	21	760	680	800	700	50	550	545	307	1125	60
CAS/ATEX-2080-2T-125/A	1290	1505	1420	231	718	818	775	16x13	11°15'	710	900	486	550	730	160	698	450	513	630	560	19	930	870	870	700	50	550	588	333	1218	60

CAS/ATEX-790...1090

Boca de aspiración

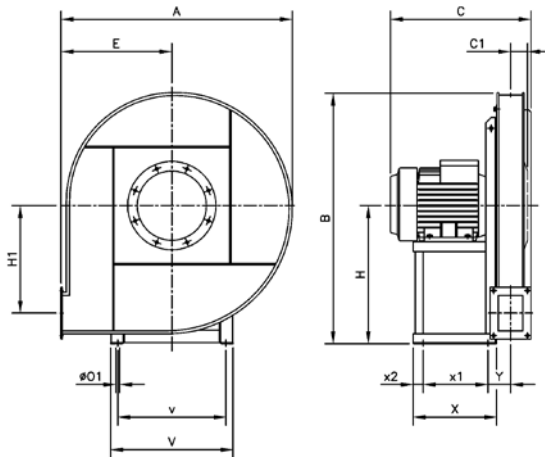
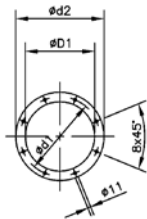

Boca de impulsión
CAS-680/790

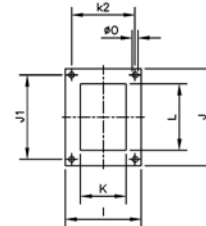

Boca de impulsión
CAS-980...1090

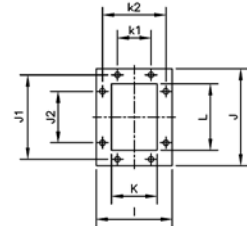

Modelo	A	B	C	C1	$\phi D1$	$\phi d1$	$\phi d2$	E	H	H1	I	J	J1	J2	K	k1	k2	L	ϕO	$\phi O1$	V	v	X	x1	x2	Y
CAS/ATEX-790-2T-20	1095	1175	680	56	185	219	255	530	630	520	140	172	140	-	80	-	112	112	9	14	440	400	425	340	30	103
CAS/ATEX-980-2T-30	1120	1250	740	90	255	292	325	530	710	530	210	270	241	112	140	112	182	200	11,5	14	500	450	470	370	35	143
CAS/ATEX-990-2T-50	1270	1410	840	100	286	332	366	600	800	600	230	294	265	112	160	112	200	224	11,5	16	570	510	500	385	40	165
CAS/ATEX-1080-2T-40	1120	1250	815	90	255	292	325	530	710	530	210	270	241	112	140	112	182	200	11,5	16	570	510	500	385	40	153
CAS/ATEX-1090-2T-60	1270	1410	920	100	286	332	366	600	800	600	230	294	265	112	160	112	200	224	11,5	19	626	565	550	425	40	175

Curvas Características

Q= Caudal en m³/h, m³/s y cfm.

Pe= Presión estática en mmH₂O, Pa e inwg.

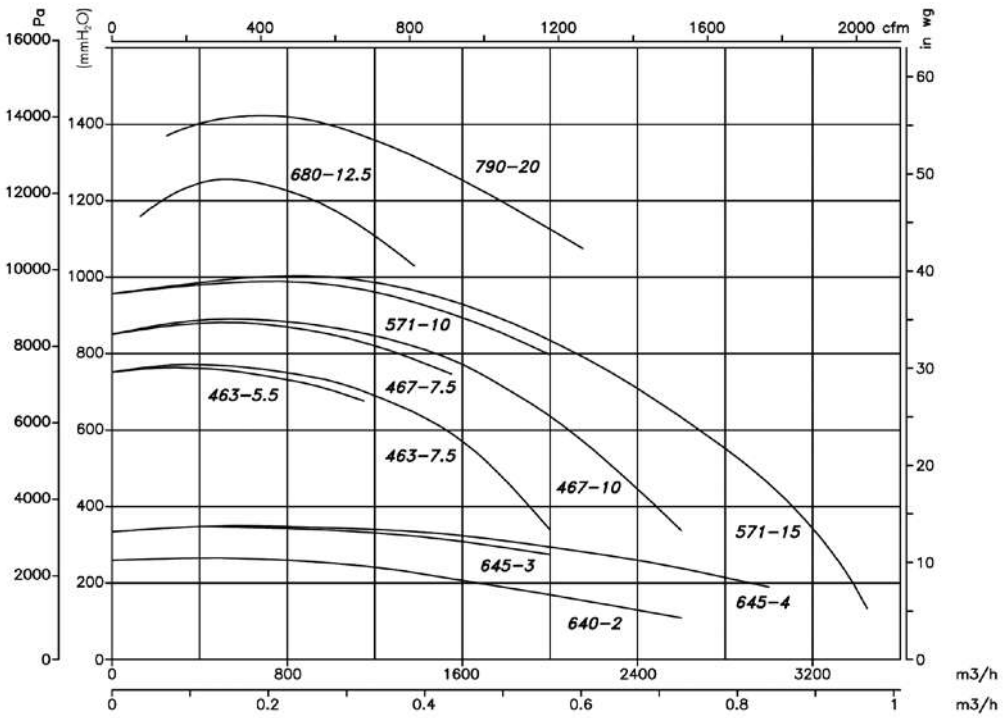
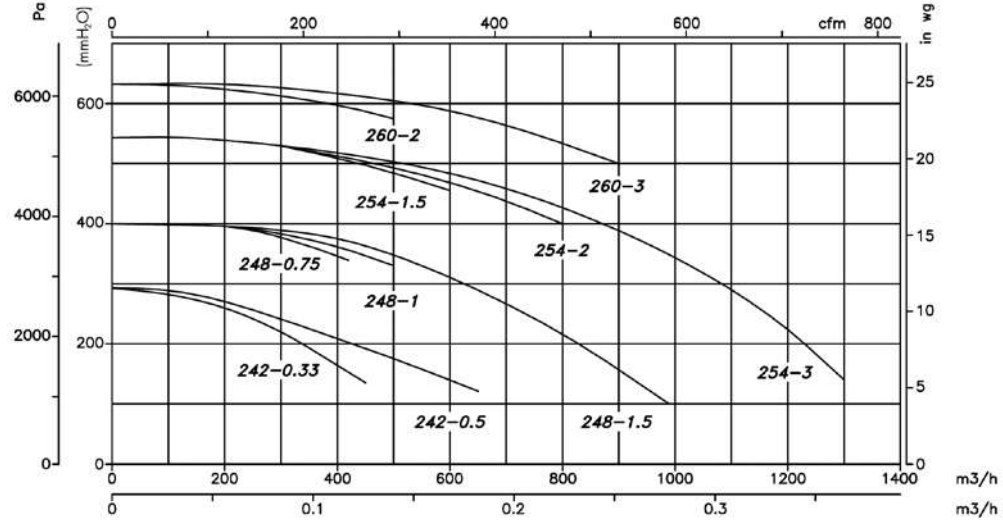

Accesorios

Ver apartado accesorios.



INT



VSD3/A-RFT
VSD1/A-RFM



CUADROS



RPA



B



BIC



ACE/ATEX



CJACUS



REG



S



INT-ATEX

Curvas Características

Q= Caudal en m³/h, m³/s y cfm.

Pe= Presión estática en mmH₂O, Pa e inwg.

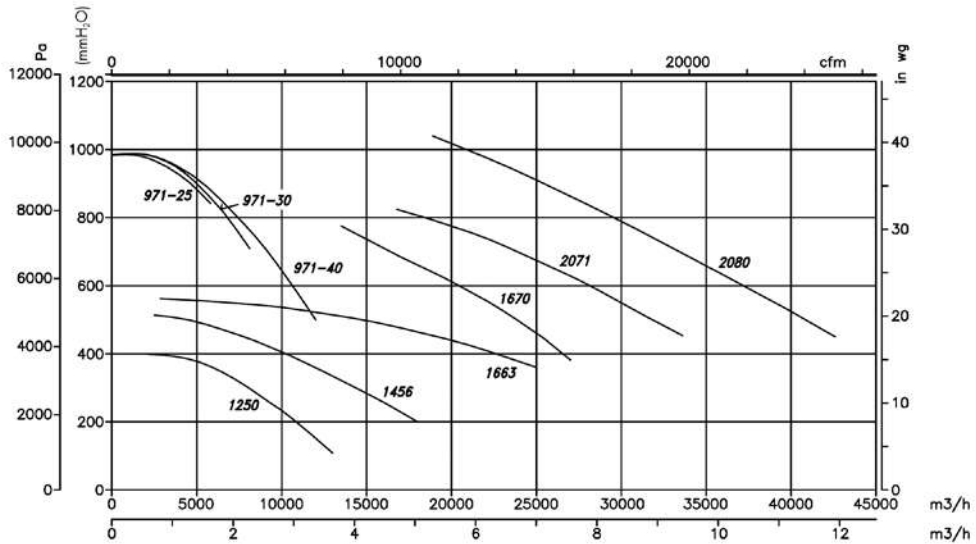
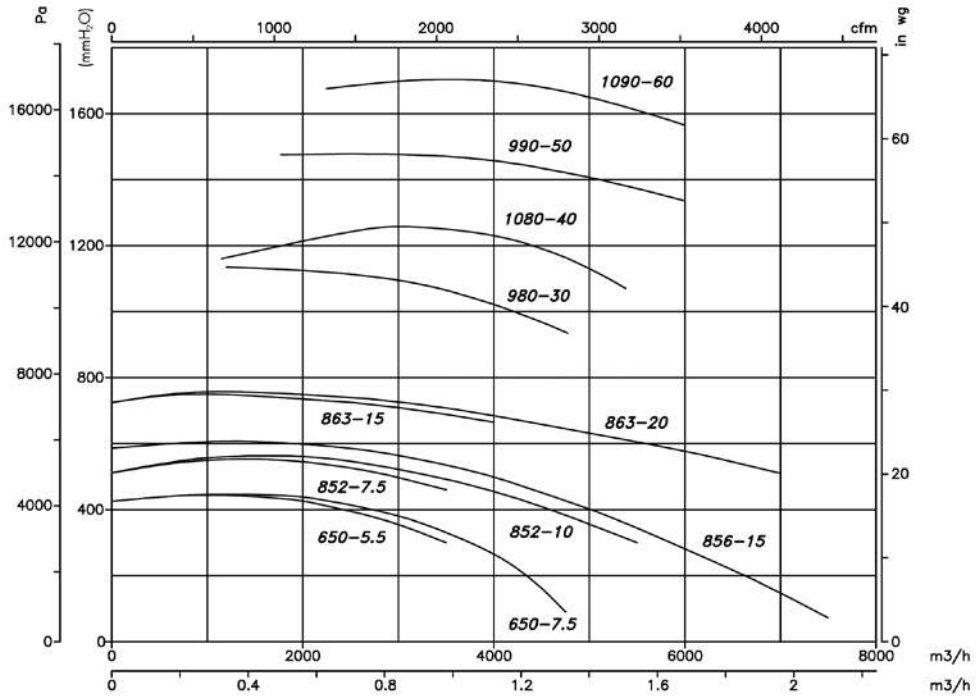

Orientaciones

Suministro standard LG 270
Posiciones LG 180 bajo demanda
y con medidas de anclaje especiales.



Suministro bajo demanda
Posiciones RD 180 con medidas
de anclaje especiales.



CA/ATEX



Construcción en aluminio para evitar chispas

Extractores centrífugos de alta presión y simple aspiración en fundición de aluminio, con certificación ATEX

Extractores centrífugos de alta presión, con envolvente y turbina en fundición de aluminio y Certificación ATEX con motor antiexplosivo CEE ExII2G Ex e, antideflagrante CEE ExII2G Ex d, Ex tc, o Ex tb, para trabajar en atmósferas explosivas.





Ventilador:

- Envolvente en fundición de aluminio
- Turbina en fundición de aluminio

Motor:

- Motores clase F, con rodamientos a bolas con certificación ATEX, antiexplosivos Ex e, antideflagrante Ex d, Ex tc, o Ex tb
- Trifásicos 230/400V.-50Hz.(hasta 4 kW) y 400/690V.-50Hz. (potencias superiores a 4 kW)
- Temperatura máxima del aire a transportar: -20°C.+ 80°C.



Ex "e" marcado: CEE  II 2G Ex e
 Ex "d" marcado: CEE  II 2G Ex d
 Ex tc marcado: CEE  II 3D Ex tc
 Ex tb marcado: CEE  II 2D Ex tb
 Organismo notificado: L.O.M.
 N° de identificación:
 LOM4ATEX007

Acabado:

- Anticorrosivo con pintura ATEX, libre de componentes férricos, en resina de poliéster polimerizada a 190 °C, previo desengrase con tratamiento nanotecnológico libre de fosfatos

Bajo demanda:

- Motores con PTC incorporada
- Bobinados especiales para diferentes tensiones y frecuencias
- Construcción ATEX para diferentes categorías
- Extractores con motor de 2 velocidades

Código de pedido

CA/ATEX — **148** — **2T** — **0,75** — **Ex d**





Ventiladores centrífugos de alta presión y simple aspiración con envolvente y turbina en fundición de aluminio con certificación ATEX

Tamaño turbina



Número de polos motor
2=2900 r/min. 50 Hz

T=Trifásico

Potencia motor (c.v.)

Ex-e marcado:
CEE  II 2G Ex e IIB T3
 Ex "d" marcado:
CEE  II 2G Ex d IIB T5
 Ex tc marcado:
CEE  II 3D Ex tc
 Ex tb marcado:
CEE  II 2D Ex tb

Markado:

CEE  II 2G c
 CEE  II 2D c
 CEE  II 3D c

Características técnicas

Modelo	Velocidad (r/min)	Intensidad máxima admisible (A)			Potencia instalada (kW)	Caudal máximo (m³/h)	Nivel presión sonora dB(A)	Peso aprox. (Kg)
		230V	400V	690V				
CA/ATEX-234-2T	2770	2,08	1,20	0,37	220	72	10,2	
CA/ATEX-142-2T-0,33	2740	1,73	1,00	0,25	275	73	22,5	
CA/ATEX-142-2T-0,5	2770	2,08	1,20	0,37	350	73	22,5	
CA/ATEX-148-2T-0,75	2710	2,94	1,70	0,55	400	74	28,0	
CA/ATEX-148-2T-1	2820	3,46	2,00	0,75	490	75	30,0	
CA/ATEX-148-2T-1,5	2850	4,50	2,60	1,10	610	76	32,0	
CA/ATEX-154-2T-1,5	2850	4,50	2,60	1,10	600	78	46,0	
CA/ATEX-154-2T-2	2800	6,24	3,60	1,50	800	79	48,5	
CA/ATEX-154-2T-3	2860	8,66	5,00	2,20	1280	80	50,5	
CA/ATEX-160-2T-2	2800	6,24	3,60	1,50	500	83	57,0	
CA/ATEX-160-2T-3	2860	8,66	5,00	2,20	900	84	58,0	
CA/ATEX-166-2T-3	2860	8,66	5,00	2,20	500	84	67,0	
CA/ATEX-166-2T-4	2845	12,12	7,00	3,00	950	85	73,0	
CA/ATEX-166-2T-5,5	2910	15,42	8,90	4,00	1600	86	76,0	
CA/ATEX-172-2T-5,5	2910	15,42	8,90	4,00	1100	87	90,0	
CA/ATEX-172-2T-7,5	2880		10,50	6,09	5,50	1710	88	112,0
CA/ATEX-172-2T-10	2880		15,70	9,06	7,50	2300	89	124,0

Características acústicas

Los valores indicados, se determinan mediante medidas de nivel de presión y potencia sonora en dB(A) obtenidas en campo libre a una distancia equivalente a dos veces la envergadura del ventilador más el diámetro de la turbina, con un mínimo de 1,5 mts.

Espectro de potencia sonora Lw(A) en dB(A) por banda de frecuencia en Hz

Modelo	63	125	250	500	1000	2000	4000	8000	Modelo	63	125	250	500	1000	2000	4000	8000
234	38	51	65	72	80	79	73	64	160-2	54	67	81	88	96	94	88	80
142	39	52	66	73	81	80	74	65	160-3	55	68	82	89	97	95	89	81
148-0,75	43	56	70	77	85	83	77	69	166-3	55	68	82	89	97	95	89	81
148-1	44	57	71	78	86	84	78	70	166-4	56	69	83	90	98	96	90	82
148-1,5	45	58	72	79	87	85	79	71	166-5,5	57	70	84	91	99	97	91	83
154-1,5	47	60	74	81	89	87	81	73	172-5,5	59	72	86	93	101	100	94	85
154-2	48	61	75	82	90	88	82	74	172-7,5	60	73	87	94	102	101	95	86
154-3	49	62	76	83	91	89	83	75	172-10	61	74	88	95	103	102	96	87

Dimensiones mm

CA/ATEX-234

Modelo	A	A1	B	C	C1	C2	øD	ød	ød1	ød2	E	H	H1	I	J	øK	k	øO	øO1	V	v	x1	Y
CA-234-2T-0,33	376	381	415	272	242,5	29,5	98	130	115	M4	175	225	187	98	63	40	72	9	9	180	120	40	94
CA-234-2M-0,33	376	381	415	272	242,5	29,5	98	130	115	M4	175	225	187	98	63	40	72	9	9	180	120	40	94

CA/ATEX-142...172

Modelo	A	A1	B	C	C1	C2	øD	ød	ød1	ød2	E	H	H1	I	J	øK	øk	øO	øO1	V	v	x1	Y
CA-142-2T-0'33	494	488	540	270	221,52	48,5	90	160	130	M8	240	301	235	120	60	90	11	12	300	270	130	51	
CA-142-2T-0'5	494	488	540	290	241,5	48,5	90	160	130	M8	240	301	235	120	60	90	11	12	300	270	130	51	
CA-148-2T-0'75	563	557,5	639	308,5	251,5	57	100	170	140	M8	270	360	269,5	150	73	110	11	12	330	290	140	60	
CA-148-2T-1	563	557,5	639	324,5	267,5	57	100	170	140	M8	270	360	269,5	150	73	110	11	12	330	290	140	60	
CA-148-2T-1'5	563	557,5	639	324,5	267,5	57	100	170	140	M8	270	360	269,5	150	73	110	11	12	330	290	140	60	
CA-154-2T-1'5	630	625	708	348	268,5	79,5	115	183	155	M10	300	395	308	160	80	120	13	12	356	320	210	62	
CA-154-2T-2	630	625	708	371	291,5	79,5	115	183	155	M10	300	395	308	160	80	120	13	12	356	320	210	62	
CA-154-2T-3	630	625	708	396	316,5	79,5	115	183	155	M10	300	395	308	160	80	120	13	12	356	320	210	62	
CA-160-2T-2	708	699	785	381	291	90	130	230	192	M10	336	440	338	160	85	120	13	12	373	322	220	62	
CA-160-2T-3	708	699	785	406	316	90	130	230	192	M10	336	440	338	160	85	120	13	12	373	322	220	62	
CA-166-2T-3	759	752	866	399	319,5	79,5	140	230	200	M10	364	490	372	160	85	120	13	12	450	400	245	70	
CA-166-2T-4	759	752	866	423	343,5	79,5	140	230	200	M10	364	490	372	160	85	120	13	12	450	400	245	70	
CA-166-2T-5'5	759	752	866	445	365,5	79,5	140	230	200	M10	364	490	372	160	85	120	13	12	450	400	265	70	
CA-172-2T-5'5	818	813	923	451	371	80	148	230	200	M10	390	516	404	175	90	140	13	12	450	400	260	78	
CA-172-2T-7'5	818	813	923	492	412	80	148	230	200	M10	390	516	404	175	90	140	13	12	450	400	300	78	
CA-172-2T-10	818	813	923	492	412	80	148	230	200	M10	390	516	404	175	90	140	13	12	450	400	300	78	

Las medidas corresponden a la versión Ex "e"

Curvas Características

Q= Caudal en m³/h, m³/s y cfm.

Pe= Presión estática en mmH₂O, Pa e in wg.

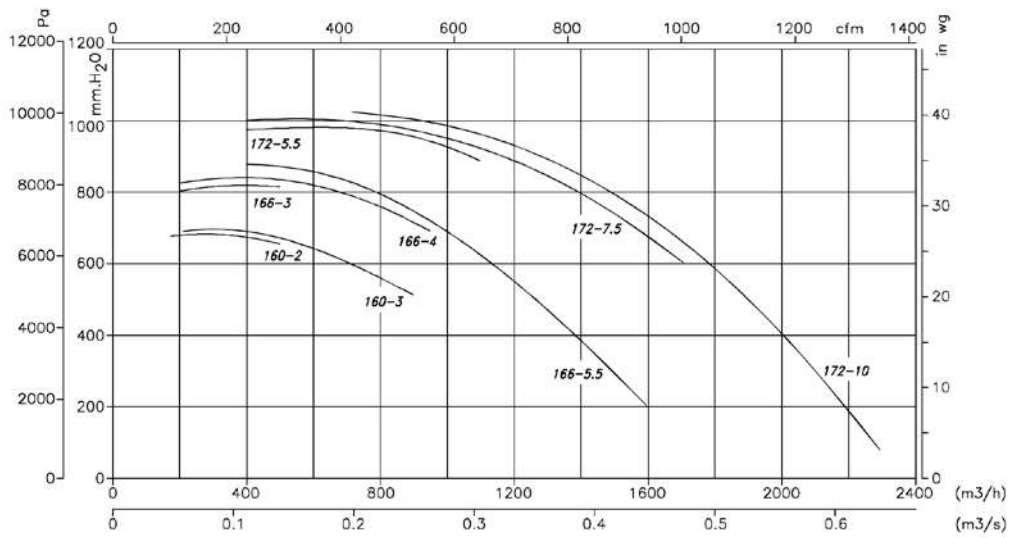
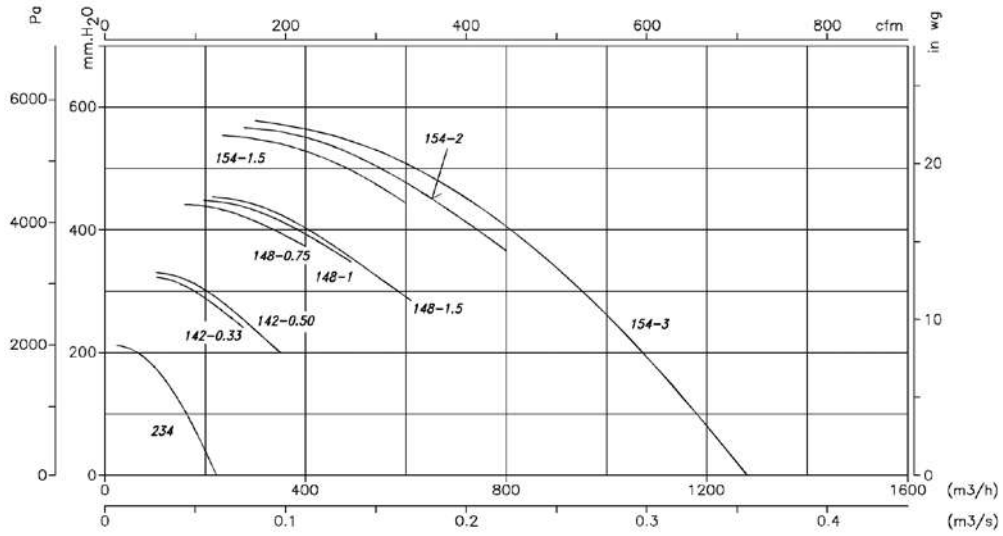

Orientaciones

Suministro standard LG 270

Posiciones LG 180 bajo demanda y con medidas de anclaje especiales.



Accesorios

Ver apartado accesorios.

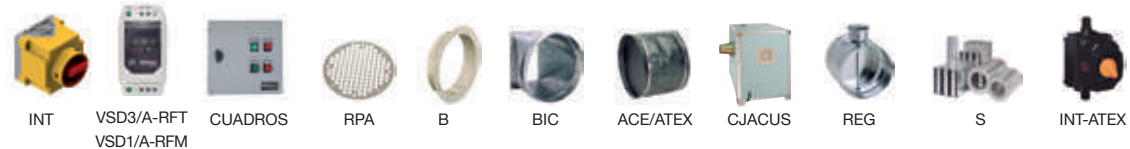

ACCESORIOS

<p>VSD3/A-RFT VSD1/A-RFM</p>  <p>Variadores electrónicos de velocidad</p> <p>192</p>	<p>INT</p>  <p>Interruptores de seguridad paro-marcha, para cumplir la Norma UNE-EN 60204-1</p> <p>193</p>	<p>Interruptor ATEX</p>  <p>Interruptor ATEX paro-marcha según directivas 94/9/EC y 2006/95/EC</p> <p>193</p>	<p>KME</p>  <p>Kit mando externo de paro, marcha y control de velocidad para los convertidores de frecuencia VSD1/A-RFM y VSD3/A-RFT</p> <p>193</p>	<p>GMP</p>  <p>Cuadro eléctrico de arranque y protección de ventiladores con motor trifásico, con pulsadores de paro y marcha</p> <p>193</p>
<p>CUADROS ELÉCTRICOS</p>  <p>Cuadros eléctricos</p> <p>194</p>	<p>PL</p>  <p>Persianas de sobrepresión</p> <p>194</p>	<p>P</p>  <p>Persianas de sobrepresión en aluminio</p> <p>194</p>	<p>R</p>  <p>Rejilla de protección para la aspiración de ventiladores helicoidales</p> <p>194</p>	<p>RI</p>  <p>Rejilla de protección para la impulsión de ventiladores helicoidales.</p> <p>195</p>
<p>RT</p>  <p>Rejilla de protección para la aspiración o impulsión de ventiladores helicoidales tubulares.</p> <p>195</p>	<p>RPA</p>  <p>Rejilla de protección para la aspiración de ventiladores centrífugos</p> <p>195</p>	<p>Drall-Regler</p>  <p>Válvulas para regulación de caudal para boca de impulsión i aspiración de accionamiento manual</p> <p>195</p>	<p>Válvula lamas contrapuestas</p>  <p>Válvulas para regulación de caudal para boca de impulsión i aspiración de accionamiento manual</p> <p>195</p>	<p>BTUB</p>  <p>Brida de acoplamiento para ventiladores helicoidales</p> <p>196</p>
<p>PV</p>  <p>Pabellón de aspiración</p> <p>196</p>	<p>B</p>  <p>Brida de acoplamiento para ventiladores centrífugos</p> <p>196</p>	<p>BD</p>  <p>Brida de acoplamiento doble y elástica para ventiladores centrífugos</p> <p>197</p>	<p>BIC</p>  <p>Brida conversión de rectangular a circular, para ventiladores centrífugos</p> <p>198</p>	<p>BAC</p>  <p>Brida de acoplamiento doble y elástica para ventiladores helicoidales</p> <p>198</p>
<p>PS</p>  <p>Conjunto de pies soporte, para ventiladores tubulares.</p> <p>198</p>	<p>MS</p>  <p>Marco soporte para facilitar el montaje en obra</p> <p>199</p>	<p>PA</p>  <p>Placa de adaptación para montaje de accesorios, en extractores de tejado</p> <p>199</p>	<p>PT</p>  <p>Obturadores de cierre automático para trabajo vertical</p> <p>199</p>	<p>OP</p>  <p>Obturadores de sobrepresión para extractores de tejado</p> <p>199</p>
<p>ACE/ATEX</p>  <p>Acoplamiento elástico para amortiguar vibraciones</p> <p>200</p>	<p>REG</p>  <p>Registro de regulación manual</p> <p>200</p>	<p>CJACUS</p>  <p>Cajas acústicas para ventiladores centrífugos</p> <p>200</p>	<p>S</p>  <p>Silenciadores para acoplar a la aspiración o impulsión</p> <p>201</p>	



VSD3/A-RFT

VSD1/A-RFM

Variadores electrónicos de velocidad para motores AC

Características:

- Convertidores para la variación de velocidad mediante tensión y frecuencia, de ventiladores helicoidales y centrífugos con motores trifásicos asíncronos
- Alimentación del convertidor:
 - Monofásico (VSD1/A-RFM): 200-240V 50/60 Hz
 - Trifásico (VSD3/A-RFT): 380-480V 50/60 Hz
- De acuerdo con la Directiva de Compatibilidad Electromagnética 2004/108/EC, la Directiva de Baja tensión 2006/95/EC y la Directiva de Seguridad de máquinas 2006/42/EC.
- De acuerdo con las normas: -EN 61800-3:2004: Accionamientos eléctricos de potencia de velocidad variable. Norma de producto relativa a CEM incluyendo métodos de ensayos específicos. -EN 61800-5-1:2003: Accionamientos eléctricos de potencia de velocidad variable. Requisitos de seguridad. Eléctricos, térmicos y energéticos. -EN 60204-1:2006: Seguridad de las máquinas. Equipo eléctrico de las máquinas. Requisitos generales. -EN 55011:2007: Límites y métodos de medida de las características relativas a las perturbaciones radioeléctricas de los aparatos industriales, científicos y médicos (ICM) que producen energía en radiofrecuencia. -EN 60529:1992: Especificaciones para los grados de protección en los recintos.
- Entrada paro/marcha para deshabilitar/habilitar el variador.
- Entrada 0-10V para el control de velocidad.
- Conexión a bus ModBus RTU disponible.
- Modelo estándar con grado de protección IP20. Disponible también en versión IP66 hasta 10 CV.

1. En general, todos los ventiladores SODECA con motor trifásico en ejecución normal, son adecuados para trabajar alimentados con convertidor de frecuencia estático (según IEC 60034-17). No obstante algunos motores requieren medidas especiales. La máxima frecuencia o velocidad de funcionamiento, nunca deberá exceder la de diseño del ventilador. Las aplicaciones con par cuadrático tales como ventiladores y bombas, cuando varía la velocidad, la potencia absorbida es directamente proporcional al cubo de la velocidad de rotación: $P_{a2} = P_{a1} (n_2 / n_1)^3$

2. El aislamiento de los motores acoplados a los ventiladores es suficiente para trabajar sin restricciones con convertidor de frecuencia hasta tensiones de < 500 V. La utilización de filtros senoidales a la salida del convertidor, contribuirán en el buen funcionamiento del motor, minimizando averías y aumentando la vida útil del mismo. Se recomienda que para motores de tamaño > 225, éstos sean solicitados con devanados especiales para funcionar con convertidor de frecuencia.

3. La longitud de los cables de salida del convertidor al ventilador, influyen especialmente en las características de la tensión en bornes del motor. La definición de "cables largos" dependerá del valor nominal y tipo de convertidor, siendo necesario consultar la documentación técnica del fabricante.

4. Para los motores Antideflagrantes Ex-d, estos deben solicitarse para ser accionados mediante convertidor de frecuencia. El fabricante del motor pedirá información de la aplicación mediante un cuestionario, para definir los parámetros de trabajo. Además dichos motores deberán llevar incorporadas sondas PTC.

5. Los motores de seguridad aumentada Ex-e, no pueden accionarse con convertidor de frecuencia (para ello sería necesario la certificación conjunta motor y convertidor).

VSD1/A-RFM

Modelo		VSD1/A-RFM-0,5	VSD1/A-RFM-1	VSD1/A-RFM-2	VSD1/A-RFM-3
Potencia (CV)		0,50	1,00	2,00	3,00
Potencia (kW)		0,37	0,75	1,50	2,20
Intensidad máxima (A)		2,3	4,3	7,0	10,5
Entrada					
Tipo entrada		Monofásica	Monofásica	Monofásica	Monofásica
Tensión (V)		200-240 V	200-240 V	200-240 V	200-240 V
Frecuencia (Hz)		50-60 Hz	50-60 Hz	50-60 Hz	50-60 Hz
Salida					
Tipo Salida		Trifásica	Trifásica	Trifásica	Trifásica
Tensión (V)		200-240 V	200-240 V	200-240 V	200-240 V
Frecuencia (Hz)		0-500 Hz	0-500 Hz	0-500 Hz	0-500 Hz
Grados de protección		Estándar: IP20. Bajo pedido: IP66.			
Refrigeración		IP20: Forzada. IP66: Natural			

VSD3/A-RFT

Modelo	VSD3/A-RFT-1	VSD3/A-RFT-2	VSD3/A-RFT-3	VSD3/A-RFT-5.5	VSD3/A-RFT-7.5	VSD3/A-RFT-10	VSD3/A-RFT-15	VSD3/A-RFT-20	VSD3/A-RFT-25	VSD3/A-RFT-30
Potencia (CV)	1,00	2,00	3,00	5,50	7,50	10,00	15,00	20,00	25,00	30,00
Potencia (kW)	0,75	1,50	2,20	4,00	5,50	7,50	11,00	15,00	18,50	22,00
Intensidad máxima(A)	2,2	4,1	5,8	9,5	14,0	18,0	24,0	30,0	39,0	46,0
Entrada										
Tipo entrada	Trifásica	Trifásica	Trifásica	Trifásica	Trifásica	Trifásica	Trifásica	Trifásica	Trifásica	Trifásica
Tensión (V)	380-480 V	380-480 V	380-480 V	380-480 V	380-480 V	380-480 V	380-480 V	380-480 V	380-480 V	380-480 V
Frecuencia (Hz)	50-60 Hz	50-60 Hz	50-60 Hz	50-60 Hz	50-60 Hz	50-60 Hz	50-60 Hz	50-60 Hz	50-60 Hz	50-60 Hz
Salida										
Tipo Salida	Trifásica	Trifásica	Trifásica	Trifásica	Trifásica	Trifásica	Trifásica	Trifásica	Trifásica	Trifásica
Tensión (V)	380-480 V	380-480 V	380-480 V	380-480 V	380-480 V	380-480 V	380-480 V	380-480 V	380-480 V	380-480 V
Frecuencia (Hz)	0-500 Hz	0-500 Hz	0-500 Hz	0-500 Hz	0-500 Hz	0-500 Hz	0-500 Hz	0-500 Hz	0-500 Hz	0-500 Hz
Grados de protección	Estándar: IP20. Bajo pedido: IP66						IP20	IP20	IP20	IP20
Refrigeración	IP20 e IP55: Forzada. IP66: Natural									



INT

Interruptores de seguridad paro-marcha para cumplir la Norma UNE-EN 60204-1

Características:

- Interruptores para instalar al lado del ventilador y de esta forma poder cortar la corriente antes de manipular el ventilador
- Protección IP65
- Ventiladores trifásicos o de 2 velocidades, utilizar interruptor de 6 polos
- Ventiladores monofásicos, utilizar interruptor de 3 polos

Modelo	Intensidad (A)	Intensidad (kW)	Entrada cables (mm)	Modelo	Intensidad (A)	Intensidad (kW)	Entrada cables (mm)
INT-KG 20/3CA	25	7,5	29	INT-KG 20/6CA	25	7,5	29
INT-KG 41/3CA	40	15	37,5	INT-KG 41/6CA	40	15	37,5
INT-KG 64/3CA	63	22	37,5	INT-KG 64/6CA	63	22	37,5
INT-KG 80/3CA	80	30	37,5	INT-KG 80/6CA	80	30	37,5
INT-KG 100/3CA	100	37	37,5	INT-KG 100/6CA	100	37	37,5



Interruptor ATEX

Interruptor ATEX paro-marcha según directivas 2014/34/UE y 2014/35/UE

Características:

- II 3G Ex nR IIC T6 Gc
- II 2D Ex tb IIIC T XX °C Db IP66
- Protección IP66
- Construidos en termoplástico antiestático
- Interruptores de 3 polos para motores trifásicos a una tensión de línea máxima de 500 V.

Modelo	Intensidad máx zona 21-22 (Polvo) (A)	Intensidad máx zona 2 (Gas) (A)	Tensión máxima (V)	Potencia máxima motor 400V (kW)	Ø Entrada cable (mm)
INT/ATEX 16/3CA	16	10	500	5,5	10÷14
INT/ATEX 25/3CA	25	20	500	7,5	12÷18
INT/ATEX 40/3CA	40	32	500	15,0	12÷18
INT/ATEX 63/3CA	63	50	500	22,0	16÷25



KME - 10K

Kit mando externo de paro, marcha y control de velocidad para los convertidores de frecuencia VSD1/A-RFM y VSD3/A-RFT

Características:

- Paro y marcha mediante pulsación del mando
- Visualización mediante LED de la posición de paro o marcha
- Memoria de la última posición de regulación de velocidad
- Posibilidad de montaje en superficie o empotrado



GMP

Cuadro eléctrico de arranque y protección de ventiladores con motor trifásico, con pulsadores de paro y marcha

Características:

- Paro y marcha mediante pulsador
- Incorpora contactor y relé térmico regulable totalmente cableados, para protección del motor
- El pulsador de paro, se utiliza como rearme del relé térmico, en caso de disparo por sobrecarga
- Para montaje en superficie, protección IP-55

Para ventilador con motor trifásico 230V

Modelo	Intensidad de regulación (A)	Potencia motor 3x230V (kW)
GMP-0,2-0,33/230	1,2-1,8	0,25
GMP-02-0,75/230	1,8-2,8	0,37 / 0,55
GMP-02-1/230	2,8-4	0,75
GMP-02-1,5/230	4-6,3	1,10
GMP-02-2/230	5,6-8	1,50
GMP-04-3/230	7-10	2,20
GMP-04-4/230	8-12,5	3,00
GMP-04-5,5/230	11-17	4,00
GMP-04-7,5/230	15-23	5,50
GMP-04-10/230	22-32	7,50
GMP-06-12,5/230	25-40	9,20
GMP-06-15/230	25-40	11,00

Para ventilador con motor trifásico 400V

Modelo	Intensidad de regulación (A)	Potencia motor 3x400V (kW)
GMP-0,2-0,33/400	0,56-0,8	0,25
GMP-02-0,5/400	0,8-1,2	0,37
GMP-02-0,75/400	1,2-1,8	0,55
GMP-02-1,5/400	1,8-2,8	1,10
GMP-02-2/400	2,8-4	1,50
GMP-02-3/400	4-3	2,20
GMP-02-4/400	5,6-8	3,00
GMP-04-5,5/400	7-10	4,00
GMP-04-7,5/400	8-12,5	5,50
GMP-04-10/400	11-17	7,50
GMP-06-12,5/400	15-23	9,20
GMP-06-15/400	15-23	11,00
GMP-06-20/400	22-32	15,00
GMP-06-25/400	25-40	18,50



AET

Cuadro eléctrico de arranque estrella / triángulo y protección de ventiladores trifásicos, con pulsadores de paro y marcha

Características:

- Paro y marcha mediante pulsador
- Visualización de estado mediante pilotos luminosos
- Incorpora relé térmico regulable para protección

del motor

- Totalmente cableado
- Caja metálica para montaje en superficie, protección IP-65

Para ventilador con motor trifásico 400V/690V
Alimentación 3x400V+N

Modelo	Intensidad regulación relé térmico (A)	Potencia motor 3x400/690V (kW)
AET-01-5,5/400	4-6,3	4,0
AET-01-7,5/400	5-8	5,5
AET-01-10/400	7-10	7,5
AET-01-15/400	12-18	11,0
AET-01-20/400	12-18	15,0
AET-02-30/400	18-26	18,5 22,0
AET-02-40/400	28-40	30,0
AET-02-50/400	34-50	37,0
AET-02-60/400	45-65	45,0
AET-02-75/400	45-65	55,0



PL

Persianas de sobrepresión en material plástico

Características:

- La persiana de sobrepresión se adapta directamente sobre la pared en que se instala el ventilador
- Apertura mediante sobrepresión por el flujo de aire
- Se cierran cuando el ventilador está en reposo
- Construcción en material plástico
- Velocidad máxima recomendable de 12m/seg. para los modelos 80,90 y 100

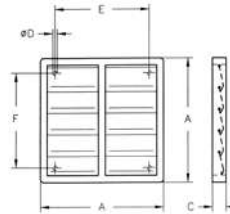

Modelo	Dimensiones				
	A	C	ØD	E	F
PL-20	240	28	5,2	193	167
PL-25	294	26	5	232	232
PL-31	347	26	5	276	276
PL-35	397	26	5	310	310
PL-40	459	26	5	364	364
PL-45	501	26	5	395	395
PL-50	549	31	5	445	445
PL-56	605	28	5	522	522
PL-63	696	31	5	626	626
PL-71	760	40	5	692	692
PL-80	840	40	5	772	772
PL-90	940	40	5	872	87
PL-100	1040	40	5	972	972



P

Persianas de sobrepresión en aluminio, construcción antichispas

Características:

- La persiana de sobrepresión se adapta directamente sobre la pared en que se instala el ventilador
- Apertura mediante sobrepresión por el flujo de aire
- Se cierran cuando el ventilador está en reposo
- Construcción en chapa de aluminio
- Velocidad máxima recomendable de 18m/seg. para los modelos 90 y 100

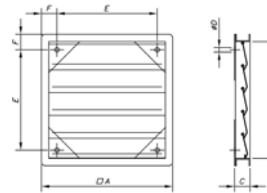

Modelo	Dimensiones					
	G	A	C	ØD	E	F
P 25	240	290	51	6	180	55
P 35	350	400	51	6	290	55
P 45	450	500	51	6	390	55
P 56	550	600	51	6	440	80
P 63	645	715	72	6	555	80
P 71	710	780	72	6	620	80
P 80	805	875	72	6	695	90
P 90	900	970	72	6	790	90
P 100	1000	1070	72	6	890	90



R

Rejilla de protección para la aspiración de ventiladores helicoidales.

Modelo	HC	HCH/HDF
R-35/B	-	35
R-40	-	40
R-45	-	45
R-56	-	56-4T/M-0,75, 56-4T-1, 56-6T/M-0,33, 56-6T-0,5, 56-6T-0,75
R-56 - 1,5	-	56-4T-1,5, 56-4T-2
R-63 - 0,5	-	63-4T-1, 63-6T/M-0,5, 63-6T-0,75
R-63 - 1,5	-	63-4T-1,5, 63-4T-2, 63-6T-1
R-63 - 4	-	63-4T-3, 63-4T-4
R-71	-	71-4T-1,5, 71-4T-2, 71-6T/M-0,75, 71-6T-1, 71-6T-1,5
R-71/C*	71	
R-71-3	-	71-4T-3, 71-4T-4
R-80	-	80-6T-1, 80-6T-1,5, 80-8T-0,5, 80-8T-0,75

Modelo	HC	HCH/HDF
R-80/C*	80	
R-80 - 5,5	-	80-4T-3, 80-4T-4, 80-4T-5,5, 80-6T-2, 80-6T-3, 80-8T-1
R-90	-	90-4T-4, 90-4T-5,5, 90-6T-2, 90-6T-3, 90-8T-1, 90-8T-1,5, 90-8T-2
R-90/C*	90	
R-90 - 7,5	-	90-4T-7,5, 90-4T-10, 90-6T-4, 90-8T-3
R-100	-	100-6T-3, 100-8T-1,5, 100-8T-2
R-100/C*	100	
R-100-7,5/C*	100 4T/H	
R-100 - 10	-	100-4T-7,5, 100-4T-10, 100-6T-4, 100-6T-5,5, 100-8T-1,5, 100-8T-2
R-100 - 20	-	100-4T-15, 100-4T-20

* estos modelos se suministran con rejilla cuadrada



RI

Rejilla de protección para la impulsión de ventiladores helicoidales.

Modelo	HCDF	HC	HCH/HDF	Modelo	HCDF	HC	HCH/HDF	Modelo	HCDF	HC	HCH/HDF
RI-25	25	25	-	RI-45	45	45	45	RI-71	-	71	71
RI-31	31	31	-	RI-50	50	50	-	RI-80	-	80	80
RI-35/C	35	35	-	RI-56	56	56	56	RI-90	-	90	90
RI-40	40	40	40	RI-63	-	63	63	RI-100	-	100	100



RT

Rejilla de protección para la aspiración o impulsión de ventiladores helicoidales tubulares.

Modelo	HTP/HBA	HCT	HPX	Modelo	HTP/HBA	HCT	HPX	Modelo	HTP/HBA	HCT	HPX
RT-25	-	25	-	RT-45	-	45	45	RT-71	71	71	71
RT-31/B	-	31	-	RT-50	50	50	50	RT-80	80	80	80
RT-35	-	35	35	RT-56	56	56	56	RT-90	90	90	90
RT-40	-	40	-	RT-63	63	63	63	RT-100	100	100	100



RPA

Rejilla de protección para la aspiración de ventiladores centrífugos

Características:

- Previene contra contactos con la turbina y posibles entradas de objetos, según norma UNE-EN ISO 12499:2010
- Construida en chapa de acero

Aplicable a los modelos

Modelo	CMA	CAS	CA	CMP	CMR
RPA-10	-	-	-	38	-
RPA-11	218	-	-	-	-
RPA-13	324	-	234	-	-
RPA-15	325/426	242	142	512	-
RPA-17	527	248	148	514	-
RPA-18	528	254	154	-	-
RPA-20	531	260	-	616	-
RPA-23	-	680	160/166/172	718	-
RPA-25	540/545	790	-	620/820	-
RPA-28	-	463/467	-	922	-
RPA-31	-	571/640/645/650/980/1080	-	1025	-
RPA-35	-	852/990/1090	-	1128	-
RPA-38	-	-	-	231	1031
RPA-42	-	856	-	1435	1135
RPA-44	-	1250/A	-	-	-
RPA-47	-	863/971	-	1640	1240
RPA-48	-	1456/A	-	-	-
RPA-52	-	-	-	1845	1445
RPA-55	-	-	-	-	-
RPA-60	-	-	-	2050	1650
RPA-65	-	1663/A	-	-	-
RPA-66	-	-	-	-	1856
RPA-73	-	1671/A-2071/A	-	2563	2063
RPA-81	-	2080/A	-	-	2271
RPA-88	-	-	-	-	2380
RPA-90	-	-	-	-	2590
RPA-100	-	-	-	-	28100



Drall-Regler

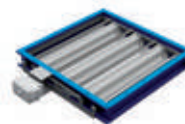

Válvula lamas contrapuestas

- Válvulas para regulación de caudal para boca de impulsión i aspiración de accionamiento manual, aptas para rangos de temperaturas entre °C -10/ +150 y rangos de presiones entre Pa 0 / 5.000.
- Fabricación robusta incorporando rodamientos de bolas en todos los ejes.



BTUB

Brida de acoplamiento para ventiladores helicoidales

Modelo	HTP/HBA	HCT	HPX	HT	Modelo	HTP/HBA	HCT	HPX	HT	Modelo	HTP/HBA	HCT	HPX	HT
BTUB-250	-	25	-	25	BTUB-450	45	45	45	45	BTUB-710	71	71	71	71
BTUB-280	-	31	-	-	BTUB-500	50	50	50	50	BTUB-800	80	80	80	80
BTUB-315	31	-	-	31	BTUB-560	56	56	56	56	BTUB-900	90	90	90	90
BTUB-355	35	35	-	35	BTUB-630	63	63	63	63	BTUB-1000	100	100	100	100
BTUB-400	40	40	-	40										



PV

Pabellón de aspiración aplicable a las series HEPT, HCT, HGT, HTP, THT

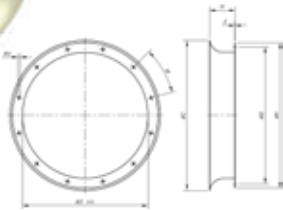

Modelo	øA	øB	ØC	øD	ød	E	M	H	Modelo	øA	øB	ØC	øD	ød	E	M	H
PV-31	398	355	426	320	10	1,5	8x45°	165	PV-80	904	860	915	797	12	2	16x22,5°	250
PV-35	438	395	435	359	10	1,5	8x45°	165	PV-90	1004	970	1015	894	14	2	16x22,5°	250
PV-40	484	450	507	401	12	1,5	8x45°	165	PV-100	1105	1070	1115	1003	14	2	16x22,5°	250
PV-45	534	500	555	450	12	1,5	8x45°	165	PV-125	1370	1320	1364	1240	14	2	20x18°	250
PV-50	584	560	617	504	12	1,5	12x30°	165	PV-140	1533	1470	1673	1413	15	3	20x18°	250
PV-56	664	620	667	565	12	1,5	12x30°	165	PV-160	1705	1680	1866	1585	19	3	24x15°	315
PV-63	734	690	757	634	12	1,5	12x30°	165	PV-180	1908	1830	1923	1788	19	3	24x15°	315
PV-71	812	770	816	711	12	2	16x22,5°	250	PV-200	2113	2080	2128	1993	19	3	24x15°	315



B

Brida de acoplamiento para ventiladores centrífugos

Características:

- Se adapta a la boca de aspiración y de impulsión
- Facilita la instalación al conducto

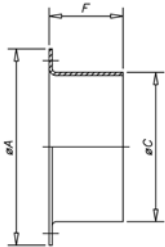

	ØA	ØC	F		ØA	ØC	F		ØA	ØC	F		ØA	ØC	F
B-52-E	100	52	67	B-200	260	200	60	B-355/1	430	355	80	B-500/5	590	500	80
B-63	110	63	60	B-224	280	224	60	B-355/2	430	355	80	B-560/1	650	560	80
B-80	150	80	60	B-250/1	310	250	80	B-355/3	430	355	80	B-560/2	650	560	80
B-80-E	150	80	60	B-250/2	310	250	80	B-355/4	430	355	80	B-560/3	650	560	80
B-100	150	100	60	B-250/3	310	250	80	B-400/1	480	400	80	B-630/1	720	630	80
B-100-E	170	100	60	B-250/4	310	250	80	B-400/2	480	400	80	B-630/2	720	630	80
B-112	160	112	60	B-250/5	310	250	80	B-400/3	480	400	80	B-630/3	720	630	80
B-125	180	125	60	B-280/1	350	280	80	B-400/4	480	400	80	B-630/4	720	630	80
B-140	190	140	60	B-280/2	350	280	80	B-450/1	530	450	80	B-710/1	800	710	80
B-150	210	150	60	B-280/3	350	280	80	B-450/2	530	450	80	B-710/2	800	710	80
B-160	220	160	60	B-315/1	380	315	80	B-450/3	530	450	80	B-710/3	800	710	80
B-160/1	220	160	60	B-315/2	380	315	80	B-500/1	590	500	80	B-800	890	800	100
B-160/2	310	160	80	B-315/3	380	315	80	B-500/2	590	500	80	B-900/1	1000	900	100
B-180	240	180	60	B-315/4	380	315	80	B-500/3	590	500	80	B-1000/1	1100	1000	100
B-180/1	240	180	60	B-315/5	380	315	80	B-500/4	590	500	80				

Aspiración

Impulsión

Modelo	CHT CVT	CRF	CMAT CMA	CB	CAST CAS	CA	CAM	CMP TCMP	CMT	CBP	CMR-X TCR TCR/R CMR	CMAT CMA	CA
B-52-E	-	-	-	-	-	-	-	-	-	-	-	-	234
B-63	-	-	-	-	-	-	-	-	-	-	-	218/324	142
B-80	-	-	218/324	-	-	-	-	-	-	-	-	325	-
B-80-E	-	-	-	-	-	-	-	-	-	-	-	-	148/154/160/166
B-100	-	-	325	-	-	234	-	-	-	-	-	426/527	-
B-100-E	-	-	-	-	242	142	-	-	-	-	-	-	172
B-112	-	-	426	-	248	148	-	512	-	-	-	-	-
B-125	-	-	527/528	-	254	154	-	-	-	-	-	528	-
B-140	-	-	-	-	-	-	-	514	-	-	-	-	-
B-150	-	-	531	-	260	160	-	-	-	-	-	531/540	-
B-160	-	-	-	-	-	-	-	616	-	-	-	-	-
B-160/1	-	225	-	-	680	-	-	-	-	-	-	-	-
B-160/2	-	-	-	-	-	-	-	-	-	-	625	-	-
B-180	-	250	540	-	790	166/172	540/545	718	922	-	-	545	-
B-180/1	-	-	545	-	-	-	-	-	-	-	-	-	-
B-200	-	-	-	820	463	-	-	620/820	1025	-	-	-	-
B-224	-	-	-	-	467	-	550/752	922	1128	-	622	-	-
B-250/1	-	-	-	-	571/640/645/650	-	-	-	1231	-	-	-	-

Modelo	Aspiración										Impulsión		
	CHT CVT	CRF	CMAT CMA	CB	CAST CAS	CA	CAM	CMP TCMP	CMT	CBP	CMR-X TCR TCR/R CMR	CMAT CMA	CA
B-250/2	-	-	-	-	-	-	760	-	-	-	-	-	-
B-250/3	200/225	315	-	-	-	-	-	1025	-	-	-	-	-
B-250/4	-	-	-	1428	-	-	-	-	-	-	-	-	-
B-250/5	-	-	-	-	980/1080	-	-	-	-	-	-	-	-
B-280/1	-	-	-	-	852	-	-	-	1435/1640	-	728	-	-
B-280/2	-	-	-	-	-	-	-	1128	-	-	-	-	-
B-280/3	-	-	-	-	990/1090	-	-	-	-	-	-	-	-
B-315/1	-	-	-	1733	-	-	-	-	-	-	-	-	-
B-315/2	-	-	-	-	-	-	880	-	-	-	-	-	-
B-315/3	-	-	-	-	-	-	-	-	-	-	1031	-	-
B-315/4	-	-	-	-	-	-	-	1231	-	-	-	-	-
B-315/5	-	-	-	-	-	-	-	-	-	-	731	-	-
B-355/1	-	-	-	-	-	-	-	-	-	-	1135	-	-
B-355/2	-	-	-	2240	863	-	-	-	-	-	-	-	-
B-355/3	250/315	355/400	-	-	856	-	-	1435	1845	-	-	-	-
B-355/4	-	-	-	-	1250/A	-	-	-	-	-	-	-	-
B-400/1	-	-	-	-	-	-	-	1640	-	-	-	-	-
B-400/2	-	-	-	-	-	-	-	-	-	-	1240	-	-
B-400/3	-	-	-	-	971	-	-	-	2050	-	-	-	-
B-400/4	-	-	-	-	1456/A	-	-	-	-	-	-	-	-
B-450/1	-	-	-	-	-	-	-	1845	-	-	-	-	-
B-450/2	-	-	-	-	-	-	-	-	-	-	1445	-	-
B-450/3	-	-	-	-	-	-	-	-	-	1445	-	-	-
B-500/1	-	-	-	-	-	-	-	2050	-	-	-	-	-
B-500/2	-	-	-	-	-	-	-	-	-	-	1650	-	-
B-500/3	-	-	-	-	-	-	-	-	-	1650	-	-	-
B-500/4	400/450	450/500	-	-	-	-	-	-	-	-	-	-	-
B-500/5	-	-	-	-	-	-	-	-	-	-	-	-	-
B-560/1	-	-	-	-	-	-	-	-	-	1856	-	-	-
B-560/2	-	-	-	-	-	-	-	-	-	-	1856	-	-
B-560/3	-	-	-	-	1663/A	-	-	-	-	-	-	-	-
B-630/1	-	-	-	-	-	-	-	2563	-	-	-	-	-
B-630/2	-	-	-	-	-	-	-	-	-	-	2063	-	-
B-630/3	500	-	-	-	-	-	-	-	-	-	-	-	-
B-630/4	-	-	-	-	1671/A-2071/A	-	-	-	-	-	-	-	-
B-710/1	-	-	-	-	-	-	-	-	-	-	2271	-	-
B-710/2	560/630	-	-	-	-	-	-	-	-	-	-	-	-
B-710/3	-	-	-	-	2080/A	-	-	-	-	-	-	-	-
B-800	-	-	-	-	-	-	-	-	-	-	2380	-	-
B-900/1	-	-	-	-	-	-	-	-	-	-	2590	-	-
B-1000/1	-	-	-	-	-	-	-	-	-	-	28100	-	-



BD

Brida de acoplamiento doble para ventiladores centrífugos

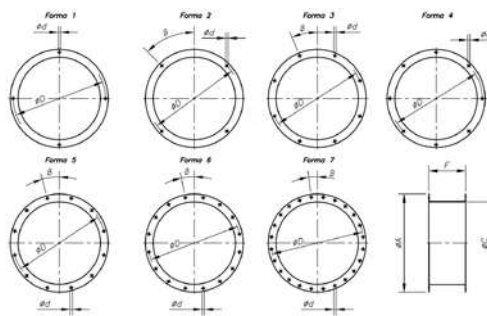

Características:

- Se adapta a la boca de aspiración
- Facilita la instalación al conducto con brida

	ØA	ØC	ØD	Ød	F	β	Forma
BD-200	260	200	225	7	80	15°	2
BD-224	280	224	254	7	80	-	1
BD-250/1	310	250	280	10	80	45°	2
BD-280	350	280	320	10	100	-	4
BD-315/3	390	315	355	10	100	22°30'	3
BD-355/3	430	355	395	10	100	22°30'	3
BD-400/1	480	400	450	12	100	22°30'	3
BD-400/2	480	400	450	12	100	22°30'	3
BD-450/1	530	450	500	12	100	22°30'	3
BD-450/2	530	450	500	12	100	22°30'	3
BD-500/2	590	500	560	12	100	15°	5
BD-560	650	560	620	12	120	15°	5
BD-630/2	720	630	690	12	120	15°	5
BD-710	800	710	770	12	120	11°15'	6
BD-800	890	800	860	12	140	11°15'	6
BD-900/1	1000	900	958	12	140	11°15'	6
BD-1000/1	1100	1000	1067	14	140	7°30'	7

Aplicable a los modelos

Modelo	CMP	CMR
BD-112	512	-
BD-140	514	-
BD-160	616	-
BD-180	718	-
BD-200	620/820	-
BD-224	922	-
BD-250/1	1025	-
BD-250/2	-	-
BD-280	1128	-
BD-315/1	-	-

Aplicable a los modelos

Modelo	CMP	CMR
BD-315/2	-	1031
BD-315/3	1231	-
BD-355/1	-	1135
BD-355/2	-	-
BD-355/3	1435	-
BD-400/1	1640	-
BD-400/2	-	1240
BD-450/1	1845	-
BD-450/2	-	1445
BD-500/1	2050	-

Aplicable a los modelos

Modelo	CMP	CMR
BD-500/2	-	1650
BD-560	-	1856
BD-630/1	2563	-
BD-630/2	-	2063
BD-710	-	2271
BD-800	-	2380
BD-900/1	-	2590
BD-1000/1	-	28100

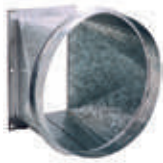

BIC

Brida conversión de rectangular a circular para ventiladores centrifugos

- Características:
- Se adapta a la boca de impulsión
 - Facilita la instalación al conducto circular

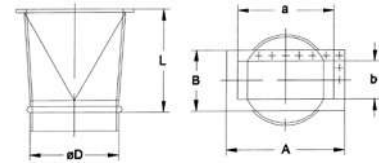

Modelo	L	D	a	b	A	B	Aplicable a modelos
BIC-242	200	100	95	60	155	120	CAS-242
BIC-248	200	112	105	66	165	126	CAS-248
BIC-254	200	125	115	75	175	135	CAS-254
BIC-260	200	150	125	85	185	145	CAS-260
BIC-463	200	200	125	85	185	145	CAS-463
BIC-467	250	224	130	90	190	150	CAS-467
BIC-571	250	250	145	95	205	155	CAS-571
BIC-640	250	250	200	125	260	185	CAS-640
BIC-645	250	250	224	140	284	200	CAS-645
BIC-650	250	250	250	160	310	220	CAS-650
BIC-680	250	180	100	71	160	131	CAS-680
BIC-790	250	180	112	80	172	140	CAS-790
BIC-852	250	280	280	180	340	240	CAS-852
BIC-856	280	355	280	180	340	240	CAS-856
BIC-863	280	355	315	200	375	260	CAS-863
BIC-971	280	400	355	224	425	294	CAS-971
BIC-980	300	250	200	140	270	210	CAS-980
BIC-990	300	280	224	160	294	230	CAS-990
BIC-1080	300	250	200	140	270	210	CAS-1080
BIC-1090	300	280	224	160	294	230	CAS-1090
BIC-1250	450	400	400	280	480	360	CAS-1250/A
BIC-1456	450	450	450	315	530	395	CAS-1456/A
BIC-1663	450	500	500	355	580	435	CAS-1663/A
BIC-1671	450	630	560	400	660	500	CAS-1671/A-2071/A
BIC-2080	450	710	630	450	730	550	CAS-2080/A
BIC-512	300	112	86	75	118	104	CMP-512

Modelo	L	D	a	b	A	B	Aplicable a modelos
BIC-514	300	140	107	83	147	122	CMP-514
BIC-616	300	160	125	103	172	153	CMP-616
BIC-620	300	200	100	105	153	159	CMP-620
BIC-718	300	180	146	115	192	169	CMP-718
BIC-820	300	200	156	160	213	184	CMP-820
BIC-922	300	224	216	140	282	204	CMP-922
BIC-1025	300	250	250	165	314	229	CMP-1025
BIC-1128	300	280	300	180	364	244	CMP-1128
BIC-1231	300	315	320	200	384	266	CMP-1231
BIC-1435	300	355	280	228	344	294	CMP-1435
BIC-1640	300	400	320	250	404	336	CMP-1640
BIC-1845	450	450	360	284	444	370	CMP-1845
BIC-2050	450	500	450	315	545	412	CMP-2050
BIC-2563	450	630	600	410	706	512	CMP-2563
BIC-1031	300	315	315	250	385	320	CMR-1031
BIC-1135	450	355	355	280	425	350	CMR-1135
BIC-1240	450	400	400	315	480	395	CMR-1240
BIC-1445	450	450	450	355	540	445	CMR-1445
BIC-1650	450	500	500	400	590	490	CMR-1650
BIC-1856	450	560	560	450	660	550	CMR-1856
BIC-2063	450	630	630	500	750	620	CMR-2063
BIC-2271	450	710	710	560	840	690	CMR-2271
BIC-2380	600	800	800	560	920	680	CMR-2380
BIC-2590	600	900	900	630	1020	750	CMR-2590
BIC-28100	600	1000	1000	710	1120	830	CMR-28100



BAC

Brida de acoplamiento doble y elástica para ventiladores helicoidales

- Características:
- Se adapta a la boca de aspiración e impulsión
 - Facilita la instalación al conducto con brida
 - Evita la transmisión de vibraciones

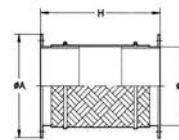

Modelo	HEPT	HCT	HGT	CHT/CVT	HT	HPX	CRF
BAC-160	-	-	-	-	-	-	225
BAC-180	-	-	-	-	-	-	250
BAC-250	-	25	-	200/225	25	-	315
BAC-315/B	-	31	-	-	-	-	-
BAC-315	31	-	-	-	31	-	-
BAC-355	35	35	-	250/315	35	35	355/400
BAC-400	40	40	-	-	40	-	-
BAC-450	45	45	-	-	45	45	-

Modelo	HEPT	HCT	HGT	CHT/CVT	HT	HPX	CRF
BAC-500	50	50	-	400/450	50	50	450/500
BAC-560	56	56	-	-	56	56	-
BAC-630	63	63	-	500	63	63	-
BAC-710	-	71	-	560/630	71	71	-
BAC-800	-	80	-	-	80	80	-
BAC-900	-	90	-	-	90	90	-
BAC-1000	-	100	-	-	100	100	-
BAC-1250	-	-	125	-	-	-	-

	ØD*	ØA*	H
BAC-250	250	310	340
BAC-355	355	430	340
BAC-400	400	480	340
BAC-450	450	530	340
BAC-500	500	590	340
BAC-560	560	650	340
BAC-630	630	720	340
BAC-710	710	800	340
BAC-800	800	890	340
BAC-900	900	1000	340
BAC-1000	1000	1100	340
BAC-1250	1250	1365	340

*Diámetro nominal tubería



PS

Conjunto de pies soporte, para ventiladores tubulares.

- Características:
- Al fijarse a la brida facilita la fijación sobre superficies planas

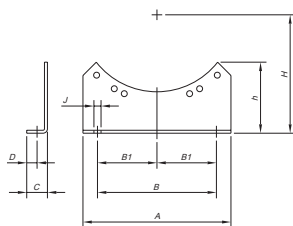

Modelo	A	B	B1	C	D	h	H	ØJ
PS-35/40	240	200	-	40	17	75	270,5	12
PS-45/50	450	400	200	40	17	175	328	12
PS-45/50	450	400	200	40	17	175	355	12
PS-56/63	520	430	215	45	20	242	425	14
PS-56/63	520	430	215	45	20	242	472,5	14
PS-71	620	530	265	50	20	228	530	16
PS-80	730	640	320	60	25	255	590	16
PS-90	780	690	345	70	30	273	650	18
PS-100	860	770	385	75	35	310	730	18
PS-125	1020	920	460	55	25	411	830	13

Modelo	HCT/HBA	HPX/HTP
PS-25/31	25/31	-
PS-35/40	35/40	35
PS-45/50	45/50	45/50
PS-56/63	56/63	56/63
PS-71	71	71
PS-80	80	80
PS-90	90	90
PS-100	100	100



MS

Marco soporte para facilitar el montaje en obra

Características:

- Utilizado para facilitar el montaje del ventilador en conductos de obra

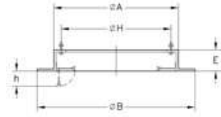

Modelo	ØA	ØB	E	ØH	h
MS-348	348	520	60	295	70
MS-393	393	565	60	320	70
MS-443	443	615	60	360	70
MS-493	493	665	60	410	70
MS-553	553	725	60	450	70

Modelo	ØA	ØB	E	ØH	h
MS-623	623	795	60	530	70
MS-701	701	875	60	590	90
MS-791	791	965	60	680	90
MS-891	891	1065	60	750	90
MS-991	991	1165	60	850	90
MS-1086	1086	1260	60	850	90
MS-1140	1140	1314	60	1000	90
MS-1240	1240	1414	60	1100	90

Modelo	CHT/CVT	HT	CRF
MS-348	-	-	225
MS-393	-	-	250
MS-443	200/225	25	315
MS-493	-	31	-
MS-553	250/315	35	355/400
MS-623	-	40	-
MS-701	400/450	45	450/500
MS-791	-	50	-
MS-891	500	56	-
MS-991	-	63/71	-
MS-1086	560/630	-	-
MS-1140	-	80/90	-
MS-1240	-	100	-



PA

Placa de adaptación para montaje de accesorios, en extractores de tejado

Características:

- Se utiliza para el montaje de los accesorios PT, B, BTUB, BAC. Permite separar el ventilador de su base sin desmontar el conjunto de accesorios

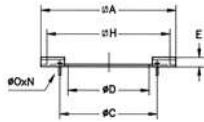

Modelo	ØA	ØJ	ØD	E	ØH	ØO	N
PA-345	345	200	165	20	245	M.8	4x90°
PA-390	390	210	190	20	320	M.8	4x90°
PA-440/250	440	280	249	20	360	M.6	4x90°
PA-490	490	355	314	20	410	M.8	8x45°
PA-550	550	395	354	20	450	M.6	8x45°
PA-620	620	450	399	20	530	M.10	8x45°
PA-700/500	700	560	499	20	590	M.10	12x30°
PA-700/450	700	500	449	20	590	M.10	8x45°

Modelo	ØA	ØJ	ØD	E	ØH	ØO	N
PA-790	790	560	499	20	680	M.10	12x30°
PA-890/630	890	690	629	20	750	M.10	12x30°
PA-890/560	890	620	559	20	750	M.10	12x30°
PA-990/630	990	690	629	20	850	M.10	12x30°
PA-990/710	990	770	709	20	850	M.10	16x22°30'
PA-1085	1085	770	709	20	850	M.10	16x22°30'
PA-1138/800	1138	860	799	25	1000	M.10	16x22°30'
PA-1138/900	1138	970	899	25	1000	M.12	16x22°30'
PA-1238	1238	1070	999	25	1100	M.12	16x22°30'

Modelo	CHT/CHT	HT	CRF
PA-345	-	-	225
PA-390	-	-	250
PA-440/250	200/225	25	315
PA-490	-	31	-
PA-550	250/315	35	350/400
PA-620	-	40	-
PA-700/500	400/450	-	450/500
PA-700/450	-	45	-
PA-790	-	50	-
PA-890/630	500	-	-
PA-890/560	-	56	-
PA-990/630	-	63	-
PA-990/710	-	71	-
PA-1085	560/630	-	-
PA-1138/800	-	80	-
PA-1138/900	-	90	-
PA-1238	-	100	-



PT

Obturadores de cierre automático para trabajo vertical

Características:

- Obturadores circulares de cierre automático para ser instalados en la aspiración de extractores de tejado
- Aconsejable utilizar la placa de adaptación PA, para su montaje

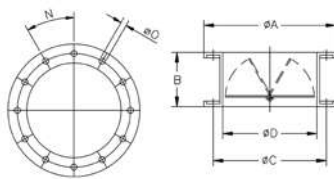

Modelo	ØA	B	ØC	ØD*	ØO	N	Aplicable a los modelos	
							CHT/CVT	CRF
PT-160	220	150	200	160	10	4x90°	-	225
PT-180	240	150	210	180	10	4x90°	-	250
PT-250	310	150	280	250	10	4x90°	200/225	315
PT-355	435	200	395	355	10	8x45°	250/315	350/400
PT-500	600	280	560	500	12	12x30°	400/450	450/500
PT-630	730	355	690	630	12	12x30°	500	-
PT-710	810	400	770	710	12	16x22°30'	560/630	-

*Diámetro nominal tubería



OP

Obturadores de sobrepresión para extractores de tejado

25-63

OP-25	HT-25
OP-31	HT-31
OP-35	HT-35

OP-40	HT-40
OP-45	HT-45
OP-50	HT-50

OP-56	HT-56
OP-63	HT-63
OP-71	HT-71

OP-80	HT-80
OP-90	HT-90
OP-100	HT-100



71-100



ACE/ATEX

Acoplamiento elástico para amortiguar vibraciones

Características:

- Se utiliza entre la boca del ventilador y el conducto para evitar la transmisión de vibraciones

	Aplicable a los modelos (ASPIRACIÓN)					Aplicable a los modelos (IMPULSIÓN)	
	CMA	CAS	CA	CMP	CMR	CA	CMA
ACE-52	-	-	-	-	-	234	-
ACE-63	-	-	-	-	-	142	218/324
ACE-80	218/324	-	-	-	-	148/154 160/166	325
ACE-100	325	242	234/142	-	-	172	426/527
ACE-112	426	248	148	512	-	-	-
ACE-125	527/528	254	154	-	-	-	528
ACE-140	-	-	-	514	-	-	-
ACE-150	531	260	160	-	-	531/540	-
ACE-160	-	680	-	616	-	-	-
ACE-180	540/545	790	166/172	718	-	-	545
ACE-200	-	463	-	620/820	-	-	-
ACE-224	-	467	-	922	-	-	-
ACE-250	-	-	-	1025	-	-	-
ACE-280	-	571/640/645 650/980/1080	-	1128	-	-	-
ACE-315	-	852/990/1090	-	1231	1031	-	-
ACE-355	-	-	-	1435	1135	-	-
ACE-400	-	856/863/1250/A	-	1640	1240	-	-
ACE-450	-	971/1456/A	-	1845	1445	-	-
ACE-500	-	-	-	2050	1650	-	-
ACE-560	-	1663/A	-	-	1856	-	-
ACE-630	-	1671/A-2071/A	-	2563	2063	-	-
ACE-710	-	2080/A	-	-	2271	-	-
ACE-800	-	-	-	-	2380	-	-
ACE-900	-	-	-	-	2590	-	-
ACE-1000	-	-	-	-	28100	-	-



REG Registro de regulación manual

Características:

- Su construcción permite incorporarlos en los sistemas de conductos, para la regulación del caudal

Modelo	L	ØD*	Modelo	L	ØD*
REG-80	100	80	REG-250	100	250
REG-100	100	100	REG-280	100	280
REG-112	100	112	REG-315	100	315
REG-125	100	125	REG-355	100	355
REG-140	100	140	REG-400	100	400
REG-150	100	150	REG-450	150	450
REG-160	100	160	REG-500	150	500
REG-180	100	180	REG-560	150	560
REG-200	100	200	REG-630	250	630
REG-224	100	224	REG-800	250	800



CJACUS Cajas acústicas para ventiladores centrifugos

Características:

- Caja de ventilación construida en chapa galvanizada con aislamiento acústico
- Pies soporte y silent-blocks incluidos
- CJACUS/C: Con conexión de aspiración e impulsión al exterior, por medio de conductos. Rejilla para la refrigeración del motor incluida
- CJACUS/L: Con aspiración libre por medio de rejilla, incorporada en la caja y conexión de impulsión al exterior

Modelo	Aplicable a los modelos		
	CAS	CA	CAM
CJACUS-0	640	154	540
CJACUS-1	254/645	160	545
CJACUS-2	260/463/650	166	550/752
CJACUS-3	467/852/856	172	-
CJACUS-4	571/863	-	760
CJACUS-5	971	-	880



S Silenciadores para acoplar a la aspiración o impulsión.

Características:

- Silenciadores circulares o rectangulares para acoplar a la aspiración o impulsión, de ventiladores centrífugos o helicoidales

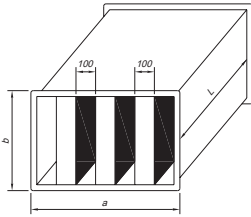

ASPIRACIÓN / IMPULSIÓN (Sección rectangular)

	L	a	b	Kg	Amortiguación de sustitución (dB) en banda de octavos (Hz)						Aplicable
					125	250	500	1000	2000	4000	
SR-1000/900/900	900	1000	900	64	4	10	21	37	44	37	HCH/HCT
SR-1200/900/900	900	1200	900	74	4	10	21	37	44	37	HCH/HCT
SR-1400/1200/900	900	1400	1200	102	4	12	25	41	47	42	HCH/HCT
SR-1800/1200/1200	1200	1800	1200	169	4	12	25	41	47	42	HCH/HCT
SR-1800/1500/1200	1200	1800	1504	195	4	12	25	41	47	42	HCH/HCT

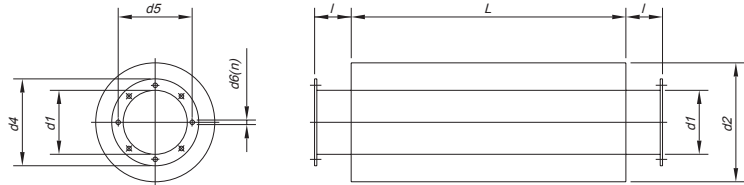

ASPIRACIÓN / IMPULSIÓN (Sección circular)

	L	d1	d2	l	d3	d4	d5	d6	n	Kg	Amortiguación de sustitución (dB) en banda de octavos (Hz)						Aplicable
											125	250	500	1000	2000	4000	
SC-630/900	900	630	800	100	630	720	690	12	12x30°	44	5	8	14	12	13	9	HCH/HCT
SC-710/900	900	710	900	100	710	800	770	12	16x22°30'	65	5	8	13	11	12	8	HCH/HCT
SC-800/900	900	800	1000	100	800	900	860	12	16x22°30'	70	4	8	11	9	9	8	HCH/HCT
SC-900/1200	1200	900	1120	100	900	1000	970	15	16x22°30'	87	5	7	11	11	7	5	HCH/HCT
SC-1000/1200	1200	1000	1200	100	1000	1100	1070	15	16x22°30'	95	4	7	11	10	7	6	HCH/HCT

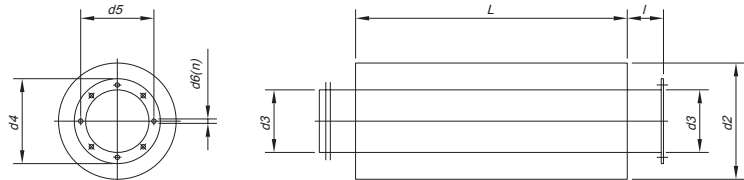

	L	d2	d3	d4	d5	d6	n	Kg	Amortiguación de sustitución (dB) en banda de octavos (Hz)						Aplicable	
									125	250	500	1000	2000	4000		
S-250/600-A	600	450	250	310	280	10	4x90°	14	5	12	20	24	23	14	CVT-CHT-200/225 / HT-25	
S-315/900-A	900	500	315	390	355	10	8x45°	22	4	12	21	26	19	15	HT-31	
S-355/900-A	900	560	355	430	395	10	8x45°	25	4	12	20	24	18	14	CVT-CHT-250/315 / HT-35	
S-400/900-A	900	600	400	480	450	12	8x45°	29	5	12	19	22	18	13	HT-40	
S-450/900-A	900	630	450	530	500	12	8x45°	32	5	12	18	20	16	12	HT-45	
S-500/900-A	900	710	500	590	560	12	12x30°	35	4	11	18	16	14	11	CVT-CHT-400/450 / HT-50	
S-560/900-A	900	750	560	650	620	12	12x30°	41	4	10	16	14	13	10	HT-56	
S-630/900-A	900	800	630	720	690	12	12x30°	44	5	8	14	12	13	9	CVT-CHT-500 / HT-63	
S-710/900-A	900	900	710	800	770	12	16x22°30'	65	5	8	13	11	12	8	CVT-CHT-560/630 / HT-71	
S-800/900-A	900	1000	800	900	860	12	16x22°30'	70	4	8	11	9	9	8	HT-80	
S-900/1200-A	1200	1120	900	1000	970	12	16x22°30'	85	5	7	11	11	7	6	HT-90	
S-1000/1200-A	1200	1200	1000	1100	1070	12	16x22°30'	95	4	7	11	10	7	6	HT-100	

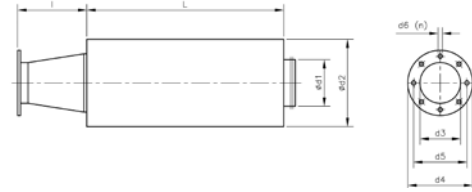

IMPULSIÓN (Brida circular)

	L	d1	d2	l	d3	d4	d5	d6	n	Kg	<i>Amortiguación de sustitución (dB) en banda de octavos (Hz)</i>						
											125	250	500	1000	2000	4000	Aplicable
S-80/600/234-I	600	80	280	103	40	100	72	9	2x180°	6	17	26	29	53	53	45	CAS-234
S-100/600/142-I	600	100	300	131	60	120	90	11	4x90°	8	13	23	34	46	52	40	CA-142
S-150/900/148-I	900	150	355	176	73	150	110	11	4x90°	11	10	27	37	51	53	37	CA-148
S-160/900/154-I	900	160	355	190	80	160	120	13	4x90°	12	11	24	35	49	51	27	CA-154
S-200/900/160-I	900	200	400	245	85	160	120	13	4x90°	17	8	18	28	40	37	23	CA-160
S-200/900/166-I	900	200	400	245	85	160	120	13	4x90°	17	8	18	28	40	37	23	CA-166
S-200/900/172-I	900	200	400	245	90	175	140	13	4x90°	17	8	18	28	40	37	23	CA-172

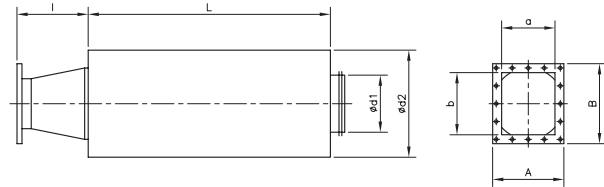

IMPULSIÓN (Brida rectangular)

	L	d1	d2	l	a	b	A	B	Kg	<i>Amortiguación de sustitución (dB) en banda de octavos (Hz)</i>						
										125	250	500	1000	2000	4000	Aplicable
S-100/600/242-I	600	100	300	200	95	60	155	120	8	13	23	34	46	52	40	CAS-242
S-150/900/248-I	900	150	355	200	105	66	165	126	11	10	27	37	51	53	37	CAS-248
S-160/900/254-I	900	160	355	200	115	75	175	135	12	11	24	35	49	51	27	CAS-254
S-200/900/260-I	900	200	400	200	125	85	185	145	17	8	18	28	40	37	23	CAS-260
S-200/900/463-I	900	200	400	200	125	85	185	145	17	8	18	28	40	37	23	CAS-463
S-250/900/467-I	900	250	450	250	130	90	190	150	22	6	17	30	34	28	17	CAS-467
S-250/900/571-I	900	250	450	250	145	95	205	155	22	6	17	30	34	28	17	CAS-571
S-250/600/640-I	900	250	450	250	200	125	260	185	14	5	12	20	24	23	14	CAS-640
S-315/900/645-I	900	315	500	250	224	140	284	200	22	4	12	21	26	19	15	CAS-645
S-355/900/650-I	900	355	560	250	250	160	310	220	25	4	12	20	24	18	14	CAS-650
S-180/900/680-I	900	180	380	100	71	100	131	160	15	9	21	31	44	44	25	CAS-680
S-180/900/790-I	900	180	380	100	80	112	140	172	15	9	21	31	44	44	25	CAS-790
S-355/900/852-I	900	355	560	250	280	180	340	240	25	4	12	20	24	18	14	CAS-852
S-400/1200/856-I	1200	400	600	280	280	180	340	240	38	7	16	22	29	22	15	CAS-856
S-400/1200/863-I	1200	400	600	280	315	200	375	260	38	7	16	22	29	22	15	CAS-863
S-450/1200/971-I	1200	450	630	280	355	224	425	294	42	6	15	21	25	20	14	CAS-971
S-250/1200/980-I	1200	250	450	100	140	200	210	270	29	9	22	35	39	33	20	CAS-980
S-280/1200/990-I	1200	280	450	100	160	224	230	294	33	8	18	31	38	28	19	CAS-990
S-250/1200/1080-I	1200	250	450	100	140	200	210	270	29	9	22	35	39	33	20	CAS-1080
S-280/1200/1090-I	1200	280	450	100	160	224	230	294	33	8	18	31	38	28	19	CAS-1090
S-500/900/1250-I	1200	500	600	300	280	400	360	480	9	6	13	18	15	15	12	CAS-1250/A
S-560/900/1456-I	900	560	630	450	315	450	395	530	9	5	8	13	11	12	8	CAS-1456/A
S-630/1200/1663-I	900	630	750	450	355	500	435	580	12	4	8	13	11	11	9	CAS-1663/A
S-315/600/922-I	600	315	500	300	216	140	282	204	16	4	8	14	17	14	12	CMP-922
S-355/900/1025-I	900	355	560	300	250	165	314	229	25	4	12	20	24	23	14	CMP-1025
S-400/900/1128-I	900	400	600	300	300	180	364	244	29	5	12	19	22	18	13	CMP-1128
S-450/900/1231-I	900	450	630	300	320	200	384	266	32	5	12	18	20	16	12	CMP-1231
S-500/900/1435-I	900	500	710	300	280	228	344	294	35	4	11	18	16	14	11	CMP-1435
S-500/900/1640-I	900	500	710	300	320	250	404	336	35	4	11	18	16	14	11	CMP-1640
S-560/900/1845-I	900	560	750	450	360	284	444	370	41	4	10	16	14	13	10	CMP-1845
S-630/1200/2050-I	1200	630	800	450	450	315	545	412	56	6	13	18	15	15	12	CMP-2050
S-800/1200/2563-I	1200	800	1000	450	600	410	706	512	80	5	9	13	11	11	9	CMP-2563
S-400/900/1031-I	900	400	600	300	315	250	385	320	29	5	12	19	22	18	13	CMR-1031
S-450/900/1135-I	900	450	630	450	355	280	425	350	32	5	12	18	20	16	12	CMR-1135
S-500/900/1240-I	900	500	710	450	400	315	480	395	35	4	11	18	16	14	11	CMR-1240
S-560/900/1445-I	900	560	750	450	450	355	540	445	41	4	10	16	14	13	10	CMR-1445
S-630/1200/1650-I	1200	630	800	450	500	400	590	490	56	6	13	18	15	15	12	CMR-1650
S-710/900/1856-I	900	710	900	450	560	450	660	550	65	5	8	13	11	12	8	CMR-1856
S-800/900/2063-I	900	800	1000	450	630	500	750	620	70	4	8	11	9	9	8	CMR-2063
S-800/1200/2271-I	1200	800	1000	450	710	560	840	690	80	5	9	13	11	11	9	CMR-2271
S-800/1201/2380-I	1200	800	1000	450	560	800	680	920	90	5	9	13	11	11	9	CMR-2380

Índice Alfabético de Referencias. VENTILADORES

CA/ATEX	188	CMRS	16	HGTX	107
CAB	59	CMRS-X	24	HPX/ATEX	174
CAS/ATEX	183	CPV/ATEX	177	HPX/SEC	100
CASB	38	HBA	98	HTMH	137
CASB-X	45	HCH/ATEX	167	HTMV	145
CAST	64	HCT/ATEX	167	HTP	84
CMR/ATEX	180	HCT/MAR	134		
CMRG	73	HFW	78		
CMRH	68	HGT	107		

Índice Alfabético de Referencias. ACCESORIOS

ACE/ATEX	200	Interruptor ATEX	193	REG	200
B	196	KME	193	RI	195
BAC	198	MS	199	RPA	195
BD	197	OP	199	RT	195
BIC	198	P	194	S	201
BTUB	196	PA	199	Válvula lamas contrapuestas	195
CJACUS	200	PL	194	VSD1/A-RFM	192
CUADROS ELÉCTRICOS	194	PS	198	VSD3/A-RFT	192
Drall-Regler	195	PT	199		
GMP	193	PV	196		
INT	193	R	194		

EFFICIENT WORK FANS



SOLution DEvelopment CAPacity

Fast and flexible industrial fan solutions and tailored fans

Large experience in smoke control systems and ATEX applications

Wide range of certified products for specific markets

VENTILADORES
HELICOIDALES Y
EXTRACTORES DE TEJADO



VENTILADORES
CENTRÍFUGOS Y EXTRACTORES
EN LÍNEA



EXTRACTORES
PARA EVACUACIÓN
DE HUMOS



VENTILADORES HEAVY DUTY
Y EXTRACTORES PARA
ATMÓSFERAS EXPLOSIVAS ATEX



RECUPERADORES DE CALOR,
UNIDADES DE FILTRACIÓN
Y TRATAMIENTO DE AIRE



CORTINAS DE AIRE PARA
APLICACIONES COMERCIALES E
INDUSTRIALES



SISTEMAS DE VENTILACIÓN
PARA VIVIENDAS



SOLICÍTENOS
INFORMACIÓN



www.sodeca.com



DIVISIÓN INDUSTRIAL HEAVY DUTY FANS

SODECA, S.L.U

Ctra. de Berga, km 0,7
E-08580 SANT QUIRZE DE BESORA
(Barcelona - Spain)

Tel. +34 93 504 16 65

Fax +34 93 852 90 42

Heavy duty division: divisionhd@sodeca.com

General sales: comercial@sodeca.com

Export sales: ventilation@sodeca.com

www.sodeca.com



HEADQUARTER

SODECA S.L.U.

Ctra. de Berga, km 0,7
E-08580 SANT QUIRZE DE
BESORA
Barcelona, SPAIN
Tel. +34 93 504 16 65
Fax +34 93 852 90 42
Heavy duty division:
divisionhd@sodeca.com
General sales:
comercial@sodeca.com
Export sales:
ventilation@sodeca.com

CHILE

Sodeca Ventiladores Ltda

Sr. Frederic Cousquer
Santa Bernardita 12.005
(Esquina con Puerta Sur)
Bodegas 24 a 26
03380 San Bernardo,
Santiago, CHILE
Tel. +56 22 840 5582
ventas.chile@sodeca.com

COLOMBIA

Sodeca Colombia S.A.S

Sra. Luisa Stella Prieto
Avenida 1 de Mayo
N°72N - 45/47 Sur
Bogotá, COLOMBIA
Tel. +57 1 293 7272
ventascolombia@sodeca.co

PORTUGAL

Sodeca Portugal Lda

PORTO
Rua Veloso Salgado 1120/1138
4450-801 Leça de Palmeira,
Tel. +351 229 991 100
Fax. +351 229 991 119
geral@sodeca.pt

FINLAND

Sodeca Finland Oy

Mr. Kai Yli-Sipilä
Metsälinnankatu 30, PL2,
FI-32700 Huittinen,
FINLAND
Tel. + 358 400 320 125
orders.finland@sodeca.com

PORTUGAL

Sodeca Portugal Lda

LISBOA
Parque Empresarial da Granja
Pavilhão 8
2625-607 Vialonga,
Tel. +351 219 748 491
Fax. +351 219 748 493
geral@sodeca.pt

RUSSIA

Sodeca, L.L.C.

Mr. Stanislav Alifanov
Myasisheva str, 1, room 603
Business Center "Chaika"
140180 Zhukovskiy,
Moscow, RUSSIA
Tel. +7 495 955 90 50
alifanov@sodeca.com

UNITED KINGDOM

Sodeca Fans UK Ltd

Mr. Mark Newcombe
Pacific House
Relay Point
Tamworth, B77 5PA
UNITED KINGDOM
Tel. +44 (0) 1827 264 435
Mob. +44 (0) 7488 517433
sales@sodeca.co.uk

ZONA CARIBE

Sodeca Cuba

Sr. Carlos Hernández
Residencial Miramar
Apto. N° 108
Ave. 7ma N° 1805 entre 18 y 20
Miramar Playa, Havana, CUBA
Tel. +537 20 43721
carlos@sodeca.co.cu



**DIVISIÓN INDUSTRIAL HEAVY DUTY FANS
SODECA, S.L.U**

Ctra. de Berga, km 0,7
E-08580 SANT QUIRZE DE BESORA
(Barcelona - Spain)
Tel. +34 93 504 16 65
Fax +34 93 852 90 42

Heavy duty division: divisionhd@sodeca.com

General sales: comercial@sodeca.com

Export sales: ventilation@sodeca.com

www.sodeca.com

