

THT

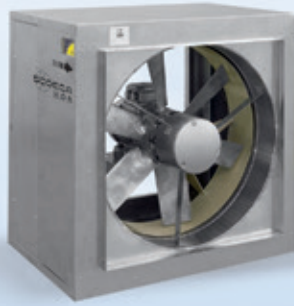

CJTHT/PLUS



THT-IMP-0



**AIRTECHNIC**

[www.airtechnic.gr](http://www.airtechnic.gr)

Air-Conditioning & Ventilation Components & Systems



# EXTRACTORES PARA LA EVACUACIÓN DE HUMOS

400°C/2h - 300°C/2h - 200°C/2h



EN-12101-3-2002  
Powered smoke and  
heat exhaust ventilators  
for use in Construction Works





## NUESTRO COMPROMISO CON EL MEDIO AMBIENTE

Sodeca ha iniciado una nueva etapa de estudio y diseño de nuevas tendencias de ventilación que ayuden a la preservación del medio ambiente y al ahorro energético que tanto preocupa a la sociedad actual.



Para obtener una mejora en la consumo energético, SODECA ha ajustado las turbinas y hélices en su zona de trabajo de máxima eficiencia. Por este motivo puede haber cambios en la representación de las curvas de este catálogo respecto a ediciones anteriores.

**SODECA** centra su actividad en la producción de ventiladores industriales, sistemas de ventilación y extractores para la evacuación de humos en caso de incendio, desde 1983 año de su fundación.

Los ventiladores y extractores de **SODECA** están presentes en todos los países Europeos y en gran parte del mundo, gracias a la calidad del producto y a los métodos de investigación y desarrollo utilizados.

Nuestros procedimientos de calidad utilizados y certificados por BUREAU VERITAS, según ISO 9001:2008, son otra de las razones que sitúan a **SODECA** como uno de los mejores y más reconocidos fabricantes de ventiladores de Europa.

Sin duda el factor más importante para alcanzar nuestros objetivos, es el factor humano, grandes profesionales que trabajan a su servicio, ofreciendo no solo equipos de ventilación, sino soluciones a cualquier necesidad de ventilación planteada por nuestros clientes.

Les ofrecemos la posibilidad de visitar nuestras instalaciones en Sant Quirze de Besora, con más de 16.000 m<sup>2</sup> de superficie construida, donde podrá ver nuestra fabricación de ventiladores, con las más altas exigencias de calidad, cumpliendo con las normativas de ISO y AMCA.

Este catálogo es solo un pequeño detalle de nuestras posibilidades, no dude en contactar con nosotros, ponemos toda nuestra experiencia y nuestro equipo humano a su disposición.



Instalaciones centrales de SODECA S.L.U. en Sant Quirze de Besora y planta de fabricación en Santiago de Chile.



# EXTRACTORES PARA EVACUACIÓN DE HUMOS Y SISTEMAS DE SOBREPRESIÓN



Gracias a los conocimientos adquiridos en los 25 años de experiencia, en la fabricación de ventiladores para trabajo continuo con alta temperatura, SODECA se ha especializado en la fabricación de extractores para la evacuación de humos en caso de incendios y sistemas de sobre presión para el control del humo en instalaciones de vías de escape en caso de incendio.

Si nuestros sistemas de fabricación están certificados por organismos exteriores de certificación de calidad como BUREAU VERITAS, los controles de calidad para los procesos de fabricación y control de los extractores, para la evacuación de humos con temperatura, están además, completamente auditados, por organismos independientes como APPLUS, para asegurar así el correcto funcionamiento y cumplimiento de normativas y características técnicas de los extractores.

Todos nuestros extractores para evacuación de humos cumplen con las exigencias de la Norma Europea EN 12101-3:2002/AC:2006 "Powered smoke and heat exhaust ventilators for use in Construction Works", y están certificados por laboratorio independiente y acreditado por las Directivas Europeas

## Resumen homologaciones y certificados:

■ Se entregan con homologación F-400, siendo aptos para aplicaciones F-300 y F-200

Serie	Tipo	Servicio S2			Marcado CE		
		F200 200°C-120min	F300 300°C-120min	F400 400°C-120min	F200 (120min)	F300 (60min)	F400 (120min)
THT - THT/ATEX	VENT.AXIAL	x	x	x	0370-CPR-0514	0370-CPR-0973	0370-CPR-0305
CJTHT/PLUS	VENT.AXIAL	x	x	x	0370-CPR-0515	0370-CPR-0974	0370-CPR-0312
CJTHT - CJTHT/ATEX	VENT.AXIAL	x	x	x	0370-CPR-0515	0370-CPR-0974	0370-CPR-0312
CJTHT/DUPLEX/ATEX	VENT.AXIAL		x	x		0370-CPR-0974	0370-CPR-0312
THT/IMP	VENT.IMPULSOS AXIAL	x	x	x	0370-CPR-0394	0370-CPR-0822	0370-CPR-0822
CI	VENT.IMPULSOS CENTRIFUGO		x			0370-CPR-0715	
HTMF	EXTRACTOR TEJADO AXIAL		x	x		0370-CPR-0544	0370-CPR-0544
CJBDT	VENT.CENTRIFUGO		x	x		0370-CPR-0888	0370-CPR-0580
CBDT	VENT.CENTRIFUGO		x	x		0370-CPR-0888	0370-CPR-0580
TCR	VENT.CENTRIFUGO		x	x		0370-CPR-0384	0370-CPR-0384
CTMP	VENT.CENTRIFUGO		x	x		0370-CPR-0397	0370-CPR-0397
CJS	VENT.CENTRIFUGO		x	x		0370-CPR-0398	0370-CPR-0398
CJMD	VENT.CENTRIFUGO		x	x		0370-CPR-0399	0370-CPR-0399
TCR/R	VENT.CENTRIFUGO	■	■	x			0370-CPR-0400
CJTCR/R	VENT.CENTRIFUGO	■	■	x			0370-CPR-0401
TCMP	VENT.CENTRIFUGO	■	■	x			0370-CPR-0313
CJMP	VENT.CENTRIFUGO	■	■	x			0370-CPR-0402
CJTX-C	VENT.CENTRIFUGO	■	■	x			0370-CPR-0468
CJSX	VENT.CENTRIFUGO	■	■	x			0370-CPR-0503
CJSRX	VENT.CENTRIFUGO	■	■	x			0370-CPR-1578
CSX	VENT.CENTRIFUGO	■	■	x			0370-CPR-1577
CJLINE	VENT.CENTRIFUGO	■	■	x			0370-CPR-0594
CJEC	VENT.CENTRIFUGO	■	■	x			0370-CPR-0382
CHT	EXTRACTOR TEJADO CENTRIFUGO	■	■	x			0370-CPR-0897
CVT	EXTRACTOR TEJADO CENTRIFUGO	■	■	x			0370-CPR-0897

# INMERSO

Instalación del ventilador inmerso en la zona de riesgo de incendio

<p><b>THT</b></p>  <p>Extractores helicoidales tubulares 400°C/2h, 300°C/2h y 200°C/2h</p> <p>12</p>	<p><b>CJTHT/PLUS</b></p>  <p>Unidades de extracción 400°C/2h, 300°C/2h y 200°C/2h, con atenuador acústico integrado</p> <p>20</p>	<p><b>CJTHT</b></p>  <p>Unidades de extracción helicoidales 400°C/2h, 300°C/2h y 200°C/2h, con caja aislada acústicamente</p> <p>24</p>	<p><b>CJTHT/DUPLEX/ATEX</b></p>  <p>Unidades de extracción 400°C/2h, con certificación ATEX categoría 2 Ex II 2G. De acuerdo R.E.B.T. Itc 29 ATEX y NBE-CP/96 para aparcamientos clasificados Zona 1 y 2</p> <p>30</p>
<p><b>THT/HATCH</b></p>  <p>Exteriores dinámicos con apertura motorizada equipados con extractor de tejado, para evacuación de humo en caso de incendio, 400°C/2h</p> <p>92</p>	<p><b>THT/IMP</b></p>  <p>Jet fans de gran alcance 400°C/2h, 300°C/2h y 200°C/2h, unidireccionales o reversibles, con diseño circular o octogonal</p> <p>97</p>	<p><b>TÚNEL JETFAN</b></p>  <p>Jet Fans de gran impulso, especialmente diseñados para ventilación de túneles. Certificados 400°C/2h, 300°C/2h y 200°C/2h</p> <p>101</p>	<p><b>CI</b></p>  <p>Ventiladores centrífugos de inducción 300°C/2h</p> <p>105</p>
<p><b>HTMF</b></p>  <p>Extractores de cubierta multifuncional 400°C/2h y 300°C/2h</p> <p>107</p>	<p><b>CJBDT</b></p>  <p>Unidades de extracción con caja aislada acústicamente, para trabajar inmersas en zonas de riesgo de incendios 400°C/2h y 300°C/2h</p> <p>115</p>	<p><b>CBDT</b></p>  <p>Extractores centrífugos de doble aspiración con motor directo, para trabajar inmersos en zonas de riesgo de incendio 400°C/2h y 300°C/2h, con posibilidad de motor monofásico</p> <p>115</p>	<p><b>TCR</b></p>  <p>Extractores centrífugos 400°C/2h y 300°C/2h con turbina a reacción</p> <p>119</p>
<p><b>CTMP</b></p>  <p>Extractores centrífugos 400°C/2h y 300°C/2h con turbina multipala</p> <p>122</p>	<p><b>CJS</b></p>  <p>Unidades de extracción 400°C/2h y 300°C/2h con tapas intercambiables</p> <p>125</p>	<p><b>CJMD</b></p>  <p>Unidades de extracción 400°C/2h y 300°C/2h con entrada y salida lineal</p> <p>128</p>	

## EXTERIOR

Instalación del ventilador exterior a la zona de riesgo de incendio

### TCR/R CJTCR/R



Extractor y unidades de extracción centrifugos 400°C/2h con turbina a reacción

132

### TCMP



Extractor centrifugo 400°C/2h con turbina multipala

137

### CJMP



Unidades de extracción 400°C/2h con turbina multipala

137

### CJTX-C



Unidades de extracción 400°C/2h, con motor interior a transmisión y tensor automático de correas

143

### CJSX



Unidades de extracción 400°C/2h, a transmisión con ventilador de simple aspiración

155

### CJSX-SILENT



Unidades de extracción 400°C/2h, a transmisión con ventilador de simple aspiración

162

### CSX



Extractores centrifugos 400 °C/2h para trabajar en el exterior de la zona de riesgo de incendios, accionados a transmisión con turbina a reacción

166

### CJSRX



Unidades de extracción 400 °C/2h para trabajar en el exterior de la zona de riesgo de incendios, accionados a transmisión con turbina a reacción

176

### CJLINE



Unidades de extracción 400°C/2h, con entrada y salida lineal

179

### CJEC



Cajas de extracción para cocinas 400°C/2h y motor de 2 velocidades

184

### CHT



Extractores centrifugos de tejado 400°C/2h, con salida de aire horizontal, sombrerete de aluminio

187

### CVT



Extractores centrifugos de tejado 400°C/2h, con salida de aire vertical, sombrerete de aluminio

187

## KIT SOBREPRESIÓN DE VIAS DE EVACUACIÓN



KIT DE SOBREPRESIÓN

KIT DE SOBREPRESIÓN CON VENTILADOR DE RESERVA

192

SOFTWARE DE SELECCIÓN



# NUEVAS HERRAMIENTAS PARA INGENIERIAS Y DEPARTAMENTOS TÉCNICOS

PREPARE INFORMES

**NUEVO**  
MÓDULO DE  
PROYECTOS

TÉCNICOS EN MINUTOS

## QUICKFAN SODECA SELECTOR



**MÓDULO DE PROYECTOS:** nueva función para preparar informes técnicos en minutos

- . Seleccione centenares de modelos en un solo paso
- . Cargue masivamente sus datos en Excel
- . Edite y gestione las fichas técnicas
- . Imprima el informe con índice y portada, edítelo o envíelo a otro QuickFan



BÚSQUEDA FÁCIL



INFORMES PERSONALIZABLES



SIEMPRE ACTUALIZADO



INFORMES EN MINUTOS

## 3D SODECA



VENTILADORES CAD 3D

40

FORMATOS DISPONIBLES

**MODELOS EN CAD 3D:**

- . Descárguese nuestros ventiladores en Cad 3D desde nuestra web
- . Elija entre más de 40 formatos Cad disponibles
- . Incluyendo Revit
- . Más de 2.000 modelos y configuraciones disponibles



SIEMPRE ACTUALIZADO



INFORMES EN MINUTOS



# CUMPLIMIENTO DE NORMAS

Los ventiladores y extractores de SODECA, cumplen con las siguientes normativas:

<b>CALIDAD</b>	
<b>ISO 9001:2008</b>	Sistemas de gestión de la calidad. Requisitos. Quality management systems -- Requirements
<b>ENSAYOS</b>	
<b>ISO 5801</b>	Ventiladores industriales. Ensayos de comportamiento en circuitos normalizados. Industrial fans -- Performance testing using standardized airways
<b>AMCA 210-07</b>	Ventiladores industriales. Métodos de ensayos de ventiladores y su representación de ensayos. Laboratory Methods of Testing Fans for Aerodynamic Performance Rating
<b>UNE-EN ISO 5801</b>	Ventiladores. Dispositivos e instalaciones para el ensayo de ventiladores.
<b>UNE-EN ISO 13350</b>	Ensayos de comportamiento de ventiladores de chorro. Industrial fans -- Performance testing of jet fans
<b>ISO 13348</b>	Industrial fans -- Tolerances, methods of conversion and technical data presentation
<b>VENTILADORES PARA ALTA TEMPERATURA</b>	
<b>EN 12101-3</b>	Sistemas de control de humos y calor. Parte 3: Especificaciones para aireadores extractores de humos y calor mecánicos. Smoke and heat control systems - Part 3: Specification for powered smoke and heat exhaust ventilators
<b>ACÚSTICA</b>	
<b>ISO 3744</b>	Acústica. Determinación de los niveles de potencia acústica de fuentes de ruido a partir de la presión acústica. Método de ingeniería para condiciones de campo libre sobre un plano reflectante. Acoustics -- Determination of sound power levels of noise sources using sound pressure -- Engineering method in an essentially free field over a reflecting plane
<b>EQUILIBRADO Y VIBRACIONES</b>	
<b>ISO 1940-1</b>	Vibraciones mecánicas. Calidad de equilibrado Mechanical vibration -- Balance quality requirements for rotors in a constant (rigid) state -- Part 1: Specification and verification of balance tolerances
<b>ISO 10816-1</b>	Vibraciones mecánicas. Evaluación de las vibraciones de máquinas Mechanical vibration -- Evaluation of machine vibration by measurements on non-rotating parts -- Part 1: General guidelines
<b>ISO 14694</b>	Ventiladores industriales. Especificaciones para equilibrado y niveles de vibración Industrial fans -- Specifications for balance quality and vibration levels
<b>SEGURIDAD (Declaración de Conformidad CE)</b>	
<b>EN ISO 12100</b>	Seguridad de las máquinas. Conceptos básicos, principios generales para el diseño. Parte 1: Terminología básica, metodología. Safety of machinery -- Basic concepts, general principles for design -- Part 1: Basic terminology, methodology
<b>EN ISO 12100</b>	Seguridad de las máquinas. Conceptos básicos, principios generales para el diseño. Parte 2: Principios técnicos. Safety of machinery -- Basic concepts, general principles for design -- Part 2: Technical principles
<b>UNE EN 60204-1</b>	Seguridad de las máquinas. Equipo eléctrico de las máquinas. Parte 1: Requisitos generales. Safety of machinery - Electrical equipment of machines - Part 1: General requirements
<b>ISO 13857</b>	Seguridad de máquinas. Distancias de seguridad para impedir que se alcancen zonas peligrosas con los miembros superiores e inferiores. Safety of machinery -- Safety distances to prevent danger zones being reached by upper and lower limbs
<b>UNE-EN ISO 12499</b>	Ventiladores industriales. Seguridad mecánica en los ventiladores Industrial fans -- Mechanical safety of fans -- Guarding
<b>DIRECTIVAS Y REGLAMENTOS</b>	
<b>Directiva 2006/42/CE</b>	Directiva de máquinas Machinery Directive
<b>Directiva 2006/95/CE</b>	Directiva de baja tensión Low Voltage Directive
<b>Directiva 2004/108/CE</b>	Directiva compatibilidad electromagnética EMC Directive
<b>Reglamento 305/2011</b>	Directiva productos de construcción Construction Products Directive CPR
<b>Directiva 2009/125/CE</b>	Directiva de requisitos de diseño ecológico para productos que utilizan energía. Ecodesign Requirements for Energy-related Products Directive
<b>EJECUCIONES ATEX</b>	
<b>Directiva ATEX 94/9/CE</b>	Aparatos y sistemas de protección para uso en atmósferas potencialmente explosivas Equipment and protective systems intended for use in potentially explosive atmospheres
<b>EN 14986</b>	Diseño de ventiladores para trabajar en atmósferas potencialmente explosivas. Design of fans working in potentially explosive atmospheres
<b>EN 13463-1</b>	Equipos no eléctricos destinados a atmósferas potencialmente explosivas. Parte 1: Requisitos y metodología básica. Non-electrical equipment for use in potentially explosive atmospheres - Part 1: Basic method and requirements
<b>EN 1127-1</b>	Atmósferas explosivas. Prevención y protección contra la explosión. Parte 1: Conceptos básicos y metodología. Explosive atmospheres - Explosion prevention and protection - Part 1: Basic concepts and methodology

## Evacuación de humo para: **APARCAMIENTOS**

Método de evacuación de humo mediante extractores certificados para trabajo con temperatura durante un tiempo determinado según su clasificación y certificación. Este método es aplicado habitualmente en edificios, centros comerciales, túneles, aparcamientos y otras construcciones de gran superficie y con grandes áreas abiertas, también en naves industriales de alto riesgo de incendios y extracciones de humos en cocinas industriales.



### VENTILADOR INMERSO

Instalación del ventilador inmerso en la zona de riesgo de incendio



### VENTILADOR EXTERIOR

Instalación del ventilador exterior a la zona de riesgo de incendio



### JET FAN

Instalación del Jet Fan en la zona de riesgo de incendio





## Evacuación de humo para: **COCINAS INDUSTRIALES**

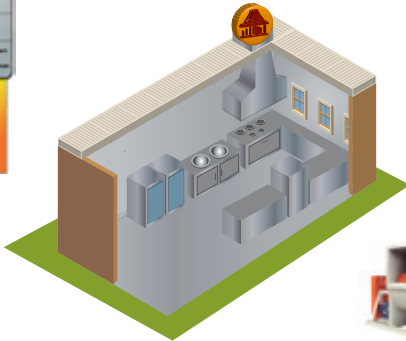

Extractores idóneos para aplicación en cocinas industriales

Para la correcta aplicación de la norma:

- C.T.E. Código Técnico de la Edificación. Documento Básico SI de seguridad en caso de incendio. Documento Básico HS de salubridad.

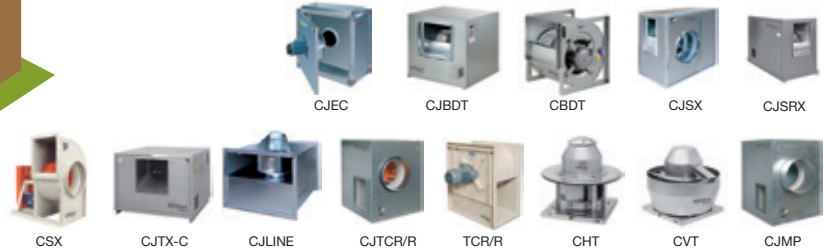

## Evacuación de humo para: **NAVES INDUSTRIALES**



Extractores idóneos para aplicación en naves industriales

Para la correcta aplicación de la norma:

- Reglamento de Seguridad Contra Incendios en Establecimientos Industriales, Real Decreto 2267/2004, EN-23585:2004 Seguridad Contra Incendios



## Control de humo por presión diferencial para: **VÍAS DE EVACUACIÓN**



Método de control de humo por Sobrepresión, este sistema consiste en la presurización mediante inyección de aire en habitáculos que son utilizados como vías de escape de personas en caso de incendio, tales como cajas de escalera, pasillos, corredores, elevadores, etc. Sobre todo en edificios de altura con gran ocupación. Este método está basado en el control del humo mediante la velocidad del aire y la barrera artificial que crea la sobre presión del aire sobre el humo, para que éste no pueda entrar en las vías de escape. De acuerdo de la norma EN-12101-6-2006

KIT SOBREPRESIÓN DE ESCALERAS PARA EQUIPOS TRIFÁSICOS



KIT SOBREPRESIÓN DE ESCALERAS Para equipos monofásicos



KIT SOBREPRESIÓN CON VENTILADOR DE RESERVA



## Evacuación de humo para: **TÚNELES**



TÚNEL JET FAN

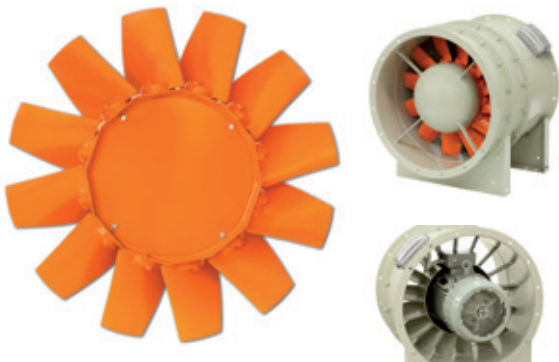

### VENTILACIÓN DE TÚNELES

Los túneles juegan una parte importante en el desarrollo global de las economías, contribuyendo a la creación de grandes infraestructuras y mejora en las comunicaciones urbanas. Mayoritariamente la ventilación de túneles se hace extensiva a los túneles de carretera, los túneles de metro y los túneles de vías férreas.

Los requisitos de seguridad y calidad de aire, son los aspectos más importantes en las demandas de ventilación de túneles, tanto en nuevas construcciones como en la mejora y adecuación de viejas infraestructuras.

Aunque el principal objetivo de la ventilación de túneles, es la seguridad y el control de humos en caso de incendio, juega también una parte importante el control de las emisiones de los gases de combustión de los vehículos



### ULTIMAS INSTALACIONES DE TÚNELES

Referencia:  
**TUNEL VARIANTE DE RENTERIA (GUIPUZCOA)**  
Ventilación longitudinal del túnel, utilizando ventiladores tipo Túnel Jetfan certificados 400°C/2h. Modelo THT/IMP-C-125-4T

Referencia:  
**TUNEL PLAZA DE LUGO EN A CORUÑA**  
Ventilación longitudinal del túnel, utilizando ventiladores tipo Túnel Jetfan certificados 400°C/2h. Modelo THT/IMP-C-125-4T

Referencia:  
**TUNEL PLAZA ESPAÑA EN FERROL**  
Ventilación longitudinal del túnel, utilizando ventiladores tipo Túnel Jetfan certificados 400°C/2h. Modelo THT/IMP-C-100-4T

Referencia:  
**LÍNEA 9 METRO BARCELONA**  
Ventilación diferentes estaciones y pozos de ventilación, utilizando diferentes tamaños de ventiladores certificados 400°C/2h de la serie THT

Referencia:  
**TUNELES AUTOVIA C-17. RIPOLL**  
Ventilación longitudinal del túnel, utilizando ventiladores tipo Túnel Jetfan certificados 400°C/2h.

## SISTEMAS DE VENTILACIÓN DE TÚNELES

Básicamente existen tres formas de realizar la ventilación de los túneles:

**Ventilación Longitudinal:** El flujo de aire, tiene la misma dirección que el eje del túnel. El aire entra por una de las bocas del túnel y sale por la otra boca. Se utiliza en túneles de no demasiada longitud, de hasta 2km en condiciones severas y hasta 5km si las condiciones no son muy severas o si el sentido de circulación es unidireccional. Esta ventilación se puede dividir en varios tramos con extracciones e inyecciones de aire intermedias, en este caso el sistema de ventilación puede utilizarse para longitudes de túneles mayores, de hasta 10 km.

*Ventilación Longitudinal*

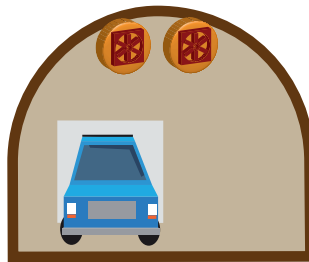
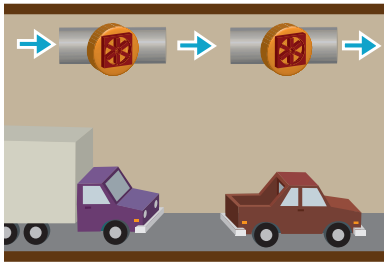

En la práctica habitualmente se utilizan ventiladores reversibles, para poder adaptar el sentido de circulación del aire, en función de las necesidades del tráfico, pudiendo así compensar el efecto pistón producido por el paso de los vehículos por el túnel.

**Ventilación Transversal:** La dirección del flujo de aire es transversal al eje del túnel. El aire limpio es inyectado uniformemente a lo largo de todo el túnel por medio de uno o varios canales, y el aire extraído es aspirado también a lo largo de todo el túnel y de una forma uniforme. Con el fin de limitar las pérdidas de carga, estos conductos están divididos transversalmente en tramos independientes de entre 1000 y 1600 m. El mejor sistema consiste en insuflar aire fresco por los laterales de la calzada de circulación y extraer el aire viciado por la parte superior del túnel.

*Ventilación Transversal*

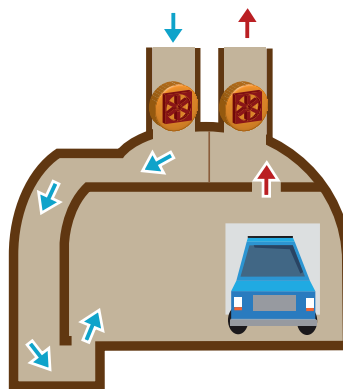
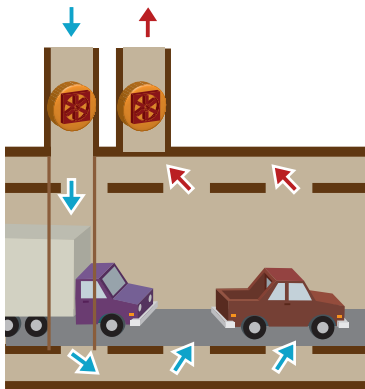

Este sistema está considerado el más seguro y confortable, es independiente de las influencias meteorológicas, de la velocidad del viento en las bocas de entrada y de la velocidad del aire inducida por los vehículos, a pesar de ello este sistema es el más caro tanto de inversión, como de coste de explotación.

Suele utilizarse en túneles de carretera de longitudes medias y altas con altas cargas de tráfico.

**Ventilación Semi-transversal:** El aire fresco y limpio se inyecta en dirección transversal al eje del túnel, mediante un canal paralelo a lo largo de todo el túnel, y el aire viciado sale por las dos bocas del túnel. Este sistema presenta la ventaja de

*Ventilación Semi-transversal*

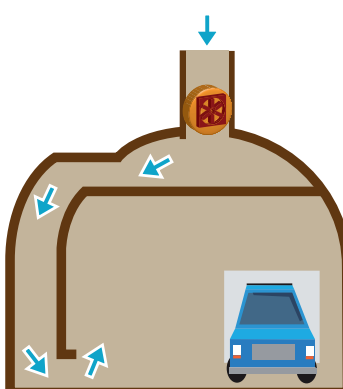
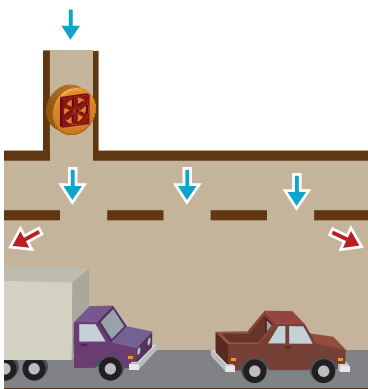

poder realizar un sistema reversible, pudiéndose en caso de incendio, invertir el sentido de circulación de aire y de esta manera extraer los humos y gases del incendio por la parte superior del túnel.

Se utiliza en túneles de carretera de longitudes medias con cargas de tráfico no muy altas.



# THT



Detalle THT/Atex

## THT: Extractores helicoidales tubulares 400°C/2h, 300°C/2h y 200°C/2h

Extractores helicoidales tubulares para trabajar inmersos en zonas de riesgo de incendios.

### Ventilador:

- Envolvere tubular en chapa de acero.
- Hélices de ángulo variable en fundición de aluminio.
- Homologación según norma EN 12101-3:2002/AC:2006. Con certificaciones N°: 0370-CPR-0305 (F400), 0370-CPR-0973 (F300), 0370-CPR-0514 (F200).
- Dirección aire motor-hélice



### Motor:

- Motores clase H para uso continuo S1 y uso emergencia S2. Con rodamientos a bolas, protección IP55 y 1 ó 2 velocidades según modelo
- Trifásicos 230/400V.-50Hz. (hasta 4CV.) y 400/690V.-50Hz. (potencias superiores a 4CV.)
- Temperatura máxima del aire a transportar: Servicio S1 -20°C+ 40°C en continuo. Servicio S2 200°C/2h, 300°C/2h, 400°C/2h

- THT/CL: ventiladores helicoidales tubulares con carcasa larga equipada con trampilla de inspección
- THT/ATEX: ventiladores helicoidales con carcasa corta, con certificación ATEX Ex II3G para zona 2 (sólo 400°C/2h y 300°C/2h). Carcasa equipada con banda de aluminio según norma EN-14986:2007.
- THT/CL/ATEX: ventiladores helicoidales con carcasa larga, con trampilla de inspección y certificación ATEX, Ex II3G para Zona 2 (sólo 400°C/2h y 300°C/2h). Carcasa equipada con banda de aluminio según norma EN-14986:2007.

### Acabado:

- Anticorrosivo en resina de poliéster polimerizada a 190°C, previo desengrase con tratamiento nanotecnológico libre de fosfatos

### Bajo demanda:

- Dirección aire hélice-motor
- Hélices reversibles 100%
- Carcasa larga /CL: incremento del 5%

### Versiones disponibles

- THT: ventiladores helicoidales tubulares con carcasa corta

## Código de pedido

De tamaño 40 a tamaño 100

**THT — 56 — 4T — 2 — F-400**

THT: Extractores helicoidales tubulares 400°C/2h, 300°C/2h y 200°C/2h

Diámetro hélice en cm.

Número de polos motor

T=Trifásico

Potencia motor (c.v.)

F-200: Homologación 200°C/2h

F-300: Homologación. Probado para 300°C/2h.

F-400: Homologación 400°C/2h

CAT3: Con certificación ATEX Categoría 3 Ex II3G

THT/ATEX: Extractores helicoidales tubulares 400°C/2h, 300°C/2h y 200°C/2h con certificación ATEX

- 2=2900 r/min. 50 Hz
- 4=1400 r/min. 50 Hz
- 6=900 r/min. 50 Hz
- 8=750 r/min. 50 Hz
- 12=500 r/min. 50 Hz

THT/CL: Extractores helicoidales tubulares 400°C/2h, 300°C/2h y 200°C/2h con carcasa larga, equipada con trampilla de inspección

De tamaño 125 a tamaño 160

**THT — 125 — 4T / 9-25 — 10° — F-400**

THT: Extractores helicoidales tubulares 400°C/2h, 300°C/2h y 200°C/2h

Diámetro hélice en cm.

Número de polos motor

T=Trifásico

Número de palas

Potencia motor (c.v.)

Angulo inclinación palas

F-200: Homologación 200°C/2h

F-300: Homologación 300°C/2h

F-400: Homologación 400°C/2h

CAT3: Con certificación ATEX Categoría 3 Ex II3G

THT/CL: Extractores helicoidales tubulares 400°C/2h, 300°C/2h y 200°C/2h con carcasa larga, equipada con trampilla de inspección

- 2=2900 r/min. 50 Hz
- 4=1400 r/min. 50 Hz
- 6=900 r/min. 50 Hz
- 8=750 r/min. 50 Hz
- 12=500 r/min. 50 Hz

## Características técnicas

Modelo	Velocidad (r/min)	Intensidad máxima admisible (A)			Potencia instalada (kW)	Ángulo inclinación palas (°)	Caudal máximo (m³/h)	Nivel presión sonora dB(A)	Peso aprox. (Kg)	
		230V	400V	690V					Larga	Corta
THT-40-2T-1,5	2880	4,70	2,70		1,10	20	7050	76	33	31
THT-40-2/4T-1,5	2900 / 1450		2,90 / 1,10		1,10 / 0,25	20	7050 / 3525	76 / 61	34	32
THT-40-2T-2	2880	5,90	3,40		1,50	24	7950	77	35	33
THT-40-2/4T-2	2940 / 1460		4,40 / 1,40		1,50 / 0,37	24	7950 / 3975	77 / 62	35	33
THT-40-4T-0,75	1420	2,90	1,70		0,55	32	4800	64	32	29
THT-40-6T-0,75	930	3,30	1,90		0,55	32	3150	53	37	34
THT-40-6/12T-0,75	940 / 460		2,10 / 0,90		0,55 / 0,09	32	3150 / 1575	53 / 38	41	38
THT-45-2T-2	2880	5,90	3,40		1,50	16	9400	78	38	34
THT-45-2/4T-2	2940 / 1460		4,40 / 1,40		1,50 / 0,37	16	9400 / 4700	78 / 63	37	34
THT-45-2T-3	2900	8,70	5,00		2,20	22	11350	80	39	36
THT-45-2/4T-3	2930 / 1450		5,70 / 1,80		2,20 / 0,60	22	11350 / 5675	80 / 65	39	36
THT-45-4T-0,75	1420	2,90	1,70		0,55	36	7450	68	34	30
THT-45-6T-0,75	930	3,30	1,90		0,55	30	4450	55	38	35
THT-45-6/12T-0,75	940 / 460		2,10 / 0,90		0,55 / 0,09	30	4450 / 2225	55 / 40	42	39
THT-50-2T-4	2880	11,20	6,50		3,00	16	13900	82	49	42
THT-50-2/4T-4	2920 / 1440		6,70 / 2,00		3,00 / 0,80	16	13900 / 6950	82 / 67	51	44
THT-50-2T-5,5	2890	16,00	9,30		4,00	20	15900	83	65	57
THT-50-2/4T-6	2930 / 1450		10,00 / 3,20		4,50 / 1,30	20	15900 / 7950	83 / 68	67	60
THT-50-4T-1	1430	3,80	2,20		0,75	28	9750	69	37	33
THT-50-6T-0,75	930	3,30	1,90		0,55	32	7000	57	40	36
THT-50-6/12T-0,75	940 / 460		2,10 / 0,90		0,55 / 0,09	32	7000 / 3500	57 / 42	44	40
THT-56-2T-5,5	2890	16,00	9,30		4,00	16	18800	88	69	60
THT-56-2/4T-6	2930 / 1450		10,00 / 3,20		4,50 / 1,30	16	18800 / 9400	88 / 72	71	63
THT-56-2T-12	2950		19,20	11,09	9,00	30	27200	89	147	139
THT-56-2/4T-12	2920 / 1440		18,50 / 5,50		9,00 / 2,50	30	27200 / 13600	89 / 74	137	129
THT-56-4T-1	1430	3,80	2,20		0,75	22	11250	73	45	40
THT-56-4T-1,5	1420	4,70	2,70		1,10	30	13600	74	44	40
THT-56-4/8T-1,5	1440 / 710		2,90 / 1,40		1,10 / 0,25	30	13600 / 6800	74 / 59	48	43
THT-56-4T-2	1425	6,60	3,80		1,50	36	15050	75	48	43
THT-56-4/8T-2	1415 / 715		3,60 / 1,50		1,50 / 0,30	36	15050 / 7525	75 / 60	59	55
THT-56-6T-0,75	930	3,30	1,90		0,55	38	10150	62	44	39
THT-56-6/12T-0,75	940 / 460		2,10 / 0,90		0,55 / 0,09	38	10150 / 5075	62 / 47	48	43
THT-63-2T-12	2950		19,20	11,09	9,00	18	32300	90	161	143
THT-63-2/4T-12	2920 / 1440		18,50 / 5,50		9,00 / 2,50	18	32300 / 16150	90 / 75	151	133
THT-63-2T-22	2960		32,30	18,65	16,00	28	39950	91	188	170
THT-63-2/4T-22	2960 / 1480		32,30 / 8,90		16,00 / 4,00	28	39950 / 19975	91 / 76	188	170
THT-63-4T-1	1430	3,80	2,20		0,75	14	15200	73	49	43
THT-63-4T-1,5	1420	4,70	2,70		1,10	20	17800	74	51	45
THT-63-4/8T-1,5	1440 / 710		2,90 / 1,40		1,10 / 0,25	20	17800 / 8900	74 / 59	55	49
THT-63-4T-2	1425	6,60	3,80		1,50	24	19300	75	55	49
THT-63-4/8T-2	1415 / 715		3,60 / 1,50		1,50 / 0,30	24	19300 / 9650	75 / 60	70	60
THT-63-4T-3	1435	9,20	5,30		2,20	32	22150	76	64	54
THT-63-4/8T-3	1415 / 715		5,20 / 1,90		2,20 / 0,45	32	22150 / 11075	76 / 61	77	66
THT-63-4T-4	1430	11,40	6,60		3,00	38	24250	77	73	63
THT-63-4/8T-4	1420 / 705		6,90 / 2,30		3,00 / 0,60	38	24250 / 12125	77 / 62	86	77
THT-63-6T-0,75	930	3,30	1,90		0,55	28	13600	65	51	45
THT-63-6/12T-0,75	940 / 460		2,10 / 0,90		0,55 / 0,09	28	13600 / 6800	65 / 50	55	49
THT-63-6T-1	940	4,40	2,60		0,75	38	15900	66	54	48
THT-63-6/12T-1	935 / 430		2,50 / 1,03		0,75 / 0,15	38	15900 / 7950	66 / 51	61	55
THT-71-4T-1,5	1420	4,70	2,70		1,10	12	19500	78	58	52
THT-71-4/8T-1,5	1440 / 710		2,90 / 1,40		1,10 / 0,25	12	19500 / 9750	78 / 63	61	56
THT-71-4T-2	1425	6,60	3,80		1,50	14	20900	79	61	56
THT-71-4/8T-2	1415 / 715		3,60 / 1,50		1,50 / 0,30	14	20900 / 10450	79 / 64	76	67

## Características técnicas

Modelo	Velocidad (r/min)	Intensidad máxima admisible (A)			Potencia instalada (kW)	Ángulo inclinación palas (°)	Caudal máximo (m³/h)	Nivel presión sonora dB(A)	Peso aprox. (Kg)	
		230V	400V	690V					Larga	Corta
THT-71-4T-3	1435	9,20	5,30		2,20	22	25100	81	70	61
THT-71-4/8T-3	1415 / 715		5,20 / 1,90		2,20 / 0,45	22	25100 / 12550	81 / 66	82	74
THT-71-4T-4	1430	11,40	6,60		3,00	28	27500	82	79	70
THT-71-4/8T-4	1420 / 705		6,90 / 2,30		3,00 / 0,60	28	27500 / 13750	82 / 67	92	83
THT-71-6T-0,75	930	3,30	1,90		0,55	20	16100	67	57	52
THT-71-6/12T-0,75	940 / 460		2,10 / 0,90		0,55 / 0,09	20	16100 / 8050	67 / 52	61	56
THT-71-6T-1	940	4,40	2,60		0,75	26	17300	68	61	55
THT-71-6/12T-1	935 / 430		2,50 / 1,03		0,75 / 0,15	26	17300 / 8650	68 / 53	67	62
THT-71-6T-1,5	945	6,40	3,70		1,10	34	19950	69	69	61
THT-71-6/12T-1,5	940 / 450		3,30 / 1,20		1,10 / 0,18	34	19950 / 9975	69 / 54	77	69
THT-80-4T-3	1435	9,20	5,30		2,20	12	25450	82	79	69
THT-80-4/8T-3	1415 / 715		5,20 / 1,90		2,20 / 0,45	12	25450 / 12725	82 / 67	91	82
THT-80-4T-4	1430	11,40	6,60		3,00	16	30250	83	88	78
THT-80-4/8T-4	1420 / 705		6,90 / 2,30		3,00 / 0,60	16	30250 / 15125	83 / 68	101	92
THT-80-4T-5,5	1440		8,40	4,85	4,00	18	32750	84	94	85
THT-80-4/8T-5,5	1450 / 720		9,40 / 3,50		4,00 / 0,80	18	32750 / 16375	84 / 69	127	118
THT-80-6T-1,5	945	6,40	3,70		1,10	18	21450	72	78	69
THT-80-6/12T-1,5	940 / 450		3,30 / 1,20		1,10 / 0,18	18	21450 / 10725	72 / 57	86	77
THT-80-6T-2	945	7,40	4,30		1,50	26	25950	73	87	78
THT-80-6/12T-2	960 / 470		4,30 / 1,70		1,50 / 0,25	26	25950 / 12975	73 / 58	91	82
THT-80-6T-3	950	10,30	5,90		2,20	32	29950	74	94	84
THT-80-6/12T-3	940 / 470		5,60 / 2,20		2,20 / 0,37	32	29950 / 14975	74 / 59	100	91
THT-80-8T-0,75	700	3,60	2,10		0,55	20	17550	70	71	62
THT-80-8T-1	710	4,80	2,80		0,75	28	20650	71	78	69
THT-90-4T-4	1430	11,40	6,60		3,00	8	33600	87	110	93
THT-90-4/8T-4	1420 / 705		6,90 / 2,30		3,00 / 0,60	8	33600 / 16800	87 / 72	124	106
THT-90-4T-5,5	1440		8,40	4,85	4,00	12	38900	89	117	99
THT-90-4/8T-5,5	1450 / 720		9,40 / 3,50		4,00 / 0,80	12	38900 / 19450	89 / 74	150	132
THT-90-4T-7,5	1430		11,50	6,64	5,50	18	46150	91	143	126
THT-90-4/8T-7,5	1455 / 725		12,80 / 4,60		5,50 / 1,10	18	46150 / 23075	91 / 76	157	140
THT-90-4T-10	1460		17,70	10,22	7,50	22	50150	92	154	137
THT-90-4/8T-9	1455 / 725		15,50 / 5,50		6,70 / 1,50	22	50150 / 25075	92 / 77	157	140
THT-90-6T-2	945	7,40	4,30		1,50	16	28800	77	110	92
THT-90-6/12T-2	960 / 470		4,30 / 1,70		1,50 / 0,25	16	28800 / 14400	77 / 62	114	96
THT-90-6T-3	950	10,30	5,90		2,20	24	34000	78	116	99
THT-90-6/12T-3	940 / 470		5,60 / 2,20		2,20 / 0,37	24	34000 / 17000	78 / 63	123	105
THT-90-6T-4	945	15,00	8,70		3,00	30	38900	79	142	124
THT-90-6/12T-4	970 / 475		8,90 / 3,50		3,00 / 0,55	30	38900 / 19450	79 / 64	143	126
THT-90-8T-1	710	4,80	2,80		0,75	18	22900	71	100	84
THT-90-8T-2	700	9,00	5,20		1,50	30	29500	73	116	99
THT-90-8T-3	705	13,20	7,60		2,20	32	30850	74	134	116
THT-100-4T-7,5	1430		11,50	6,64	5,50	10	46850	92	151	131
THT-100-4/8T-7,5	1455 / 725		12,80 / 4,60		5,50 / 1,10	10	46850 / 23425	92 / 77	165	145
THT-100-4T-10	1460		17,70	10,22	7,50	16	57400	93	162	142
THT-100-4/8T-9	1455 / 725		15,50 / 5,50		6,70 / 1,50	14	54700 / 27350	93 / 78	165	145
THT-100-4T-15	1455		23,00	13,28	11,00	22	66300	94	215	195
THT-100-4/8T-15	1470 / 725		23,20 / 8,70		11,00 / 2,80	22	66300 / 33150	94 / 79	215	195
THT-100-4T-20	1460		29,00	16,74	15,00	28	76150	95	230	210
THT-100-4/8T-20	1470 / 725		31,70 / 11,80		15,00 / 3,80	28	76150 / 38075	95 / 80	230	210
THT-100-6T-3	950	10,30	5,90		2,20	16	37600	82	124	105
THT-100-6/12T-3	940 / 470		5,60 / 2,20		2,20 / 0,37	16	37600 / 18800	82 / 67	130	112
THT-100-6T-4	945	15,00	8,70		3,00	20	41150	83	150	130
THT-100-6/12T-4	970 / 475		8,90 / 3,50		3,00 / 0,55	20	41150 / 20575	83 / 68	151	131
THT-100-6T-5,5	970		11,00	6,35	4,00	26	47800	84	162	142
THT-100-6/12T-5,5	970 / 480		11,30 / 4,20		4,00 / 0,65	26	47800 / 23900	84 / 69	162	142

## Características técnicas

Modelo	Velocidad (r/min)	Intensidad máxima admisible (A)			Potencia instalada (kW)	Ángulo inclinación palas (°)	Caudal máximo (m³/h)	Nivel presión sonora dB(A)	Peso aprox. (Kg)	
		230V	400V	690V					Larga	Corta
THT-100-8T-2	700	9,00	5,20		1,50	22	32900	77	124	105
THT-100-8T-3	705	13,20	7,60		2,20	30	39400	77	142	122
THT-100-8T-4	710	15,60	9,00		3,00	32	40550	78	162	142
THT-125-4T/3-10	1460		17,70	10,22	7,50	8	58550	88	243	210
THT-125-4/8T/3-9	1455 / 725		15,50 / 5,50		6,70 / 1,50	8	58550 / 29275	88 / 68	243	210
THT-125-4T/3-15	1455		23,00	13,28	11,00	14	77750	89	294	266
THT-125-4/8T/3-15	1470 / 725		23,20 / 8,70		11,00 / 2,80	14	77750 / 38875	89 / 69	294	266
THT-125-4T/3-20	1460		29,00	16,74	15,00	18	91450	91	309	281
THT-125-4/8T/3-20	1470 / 725		31,70 / 11,80		15,00 / 3,80	18	91450 / 45725	91 / 71	309	281
THT-125-4T/3-25	1465		37,00	21,36	18,50	20	98350	91	377	334
THT-125-4T/3-30	1470		42,00	24,25	22,00	24	110350	92	391	348
THT-125-4/8T/3-27	1470 / 735		38,00 / 13,00		20,00 / 4,00	22	104400 / 52200	92 / 71	391	348
THT-125-4/8T/3-37	1475 / 735		51,00 / 20,60		27,00 / 6,00	28	120700 / 60350	93 / 72	472	429
THT-125-4T/3-40	1475		58,00	33,49	30,00	30	125000	93	472	429
THT-125-4/8T/3-40	1480 / 735		62,00 / 27,00		30,00 / 10,00	30	125000 / 62500	93 / 72	618	562
THT-125-4T/6-20	1460		29,00	16,74	15,00	10	78600	89	318	290
THT-125-4/8T/6-20	1470 / 725		31,70 / 11,80		15,00 / 3,80	10	78600 / 39300	89 / 68	318	290
THT-125-4/8T/6-22	1470 / 735		31,80 / 12,00		16,50 / 3,30	12	85600 / 42800	89 / 69	303	275
THT-125-4T/6-25	1465		37,00	21,36	18,50	14	92550	90	386	343
THT-125-4/8T/6-27	1470 / 735		38,00 / 13,00		20,00 / 4,00	16	98850 / 49425	90 / 69	400	357
THT-125-4T/6-30	1470		42,00	24,25	22,00	16	98850	90	400	357
THT-125-4/8T/6-37	1475 / 735		51,00 / 20,60		27,00 / 6,00	20	110900 / 55450	90 / 70	481	437
THT-125-4T/6-40	1475		58,00	33,49	30,00	22	117450	92	481	437
THT-125-4/8T/6-40	1480 / 735		62,00 / 27,00		30,00 / 10,00	22	117450 / 58725	92 / 71	627	571
THT-125-4T/6-50	1480		73,00	42,15	37,00	26	131050	93	529	473
THT-125-4T/9-25	1465		37,00	21,36	18,50	10	79650	88	395	352
THT-125-4/8T/9-22	1470 / 735		31,80 / 12,00		16,50 / 3,30	8	71150 / 35575	88 / 69	312	284
THT-125-4T/9-30	1470		42,00	24,25	22,00	12	88300	89	409	366
THT-125-4/8T/9-27	1470 / 735		38,00 / 13,00		20,00 / 4,00	12	88300 / 44150	89 / 70	409	366
THT-125-4/8T/9-37	1475 / 735		51,00 / 20,60		27,00 / 6,00	16	104050 / 52025	90 / 70	490	446
THT-125-4T/9-40	1475		58,00	33,49	30,00	16	104050	91	490	446
THT-125-4/8T/9-40	1480 / 735		62,00 / 27,00		30,00 / 10,00	16	104050 / 52025	91 / 71	636	580
THT-125-4T/9-50	1480		73,00	42,15	37,00	20	118400	93	538	482
THT-125-6T/3-4	945	15,00	8,70		3,00	12	46750	79	230	197
THT-125-6/12T/3-4	970 / 475		8,90 / 3,50		3,00 / 0,55	12	46750 / 23375	79 / 64	232	199
THT-125-6T/3-5,5	970		11,00	6,35	4,00	16	55400	80	242	209
THT-125-6/12T/3-5,5	970 / 480		11,30 / 4,20		4,00 / 0,65	16	55400 / 27700	80 / 65	243	210
THT-125-6T/3-7,5	970		14,00	8,08	5,50	22	68400	81	249	216
THT-125-6/12T/3-7,5	970 / 480		13,70 / 5,60		5,50 / 1,00	22	68400 / 34200	81 / 66	263	230
THT-125-6T/3-10	960		18,60	10,74	7,50	28	79150	83	274	246
THT-125-6/12T/3-10	970 / 480		19,00 / 8,00		7,50 / 1,40	28	79150 / 39575	83 / 68	294	266
THT-125-6T/3-15	955		26,00	15,01	11,00	34	87150	84	304	276
THT-125-6/12T/3-15	970 / 470		28,50 / 13,00		11,00 / 2,00	34	87150 / 43575	84 / 69	309	281
THT-125-6T/3-20	950		35,50	20,50	15,00	38	91650	85	377	334
THT-125-6/12T/3-24	970 / 480		36,00 / 14,50		17,50 / 3,50	38	91650 / 45825	85 / 70	472	429
THT-125-6T/6-5,5	970		11,00	6,35	4,00	10	51500	77	251	218
THT-125-6/12T/6-5,5	970 / 480		11,30 / 4,20		4,00 / 0,65	10	51500 / 25750	77 / 62	252	219
THT-125-6T/6-7,5	970		14,00	8,08	5,50	14	60650	77	258	225
THT-125-6/12T/6-7,5	970 / 480		13,70 / 5,60		5,50 / 1,00	14	60650 / 30325	77 / 62	272	239
THT-125-6T/6-10	960		18,60	10,74	7,50	20	72650	79	283	255
THT-125-6/12T/6-10	970 / 480		19,00 / 8,00		7,50 / 1,40	20	72650 / 36325	79 / 64	303	275
THT-125-6T/6-15	955		26,00	15,01	11,00	26	85850	81	313	285
THT-125-6/12T/6-15	970 / 470		28,50 / 13,00		11,00 / 2,00	26	85850 / 42925	81 / 66	318	290
THT-125-6T/6-20	950		35,50	20,50	15,00	30	92850	82	386	343
THT-125-6/12T/6-24	970 / 480		36,00 / 14,50		17,50 / 3,50	34	99650 / 49825	82 / 67	481	437

### Características técnicas

Modelo	Velocidad (r/min)	Intensidad máxima admisible (A)			Potencia instalada (kW)	Ángulo inclinación palas (°)	Caudal máximo (m³/h)	Nivel presión sonora dB(A)	Peso aprox. (Kg)	
		230V	400V	690V					Larga	Corta
THT-125-6T/9-10	960		18,60	10,74	7,50	14	63500	78	292	264
THT-125-6/12T/9-10	970 / 480		19,00 / 8,00		7,50 / 1,40	14	63500 / 31750	78 / 63	312	284
THT-125-6T/9-15	955		26,00	15,01	11,00	20	77550	81	322	294
THT-125-6/12T/9-15	970 / 470		28,50 / 13,00		11,00 / 2,00	20	77550 / 38775	81 / 66	327	299
THT-125-6T/9-20	950		35,50	20,50	15,00	26	92950	84	395	352
THT-125-6/12T/9-24	970 / 480		36,00 / 14,50		17,50 / 3,50	30	98500 / 49250	84 / 69	490	446
THT-140-6T/3-5,5	970		11,00	6,35	4,00	8	51300	83	279	242
THT-140-6T/3-7,5	970		14,00	8,08	5,50	14	68150	84	287	250
THT-140-6T/3-10	960		18,60	10,74	7,50	18	80200	85	339	300
THT-140-6T/3-15	955		26,00	15,01	11,00	24	96700	86	356	317
THT-140-6T/3-20	950		35,50	20,50	15,00	30	109600	88	436	386
THT-140-6T/6-7,5	970		14,00	8,08	5,50	8	62800	84	297	260
THT-140-6T/6-10	960		18,60	10,74	7,50	10	68900	85	349	310
THT-140-6T/6-15	955		26,00	15,01	11,00	16	86650	86	366	327
THT-140-6T/6-20	950		35,50	20,50	15,00	22	102950	87	445	396
THT-140-6T/6-25	975		34,40	19,86	18,50	24	108750	88	497	448
THT-140-6T/6-30	975		41,40	23,90	22,00	28	119050	89	506	457
THT-140-6T/9-10	960		18,60	10,74	7,50	8	62350	84	358	319
THT-140-6T/9-15	955		26,00	15,01	11,00	12	77400	86	375	336
THT-140-6T/9-20	950		35,50	20,50	15,00	16	91200	87	455	405
THT-140-6T/9-25	975		34,40	19,86	18,50	20	103800	88	506	458
THT-140-6T/9-30	975		41,40	23,90	22,00	22	111000	89	515	467
THT-140-6T/9-40	985		54,20	31,29	30,00	28	128800	91	673	611
THT-140-6T/9-50	980		66,40	38,34	37,00	32	135750	92	751	696
THT-140-8T/3-3	705	13,20	7,60		2,20	12	47400	78	279	242
THT-140-8T/3-4	710	15,60	9,00		3,00	16	56200	78	287	250
THT-140-8T/3-5,5	710		13,00	7,51	4,00	20	65350	79	337	298
THT-140-8T/3-7,5	710		15,10	8,72	5,50	26	77400	81	346	307
THT-140-8T/3-10	715		20,60	11,89	7,50	32	85900	82	357	318
THT-140-8T/6-3	705	13,20	7,60		2,20	8	47600	78	289	252
THT-140-8T/6-4	710	15,60	9,00		3,00	10	52250	79	297	260
THT-140-8T/6-5,5	710		13,00	7,51	4,00	14	61500	80	347	308
THT-140-8T/6-7,5	710		15,10	8,72	5,50	18	69550	81	356	317
THT-140-8T/6-10	715		20,60	11,89	7,50	24	82700	82	367	328
THT-140-8T/6-15	725		21,70	12,53	11,00	30	94150	83	453	404
THT-140-8T/9-4	710	15,60	9,00		3,00	8	47250	79	306	269
THT-140-8T/9-5,5	710		13,00	7,51	4,00	10	52950	79	356	317
THT-140-8T/9-7,5	710		15,10	8,72	5,50	14	64400	81	365	326
THT-140-8T/9-10	715		20,60	11,89	7,50	18	73900	82	376	337
THT-140-8T/9-15	725		21,70	12,53	11,00	26	94300	83	463	413
THT-140-8T/9-20	725		32,90	18,99	15,00	32	102900	86	516	468
THT-160-6T/3-10	960		18,60	10,74	7,50	8	76600	83	412	358
THT-160-6T/3-15	955		26,00	15,01	11,00	12	93350	85	429	375
THT-160-6T/3-20	950		35,50	20,50	15,00	18	119700	86	522	453
THT-160-6T/3-25	975		34,40	19,86	18,50	22	136600	87	574	504
THT-160-6T/3-30	975		41,40	23,90	22,00	24	144550	89	583	513
THT-160-6T/6-15	955		26,00	15,01	11,00	8	93750	85	440	386
THT-160-6T/6-20	950		35,50	20,50	15,00	12	112000	86	532	463
THT-160-6T/6-25	975		34,40	19,86	18,50	14	121100	87	584	515
THT-160-6T/6-30	975		41,40	23,90	22,00	16	129350	88	593	524
THT-160-6T/6-40	985		54,20	31,29	30,00	22	153700	89	768	669
THT-160-6T/6-50	980		66,40	38,34	37,00	26	170800	91	842	757
THT-160-6T/9-15	955		26,00	15,01	11,00	8	93100	85	450	396
THT-160-6T/9-20	950		35,50	20,50	15,00	8	93100	86	542	473
THT-160-6T/9-25	975		34,40	19,86	18,50	10	104250	87	594	525



**Características técnicas**

Modelo	Velocidad (r/min)	Intensidad máxima admisible (A)			Potencia instalada (kW)	Ángulo inclinación palas (°)	Caudal máximo (m³/h)	Nivel presión sonora dB(A)	Peso aprox. (Kg)	
		230V	400V	690V					Larga	Corta
THT-160-6T/9-30	975		41,40	23,90	22,00	14	126800	88	603	534
THT-160-6T/9-40	985		54,20	31,29	30,00	18	145500	89	778	679
THT-160-6T/9-50	980		66,40	38,34	37,00	20	154950	90	852	768
THT-160-6T/9-60	985		84,50	48,79	45,00	24	176750	91	1067	968
THT-160-6T/9-75	985		100,00	57,74	55,00	28	192300	92	1112	1013
THT-160-8T/3-4	710	15,60	9,00		3,00	8	58050	77	356	304
THT-160-8T/3-5,5	710		13,00	7,51	4,00	12	70750	79	410	356
THT-160-8T/3-7,5	710		15,10	8,72	5,50	16	83900	80	419	365
THT-160-8T/3-10	715		20,60	11,89	7,50	20	97550	81	430	376
THT-160-8T/3-15	725		21,70	12,53	11,00	26	115550	83	530	461
THT-160-8T/6-5,5	710		13,00	7,51	4,00	8	71050	77	421	367
THT-160-8T/6-7,5	710		15,10	8,72	5,50	10	77950	79	430	376
THT-160-8T/6-10	715		20,60	11,89	7,50	14	91800	80	441	387
THT-160-8T/6-15	725		21,70	12,53	11,00	18	103800	82	540	471
THT-160-8T/6-20	725		32,90	18,99	15,00	24	123050	83	594	525
THT-160-8T/6-25	730		34,90	20,15	18,50	28	134700	84	741	642
THT-160-8T/9-7,5	710		15,10	8,72	5,50	8	70550	79	440	386
THT-160-8T/9-10	715		20,60	11,89	7,50	10	79000	80	451	397
THT-160-8T/9-15	725		21,70	12,53	11,00	14	96100	82	550	481
THT-160-8T/9-20	725		32,90	18,99	15,00	18	110300	83	604	535
THT-160-8T/9-25	730		34,90	20,15	18,50	22	125600	84	751	652
THT-160-8T/9-30	730		41,10	23,73	22,00	26	140750	85	776	677
THT-160-8T/9-40	730		56,30	32,50	30,00	32	153550	86	837	753

**Características acústicas**

Los valores indicados, se determinan mediante medidas de nivel de presión y potencia sonora en dB(A) obtenidas en campo libre a una distancia equivalente a dos veces la envergadura del ventilador más el diámetro de la hélice, con un mínimo de 1,5 mts.

Espectro de potencia sonora Lw(A) en dB(A) por banda de frecuencia en Hz

Modelo	63	125	250	500	1000	2000	4000	8000	Modelo	63	125	250	500	1000	2000	4000	8000
40-2-1,5	48	69	76	81	84	80	73	62	63-4-3	53	70	78	83	85	82	77	67
40-4-1,5 (2V)	33	54	61	66	69	65	58	47	63-8-3 (2V)	38	55	63	68	70	67	62	52
40-2-2	49	70	77	82	85	81	74	63	63-4-4	54	71	79	84	86	83	78	68
40-4-2 (2V)	34	55	62	67	70	66	59	48	63-8-4 (2V)	39	56	64	69	71	68	63	53
40-4-0,75	36	57	64	69	72	68	61	50	63-6-0,75	42	60	68	73	75	72	65	56
40-6	25	46	53	58	61	57	50	39	63-12-0,75 (2V)	27	43	51	56	58	55	48	37
40-12 (2V)	10	31	38	43	46	42	35	24	63-6-1	43	62	70	75	77	74	67	57
45-2-2	50	71	78	83	86	82	75	64	63-12-1 (2V)	28	45	53	58	60	57	50	42
45-4-2 (2V)	35	56	63	68	71	67	60	49	71-4-1,5	54	74	82	87	89	86	79	69
45-2-3	52	73	80	85	88	84	77	66	71-8-1,5 (2V)	38	58	66	71	73	70	63	54
45-4-3 (2V)	37	58	65	70	73	69	62	51	71-4-2	53	73	81	86	88	85	78	70
45-4-0,75	40	61	68	73	76	72	65	54	71-8-2 (2V)	38	58	66	71	73	70	63	55
45-6	27	48	55	60	63	59	52	41	71-4-3	58	72	80	85	87	84	77	71
45-12 (2V)	12	33	40	45	48	44	37	26	71-8-3 (2V)	43	57	65	70	72	69	62	56
50-2-4	57	77	85	90	92	89	82	71	71-4-4	59	73	81	86	88	85	78	72
50-4-4 (2V)	42	62	70	75	77	74	67	56	71-8-4 (2V)	44	58	66	71	73	70	63	57
50-2-5,5	58	78	86	91	93	90	83	72	71-6-0,75	44	63	72	74	76	73	66	55
50-2-6	58	78	86	91	93	90	83	72	71-12-0,75 (2V)	29	44	52	57	59	56	49	38
50-4-6 (2V)	43	63	71	76	78	75	68	57	71-6-1	45	65	73	75	77	74	67	56
50-4-1	44	64	72	77	79	76	69	58	71-12-1 (2V)	30	46	54	59	61	58	51	40
50-6	32	52	60	65	67	64	57	46	71-6-1,5	46	66	71	76	78	75	68	57
50-12 (2V)	17	37	45	50	52	49	42	31	71-12-1,5 (2V)	31	46	54	59	61	58	51	40
56-2-5,5	63	83	91	96	98	95	88	77	80-4-3	57	77	85	90	92	89	82	73
56-2-6	63	83	91	96	98	95	88	77	80-8-3 (2V)	42	62	70	75	77	74	67	58
56-4-6 (2V)	48	68	76	81	83	80	73	62	80-4-4	56	76	84	89	91	88	81	74
56-2-12	64	84	92	97	99	96	89	78	80-8-4 (2V)	41	61	69	74	76	73	66	59
56-4-12 (2V)	49	69	77	82	84	81	74	63	80-4-5,5	56	76	84	89	91	88	81	70
56-4-1	48	68	76	81	83	80	73	62	80-8-5,5 (2V)	40	60	68	73	75	72	65	59
56-4-1,5	49	69	77	82	84	81	74	63	80-6-1,5	49	66	74	79	81	78	71	60
56-8-1,5 (2V)	34	54	62	67	69	66	59	48	80-12-1,5 (2V)	34	49	57	62	64	61	54	43
56-4-2	50	70	78	83	85	82	75	64	80-6-2	50	67	75	80	82	79	72	61
56-8-2 (2V)	35	55	63	68	70	67	60	49	80-12-2 (2V)	35	50	58	63	65	62	55	44
56-6	37	57	65	70	72	69	62	51	80-6-3	51	68	76	81	83	80	73	62
56-12 (2V)	22	42	50	55	57	54	47	36	80-12-3 (2V)	36	51	59	64	66	63	56	45
63-2-12	67	87	95	100	102	99	92	81	80-8-0,75	47	60	68	73	75	72	65	54
63-4-12 (2V)	52	72	80	85	87	84	77	66	80-8-1	48	61	69	74	76	73	66	55
63-2-22	68	88	96	101	103	100	93	82	90-4-4	61	82	89	94	97	93	86	79
63-4-22 (2V)	53	73	81	86	88	85	78	67	90-8-4 (2V)	46	67	74	79	82	78	71	64
63-4-1	50	70	78	83	85	82	75	64	90-4-5,5	60	81	88	93	96	92	85	74
63-4-1,5	48	68	76	81	83	80	73	65	90-8-5,5 (2V)	45	66	73	78	81	77	70	59
63-8-1,5 (2V)	33	53	61	66	68	65	58	50	90-4-7,5	59	80	87	92	95	91	84	73
63-4-2	52	68	76	81	83	80	73	66	90-8-7,5 (2V)	43	64	71	76	79	75	68	57
63-8-2 (2V)	37	53	61	66	68	65	58	51	90-4-10	58	79	86	91	94	90	83	72

**Características acústicas**

Espectro de potencia sonora Lw(A) en dB(A) por banda de frecuencia en Hz

Modelo	63	125	250	500	1000	2000	4000	8000	Modelo	63	125	250	500	1000	2000	4000	8000
90-4-9	58	79	86	91	94	90	83	72	125-12/6-10 (2V)	47	56	69	72	73	70	59	55
90-8-9 (2V)	43	64	71	76	79	75	68	57	125-6/6-15	64	73	86	89	90	87	76	72
90-6-2	49	70	77	82	85	81	74	63	125-12/6-15 (2V)	49	58	71	74	75	72	61	57
90-12-2 (2V)	32	53	60	65	68	64	57	46	125-6/6-20	65	74	87	90	91	88	77	73
90-6-3	56	70	77	82	85	81	74	63	125-6/6-24	65	74	87	90	91	88	77	73
90-12-3 (2V)	41	53	60	65	68	64	57	46	125-12/6-24 (2V)	50	59	72	75	76	73	62	58
90-6-4	57	72	79	84	87	83	76	65	125-6/9-10	58	68	83	87	86	85	74	70
90-12-4 (2V)	42	55	62	67	70	66	59	48	125-12/9-10 (2V)	43	53	68	72	71	70	59	55
90-8-1	42	63	70	75	78	74	67	56	125-6/9-15	61	71	86	90	89	88	77	73
90-8-2	51	66	73	78	81	77	70	59	125-12/9-15 (2V)	46	56	71	75	74	73	62	58
90-8-3	52	66	73	78	81	77	70	59	125-6/9-20	64	74	89	93	92	91	80	76
100-4-7.5	64	84	92	97	99	96	89	78	125-6/9-24	64	74	89	93	92	91	80	76
100-8-7.5 (2V)	49	69	77	82	84	81	74	63	125-12/9-24 (2V)	49	59	74	78	77	76	65	61
100-4-10	62	82	90	95	97	94	87	76	140-6/3-5,5	69	79	87	92	91	90	77	73
100-4-9	63	83	91	96	98	95	88	77	140-6/3-7,5	70	80	88	93	92	91	78	74
100-8-9 (2V)	48	68	76	81	83	80	73	62	140-6/3-10	71	81	89	94	93	92	79	79
100-4-15	61	81	89	94	96	93	86	75	140-6/3-15	72	82	90	95	94	93	80	80
100-8-15 (2V)	46	66	74	79	81	78	71	60	140-6/3-20	74	84	92	97	96	95	82	82
100-4-20	63	83	91	96	98	95	88	77	140-6/3-7,5	68	83	92	94	91	85	77	73
100-8-20 (2V)	47	67	75	80	82	79	72	61	140-6/6-10	69	84	93	95	92	86	78	74
100-6-3	61	72	80	85	87	84	77	66	140-6/6-15	70	85	94	96	93	87	79	75
100-12-3 (2V)	46	55	63	68	70	67	60	49	140-6/6-20	71	86	95	97	94	88	80	76
100-6-4	64	72	80	85	87	84	77	66	140-6/6-25	72	87	96	98	95	89	81	77
100-12-4 (2V)	48	55	63	68	70	67	60	49	140-6/6-30	73	88	97	99	96	90	82	78
100-6-5,5	64	73	81	86	88	85	78	67	140-6/9-10	66	84	93	92	91	87	78	73
100-12-5,5 (2V)	49	56	64	69	71	68	61	50	140-6/9-15	68	86	95	94	93	89	80	75
100-8-2	56	66	74	79	81	78	71	60	140-6/9-20	69	87	96	95	94	90	81	76
100-8-3	57	68	76	81	83	80	73	62	140-6/9-25	70	88	97	96	95	91	82	77
100-8-4	58	68	76	81	83	80	73	62	140-6/9-30	71	89	98	97	96	92	83	78
125-4/3-10	70	76	88	98	98	94	86	82	140-6/9-40	73	91	100	99	98	94	85	80
125-4/3-9	70	76	88	98	98	94	86	82	140-6/9-50	74	92	101	100	99	95	86	81
125-8/3-9 (2V)	50	56	68	78	78	74	66	62	140-8/3-3	64	74	82	87	86	85	72	67
125-4/3-15	71	77	89	99	99	95	87	83	140-8/3-4	64	74	82	87	86	85	72	67
125-8/3-15 (2V)	51	57	69	79	79	75	67	63	140-8/3-5,5	65	75	83	88	87	86	73	68
125-4/3-20	73	79	91	101	101	97	89	85	140-8/3-7,5	67	77	85	90	89	88	75	70
125-8/3-20 (2V)	53	59	71	81	81	77	69	65	140-8/3-10	68	78	86	91	90	89	76	71
125-4/3-25	73	79	91	101	101	97	89	85	140-8/6-3	63	75	84	88	86	80	70	67
125-4/3-30	74	80	92	102	102	98	90	86	140-8/6-4	64	76	85	89	87	81	71	68
125-4/3-27	74	80	92	102	102	98	90	86	140-8/6-5,5	65	77	86	90	88	82	72	69
125-8/3-27 (2V)	53	59	71	81	81	77	69	65	140-8/6-7,5	66	78	87	91	89	83	73	70
125-4/3-37	75	81	93	103	103	99	91	87	140-8/6-10	67	79	88	92	90	84	74	71
125-8/3-37 (2V)	54	60	72	82	82	78	70	66	140-8/6-15	68	80	89	93	91	85	75	72
125-4/3-40	75	81	93	103	103	99	91	87	140-8/9-4	62	73	84	89	87	83	73	68
125-8/3-40 (2V)	54	60	72	82	82	78	70	66	140-8/9-5,5	62	73	84	89	87	83	73	68
125-4/6-20	67	75	91	98	100	95	89	85	140-8/9-7,5	64	75	86	91	89	85	75	70
125-8/6-20 (2V)	46	54	70	77	79	74	68	64	140-8/9-10	65	76	87	92	90	86	76	71
125-4/6-22	67	75	91	98	100	95	89	85	140-8/9-15	66	77	88	93	91	87	77	72
125-8/6-22 (2V)	47	55	71	78	80	75	69	65	140-8/9-20	69	80	91	96	94	90	80	75
125-4/6-25	68	76	92	99	101	96	90	86	160-6/3-10	69	79	87	92	91	90	77	72
125-4/6-27	68	76	92	99	101	96	90	86	160-6/3-15	71	81	89	94	93	92	79	74
125-8/6-27 (2V)	47	55	71	78	80	75	69	65	160-6/3-20	72	82	90	95	94	93	80	75
125-4/6-30	68	76	92	99	101	96	90	86	160-6/3-25	73	83	91	96	95	94	81	76
125-4/6-37	68	76	92	99	101	96	90	86	160-6/3-30	75	85	93	98	97	96	83	78
125-8/6-37 (2V)	48	56	72	79	81	76	70	66	160-6/6-15	69	84	93	95	92	86	78	74
125-4/6-40	70	78	94	101	103	98	92	88	160-6/6-20	70	85	94	96	93	87	79	75
125-8/6-40 (2V)	49	57	73	80	82	77	71	67	160-6/6-25	71	86	95	97	94	88	80	76
125-4/6-50	71	79	95	102	104	99	93	89	160-6/6-30	72	87	96	98	95	89	81	77
125-4/9-25	66	74	91	97	98	93	88	84	160-6/6-40	73	88	97	99	96	90	82	78
125-4/9-22	66	74	91	97	98	93	88	84	160-6/6-50	75	90	99	101	98	92	84	80
125-8/9-22 (2V)	47	55	72	78	79	74	69	65	160-6/9-15	67	85	94	93	92	88	79	74
125-4/9-30	67	75	92	98	99	94	89	85	160-6/9-20	68	86	95	94	93	89	80	75
125-4/9-27	67	75	92	98	99	94	89	85	160-6/9-25	69	87	96	95	94	90	81	76
125-8/9-27 (2V)	48	56	73	79	80	75	70	66	160-6/9-30	70	88	97	96	95	91	82	77
125-4/9-37	68	76	93	99	100	95	90	86	160-6/9-40	71	89	98	97	96	92	83	78
125-8/9-37 (2V)	48	56	73	79	80	75	70	66	160-6/9-50	72	90	99	98	97	93	84	79
125-4/9-40	69	77	94	100	101	96	91	87	160-6/9-60	73	91	100	99	98	94	85	80
125-8/9-40 (2V)	49	57	74	80	81	76	71	67	160-6/9-75	74	92	101	100	99	95	86	81
125-4/9-50	71	79	96	102	103	98	93	89	160-8/3-4	63	73	81	86	85	84	71	66
125-6/3-4	65	73	85	89	87	82	73	69	160-8/3-5,5	65	75	83	88	87	86	73	68
125-12/3-4 (2V)	50	58	70	74	72	67	58	54	160-8/3-7,5	66	76	84	89	88	87	74	69
125-6/3-5,5	66	74	86	90	88	83	74	70	160-8/3-10	67	77	85	90	89	88	75	70
125-12/3-5,5 (2V)	51	59	71	75	73	68	59	55	160-8/3-15	69	79	87	92	91	90	77	72
125-6/3-7,5	67	75	87	91	89	84	75	71	160-8/6-5,5	61	76	85	87	84	78	70	66
125-12/3-7,5 (2V)	52	60	72	76	74	69	60	56	160-8/6-7,5	63	78	87	89	86	80	72	68
125-6/3-10	69	77	89	93	91	86	77	73	160-8/6-10	64	79	88	90	87	81	73	69
125-12/3-10 (2V)	54	62	74	78	76	71	62	58	160-8/6-15	66	81	90	92	89	83	75	71
125-6/3-15	70	78	90	94	92	87	78	74	160-8/6-20	67	82	91	93	90	84	76	72
125-12/3-15 (2V)	55	63	75	79	77	72	63	59	160-8/6-25	68	83	92	94	91	85	77	73
125-6/3-20	71	79	91	95	93	88	79	75	160-8/9-7,5	61	79	88	87	86	82	73	68
125-6/3-24	71	79	91	95	93	88	79	75	160-8/9-10	62	80	89	88	87	83	74	69
125-12/3-24 (2V)	56	64	76	80	78	73	64	60	160-8/9-15	64	82	91	90	89</			

Dimensiones mm

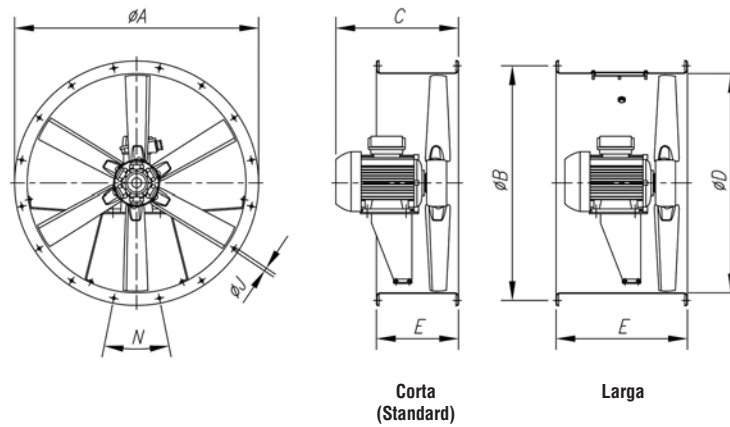

Corta (Standard)

Larga

C (Consultar tamaño motor según potencia)

Modelo	ØA	ØB	C (Consultar tamaño motor según potencia)														ØD	E		ØJ	N			
			80	90S	90L	100	112	132S	132M	132ML	160M	160L	180M	180L	200L	225		250	280			Corta	Larga	
THT-40	490	450	348	364	389	-	-	-	-	-	-	-	-	-	-	-	-	-	-	410	250	400	12	8x45°
THT-45	540	500	348	364	389	-	-	-	-	-	-	-	-	-	-	-	-	-	-	460	250	400	12	8x45°
THT-50	600	560	339	364	389	-	-	-	-	-	-	-	-	-	-	-	-	-	-	514	250	400	12	12x30°
THT-50	600	560	-	-	-	419	438	-	-	-	-	-	-	-	-	-	-	-	-	514	250	500	12	12x30°
THT-56	660	620	275	364	389	-	-	-	-	-	-	-	-	-	-	-	-	-	-	560	250	400	12	12x30°
THT-56	660	620	-	-	-	416	432	480	518	-	-	-	-	-	-	-	-	-	-	560	250	500	12	12x30°
THT-56	660	620	-	-	-	-	-	-	-	620	-	-	-	-	-	-	-	-	-	560	250	650	12	12x30°
THT-63	730	690	339	359	389	-	-	-	-	-	-	-	-	-	-	-	-	-	-	640	250	400	12	12x30°
THT-63	730	690	-	-	-	420	437	-	-	-	-	-	-	-	-	-	-	-	-	640	250	500	12	12x30°
THT-63	730	690	-	-	-	-	-	539	577	-	-	-	-	-	-	-	-	-	-	640	250	650	12	12x30°
THT-63	730	690	-	-	-	-	-	-	-	630	674	-	-	-	-	-	-	-	-	640	350	650	12	12x30°
THT-71	810	770	366	379	404	-	-	-	-	-	-	-	-	-	-	-	-	-	-	710	300	430	12	16x22°30'
THT-71	810	770	-	-	-	438	433	-	-	-	-	-	-	-	-	-	-	-	-	710	300	500	12	16x22°30'
THT-80	900	860	-	-	422	456	472	-	-	-	-	-	-	-	-	-	-	-	-	800	300	500	12	16x22°30'
THT-80	900	860	-	-	-	-	-	515	-	-	-	-	-	-	-	-	-	-	-	800	300	600	12	16x22°30'
THT-90	1015	970	-	-	-	466	482	525	565	590	-	-	-	-	-	-	-	-	-	900	350	600	15	16x22°30'
THT-100	1115	1070	-	-	-	-	482	525	565	590	-	-	-	-	-	-	-	-	-	1000	450	600	15	16x22°30'
THT-100	1115	1070	-	-	-	-	-	-	-	695	695	-	-	-	-	-	-	-	-	1000	450	700	15	16x22°30'
THT-125	1365	1320	-	-	-	-	-	561	601	-	-	-	-	-	-	-	-	-	-	1250	500	700	15	20x18°
THT-125	1365	1320	-	-	-	-	-	-	-	626	695	695	-	-	-	-	-	-	-	1250	500	700	15	20x18°
THT-125	1365	1320	-	-	-	-	-	-	-	-	-	740	740	860	-	-	-	-	-	1250	500	900	15	20x18°
THT-125	1365	1320	-	-	-	-	-	-	-	-	-	-	-	907	-	-	-	-	-	1250	500	1000	15	20x18°
THT-125	1365	1320	-	-	-	-	-	-	-	-	-	-	-	-	987	-	-	-	-	1250	600	1000	15	20x18°
THT-125	1365	1320	-	-	-	-	-	-	-	-	-	-	-	-	-	1077	-	-	-	1250	600	1200	15	20x18°
THT-140	1515	1470	-	-	-	-	-	532	570	-	-	-	-	-	-	-	-	-	-	1400	400	650	15	20x18°
THT-140	1515	1470	-	-	-	-	-	-	-	650	700	-	-	-	-	-	-	-	-	1400	450	700	15	20x18°
THT-140	1515	1470	-	-	-	-	-	-	-	-	-	-	765	-	-	-	-	-	-	1400	550	900	15	20x18°
THT-140	1515	1470	-	-	-	-	-	-	-	-	-	-	-	825	-	-	-	-	-	1400	550	900	15	20x18°
THT-140	1515	1470	-	-	-	-	-	-	-	-	-	-	-	-	910	-	-	-	-	1400	550	1000	15	20x18°
THT-140	1515	1470	-	-	-	-	-	-	-	-	-	-	-	-	-	985	-	-	-	1400	600	1000	15	20x18°
THT-160	1735	1680	-	-	-	-	-	532	570	-	-	-	-	-	-	-	-	-	-	1600	400	650	19	24x15°
THT-160	1735	1680	-	-	-	-	-	-	-	700	-	-	-	-	-	-	-	-	-	1600	450	700	19	24x15°
THT-160	1735	1680	-	-	-	-	-	-	-	-	-	765	-	-	-	-	-	-	-	1600	550	900	19	24x15°
THT-160	1735	1680	-	-	-	-	-	-	-	-	-	-	-	825	-	-	-	-	-	1600	550	1000	19	24x15°
THT-160	1735	1680	-	-	-	-	-	-	-	-	-	-	-	-	910	-	-	-	-	1600	550	1000	19	24x15°
THT-160	1735	1680	-	-	-	-	-	-	-	-	-	-	-	-	-	985	-	-	-	1600	600	1000	19	24x15°
THT-160	1735	1680	-	-	-	-	-	-	-	-	-	-	-	-	-	-	1190	-	-	1600	700	1000	19	24x15°

\* Versión estándar suministrada en carcasa corta. Bajo demanda carcasa larga con trampilla de inspección.

Tamaños constructivos motores según potencia (1velocidad)

	CV																				
	0,75	1	1,5	2	3	4	5,5	7,5	10	12	15	20	22	25	30	40	50	60	75	100	
2T (3000 r/min)	80	80	80	90S	90L	100LB	112M	132S	132S	132MA	160M	160M	160L	180M	180L	200L	225S/M	225S/M	250S/M	280S/M	-
4T (1500 r/min)	90S	90S	90S	90L	100LA	100LB	112M	132S	132M	-	160M	160L	-	180M	180L	200L	225S/M	225S/M	250S/M	280S/M	-
6T (1000 r/min)	90S	90S	90L	100L	112M	132S	132MA	132MB	160M	-	160L	180L	-	200MLA	200MLB	225SMB	250S/M	280S/M	280S/M	-	-
8T (750 r/min)	90L	100LA	100L	112M	132S	132M	160MA	160M	160L	-	180L	200MLA	-	225SMA	225SMB	250SMA	280S/M	280S/M	-	-	-

Tamaños constructivos motores según potencia (2velocidad)

	CV																						
	0,75	1	1,5	2	3	4	5,5	6	7,5	8	9	10	12	15	18	20	22	24	27	37	38	40	
2/4(3000/1500 r/min)	-	-	90S	90S	90L	100L	-	112M	-	-	132M	-	160MA	-	160M	-	160L	-	-	-	-	-	-
4/8(1500/750 r/min)	-	-	90S	100L	100LA	100LC	132S	-	132S	132S	-	132M	-	160M	-	160L	180M	180M	180L	200MLA	200L	225S/M	-
6/12(1000/500 r/min)	90L	100L	100LB	112M	112M	132MC	160M	160M	160LB	160LB	-	160LB	-	200MLC	160L	200M	-	250SMB	22S/M	-	225S/M	-	

Curvas Características

Ver curvas características en la página 33.



# CJTHT/PLUS

## Unidades de extracción helicoidales 400°C/2h, 300°C/2h y 200°C/2h con atenuador acústico integrado



Atenuador acústico integrado de alta eficacia

Unidades de extracción con caja aislada acústicamente, para trabajar inmersas en zonas de riesgo de incendios 400°C/2h. y atenuador acústico, con núcleo central incorporado.

**Ventilador:**

- Estructura en chapa de acero galvanizado, con aislamiento térmico y acústico
- Hélices orientables en fundición de aluminio
- Atenuador acústico con material fonoabsorbente, especialmente estudiado para obtener una importante reducción de ruido. Unidades aptas para trabajo vertical y horizontal. Homologación según norma EN 12101-3:2002/AC:2006, con certificación N°: 0370-CPR-0312
- Dirección aire motor-hélice

**Motor:**

- Motores clase H, uso continuo S1 y uso emergencia S2, con rodamientos a bolas, protección IP55, de 1 ó 2 velocidades según modelo
- Trifásicos 230/400V.-50Hz.(hasta 4CV) y 400/690V.-50Hz.(potencias superiores a 4CV)
- Temperatura máxima del aire a transportar: Servicio S1 -20°C+ 40°C en continuo, Servicio S2 200°C/2h, 300°C/2h, 400°C/2h

**Acabado:**

- Anticorrosivo en chapa de acero galvanizado

**Bajo demanda:**

- Hélices reversibles 100%



### Código de pedido

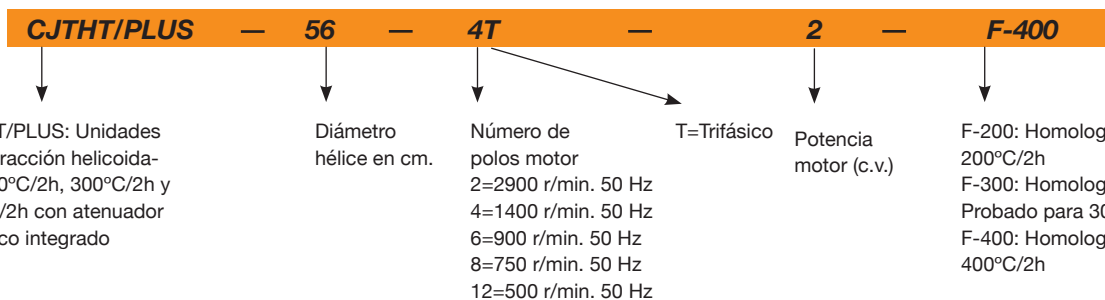

### Características técnicas

Modelo	Velocidad (r/min)	Intensidad máxima admisible (A)			Potencia instalada (kW)	Ángulo inclinación palas (°)	Caudal máximo (m³/h)	Nivel presión sonora dB(A)	Peso aprox. (Kg)
		230V	400V	690V					
CJTHT-40-2/4T-1,5/PLUS	2900 / 1450		2,90 / 1,10		1,10 / 0,25	20	7050 / 3525	71 / 56	53
CJTHT-40-2/4T-2/PLUS	2940 / 1460		4,40 / 1,40		1,50 / 0,37	24	7950 / 3975	72 / 57	54
CJTHT-40-4T-0,75/PLUS	1420	2,90	1,70		0,55	32	4800	59	47
CJTHT-40-6T-0,75/PLUS	930	3,30	1,90		0,55	32	3150	49	52
CJTHT-40-6/12T-0,75/PLUS	940 / 460		2,10 / 0,90		0,55 / 0,09	32	3150 / 1575	49 / 34	56
CJTHT-45-2/4T-2/PLUS	2940 / 1460		4,40 / 1,40		1,50 / 0,37	16	9400 / 4700	73 / 58	56
CJTHT-45-2/4T-3/PLUS	2930 / 1450		5,70 / 1,80		2,20 / 0,60	22	11350 / 5675	75 / 60	58
CJTHT-45-4T-0,75/PLUS	1420	2,90	1,70		0,55	36	7450	63	49
CJTHT-45-6T-0,75/PLUS	930	3,30	1,90		0,55	30	4450	51	53
CJTHT-45-6/12T-0,75/PLUS	940 / 460		2,10 / 0,90		0,55 / 0,09	30	4450 / 2225	51 / 36	58
CJTHT-50-2/4T-4/PLUS	2920 / 1440		6,70 / 2,00		3,00 / 0,80	16	13900 / 6950	77 / 60	65

## Características técnicas

Modelo	Velocidad (r/min)	Intensidad máxima admisible (A)			Potencia instalada (kW)	Ángulo inclinación palas (°)	Caudal máximo (m³/h)	Nivel presión sonora dB(A)	Peso aprox. (Kg)
		230V	400V	690V					
CJTHT-50-2/4T-6/PLUS	2930 / 1450		10,00 / 3,20		4,50 / 1,30	20	15900 / 7950	78 / 63	81
CJTHT-50-4T-1/PLUS	1430	3,80	2,20		0,75	28	9750	64	51
CJTHT-50-6T-0,75/PLUS	930	3,30	1,90		0,55	32	7000	53	55
CJTHT-50-6/12T-0,75/PLUS	940 / 460		2,10 / 0,90		0,55 / 0,09	32	7000 / 3500	53 / 38	59
CJTHT-56-2/4T-6/PLUS	2930 / 1450		10,00 / 3,20		4,50 / 1,30	16	18800 / 9400	83 / 67	90
CJTHT-56-2/4T-12/PLUS	2920 / 1440		18,50 / 5,50		9,00 / 2,50	30	27200 / 13600	84 / 69	153
CJTHT-56-4T-1/PLUS	1430	3,80	2,20		0,75	22	11250	68	62
CJTHT-56-4T-1,5/PLUS	1420	4,70	2,70		1,10	30	13600	69	64
CJTHT-56-4/8T-1,5/PLUS	1440 / 710		2,90 / 1,40		1,10 / 0,25	30	13600 / 6800	69 / 52	68
CJTHT-56-4/8T-2/PLUS	1425	6,60	3,80		1,50	36	15050	70	68
CJTHT-56-4/8T-2/PLUS	1415 / 715		3,60 / 1,50		1,50 / 0,30	36	15050 / 7525	70 / 53	80
CJTHT-56-6T-0,75/PLUS	930	3,30	1,90		0,55	38	10150	58	64
CJTHT-56-6/12T-0,75/PLUS	940 / 460		2,10 / 0,90		0,55 / 0,09	38	10150 / 5075	58 / 41	68
CJTHT-63-4T-1/PLUS	1430	3,80	2,20		0,75	14	15200	68	66
CJTHT-63-4T-1,5/PLUS	1420	4,70	2,70		1,10	20	17800	69	69
CJTHT-63-4/8T-1,5/PLUS	1440 / 710		2,90 / 1,40		1,10 / 0,25	20	17800 / 8900	69 / 52	72
CJTHT-63-4/8T-2/PLUS	1425	6,60	3,80		1,50	24	19300	70	72
CJTHT-63-4/8T-2/PLUS	1415 / 715		3,60 / 1,50		1,50 / 0,30	24	19300 / 9650	70 / 53	84
CJTHT-63-4T-3/PLUS	1435	9,20	5,30		2,20	32	22150	72	78
CJTHT-63-4/8T-3/PLUS	1415 / 715		5,20 / 1,90		2,20 / 0,45	32	22150 / 11075	72 / 54	90
CJTHT-63-4T-4/PLUS	1430	11,40	6,60		3,00	38	24250	73	87
CJTHT-63-4/8T-4/PLUS	1420 / 705		6,90 / 2,30		3,00 / 0,60	38	24250 / 12125	73 / 55	101
CJTHT-63-6T-0,75/PLUS	930	3,30	1,90		0,55	28	13600	61	68
CJTHT-63-6/12T-0,75/PLUS	940 / 460		2,10 / 0,90		0,55 / 0,09	28	13600 / 6800	61 / 44	72
CJTHT-63-6T-1/PLUS	940	4,40	2,60		0,75	38	15900	62	72
CJTHT-63-6/12T-1/PLUS	935 / 430		2,50 / 1,03		0,75 / 0,15	38	15900 / 7950	62 / 45	78
CJTHT-71-4T-1,5/PLUS	1420	4,70	2,70		1,10	12	19500	74	85
CJTHT-71-4/8T-1,5/PLUS	1440 / 710		2,90 / 1,40		1,10 / 0,25	12	19500 / 9750	74 / 59	89
CJTHT-71-4T-2/PLUS	1425	6,60	3,80		1,50	14	20900	75	89
CJTHT-71-4/8T-2/PLUS	1415 / 715		3,60 / 1,50		1,50 / 0,30	14	20900 / 10450	75 / 60	101
CJTHT-71-4T-3/PLUS	1435	9,20	5,30		2,20	22	25100	76	95
CJTHT-71-4/8T-3/PLUS	1415 / 715		5,20 / 1,90		2,20 / 0,45	22	25100 / 12550	76 / 62	107
CJTHT-71-4T-4/PLUS	1430	11,40	6,60		3,00	28	27500	77	104
CJTHT-71-4/8T-4/PLUS	1420 / 705		6,90 / 2,30		3,00 / 0,60	28	27500 / 13750	77 / 63	118
CJTHT-71-6T-0,75/PLUS	930	3,30	1,90		0,55	20	16100	63	85
CJTHT-71-6/12T-0,75/PLUS	940 / 460		2,10 / 0,90		0,55 / 0,09	20	16100 / 8050	63 / 49	89
CJTHT-71-6T-1/PLUS	940	4,40	2,60		0,75	26	17300	64	88
CJTHT-71-6/12T-1/PLUS	935 / 430		2,50 / 1,03		0,75 / 0,15	26	17300 / 8650	64 / 49	95
CJTHT-71-6T-1,5/PLUS	945	6,40	3,70		1,10	34	19950	65	94
CJTHT-71-6/12T-1,5/PLUS	940 / 450		3,30 / 1,20		1,10 / 0,18	34	19950 / 9975	65 / 50	102
CJTHT-80-4T-3/PLUS	1435	9,20	5,30		2,20	12	25450	78	103
CJTHT-80-4/8T-3/PLUS	1415 / 715		5,20 / 1,90		2,20 / 0,45	12	25450 / 12725	78 / 63	115
CJTHT-80-4T-4/PLUS	1430	11,40	6,60		3,00	16	30250	79	112
CJTHT-80-4/8T-4/PLUS	1420 / 705		6,90 / 2,30		3,00 / 0,60	16	30250 / 15125	79 / 64	125
CJTHT-80-4T-5,5/PLUS	1440		8,40	4,85	4,00	18	32750	80	118
CJTHT-80-4/8T-5,5/PLUS	1450 / 720		9,40 / 3,50		4,00 / 0,80	18	32750 / 16375	80 / 65	153
CJTHT-80-6T-1,5/PLUS	945	6,40	3,70		1,10	18	21450	68	102
CJTHT-80-6/12T-1,5/PLUS	940 / 450		3,30 / 1,20		1,10 / 0,18	18	21450 / 10725	68 / 53	110
CJTHT-80-6T-2/PLUS	945	7,40	4,30		1,50	26	25950	69	111
CJTHT-80-6/12T-2/PLUS	960 / 470		4,30 / 1,70		1,50 / 0,25	26	25950 / 12975	69 / 54	115
CJTHT-80-6T-3/PLUS	950	10,30	5,90		2,20	32	29950	70	118
CJTHT-80-6/12T-3/PLUS	940 / 470		5,60 / 2,20		2,20 / 0,37	32	29950 / 14975	70 / 55	124
CJTHT-80-8T-0,75/PLUS	700	3,60	2,10		0,55	20	17550	67	95

**Características técnicas**

Modelo	Velocidad (r/min)	Intensidad máxima admisible (A)			Potencia instalada (kW)	Ángulo inclinación palas (°)	Caudal máximo (m³/h)	Nivel presión sonora dB(A)	Peso aprox. (Kg)
		230V	400V	690V					
CJTHT-80-8T-1/PLUS	710	4,80	2,80		0,75	28	20650	68	102
CJTHT-90-4T-4/PLUS	1430	11,40	6,60		3,00	8	33600	82	136
CJTHT-90-4/8T-4/PLUS	1420 / 705		6,90 / 2,30		3,00 / 0,60	8	33600 / 16800	82 / 68	149
CJTHT-90-4T-5,5/PLUS	1440		8,40	4,85	4,00	12	38900	84	142
CJTHT-90-4/8T-5,5/PLUS	1450 / 720		9,40 / 3,50		4,00 / 0,80	12	38900 / 19450	84 / 69	177
CJTHT-90-4T-7,5/PLUS	1430		11,50	6,64	5,50	18	46150	86	168
CJTHT-90-4/8T-7,5/PLUS	1455 / 725		12,80 / 4,60		5,50 / 1,10	18	46150 / 23075	86 / 72	182
CJTHT-90-4T-10/PLUS	1460		17,70	10,22	7,50	22	50150	87	179
CJTHT-90-4/8T-9/PLUS	1455 / 725		15,50 / 5,50		6,70 / 1,50	22	50150 / 25075	87 / 73	182
CJTHT-90-6T-2/PLUS	945	7,40	4,30		1,50	16	28800	74	135
CJTHT-90-6/12T-2/PLUS	960 / 470		4,30 / 1,70		1,50 / 0,25	16	28800 / 14400	74 / 59	139
CJTHT-90-6T-3/PLUS	950	10,30	5,90		2,20	24	34000	75	142
CJTHT-90-6/12T-3/PLUS	940 / 470		5,60 / 2,20		2,20 / 0,37	24	34000 / 17000	75 / 60	148
CJTHT-90-6T-4/PLUS	945	15,00	8,70		3,00	30	38900	76	166
CJTHT-90-6/12T-4/PLUS	970 / 475		8,90 / 3,50		3,00 / 0,55	30	38900 / 19450	76 / 61	168
CJTHT-90-8T-1/PLUS	710	4,80	2,80		0,75	18	22900	68	126
CJTHT-90-8T-2/PLUS	700	9,00	5,20		1,50	30	29500	69	142
CJTHT-90-8T-3/PLUS	705	13,20	7,60		2,20	32	30850	70	158
CJTHT-100-4T-7,5/PLUS	1430		11,50	6,64	5,50	10	46850	88	176
CJTHT-100-4/8T-7,5/PLUS	1455 / 725		12,80 / 4,60		5,50 / 1,10	10	46850 / 23425	88 / 73	190
CJTHT-100-4T-10/PLUS	1460		17,70	10,22	7,50	16	57400	89	187
CJTHT-100-4/8T-9/PLUS	1455 / 725		15,50 / 5,50		6,70 / 1,50	14	54700 / 27350	89 / 74	190
CJTHT-100-4T-15/PLUS	1455		23,00	13,28	11,00	22	66300	90	231
CJTHT-100-4/8T-15/PLUS	1470 / 725		23,20 / 8,70		11,00 / 2,80	22	66300 / 33150	90 / 75	231
CJTHT-100-4T-20/PLUS	1460		29,00	16,74	15,00	28	76150	91	246
CJTHT-100-4/8T-20/PLUS	1470 / 725		31,70 / 11,80		15,00 / 3,80	28	76150 / 38075	91 / 76	246
CJTHT-100-6T-3/PLUS	950	10,30	5,90		2,20	16	37600	79	150
CJTHT-100-6/12T-3/PLUS	940 / 470		5,60 / 2,20		2,20 / 0,37	16	37600 / 18800	79 / 64	156
CJTHT-100-6T-4/PLUS	945	15,00	8,70		3,00	20	41150	80	175
CJTHT-100-6/12T-4/PLUS	970 / 475		8,90 / 3,50		3,00 / 0,55	20	41150 / 20575	80 / 65	176
CJTHT-100-6T-5,5/PLUS	970		11,00	6,35	4,00	26	47800	81	187
CJTHT-100-6/12T-5,5/PLUS	970 / 480		11,30 / 4,20		4,00 / 0,65	26	47800 / 23900	81 / 66	187
CJTHT-100-8T-2/PLUS	700	9,00	5,20		1,50	22	32900	74	150
CJTHT-100-8T-3/PLUS	705	13,20	7,60		2,20	30	39400	74	167
CJTHT-100-8T-4/PLUS	710	15,60	9,00		3,00	32	40550	75	187

**Características acústicas**

Los valores indicados, se determinan mediante medidas de nivel de presión y potencia sonora en dB(A) obtenidas en campo libre a una distancia equivalente a dos veces la envergadura del ventilador más el diámetro de la hélice, con un mínimo de 1,5 mts.

Espectro de potencia sonora Lw(A) en dB(A) por banda de frecuencia en Hz

Modelo	63	125	250	500	1000	2000	4000	8000	Modelo	63	125	250	500	1000	2000	4000	8000
40-2-1,5	43	64	71	76	79	75	68	57	50-6	28	48	56	61	63	60	53	42
40-4-1,5 (2V)	28	49	56	61	64	60	53	42	50-12 (2V)	13	33	41	46	48	45	38	27
40-2-2	44	65	72	77	80	76	69	58	56-2-6	58	78	86	91	93	90	83	72
40-4-2 (2V)	29	50	57	62	65	61	54	43	56-4-6 (2V)	42	62	70	75	77	74	67	56
40-4-0,75	31	52	59	64	67	63	56	45	56-2-12	59	79	87	92	94	91	84	73
40-6	21	42	49	54	57	53	46	35	56-4-12 (2V)	44	64	72	77	79	76	69	58
40-12 (2V)	6	27	34	39	42	38	31	20	56-4-1	43	63	71	76	78	75	68	57
45-2-2	45	66	73	78	81	77	70	59	56-4-1,5	44	64	72	77	79	76	69	58
45-4-2 (2V)	30	51	58	63	66	62	55	44	56-8-1,5 (2V)	27	47	55	60	62	59	52	41
45-2-3	47	68	75	80	83	79	72	61	56-4-2	45	65	73	78	80	77	70	59
45-4-3 (2V)	32	53	60	65	68	64	57	46	56-8-2 (2V)	28	48	56	61	63	60	53	42
45-4-0,75	35	56	63	68	71	67	60	49	56-6	33	53	61	66	68	65	58	47
45-6	23	44	51	56	59	55	48	37	56-12 (2V)	16	36	44	49	51	48	41	30
45-12 (2V)	8	29	36	41	44	40	33	22	63-4-1	45	65	73	78	80	77	70	59
50-2-4	52	72	80	85	87	84	77	66	63-4-1,5	44	64	72	77	79	76	69	60
50-4-4 (2V)	35	55	63	68	70	67	60	49	63-8-1,5 (2V)	27	47	55	60	62	59	52	43
50-2-6	53	73	81	86	88	85	78	67	63-4-2	47	64	72	77	79	76	69	61
50-4-6 (2V)	38	58	66	71	73	70	63	52	63-8-2 (2V)	30	47	55	60	62	59	52	44
50-4-1	39	59	67	72	74	71	64	53	63-4-3	49	67	75	80	82	79	74	63

## Características acústicas

Espectro de potencia sonora Lw(A) en dB(A) por banda de frecuencia en Hz

Modelo	63	125	250	500	1000	2000	4000	8000	Modelo	63	125	250	500	1000	2000	4000	8000
63-8-3 (2V)	31	49	57	62	64	61	56	45	90-8-4 (2V)	43	64	71	76	79	75	68	60
63-4-4	50	68	76	81	83	80	75	64	90-4-5,5	56	77	84	89	92	88	81	70
63-8-4 (2V)	32	50	58	63	65	62	57	46	90-8-5,5 (2V)	41	62	69	74	77	73	66	55
63-6-0,75	38	56	64	69	71	68	61	52	90-4-7,5	55	76	83	88	91	87	80	69
63-12-0,75 (2V)	21	37	45	50	52	49	42	31	90-8-7,5 (2V)	40	61	68	73	76	72	65	54
63-6-1	39	58	66	71	73	70	63	53	90-4-10	54	75	82	87	90	86	79	68
63-12-1 (2V)	22	39	47	52	54	51	44	36	90-4-9	54	75	82	87	90	86	79	68
71-4-1,5	51	71	79	84	86	83	76	65	90-8-9 (2V)	40	61	68	73	76	72	65	54
71-8-1,5 (2V)	36	55	63	68	70	67	61	50	90-6-2	46	67	74	79	82	78	71	60
71-4-2	50	70	78	83	85	82	75	66	90-12-2 (2V)	29	50	57	62	65	61	54	43
71-8-2 (2V)	35	55	63	68	70	67	60	51	90-6-3	53	67	74	79	82	78	71	60
71-4-3	53	68	76	81	83	80	73	67	90-12-3 (2V)	38	50	57	62	65	61	54	43
71-8-3 (2V)	39	54	62	67	69	66	59	53	90-6-4	54	69	76	81	84	80	73	62
71-4-4	54	69	77	82	84	81	74	68	90-12-4 (2V)	39	52	59	64	67	63	56	45
71-8-4 (2V)	40	55	63	68	70	67	60	54	90-8-1	39	60	67	72	75	71	64	53
71-6-0,75	40	60	68	71	73	70	63	52	90-8-2	47	62	69	74	77	73	66	55
71-12-0,75 (2V)	26	42	50	55	57	54	47	36	90-8-3	48	62	69	74	77	73	66	55
71-6-1	41	61	69	71	73	70	63	52	100-4-7,5	61	81	89	94	96	93	86	75
71-12-1 (2V)	26	42	50	55	57	54	47	36	100-8-7,5 (2V)	46	66	74	79	81	78	71	60
71-6-1,5	42	62	67	72	74	71	64	53	100-4-10	59	79	87	92	94	91	84	73
71-12-1,5 (2V)	27	42	50	55	57	54	47	36	100-4-9	60	80	88	93	95	92	85	74
80-4-3	55	74	82	88	89	86	80	69	100-8-9 (2V)	45	65	73	78	80	77	70	59
80-8-3 (2V)	40	59	67	73	74	71	65	54	100-4-15	58	78	86	91	93	90	83	72
80-4-4	53	73	81	86	88	85	78	70	100-8-15 (2V)	43	63	71	76	78	75	68	57
80-8-4 (2V)	38	58	66	71	73	70	63	55	100-4-20	60	80	88	93	95	92	85	74
80-4-5,5	53	73	81	86	88	85	78	71	100-8-20 (2V)	44	64	72	77	79	76	69	58
80-8-5,5 (2V)	37	57	65	70	72	69	62	56	100-6-3	59	70	78	83	85	82	75	64
80-6-1,5	45	62	70	75	77	74	67	56	100-12-3 (2V)	44	53	61	66	68	65	58	47
80-12-1,5 (2V)	30	45	53	58	60	57	50	39	100-6-4	60	68	76	81	83	80	73	62
80-6-2	46	63	71	76	78	75	68	57	100-12-4 (2V)	45	52	60	65	67	64	57	46
80-12-2 (2V)	31	46	54	59	61	58	51	40	100-6-5,5	61	70	78	83	85	82	75	64
80-6-3	47	64	72	77	79	76	69	58	100-12-5,5 (2V)	46	53	61	66	68	65	58	47
80-12-3 (2V)	32	47	55	60	62	59	52	41	100-8-2	54	64	72	77	79	76	69	58
80-8-0,75	44	57	65	70	72	69	62	51	100-8-3	54	66	74	79	81	78	71	60
80-8-1	45	58	66	71	73	70	63	52	100-8-4	55	66	74	79	81	78	71	60
90-4-4	57	78	85	90	93	89	82	74									

## Dimensiones mm

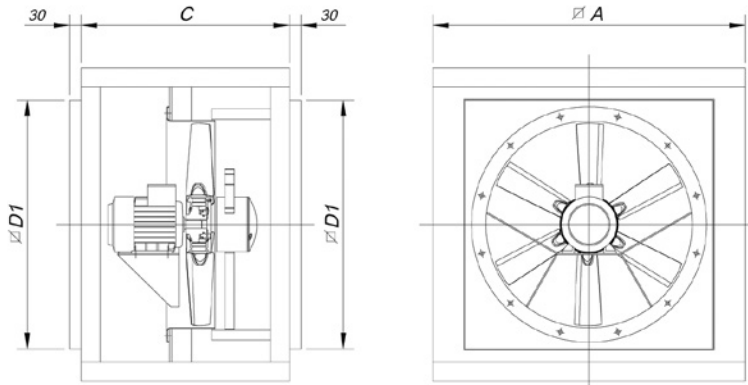

Modelo	∅A	C	∅D1
CJTHT/PLUS-40/45/50	700	550	565
CJTHT/PLUS-56/63	825	550	690
CJTHT/PLUS-71/80	1000	650	850
CJTHT/PLUS-90/100	1200	750	1050

## Curvas Características

Ver curvas características en la página 33.

## Accesorios

Ver apartado accesorios



# CJTHT

## CJTHT: Ventiladores helicoidales 400°C/2h, 300°C/2h y 200°C/2h. Con caja aislada acústicamente



Detalle CJTHT/ATEX

Unidades de extracción con ventiladores helicoidales para trabajar inmersas en zonas de riesgo de incendios

**Ventilador:**

- Ventilador con envolvente tubular en chapa de acero.
- Estructura en chapa de acero galvanizado, con aislamiento térmico y acústico.
- Hélices de ángulo variable en fundición de aluminio.
- Homologación según norma EN 12101-3:2002/AC:2006 con certificaciones: 0370-CPR-0312 (F400), 0370-CPR-0974 (F300), 0370-CPR-0515 (F200).

**Motor:**

- Motores clase H para uso continuo S1 y uso emergencia S2. Con rodamientos a bolas, protección IP55 y 1 ó 2 velocidades según modelo
- Trifásicos 230/400V.-50Hz. (hasta 4CV.) y 400/690V.-50Hz. (potencias superiores a 4CV.)
- Temperatura máxima del aire a transportar: Servicio S1 -20°C+ 40°C en continuo. Servicio S2 200°C/2h, 300°C/2h, 400°C/2h

**Versiones disponibles:**

- CJTHT: Ventiladores helicoidales con caja aislada acústicamente
- CJTHT/ATEX: Ventiladores helicoidales con caja aislada acústicamente, con certificación ATEX, categoría 3 Ex II3G para zona 2 (sólo 400°C/2h y 300°C/2h).
- CJTHT/PLUS: Ventiladores helicoidales con atenuador acústico.

**Bajo demanda:**

- Dirección aire hélice-motor
- Hélices reversibles 100%

**Acabado:**

- Ventilador: Anticorrosivo en resina de poliéster polimerizada a 190°C.. previo desengrase con tratamiento nanotecnológico libre de fosfatos
- Caja: anticorrosivo en chapa de acero galvanizado

### Código de pedido

De tamaño 40 a tamaño 100

**CJTHT — 56 — 4T — 2 — F-400**

CJTHT: Unidades de extracción helicoidales 400°C/2h, 300°C/2h y 200°C/2h, con caja aislada acústicamente

Diámetro hélice en cm.

Número de polos motor  
 2=2900 r/min. 50 Hz  
 4=1400 r/min. 50 Hz  
 6=900 r/min. 50 Hz  
 8=750 r/min. 50 Hz  
 12=500 r/min. 50 Hz

T=Trifásico

Potencia motor (c.v.)

F-200: Homologación 200°C/2h  
 F-300: Homologación. Probado para 300°C/2h  
 F-400: Homologación 400°C/2h  
 CAT3: Con certificación ATEX Categoría 3 Ex II3G

CJTHT/ATEX: Unidades de extracción helicoidales 400°C/2h, 300°C/2h y 200°C/2h, con certificación ATEX

Tamaño 125

**CJTHT — 125 — 4T / — 9-10 — 15 — F-400**

CJTHT: Unidades de extracción helicoidales 400°C/2h, 300°C/2h y 200°C/2h, con caja aislada acústicamente

Diámetro hélice en cm.

Número de polos motor  
 2=2900 r/min. 50 Hz  
 4=1400 r/min. 50 Hz  
 6=900 r/min. 50 Hz  
 8=750 r/min. 50 Hz  
 12=500 r/min. 50 Hz

T=Trifásico

Número de palas  
 3 palas  
 6 palas  
 9 palas

Angulo inclinación palas

Potencia motor (c.v.)

F-200: Homologación 200°C/2h  
 F-300: Homologación. Probado para 300°C/2h  
 F-400: Homologación 400°C/2h  
 CAT3: Con certificación ATEX Categoría 3 Ex II3G



## Características técnicas

Modelo	Velocidad (r/min)	Intensidad máxima admisible (A)			Potencia instalada (kW)	Ángulo inclinación palas (°)	Caudal máximo (m³/h)	Nivel presión sonora dB(A)	Peso aprox. (Kg)
		230V	400V	690V					
CJTHT-40-2/4T-1,5	2900 / 1450		2,90 / 1,10		1,10 / 0,25	20	7050 / 3525	73 / 58	50
CJTHT-40-2/4T-2	2940 / 1460		4,40 / 1,40		1,50 / 0,37	24	7950 / 3975	74 / 59	51
CJTHT-40-4T-0,75	1420	2,90	1,70		0,55	32	4800	61	41
CJTHT-40-6T-0,75	930	3,30	1,90		0,55	32	3150	51	49
CJTHT-40-6/12T-0,75	940 / 460		2,10 / 0,90		0,55 / 0,09	32	3150 / 1575	51 / 36	53
CJTHT-45-2/4T-2	2940 / 1460		4,40 / 1,40		1,50 / 0,37	16	9400 / 4700	75 / 60	53
CJTHT-45-2/4T-3	2930 / 1450		5,70 / 1,80		2,20 / 0,60	22	11350 / 5675	77 / 62	55
CJTHT-45-4T-0,75	1420	2,90	1,70		0,55	36	7450	65	43
CJTHT-45-6T-0,75	930	3,30	1,90		0,55	30	4450	53	51
CJTHT-45-6/12T-0,75	940 / 460		2,10 / 0,90		0,55 / 0,09	30	4450 / 2225	53 / 38	55
CJTHT-50-2/4T-4	2920 / 1440		6,70 / 2,00		3,00 / 0,80	16	13900 / 6950	79 / 64	62
CJTHT-50-2/4T-6	2930 / 1450		10,00 / 3,20		4,50 / 1,30	20	15900 / 7950	80 / 65	78
CJTHT-50-4T-1	1430	3,80	2,20		0,75	28	9750	66	50
CJTHT-50-6T-0,75	930	3,30	1,90		0,55	32	7000	55	52
CJTHT-50-6/12T-0,75	940 / 460		2,10 / 0,90		0,55 / 0,09	32	7000 / 3500	55 / 40	56
CJTHT-56-2/4T-6	2930 / 1450		10,00 / 3,20		4,50 / 1,30	16	18800 / 9400	85 / 69	87
CJTHT-56-2/4T-12	2920 / 1440		18,50 / 5,50		9,00 / 2,50	30	27200 / 13600	86 / 71	153
CJTHT-56-4T-1	1430	3,80	2,20		0,75	22	11250	70	59
CJTHT-56-4T-1,5	1420	4,70	2,70		1,10	30	13600	71	61
CJTHT-56-4/8T-1,5	1440 / 710		2,90 / 1,40		1,10 / 0,25	30	13600 / 6800	71 / 56	65
CJTHT-56-4T-2	1425	6,60	3,80		1,50	36	15050	72	63
CJTHT-56-4/8T-2	1415 / 715		3,60 / 1,50		1,50 / 0,30	36	15050 / 7525	72 / 57	69
CJTHT-56-6T-0,75	930	3,30	1,90		0,55	38	10150	60	61
CJTHT-56-6/12T-0,75	940 / 460		2,10 / 0,90		0,55 / 0,09	38	10150 / 5075	60 / 45	65
CJTHT-63-4T-1	1430	3,80	2,20		0,75	14	15200	70	63
CJTHT-63-4T-1,5	1420	4,70	2,70		1,10	20	17800	71	66
CJTHT-63-4/8T-1,5	1440 / 710		2,90 / 1,40		1,10 / 0,25	20	17800 / 8900	71 / 56	69
CJTHT-63-4T-2	1425	6,60	3,80		1,50	24	19300	72	67
CJTHT-63-4/8T-2	1415 / 715		3,60 / 1,50		1,50 / 0,30	24	19300 / 9650	72 / 57	74
CJTHT-63-4T-3	1435	9,20	5,30		2,20	32	22150	73	73
CJTHT-63-4/8T-3	1415 / 715		5,20 / 1,90		2,20 / 0,45	32	22150 / 11075	73 / 58	87
CJTHT-63-4T-4	1430	11,40	6,60		3,00	38	24250	74	78
CJTHT-63-4/8T-4	1420 / 705		6,90 / 2,30		3,00 / 0,60	38	24250 / 12125	74 / 59	91
CJTHT-63-6T-0,75	930	3,30	1,90		0,55	28	13600	63	66
CJTHT-63-6/12T-0,75	940 / 460		2,10 / 0,90		0,55 / 0,09	28	13600 / 6800	63 / 48	69
CJTHT-63-6T-1	940	4,40	2,60		0,75	38	15900	64	67
CJTHT-63-6/12T-1	935 / 430		2,50 / 1,03		0,75 / 0,15	38	15900 / 7950	64 / 49	71
CJTHT-71-4T-1,5	1420	4,70	2,70		1,10	12	19500	75	82
CJTHT-71-4/8T-1,5	1440 / 710		2,90 / 1,40		1,10 / 0,25	12	19500 / 9750	75 / 60	86
CJTHT-71-4T-2	1425	6,60	3,80		1,50	14	20900	76	84
CJTHT-71-4/8T-2	1415 / 715		3,60 / 1,50		1,50 / 0,30	14	20900 / 10450	76 / 61	91
CJTHT-71-4T-3	1435	9,20	5,30		2,20	22	25100	78	90
CJTHT-71-4/8T-3	1415 / 715		5,20 / 1,90		2,20 / 0,45	22	25100 / 12550	78 / 63	103
CJTHT-71-4T-4	1430	11,40	6,60		3,00	28	27500	79	95
CJTHT-71-4/8T-4	1420 / 705		6,90 / 2,30		3,00 / 0,60	28	27500 / 13750	79 / 64	108
CJTHT-71-6T-0,75	930	3,30	1,90		0,55	20	16100	65	82
CJTHT-71-6/12T-0,75	940 / 460		2,10 / 0,90		0,55 / 0,09	20	16100 / 8050	65 / 50	86
CJTHT-71-6T-1	940	4,40	2,60		0,75	26	17300	66	84
CJTHT-71-6/12T-1	935 / 430		2,50 / 1,03		0,75 / 0,15	26	17300 / 8650	66 / 51	87
CJTHT-71-6T-1,5	945	6,40	3,70		1,10	34	19950	67	86
CJTHT-71-6/12T-1,5	940 / 450		3,30 / 1,20		1,10 / 0,18	34	19950 / 9975	67 / 52	97
CJTHT-80-4T-3	1435	9,20	5,30		2,20	12	25450	79	98
CJTHT-80-4/8T-3	1415 / 715		5,20 / 1,90		2,20 / 0,45	12	25450 / 12725	79 / 64	111

### Características técnicas

Modelo	Velocidad (r/min)	Intensidad máxima admisible (A)			Potencia instalada (kW)	Ángulo inclinación palas (°)	Caudal máximo (m³/h)	Nivel presión sonora dB(A)	Peso aprox. (Kg)
		230V	400V	690V					
CJTHT-80-4T-4	1430	11,40	6,60		3,00	16	30250	80	103
CJTHT-80-4/8T-4	1420 / 705		6,90 / 2,30		3,00 / 0,60	16	30250 / 15125	80 / 65	115
CJTHT-80-4T-5,5	1440		8,40	4,85	4,00	18	32750	81	113
CJTHT-80-4/8T-5,5	1450 / 720		9,40 / 3,50		4,00 / 0,80	18	32750 / 16375	81 / 66	147
CJTHT-80-6T-1,5	945	6,40	3,70		1,10	18	21450	70	95
CJTHT-80-6/12T-1,5	940 / 450		3,30 / 1,20		1,10 / 0,18	18	21450 / 10725	70 / 55	105
CJTHT-80-6T-2	945	7,40	4,30		1,50	26	25950	71	99
CJTHT-80-6/12T-2	960 / 470		4,30 / 1,70		1,50 / 0,25	26	25950 / 12975	71 / 56	113
CJTHT-80-6T-3	950	10,30	5,90		2,20	32	29950	72	113
CJTHT-80-6/12T-3	940 / 470		5,60 / 2,20		2,20 / 0,37	32	29950 / 14975	72 / 57	118
CJTHT-80-8T-0,75	700	3,60	2,10		0,55	20	17550	68	99
CJTHT-80-8T-1	710	4,80	2,80		0,75	28	20650	69	111
CJTHT-90-4T-4	1430	11,40	6,60		3,00	8	33600	84	127
CJTHT-90-4/8T-4	1420 / 705		6,90 / 2,30		3,00 / 0,60	8	33600 / 16800	84 / 69	139
CJTHT-90-4T-5,5	1440		8,40	4,85	4,00	12	38900	86	137
CJTHT-90-4/8T-5,5	1450 / 720		9,40 / 3,50		4,00 / 0,80	12	38900 / 19450	86 / 71	171
CJTHT-90-4T-7,5	1430		11,50	6,64	5,50	18	46150	88	171
CJTHT-90-4/8T-7,5	1455 / 725		12,80 / 4,60		5,50 / 1,10	18	46150 / 23075	88 / 73	190
CJTHT-90-4T-10	1460		17,70	10,22	7,50	22	50150	89	208
CJTHT-90-4/8T-9	1455 / 725		15,50 / 5,50		6,70 / 1,50	22	50150 / 25075	89 / 74	198
CJTHT-90-6T-2	945	7,40	4,30		1,50	16	28800	75	123
CJTHT-90-6/12T-2	960 / 470		4,30 / 1,70		1,50 / 0,25	16	28800 / 14400	75 / 60	137
CJTHT-90-6T-3	950	10,30	5,90		2,20	24	34000	76	137
CJTHT-90-6/12T-3	940 / 470		5,60 / 2,20		2,20 / 0,37	24	34000 / 17000	76 / 61	142
CJTHT-90-6T-4	945	15,00	8,70		3,00	30	38900	77	171
CJTHT-90-6/12T-4	970 / 475		8,90 / 3,50		3,00 / 0,55	30	38900 / 19450	77 / 62	171
CJTHT-90-8T-1	710	4,80	2,80		0,75	18	22900	69	135
CJTHT-90-8T-2	700	9,00	5,20		1,50	30	29500	71	139
CJTHT-90-8T-3	705	13,20	7,60		2,20	32	30850	72	171
CJTHT-100-4T-7,5	1430		11,50	6,64	5,50	10	46850	89	179
CJTHT-100-4/8T-7,5	1455 / 725		12,80 / 4,60		5,50 / 1,10	10	46850 / 23425	89 / 74	198
CJTHT-100-4T-10	1460		17,70	10,22	7,50	16	57400	90	216
CJTHT-100-4/8T-9	1455 / 725		15,50 / 5,50		6,70 / 1,50	14	54700 / 27350	90 / 75	206
CJTHT-100-4T-15	1455		23,00	13,28	11,00	22	66300	91	251
CJTHT-100-4/8T-15	1470 / 725		23,20 / 8,70		11,00 / 2,80	22	66300 / 33150	91 / 76	251
CJTHT-100-4T-20	1460		29,00	16,74	15,00	28	76150	92	258
CJTHT-100-4/8T-20	1470 / 725		31,70 / 11,80		15,00 / 3,80	28	76150 / 38075	92 / 77	258
CJTHT-100-6T-3	950	10,30	5,90		2,20	16	37600	80	145
CJTHT-100-6/12T-3	940 / 470		5,60 / 2,20		2,20 / 0,37	16	37600 / 18800	80 / 65	150
CJTHT-100-6T-4	945	15,00	8,70		3,00	20	41150	81	179
CJTHT-100-6/12T-4	970 / 475		8,90 / 3,50		3,00 / 0,55	20	41150 / 20575	81 / 66	179
CJTHT-100-6T-5,5	970		11,00	6,35	4,00	26	47800	82	187
CJTHT-100-6/12T-5,5	970 / 480		11,30 / 4,20		4,00 / 0,65	26	47800 / 23900	82 / 67	206
CJTHT-100-8T-2	700	9,00	5,20		1,50	22	32900	75	147
CJTHT-100-8T-3	705	13,20	7,60		2,20	30	39400	75	179
CJTHT-100-8T-4	710	15,60	9,00		3,00	32	40550	76	216
CJTHT-125-4T/3-10	1460		17,70	10,22	7,50	8	58550	85	395
CJTHT-125-4/8T/3-9	1455 / 725		15,50 / 5,50		6,70 / 1,50	8	58550 / 29275	85 / 65	409
CJTHT-125-4T/3-15	1455		23,00	13,28	11,00	14	77750	86	450
CJTHT-125-4/8T/3-15	1470 / 725		23,20 / 8,70		11,00 / 2,80	14	77750 / 38875	86 / 66	456
CJTHT-125-4T/3-20	1460		29,00	16,74	15,00	18	91450	88	457
CJTHT-125-4/8T/3-20	1470 / 725		31,70 / 11,80		15,00 / 3,80	18	91450 / 45725	88 / 68	476
CJTHT-125-4T/3-25	1465		37,00	21,36	18,50	20	98350	88	540

**Características técnicas**

Modelo	Velocidad (r/min)	Intensidad máxima admisible (A)			Potencia instalada (kW)	Ángulo inclinación palas (°)	Caudal máximo (m³/h)	Nivel presión sonora dB(A)	Peso aprox. (Kg)
		230V	400V	690V					
CJTHT-125-4T/3-30	1470		42,00	24,25	22,00	24	110350	89	545
CJTHT-125-4/8T/3-27	1470 / 735		38,00 / 13,00		20,00 / 4,00	22	104400 / 52200	89 / 68	548
CJTHT-125-4/8T/3-37	1475 / 735		51,00 / 20,60		27,00 / 6,00	28	120700 / 60350	90 / 69	625
CJTHT-125-4T/3-40	1475		58,00	33,49	30,00	30	125000	90	598
CJTHT-125-4/8T/3-40	1480 / 735		62,00 / 27,00		30,00 / 10,00	30	125000 / 62500	90 / 69	638
CJTHT-125-4T/6-20	1460		29,00	16,74	15,00	10	78600	86	466
CJTHT-125-4/8T/6-20	1470 / 725		31,70 / 11,80		15,00 / 3,80	10	78600 / 39300	86 / 65	485
CJTHT-125-4/8T/6-22	1470 / 735		31,80 / 12,00		16,50 / 3,30	12	85600 / 42800	86 / 66	555
CJTHT-125-4T/6-25	1465		37,00	21,36	18,50	14	92550	87	549
CJTHT-125-4/8T/6-27	1470 / 735		38,00 / 13,00		20,00 / 4,00	16	98850 / 49425	87 / 66	557
CJTHT-125-4T/6-30	1470		42,00	24,25	22,00	16	98850	87	554
CJTHT-125-4/8T/6-37	1475 / 735		51,00 / 20,60		27,00 / 6,00	20	110900 / 55450	87 / 67	633
CJTHT-125-4T/6-40	1475		58,00	33,49	30,00	22	117450	89	606
CJTHT-125-4/8T/6-40	1480 / 735		62,00 / 27,00		30,00 / 10,00	22	117450 / 58725	89 / 68	646
CJTHT-125-4T/6-50	1480		73,00	42,15	37,00	26	131050	90	734
CJTHT-125-4T/9-25	1465		37,00	21,36	18,50	10	79650	85	558
CJTHT-125-4/8T/9-22	1470 / 735		31,80 / 12,00		16,50 / 3,30	8	71150 / 35575	85 / 66	564
CJTHT-125-4T/9-30	1470		42,00	24,25	22,00	12	88300	86	563
CJTHT-125-4/8T/9-27	1470 / 735		38,00 / 13,00		20,00 / 4,00	12	88300 / 44150	86 / 67	566
CJTHT-125-4/8T/9-37	1475 / 735		51,00 / 20,60		27,00 / 6,00	16	104050 / 52025	87 / 67	642
CJTHT-125-4T/9-40	1475		58,00	33,49	30,00	16	104050	88	615
CJTHT-125-4/8T/9-40	1480 / 735		62,00 / 27,00		30,00 / 10,00	16	104050 / 52025	88 / 68	655
CJTHT-125-4T/9-50	1480		73,00	42,15	37,00	20	118400	90	743
CJTHT-125-6T/3-4	945	15,00	8,70		3,00	12	46750	77	385
CJTHT-125-6/12T/3-4	970 / 475		8,90 / 3,50		3,00 / 0,55	12	46750 / 23375	77 / 62	401
CJTHT-125-6T/3-5,5	970		11,00	6,35	4,00	16	55400	78	393
CJTHT-125-6/12T/3-5,5	970 / 480		11,30 / 4,20		4,00 / 0,65	16	55400 / 27700	78 / 63	432
CJTHT-125-6T/3-7,5	970		14,00	8,08	5,50	22	68400	79	401
CJTHT-125-6/12T/3-7,5	970 / 480		13,70 / 5,60		5,50 / 1,00	22	68400 / 34200	79 / 64	445
CJTHT-125-6T/3-10	960		18,60	10,74	7,50	28	79150	81	449
CJTHT-125-6/12T/3-10	970 / 480		19,00 / 8,00		7,50 / 1,40	28	79150 / 39575	81 / 66	457
CJTHT-125-6T/3-15	955		26,00	15,01	11,00	34	87150	82	466
CJTHT-125-6/12T/3-15	970 / 470		28,50 / 13,00		11,00 / 2,00	34	87150 / 43575	82 / 67	557
CJTHT-125-6T/3-20	950		35,50	20,50	15,00	38	91650	83	533
CJTHT-125-6/12T/3-24	970 / 480		36,00 / 14,50		17,50 / 3,50	38	91650 / 45825	83 / 68	623
CJTHT-125-6T/6-5,5	970		11,00	6,35	4,00	10	51500	75	402
CJTHT-125-6/12T/6-5,5	970 / 480		11,30 / 4,20		4,00 / 0,65	10	51500 / 25750	75 / 60	441
CJTHT-125-6T/6-7,5	970		14,00	8,08	5,50	14	60650	75	410
CJTHT-125-6/12T/6-7,5	970 / 480		13,70 / 5,60		5,50 / 1,00	14	60650 / 30325	75 / 60	454
CJTHT-125-6T/6-10	960		18,60	10,74	7,50	20	72650	77	458
CJTHT-125-6/12T/6-10	970 / 480		19,00 / 8,00		7,50 / 1,40	20	72650 / 36325	77 / 62	466
CJTHT-125-6T/6-15	955		26,00	15,01	11,00	26	85850	79	475
CJTHT-125-6/12T/6-15	970 / 470		19,00 / 8,00		11,00 / 2,00	26	85850 / 42925	79 / 64	566
CJTHT-125-6T/6-20	950		35,50	20,50	15,00	30	92850	80	542
CJTHT-125-6/12T/6-24	970 / 480		36,00 / 14,50		17,50 / 3,50	34	99650 / 49825	80 / 65	631
CJTHT-125-6T/9-10	960		18,60	10,74	7,50	14	63500	76	467
CJTHT-125-6/12T/9-10	970 / 480		19,00 / 8,00		7,50 / 1,40	14	63500 / 31750	76 / 61	475
CJTHT-125-6T/9-15	955		26,00	15,01	11,00	20	77550	79	484
CJTHT-125-6/12T/9-15	970 / 470		28,50 / 13,00		11,00 / 2,00	20	77550 / 38775	79 / 64	575
CJTHT-125-6T/9-20	950		35,50	20,50	15,00	26	92950	82	551
CJTHT-125-6/12T/9-24	970 / 480		36,00 / 14,50		17,50 / 3,50	30	98500 / 49250	82 / 67	640

**Características acústicas**

Los valores indicados, se determinan mediante medidas de nivel de presión y potencia sonora en dB(A) obtenidas en campo libre a una distancia equivalente a dos veces la envergadura del ventilador más el diámetro de la hélice, con un mínimo de 1,5 mts.

**Espectro de potencia sonora Lw(A) en dB(A) por banda de frecuencia en Hz**

Modelo	63	125	250	500	1000	2000	4000	8000	Modelo	63	125	250	500	1000	2000	4000	8000
40-2-1,5	45	66	73	78	81	77	70	59	90-8-3	50	64	71	76	79	75	68	57
40-4-1,5 (2V)	30	51	58	63	66	62	55	44	100-4-7,5	62	82	90	95	97	94	87	76
40-2-2	46	67	74	79	82	78	71	60	100-8-7,5 (2V)	47	67	75	80	82	79	72	61
40-4-2 (2V)	31	52	59	64	67	63	56	45	100-4-10	60	80	88	93	95	92	85	74
40-4-0,75	33	54	61	66	69	65	58	47	100-4-9	61	81	89	94	96	93	86	75
40-6	23	44	51	56	59	55	48	37	100-8-9 (2V)	46	66	74	79	81	78	71	60
40-12 (2V)	8	29	36	41	44	40	33	22	100-4-15	59	79	87	92	94	91	84	73
45-2-2	47	68	75	80	83	79	72	61	100-8-15 (2V)	44	64	72	77	79	76	69	58
45-4-2 (2V)	32	53	60	65	68	64	57	46	100-4-20	61	81	89	94	96	93	86	75
45-2-3	49	70	77	82	85	81	74	63	100-8-20 (2V)	45	65	73	78	80	77	70	59
45-4-3 (2V)	34	55	62	67	70	66	59	48	100-6-3	60	71	79	84	86	83	76	65
45-4-0,75	37	58	65	70	73	69	62	51	100-12-3 (2V)	45	54	62	67	69	66	59	48
45-6	25	46	53	58	61	57	50	39	100-6-4	61	69	77	82	84	81	74	63
45-12 (2V)	10	31	38	43	46	42	35	24	100-12-4 (2V)	46	53	61	66	68	65	58	47
50-2-4	54	74	82	87	89	86	79	68	100-6-5,5	62	71	79	84	86	83	76	65
50-4-4 (2V)	39	59	67	72	74	71	64	53	100-12-5,5 (2V)	47	54	62	67	69	66	59	48
50-2-6	55	75	83	88	90	87	80	69	100-8-2	55	65	73	78	80	77	70	59
50-4-6 (2V)	40	60	68	73	75	72	65	54	100-8-3	55	67	75	80	82	79	72	61
50-4-1	41	61	69	74	76	73	66	55	100-8-4	56	67	75	80	82	79	72	61
50-6	30	50	58	63	65	62	55	44	125-4/3-10	67	73	85	95	95	91	83	79
50-12 (2V)	15	35	43	48	50	47	40	29	125-4/3-9	67	73	85	95	95	91	83	79
56-2-6	60	80	88	93	95	92	85	74	125-8/3-9 (2V)	47	53	65	75	75	71	63	59
56-4-6 (2V)	44	64	72	77	79	76	69	58	125-4/3-15	68	74	86	96	96	92	84	80
56-2-12	61	81	89	94	96	93	86	75	125-8/3-15 (2V)	48	54	66	76	76	72	64	60
56-4-12 (2V)	46	66	74	79	81	78	71	60	125-4/3-20	70	76	88	98	98	94	86	82
56-4-1	45	65	73	78	80	77	70	59	125-8/3-20 (2V)	50	56	68	78	78	74	66	62
56-4-1,5	46	66	74	79	81	78	71	60	125-4/3-25	70	76	88	98	98	94	86	82
56-8-1,5 (2V)	31	51	59	64	66	63	56	45	125-4/3-30	71	77	89	99	99	95	87	83
56-4-2	47	67	75	80	82	79	72	61	125-4/3-27	71	77	89	99	99	95	87	83
56-8-2 (2V)	32	52	60	65	67	64	57	46	125-8/3-27 (2V)	50	56	68	78	78	74	66	62
56-6	35	55	63	68	70	67	60	49	125-4/3-37	72	78	90	100	100	96	88	84
56-12 (2V)	20	40	48	53	55	52	45	34	125-8/3-37 (2V)	51	57	69	79	79	75	67	63
63-4-1	47	67	75	80	82	79	72	61	125-4/3-40	72	78	90	100	100	96	88	84
63-4-1,5	46	66	74	79	81	78	71	62	125-8/3-40 (2V)	51	57	69	79	79	75	67	63
63-8-1,5 (2V)	31	51	59	64	66	63	56	47	125-4/6-20	64	72	88	95	97	92	86	82
63-4-2	49	66	74	79	81	78	71	63	125-8/6-20 (2V)	43	51	67	74	76	71	65	61
63-8-2 (2V)	34	51	59	64	66	63	56	48	125-4/6-22	64	72	88	95	97	92	86	82
63-4-3	50	68	76	81	83	80	75	64	125-8/6-22 (2V)	44	52	68	75	77	72	66	62
63-8-3 (2V)	35	53	61	66	68	65	60	49	125-4/6-25	65	73	89	96	98	93	87	83
63-4-4	51	69	77	82	84	81	76	65	125-4/6-27	65	73	89	96	98	93	87	83
63-8-4 (2V)	36	54	62	67	69	66	61	50	125-8/6-27 (2V)	44	52	68	75	77	72	66	62
63-6-0,75	40	58	66	71	73	70	63	54	125-4/6-30	65	73	89	96	98	93	87	83
63-12-0,75 (2V)	25	41	49	54	56	53	46	35	125-4/6-37	65	73	89	96	98	93	87	83
63-6-1	41	60	68	73	75	72	65	55	125-8/6-37 (2V)	45	53	69	76	78	73	67	63
63-12-1 (2V)	26	43	51	56	58	55	48	40	125-4/6-40	67	75	91	98	100	95	89	85
71-4-1,5	52	72	80	85	87	84	77	66	125-8/6-40 (2V)	46	54	70	77	79	74	68	64
71-8-1,5 (2V)	37	56	64	69	71	68	62	51	125-4/6-50	68	76	92	99	101	96	90	86
71-4-2	51	71	79	84	86	83	76	67	125-4/9-25	63	71	88	94	95	90	85	81
71-8-2 (2V)	36	56	64	69	71	68	61	52	125-4/9-22	63	71	88	94	95	90	85	81
71-4-3	55	70	78	83	85	82	75	69	125-8/9-22 (2V)	44	52	69	75	76	71	66	62
71-8-3 (2V)	40	55	63	68	70	67	60	54	125-4/9-30	64	72	89	95	96	91	86	82
71-4-4	56	71	79	84	86	83	76	70	125-4/9-27	64	72	89	95	96	91	86	82
71-8-4 (2V)	41	56	64	69	71	68	61	55	125-8/9-27 (2V)	45	53	70	76	77	72	67	63
71-6-0,75	42	62	70	73	75	72	65	54	125-4/9-37	65	73	90	96	97	92	87	83
71-12-0,75 (2V)	27	43	51	56	58	55	48	37	125-8/9-37 (2V)	45	53	70	76	77	72	67	63
71-6-1	43	63	71	73	75	72	65	54	125-4/9-40	66	74	91	97	98	93	88	84
71-12-1 (2V)	28	44	52	57	59	56	49	38	125-8/9-40 (2V)	46	54	71	77	78	73	68	64
71-6-1,5	44	64	69	74	76	73	66	55	125-4/9-50	68	76	93	99	100	95	90	86
71-12-1,5 (2V)	29	44	52	57	59	56	49	38	125-6/3-4	63	71	83	87	85	80	71	67
80-4-3	56	75	83	89	90	87	81	70	125-12/3-4 (2V)	48	56	68	72	70	65	56	52
80-8-3 (2V)	41	60	68	74	75	72	66	55	125-6/3-5,5	64	72	84	88	86	81	72	68
80-4-4	54	74	82	87	89	86	79	71	125-12/3-5,5 (2V)	49	57	69	73	71	66	57	53
80-8-4 (2V)	39	59	67	72	74	71	64	56	125-6/3-7,5	65	73	85	89	87	82	73	69
80-4-5,5	54	74	82	87	89	86	79	72	125-12/3-7,5 (2V)	50	58	70	74	72	67	58	54
80-8-5,5 (2V)	38	58	66	71	73	70	63	57	125-6/3-10	67	75	87	91	89	84	75	71
80-6-1,5	47	64	72	77	79	76	69	58	125-12/3-10 (2V)	52	60	72	76	74	69	60	56
80-12-1,5 (2V)	32	47	55	60	62	59	52	41	125-6/3-15	68	76	88	92	90	85	76	72
80-6-2	48	65	73	78	80	77	70	59	125-12/3-15 (2V)	53	61	73	77	75	70	61	57
80-12-2 (2V)	33	48	56	61	63	60	53	42	125-6/3-20	69	77	89	93	91	86	77	73
80-6-3	49	66	74	79	81	78	71	60	125-6/3-24	69	77	89	93	91	86	77	73
80-12-3 (2V)	34	49	57	62	64	61	54	43	125-12/3-24 (2V)	54	62	74	78	76	71	62	58
80-8-0,75	45	58	66	71	73	70	63	52	125-6/6-5,5	58	67	80	83	84	81	70	66
80-8-1	46	59	67	72	74	71	64	53	125-12/6-5,5 (2V)	43	52	65	68	69	66	55	51
90-4-4	59	80	87	92	95	91	84	76	125-6/6-7,5	58	67	80	83	84	81	70	66
90-8-4 (2V)	44	65	72	77	80	76	69	61	125-12/6-7,5 (2V)	43	52	65	68	69	66	55	51
90-4-5,5	58	79	86	91	94	90	83	72	125-6/6-10	60	69	82	85	86	83	72	68
90-8-5,5 (2V)	43	64	71	76	79	75	68	57	125-12/6-10 (2V)	45	54	67	70	71	68	57	53
90-4-7,5	57	78	85	90	93	89	82	71	125-6/6-15	62	71	84	87	88	85	74	70
90-8-7,5 (2V)	41	62	69	74	77	73	66	55	125-12/6-15 (2V)	47	56	69	72	73	70	59	55
90-4-10	56	77	84	89	92	88	81	70	125-6/6-20	63	72	85	88	89	86	75	71
90-4-9	56	77	84	89	92	88	81	70	125-6/6-24	63	72	85	88	89	86	75	71
90-8-9 (2V)	41	62	69	74	77	73	66										

## Dimensiones mm

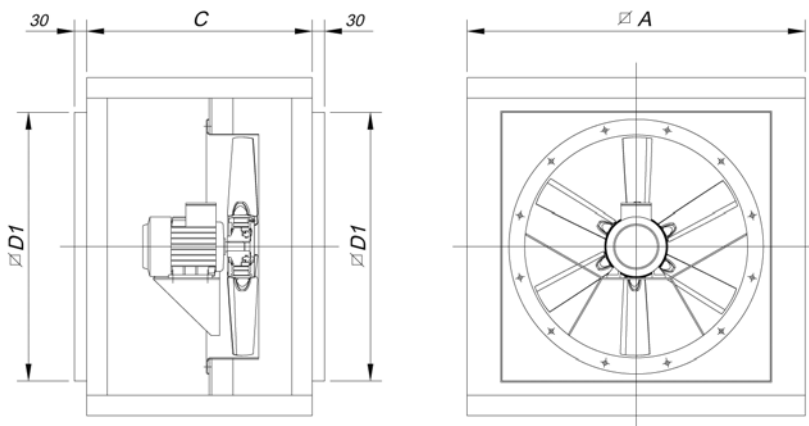

Modelo	$\varnothing A$	C	$\varnothing D1$
CJTHT-40/45/50	700	550	565
CJTHT-56/63	825	550	690
CJTHT-71/80	1000	650	850
CJTHT-90/100	1200	750	1050
CJTHT-125	1600	1200	1400

## Curvas Características

Ver curvas características en la página 33.

## Accesorios

Ver apartado accesorios



# CJTHT/DUPLEX/ATEX



**Unidades de extracción 400°C/2h, con certificación ATEX categoría 2 Ex II2G. De acuerdo R.E.B.T. Itc 29 ATEX y NBE-CP/96 para aparcamientos clasificados Zona 1 y 2**

Unidades de extracción dúplex, con caja aislada acústicamente, para trabajar inmersas en zonas de riesgo de incendios 400°C/2h, con certificación ATEX categoría 2 Ex II2G. De acuerdo R.E.B.T. Itc 29 ATEX para aparcamientos clasificados Zona 1 y 2

**Ventilador:**

- Estructura en chapa de acero galvanizado, con aislamiento térmico y acústico
- Hélices orientables en fundición de aluminio

**Unidades de extracción doble compuesta por:**

- CJTHT/ATEX categoría 3, 400°C/2h para evacuación de humos en caso de incendios, con certificación N°: 0370-CPR-0312
- CJHCH/ATEX categoría 2 para evacuación de CO en funcionamiento normal
- Dirección aire motor-hélice

**Motor:**

- Motores clase H, uso continuo S1 y uso emergencia S2, con rodamientos a bolas, protección IP55
- Trifásicos 230/400V.-50Hz.(hasta 4CV.) y 400/690V.-50Hz.(potencias superiores a 4CV.)
- Temperatura máxima del aire a transportar: Servicio S1 -20°C+ 40°C en continuo, Servicio S2 400°C/2h

**Acabado:**

- Anticorrosivo en chapa de acero galvanizado

**Bajo demanda:**

- Construcción para trabajo horizontal



**Código de pedido**

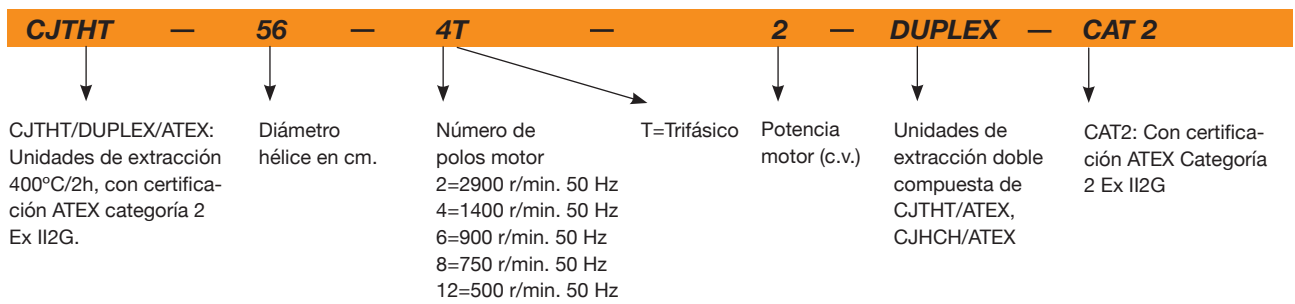

**Características técnicas**

Modelo	Velocidad (r/min)	Intensidad máxima admisible (A)			Potencia instalada (kW)	Ángulo inclinación palas (°)	Caudal máximo (m³/h)	Nivel presión sonora dB(A)	Peso aprox. (Kg)
		230V	400V	690V					
CJTHT-40-4T-0,75/DUPLEX-CAT2	1420	2,90	1,70		0,55	32	4800	61	82
CJTHT-40-6T-0,75/DUPLEX-CAT2	930	3,30	1,90		0,55	32	3150	51	92
CJTHT-45-4T-0,75/DUPLEX-CAT2	1420	2,90	1,70		0,55	36	7450	65	85
CJTHT-45-6T-0,75/DUPLEX-CAT2	930	3,30	1,90		0,55	30	4450	53	95
CJTHT-50-4T-1/DUPLEX-CAT2	1430	3,80	2,20		0,75	28	9750	66	95
CJTHT-50-6T-0,75/DUPLEX-CAT2	930	3,30	1,90		0,55	32	7000	55	97
CJTHT-56-4T-1/DUPLEX-CAT2	1430	3,80	2,20		0,75	22	11250	70	113
CJTHT-56-4T-1,5/DUPLEX-CAT2	1420	4,70	2,70		1,10	30	13600	71	117
CJTHT-56-4T-2/DUPLEX-CAT2	1425	6,60	3,80		1,50	36	15050	72	122
CJTHT-56-6T-0,75/DUPLEX-CAT2	930	3,30	1,90		0,55	38	10150	60	115

## Características técnicas

Modelo	Velocidad (r/min)	Intensidad máxima admisible (A)			Potencia instalada (kW)	Ángulo inclinación palas (°)	Caudal máximo (m³/h)	Nivel presión sonora dB(A)	Peso aprox. (Kg)
		230V	400V	690V					
CJTHT-63-4T-1/DUPLEX-CAT2	1430	3,80	2,20		0,75	14	15200	70	122
CJTHT-63-4T-1,5/DUPLEX-CAT2	1420	4,70	2,70		1,10	20	17800	71	126
CJTHT-63-4T-2/DUPLEX-CAT2	1425	6,60	3,80		1,50	24	19300	72	131
CJTHT-63-4T-3/DUPLEX-CAT2	1435	9,20	5,30		2,20	32	22150	73	143
CJTHT-63-4T-4/DUPLEX-CAT2	1430	11,40	6,60		3,00	38	24250	74	150
CJTHT-63-6T-0,75/DUPLEX-CAT2	930	3,30	1,90		0,55	28	13600	63	124
CJTHT-63-6T-1/DUPLEX-CAT2	940	4,40	2,60		0,75	38	15900	64	128
CJTHT-71-4T-1,5/DUPLEX-CAT2	1420	4,70	2,70		1,10	12	19500	75	160
CJTHT-71-4T-2/DUPLEX-CAT2	1425	6,60	3,80		1,50	14	20900	76	164
CJTHT-71-4T-3/DUPLEX-CAT2	1435	9,20	5,30		2,20	22	25100	78	177
CJTHT-71-4T-4/DUPLEX-CAT2	1430	11,40	6,60		3,00	28	27500	79	184
CJTHT-71-6T-0,75/DUPLEX-CAT2	930	3,30	1,90		0,55	20	16100	65	158
CJTHT-71-6T-1/DUPLEX-CAT2	940	4,40	2,60		0,75	26	17300	66	161
CJTHT-71-6T-1,5/DUPLEX-CAT2	945	6,40	3,70		1,10	34	19950	67	166
CJTHT-80-4T-3/DUPLEX-CAT2	1435	9,20	5,30		2,20	12	25450	79	193
CJTHT-80-4T-4/DUPLEX-CAT2	1430	11,40	6,60		3,00	16	30250	80	200
CJTHT-80-4T-5,5/DUPLEX-CAT2	1440		8,40	4,85	4,00	18	32750	81	213
CJTHT-80-6T-1,5/DUPLEX-CAT2	945	6,40	3,70		1,10	18	21450	70	184
CJTHT-80-6T-2/DUPLEX-CAT2	945	7,40	4,30		1,50	26	25950	71	196
CJTHT-80-6T-3/DUPLEX-CAT2	950	10,30	5,90		2,20	32	29950	72	213
CJTHT-90-4T-4/DUPLEX-CAT2	1430	11,40	6,60		3,00	8	33600	84	248
CJTHT-90-4T-5,5/DUPLEX-CAT2	1440		8,40	4,85	4,00	12	38900	86	261
CJTHT-90-4T-7,5/DUPLEX-CAT2	1430		11,50	6,64	5,50	18	46150	88	309
CJTHT-90-4T-10/DUPLEX-CAT2	1460		17,70	10,22	7,50	22	50150	89	354
CJTHT-90-6T-2/DUPLEX-CAT2	945	7,40	4,30		1,50	16	28800	75	243
CJTHT-90-6T-3/DUPLEX-CAT2	950	10,30	5,90		2,20	24	34000	76	261
CJTHT-90-6T-4/DUPLEX-CAT2	945	15,00	8,70		3,00	30	38900	77	308
CJTHT-100-4T-7,5/DUPLEX-CAT2	1430		11,50	6,64	5,50	10	46850	89	326
CJTHT-100-4T-10/DUPLEX-CAT2	1460		17,70	10,22	7,50	16	57400	90	371
CJTHT-100-4T-15/DUPLEX-CAT2	1455		23,00	13,28	11,00	22	66300	91	436
CJTHT-100-4T-20/DUPLEX-CAT2	1460		29,00	16,74	15,00	28	76150	92	462
CJTHT-100-6T-3/DUPLEX-CAT2	950	10,30	5,90		2,20	16	37600	80	277
CJTHT-100-6T-4/DUPLEX-CAT2	945	15,00	8,70		3,00	20	41150	81	325
CJTHT-100-6T-5,5/DUPLEX-CAT2	970		11,00	6,35	4,00	26	47800	82	340

(\*) Los datos corresponden a un solo ventilador

## Características acústicas

Los valores indicados, se determinan mediante medidas de nivel de presión y potencia sonora en dB(A) obtenidas en campo libre a una distancia equivalente a dos veces la envergadura del ventilador más el diámetro de la hélice, con un mínimo de 1,5 mts.

Espectro de potencia sonora Lw(A) en dB(A) por banda de frecuencia en Hz

Modelo	63	125	250	500	1000	2000	4000	8000	Modelo	63	125	250	500	1000	2000	4000	8000
CJTHT-40-4T-0,75/DUPLEX-CAT2	33	54	61	66	69	65	58	47	CJTHT-71-6T-1/DUPLEX-CAT2	43	63	71	73	75	72	65	54
CJTHT-40-6T-0,75/DUPLEX-CAT2	23	44	51	56	59	55	48	37	CJTHT-71-6T-1,5/DUPLEX-CAT2	44	64	69	74	76	73	66	55
CJTHT-45-4T-0,75/DUPLEX-CAT2	37	58	65	70	73	69	62	51	CJTHT-80-4T-3/DUPLEX-CAT2	56	75	83	89	90	87	81	70
CJTHT-45-6T-0,75/DUPLEX-CAT2	25	46	53	58	61	57	50	39	CJTHT-80-4T-4/DUPLEX-CAT2	54	74	82	87	89	86	79	71
CJTHT-50-4T-1/DUPLEX-CAT2	41	61	69	74	76	73	66	55	CJTHT-80-4T-5,5/DUPLEX-CAT2	54	74	82	87	89	86	79	72
CJTHT-50-6T-0,75/DUPLEX-CAT2	30	50	58	63	65	62	55	44	CJTHT-80-6T-1,5/DUPLEX-CAT2	47	64	72	77	79	76	69	58
CJTHT-56-4T-1/DUPLEX-CAT2	45	65	73	78	80	77	70	59	CJTHT-80-6T-2/DUPLEX-CAT2	48	65	73	78	80	77	70	59
CJTHT-56-4T-1,5/DUPLEX-CAT2	46	66	74	79	81	78	71	60	CJTHT-80-6T-3/DUPLEX-CAT2	49	66	74	79	81	78	71	60
CJTHT-56-4T-2/DUPLEX-CAT2	47	67	75	80	82	79	72	61	CJTHT-80-6T-4/DUPLEX-CAT2	59	80	87	92	95	91	84	76
CJTHT-56-6T-0,75/DUPLEX-CAT2	35	55	63	68	70	67	60	49	CJTHT-90-4T-5,5/DUPLEX-CAT2	58	79	86	91	94	90	83	72
CJTHT-63-4T-1/DUPLEX-CAT2	47	67	75	80	82	79	72	61	CJTHT-90-4T-7,5/DUPLEX-CAT2	57	78	85	90	93	89	82	71
CJTHT-63-4T-1,5/DUPLEX-CAT2	46	66	74	79	81	78	71	62	CJTHT-90-4T-10/DUPLEX-CAT2	56	77	84	89	92	88	81	70
CJTHT-63-4T-2/DUPLEX-CAT2	49	66	74	79	81	78	71	63	CJTHT-90-6T-2/DUPLEX-CAT2	47	68	75	80	83	79	72	61
CJTHT-63-4T-3/DUPLEX-CAT2	50	68	76	81	83	80	75	64	CJTHT-90-6T-3/DUPLEX-CAT2	54	68	75	80	83	79	72	61
CJTHT-63-4T-4/DUPLEX-CAT2	51	69	77	82	84	81	76	65	CJTHT-90-6T-4/DUPLEX-CAT2	55	70	77	82	85	81	74	63
CJTHT-63-6T-0,75/DUPLEX-CAT2	40	58	66	71	73	70	63	54	CJTHT-100-4T-7,5/DUPLEX-CAT2	62	82	90	95	97	94	87	76
CJTHT-63-6T-1/DUPLEX-CAT2	41	60	68	73	75	72	65	55	CJTHT-100-4T-10/DUPLEX-CAT2	60	80	88	93	95	92	85	74
CJTHT-71-4T-1,5/DUPLEX-CAT2	52	72	80	85	87	84	77	66	CJTHT-100-4T-15/DUPLEX-CAT2	59	79	87	92	94	91	84	73
CJTHT-71-4T-2/DUPLEX-CAT2	51	71	79	84	86	83	76	67	CJTHT-100-4T-20/DUPLEX-CAT2	61	81	89	94	96	93	86	75
CJTHT-71-4T-3/DUPLEX-CAT2	55	70	78	83	85	82	75	69	CJTHT-100-6T-3/DUPLEX-CAT2	60	71	79	84	86	83	76	65
CJTHT-71-4T-4/DUPLEX-CAT2	56	71	79	84	86	83	76	70	CJTHT-100-6T-4/DUPLEX-CAT2	61	69	77	82	84	81	74	63
CJTHT-71-6T-0,75/DUPLEX-CAT2	42	62	70	73	75	72	65	54	CJTHT-100-6T-5,5/DUPLEX-CAT2	62	71	79	84	86	83	76	65

**Dimensiones mm**

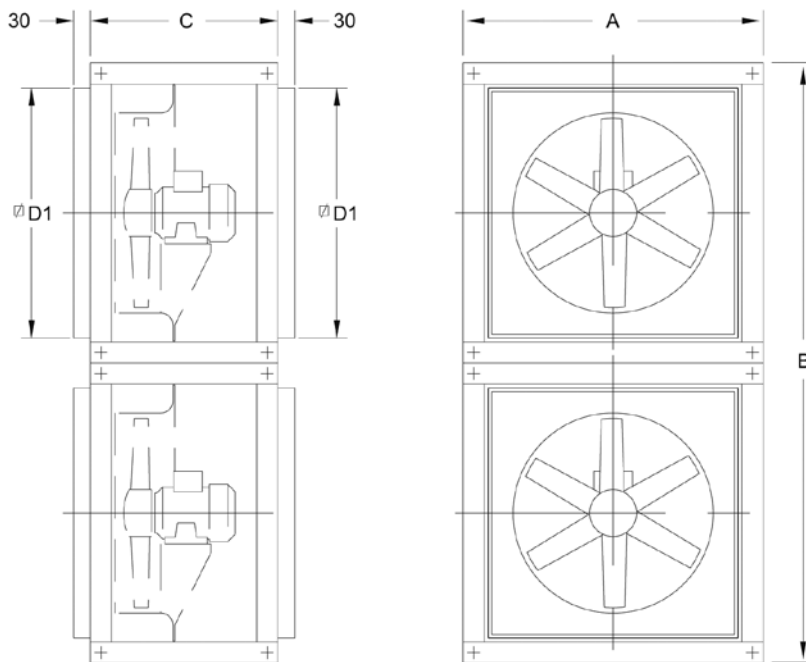

Modelo	ØA	B	C	ØD1
CJTHT/DUPLEX-40/45/50	700	1400	550	565
CJTHT/DUPLEX-56/63	825	1650	550	690
CJTHT/DUPLEX-71/80	1000	2000	650	850
CJTHT/DUPLEX-90/100	1200	2400	750	1050

**Curvas Características**

Ver curvas características en la página 33.

**Accesorios**

Ver apartado accesorios





## EJEMPLO SELECCIÓN

### Curvas características

THT CJTHT/PLUS CJTHT CJTHT/DUPLEX/ATEX

Q= Caudal en m<sup>3</sup>/h, m<sup>3</sup>/s y cfm.

Pe= Presión estática en mmH<sub>2</sub>O, Pa e inwg.

**Diámetro Hélice (cm): 71**

**Número de polos: 6**

**Número de palas: 6**

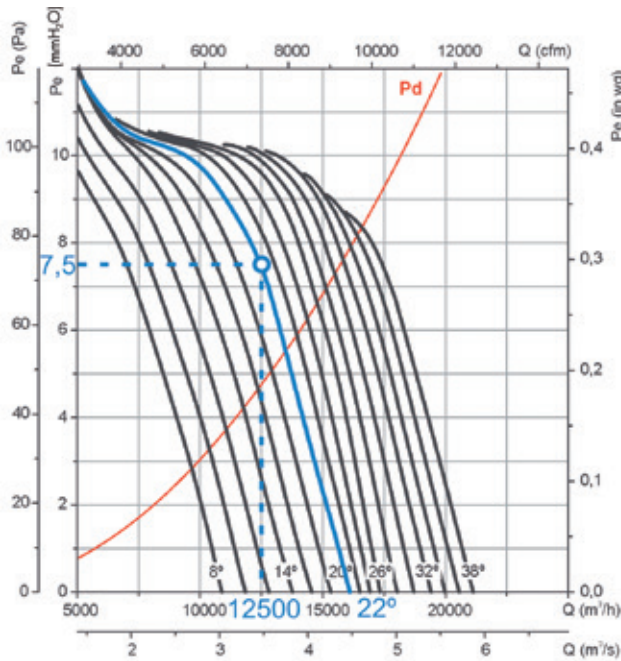

### Datos de partida

- Punto de trabajo:
- Caudal: 12.500 m<sup>3</sup>/h
- Pérdida de carga: 7,5 mmH<sub>2</sub>O

### Pasos para la selección del equipo

#### En la gráfica de presiones:

1. Marcar el punto de trabajo, definido por el caudal de trabajo (12.500 m<sup>3</sup>/h) y la pérdida de carga (7,5 mmH<sub>2</sub>O).
2. Escoger la curva del equipo que más se acerque por encima al punto de trabajo. En nuestro caso se obtiene una curva de 22° de ángulo de pala.

#### En la gráfica de potencia:

3. Marcar el punto de trabajo, definido por el caudal de trabajo (12.500 m<sup>3</sup>/h) y la curva de ángulo de pala escogido (22°).
4. Leer la potencia absorbida en el eje de potencias a la izquierda. La Pa= 560 W en el punto de trabajo.
5. Buscar recta roja que más se acerque al punto de trabajo por encima. En la parte derecha de la gráfica se obtiene el valor de potencia instalada de motor. En nuestro caso 0,75 kW o 1 CV.

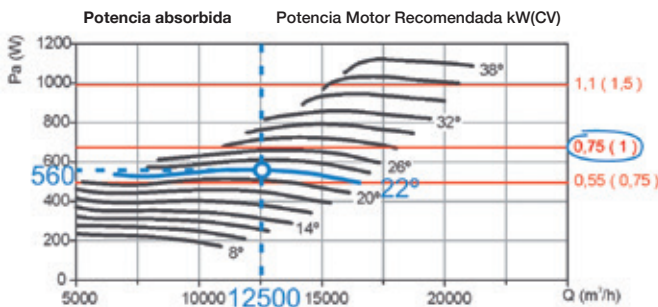

## EJEMPLO CÓDIGO PEDIDO

<b>THT</b>	<b>—</b>	<b>71</b>	<b>—</b>	<b>6T</b>	<b>—</b>	<b>1</b>	<b>—</b>	<b>6-22</b>	<b>—</b>	<b>F-400</b>
Nombre de serie: THT CJTHT/PLUS CJTHT CJTHT/DUPLEX/ATEX	Diámetro hélice en cm.	Número de polos motor 2=2900 r/min. 50 Hz 4=1400 r/min. 50 Hz 6=900 r/min. 50 Hz 8=750 r/min. 50 Hz 12=500 r/min. 50 Hz	T=Trifásico M=Monofásico	Potencia motor (c.v.)	Número de palas 3 palas 6 palas 9 palas	Angulo incli- nación palas	F-200: Homologación 200°C/2h F-300: Homologación 300°C/2h F-400: Homologación 400°C/2h CAT3: Con certificación ATEX Categoría 3 Ex II3G			

**Curvas características**

THT CJTHT/PLUS CJTHT CJTHT/DUPLEX/ATEX

Q= Caudal en m³/h, m³/s y cfm.

Pe= Presión estática en mmH2O, Pa e inwg.

**Diámetro Hélice (cm): 40**

**Número de polos: 2**

**Número de palas: 6**

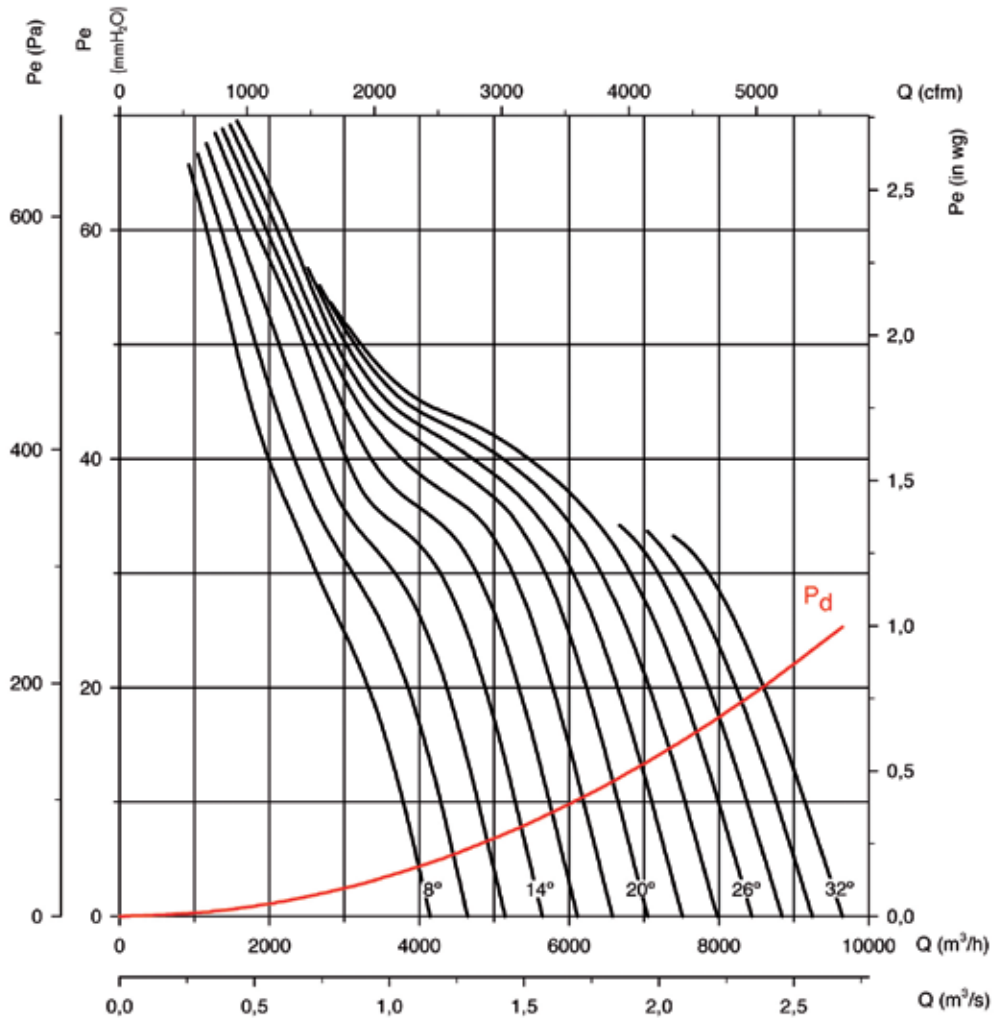

**Potencia absorbida**

**Potencia Motor Recomendada kW(CV)**

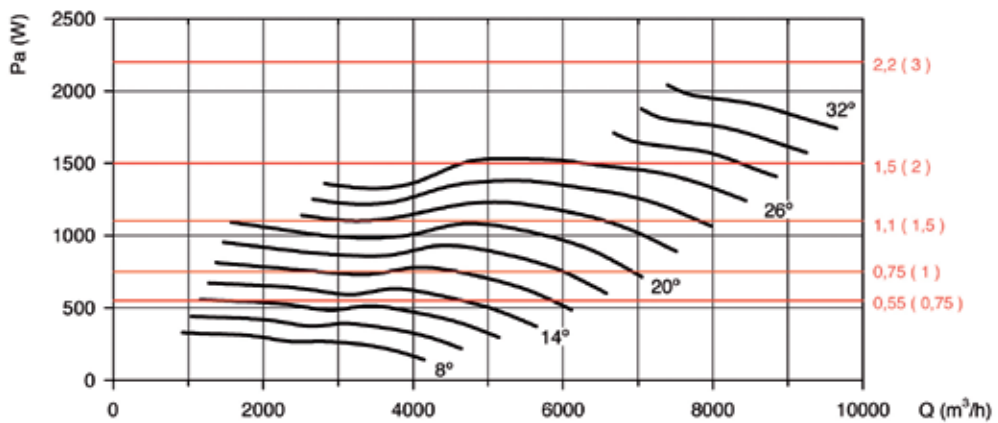

Consultar características del punto de máxima eficiencia (BEP) al final de la serie.

# THT CJTHT/PLUS CJTHT CJTHT/DUPLEX/ATEX

## Curvas características

THT CJTHT/PLUS CJTHT CJTHT/DUPLEX/ATEX

Q= Caudal en m<sup>3</sup>/h, m<sup>3</sup>/s y cfm.

Pe= Presión estática en mmH<sub>2</sub>O, Pa e inwg.

Diámetro Hélice (cm): 40

Número de polos: 4

Número de palas: 6

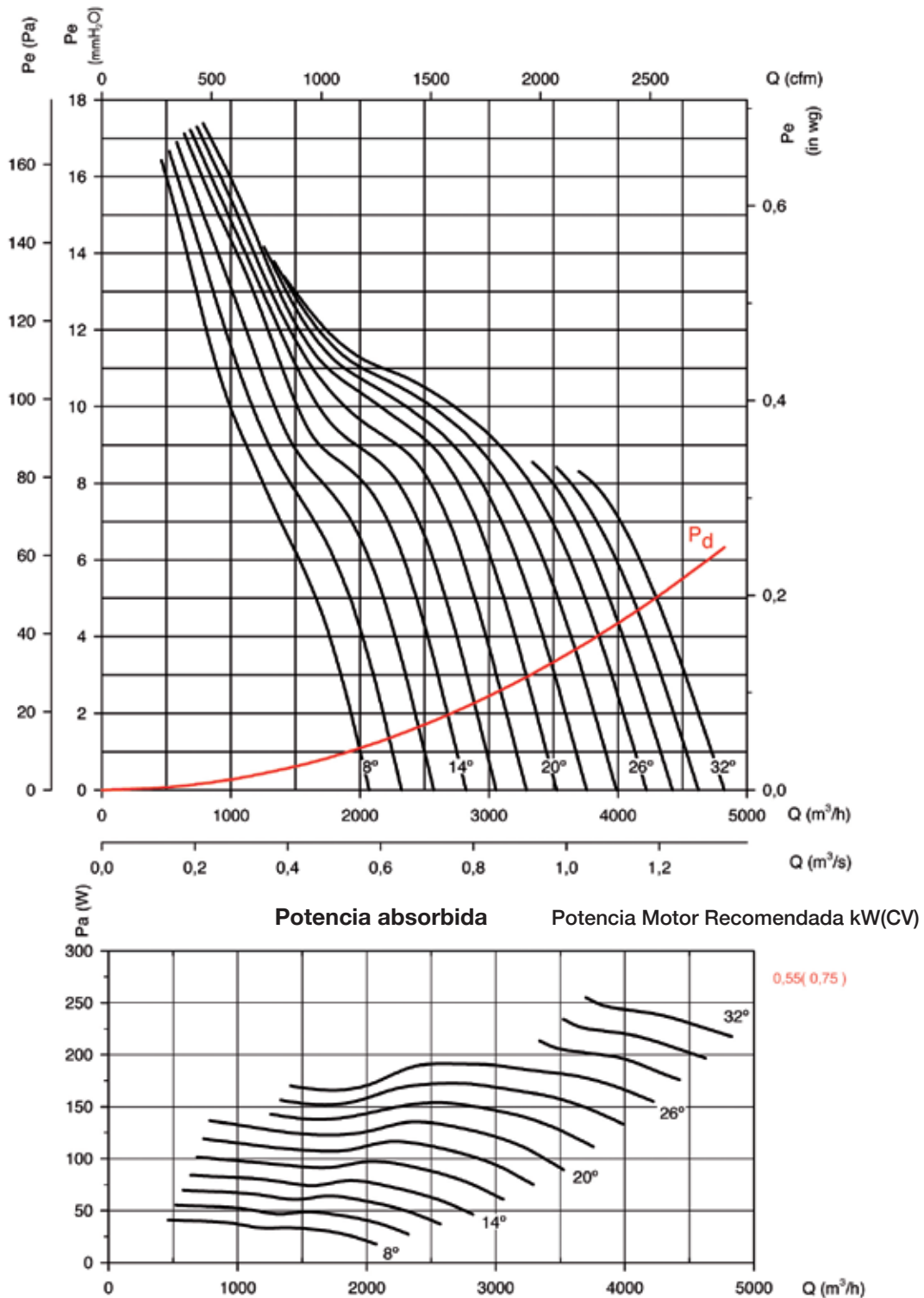

Consultar características del punto de máxima eficiencia (BEP) al final de la serie.

**Curvas características**

THT CJTHT/PLUS CJTHT CJTHT/DUPLEX/ATEX

Q= Caudal en m³/h, m³/s y cfm.

Pe= Presión estática en mmH2O, Pa e inwg.

**Diámetro Hélice (cm): 40**

**Número de polos: 6**

**Número de palas: 6**

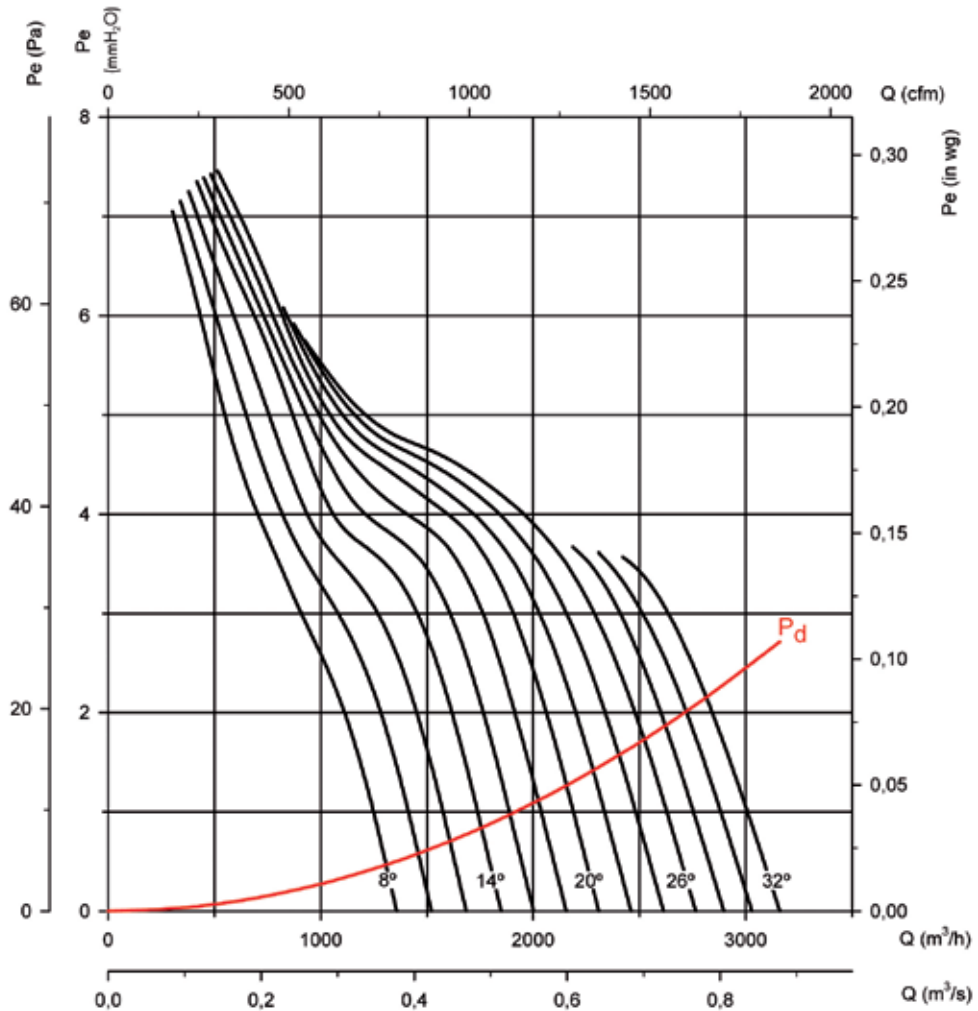

**Potencia absorbida**

**Potencia Motor Recomendada kW(CV)**

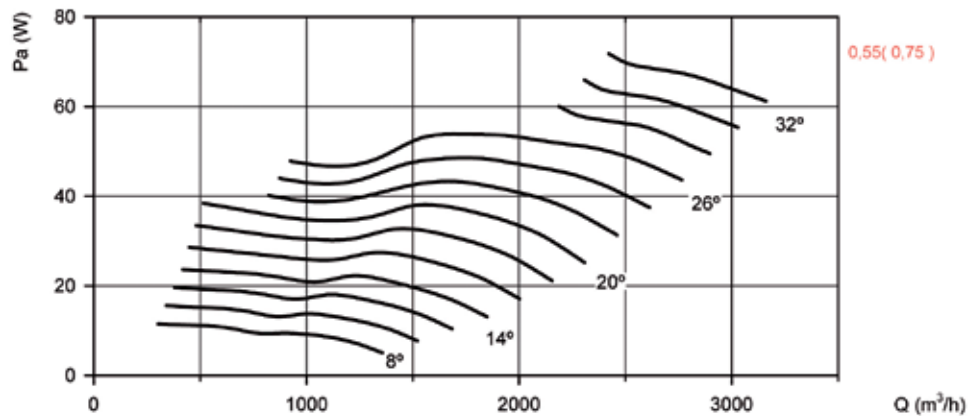

Consultar características del punto de máxima eficiencia (BEP) al final de la serie.

# THT CJTHT/PLUS CJTHT CJTHT/DUPLEX/ATEX

## Curvas características

THT CJTHT/PLUS CJTHT CJTHT/DUPLEX/ATEX

Q= Caudal en m<sup>3</sup>/h, m<sup>3</sup>/s y cfm.

Pe= Presión estática en mmH<sub>2</sub>O, Pa e inwg.

**Diámetro Hélice (cm): 45**

**Número de polos: 2**

**Número de palas: 6**

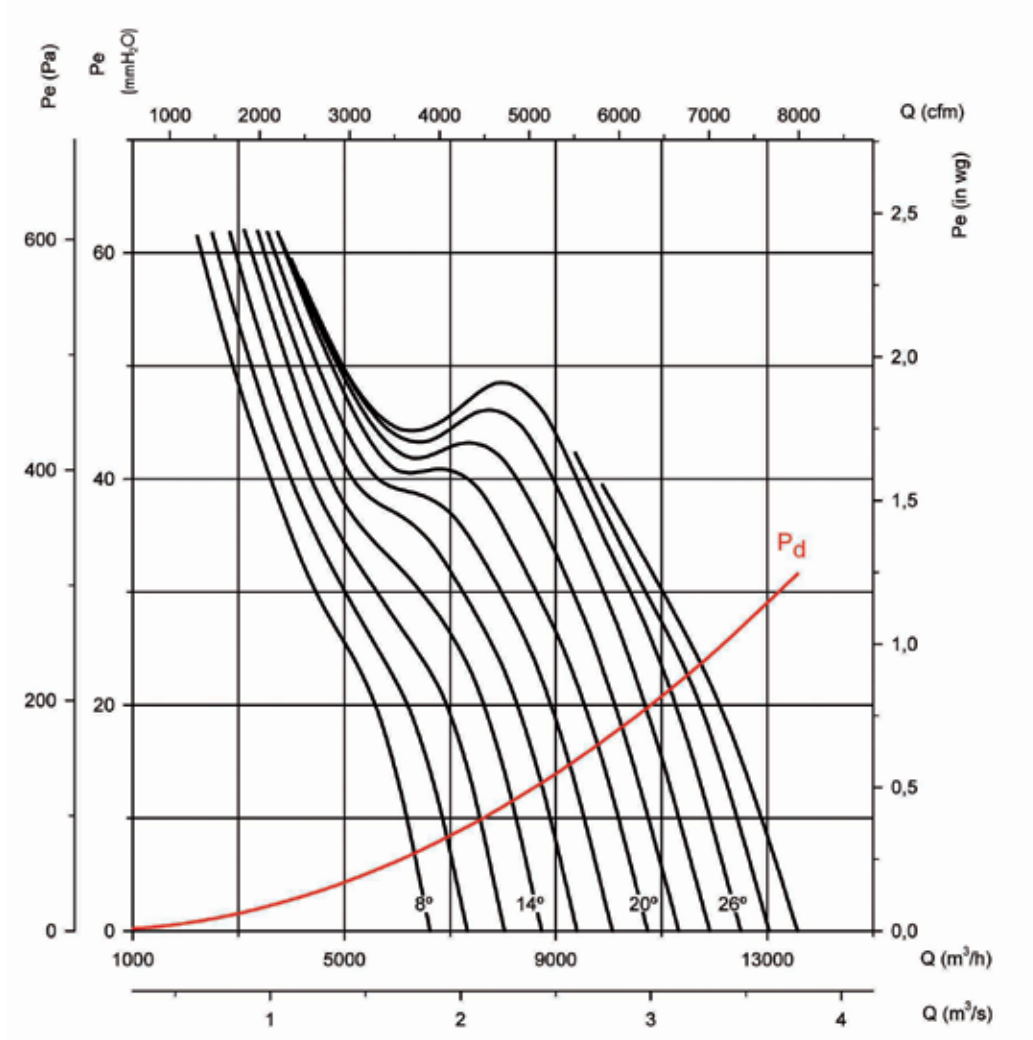

Potencia absorbida

Potencia Motor Recomendada kW(CV)

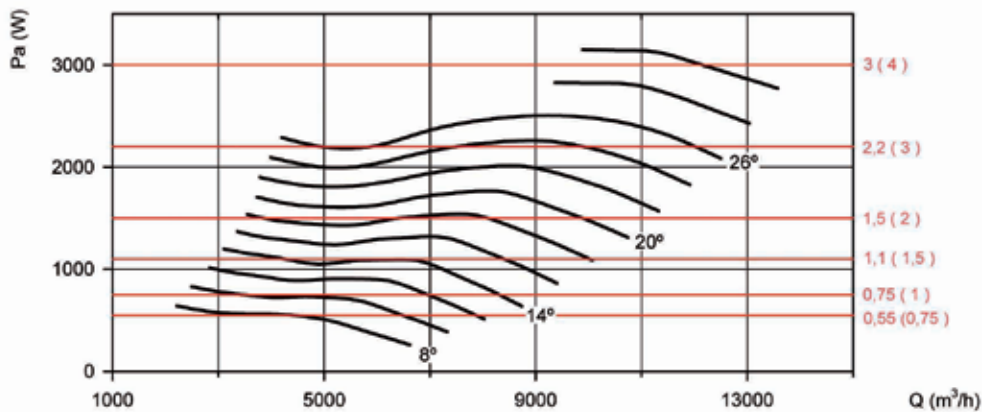

Consultar características del punto de máxima eficiencia (BEP) al final de la serie.

**Curvas características**

THT CJTHT/PLUS CJTHT CJTHT/DUPLEX/ATEX

Q= Caudal en m³/h, m³/s y cfm.

Pe= Presión estática en mmH2O, Pa e inwg.

**Diámetro Hélice (cm): 45**

**Número de polos: 4**

**Número de palas: 6**

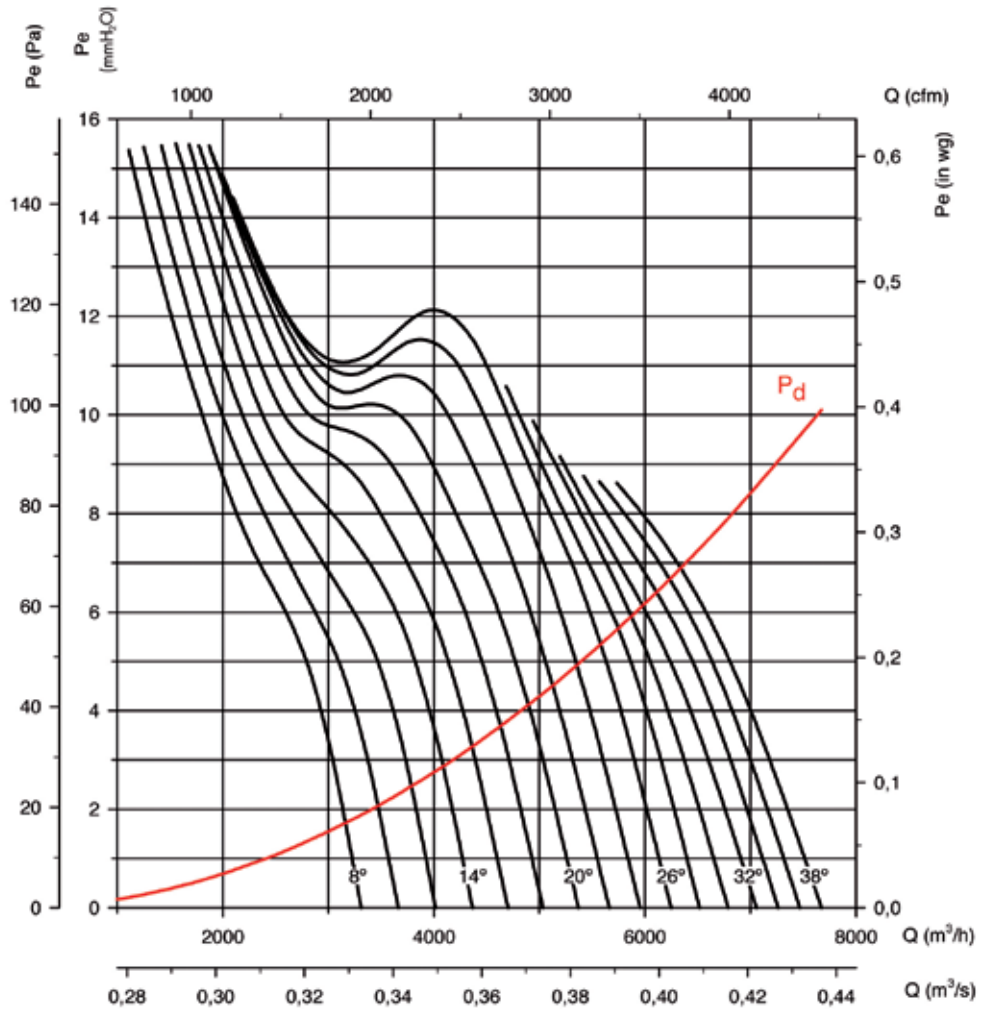

**Potencia absorbida**

**Potencia Motor Recomendada kW(CV)**

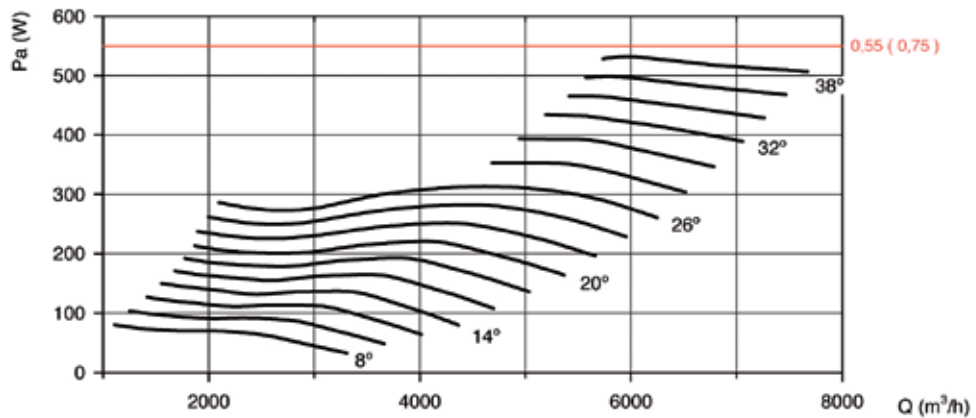

Consultar características del punto de máxima eficiencia (BEP) al final de la serie.

# THT CJTHT/PLUS CJTHT CJTHT/DUPLEX/ATEX

## Curvas características

THT CJTHT/PLUS CJTHT CJTHT/DUPLEX/ATEX

Q= Caudal en m<sup>3</sup>/h, m<sup>3</sup>/s y cfm.

Pe= Presión estática en mmH<sub>2</sub>O, Pa e inwg.

**Diámetro Hélice (cm): 45**

**Número de polos: 6**

**Número de palas: 6**

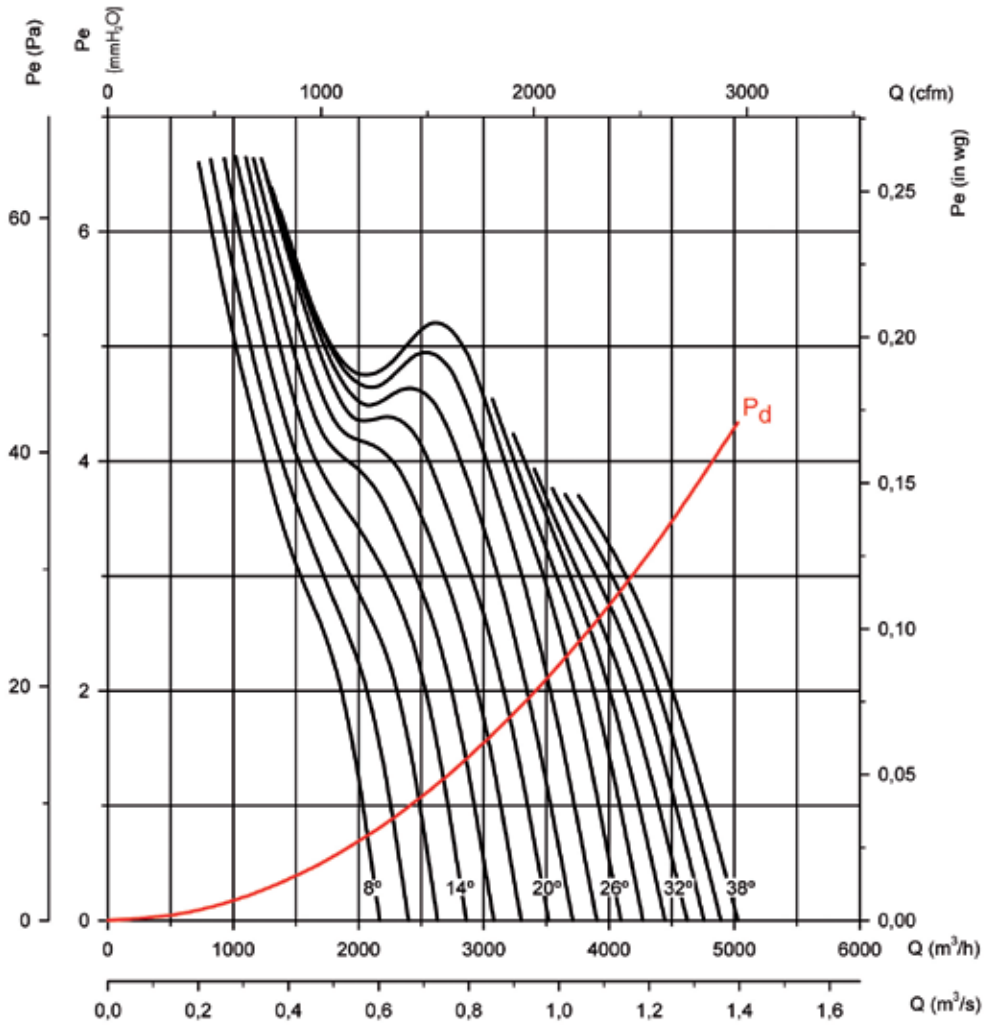

Potencia absorbida

Potencia Motor Recomendada kW(CV)

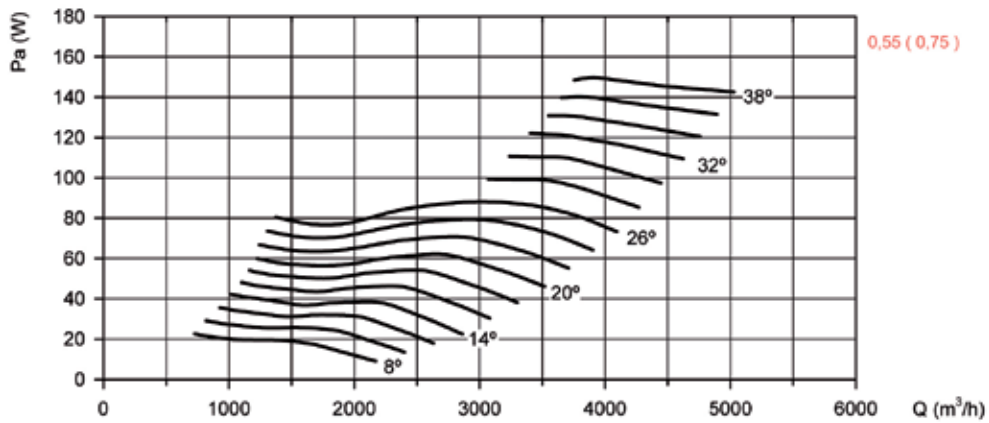

Consultar características del punto de máxima eficiencia (BEP) al final de la serie.

**Curvas características**

THT CJTHT/PLUS CJTHT CJTHT/DUPLEX/ATEX

Q= Caudal en m<sup>3</sup>/h, m<sup>3</sup>/s y cfm.

Pe= Presión estática en mmH<sub>2</sub>O, Pa e inwg.

**Diámetro Hélice (cm): 50**

**Número de polos: 2**

**Número de palas: 6**

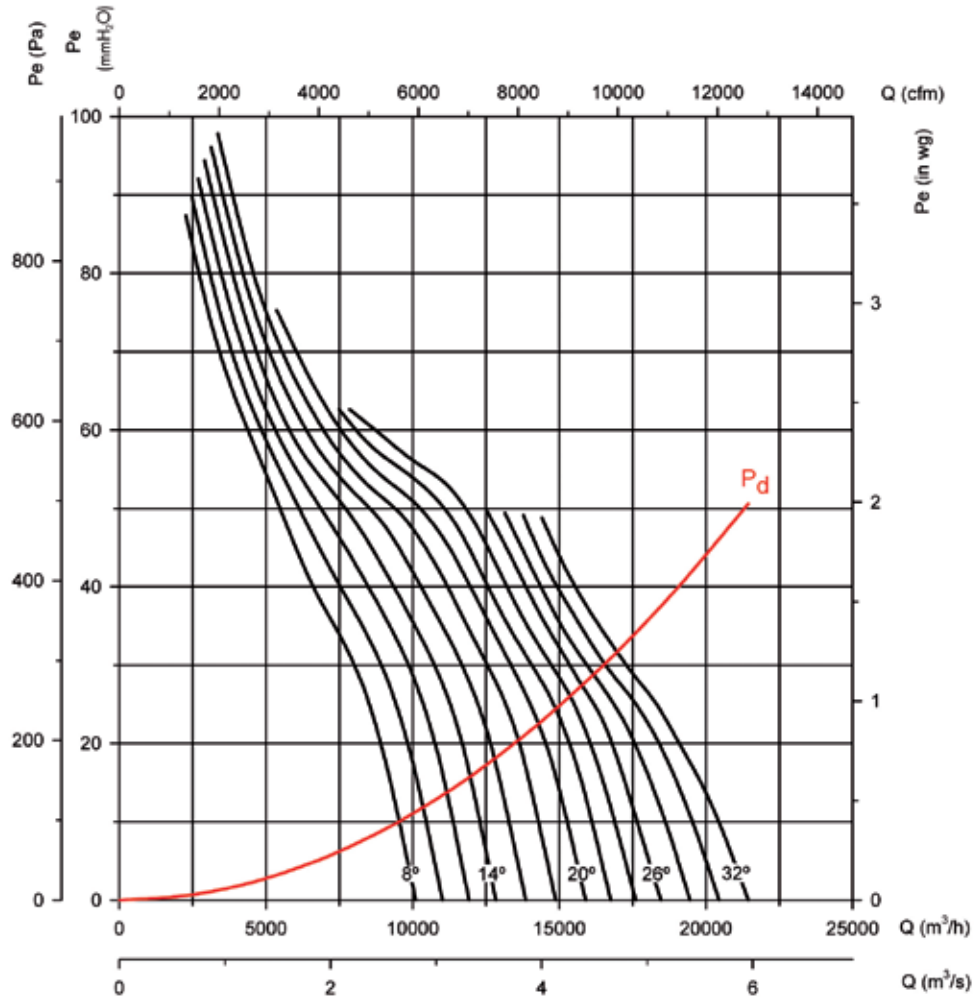

Potencia absorbida

Potencia Motor Recomendada kW(CV)

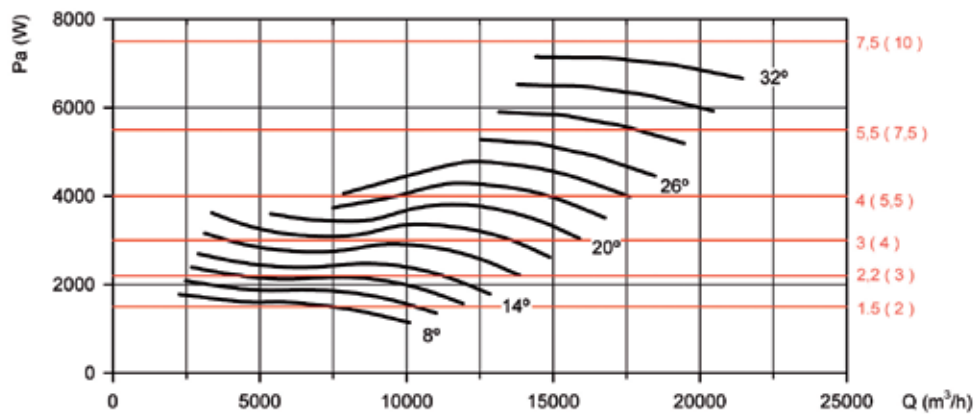

Consultar características del punto de máxima eficiencia (BEP) al final de la serie.



# THT CJTHT/PLUS CJTHT CJTHT/DUPLEX/ATEX

## Curvas características

THT CJTHT/PLUS CJTHT CJTHT/DUPLEX/ATEX

Q= Caudal en m<sup>3</sup>/h, m<sup>3</sup>/s y cfm.

Pe= Presión estática en mmH<sub>2</sub>O, Pa e inwg.

**Diámetro Hélice (cm): 50**

**Número de polos: 4**

**Número de palas: 6**

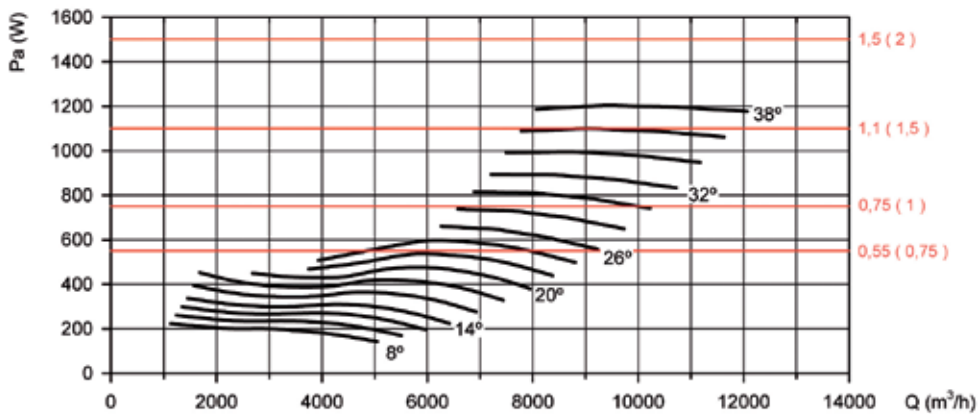
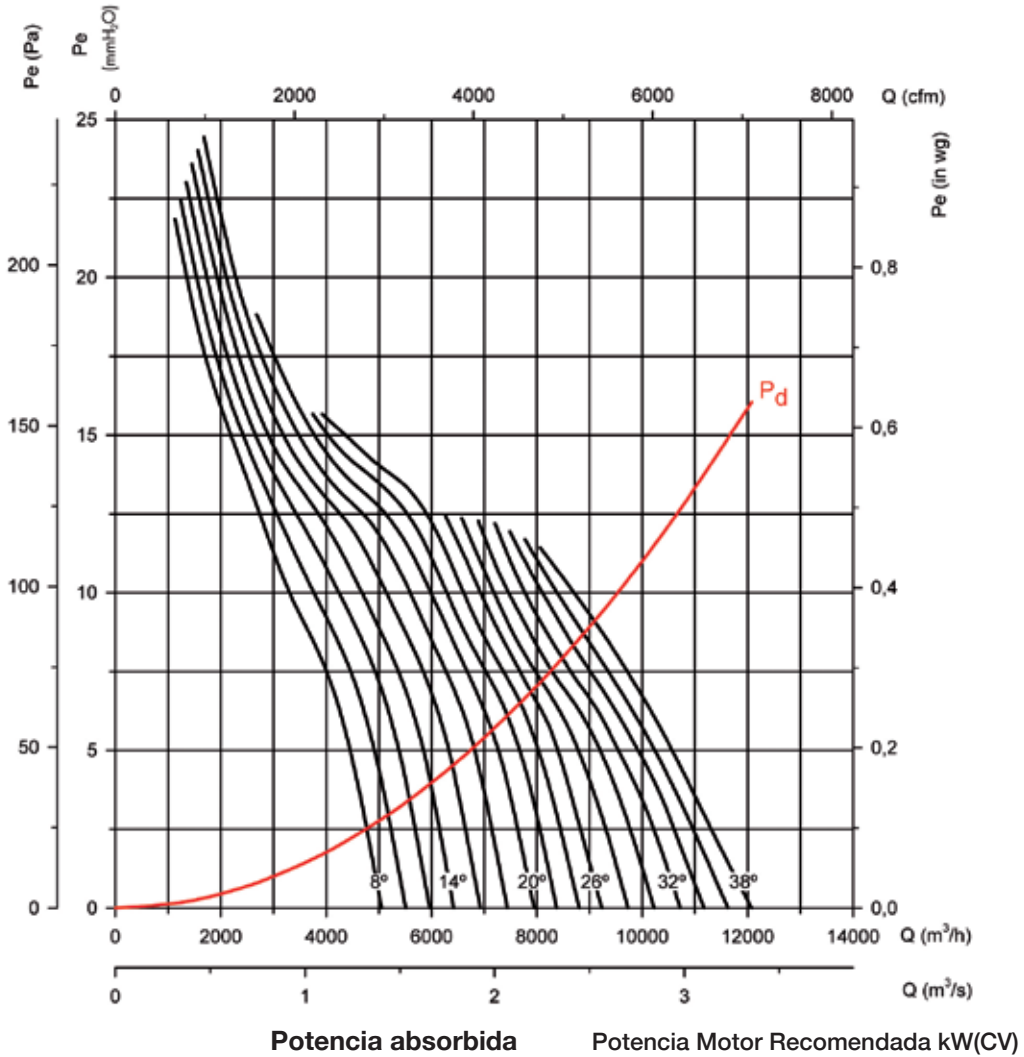

Consultar características del punto de máxima eficiencia (BEP) al final de la serie.

**Curvas características**

THT CJTHT/PLUS CJTHT CJTHT/DUPLEX/ATEX

Q= Caudal en m<sup>3</sup>/h, m<sup>3</sup>/s y cfm.

Pe= Presión estática en mmH<sub>2</sub>O, Pa e inwg.

**Diámetro Hélice (cm): 50**

**Número de polos: 6**

**Número de palas: 6**

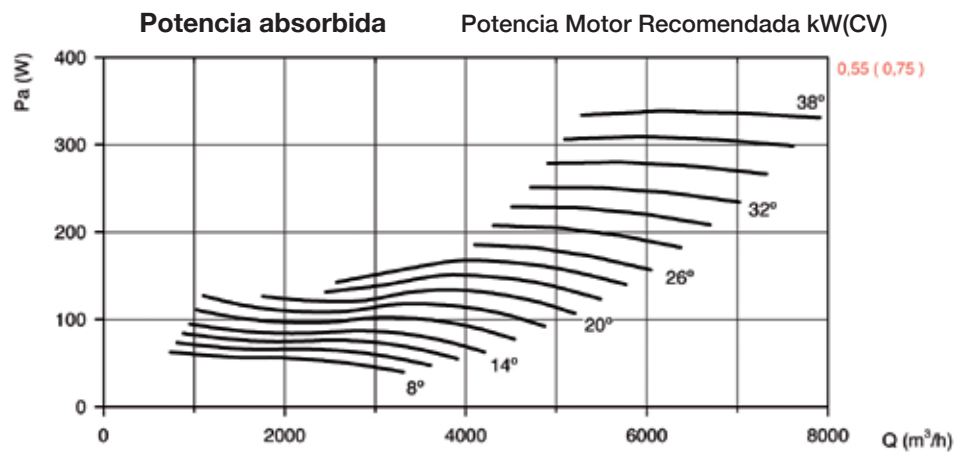
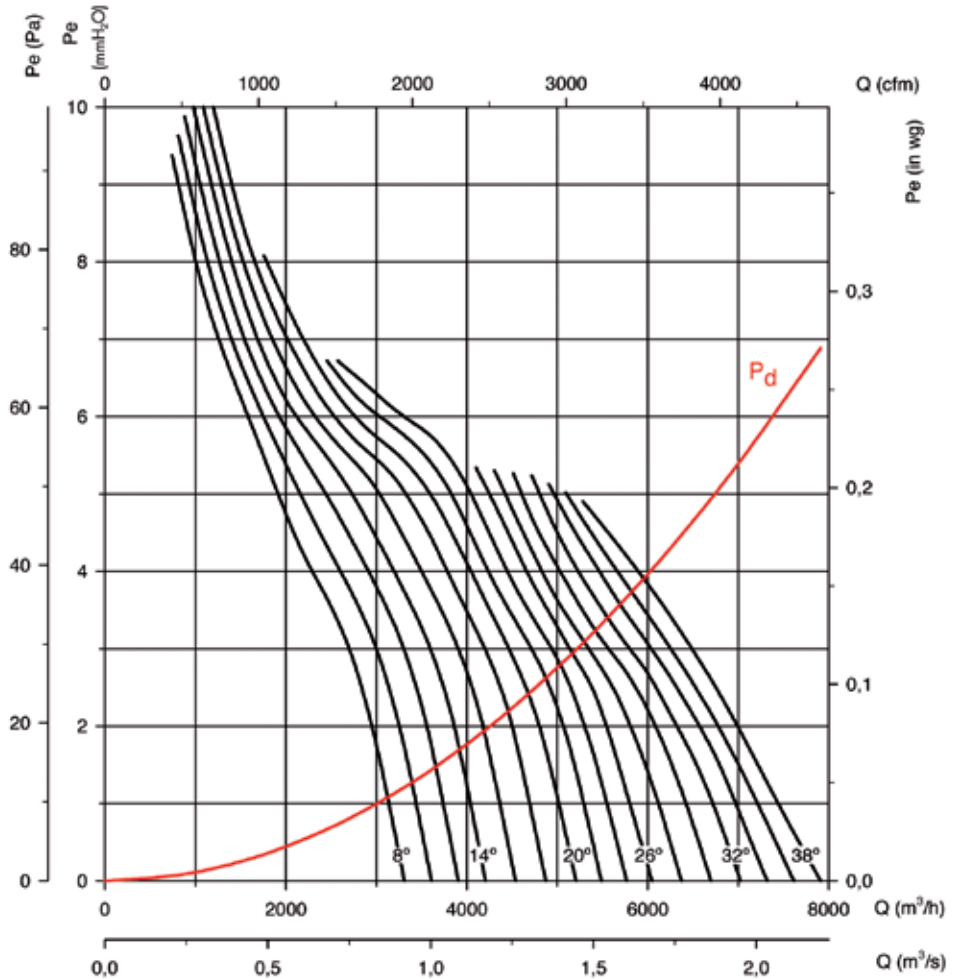

Consultar características del punto de máxima eficiencia (BEP) al final de la serie.

# THT CJTHT/PLUS CJTHT CJTHT/DUPLEX/ATEX

## Curvas características

THT CJTHT/PLUS CJTHT CJTHT/DUPLEX/ATEX

Q= Caudal en m<sup>3</sup>/h, m<sup>3</sup>/s y cfm.

Pe= Presión estática en mmH<sub>2</sub>O, Pa e inwg.

**Diámetro Hélice (cm): 56**

**Número de polos: 2**

**Número de palas: 6**

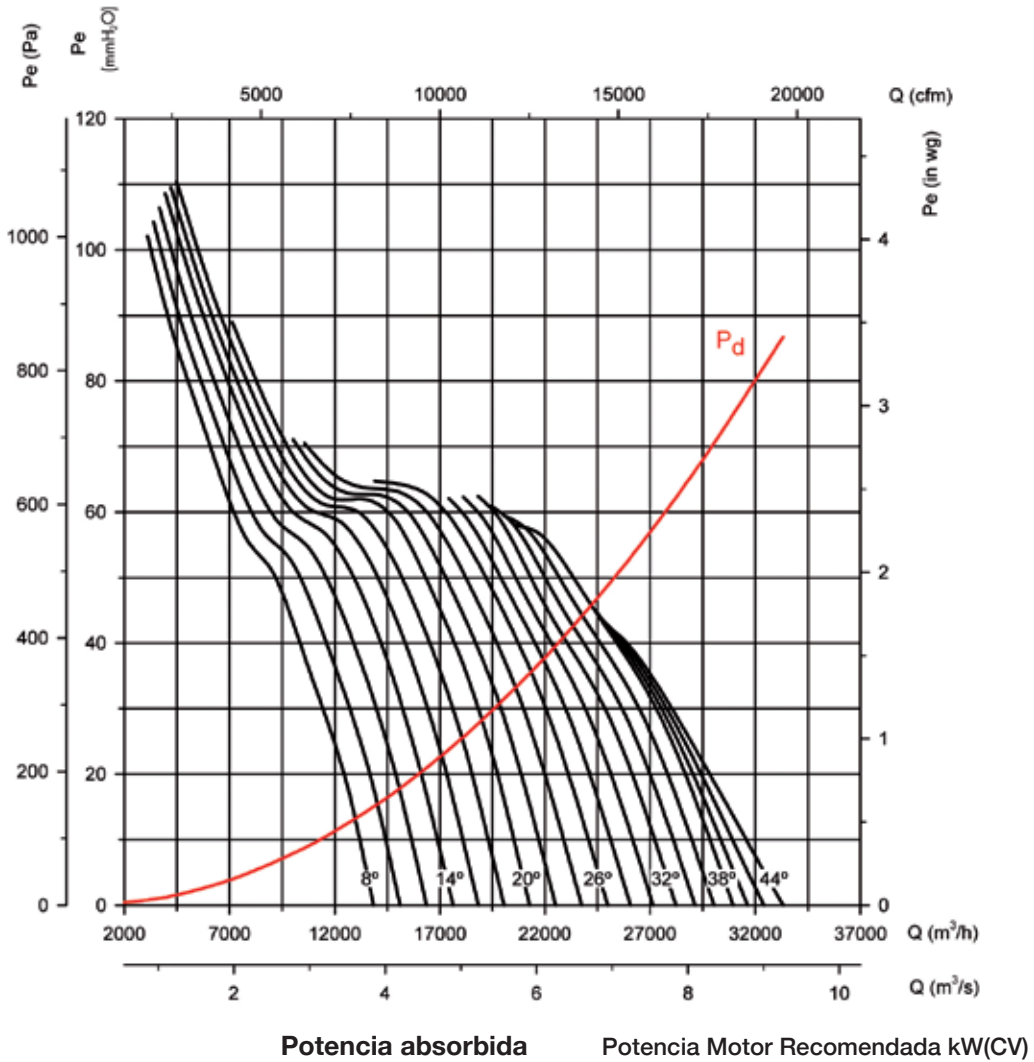

Potencia absorbida

Potencia Motor Recomendada kW(CV)

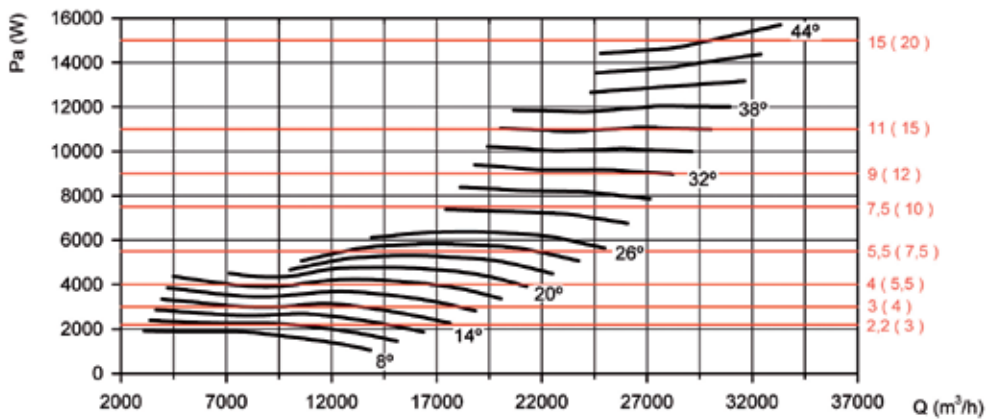

Consultar características del punto de máxima eficiencia (BEP) al final de la serie.

**Curvas características**

THT CJTHT/PLUS CJTHT CJTHT/DUPLEX/ATEX

Q= Caudal en m³/h, m³/s y cfm.

Pe= Presión estática en mmH2O, Pa e inwg.

**Diámetro Hélice (cm): 56**

**Número de polos: 4**

**Número de palas: 6**

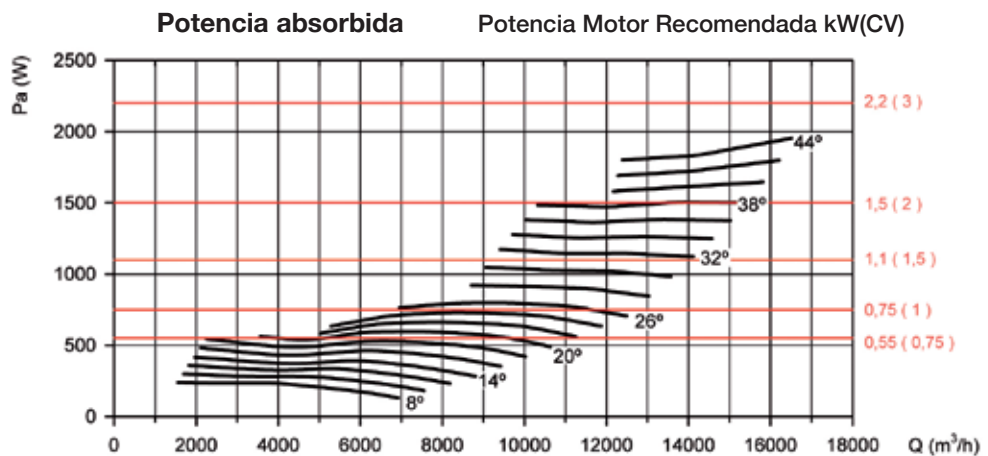
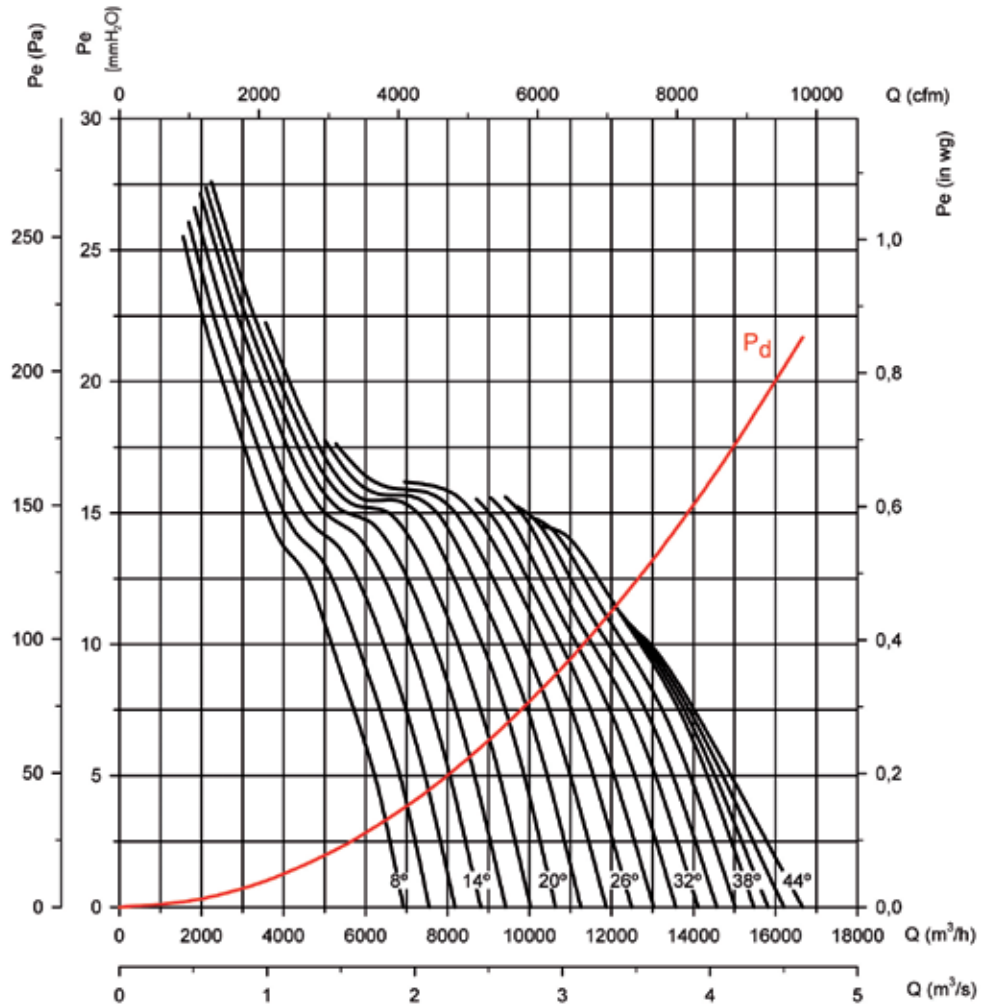

Consultar características del punto de máxima eficiencia (BEP) al final de la serie.

# THT CJTHT/PLUS CJTHT CJTHT/DUPLEX/ATEX

## Curvas características

THT CJTHT/PLUS CJTHT CJTHT/DUPLEX/ATEX

Q= Caudal en m<sup>3</sup>/h, m<sup>3</sup>/s y cfm.

Pe= Presión estática en mmH<sub>2</sub>O, Pa e inwg.

**Diámetro Hélice (cm): 56**

**Número de polos: 6**

**Número de palas: 6**

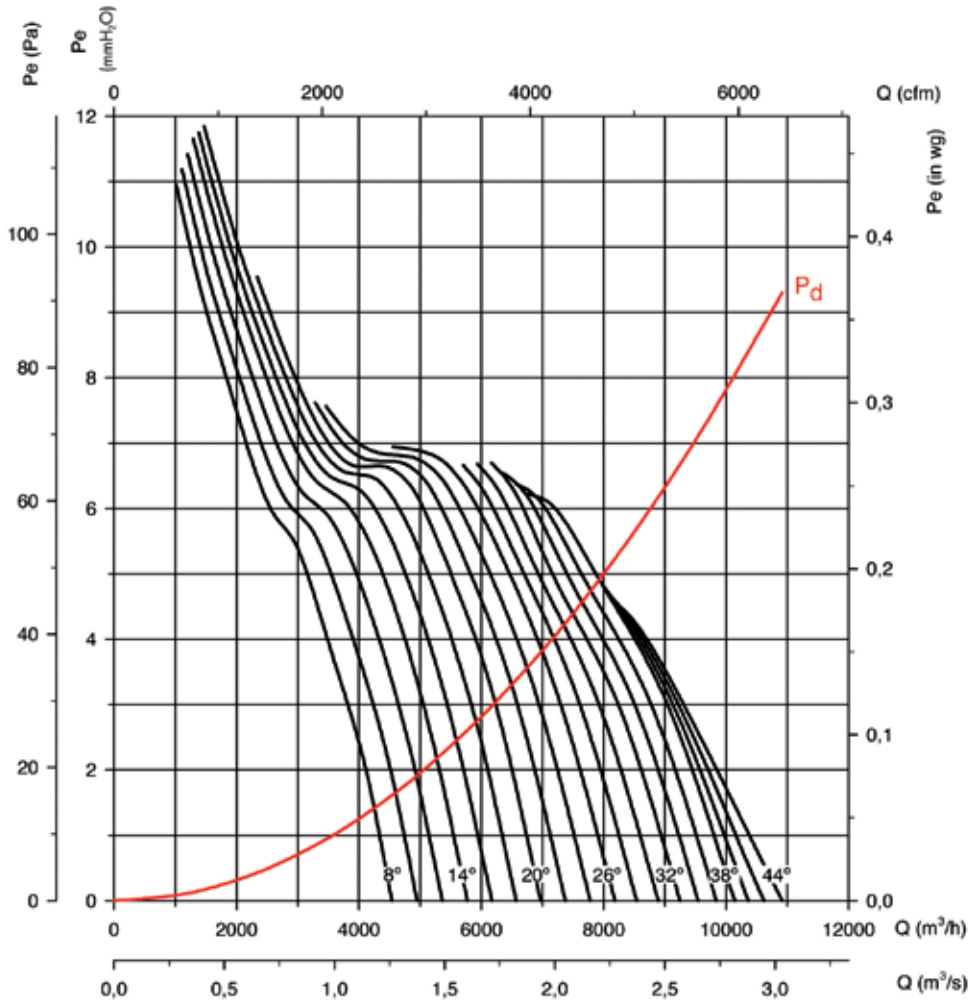

Potencia absorbida

Potencia Motor Recomendada kW(CV)

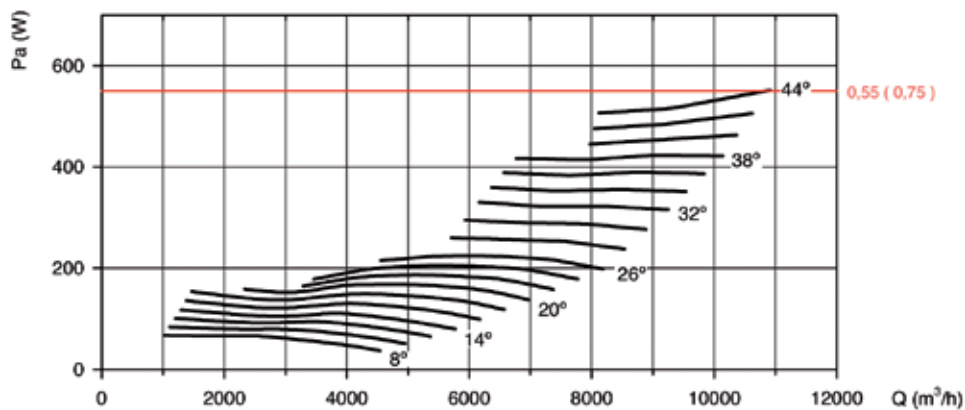

Consultar características del punto de máxima eficiencia (BEP) al final de la serie.

Curvas características

THT CJTHT/PLUS CJTHT CJTHT/DUPLEX/ATEX

Q= Caudal en m<sup>3</sup>/h, m<sup>3</sup>/s y cfm.

Pe= Presión estática en mmH<sub>2</sub>O, Pa e inwg.

Diámetro Hélice (cm): 63

Número de polos: 2

Número de palas: 6

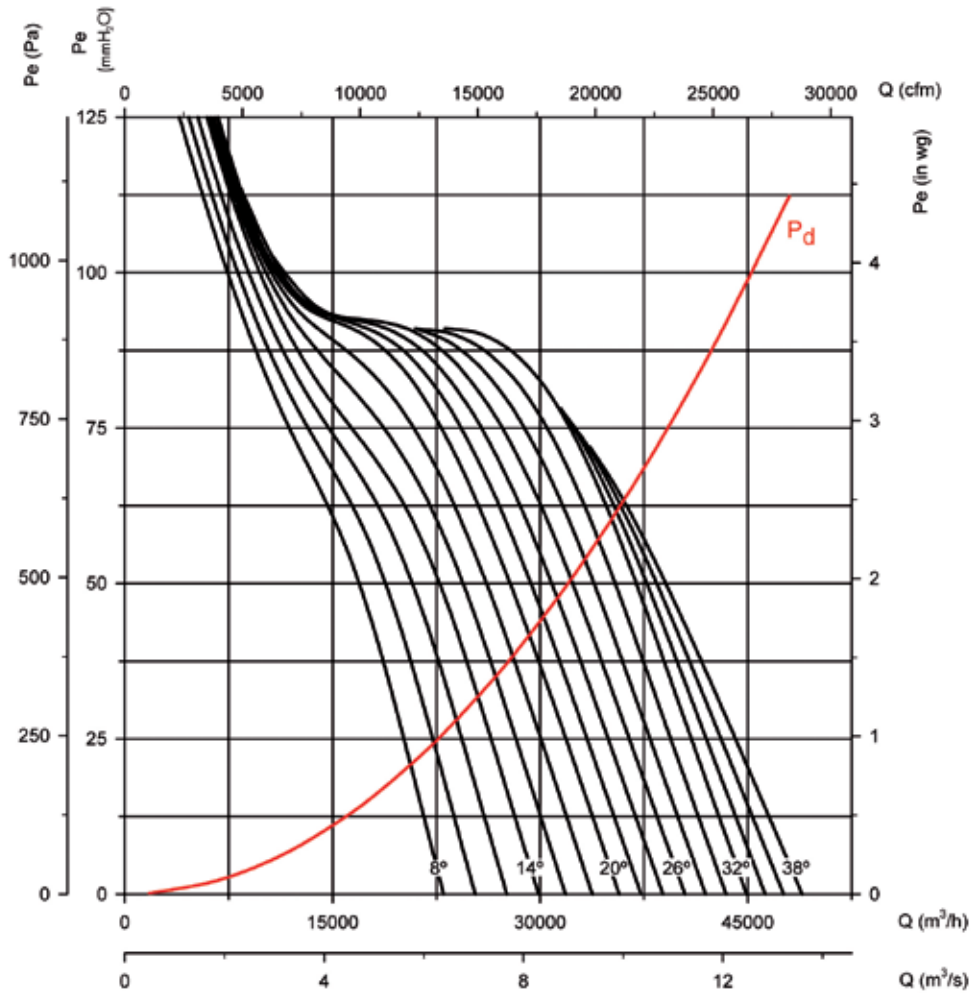

Potencia absorbida

Potencia Motor Recomendada kW(CV)

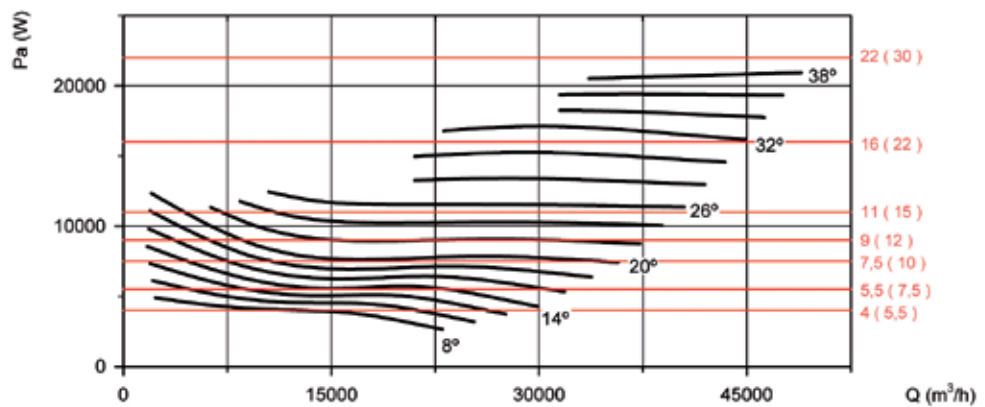

Consultar características del punto de máxima eficiencia (BEP) al final de la serie.

# THT CJTHT/PLUS CJTHT CJTHT/DUPLEX/ATEX

## Curvas características

THT CJTHT/PLUS CJTHT CJTHT/DUPLEX/ATEX

Q= Caudal en m<sup>3</sup>/h, m<sup>3</sup>/s y cfm.

Pe= Presión estática en mmH<sub>2</sub>O, Pa e inwg.

**Diámetro Hélice (cm): 63**

**Número de polos: 4**

**Número de palas: 6**

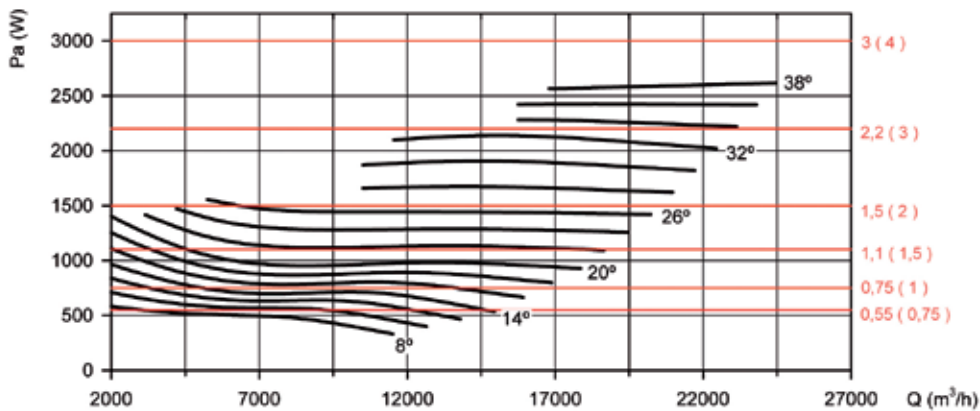
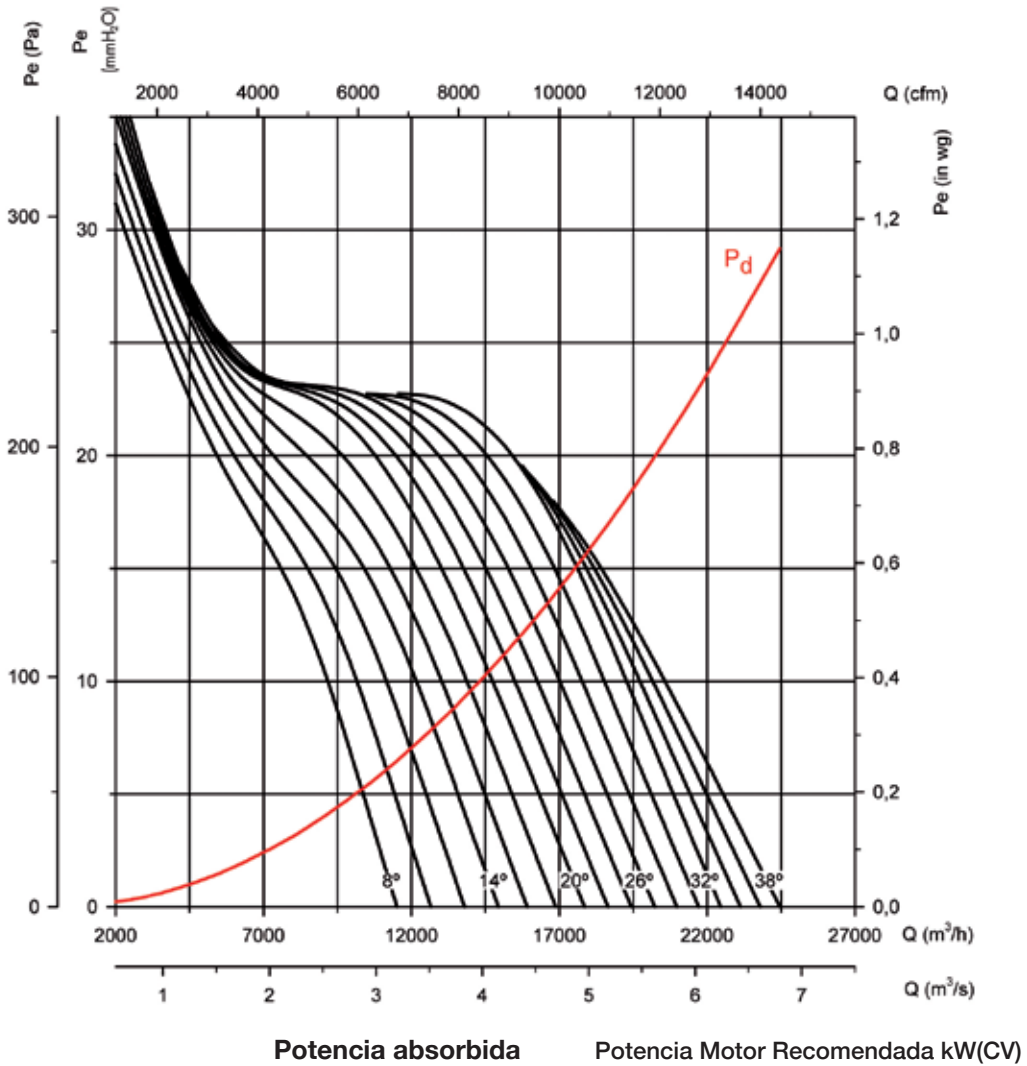

Consultar características del punto de máxima eficiencia (BEP) al final de la serie.

**Curvas características**

THT

CJTHT/PLUS

CJTHT

CJTHT/DUPLEX/ATEX

Q= Caudal en m<sup>3</sup>/h, m<sup>3</sup>/s y cfm.

Pe= Presión estática en mmH<sub>2</sub>O, Pa e inwg.

**Diámetro Hélice (cm): 63**

**Número de polos: 6**

**Número de palas: 6**

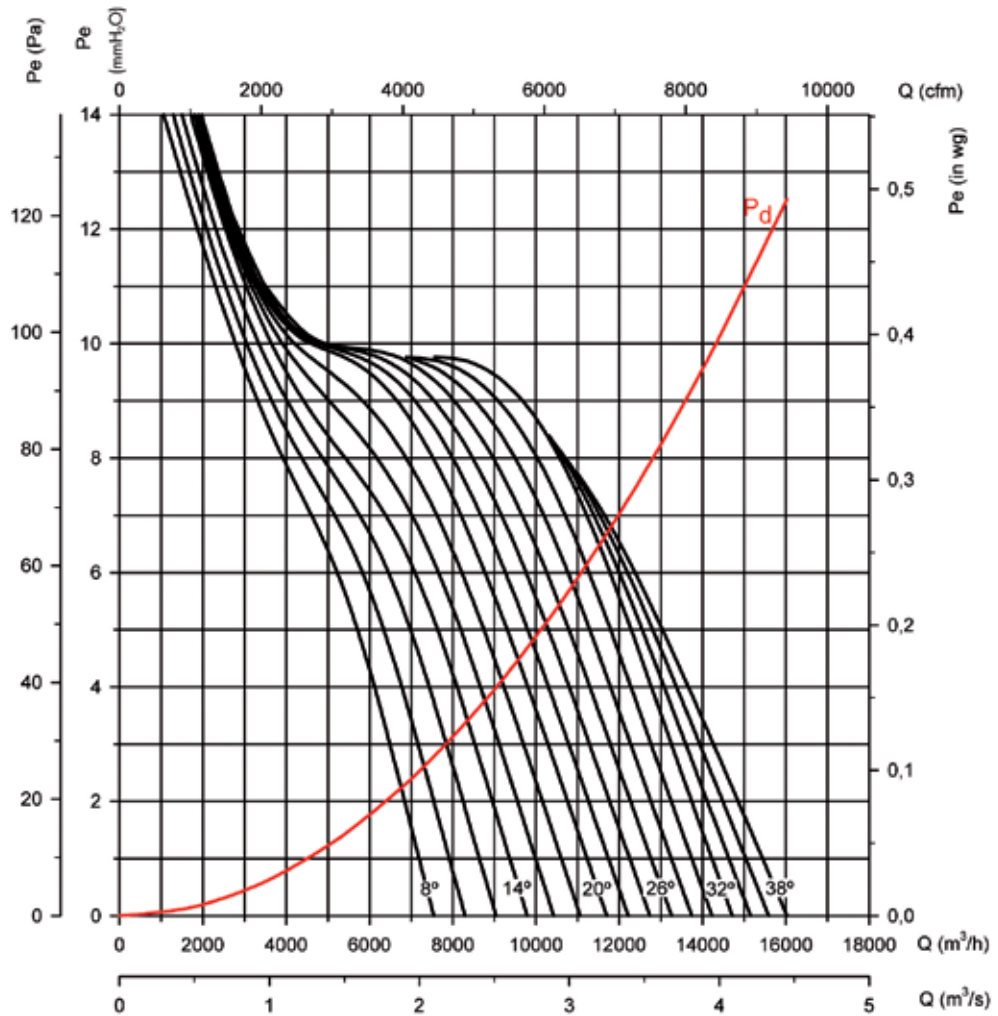

**Potencia absorbida**

**Potencia Motor Recomendada kW(CV)**

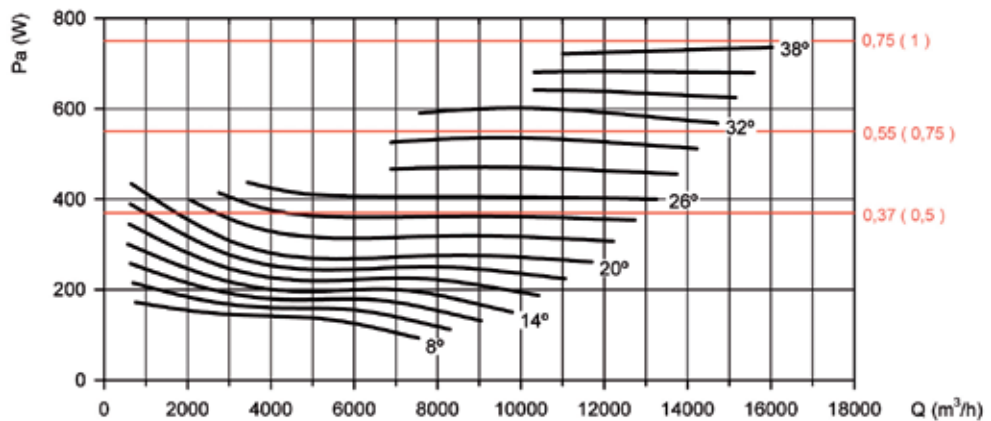

Consultar características del punto de máxima eficiencia (BEP) al final de la serie.



# THT CJTHT/PLUS CJTHT CJTHT/DUPLEX/ATEX

## Curvas características

THT CJTHT/PLUS CJTHT CJTHT/DUPLEX/ATEX

Q= Caudal en m<sup>3</sup>/h, m<sup>3</sup>/s y cfm.

Pe= Presión estática en mmH<sub>2</sub>O, Pa e inwg.

**Diámetro Hélice (cm): 71**

**Número de polos: 4**

**Número de palas: 6**

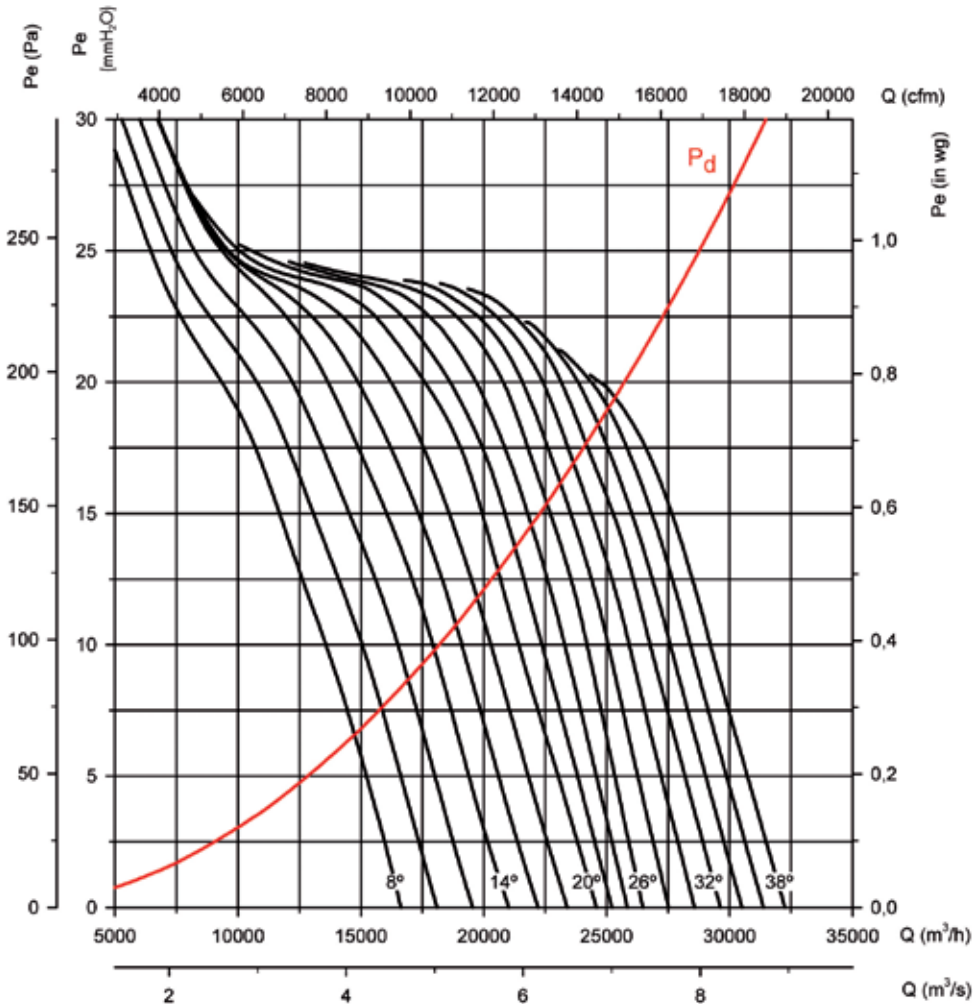

Potencia absorbida

Potencia Motor Recomendada kW(CV)

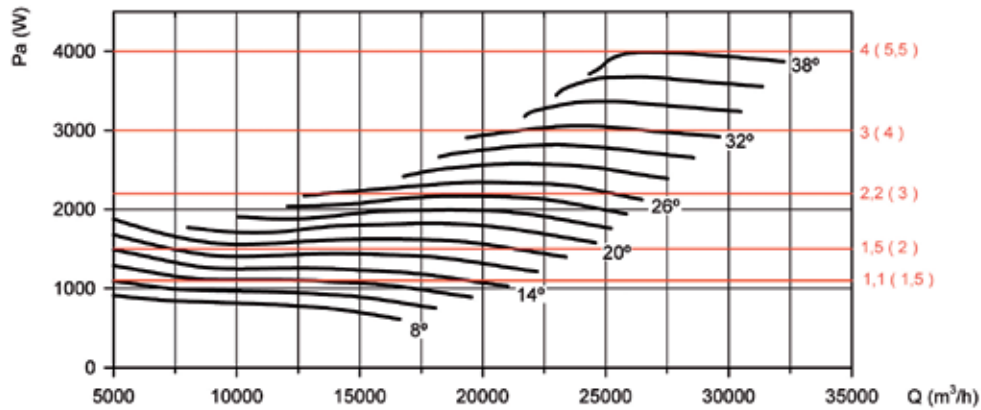

Consultar características del punto de máxima eficiencia (BEP) al final de la serie.

**Curvas características**

THT CJTHT/PLUS CJTHT CJTHT/DUPLEX/ATEX

Q= Caudal en m³/h, m³/s y cfm.

Pe= Presión estática en mmH2O, Pa e inwg.

**Diámetro Hélice (cm): 71**

**Número de polos: 6**

**Número de palas: 6**

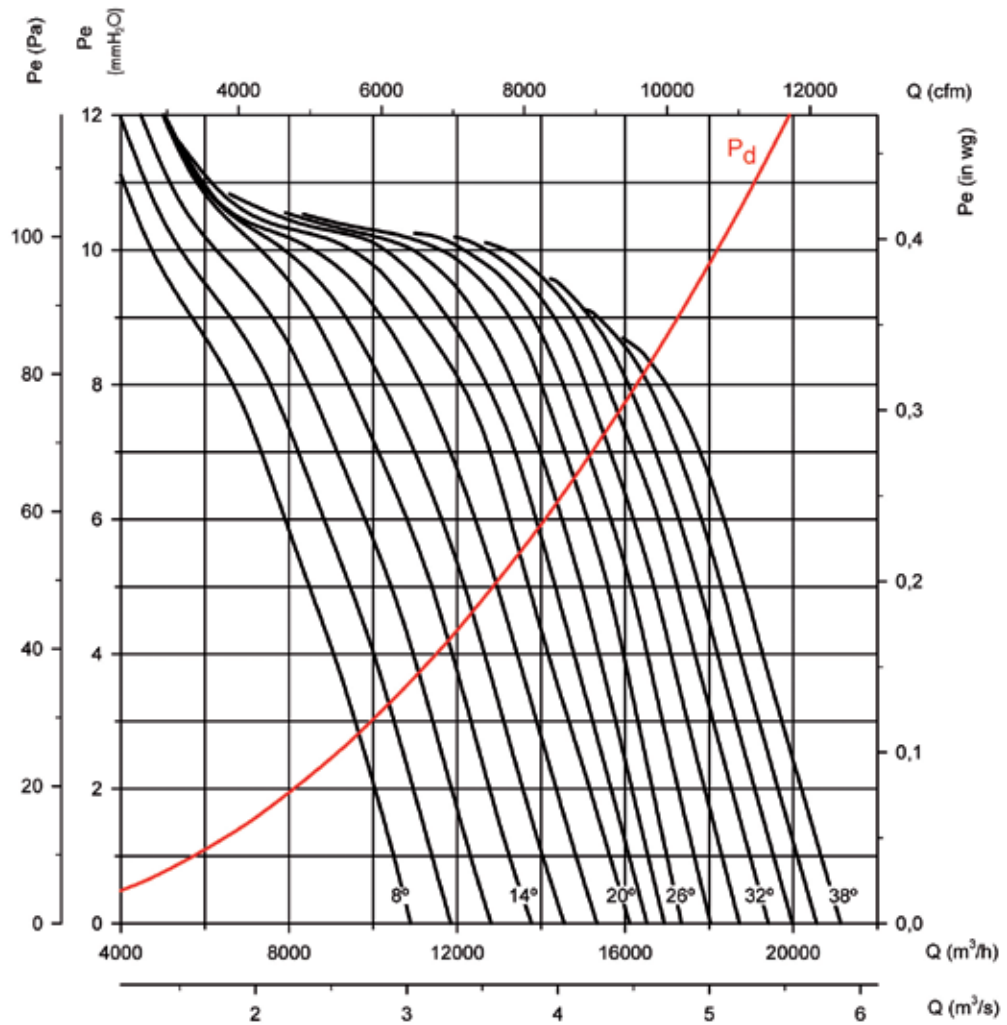

Potencia absorbida

Potencia Motor Recomendada kW(CV)

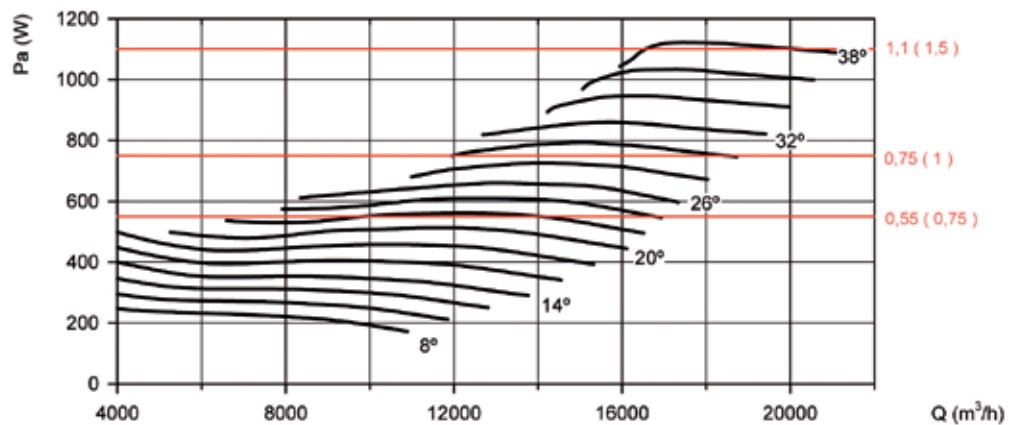

Consultar características del punto de máxima eficiencia (BEP) al final de la serie.

# THT CJTHT/PLUS CJTHT CJTHT/DUPLEX/ATEX

## Curvas características

THT CJTHT/PLUS CJTHT CJTHT/DUPLEX/ATEX

Q= Caudal en m<sup>3</sup>/h, m<sup>3</sup>/s y cfm.

Pe= Presión estática en mmH<sub>2</sub>O, Pa e inwg.

**Diámetro Hélice (cm): 80**

**Número de polos: 4**

**Número de palas: 6**

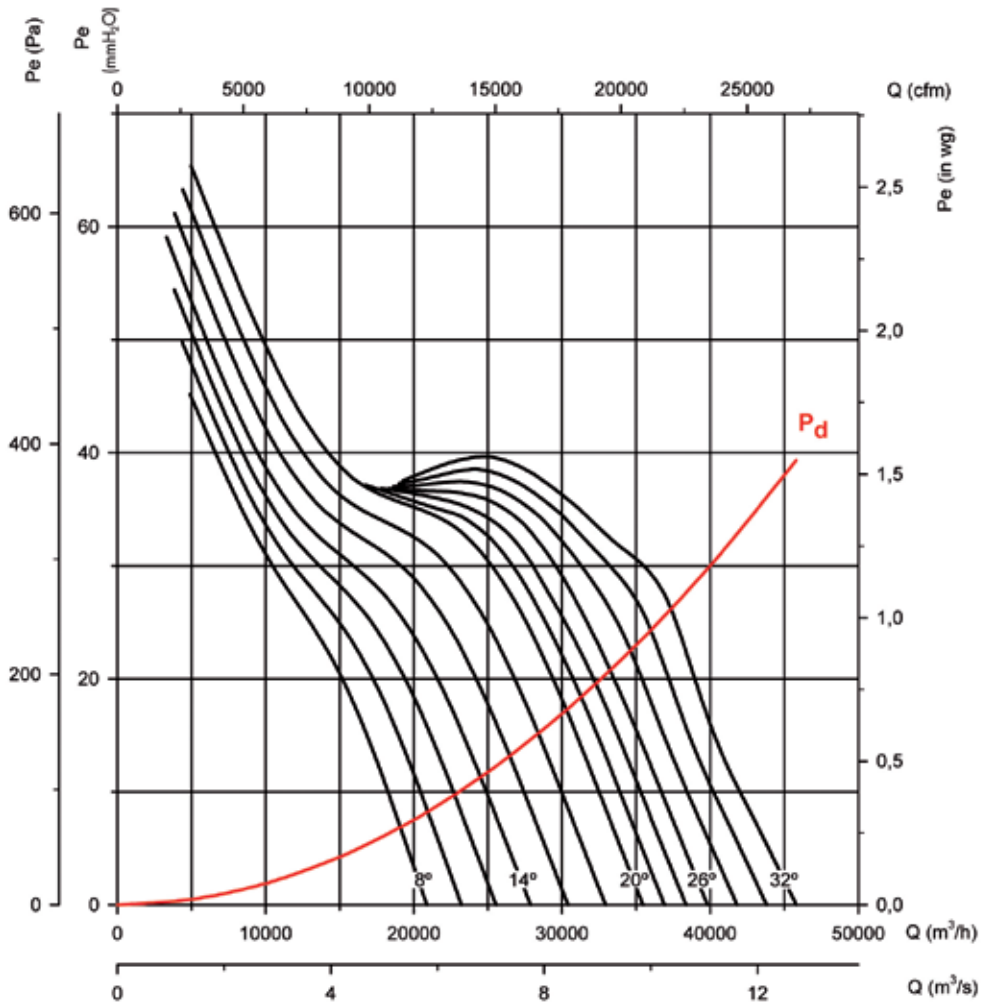

Potencia absorbida

Potencia Motor Recomendada kW(CV)

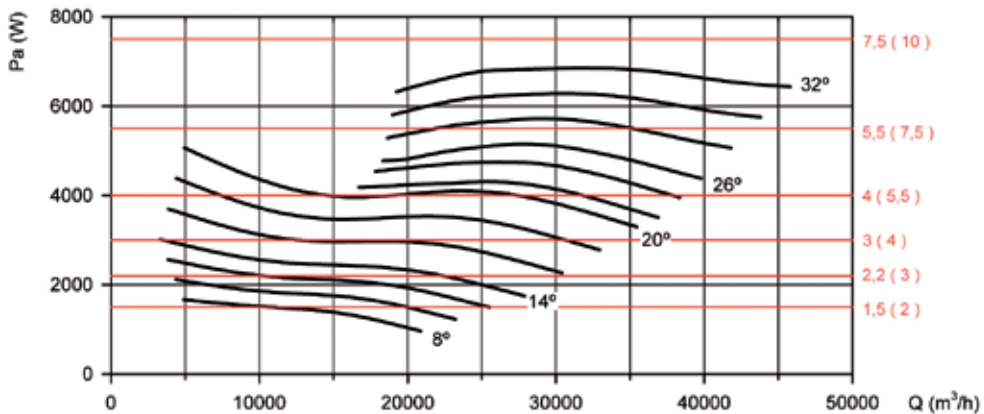

Consultar características del punto de máxima eficiencia (BEP) al final de la serie.

**Curvas características**

THT CJTHT/PLUS CJTHT CJTHT/DUPLEX/ATEX

Q= Caudal en m³/h, m³/s y cfm.

Pe= Presión estática en mmH2O, Pa e inwg.

**Diámetro Hélice (cm): 80**

**Número de polos: 6**

**Número de palas: 6**

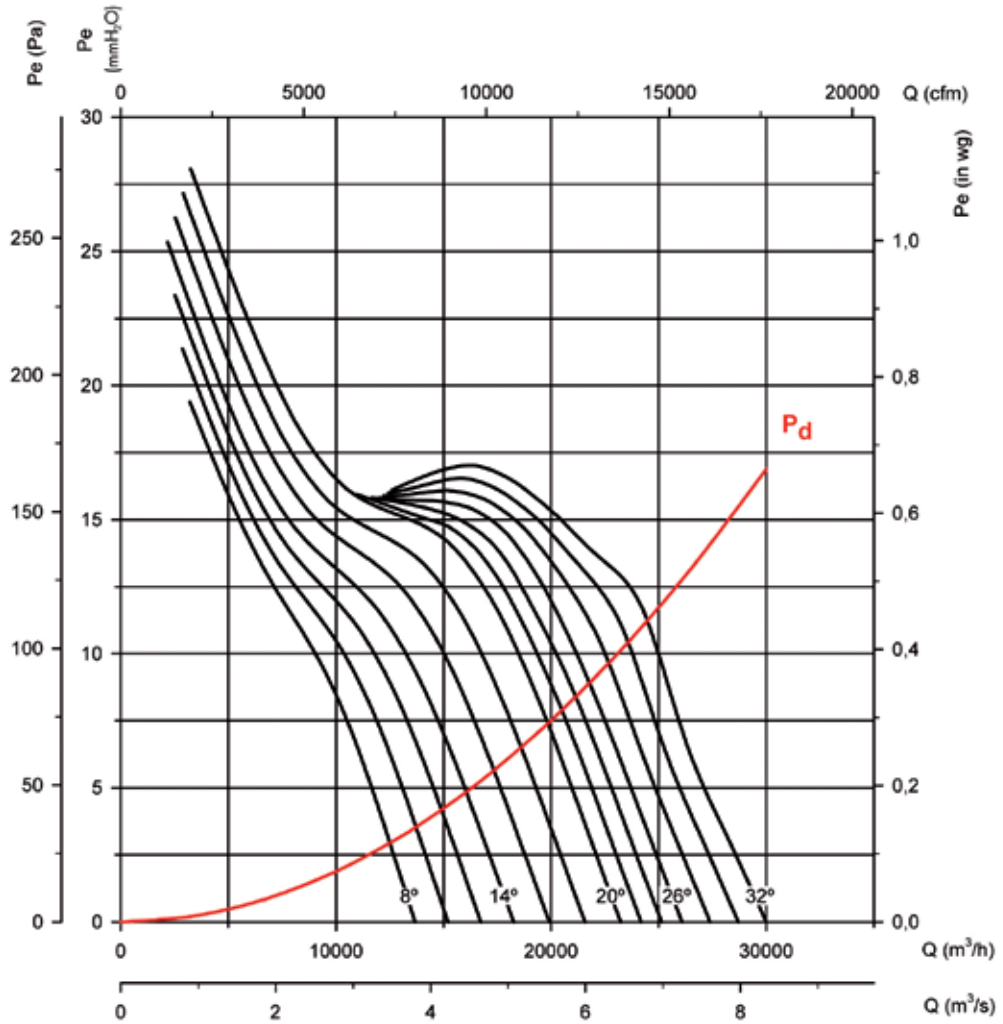

**Potencia absorbida**

**Potencia Motor Recomendada kW(CV)**

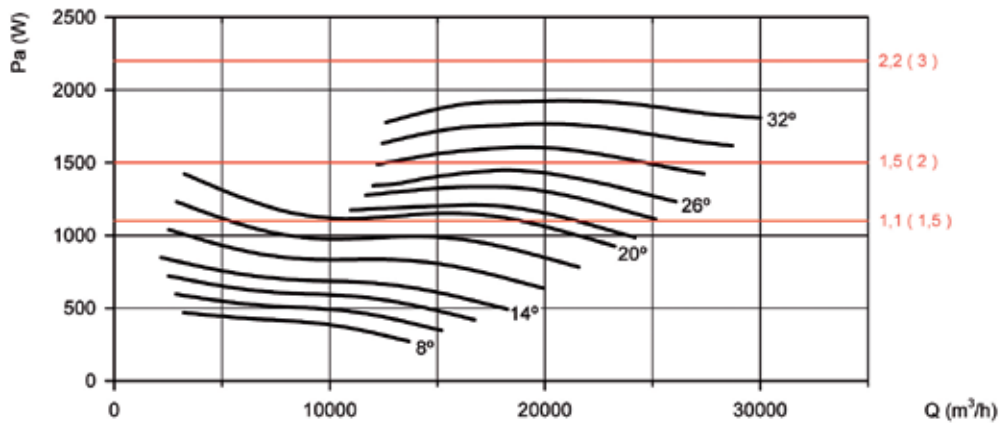

Consultar características del punto de máxima eficiencia (BEP) al final de la serie.

# THT CJTHT/PLUS CJTHT CJTHT/DUPLEX/ATEX

## Curvas características

THT CJTHT/PLUS CJTHT CJTHT/DUPLEX/ATEX

Q= Caudal en m<sup>3</sup>/h, m<sup>3</sup>/s y cfm.

Pe= Presión estática en mmH<sub>2</sub>O, Pa e inwg.

**Diámetro Hélice (cm): 80**

**Número de polos: 8**

**Número de palas: 6**

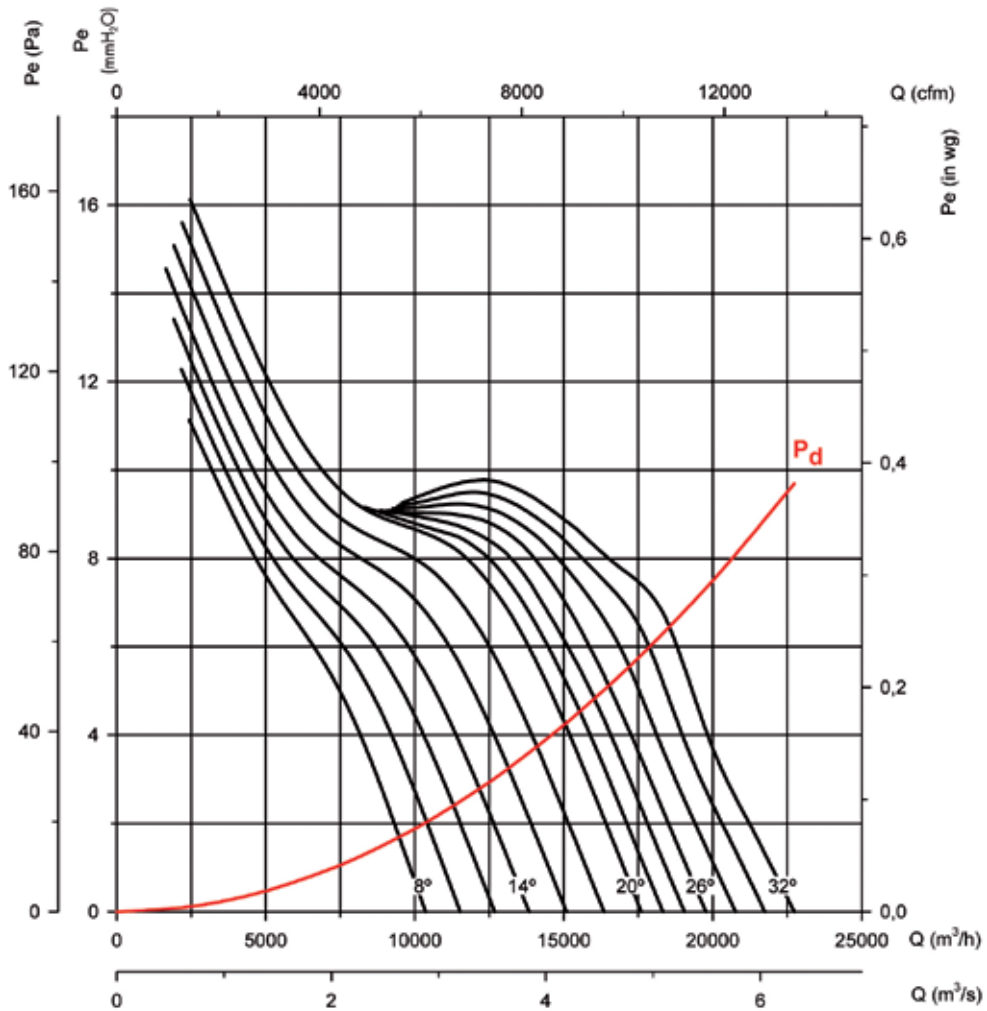

Potencia absorbida

Potencia Motor Recomendada kW(CV)

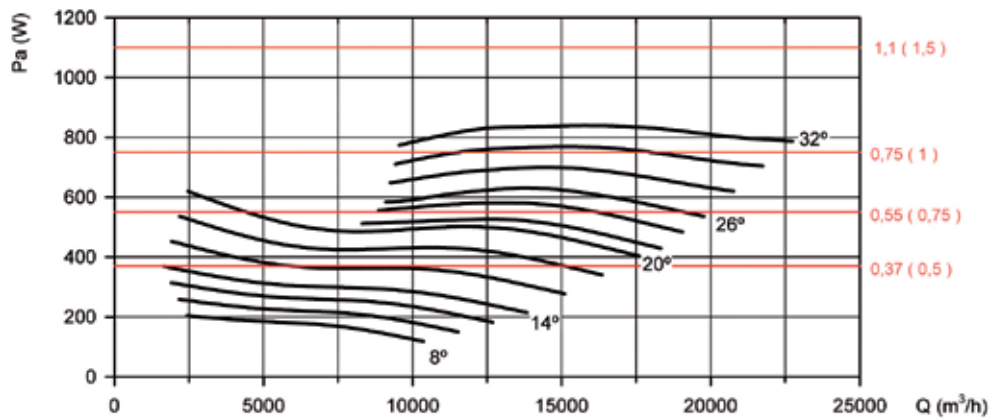

Consultar características del punto de máxima eficiencia (BEP) al final de la serie.

**Curvas características**

THT CJTHT/PLUS CJTHT CJTHT/DUPLEX/ATEX

Q= Caudal en m<sup>3</sup>/h, m<sup>3</sup>/s y cfm.

Pe= Presión estática en mmH<sub>2</sub>O, Pa e inwg.

**Diámetro Hélice (cm): 90**

**Número de polos: 4**

**Número de palas: 6**

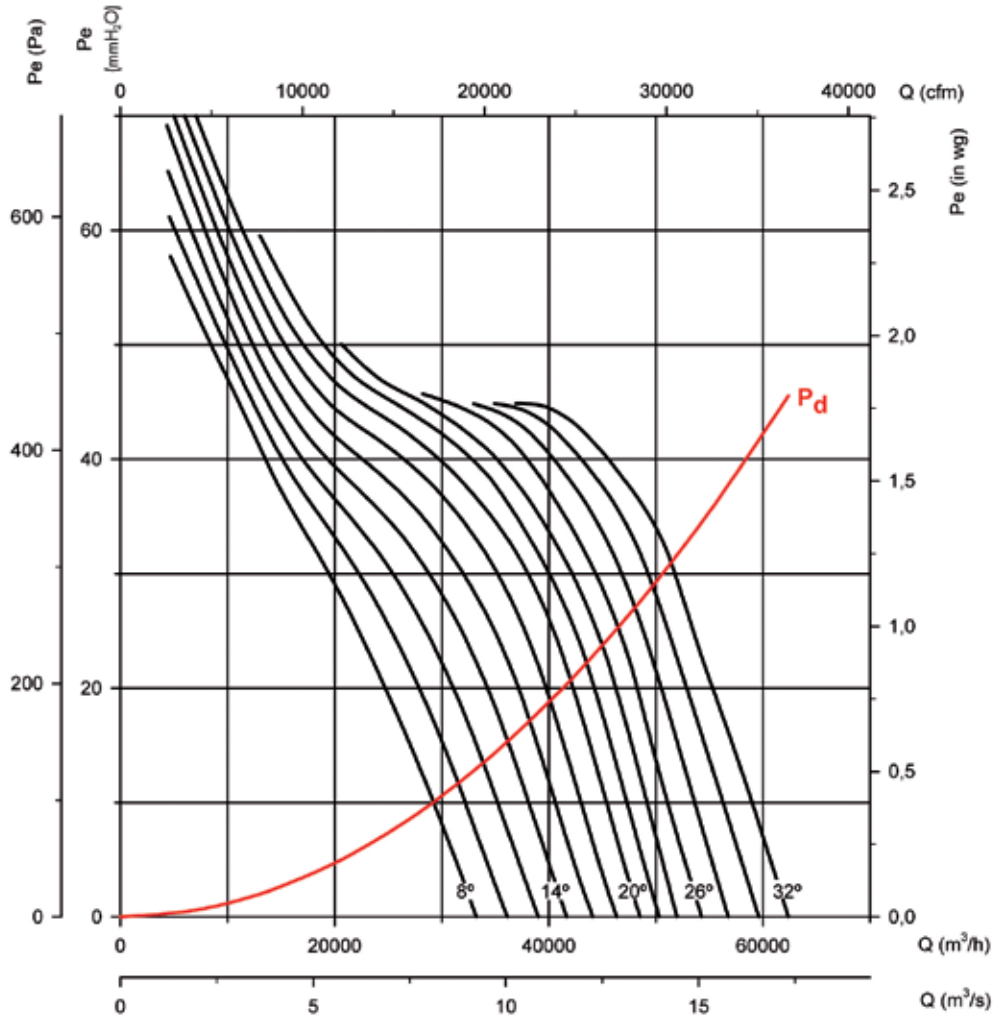

Potencia absorbida

Potencia Motor Recomendada kW(CV)

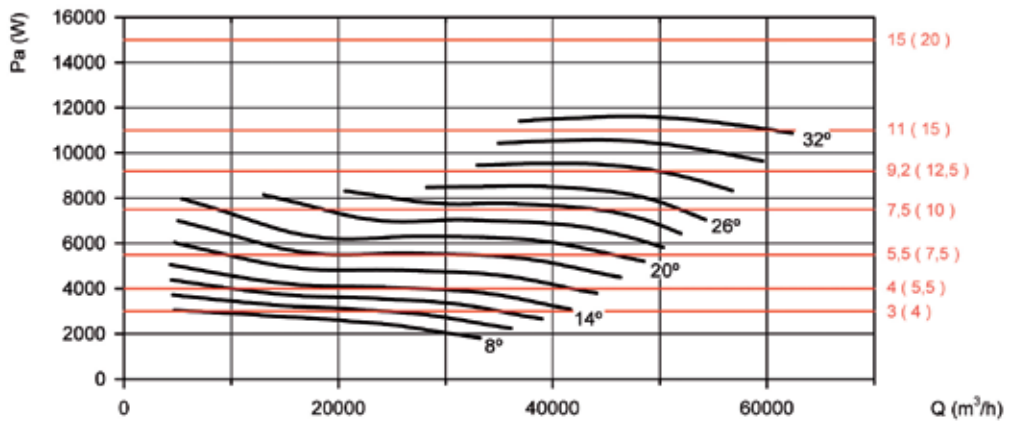

Consultar características del punto de máxima eficiencia (BEP) al final de la serie.

# THT CJTHT/PLUS CJTHT CJTHT/DUPLEX/ATEX

## Curvas características

THT CJTHT/PLUS CJTHT CJTHT/DUPLEX/ATEX

Q= Caudal en m<sup>3</sup>/h, m<sup>3</sup>/s y cfm.

Pe= Presión estática en mmH<sub>2</sub>O, Pa e inwg.

**Diámetro Hélice (cm): 90**

**Número de polos: 6**

**Número de palas: 6**

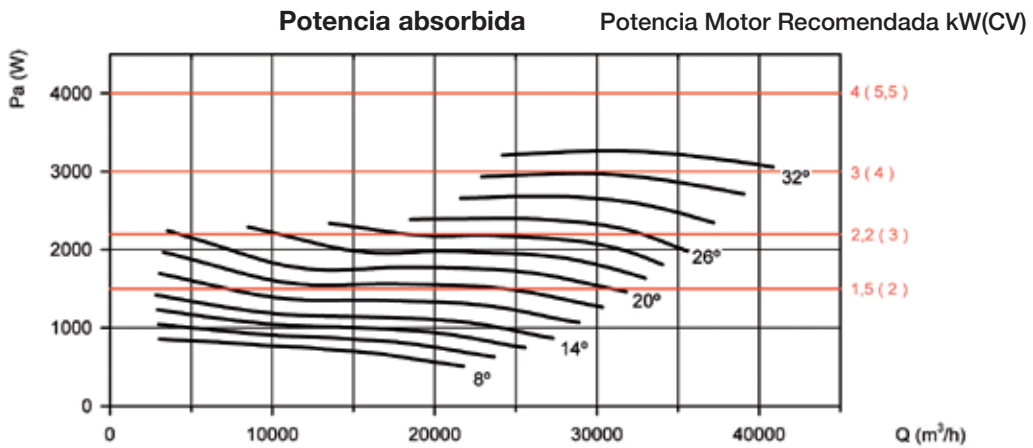
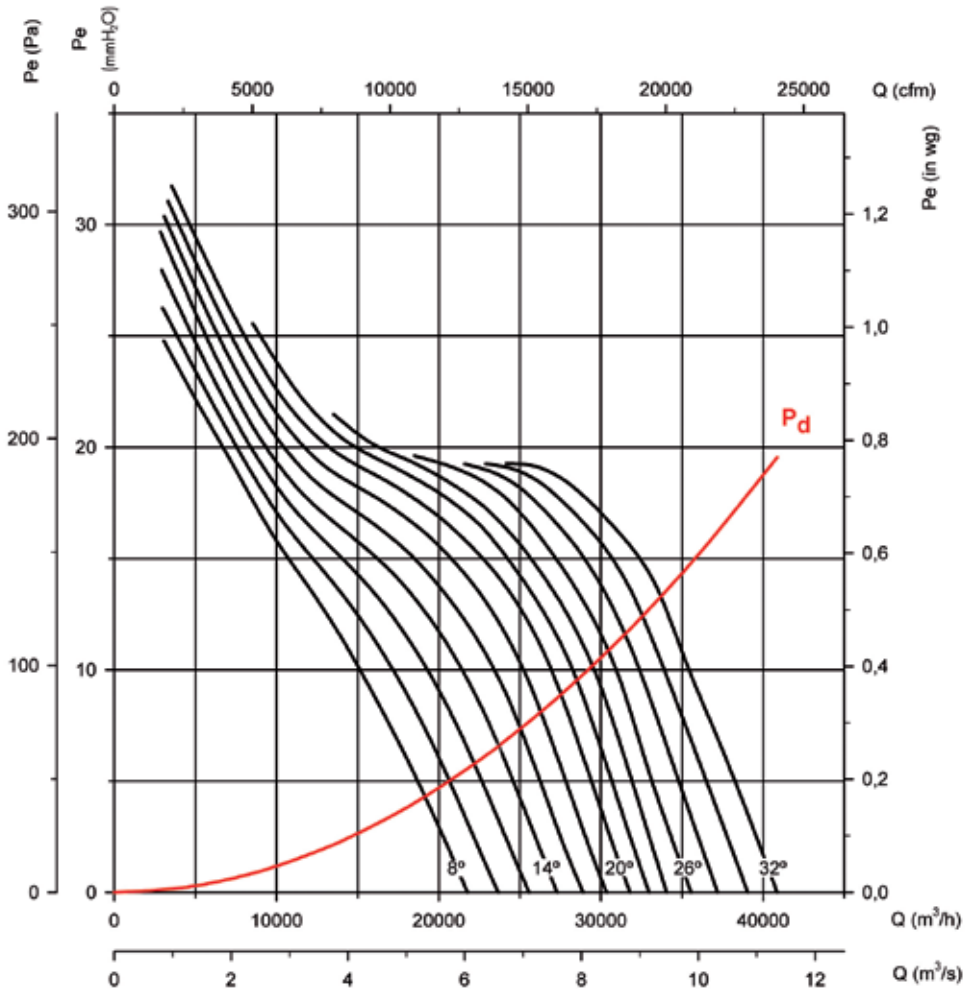

Consultar características del punto de máxima eficiencia (BEP) al final de la serie.

**Curvas características**

THT CJTHT/PLUS CJTHT CJTHT/DUPLEX/ATEX

Q= Caudal en m³/h, m³/s y cfm.

Pe= Presión estática en mmH2O, Pa e inwg.

**Diámetro Hélice (cm): 90**

**Número de polos: 8**

**Número de palas: 6**

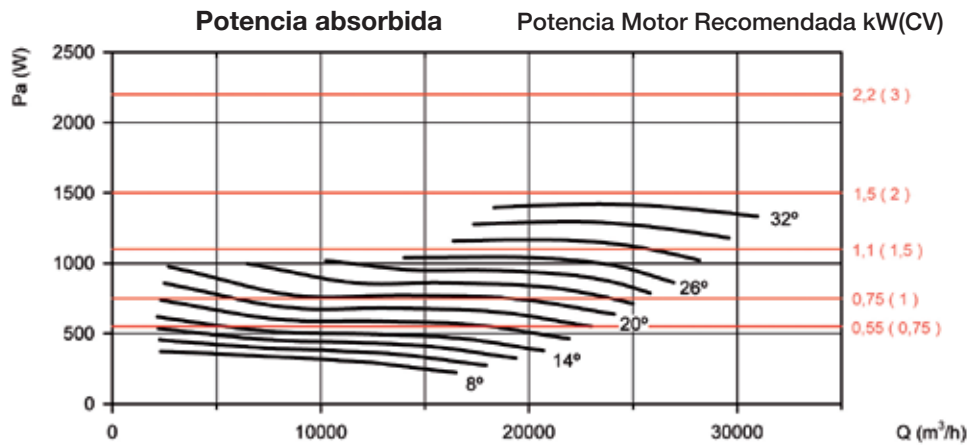
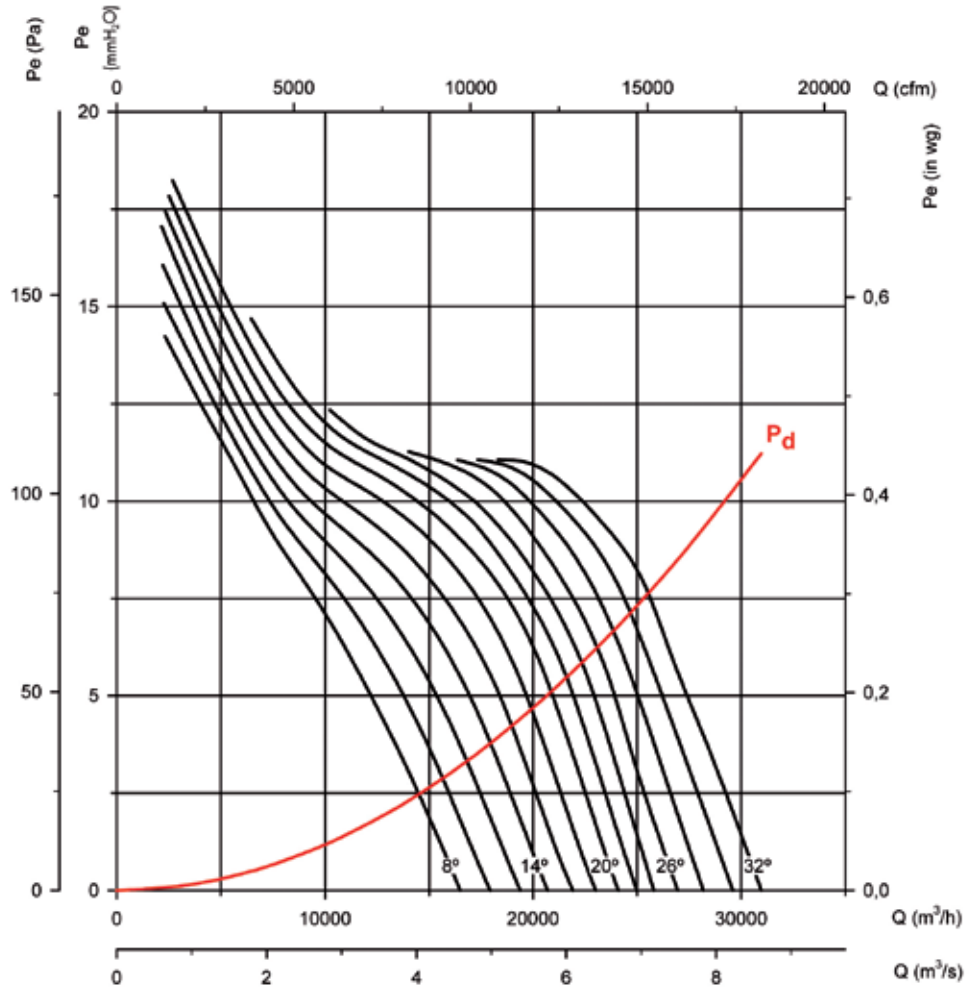

Consultar características del punto de máxima eficiencia (BEP) al final de la serie.



# THT CJTHT/PLUS CJTHT CJTHT/DUPLEX/ATEX

## Curvas características

THT CJTHT/PLUS CJTHT CJTHT/DUPLEX/ATEX

Q= Caudal en m<sup>3</sup>/h, m<sup>3</sup>/s y cfm.

Pe= Presión estática en mmH<sub>2</sub>O, Pa e inwg.

**Diámetro Hélice (cm): 100**

**Número de polos: 4**

**Número de palas: 6**

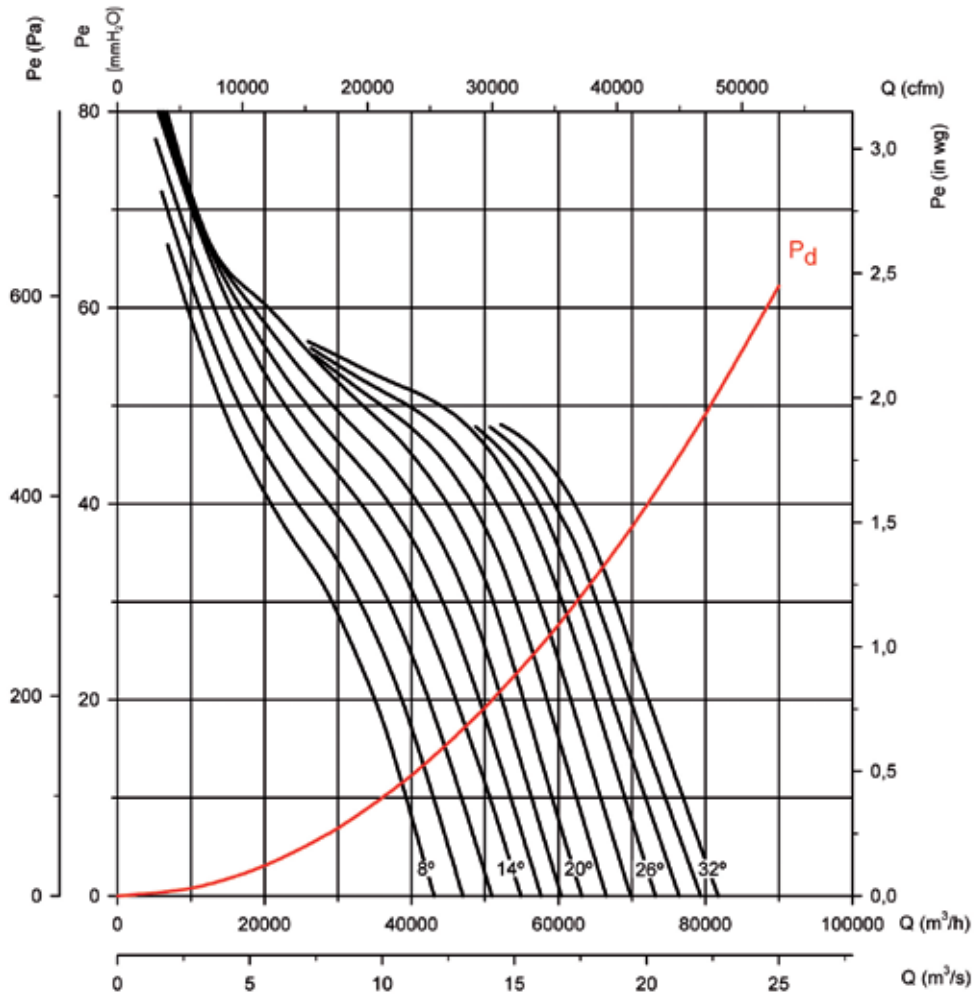

Potencia absorbida

Potencia Motor Recomendada kW(CV)

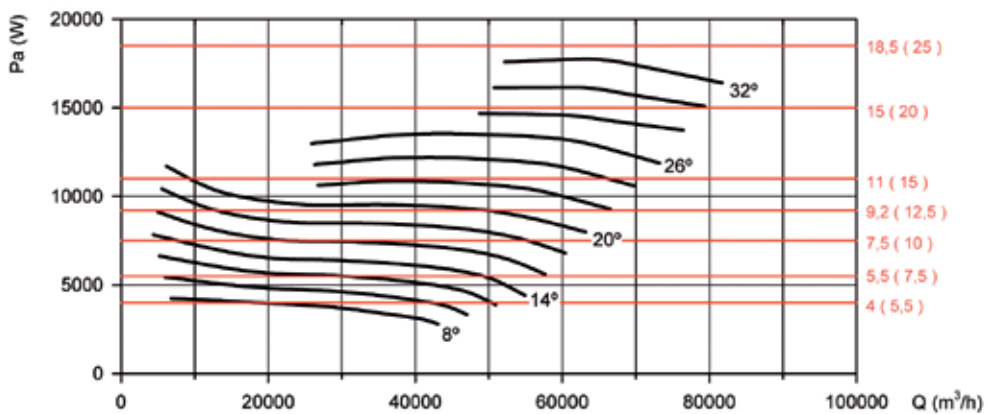

Consultar características del punto de máxima eficiencia (BEP) al final de la serie.

**Curvas características**

THT CJTHT/PLUS CJTHT CJTHT/DUPLEX/ATEX

Q= Caudal en m³/h, m³/s y cfm.

Pe= Presión estática en mmH2O, Pa e inwg.

**Diámetro Hélice (cm): 100**

**Número de polos: 6**

**Número de palas: 6**

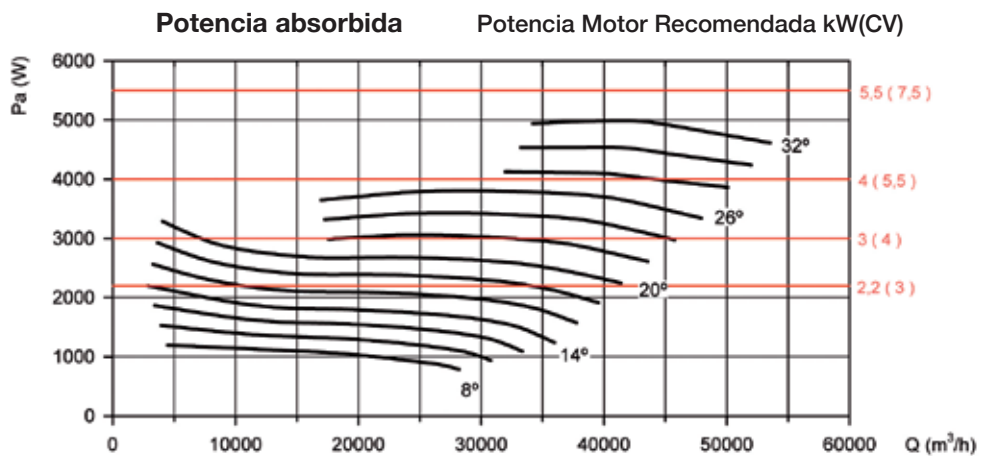
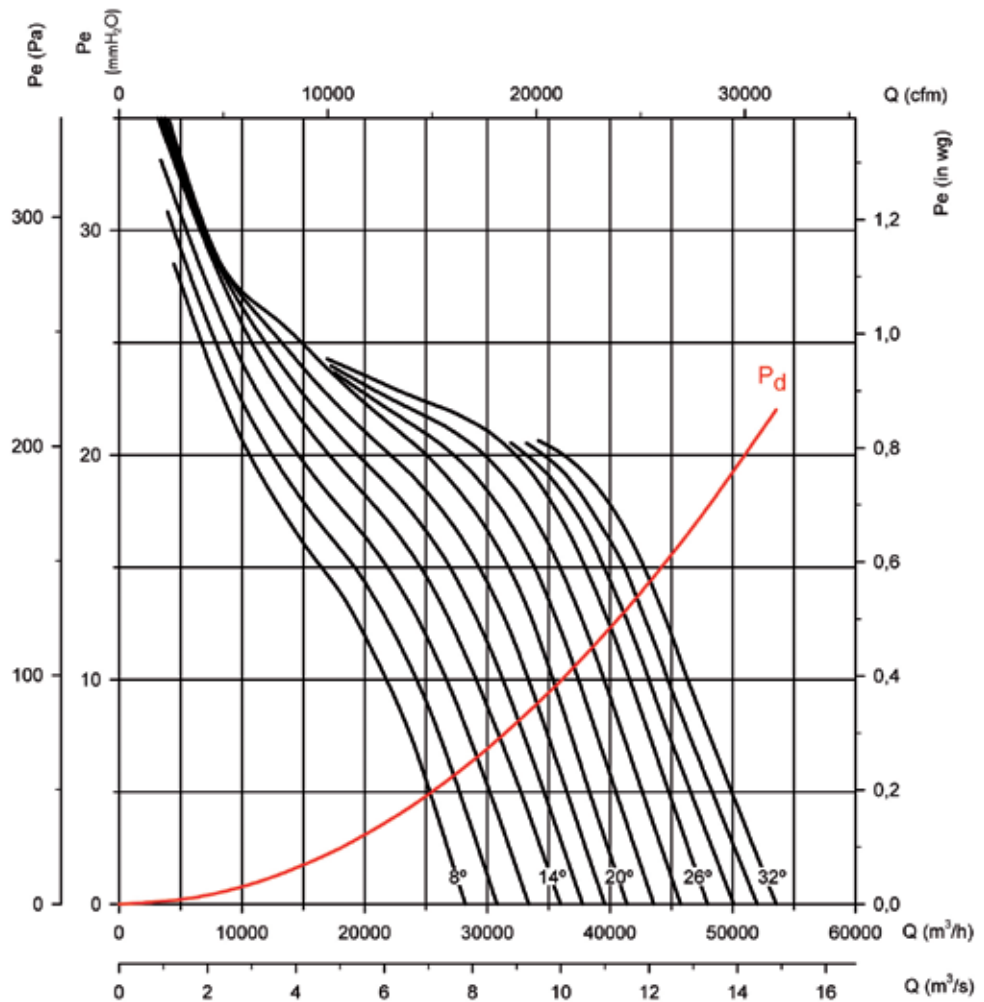

Consultar características del punto de máxima eficiencia (BEP) al final de la serie.

# THT CJTHT/PLUS CJTHT CJTHT/DUPLEX/ATEX

## Curvas características

THT CJTHT/PLUS CJTHT CJTHT/DUPLEX/ATEX

Q= Caudal en m<sup>3</sup>/h, m<sup>3</sup>/s y cfm.

Pe= Presión estática en mmH<sub>2</sub>O, Pa e inwg.

**Diámetro Hélice (cm): 100**

**Número de polos: 8**

**Número de palas: 6**

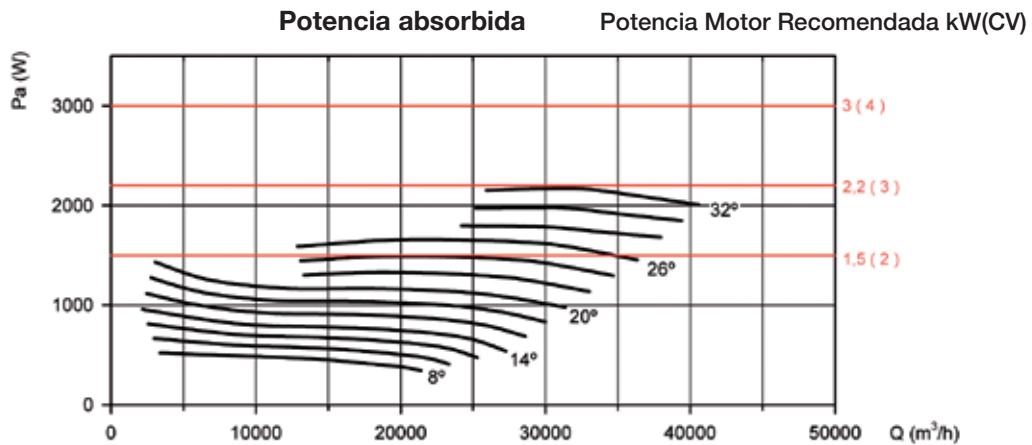
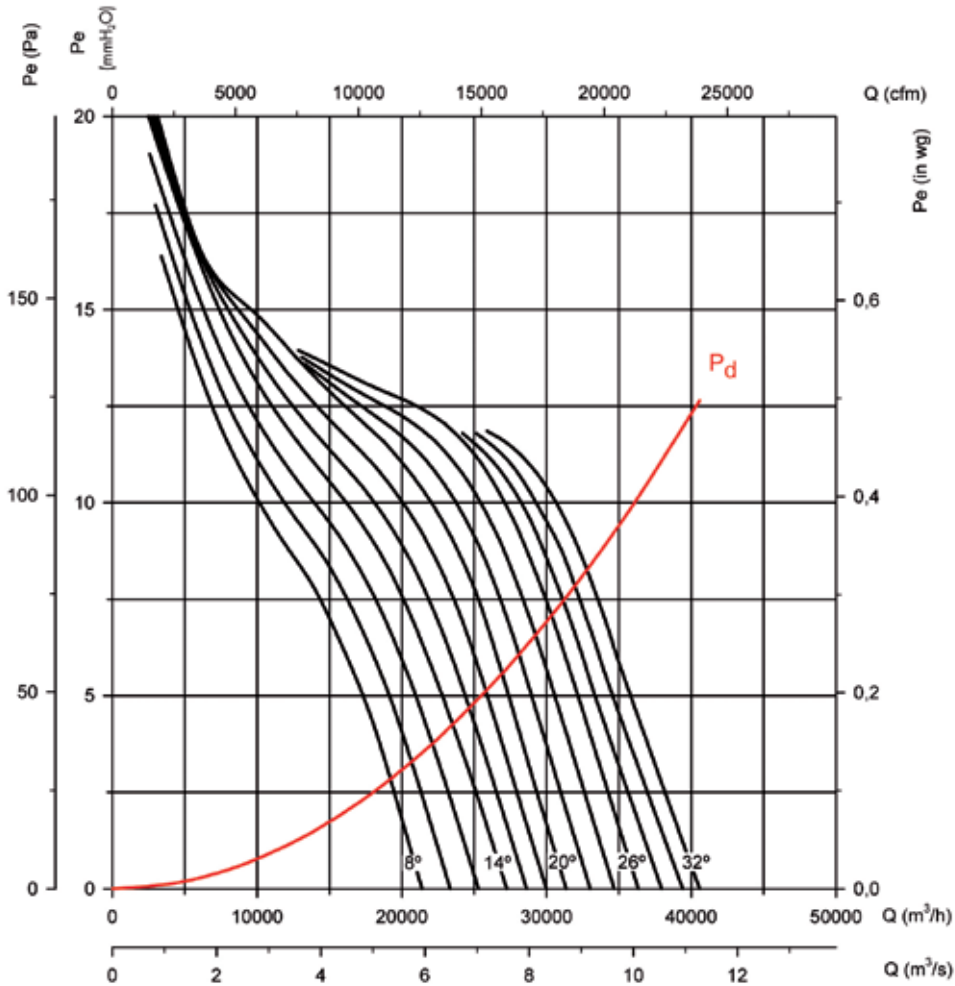

Consultar características del punto de máxima eficiencia (BEP) al final de la serie.

**Curvas características**

THT CJTHT/PLUS CJTHT CJTHT/DUPLEX/ATEX

Q= Caudal en m³/h, m³/s y cfm.

Pe= Presión estática en mmH2O, Pa e inwg.

**Diámetro Hélice (cm): 125**

**Número de polos: 4**

**Número de palas: 3**

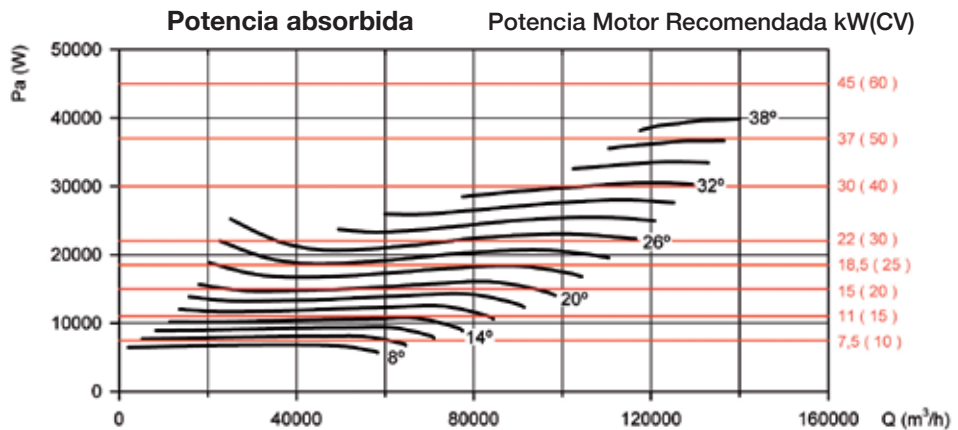
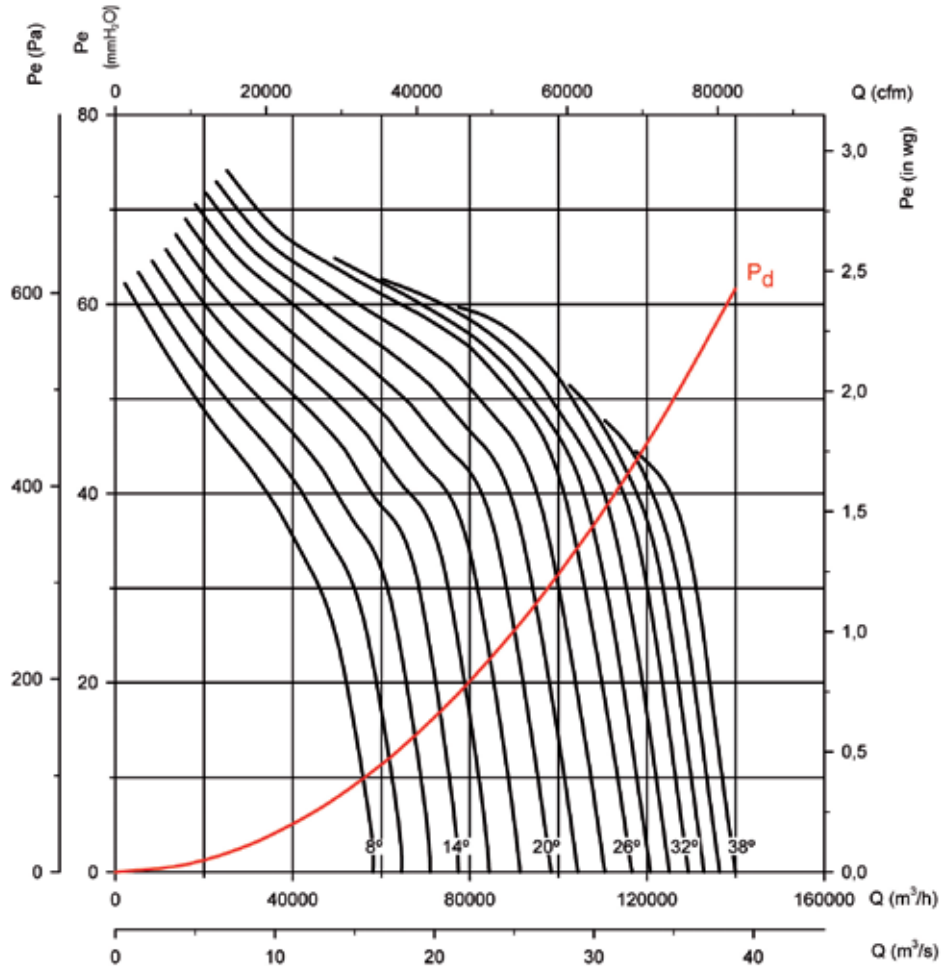

Consultar características del punto de máxima eficiencia (BEP) al final de la serie.

# THT CJTHT/PLUS CJTHT CJTHT/DUPLEX/ATEX

## Curvas características

THT

CJTHT/PLUS

CJTHT

CJTHT/DUPLEX/ATEX

Q= Caudal en m<sup>3</sup>/h, m<sup>3</sup>/s y cfm.

Pe= Presión estática en mmH<sub>2</sub>O, Pa e inwg.

**Diámetro Hélice (cm): 125**

**Número de polos: 4**

**Número de palas: 6**

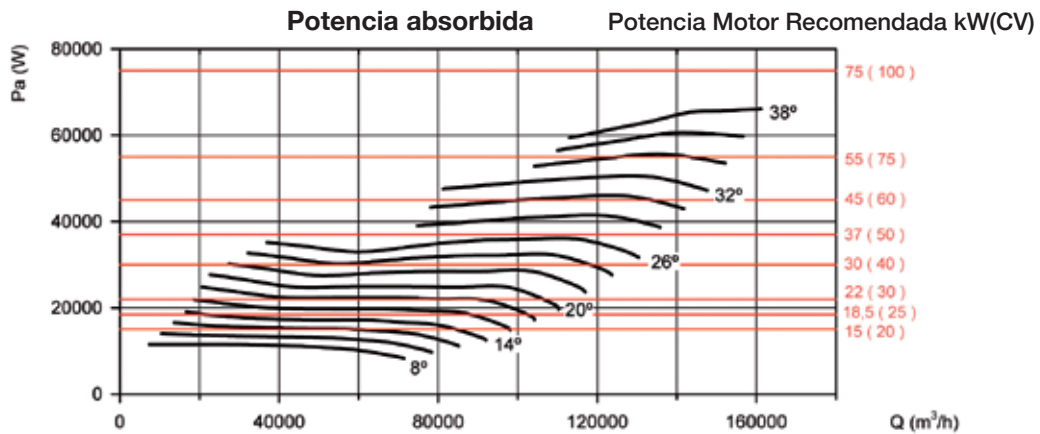
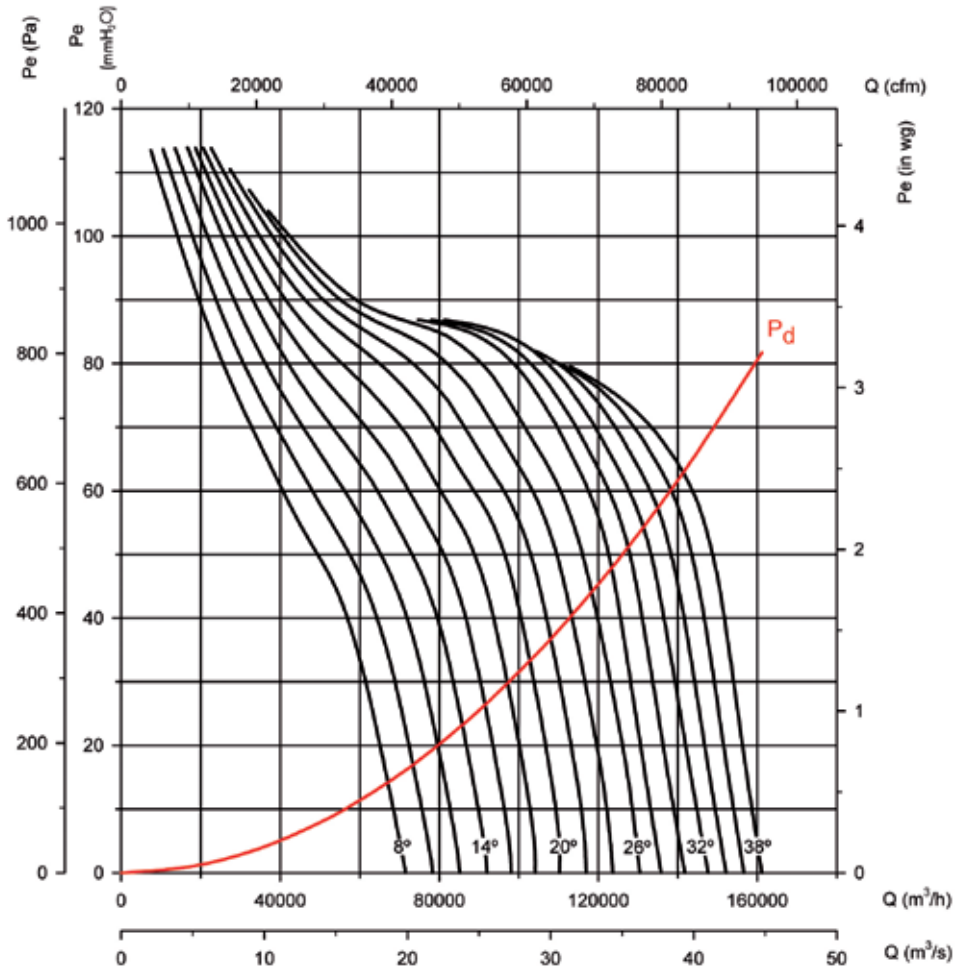

Consultar características del punto de máxima eficiencia (BEP) al final de la serie.

**Curvas características**

THT CJTHT/PLUS CJTHT CJTHT/DUPLEX/ATEX

Q= Caudal en m<sup>3</sup>/h, m<sup>3</sup>/s y cfm.

Pe= Presión estática en mmH<sub>2</sub>O, Pa e inwg.

**Diámetro Hélice (cm): 125**

**Número de polos: 4**

**Número de palas: 9**

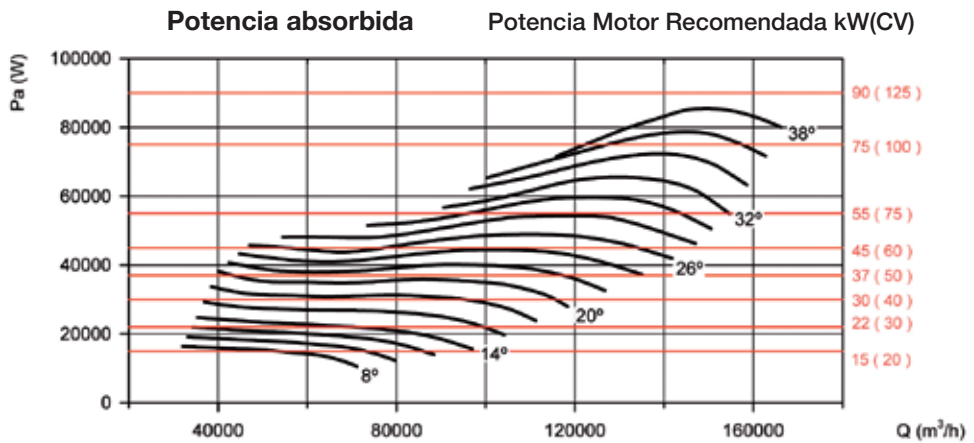
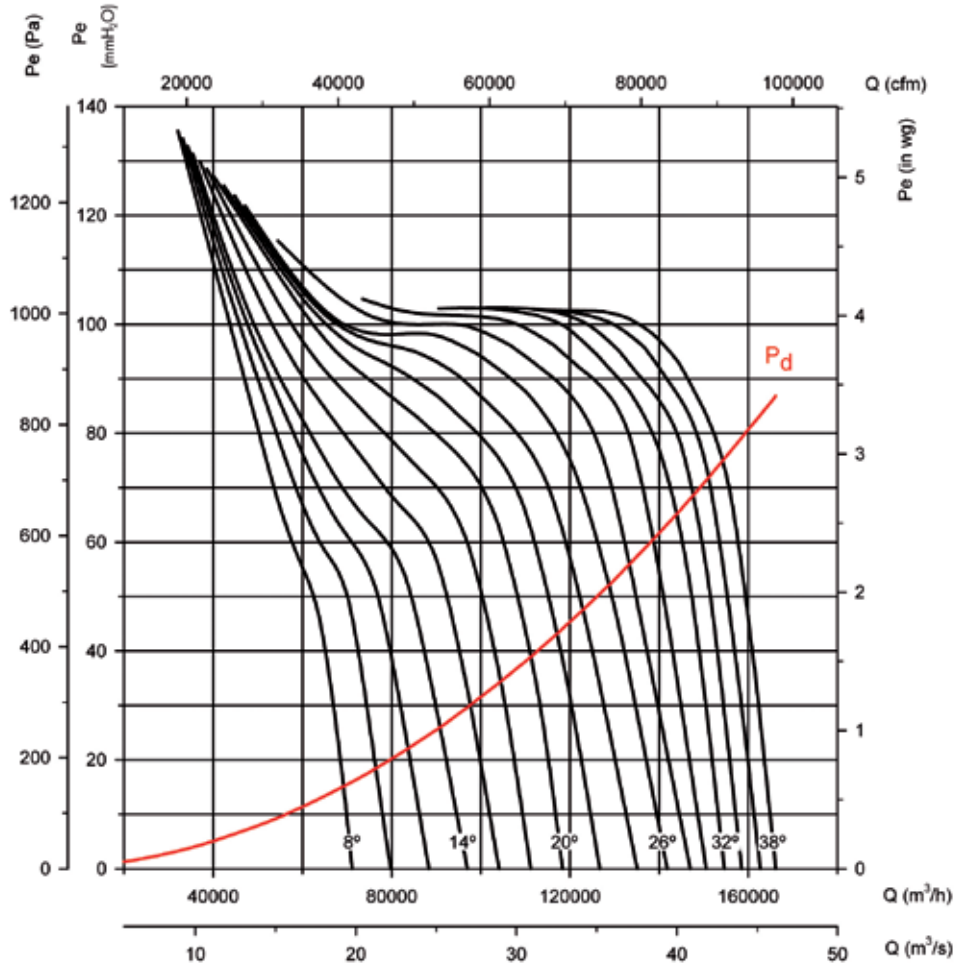

Consultar características del punto de máxima eficiencia (BEP) al final de la serie.

# THT CJTHT/PLUS CJTHT CJTHT/DUPLEX/ATEX

## Curvas características

THT

CJTHT/PLUS

CJTHT

CJTHT/DUPLEX/ATEX

Q= Caudal en m<sup>3</sup>/h, m<sup>3</sup>/s y cfm.

Pe= Presión estática en mmH<sub>2</sub>O, Pa e inwg.

**Diámetro Hélice (cm): 125**

**Número de polos: 6**

**Número de palas: 3**

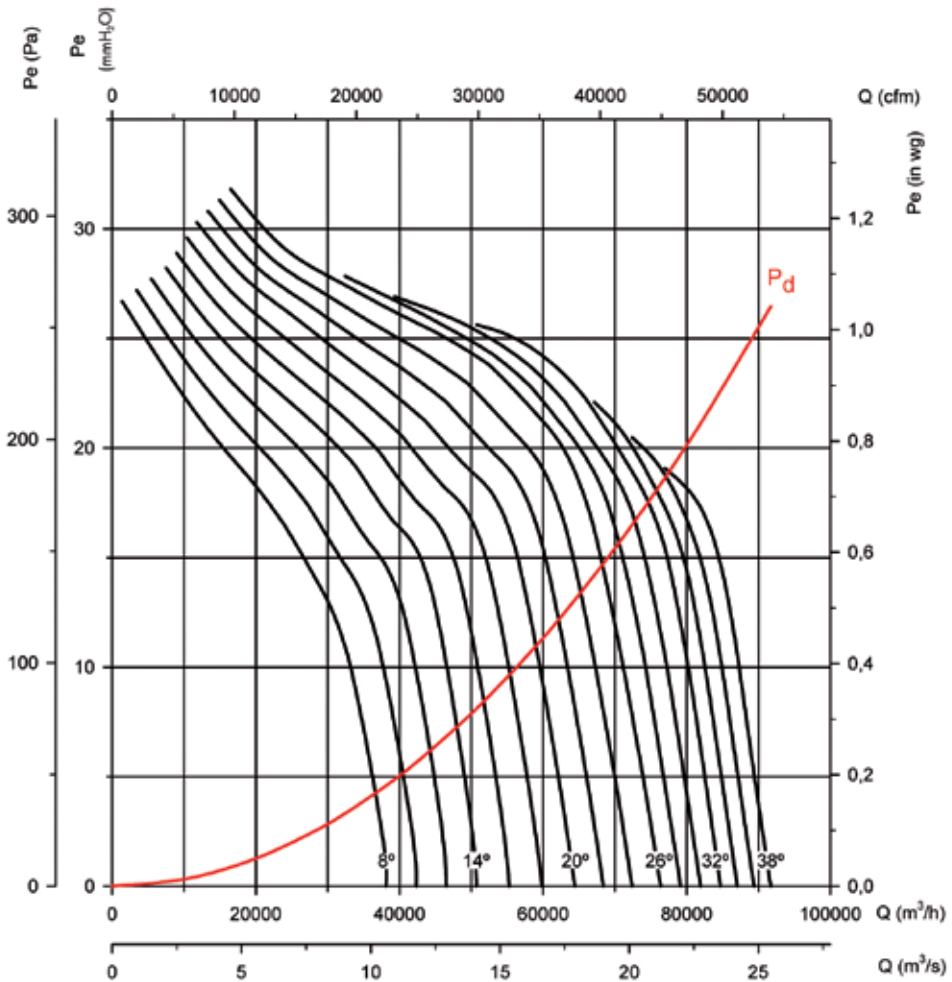

Potencia absorbida

Potencia Motor Recomendada kW(CV)

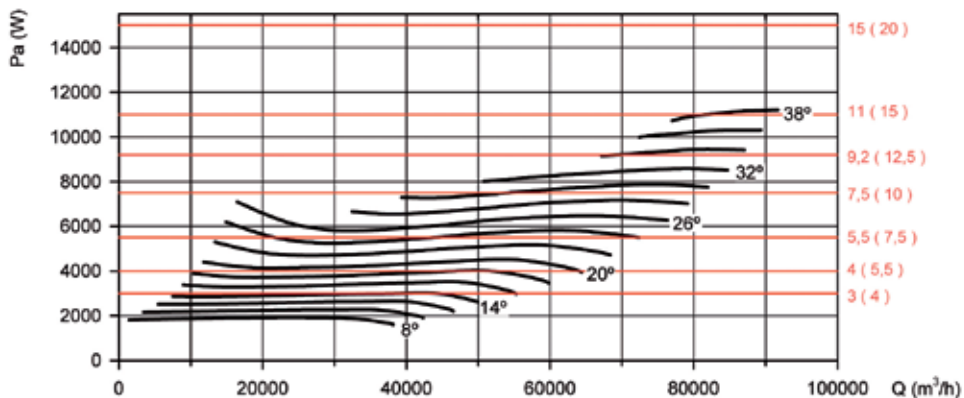

Consultar características del punto de máxima eficiencia (BEP) al final de la serie.

**Curvas características**

THT CJTHT/PLUS CJTHT CJTHT/DUPLEX/ATEX

Q= Caudal en m<sup>3</sup>/h, m<sup>3</sup>/s y cfm.

Pe= Presión estática en mmH<sub>2</sub>O, Pa e inwg.

**Diámetro Hélice (cm): 125**

**Número de polos: 6**

**Número de palas: 6**

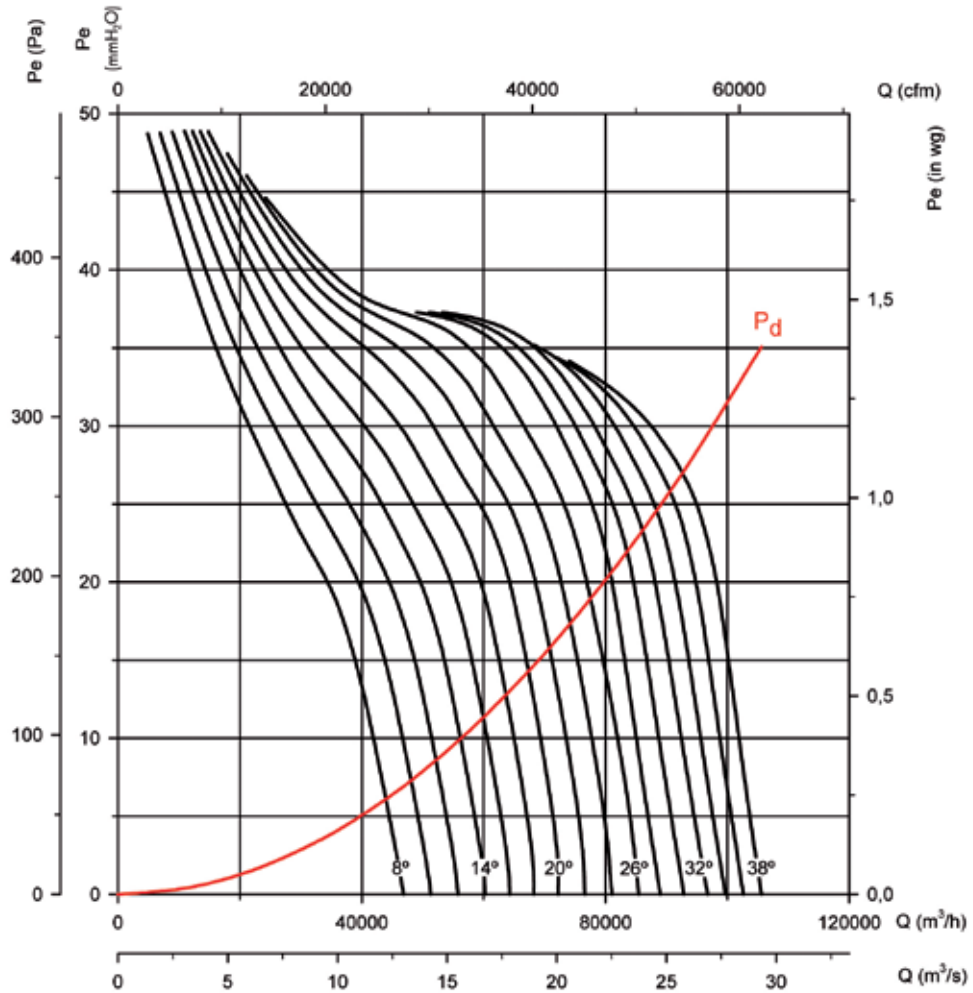

**Potencia absorbida**

**Potencia Motor Recomendada kW(CV)**

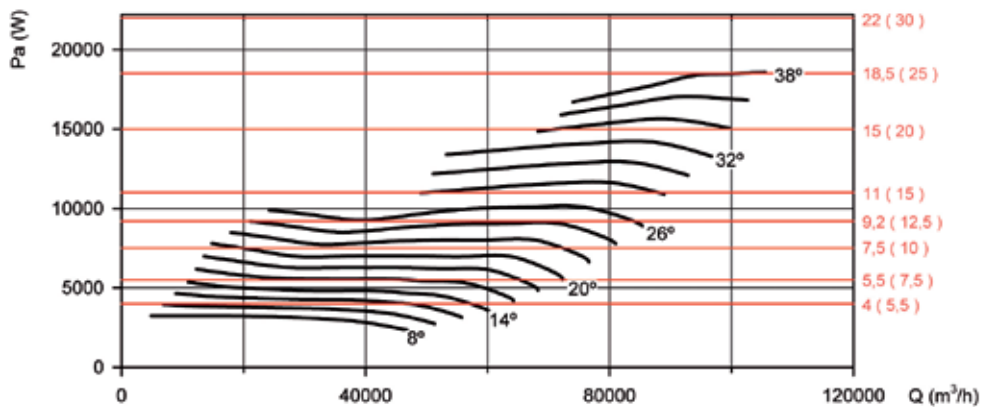

Consultar características del punto de máxima eficiencia (BEP) al final de la serie.



# THT CJTHT/PLUS CJTHT CJTHT/DUPLEX/ATEX

## Curvas características

THT CJTHT/PLUS CJTHT CJTHT/DUPLEX/ATEX

Q= Caudal en m<sup>3</sup>/h, m<sup>3</sup>/s y cfm.

Pe= Presión estática en mmH<sub>2</sub>O, Pa e inwg.

**Diámetro Hélice (cm): 125**

**Número de polos: 6**

**Número de palas: 9**

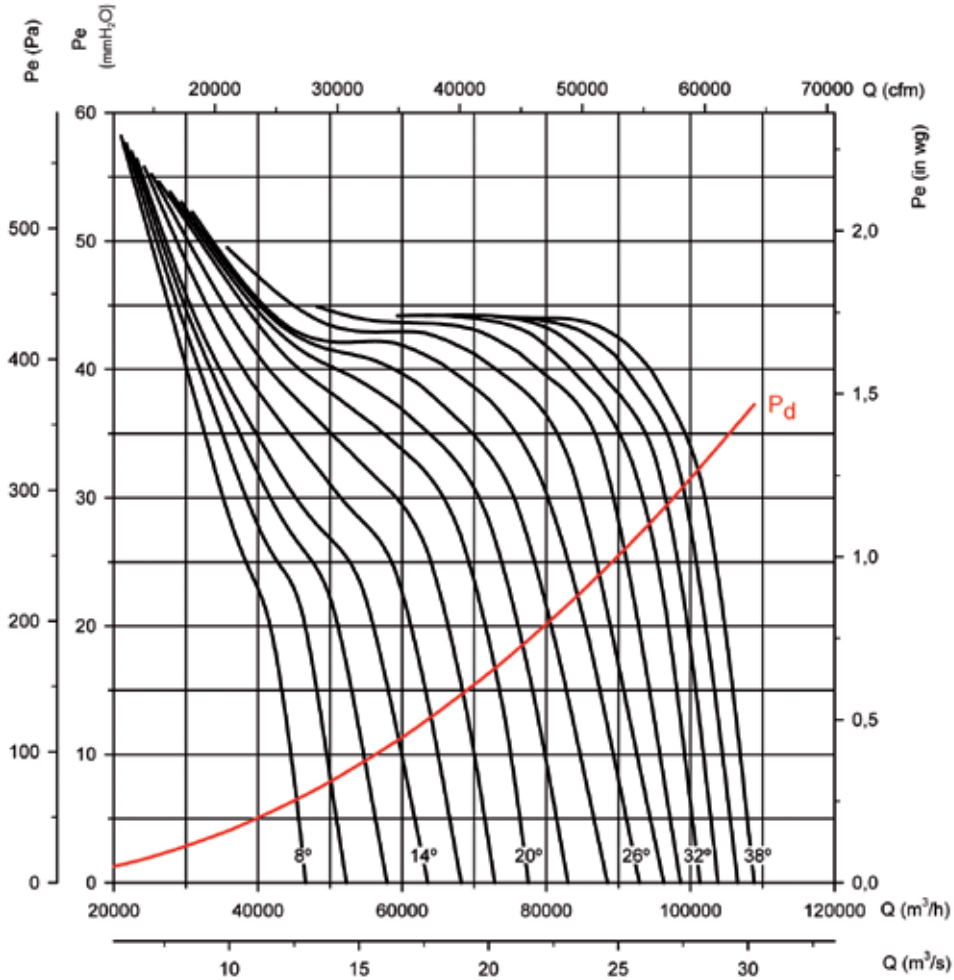

Potencia absorbida

Potencia Motor Recomendada kW(CV)

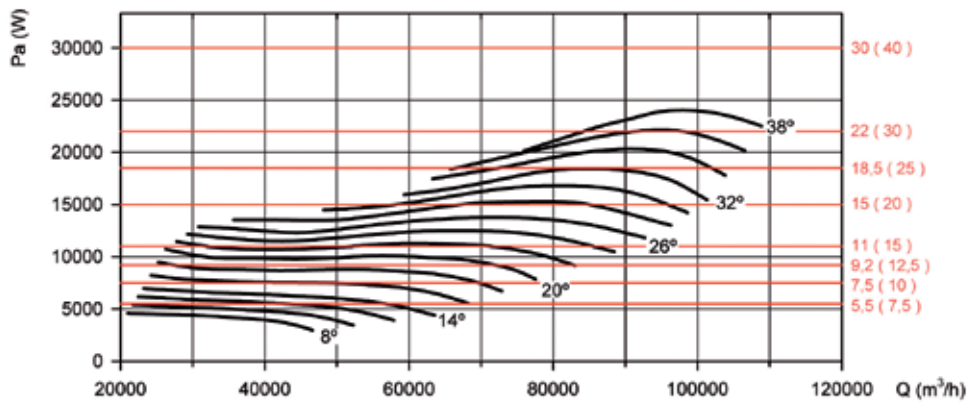

Consultar características del punto de máxima eficiencia (BEP) al final de la serie.

**Curvas características**

THT CJTHT/PLUS CJTHT CJTHT/DUPLEX/ATEX

Q= Caudal en m<sup>3</sup>/h, m<sup>3</sup>/s y cfm.

Pe= Presión estática en mmH<sub>2</sub>O, Pa e inwg.

**Diámetro Hélice (cm): 140**

**Número de polos: 6**

**Número de palas: 3**

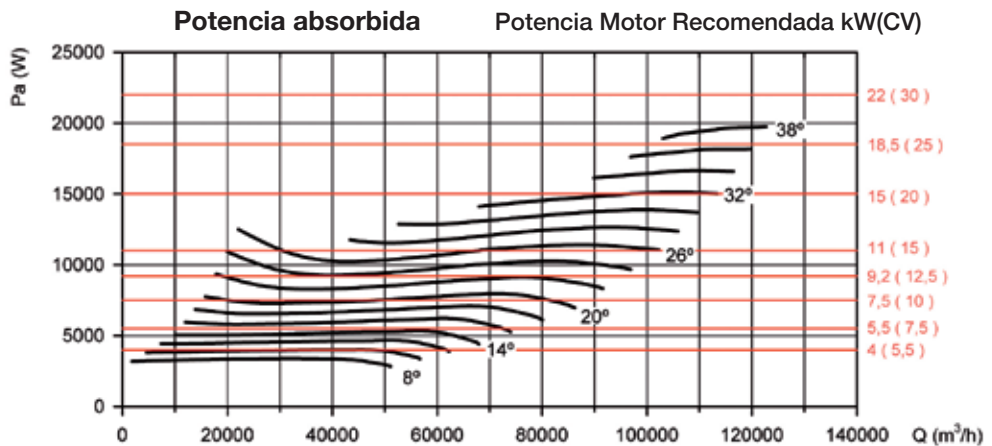
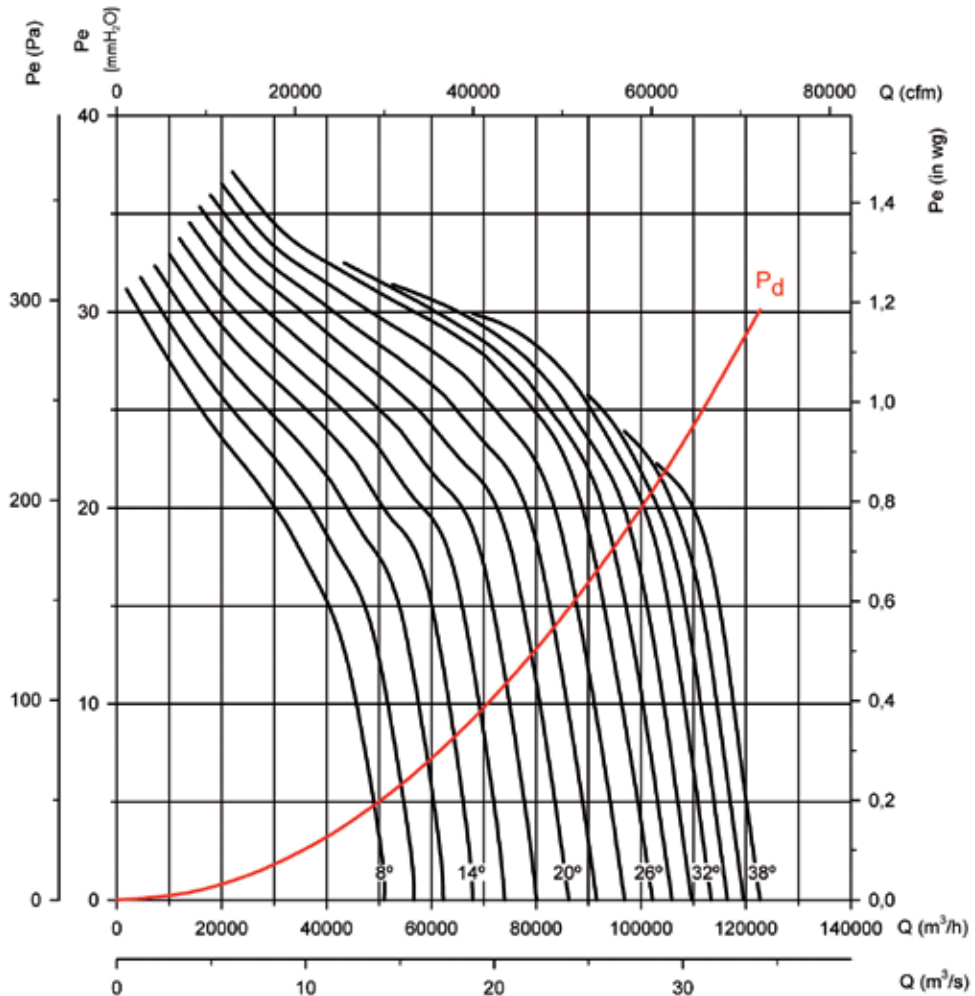

Consultar características del punto de máxima eficiencia (BEP) al final de la serie.

# THT CJTHT/PLUS CJTHT CJTHT/DUPLEX/ATEX

## Curvas características

THT

CJTHT/PLUS

CJTHT

CJTHT/DUPLEX/ATEX

Q= Caudal en m<sup>3</sup>/h, m<sup>3</sup>/s y cfm.

Pe= Presión estática en mmH<sub>2</sub>O, Pa e inwg.

**Diámetro Hélice (cm): 140**

**Número de polos: 6**

**Número de palas: 6**

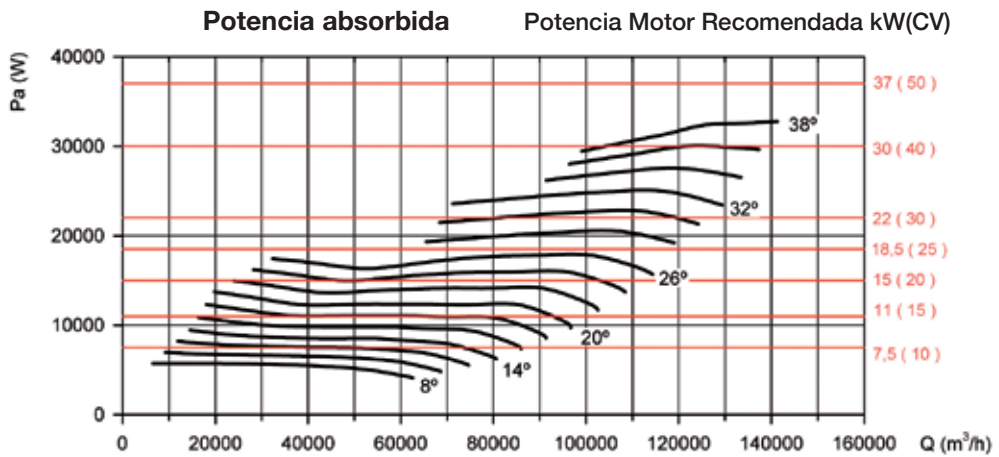
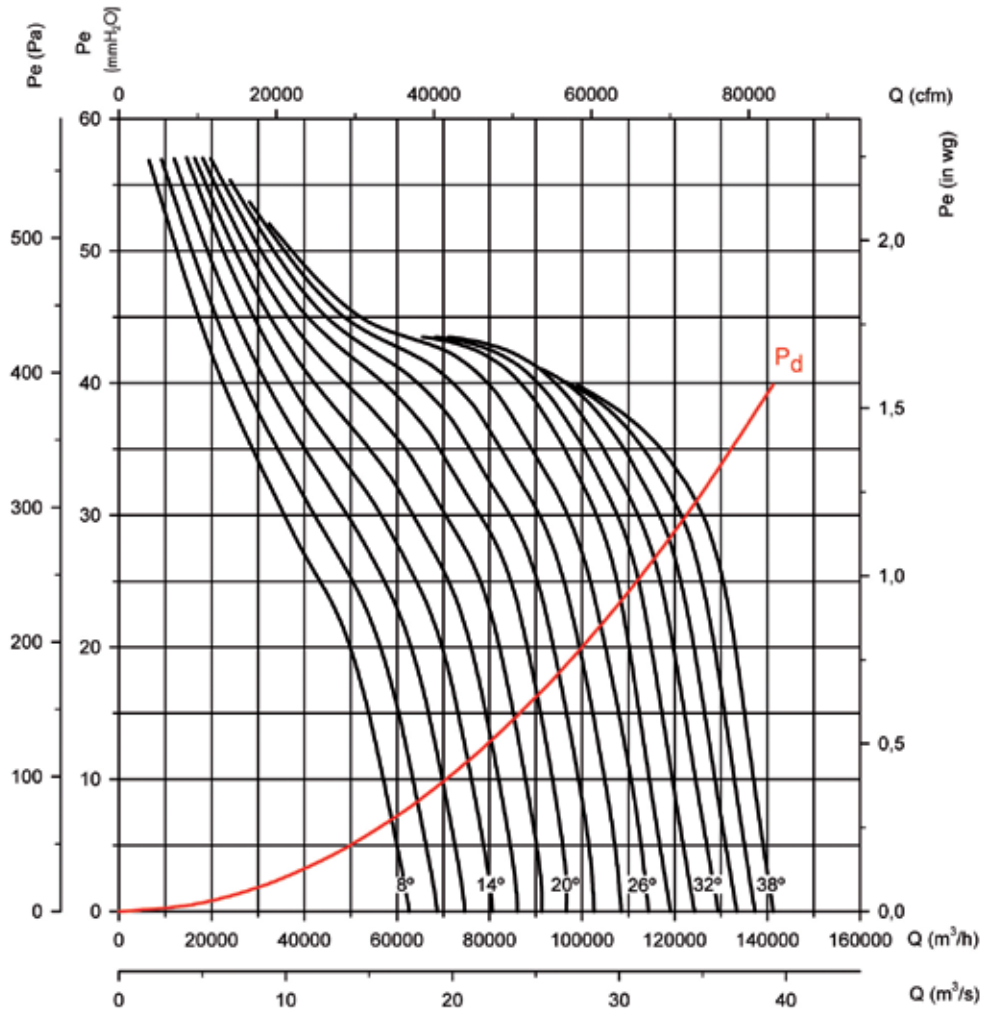

Consultar características del punto de máxima eficiencia (BEP) al final de la serie.

**Curvas características**

THT

CJTHT/PLUS

CJTHT

CJTHT/DUPLEX/ATEX

Q= Caudal en m<sup>3</sup>/h, m<sup>3</sup>/s y cfm.

Pe= Presión estática en mmH<sub>2</sub>O, Pa e inwg.

**Diámetro Hélice (cm): 140**

**Número de polos: 6**

**Número de palas: 9**

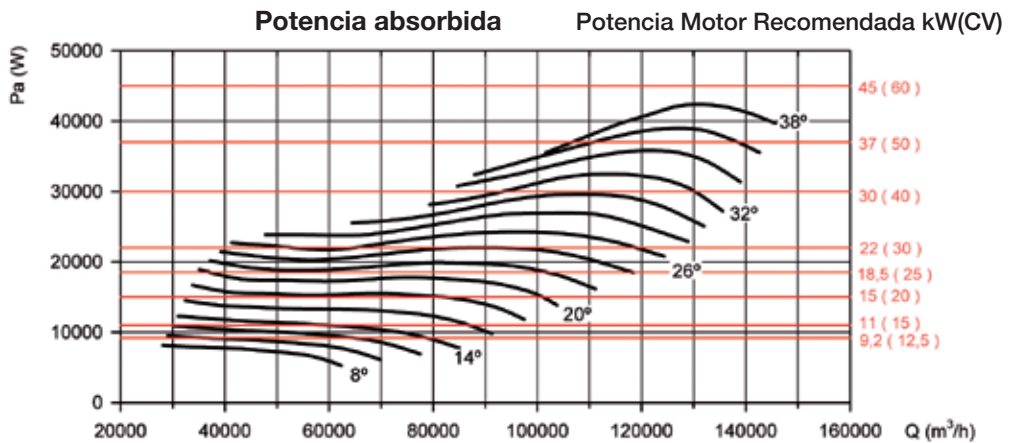
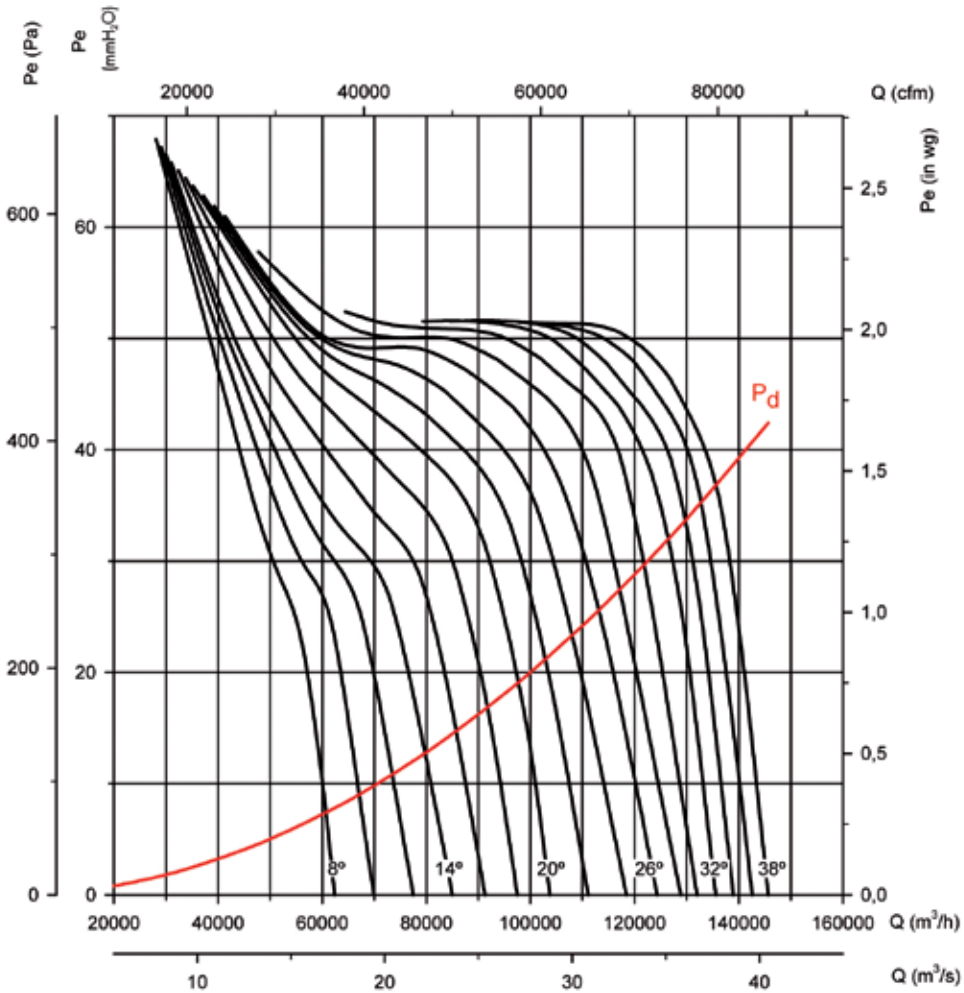

Consultar características del punto de máxima eficiencia (BEP) al final de la serie.

# THT CJTHT/PLUS CJTHT CJTHT/DUPLEX/ATEX

## Curvas características

THT

CJTHT/PLUS

CJTHT

CJTHT/DUPLEX/ATEX

Q= Caudal en m<sup>3</sup>/h, m<sup>3</sup>/s y cfm.

Pe= Presión estática en mmH<sub>2</sub>O, Pa e inwg.

**Diámetro Hélice (cm): 140**

**Número de polos: 8**

**Número de palas: 3**

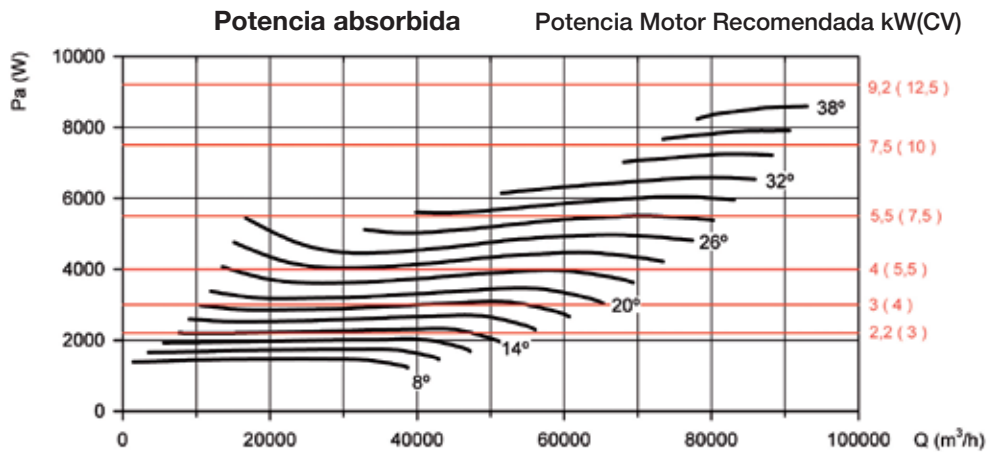
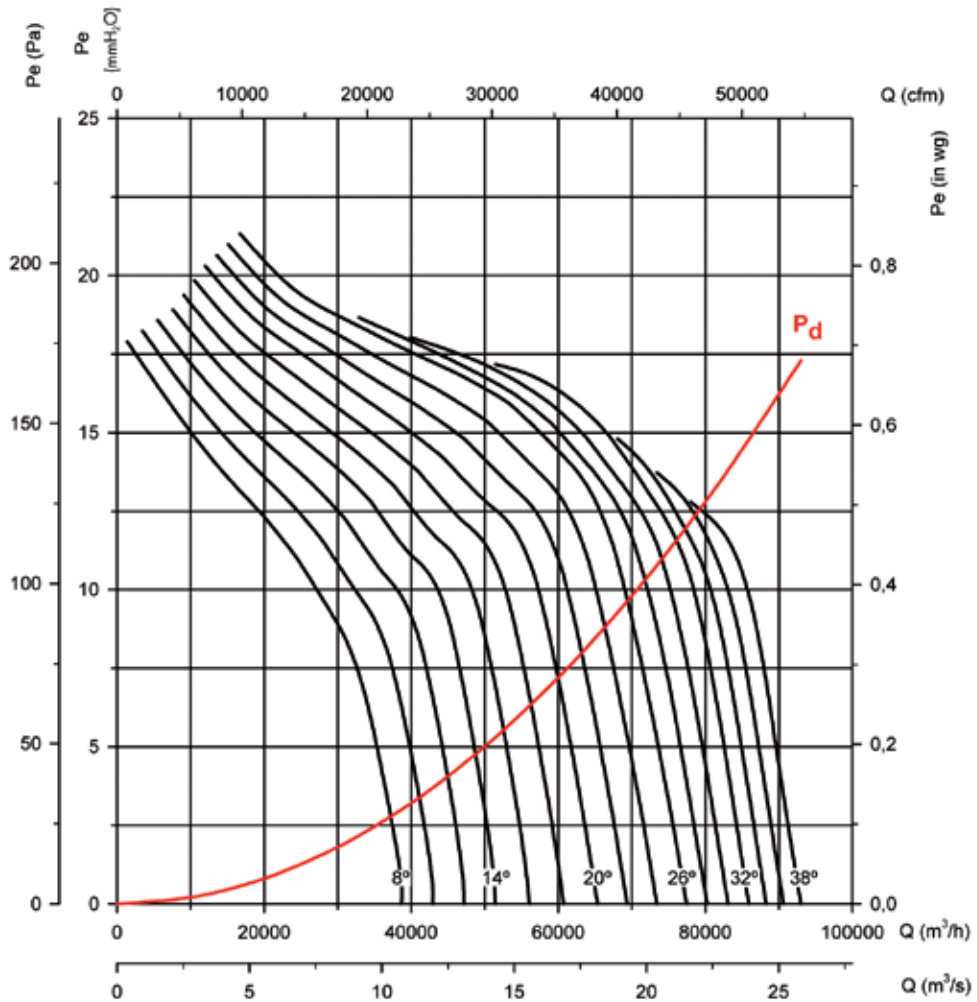

Consultar características del punto de máxima eficiencia (BEP) al final de la serie.

**Curvas características**

THT CJTHT/PLUS CJTHT CJTHT/DUPLEX/ATEX

Q= Caudal en m<sup>3</sup>/h, m<sup>3</sup>/s y cfm.

Pe= Presión estática en mmH<sub>2</sub>O, Pa e inwg.

**Diámetro Hélice (cm): 140**

**Número de polos: 8**

**Número de palas: 6**

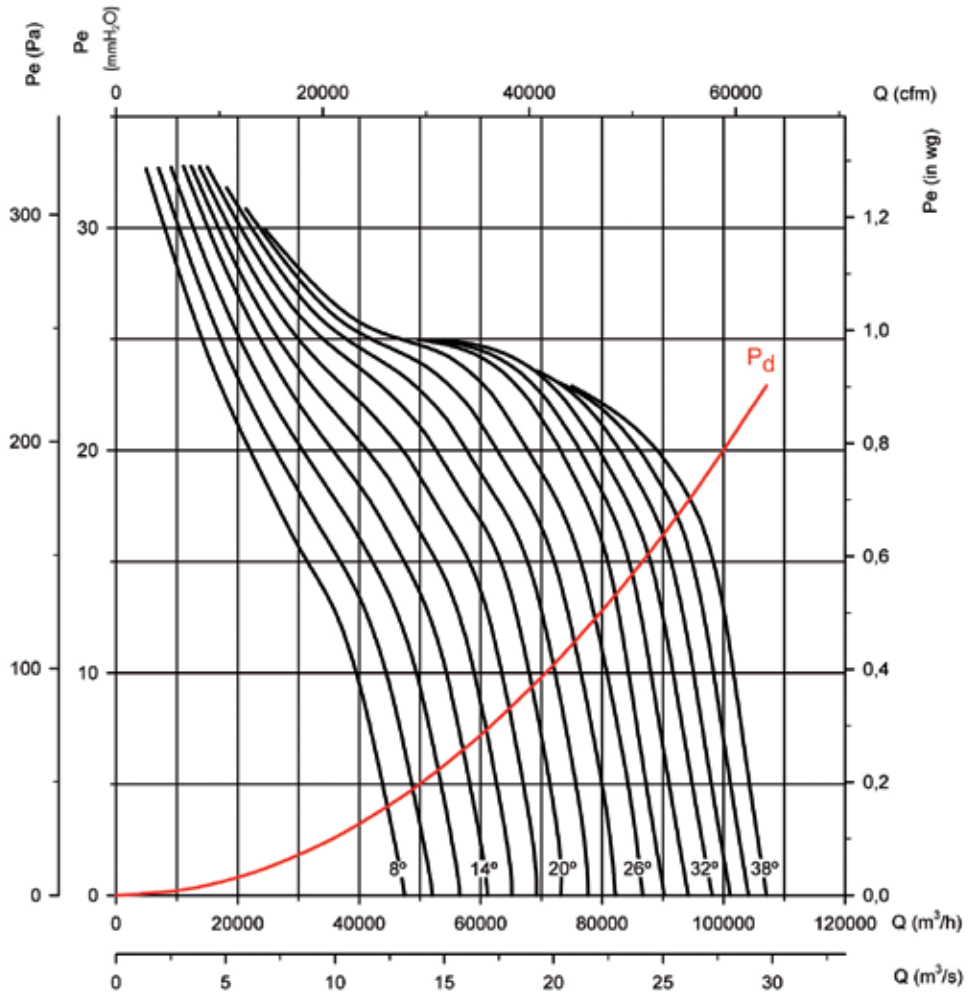

Potencia absorbida

Potencia Motor Recomendada kW(CV)

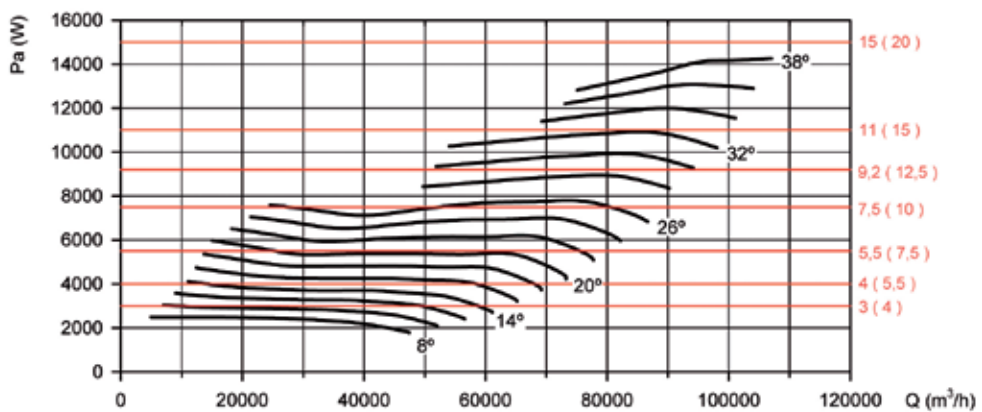

Consultar características del punto de máxima eficiencia (BEP) al final de la serie.

# THT CJTHT/PLUS CJTHT CJTHT/DUPLEX/ATEX

## Curvas características

THT

CJTHT/PLUS

CJTHT

CJTHT/DUPLEX/ATEX

Q= Caudal en m<sup>3</sup>/h, m<sup>3</sup>/s y cfm.

Pe= Presión estática en mmH<sub>2</sub>O, Pa e inwg.

**Diámetro Hélice (cm): 140**

**Número de polos: 8**

**Número de palas: 9**

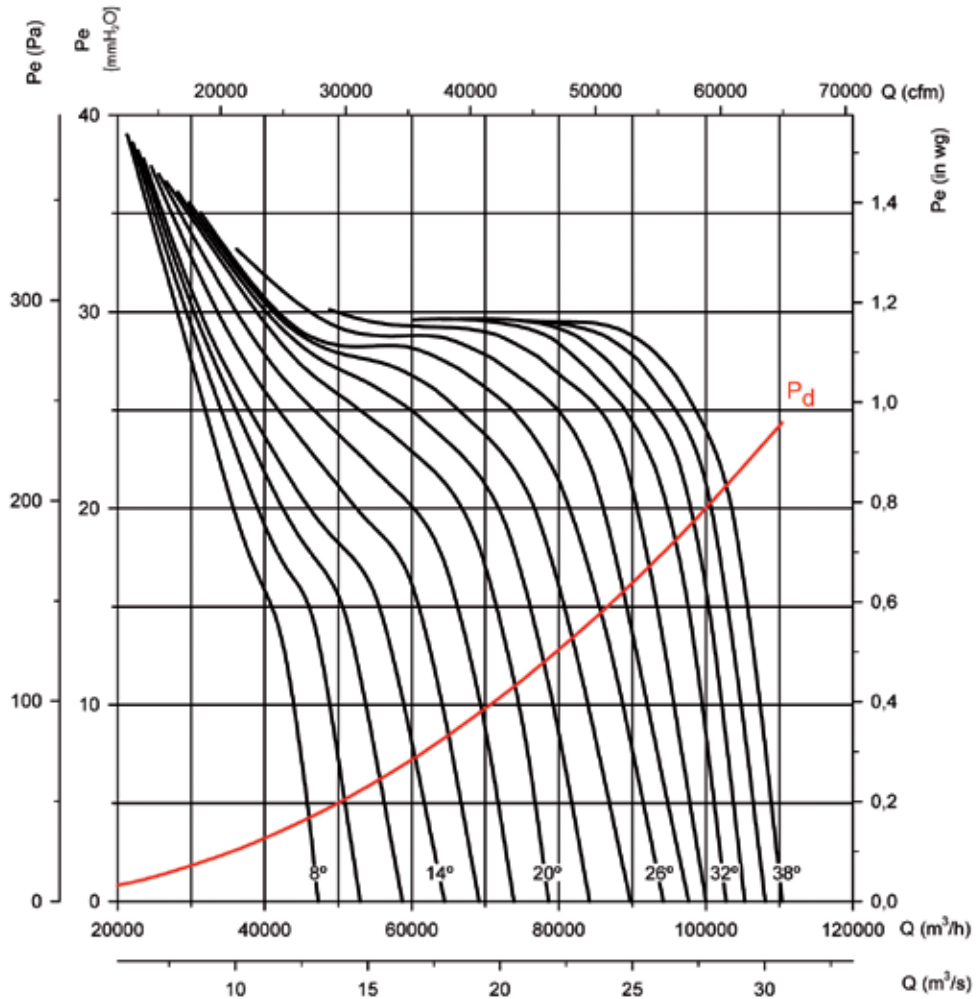

Potencia absorbida

Potencia Motor Recomendada kW(CV)

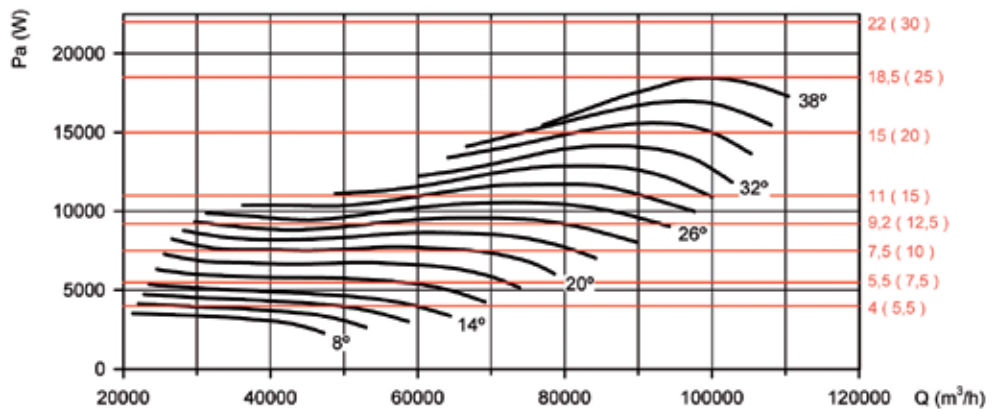

Consultar características del punto de máxima eficiencia (BEP) al final de la serie.

**Curvas características**

THT CJTHT/PLUS CJTHT CJTHT/DUPLEX/ATEX

Q= Caudal en m<sup>3</sup>/h, m<sup>3</sup>/s y cfm.

Pe= Presión estática en mmH<sub>2</sub>O, Pa e inwg.

**Diámetro Hélice (cm): 160**

**Número de polos: 6**

**Número de palas: 3**

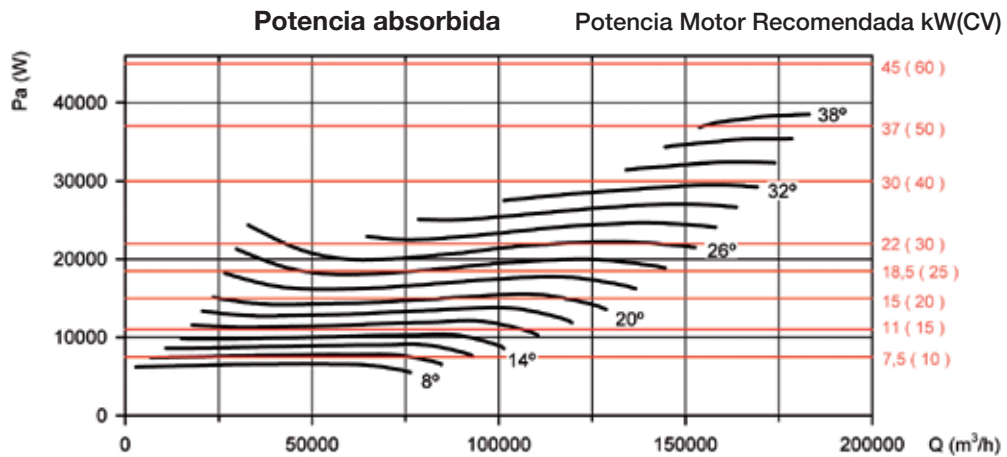
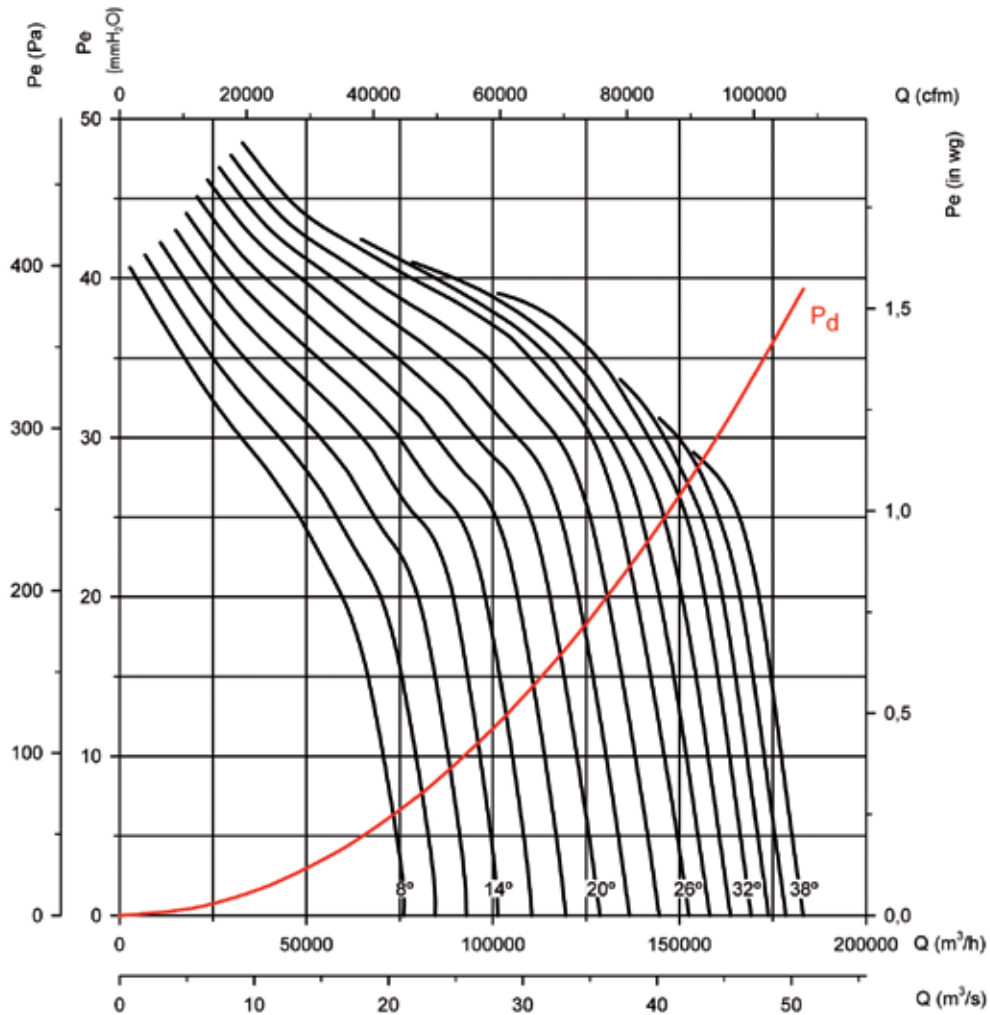

Consultar características del punto de máxima eficiencia (BEP) al final de la serie.



# THT CJTHT/PLUS CJTHT CJTHT/DUPLEX/ATEX

## Curvas características

THT CJTHT/PLUS CJTHT CJTHT/DUPLEX/ATEX

Q= Caudal en m<sup>3</sup>/h, m<sup>3</sup>/s y cfm.

Pe= Presión estática en mmH<sub>2</sub>O, Pa e inwg.

**Diámetro Hélice (cm): 160**

**Número de polos: 6**

**Número de palas: 6**

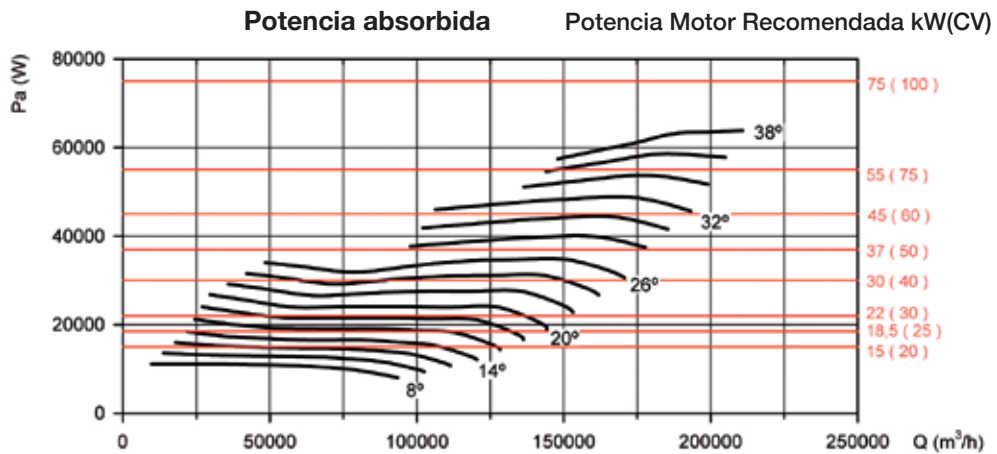
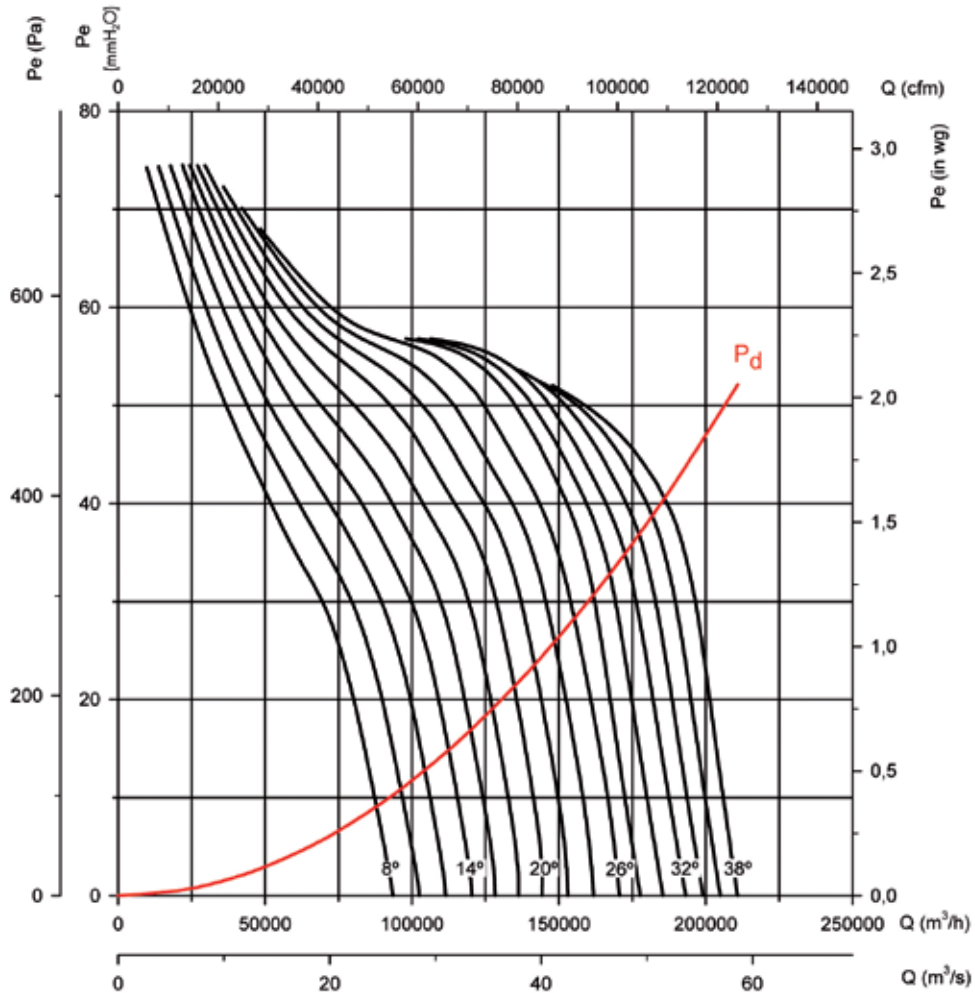

Consultar características del punto de máxima eficiencia (BEP) al final de la serie.

**Curvas características**

THT CJTHT/PLUS CJTHT CJTHT/DUPLEX/ATEX

Q= Caudal en m<sup>3</sup>/h, m<sup>3</sup>/s y cfm.

Pe= Presión estática en mmH<sub>2</sub>O, Pa e inwg.

**Diámetro Hélice (cm): 160**

**Número de polos: 6**

**Número de palas: 9**

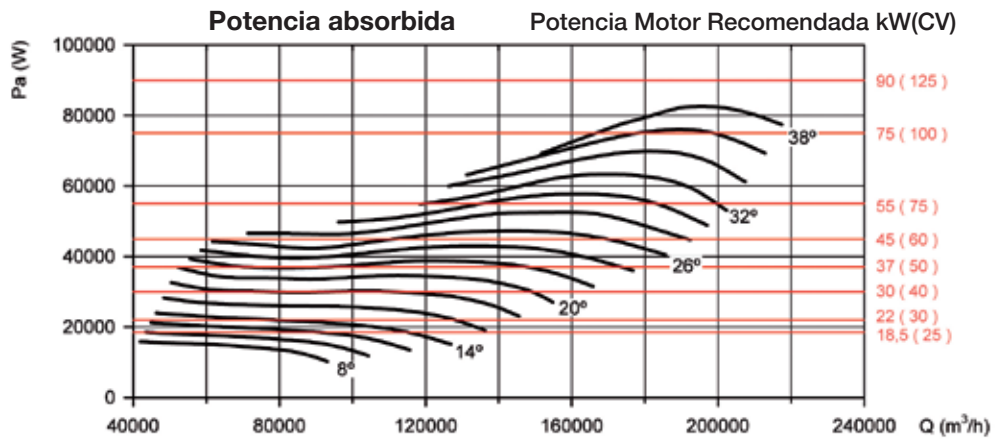
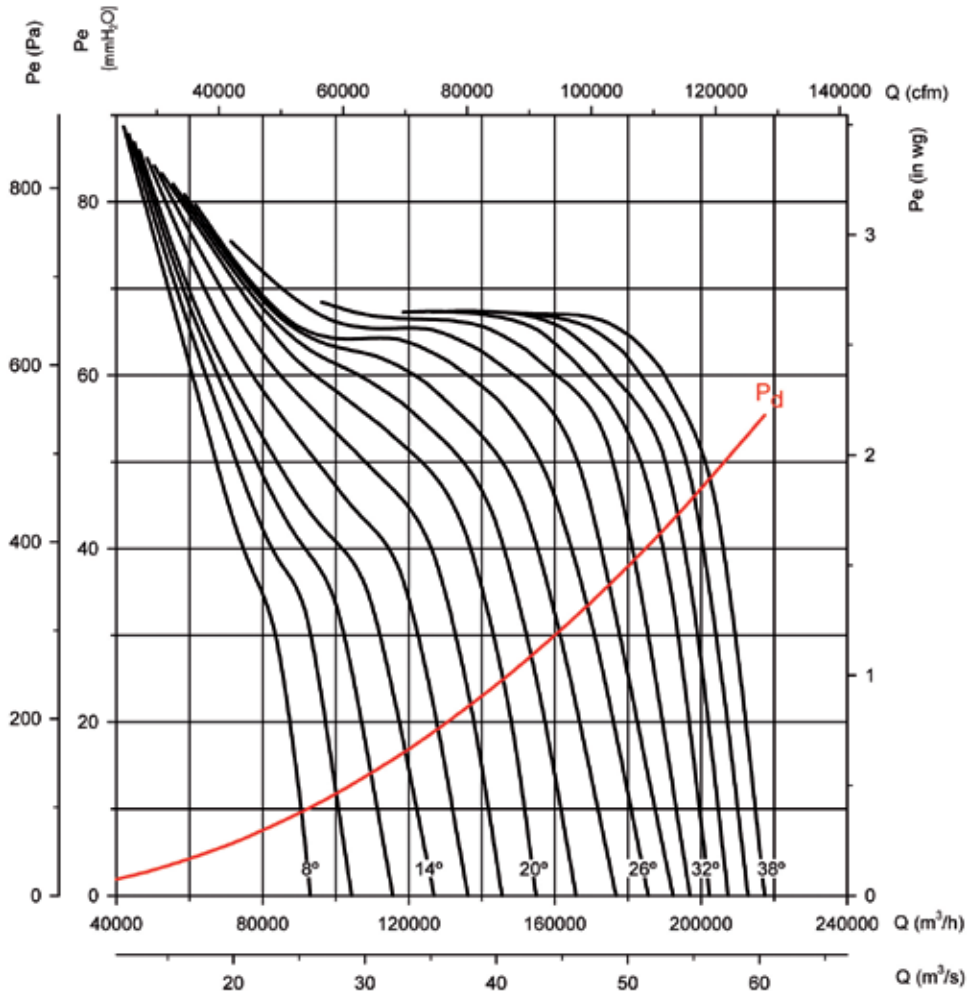

Consultar características del punto de máxima eficiencia (BEP) al final de la serie.

# THT CJTHT/PLUS CJTHT CJTHT/DUPLEX/ATEX

## Curvas características

THT CJTHT/PLUS CJTHT CJTHT/DUPLEX/ATEX

Q= Caudal en m<sup>3</sup>/h, m<sup>3</sup>/s y cfm.

Pe= Presión estática en mmH<sub>2</sub>O, Pa e inwg.

**Diámetro Hélice (cm): 160**

**Número de polos: 8**

**Número de palas: 3**

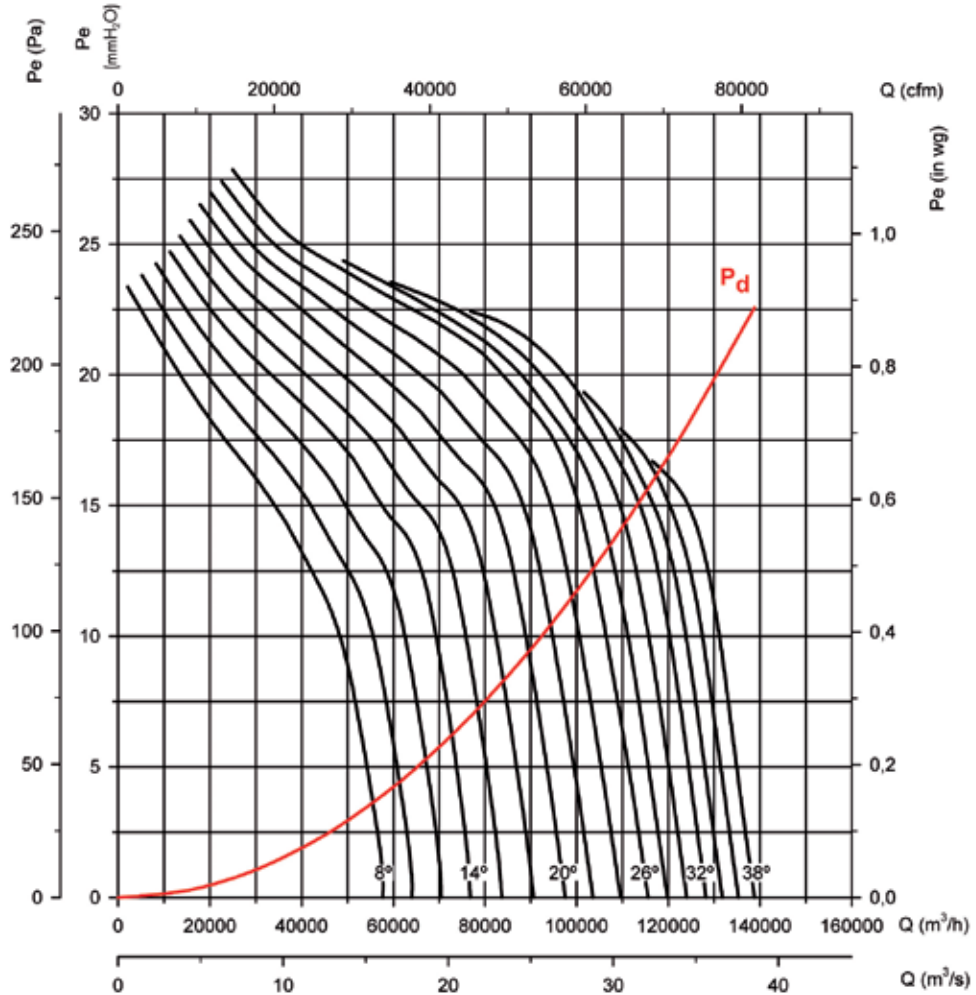

Potencia absorbida

Potencia Motor Recomendada kW(CV)

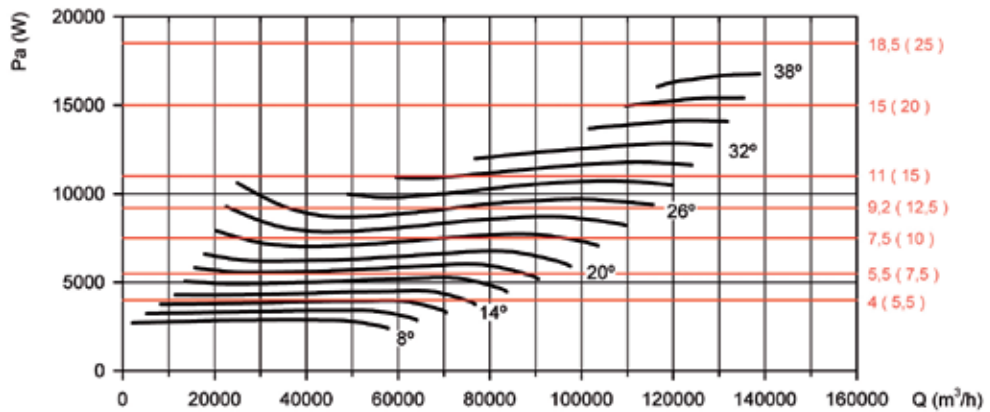

Consultar características del punto de máxima eficiencia (BEP) al final de la serie.

Curvas características

THT CJTHT/PLUS CJTHT CJTHT/DUPLEX/ATEX

Q= Caudal en m<sup>3</sup>/h, m<sup>3</sup>/s y cfm.

Pe= Presión estática en mmH<sub>2</sub>O, Pa e inwg.

Diámetro Hélice (cm): 160

Número de polos: 8

Número de palas: 6

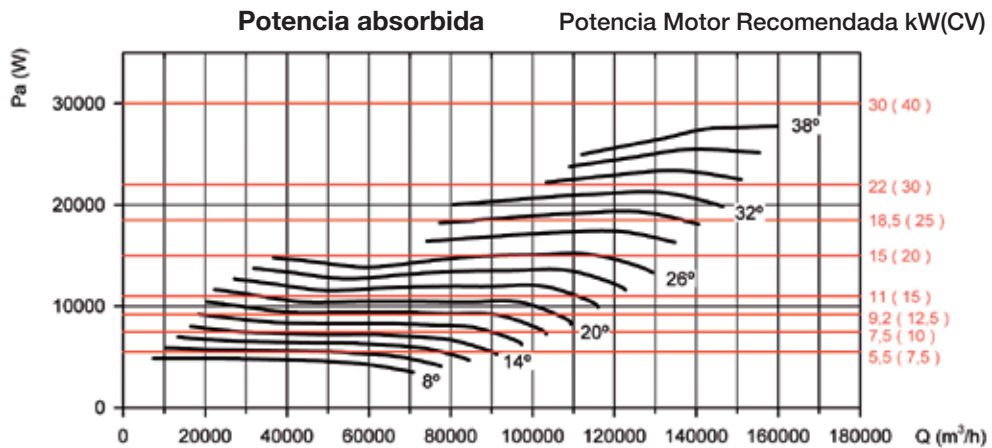
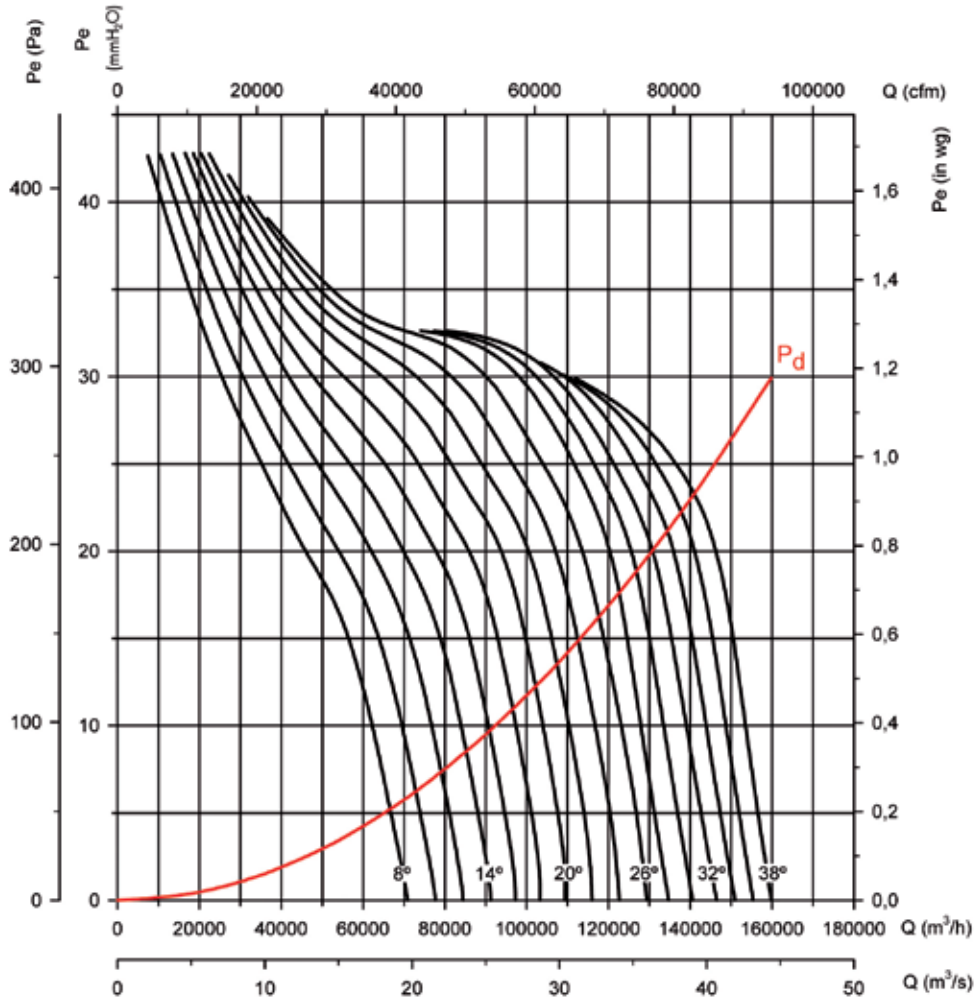

Consultar características del punto de máxima eficiencia (BEP) al final de la serie.

# THT CJTHT/PLUS CJTHT CJTHT/DUPLEX/ATEX

## Curvas características

THT

CJTHT/PLUS

CJTHT

CJTHT/DUPLEX/ATEX

Q= Caudal en m<sup>3</sup>/h, m<sup>3</sup>/s y cfm.

Pe= Presión estática en mmH<sub>2</sub>O, Pa e inwg.

**Diámetro Hélice (cm): 160**

**Número de polos: 8**

**Número de palas: 9**

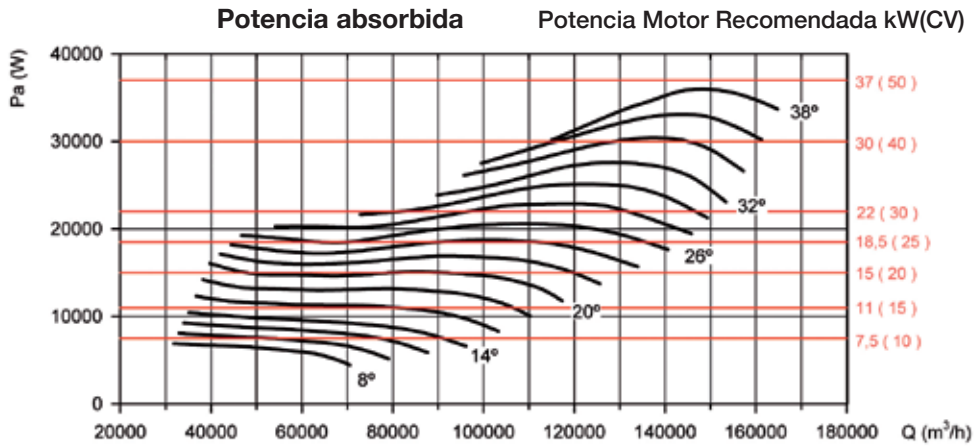
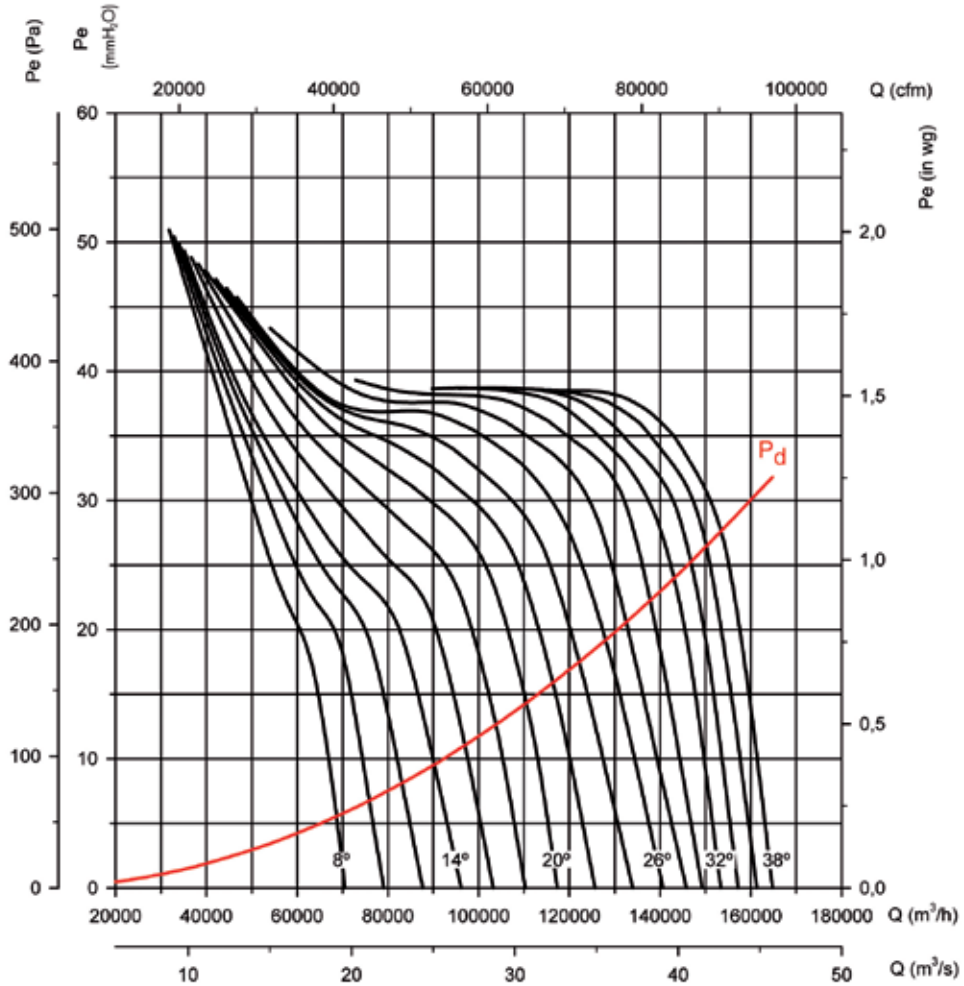

Consultar características del punto de máxima eficiencia (BEP) al final de la serie.



### Erp. Características del punto de máxima eficiencia (BEP)

<b>α</b> [°]	Ángulo inclinación palas en grados	<b>SR</b>	Relación específica
<b>PN</b>	Potencia nominal motor en kW	<b>ηe</b> [%]	Eficiencia
<b>MC</b>	Categoría de medición	<b>N</b>	Grado de eficiencia
<b>EC</b>	Categoría de eficiencia	<b>[kW]</b>	Potencia eléctrica
<b>S</b>	Estática	<b>[m³/h]</b>	Caudal
<b>T</b>	Total	<b>[mmH<sub>2</sub>O]</b>	Presión estática o total (Según EC)
<b>VSD</b>	Variador de velocidad	<b>[RPM]</b>	Velocidad

#### THT-40-2T

α [°]	PN	MC	EC	VSD	SR	ηe [%]	N	[kW]	[m³/h]	[mmH <sub>2</sub> O]	[RPM]
8	0,55	A	S	NO	1,00	62,6%	71,8	0,350	2568	31,36	2906
10	0,55	A	S	NO	1,00	52,2%	60,4	0,502	2900	33,16	2866
12	0,55	A	S	NO	1,00	47,1%	54,8	0,601	3889	26,74	2839
14	0,75	A	S	NO	1,00	43,7%	50,8	0,780	3142	39,89	2831
16	0,75	A	S	NO	1,00	40,1%	46,5	0,967	4420	32,19	2791
18	1,1	A	S	NO	1,00	38,8%	44,8	1,129	4772	33,70	2918
20	1,1	A	S	NO	1,00	36,4%	41,9	1,334	5180	34,43	2903
22	1,5	A	S	NO	1,00	35,0%	40,2	1,506	5517	35,04	2951
24	1,5	A	S	NO	1,00	33,3%	38,1	1,699	5784	35,89	2945
26	2,2	A	S	NO	1,00	33,1%	37,8	1,816	6197	35,64	2952
28	2,2	A	S	NO	1,00	31,0%	35,4	2,026	6675	34,58	2946
30	2,2	A	S	NO	1,00	29,1%	33,3	2,228	7045	33,87	2941
32	2,2	B	T	NO	1,00	44,1%	48,1	2,318	8257	45,45	2939

#### THT-40-4T

α [°]	PN	MC	EC	VSD	SR	ηe [%]	N	[kW]	[m³/h]	[mmH <sub>2</sub> O]	[RPM]
8	0,55	A	S	-	-	-	-	0,042	1284	7,84	1495
10	0,55	A	S	-	-	-	-	0,061	1339	9,01	1493
12	0,55	A	S	-	-	-	-	0,079	1425	9,60	1491
14	0,55	A	S	-	-	-	-	0,097	1571	9,97	1489
16	0,55	A	S	-	-	-	-	0,120	2210	8,05	1486
18	0,55	A	S	NO	1,00	38,0%	49,6	0,144	2386	8,43	1484
20	0,55	A	S	NO	1,00	36,1%	47,3	0,169	2564	8,71	1481
22	0,55	A	S	NO	1,00	33,5%	44,3	0,196	2758	8,76	1478
24	0,55	A	S	NO	1,00	32,3%	42,8	0,218	2939	8,80	1475
26	0,55	A	S	NO	1,00	31,0%	41,3	0,242	3099	8,91	1473
28	0,55	A	S	NO	1,00	29,1%	39,0	0,270	3337	8,65	1469
30	0,55	A	S	NO	1,00	27,3%	37,0	0,297	3522	8,47	1466
32	0,55	B	T	NO	1,00	41,3%	50,9	0,309	4129	11,36	1465

#### THT-40-6T

α [°]	PN	MC	EC	VSD	SR	ηe [%]	N	[kW]	[m³/h]	[mmH <sub>2</sub> O]	[RPM]
8	0,55	A	S	-	-	-	-	0,012	841	3,37	999
10	0,55	A	S	-	-	-	-	0,018	877	3,87	999
12	0,55	A	S	-	-	-	-	0,023	934	4,12	998
14	0,55	A	S	-	-	-	-	0,028	1029	4,28	998
16	0,55	A	S	-	-	-	-	0,035	1448	3,45	997
18	0,55	A	S	-	-	-	-	0,042	1563	3,62	997
20	0,55	A	S	-	-	-	-	0,049	1680	3,74	996
22	0,55	A	S	-	-	-	-	0,057	1807	3,76	995
24	0,55	A	S	-	-	-	-	0,064	1895	3,85	995
26	0,55	A	S	-	-	-	-	0,071	1987	3,92	994
28	0,55	A	S	-	-	-	-	0,078	2186	3,71	994
30	0,55	A	S	-	-	-	-	0,086	2308	3,63	993
32	0,55	B	T	-	-	-	-	0,094	2422	3,61	992

# THT CJTHT/PLUS CJTHT CJTHT/DUPLEX/ATEX

## THT-45-2T

α [°]	PN	MC	EC	VSD	SR	ηe [%]	N	[kW]	[m³/h]	[mmH₂O]	[RPM]
8	0,55	A	S	NO	1,00	53,7%	61,1	0,689	4682	29,06	2816
10	0,75	A	S	NO	1,00	45,6%	52,1	0,938	4676	33,60	2797
12	1,1	A	S	NO	1,00	41,7%	47,7	1,131	5445	31,82	2918
14	1,1	A	S	NO	1,00	39,4%	44,9	1,347	6350	30,67	2902
16	1,5	A	S	NO	1,00	38,0%	43,1	1,593	6802	32,70	2948
18	2,2	A	S	NO	1,00	37,4%	42,0	1,822	7270	34,40	2952
20	2,2	A	S	NO	1,00	36,8%	41,0	2,112	7694	37,06	2944
22	2,2	A	S	NO	1,01	37,5%	41,4	2,417	8144	40,86	2936
24	3	A	S	NO	1,01	37,6%	41,3	2,682	8424	44,02	2939
26	3	A	S	NO	1,01	36,0%	39,4	2,968	8872	44,28	2933
28	3	A	S	NO	1,01	31,7%	34,8	3,334	9370	41,49	2925
30	4	B	T	NO	1,00	44,3%	47,2	3,571	11649	49,90	2946

## THT-45-4T

α [°]	PN	MC	EC	VSD	SR	ηe [%]	N	[kW]	[m³/h]	[mmH₂O]	[RPM]
8	0,55	A	S	-	-	-	-	0,083	2341	7,26	1491
10	0,55	A	S	-	-	-	-	0,116	2338	8,40	1487
12	0,55	A	S	NO	1,00	40,9%	52,5	0,144	2742	7,89	1484
14	0,55	A	S	NO	1,00	38,6%	49,7	0,172	3175	7,67	1480
16	0,55	A	S	NO	1,00	36,5%	47,1	0,207	3401	8,17	1476
18	0,55	A	S	NO	1,00	35,0%	45,2	0,243	3635	8,60	1472
20	0,55	A	S	NO	1,00	34,9%	44,7	0,281	3947	9,14	1468
22	0,55	A	S	NO	1,00	34,4%	43,9	0,319	4027	10,01	1464
24	0,55	A	S	NO	1,00	34,2%	43,3	0,364	4316	10,59	1459
26	0,55	A	S	NO	1,00	33,8%	42,6	0,403	4312	11,62	1454
28	0,55	A	S	NO	1,00	29,3%	37,8	0,452	4685	10,37	1449
30	0,55	B	T	NO	1,00	40,3%	48,6	0,491	5825	12,48	1444
32	0,55	B	T	NO	1,00	39,0%	47,1	0,531	6243	12,19	1440
34	0,55	B	T	NO	1,00	38,8%	46,7	0,574	6470	12,66	1435
36	0,55	B	T	NO	1,00	38,5%	46,2	0,618	6694	13,06	1430
38	0,55	B	T	NO	1,00	38,2%	45,6	0,661	6877	13,48	1425

## THT-45-6T

α [°]	PN	MC	EC	VSD	SR	ηe [%]	N	[kW]	[m³/h]	[mmH₂O]	[RPM]
8	0,55	A	S	-	-	-	-	0,024	1534	3,12	998
10	0,55	A	S	-	-	-	-	0,034	1532	3,61	997
12	0,55	A	S	-	-	-	-	0,042	1797	3,39	997
14	0,55	A	S	-	-	-	-	0,050	2080	3,29	996
16	0,55	A	S	-	-	-	-	0,060	2228	3,51	995
18	0,55	A	S	-	-	-	-	0,070	2382	3,69	994
20	0,55	A	S	-	-	-	-	0,081	2586	3,92	993
22	0,55	A	S	-	-	-	-	0,092	2644	4,41	992
24	0,55	A	S	-	-	-	-	0,105	2760	4,72	991
26	0,55	A	S	-	-	-	-	0,116	2826	4,97	990
28	0,55	A	S	NO	1,00	28,5%	40,4	0,131	3069	4,45	989
30	0,55	B	T	NO	1,00	39,2%	50,9	0,142	3816	5,36	988
32	0,55	B	T	NO	1,00	37,9%	49,4	0,154	4090	5,23	987
34	0,55	B	T	NO	1,00	37,8%	49,0	0,166	4239	5,43	986
36	0,55	B	T	NO	1,00	37,5%	48,5	0,179	4386	5,60	985
38	0,55	B	T	NO	1,00	37,1%	48,0	0,191	4506	5,79	984

## THT-50-2T

α [°]	PN	MC	EC	VSD	SR	ηe [%]	N	[kW]	[m³/h]	[mmH₂O]	[RPM]
8	2,2	A	S	NO	1,00	40,3%	45,0	1,823	6883	39,24	2952
10	2,2	A	S	NO	1,00	38,0%	42,1	2,221	7275	42,60	2941
12	2,2	A	S	NO	1,00	36,8%	40,6	2,577	8011	43,55	2932
14	3	A	S	NO	1,01	36,5%	39,9	2,890	8704	44,52	2935
16	3	A	S	NO	1,01	34,4%	37,4	3,386	9218	46,38	2924
18	4	A	S	NO	1,01	33,2%	35,9	3,816	9715	47,89	2943
20	4	A	S	NO	1,01	31,7%	34,0	4,297	9906	50,43	2935
22	4	A	S	NO	1,01	30,7%	32,8	4,615	9091	57,23	2931
24	5,5	B	T	NO	1,00	44,1%	46,0	5,040	15830	51,58	2928
26	5,5	B	T	NO	1,01	44,7%	46,3	5,508	16933	53,40	2922
28	5,5	B	T	NO	1,01	43,7%	45,0	6,251	18159	55,30	2911
30	7,5	B	T	NO	1,01	44,2%	45,2	6,938	19309	58,31	2959
32	7,5	B	T	NO	1,01	44,3%	45,0	7,696	20591	60,82	2955



### Erp. Características del punto de máxima eficiencia (BEP)

#### THT-50-4T

α [°]	PN	MC	EC	VSD	SR	ηe [%]	N	[kW]	[m³/h]	[mmH₂O]	[RPM]
8	0,55	A	S	NO	1,00	37,8%	48,0	0,243	3441	9,81	1472
10	0,55	A	S	NO	1,00	35,6%	45,3	0,296	3638	10,65	1466
12	0,55	A	S	NO	1,00	34,6%	43,8	0,344	4006	10,89	1461
14	0,55	A	S	NO	1,00	33,7%	42,6	0,392	4352	11,13	1456
16	0,55	A	S	NO	1,00	31,7%	40,2	0,459	4609	11,60	1448
18	0,55	A	S	NO	1,00	30,2%	38,3	0,525	4858	11,97	1440
20	0,55	A	S	NO	1,00	28,8%	36,6	0,591	4953	12,61	1433
22	0,55	A	S	NO	1,00	27,9%	35,5	0,634	4545	14,31	1428
24	0,55	B	T	NO	1,00	39,5%	46,8	0,703	7915	12,90	1420
26	0,75	B	T	NO	1,00	40,9%	48,0	0,753	8466	13,35	1444
28	0,75	B	T	NO	1,00	40,0%	46,8	0,854	9080	13,83	1437
30	1,1	B	T	NO	1,00	40,8%	47,3	0,939	9654	14,58	1458
32	1,1	B	T	NO	1,00	40,9%	47,1	1,041	10296	15,21	1454
34	1,1	B	T	NO	1,00	40,8%	46,8	1,161	11232	15,50	1448
36	1,1	B	T	NO	1,00	40,6%	46,2	1,302	11647	16,67	1442
38	1,5	B	T	NO	1,00	41,2%	46,6	1,420	12048	17,84	1453

#### THT-50-6T

α [°]	PN	MC	EC	VSD	SR	ηe [%]	N	[kW]	[m³/h]	[mmH₂O]	[RPM]
8	0,55	A	S	-	-	-	-	0,070	2255	4,21	994
10	0,55	A	S	-	-	-	-	0,086	2383	4,57	993
12	0,55	A	S	-	-	-	-	0,099	2624	4,67	992
14	0,55	A	S	-	-	-	-	0,113	2851	4,78	991
16	0,55	A	S	NO	1,00	30,8%	42,7	0,133	3020	4,98	989
18	0,55	A	S	NO	1,00	29,4%	40,9	0,152	3183	5,14	987
20	0,55	A	S	NO	1,00	28,0%	39,2	0,171	3245	5,41	986
22	0,55	A	S	NO	1,00	27,1%	38,1	0,183	2978	6,14	985
24	0,55	B	T	NO	1,00	38,5%	49,2	0,203	5186	5,54	983
26	0,55	B	T	NO	1,00	39,0%	49,4	0,222	5547	5,73	982
28	0,55	B	T	NO	1,00	38,1%	48,2	0,252	5949	5,93	979
30	0,55	B	T	NO	1,00	38,0%	47,8	0,283	6325	6,26	977
32	0,55	B	T	NO	1,00	38,1%	47,6	0,314	6745	6,53	974
34	0,55	B	T	NO	1,00	38,1%	47,3	0,350	7359	6,65	971
36	0,55	B	T	NO	1,00	37,8%	46,7	0,393	7631	7,16	967
38	0,55	B	T	NO	1,00	37,8%	46,4	0,436	7894	7,66	964

#### THT-56-2T

α [°]	PN	MC	EC	VSD	SR	ηe [%]	N	[kW]	[m³/h]	[mmH₂O]	[RPM]
8	2,2	A	S	NO	1,00	58,8%	63,2	1,998	9846	43,83	2947
10	2,2	A	S	NO	1,01	53,7%	57,5	2,516	10679	46,48	2933
12	3	A	S	NO	1,01	50,4%	53,7	3,075	11114	51,27	2931
14	4	A	S	NO	1,01	49,1%	51,9	3,547	11978	53,38	2947
16	4	A	S	NO	1,01	45,3%	47,7	4,212	12896	54,34	2937
18	5,5	A	S	NO	1,01	43,0%	45,0	4,831	14184	53,78	2931
20	5,5	A	S	NO	1,01	42,8%	44,4	5,527	14979	57,97	2921
22	5,5	A	S	NO	1,01	40,7%	42,1	6,123	15917	57,53	2913
24	7,5	A	S	NO	1,01	39,0%	40,1	6,641	16159	58,84	2961
26	7,5	A	S	NO	1,01	38,6%	39,5	7,220	16918	60,47	2958
28	7,5	B	T	NO	1,01	54,7%	55,3	8,171	22277	73,70	2952
30	11	B	T	NO	1,01	52,8%	53,1	9,148	23259	76,30	2952
32	11	B	T	NO	1,01	51,1%	51,1	10,225	24598	77,96	2946
34	11	B	T	NO	1,01	49,8%	49,8	11,302	25738	80,28	2940
36	15	B	T	NO	1,01	49,9%	49,8	12,244	27684	81,05	2971
38	15	B	T	NO	1,01	49,4%	49,3	13,318	28598	84,53	2968
40	15	B	T	NO	1,01	47,2%	47,0	14,400	29153	85,69	2965
42	15	B	T	NO	1,01	45,7%	45,4	15,620	30493	85,95	2962





## Erp. Características del punto de máxima eficiencia (BEP)

### THT-56-4T

α [°]	PN	MC	EC	VSD	SR	ηe [%]	N	[kW]	[m³/h]	[mmH₂O]	[RPM]
8	0,55	A	S	NO	1,00	55,1%	65,1	0,266	4923	10,96	1470
10	0,55	A	S	NO	1,00	50,4%	59,7	0,335	5339	11,62	1462
12	0,55	A	S	NO	1,00	46,5%	55,2	0,417	5557	12,82	1453
14	0,55	A	S	NO	1,00	44,6%	52,9	0,488	5989	13,35	1445
16	0,55	A	S	NO	1,00	41,2%	49,0	0,579	6448	13,58	1434
18	0,55	A	S	NO	1,00	38,5%	45,9	0,674	7092	13,45	1424
20	0,75	A	S	NO	1,00	39,1%	46,2	0,755	7489	14,49	1444
22	0,75	A	S	NO	1,00	37,2%	44,1	0,837	7959	14,38	1438
24	0,75	A	S	NO	1,00	35,2%	41,8	0,919	8079	14,71	1432
26	1,1	A	S	NO	1,00	35,6%	42,0	0,977	8459	15,12	1457
28	1,1	B	T	NO	1,00	50,5%	56,6	1,106	11138	18,42	1451
30	1,1	B	T	NO	1,00	48,1%	53,8	1,255	11629	19,08	1444
32	1,5	B	T	NO	1,00	47,3%	52,7	1,380	12299	19,49	1454
34	1,5	B	T	NO	1,00	46,1%	51,3	1,525	12869	20,07	1450
36	1,5	B	T	NO	1,00	45,6%	50,5	1,670	13581	20,60	1445
38	2,2	B	T	NO	1,00	45,9%	50,7	1,780	14043	21,38	1456
40	2,2	B	T	NO	1,00	44,1%	48,7	1,926	14576	21,42	1452
42	2,2	B	T	NO	1,00	42,7%	47,0	2,089	15246	21,49	1448
44	2,2	B	T	NO	1,00	42,0%	46,0	2,308	16393	21,70	1442

### THT-56-6T

α [°]	PN	MC	EC	VSD	SR	ηe [%]	N	[kW]	[m³/h]	[mmH₂O]	[RPM]
8	0,55	A	S	-	-	-	-	0,077	3225	4,70	994
10	0,55	A	S	-	-	-	-	0,097	3498	4,99	992
12	0,55	A	S	-	-	-	-	0,121	3641	5,50	990
14	0,55	A	S	NO	1,00	43,4%	55,1	0,141	3924	5,73	988
16	0,55	A	S	NO	1,00	40,1%	51,3	0,167	4225	5,83	986
18	0,55	A	S	NO	1,00	37,5%	48,3	0,195	4646	5,77	984
20	0,55	A	S	NO	1,00	37,3%	47,7	0,223	4907	6,22	982
22	0,55	A	S	NO	1,00	35,5%	45,7	0,247	5214	6,17	980
24	0,55	A	S	NO	1,00	33,6%	43,5	0,271	5293	6,31	978
26	0,55	A	S	NO	1,00	33,2%	42,9	0,295	5542	6,49	976
28	0,55	B	T	NO	1,00	47,1%	56,4	0,334	7298	7,91	972
30	0,55	B	T	NO	1,00	44,8%	53,8	0,379	7619	8,19	969
32	0,55	B	T	NO	1,00	43,4%	52,0	0,423	8058	8,37	965
34	0,55	B	T	NO	1,00	42,3%	50,7	0,468	8431	8,61	961
36	0,55	B	T	NO	1,00	41,9%	50,1	0,512	9069	8,70	958
38	0,55	B	T	NO	1,00	41,5%	49,5	0,557	9368	9,07	954
40	0,55	B	T	NO	1,00	39,7%	47,4	0,602	9550	9,20	950
42	0,55	B	T	NO	1,00	38,4%	45,9	0,653	9989	9,22	946
44	0,55	B	T	NO	1,00	37,8%	45,0	0,721	10740	9,32	940

### THT-63-2T

α [°]	PN	MC	EC	VSD	SR	ηe [%]	N	[kW]	[m³/h]	[mmH₂O]	[RPM]
8	4	C	S	NO	1,01	48,2%	50,3	4,647	13801	59,58	2930
10	5,5	C	S	NO	1,01	47,7%	49,5	5,240	15062	60,95	2925
12	5,5	C	S	NO	1,01	47,0%	48,4	5,900	16392	62,10	2916
14	7,5	C	S	NO	1,01	47,2%	48,4	6,481	17777	63,16	2962
16	7,5	C	S	NO	1,01	46,3%	47,2	7,270	19115	64,69	2957
18	7,5	C	S	NO	1,01	47,0%	47,6	8,043	19736	70,39	2953
20	11	C	S	NO	1,01	47,9%	48,3	8,699	20827	73,50	2954
22	11	C	S	NO	1,01	44,4%	44,5	10,183	22211	74,82	2946
24	11	C	S	NO	1,01	41,3%	41,3	11,648	23509	75,23	2938
26	15	C	S	NO	1,01	39,1%	39,0	13,056	24775	75,68	2969
28	15	B	T	NO	1,01	59,9%	59,7	14,890	35881	91,36	2964
30	18,5	B	T	NO	1,01	58,8%	58,5	16,674	37937	94,99	2951
32	18,5	B	T	NO	1,01	58,0%	57,6	18,487	40069	98,35	2946
34	18,5	B	T	NO	1,01	57,6%	57,2	19,943	44238	95,40	2941
36	22	B	T	NO	1,01	57,8%	57,3	21,625	45504	100,94	2955
38	22	B	T	NO	1,01	58,2%	57,7	23,397	46829	106,91	2951

**Erp. Características del punto de máxima eficiencia (BEP)****THT-63-4T**

↕ [°]	PN	MC	EC	VSD	SR	ηe [%]	N	[kW]	[m³/h]	[mmH₂O]	[RPM]
8	0,55	C	S	NO	1,00	49,4%	57,1	0,605	7675	14,31	1431
10	0,75	C	S	NO	1,00	48,9%	56,2	0,695	7963	15,67	1448
12	0,75	C	S	NO	1,00	50,0%	57,0	0,781	8606	16,66	1442
14	0,75	C	S	NO	1,00	49,8%	56,5	0,868	9291	17,07	1436
16	1,1	C	S	NO	1,00	48,2%	54,6	0,966	9692	17,64	1457
18	1,1	C	S	NO	1,00	48,0%	54,1	1,078	10219	18,59	1452
20	1,1	C	S	NO	1,00	47,9%	53,7	1,193	10625	19,76	1447
22	1,5	C	S	NO	1,00	45,0%	50,5	1,360	11327	19,86	1455
24	1,5	C	S	NO	1,00	42,3%	47,4	1,551	12026	20,03	1449
26	1,5	C	S	NO	1,00	40,3%	45,1	1,748	12561	20,60	1442
28	2,2	B	T	NO	1,00	64,2%	68,7	1,953	18581	24,78	1451
30	2,2	B	T	NO	1,00	62,7%	66,9	2,201	19481	26,02	1445
32	2,2	B	T	NO	1,00	61,9%	65,8	2,447	20324	27,38	1439
34	3	B	T	NO	1,00	61,8%	65,5	2,610	21482	27,57	1448
36	3	B	T	NO	1,00	61,7%	65,2	2,810	22995	27,71	1444
38	3	B	T	NO	1,00	62,6%	65,9	3,020	24239	28,64	1440

**THT-63-6T**

↕ [°]	PN	MC	EC	VSD	SR	ηe [%]	N	[kW]	[m³/h]	[mmH₂O]	[RPM]
8	0,55	C	S	NO	1,00	48,1%	59,2	0,175	5028	6,14	986
10	0,55	C	S	NO	1,00	46,6%	57,3	0,205	5217	6,73	983
12	0,55	C	S	NO	1,00	47,6%	58,0	0,231	5639	7,15	981
14	0,55	C	S	NO	1,00	47,4%	57,5	0,256	6087	7,33	979
16	0,55	C	S	NO	1,00	44,9%	54,6	0,291	6350	7,57	976
18	0,55	C	S	NO	1,00	44,7%	54,1	0,325	6695	7,98	973
20	0,55	C	S	NO	1,00	44,6%	53,8	0,360	6961	8,48	970
22	0,55	C	S	NO	1,00	41,3%	50,0	0,417	7421	8,53	965
24	0,55	C	S	NO	1,00	38,8%	47,1	0,476	7879	8,60	961
26	0,55	C	S	NO	1,00	36,9%	45,0	0,536	8230	8,84	956
28	0,55	B	T	NO	1,00	57,7%	65,4	0,611	12174	10,64	949
30	0,55	B	T	NO	1,00	56,4%	63,7	0,688	12764	11,17	943
32	0,75	B	T	NO	1,00	57,3%	64,5	0,743	13316	11,75	954
34	0,75	B	T	NO	1,00	56,4%	63,3	0,804	14075	11,84	950
36	0,75	B	T	NO	1,00	56,4%	63,1	0,865	15066	11,90	946
38	0,75	B	T	NO	1,00	57,1%	63,7	0,930	15880	12,29	942

**THT-71-4T**

↕ [°]	PN	MC	EC	VSD	SR	ηe [%]	N	[kW]	[m³/h]	[mmH₂O]	[RPM]
8	1,1	C	S	NO	1,00	50,2%	56,5	0,999	10244	17,99	1456
10	1,1	C	S	NO	1,00	48,7%	54,5	1,172	11274	18,59	1448
12	1,1	C	S	NO	1,00	47,9%	53,4	1,346	12330	19,20	1440
14	1,5	C	S	NO	1,00	48,4%	53,6	1,495	13405	19,83	1450
16	1,5	C	S	NO	1,00	45,8%	50,6	1,717	14522	19,88	1443
18	2,2	C	S	NO	1,00	45,2%	49,8	1,906	15360	20,62	1452
20	2,2	C	S	NO	1,00	44,8%	49,1	2,168	16397	21,78	1446
22	2,2	C	S	NO	1,00	42,8%	46,8	2,369	17056	21,84	1441
24	2,2	C	S	NO	1,00	42,2%	45,9	2,566	17819	22,30	1436
26	3	C	S	NO	1,00	42,1%	45,6	2,734	18933	22,31	1445
28	3	C	S	NO	1,00	40,7%	44,0	2,976	19369	22,96	1441
30	3	C	S	NO	1,00	38,7%	41,8	3,225	19849	23,10	1436
32	3	C	S	NO	1,00	37,3%	40,2	3,456	20418	23,20	1431
34	4	C	S	NO	1,00	36,2%	39,0	3,681	21714	22,57	1460
36	4	B	T	NO	1,00	64,6%	67,0	4,158	28986	34,02	1455
38	4	B	T	NO	1,00	62,8%	65,0	4,510	29926	34,78	1451

# THT CJTHT/PLUS CJTHT CJTHT/DUPLEX/ATEX



## Erp. Características del punto de máxima eficiencia (BEP)

### THT-71-6T

α [°]	PN	MC	EC	VSD	SR	ηe [%]	N	[kW]	[m³/h]	[mmH₂O]	[RPM]
8	0,55	C	S	NO	1,00	46,8%	56,4	0,302	6712	7,72	975
10	0,55	C	S	NO	1,00	45,3%	54,5	0,354	7386	7,98	971
12	0,55	C	S	NO	1,00	44,6%	53,4	0,406	8078	8,24	966
14	0,55	C	S	NO	1,00	44,4%	52,8	0,459	8783	8,51	962
16	0,55	C	S	NO	1,00	42,0%	50,1	0,527	9514	8,53	956
18	0,55	C	S	NO	1,00	40,7%	48,4	0,596	10063	8,85	951
20	0,55	C	S	NO	1,00	40,3%	47,7	0,678	10743	9,35	944
22	0,75	C	S	NO	1,00	39,6%	46,9	0,720	11175	9,37	955
24	0,75	C	S	NO	1,00	39,0%	46,1	0,779	11674	9,57	951
26	0,75	C	S	NO	1,00	38,4%	45,2	0,842	12404	9,58	947
28	0,75	C	S	NO	1,00	37,1%	43,7	0,916	12690	9,86	943
30	1,1	C	S	NO	1,00	36,1%	42,5	0,972	13005	9,92	961
32	1,1	C	S	NO	1,00	34,8%	41,0	1,041	13377	9,96	958
34	1,1	C	S	NO	1,00	33,4%	39,4	1,123	14226	9,69	955
36	1,1	B	T	NO	1,00	59,5%	65,2	1,268	18991	14,60	949
38	1,1	B	T	NO	1,00	57,9%	63,4	1,376	19607	14,93	945

### THT-80-4T

α [°]	PN	MC	EC	VSD	SR	ηe [%]	N	[kW]	[m³/h]	[mmH₂O]	[RPM]
8	1,5	C	S	NO	1,00	51,0%	55,9	1,683	13964	22,58	1444
10	2,2	C	S	NO	1,00	49,4%	53,8	1,987	15817	22,78	1450
12	2,2	C	S	NO	1,00	47,0%	51,0	2,417	16923	24,69	1440
14	3	C	S	NO	1,00	47,2%	50,7	2,746	18703	25,45	1445
16	3	C	S	NO	1,00	44,5%	47,4	3,404	20444	27,19	1432
18	4	C	S	NO	1,00	43,6%	46,1	4,011	22304	28,78	1457
20	5,5	C	S	NO	1,00	43,7%	45,8	4,605	23848	30,98	1474
22	5,5	C	S	NO	1,00	44,7%	46,6	4,902	24787	32,44	1473
24	5,5	C	S	NO	1,00	42,9%	44,6	5,410	25791	33,05	1470
26	5,5	C	S	NO	1,00	42,0%	43,5	5,852	26826	33,68	1467
28	7,5	C	S	NO	1,00	41,1%	42,3	6,423	27918	34,75	1473
30	7,5	C	S	NO	1,01	40,4%	41,4	7,090	29984	35,12	1471
32	7,5	C	S	NO	1,01	39,5%	40,2	7,743	31204	35,97	1468

### THT-80-6T

α [°]	PN	MC	EC	VSD	SR	ηe [%]	N	[kW]	[m³/h]	[mmH₂O]	[RPM]
8	1,1	C	S	NO	1,00	49,2%	57,5	0,491	9149	9,69	980
10	1,1	C	S	NO	1,00	46,7%	54,5	0,591	10363	9,78	976
12	1,1	C	S	NO	1,00	44,5%	51,8	0,718	11087	10,60	971
14	1,1	C	S	NO	1,00	44,0%	50,9	0,828	12254	10,92	967
16	1,1	C	S	NO	1,00	41,5%	47,7	1,026	13395	11,67	959
18	1,1	C	S	NO	1,00	40,2%	45,9	1,224	14613	12,35	951
20	1,5	C	S	NO	1,00	40,8%	46,2	1,388	15625	13,30	970
22	1,5	C	S	NO	1,00	41,7%	46,9	1,478	16240	13,93	968
24	1,5	C	S	NO	1,00	40,0%	45,0	1,631	16897	14,19	964
26	1,5	C	S	NO	1,00	39,2%	44,0	1,764	17576	14,46	962
28	2,2	C	S	NO	1,00	38,6%	43,2	1,922	18291	14,92	964
30	2,2	C	S	NO	1,00	38,0%	42,3	2,122	19645	15,07	960
32	2,2	C	S	NO	1,00	37,1%	41,1	2,317	20444	15,44	956

### THT-80-8T

α [°]	PN	MC	EC	VSD	SR	ηe [%]	N	[kW]	[m³/h]	[mmH₂O]	[RPM]
8	0,55	C	S	NO	1,00	39,4%	49,4	0,266	6934	5,57	734
10	0,55	C	S	NO	1,00	37,5%	46,9	0,321	7854	5,62	731
12	0,55	C	S	NO	1,00	35,7%	44,6	0,390	8403	6,09	727
14	0,55	C	S	NO	1,00	35,3%	43,8	0,449	9287	6,27	724
16	0,55	C	S	NO	1,00	33,3%	41,2	0,557	10152	6,70	718
18	0,55	C	S	NO	1,00	32,2%	39,6	0,664	11075	7,10	711
20	0,55	C	S	NO	1,00	31,9%	38,9	0,772	11842	7,64	705
22	0,55	C	S	NO	1,00	32,6%	39,5	0,822	12308	8,00	702
24	0,75	C	S	NO	1,00	36,2%	43,2	0,785	12806	8,15	719
26	0,75	C	S	NO	1,00	35,5%	42,3	0,849	13321	8,30	717
28	0,75	C	S	NO	1,00	34,3%	40,8	0,942	13863	8,57	713
30	1,1	C	S	NO	1,00	34,2%	40,5	1,026	14889	8,66	715
32	1,1	C	S	NO	1,00	33,4%	39,4	1,121	15494	8,87	712

**Erp. Características del punto de máxima eficiencia (BEP)****THT-90-4T**

α [°]	PN	MC	EC	VSD	SR	ηe [%]	N	[kW]	[m³/h]	[mmH₂O]	[RPM]
8	3	C	S	NO	1,00	51,9%	55,2	3,028	19656	29,36	1440
10	3	C	S	NO	1,00	51,1%	54,0	3,468	23364	27,87	1431
12	4	C	S	NO	1,00	50,5%	53,0	4,049	25081	29,94	1456
14	4	C	S	NO	1,00	50,8%	52,9	4,602	27678	31,02	1450
16	5,5	C	S	NO	1,00	49,1%	50,8	5,393	29635	32,80	1470
18	5,5	C	S	NO	1,00	47,7%	49,0	6,251	31521	34,72	1465
20	7,5	C	S	NO	1,00	46,8%	47,8	7,035	33277	36,37	1471
22	7,5	C	S	NO	1,01	45,2%	45,9	7,879	35009	37,36	1467
24	11	C	S	NO	1,01	44,3%	44,8	8,627	36254	38,77	1479
26	11	C	S	NO	1,01	43,6%	43,7	9,577	37545	40,84	1477
28	11	C	S	NO	1,01	41,7%	41,7	10,667	39574	41,28	1474
30	11	C	S	NO	1,01	40,0%	40,0	11,780	41490	41,74	1471
32	15	C	S	NO	1,01	39,0%	38,9	12,781	43446	42,17	1477

**THT-90-6T**

α [°]	PN	MC	EC	VSD	SR	ηe [%]	N	[kW]	[m³/h]	[mmH₂O]	[RPM]
8	1,5	C	S	NO	1,00	49,6%	56,3	0,891	12878	12,60	981
10	1,5	C	S	NO	1,00	48,9%	55,1	1,020	15307	11,96	978
12	1,5	C	S	NO	1,00	47,7%	53,5	1,205	16432	12,85	974
14	1,5	C	S	NO	1,00	48,0%	53,5	1,370	18134	13,31	970
16	1,5	C	S	NO	1,00	45,8%	50,8	1,625	19416	14,08	965
18	2,2	C	S	NO	1,00	45,3%	49,9	1,850	20652	14,90	965
20	2,2	C	S	NO	1,00	44,0%	48,3	2,106	21802	15,61	960
22	2,2	C	S	NO	1,00	42,5%	46,4	2,358	22937	16,04	955
24	2,2	C	S	NO	1,00	41,1%	44,8	2,615	23753	16,64	950
26	3	C	S	NO	1,00	41,1%	44,5	2,858	24599	17,53	976
28	3	C	S	NO	1,00	39,3%	42,4	3,183	25928	17,72	973
30	3	C	S	NO	1,00	37,7%	40,6	3,515	27183	17,92	970
32	4	C	S	NO	1,00	37,0%	39,7	3,789	28464	18,10	976

**THT-90-8T**

α [°]	PN	MC	EC	VSD	SR	ηe [%]	N	[kW]	[m³/h]	[mmH₂O]	[RPM]
8	0,75	C	S	NO	1,00	44,9%	53,5	0,429	9760	7,24	733
10	0,75	C	S	NO	1,00	44,2%	52,5	0,491	11601	6,87	731
12	0,75	C	S	NO	1,00	43,1%	51,0	0,580	12454	7,38	727
14	0,75	C	S	NO	1,00	43,4%	50,9	0,659	13744	7,65	724
16	0,75	C	S	NO	1,00	41,4%	48,4	0,782	14716	8,09	719
18	0,75	C	S	NO	1,00	40,2%	46,8	0,907	15652	8,56	714
20	1,1	C	S	NO	1,00	39,6%	45,9	1,018	16524	8,97	715
22	1,1	C	S	NO	1,00	38,2%	44,2	1,140	17384	9,21	711
24	1,1	C	S	NO	1,00	37,0%	42,7	1,264	18002	9,56	707
26	1,1	C	S	NO	1,00	36,4%	41,8	1,404	18643	10,07	702
28	1,5	C	S	NO	1,00	36,7%	41,9	1,484	19650	10,18	719
30	1,5	C	S	NO	1,00	35,2%	40,2	1,639	20602	10,29	715
32	1,5	C	S	NO	1,00	34,0%	38,7	1,795	21573	10,40	712

**THT-100-4T**

α [°]	PN	MC	EC	VSD	SR	ηe [%]	N	[kW]	[m³/h]	[mmH₂O]	[RPM]
8	4	C	S	NO	1,00	55,5%	57,8	4,250	28902	29,96	1454
10	5,5	C	S	NO	1,00	52,1%	53,9	5,240	30466	32,94	1471
12	5,5	C	S	NO	1,00	50,3%	51,6	6,210	32807	34,96	1465
14	7,5	C	S	NO	1,00	49,9%	50,9	7,100	35267	36,91	1471
16	7,5	C	S	NO	1,00	47,9%	48,5	8,268	37591	38,73	1466
18	11	C	S	NO	1,01	47,3%	47,5	9,324	39898	40,62	1477
20	11	C	S	NO	1,01	46,6%	46,6	10,492	42175	42,59	1474
22	11	C	S	NO	1,01	43,9%	43,9	12,052	44571	43,65	1470
24	15	C	S	NO	1,01	42,4%	42,2	13,415	47975	43,55	1476
26	15	C	S	NO	1,01	41,0%	40,8	14,939	49411	45,57	1473
28	15	C	S	NO	1,01	40,0%	39,8	16,186	50259	47,37	1471
30	18,5	B	T	NO	1,01	63,4%	63,1	17,435	67547	60,14	1474
32	18,5	B	T	NO	1,00	63,4%	63,0	17,976	81688	51,24	1473



## Erp. Características del punto de máxima eficiencia (BEP)

### THT-100-6T

α [°]	PN	MC	EC	VSD	SR	ηe [%]	N	[kW]	[m³/h]	[mmH₂O]	[RPM]
8	2,2	C	S	NO	1,00	53,4%	59,1	1,242	18936	12,86	976
10	2,2	C	S	NO	1,00	49,5%	54,7	1,551	19961	14,14	971
12	2,2	C	S	NO	1,00	47,8%	52,4	1,838	21494	15,01	965
14	2,2	C	S	NO	1,00	46,9%	51,2	2,125	23106	15,84	960
16	2,2	C	S	NO	1,00	45,0%	48,9	2,474	24629	16,62	953
18	3	C	S	NO	1,00	44,6%	48,1	2,782	26140	17,44	976
20	3	C	S	NO	1,00	43,9%	47,1	3,131	27632	18,28	974
22	4	C	S	NO	1,00	42,1%	45,0	3,539	29202	18,74	977
24	4	C	S	NO	1,00	40,2%	42,8	3,983	30892	19,06	974
26	4	C	S	NO	1,00	38,9%	41,2	4,429	32373	19,56	971
28	5,5	C	S	NO	1,00	38,5%	40,6	4,730	32928	20,34	977
30	5,5	B	T	NO	1,00	60,7%	62,5	5,125	44255	25,82	976
32	5,5	B	T	NO	1,00	60,6%	62,4	5,284	53520	22,00	975

### THT-100-8T

α [°]	PN	MC	EC	VSD	SR	ηe [%]	N	[kW]	[m³/h]	[mmH₂O]	[RPM]
8	1,5	C	S	NO	1,00	50,6%	58,5	0,570	14351	7,39	738
10	1,5	C	S	NO	1,00	47,0%	54,2	0,712	15128	8,12	735
12	1,5	C	S	NO	1,00	45,3%	52,1	0,844	16290	8,62	732
14	1,5	C	S	NO	1,00	44,5%	50,9	0,975	17512	9,10	729
16	1,5	C	S	NO	1,00	42,7%	48,7	1,136	18666	9,55	726
18	1,5	C	S	NO	1,00	41,6%	47,3	1,297	19811	10,02	723
20	1,5	C	S	NO	1,00	41,0%	46,3	1,460	20942	10,50	719
22	1,5	C	S	NO	1,00	38,7%	43,6	1,677	22132	10,76	715
24	1,5	C	S	NO	1,00	37,0%	41,6	1,887	23413	10,95	710
26	2,2	C	S	NO	1,00	36,7%	41,0	2,046	24535	11,24	724
28	2,2	C	S	NO	1,00	35,8%	39,9	2,217	24956	11,68	721
30	2,2	B	T	NO	1,00	56,4%	60,3	2,403	33541	14,83	719
32	2,2	B	T	NO	1,00	56,3%	60,2	2,477	40562	12,63	718

### THT-125-4T/3

α [°]	PN	MC	EC	VSD	SR	ηe [%]	N	[kW]	[m³/h]	[mmH₂O]	[RPM]
8	7,5	C	S	NO	1,00	51,3%	52,1	7,732	41511	35,13	1468
10	11	C	S	NO	1,00	52,6%	52,9	9,098	46792	37,56	1478
12	11	C	S	NO	1,00	53,7%	53,7	10,561	52185	39,90	1474
14	11	C	S	NO	1,01	55,1%	55,0	12,025	57655	42,19	1471
16	15	C	S	NO	1,01	54,9%	54,8	13,664	62205	44,33	1475
18	15	C	S	NO	1,01	54,3%	54,0	15,545	67316	46,06	1472
20	18,5	C	S	NO	1,01	54,4%	54,0	17,323	72427	47,79	1474
22	18,5	C	S	NO	1,01	52,2%	51,7	19,993	77315	49,54	1470
24	22	C	S	NO	1,01	50,6%	50,1	22,394	82218	50,63	1472
26	30	C	S	NO	1,01	51,1%	50,5	24,524	84773	54,27	1485
28	30	C	S	NO	1,01	47,9%	47,2	27,084	90252	52,81	1483
30	30	C	S	NO	1,01	46,0%	45,2	29,766	94744	53,05	1482
32	30	C	S	NO	1,01	44,1%	43,3	32,197	96187	54,28	1480
34	37	C	S	NO	1,01	41,5%	40,6	35,389	105433	51,16	1482
36	37	B	T	NO	1,01	72,5%	71,6	39,195	121252	86,13	1480
38	45	B	T	NO	1,01	72,3%	71,2	42,145	125685	89,03	1478

**Erp. Características del punto de máxima eficiencia (BEP)****THT-125-4T/6**

α [°]	PN	MC	EC	VSD	SR	ηe [%]	N	[kW]	[m³/h]	[mmH₂O]	[RPM]
8	11	C	S	NO	1,01	56,8%	56,8	12,019	48508	51,71	1471
10	15	C	S	NO	1,01	56,0%	55,8	14,423	52757	56,25	1474
12	18,5	C	S	NO	1,01	56,5%	56,2	16,578	58230	59,12	1475
14	18,5	C	S	NO	1,01	57,1%	56,7	18,813	63848	61,84	1472
16	22	C	S	NO	1,01	56,4%	55,9	21,703	68837	65,30	1473
18	30	C	S	NO	1,01	56,1%	55,5	24,370	77896	64,43	1485
20	30	C	S	NO	1,01	56,3%	55,6	27,347	80997	69,77	1483
22	30	C	S	NO	1,01	54,5%	53,7	30,990	85910	72,17	1481
24	37	C	S	NO	1,01	53,6%	52,7	34,666	88480	77,19	1483
26	37	C	S	NO	1,01	52,1%	51,1	38,796	93638	79,23	1481
28	45	C	S	NO	1,01	49,6%	48,5	44,005	102038	78,56	1477
30	55	C	S	NO	1,01	46,8%	45,7	48,644	106474	78,56	1479
32	55	C	S	NO	1,01	44,4%	43,1	53,455	110911	78,56	1477
34	55	C	S	NO	1,01	42,1%	40,8	58,161	116500	77,12	1475
36	75	B	T	NO	1,01	70,2%	68,8	64,063	136742	120,78	1488
38	75	B	T	NO	1,01	70,2%	68,8	69,029	142272	125,19	1487

**THT-125-4T/9**

α [°]	PN	MC	EC	VSD	SR	ηe [%]	N	[kW]	[m³/h]	[mmH₂O]	[RPM]
8	18,5	C	S	NO	1,01	69,3%	68,9	17,720	37304	120,90	1474
10	18,5	C	S	NO	1,01	59,8%	59,4	19,295	56423	75,15	1471
12	22	C	S	NO	1,01	57,1%	56,6	21,805	61289	74,68	1473
14	22	C	S	NO	1,01	55,7%	55,1	23,707	73859	65,67	1470
16	30	C	S	NO	1,01	53,2%	52,5	28,561	80439	69,38	1482
18	37	C	S	NO	1,01	52,2%	51,4	33,442	87528	73,29	1483
20	37	C	S	NO	1,01	51,7%	50,8	38,503	94456	77,46	1481
22	45	C	S	NO	1,01	50,6%	49,6	43,142	97688	82,16	1478
24	45	C	S	NO	1,01	50,1%	48,9	47,794	101406	86,68	1475
26	55	C	S	NO	1,01	50,6%	49,4	52,342	106241	91,67	1478
28	55	C	S	NO	1,01	49,4%	48,1	58,152	112236	93,94	1475
30	75	C	S	NO	1,01	49,3%	47,9	63,649	120361	95,67	1488
32	75	C	S	NO	1,01	48,2%	46,8	69,211	125253	97,81	1487
34	75	C	S	NO	1,01	45,7%	44,2	75,996	130939	97,53	1486
36	90	B	T	NO	1,01	72,4%	70,8	83,094	145177	152,12	1487
38	90	B	T	NO	1,02	70,2%	68,6	90,538	149120	156,66	1486

**THT-125-6T/3**

α [°]	PN	MC	EC	VSD	SR	ηe [%]	N	[kW]	[m³/h]	[mmH₂O]	[RPM]
8	3	C	S	NO	1,00	49,0%	53,1	2,278	27197	15,08	981
10	3	C	S	NO	1,00	49,6%	53,2	2,715	30657	16,12	977
12	3	C	S	NO	1,00	50,6%	53,8	3,152	34190	17,13	973
14	4	C	S	NO	1,00	52,7%	55,6	3,531	37774	18,11	977
16	4	C	S	NO	1,00	52,1%	54,6	4,051	40755	19,03	974
18	4	C	S	NO	1,00	51,5%	53,7	4,608	44104	19,77	970
20	5,5	C	S	NO	1,00	52,0%	53,9	5,092	47452	20,51	976
22	5,5	C	S	NO	1,00	49,9%	51,4	5,877	50654	21,27	972
24	7,5	C	S	NO	1,00	49,7%	50,9	6,486	53010	22,32	977
26	7,5	C	S	NO	1,00	48,9%	49,8	7,224	56526	22,97	974
28	7,5	C	S	NO	1,00	46,3%	46,9	7,973	59317	22,84	972
30	11	C	S	NO	1,00	44,7%	45,1	8,615	62074	22,77	979
32	11	C	S	NO	1,00	43,0%	43,2	9,358	64946	22,76	977
34	11	C	S	NO	1,00	40,2%	40,2	10,268	68214	22,21	975
36	11	B	T	NO	1,00	70,1%	70,1	11,398	79441	36,97	972
38	15	B	T	NO	1,00	70,1%	70,0	12,217	82345	38,21	974



## Erp. Características del punto de máxima eficiencia (BEP)

### THT-125-6T/6

α [°]	PN	MC	EC	VSD	SR	ηe [%]	N	[kW]	[m³/h]	[mmH₂O]	[RPM]
8	4	C	S	NO	1,00	54,4%	57,3	3,530	31781	22,20	977
10	4	C	S	NO	1,00	53,1%	55,5	4,276	34565	24,14	972
12	5,5	C	S	NO	1,00	54,1%	56,1	4,873	38151	25,38	977
14	5,5	C	S	NO	1,00	54,7%	56,3	5,530	41832	26,55	974
16	7,5	C	S	NO	1,00	54,6%	55,8	6,307	45100	28,03	978
18	7,5	C	S	NO	1,00	53,8%	54,8	7,137	51036	27,66	975
20	7,5	C	S	NO	1,00	54,0%	54,6	8,009	53067	29,95	972
22	11	C	S	NO	1,00	52,9%	53,2	8,969	56286	30,98	978
24	11	C	S	NO	1,00	51,5%	51,6	10,146	57719	33,26	975
26	11	C	S	NO	1,00	50,3%	50,3	11,282	61349	34,01	972
28	15	C	S	NO	1,00	48,1%	48,0	12,756	66852	33,72	973
30	15	C	S	NO	1,00	45,2%	45,0	14,156	69759	33,72	970
32	15	C	S	NO	1,00	42,9%	42,6	15,556	72666	33,72	967
34	18,5	C	S	NO	1,00	40,9%	40,6	16,829	76327	33,10	979
36	18,5	B	T	NO	1,01	67,8%	67,4	18,637	89589	51,84	977
38	18,5	B	T	NO	1,01	67,9%	67,4	20,081	93213	53,74	975

### THT-125-6T/9

α [°]	PN	MC	EC	VSD	SR	ηe [%]	N	[kW]	[m³/h]	[mmH₂O]	[RPM]
8	5,5	C	S	NO	1,01	66,3%	68,1	5,209	24441	51,89	975
10	5,5	C	S	NO	1,00	57,2%	58,8	5,672	36967	32,26	973
12	7,5	C	S	NO	1,00	55,3%	56,6	6,337	40155	32,06	978
14	7,5	C	S	NO	1,00	53,9%	54,9	6,890	48390	28,19	976
16	7,5	C	S	NO	1,00	51,1%	51,6	8,364	52702	29,78	970
18	11	C	S	NO	1,00	50,5%	50,6	9,725	57346	31,46	976
20	11	C	S	NO	1,00	50,0%	50,0	11,197	61885	33,25	973
22	15	C	S	NO	1,00	49,1%	49,0	12,506	64003	35,27	974
24	15	C	S	NO	1,00	48,9%	48,7	13,845	65542	37,94	971
26	15	C	S	NO	1,01	48,9%	48,7	15,232	69606	39,35	968
28	18,5	C	S	NO	1,01	48,0%	47,6	16,827	73534	40,32	979
30	18,5	C	S	NO	1,01	47,6%	47,2	18,516	78857	41,07	977
32	18,5	C	S	NO	1,01	46,6%	46,1	20,134	82062	41,98	975
34	22	C	S	NO	1,01	44,6%	44,1	21,901	85787	41,86	977
36	30	B	T	NO	1,01	70,8%	70,2	23,874	95116	65,30	989
38	30	B	T	NO	1,01	68,8%	68,1	26,013	97699	67,25	988

### THT-140-6T/3

α [°]	PN	MC	EC	VSD	SR	ηe [%]	N	[kW]	[m³/h]	[mmH₂O]	[RPM]
8	4	C	S	NO	1,00	44,1%	46,7	3,951	36390	17,60	975
10	5,5	C	S	NO	1,00	45,3%	47,4	4,642	41020	18,81	978
12	5,5	C	S	NO	1,00	46,2%	47,9	5,388	45747	19,99	974
14	5,5	C	S	NO	1,00	47,4%	48,8	6,135	50542	21,13	971
16	7,5	C	S	NO	1,00	47,6%	48,6	6,925	54531	22,20	975
18	7,5	C	S	NO	1,00	47,0%	47,7	7,878	59012	23,07	972
20	11	C	S	NO	1,00	47,4%	47,8	8,727	63492	23,94	979
22	11	C	S	NO	1,00	44,8%	44,8	10,080	68187	24,30	975
24	11	C	S	NO	1,00	43,9%	43,9	11,302	71105	25,65	972
26	15	C	S	NO	1,00	43,8%	43,7	12,415	74264	26,91	974
28	15	C	S	NO	1,00	41,5%	41,3	13,688	77986	26,76	971
30	15	C	S	NO	1,00	39,9%	39,7	15,028	82755	26,65	968
32	15	B	T	NO	1,00	65,8%	65,5	16,601	99158	40,47	965
34	18,5	B	T	NO	1,00	63,5%	63,1	18,158	101655	41,68	978
36	18,5	B	T	NO	1,00	62,1%	61,7	19,821	106107	42,63	976
38	22	B	T	NO	1,00	62,2%	61,7	21,201	110043	44,01	978



### Erp. Características del punto de máxima eficiencia (BEP)

#### THT-140-6T/6

α [°]	PN	MC	EC	VSD	SR	ηe [%]	N	[kW]	[m³/h]	[mmH₂O]	[RPM]
8	5,5	C	S	NO	1,00	48,9%	50,3	6,132	42524	25,90	971
10	7,5	C	S	NO	1,00	48,5%	49,4	7,310	46249	28,17	974
12	7,5	C	S	NO	1,00	48,7%	49,2	8,451	51047	29,61	970
14	11	C	S	NO	1,00	49,8%	50,0	9,478	55972	30,98	977
16	11	C	S	NO	1,00	48,9%	48,9	10,985	60345	32,71	973
18	15	C	S	NO	1,00	48,6%	48,5	12,339	68287	32,27	974
20	15	C	S	NO	1,00	48,8%	48,6	13,847	71005	34,95	971
22	15	C	S	NO	1,00	47,2%	47,0	15,691	75312	36,15	967
24	18,5	C	S	NO	1,00	45,6%	45,2	17,766	80549	36,94	978
26	18,5	C	S	NO	1,01	44,7%	44,2	19,692	84172	38,41	976
28	22	C	S	NO	1,01	43,3%	42,7	22,143	89450	39,35	977
30	30	C	S	NO	1,01	40,9%	40,3	24,432	93339	39,35	989
32	30	B	T	NO	1,01	61,6%	60,9	27,111	110368	55,55	987
34	30	B	T	NO	1,01	60,7%	59,9	29,742	114996	57,67	986
36	30	B	T	NO	1,01	60,3%	59,5	32,339	119625	59,87	985
38	37	B	T	NO	1,01	60,6%	59,7	34,669	124508	61,99	983

#### THT-140-6T/9

α [°]	PN	MC	EC	VSD	SR	ηe [%]	N	[kW]	[m³/h]	[mmH₂O]	[RPM]
8	11	C	S	NO	1,01	60,4%	60,7	8,928	32703	60,56	978
10	11	C	S	NO	1,00	52,1%	52,2	9,721	49463	37,64	976
12	11	C	S	NO	1,00	49,6%	49,6	11,037	53728	37,41	973
14	11	C	S	NO	1,00	48,3%	48,3	11,999	64747	32,90	971
16	15	C	S	NO	1,00	46,1%	45,9	14,461	70516	34,75	970
18	18,5	C	S	NO	1,00	45,3%	45,0	16,917	76730	36,71	979
20	18,5	C	S	NO	1,01	44,9%	44,5	19,477	82804	38,80	976
22	22	C	S	NO	1,01	44,2%	43,7	21,709	85637	41,15	977
24	30	C	S	NO	1,01	43,9%	43,3	23,911	88897	43,42	989
26	30	C	S	NO	1,01	44,3%	43,6	26,289	93135	45,91	988
28	30	C	S	NO	1,01	43,7%	42,9	29,250	100645	46,65	987
30	30	C	S	NO	1,01	42,7%	41,9	32,140	105521	47,79	985
32	37	B	T	NO	1,01	65,7%	64,9	34,831	119380	70,46	983
34	37	B	T	NO	1,01	64,1%	63,1	38,467	123186	73,50	981
36	45	B	T	NO	1,01	62,7%	61,6	41,676	127100	75,48	987
38	45	B	T	NO	1,01	60,8%	59,7	45,403	130545	77,70	986

#### THT-140-8T/3

α [°]	PN	MC	EC	VSD	SR	ηe [%]	N	[kW]	[m³/h]	[mmH₂O]	[RPM]
8	3	C	S	NO	1,00	42,1%	46,8	1,804	27580	10,11	730
10	3	C	S	NO	1,00	42,6%	46,8	2,149	31089	10,81	726
12	3	C	S	NO	1,00	43,4%	47,3	2,495	34672	11,48	723
14	3	C	S	NO	1,00	44,6%	48,0	2,841	38306	12,14	719
16	3	C	S	NO	1,00	44,0%	47,1	3,258	41329	12,75	714
18	4	C	S	NO	1,00	45,1%	48,0	3,576	44725	13,25	735
20	4	C	S	NO	1,00	44,9%	47,5	4,009	48120	13,75	733
22	4	C	S	NO	1,00	43,1%	45,2	4,625	51261	14,28	730
24	5,5	C	S	NO	1,00	42,4%	44,3	5,159	53756	14,96	734
26	5,5	C	S	NO	1,00	41,9%	43,5	5,712	56323	15,62	732
28	5,5	C	S	NO	1,00	39,7%	40,9	6,308	59552	15,43	730
30	7,5	C	S	NO	1,00	38,5%	39,5	6,794	62720	15,31	730
32	7,5	B	T	NO	1,00	63,4%	64,2	7,505	75151	23,24	728
34	7,5	B	T	NO	1,00	60,8%	61,4	8,256	77044	23,94	726
36	11	B	T	NO	1,00	60,2%	60,5	8,910	80418	24,49	732
38	11	B	T	NO	1,00	59,7%	59,8	9,620	83401	25,28	731



# THT CJTHT/PLUS CJTHT CJTHT/DUPLEX/ATEX



## Erp. Características del punto de máxima eficiencia (BEP)

### THT-140-8T/6

α [°]	PN	MC	EC	VSD	SR	ηe [%]	N	[kW]	[m³/h]	[mmH₂O]	[RPM]
8	3	C	S	NO	1,00	46,0%	49,4	2,839	32229	14,88	719
10	3	C	S	NO	1,00	44,9%	47,8	3,440	35052	16,18	712
12	4	C	S	NO	1,00	46,7%	49,3	3,837	38688	17,01	734
14	4	C	S	NO	1,00	47,2%	49,5	4,354	42421	17,79	731
16	5,5	C	S	NO	1,00	46,6%	48,5	5,017	45735	18,79	734
18	5,5	C	S	NO	1,00	46,0%	47,6	5,677	51754	18,54	732
20	5,5	C	S	NO	1,00	46,2%	47,4	6,370	53815	20,07	730
22	7,5	C	S	NO	1,00	45,5%	46,4	7,094	57078	20,77	729
24	7,5	C	S	NO	1,00	44,1%	44,7	8,060	58997	22,14	727
26	11	C	S	NO	1,00	43,8%	44,1	8,822	62213	22,80	732
28	11	C	S	NO	1,00	41,5%	41,6	10,048	67794	22,60	730
30	11	C	S	NO	1,00	39,0%	39,0	11,151	70741	22,60	728
32	11	B	T	NO	1,00	58,7%	58,6	12,374	83648	31,91	725
34	15	B	T	NO	1,00	59,2%	59,1	13,273	87155	33,13	734
36	15	B	T	NO	1,00	58,8%	58,6	14,432	90663	34,39	733
38	15	B	T	NO	1,00	58,8%	58,6	15,548	94364	35,61	731

### THT-140-8T/9

α [°]	PN	MC	EC	VSD	SR	ηe [%]	N	[kW]	[m³/h]	[mmH₂O]	[RPM]
8	4	C	S	NO	1,00	57,2%	59,7	4,101	24785	34,78	733
10	4	C	S	NO	1,00	49,4%	51,6	4,465	37487	21,62	731
12	5,5	C	S	NO	1,00	47,3%	49,2	5,040	40720	21,49	734
14	5,5	C	S	NO	1,00	46,1%	47,7	5,480	49072	18,90	733
16	7,5	C	S	NO	1,00	44,4%	45,6	6,538	53444	19,96	731
18	7,5	C	S	NO	1,00	43,4%	44,1	7,692	58154	21,09	728
20	11	C	S	NO	1,00	43,5%	43,9	8,755	62756	22,29	732
22	11	C	S	NO	1,00	42,4%	42,5	9,851	64904	23,64	730
24	11	C	S	NO	1,00	42,2%	42,2	10,906	66465	25,43	728
26	11	C	S	NO	1,00	42,2%	42,2	11,998	70586	26,37	726
28	15	C	S	NO	1,00	42,1%	42,0	13,034	74569	27,03	734
30	15	C	S	NO	1,00	41,8%	41,6	14,343	79968	27,53	733
32	15	B	T	NO	1,00	63,8%	63,6	15,621	90477	40,47	731
34	18,5	B	T	NO	1,00	63,4%	63,0	16,932	93362	42,22	733
36	18,5	B	T	NO	1,00	61,7%	61,3	18,430	96329	43,35	732
38	18,5	B	T	NO	1,00	59,9%	59,4	20,078	98939	44,63	730

### THT-160-6T/3

α [°]	PN	MC	EC	VSD	SR	ηe [%]	N	[kW]	[m³/h]	[mmH₂O]	[RPM]
8	7,5	C	S	NO	1,00	45,5%	46,3	7,473	54320	22,98	974
10	11	C	S	NO	1,00	46,5%	46,9	8,801	61231	24,57	978
12	11	C	S	NO	1,00	47,5%	47,6	10,216	68287	26,10	975
14	11	C	S	NO	1,00	48,7%	48,7	11,632	75445	27,60	972
16	15	C	S	NO	1,00	48,5%	48,4	13,244	81399	29,00	972
18	15	C	S	NO	1,00	48,0%	47,7	15,068	88088	30,14	968
20	18,5	C	S	NO	1,00	48,0%	47,7	16,795	94775	31,26	979
22	18,5	C	S	NO	1,00	46,1%	45,6	19,377	100960	32,47	976
24	22	C	S	NO	1,00	45,5%	45,0	21,535	105875	34,02	978
26	22	C	S	NO	1,00	45,0%	44,4	23,846	110931	35,51	975
28	30	C	S	NO	1,00	42,8%	42,1	26,180	117291	35,09	988
30	30	C	S	NO	1,01	40,8%	40,1	28,693	123530	34,81	987
32	30	B	T	NO	1,01	67,2%	66,4	31,697	148014	52,85	985
34	37	B	T	NO	1,01	64,8%	63,9	34,696	151742	54,44	983
36	37	B	T	NO	1,01	63,4%	62,4	37,874	158387	55,68	981
38	45	B	T	NO	1,01	63,2%	62,1	40,703	164263	57,49	987

**Erp. Características del punto de máxima eficiencia (BEP)****THT-160-6T/6**

α [°]	PN	MC	EC	VSD	SR	ηe [%]	N	[kW]	[m³/h]	[mmH <sub>2</sub> O]	[RPM]
8	11	C	S	NO	1,00	50,3%	50,3	11,626	63476	33,83	972
10	15	C	S	NO	1,00	49,5%	49,3	13,981	69036	36,80	971
12	15	C	S	NO	1,00	49,6%	49,3	16,165	76198	38,68	966
14	18,5	C	S	NO	1,00	50,4%	50,1	18,240	83550	40,46	978
16	22	C	S	NO	1,01	50,0%	49,5	20,941	90077	42,72	978
18	22	C	S	NO	1,01	49,4%	48,8	23,696	101933	42,15	975
20	30	C	S	NO	1,01	49,8%	49,1	26,438	105991	45,64	988
22	30	C	S	NO	1,01	48,2%	47,5	29,960	112419	47,22	986
24	37	C	S	NO	1,01	46,5%	45,6	33,947	120236	48,25	983
26	37	C	S	NO	1,01	45,1%	44,2	37,597	124823	49,92	981
28	45	C	S	NO	1,01	43,9%	42,9	42,513	133523	51,39	987
30	45	C	S	NO	1,01	41,1%	40,0	47,358	143764	49,76	985
32	55	B	T	NO	1,01	62,5%	61,3	52,024	164748	72,55	987
34	55	B	T	NO	1,01	61,7%	60,4	57,073	171656	75,33	985
36	75	B	T	NO	1,01	61,4%	60,1	61,857	178566	78,19	988
38	75	B	T	NO	1,01	61,5%	60,1	66,644	185855	80,97	987

**THT-160-6T/9**

α [°]	PN	MC	EC	VSD	SR	ηe [%]	N	[kW]	[m³/h]	[mmH <sub>2</sub> O]	[RPM]
8	18,5	C	S	NO	1,01	61,2%	60,8	17,180	48815	79,09	979
10	18,5	C	S	NO	1,01	52,8%	52,4	18,707	73833	49,16	977
12	22	C	S	NO	1,01	50,7%	50,2	21,039	80201	48,86	978
14	22	C	S	NO	1,01	49,4%	48,9	22,875	96649	42,97	976
16	30	C	S	NO	1,01	47,1%	46,4	27,612	105260	45,39	987
18	30	C	S	NO	1,01	46,0%	45,2	32,485	114536	47,95	985
20	37	C	S	NO	1,01	45,8%	44,9	37,216	123602	50,68	981
22	45	C	S	NO	1,01	44,9%	43,9	41,679	127831	53,75	987
24	45	C	S	NO	1,01	44,3%	43,2	46,182	136572	55,04	986
26	55	C	S	NO	1,01	45,0%	43,8	50,446	139024	59,97	987
28	55	C	S	NO	1,01	44,4%	43,1	56,127	150233	60,93	986
30	75	C	S	NO	1,01	43,5%	42,2	61,477	157513	62,42	988
32	75	B	T	NO	1,01	66,7%	65,3	66,956	178199	92,03	987
34	75	B	T	NO	1,01	65,0%	63,5	73,945	183881	96,00	986
36	90	B	T	NO	1,01	63,5%	61,9	80,239	189724	98,58	987
38	90	B	T	NO	1,01	61,6%	60,0	87,415	194865	101,48	986

**THT-160-8T/3**

α [°]	PN	MC	EC	VSD	SR	ηe [%]	N	[kW]	[m³/h]	[mmH <sub>2</sub> O]	[RPM]
8	3	C	S	NO	1,00	42,1%	45,0	3,517	41169	13,20	712
10	4	C	S	NO	1,00	44,1%	46,6	4,043	46407	14,12	733
12	4	C	S	NO	1,00	45,0%	47,1	4,693	51755	14,99	730
14	5,5	C	S	NO	1,00	46,5%	48,2	5,312	57179	15,86	733
16	5,5	C	S	NO	1,00	45,9%	47,3	6,093	61692	16,66	731
18	7,5	C	S	NO	1,00	46,2%	47,3	6,812	66761	17,31	730
20	7,5	C	S	NO	1,00	46,0%	46,7	7,636	71830	17,96	728
22	11	C	S	NO	1,00	44,6%	45,0	8,710	76517	18,65	733
24	11	C	S	NO	1,00	43,7%	43,8	9,772	80242	19,54	730
26	11	C	S	NO	1,00	43,0%	43,1	10,884	85565	20,11	728
28	11	C	S	NO	1,00	40,7%	40,6	12,012	89790	20,00	726
30	15	C	S	NO	1,00	39,7%	39,6	12,842	93963	19,93	735
32	15	B	T	NO	1,00	65,5%	65,4	14,145	112179	30,36	733
34	15	B	T	NO	1,00	62,9%	62,7	15,561	115004	31,27	731
36	18,5	B	T	NO	1,00	62,7%	62,4	16,671	120041	31,98	733
38	18,5	B	T	NO	1,00	62,2%	61,8	18,000	124494	33,02	732

# THT CJTHT/PLUS CJTHT CJTHT/DUPLEX/ATEX



## Erp. Características del punto de máxima eficiencia (BEP)

### THT-160-8T/6

α [°]	PN	MC	EC	VSD	SR	ηe [%]	N	[kW]	[m³/h]	[mmH₂O]	[RPM]
8	5,5	C	S	NO	1,00	47,9%	49,7	5,309	48108	19,43	733
10	5,5	C	S	NO	1,00	46,8%	48,0	6,432	52322	21,14	730
12	7,5	C	S	NO	1,00	47,8%	48,7	7,308	57750	22,22	729
14	7,5	C	S	NO	1,00	48,3%	48,8	8,293	63322	23,24	726
16	11	C	S	NO	1,00	48,0%	48,2	9,503	68269	24,54	731
18	11	C	S	NO	1,00	47,4%	47,4	10,753	77254	24,21	728
20	11	C	S	NO	1,00	47,5%	47,5	12,067	80330	26,22	726
22	15	C	S	NO	1,00	47,1%	46,9	13,370	85202	27,12	734
24	15	C	S	NO	1,00	45,2%	45,0	15,185	90276	27,95	732
26	18,5	C	S	NO	1,00	45,9%	45,6	16,421	93251	29,67	734
28	18,5	C	S	NO	1,00	43,3%	42,8	18,800	101197	29,52	731
30	22	C	S	NO	1,00	40,8%	40,3	20,795	105597	29,52	733
32	22	B	T	NO	1,00	61,4%	60,8	23,076	124862	41,67	731
34	30	B	T	NO	1,00	60,7%	60,1	25,233	130097	43,27	734
36	30	B	T	NO	1,00	60,3%	59,6	27,435	135334	44,91	733
38	30	B	T	NO	1,00	60,3%	59,6	29,559	140858	46,51	732

### THT-160-8T/9

α [°]	PN	MC	EC	VSD	SR	ηe [%]	N	[kW]	[m³/h]	[mmH₂O]	[RPM]
8	7,5	C	S	NO	1,00	58,6%	59,3	7,811	36997	45,43	727
10	7,5	C	S	NO	1,00	50,6%	51,0	8,506	55958	28,24	725
12	11	C	S	NO	1,00	48,6%	48,8	9,547	60783	28,06	731
14	11	C	S	NO	1,00	47,4%	47,5	10,380	73250	24,68	729
16	15	C	S	NO	1,00	45,9%	45,9	12,322	79776	26,07	735
18	15	C	S	NO	1,00	44,9%	44,7	14,497	86806	27,54	733
20	18,5	C	S	NO	1,00	45,3%	45,0	16,381	93677	29,11	734
22	18,5	C	S	NO	1,00	44,2%	43,8	18,431	96883	30,88	732
24	22	C	S	NO	1,00	43,8%	43,3	20,352	100570	32,57	733
26	22	C	S	NO	1,00	44,2%	43,6	22,376	105365	34,45	731
28	30	C	S	NO	1,00	43,6%	43,0	24,790	111878	35,51	735
30	30	C	S	NO	1,01	42,8%	42,1	27,267	119369	35,95	733
32	30	B	T	NO	1,01	65,4%	64,7	29,697	135056	52,86	732
34	37	B	T	NO	1,01	64,3%	63,4	32,550	139362	55,14	742
36	37	B	T	NO	1,01	62,6%	61,7	35,429	143791	56,62	741
38	37	B	T	NO	1,01	60,7%	59,7	38,598	147687	58,29	740

# THT/HATCH

**Exutorios dinámicos con apertura motorizada equipados con extractor de tejado, para evacuación de humo en caso de incendio, 400°C/2h**



Exutorios dinámicos con extractores de tejado, de apertura motorizada. Especialmente diseñados para la rápida y eficaz evacuación de humo y gases nocivos en caso de incendio. Apto para instalación en naves industriales o instalaciones comerciales. Homologación según norma EN 12101-3:2002/AC:2006, con certificación F-400

La rápida extracción del humo permite una eficaz intervención de los bomberos, una rápida evacuación de las personas evitando nuevos focos de incendio y mayores daños estructurales al edificio. Puede utilizarse también para la ventilación ambiental del edificio donde está instalado



**Exutorio:**

- Estructura de gran robustez para aguantar severos cambios climáticos
- Estructura del equipo en chapa galvanizada anticorrosiva
- Diseño para asegurar la estanqueidad a la entrada del agua
- Aislamiento térmico de 60mm para evitar pérdidas de aire caliente en invierno
- Zócalo de adaptación para la correcta y fácil instalación en el tejado
- Interruptor para mantenimiento equipado con contacto auxiliar NA/NC para controlar desconexión del equipo.

**Sistema de apertura:**

- Brazos motorizados de apertura, con mecanismo encapsulado IP-65
- Tensión de alimentación 230 V. AC 50Hz o 24V. DC
- Sistema reforzado y garantizado con más de 10.000 operaciones en carga máxima
- Carga máxima 1000 Nw
- Apertura automática mediante señal externa del sistema de control (central de incendios, detector de humos, interruptor manual...) Sistemas de control no incluidos en el suministro.
- Apertura manual para ventilación ambiental mediante interruptor

- Interruptor final de carrera para señalar la posición de la compuerta

**Ventilador:**

- Extractores serie THT, con certificación F-400 N° 0370-CPR-0305
- Envoltorio tubular en chapa de acero con tratamiento anticorrosivo en resina de poliéster
- Hélices orientables en fundición de aluminio

**Motor:**

- Motores clase H, uso continuo S1 y uso emergencia S2, con rodamientos a bolas, protección IP55
- Trifásicos 230/400V.-50Hz (hasta 4CV) y 400/690V.-50Hz (potencias superiores a 4CV.)
- Temperatura máxima del aire a transportar:
- Servicio S1 -25°C +40°C en continuo
- Servicio S2 400°C/2h

**Acabado:**

- Anticorrosivo en chapa de acero galvanizado

**Bajo demanda:**

- Equipados con ventiladores certificados F-300
- Acabado con pintura anticorrosiva en resina de poliéster

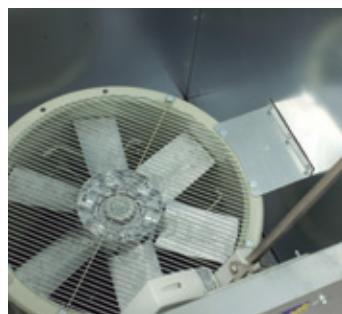

**Código de pedido**

<b>THT/HATCH</b>	<b>—</b>	<b>40</b>	<b>—</b>	<b>2T</b>	<b>—</b>	<b>1</b>	<b>—</b>	<b>N</b>	<b>—</b>	<b>1</b>	<b>—</b>	<b>G</b>
↓		↓		↓	↘	↓		↓		↓		↓
Modelo		Tamaño		Número de polos motor	T=Trifásico	Potencia motor (c.v.)		Accesorios eléctricos		Tensión de alimentación sistema de apertura		Acabado
				2=2900 r/min. 50 Hz				N= sin accesorios		1=230 V.AC		G=galvanizado
				4=1400 r/min. 50 Hz				Y= interruptor final de carrera		2=24 V.DC		P=pintado color especial
				6=900 r/min. 50 Hz								

## Características técnicas

Modelo	Velocidad (r/min)	Intensidad máxima admisible (A)			Potencia instalada (kW)	Caudal máximo (m³/h)	Nivel presión sonora dB(A)	Peso aprox. (Kg)
		230V	400V	690V				
THT/HATCH-40-2T-1	2850	3,15	1,80		0,75	6115	72	184
THT/HATCH-40-2T-1,5	2880	4,70	2,70		1,10	7050	73	188
THT/HATCH-45-2T-2	2880	5,90	3,40		1,50	9405	75	193
THT/HATCH-45-2T-3	2840	8,70	5,00		2,20	11325	77	194
THT/HATCH-50-2T-2	2880	5,90	3,40		1,50	10100	77	197
THT/HATCH-50-2T-3	2840	8,70	5,00		2,20	11925	78	199
THT/HATCH-50-2T-4	2880	11,20	6,50		3,00	13860	79	206
THT/HATCH-50-2T-5,5	2870		9,30	5,40	4,00	15900	80	222
THT/HATCH-56-2T-5,5	2870		9,50	5,50	4,00	18840	85	226
THT/HATCH-56-2T-7,5	2910		10,60	6,14	5,50	22510	86	237
THT/HATCH-56-4T-2	1440	6,20	3,60		1,50	15020	72	205
THT/HATCH-63-4T-3	1425	9,00	5,20		2,20	22460	73	262
THT/HATCH-63-4T-4	1430	11,40	6,60		3,00	24460	74	271
THT/HATCH-63-6T-1	940	4,70	2,70		0,75	16025	63	252
THT/HATCH-80-4T-3	1425	9,00	5,20		2,20	25545	79	280
THT/HATCH-80-4T-4	1430	11,40	6,60		3,00	30410	80	289
THT/HATCH-80-4T-5,5	1440		8,40	4,80	4,00	32940	81	295
THT/HATCH-80-4T-7,5	1460		12,60	7,30	5,50	39820	82	311
THT/HATCH-80-6T-1,5	945	5,50	3,20		1,10	21580	69	279
THT/HATCH-80-6T-2	945	7,40	4,30		1,50	26090	70	288
THT/HATCH-90-4T-7,5	1460		12,60	7,30	5,50	46325	88	392
THT/HATCH-90-4T-10	1460		17,70	10,20	7,50	50315	89	403
THT/HATCH-90-4T-15	1460		22,00	12,70	11,00	59610	90	456
THT/HATCH-90-6T-3	950	9,50	5,50		2,20	34055	75	365
THT/HATCH-90-6T-4	970	13,50	7,80		3,00	39055	76	391
THT/HATCH-100-4T-10	1460		17,70	10,20	7,50	57650	90	413
THT/HATCH-100-4T-15	1460		22,00	12,70	11,00	66505	91	466
THT/HATCH-100-4T-20	1460		29,00	16,70	15,00	76445	92	481
THT/HATCH-100-6T-5,5	970		11,00	6,40	4,00	47955	81	413
THT/HATCH-100-6T-7,5	970		12,40	7,20	5,50	53545	82	420

## Características técnicas del exutorio dinámico según norma EN 12101-3:2002/AC:2006

Modelo	Homologación °C	Clase aislamiento motor	Durabilidad	Temperatura ambiente mínima	Carga de viento (Pa)	Carga de nieve (Pa)
THT/HATCH	F-400	Clase H	RE 10000	T(-15)	WL 1500	SL 500



## Erp. Características del punto de máxima eficiencia (BEP)

<(°)	Ángulo inclinación palas en grados	SR	Relación específica
PN	Potencia nominal motor en kW	ηe[%]	Eficiencia
MC	Categoría de medición	N	Grado de eficiencia
EC	Categoría de eficiencia	[kW]	Potencia eléctrica
S	Estática	[m³/h]	Caudal
T	Total	[mmH²O]	Presión estática o total (Según EC)
VSD	Variador de velocidad	[RPM]	Velocidad

Modelo	<(°)	PN	MC	EC	VSD	SR	ηe[%]	N	(kW)	(m³/h)	(mmH²O)	(RPM)
THT/HATCH-40-2T-1	16	0,75	A	S	NO	1,00	41,5%	48,1	0,933	4420	32,19	2850
THT/HATCH-40-2T-1,5	20	1,1	A	S	NO	1,00	33,6%	38,9	1,445	5180	34,43	2884
THT/HATCH-45-2T-2	16	1,5	A	S	NO	1,00	35,9%	40,8	1,688	6802	32,70	2896
THT/HATCH-45-2T-3	22	2,2	A	S	NO	1,01	37,7%	41,6	2,405	8144	40,86	2854
THT/HATCH-50-2T-2	8	1,5	A	S	NO	1,00	35,9%	40,3	2,014	6731	39,48	2876
THT/HATCH-50-2T-3	12	2,2	A	S	NO	1,01	36,8%	40,5	2,586	7884	44,29	2843
THT/HATCH-50-2T-4	16	3	A	S	NO	1,01	34,3%	37,3	3,381	8962	47,55	2885
THT/HATCH-50-2T-5,5	20	4	A	S	NO	1,01	32,6%	35,1	4,131	9537	51,91	2885
THT/HATCH-56-2T-5,5	16	4	A	S	NO	1,01	45,4%	47,8	4,202	12896	54,34	2883
THT/HATCH-56-2T-7,5	22	5,5	A	S	NO	1,01	41,2%	42,6	6,055	15917	57,53	2913
THT/HATCH-56-4T-2	36	1,5	B	T	NO	1,00	45,7%	50,7	1,665	13581	20,60	1445
THT/HATCH-63-4T-3	32	2,2	B	T	NO	1,00	62,0%	65,9	2,443	20324	27,38	1430
THT/HATCH-63-4T-4	38	3	B	T	NO	1,00	57,8%	60,9	3,270	24239	28,64	1440
THT/HATCH-63-6T-1	38	0,75	B	T	NO	1,00	48,4%	54,4	1,099	15880	12,29	942
THT/HATCH-80-4T-3	12	2,2	C	S	NO	1,00	47,1%	51,0	2,413	16923	24,69	1430
THT/HATCH-80-4T-4	16	3	C	S	NO	1,00	41,1%	43,8	3,686	20444	27,19	1432
THT/HATCH-80-4T-5,5	18	4	C	S	NO	1,00	41,2%	43,5	4,246	22304	28,78	1448
THT/HATCH-80-4T-7,5	26	5,5	B	T	NO	1,00	63,0%	64,5	5,914	35186	38,92	1465
THT/HATCH-80-6T-1,5	18	1,1	C	S	NO	1,00	35,4%	40,8	1,389	14613	12,35	951
THT/HATCH-80-6T-2	26	1,5	B	T	NO	1,00	57,5%	62,1	1,825	23053	16,71	950
THT/HATCH-90-4T-7,5	18	5,5	C	S	NO	1,00	44,1%	45,2	6,749	31521	34,72	1460
THT/HATCH-90-4T-10	22	7,5	C	S	NO	1,01	38,9%	39,2	9,154	35009	37,36	1463
THT/HATCH-90-4T-15	30	11	B	T	NO	1,01	67,1%	67,1	11,526	52205	54,45	1463
THT/HATCH-90-6T-3	24	2,2	C	S	NO	1,00	38,0%	41,5	2,832	23831	16,58	950
THT/HATCH-90-6T-4	30	3	B	T	NO	1,00	58,8%	61,6	3,698	34203	23,37	971
THT/HATCH-100-4T-10	16	7,5	C	S	NO	1,00	41,3%	41,4	9,606	37591	38,73	1461
THT/HATCH-100-4T-15	22	11	C	S	NO	1,01	43,6%	43,5	12,145	44571	43,65	1461
THT/HATCH-100-4T-20	28	15	B	T	NO	1,01	64,1%	63,8	16,091	66559	56,95	1462
THT/HATCH-100-6T-5,5	26	4	B	T	NO	1,00	57,6%	59,7	4,671	42042	23,50	973
THT/HATCH-100-6T-7,5	32	5,5	B	T	NO	1,00	56,3%	57,9	5,690	53520	22,00	975

## Características acústicas

Los valores indicados se determinan mediante medidas de potencia sonora en dB(A) obtenidas en campo libre a una distancia equivalente a dos veces la envergadura del ventilador más el diámetro de la hélice, con un mínimo de 1,5 mts.

Espectro de potencia sonora Lw(A) en dB(A) por banda de frecuencia en Hz.

Modelo	63	125	250	500	1000	2000	4000	8000	Modelo	63	125	250	500	1000	2000	4000	8000
40-2-1	44	65	72	77	80	76	69	58	80-4-4	54	74	82	87	89	86	79	71
40-2-1,5	45	66	73	78	81	77	70	59	80-4-5,5	54	74	82	87	89	86	79	72
45-2-2	47	68	75	80	83	79	72	61	80-4-7,5	55	75	83	88	90	87	80	73
45-2-3	49	70	77	82	85	81	74	63	80-6-1,5	47	64	72	77	79	76	69	58
50-2-2	52	72	80	85	87	84	77	66	80-6-2	48	65	73	78	80	77	70	59
50-2-3	53	73	81	86	88	85	78	67	90-4-7,5	57	78	85	90	93	89	82	71
50-2-4	54	74	82	87	89	86	79	68	90-4-10	56	77	84	89	92	88	81	70
50-2-5,5	55	75	83	88	90	87	80	69	90-4-15	58	79	86	91	94	90	83	72
56-2-5,5	60	80	88	93	95	92	85	74	90-6-3	54	68	75	80	83	79	72	61
56-2-7,5	61	81	89	94	96	93	86	75	90-6-4	55	70	77	82	85	81	74	63
56-4-2	47	67	75	80	82	79	72	61	100-4-10	60	80	88	93	95	92	85	74
63-4-3	50	68	76	81	83	80	75	64	100-4-15	59	79	87	92	94	91	84	73
63-4-4	51	69	77	82	84	81	76	65	100-4-20	61	81	89	94	96	93	86	75
63-6-1	41	60	68	73	75	72	65	55	100-6-5,5	62	71	79	84	86	83	76	65
80-4-3	56	75	83	89	90	87	81	70	100-6-7,5	63	72	80	85	87	84	77	66

## Dimensiones mm

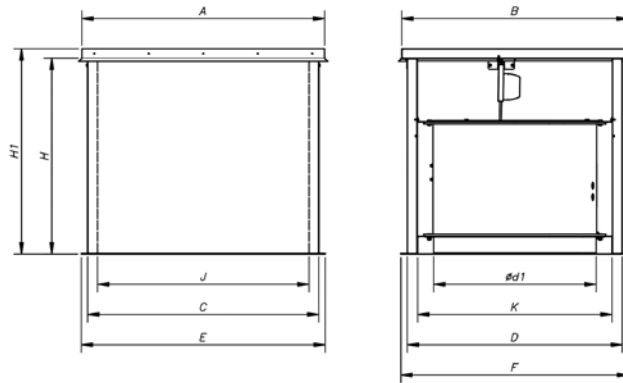

	A	B	C	D	ød1	E	F	H	H1	J	K
THT/HATCH-40-2T-1	1100	990	1022	920	400	1100	1000	940	1000	900	800
THT/HATCH-40-2T-1'5	1100	990	1022	920	400	1100	1000	940	1000	900	800
THT/HATCH-45-2T-2	1100	990	1022	920	450	1100	1000	940	1000	900	800
THT/HATCH-45-2T-3	1100	990	1022	920	450	1100	1000	940	1000	900	800
THT/HATCH-50-2T-4	1100	990	1022	920	500	1100	1000	940	1000	900	800
THT/HATCH-50-2T-5'5	1100	990	1022	920	500	1100	1000	940	1000	900	800
THT/HATCH-56-2T-5'5	1100	990	1022	920	560	1100	1000	940	1000	900	800
THT/HATCH-56-2T-7'5	1100	990	1022	920	560	1100	1000	940	1000	900	800
THT/HATCH-56-4T-2	1100	990	1022	920	560	1100	1000	940	1000	900	800
THT/HATCH-63-4T-3	1295	1195	1222	1122	630	1300	1200	940	1000	1100	1000
THT/HATCH-63-4T-4	1295	1195	1222	1122	630	1300	1200	940	1000	1100	1000
THT/HATCH-63-6T-1	1295	1195	1222	1122	630	1300	1200	940	1000	1100	1000
THT/HATCH-80-4T-3	1295	1195	1222	1122	800	1300	1200	940	1000	1100	1000
THT/HATCH-80-4T-4	1295	1195	1222	1122	800	1300	1200	940	1000	1100	1000

	A	B	C	D	ød1	E	F	H	H1	J	K
THT/HATCH-80-4T-5'5	1295	1195	1222	1122	800	1300	1200	940	1000	1100	1000
THT/HATCH-80-4T-7'5	1295	1195	1222	1122	800	1300	1200	940	1000	1100	1000
THT/HATCH-80-6T-1'5	1295	1195	1222	1122	800	1300	1200	940	1000	1100	1000
THT/HATCH-80-6T-2	1295	1195	1222	1122	800	1300	1200	940	1000	1100	1000
THT/HATCH-90-4T-7'5	1492	1392	1420	1320	900	1500	1400	940	1000	1300	1200
THT/HATCH-90-4T-10	1492	1392	1420	1320	900	1500	1400	940	1000	1300	1200
THT/HATCH-90-4T-15	1492	1392	1420	1320	900	1500	1400	940	1000	1300	1200
THT/HATCH-90-6T-3	1492	1392	1420	1320	900	1500	1400	940	1000	1300	1200
THT/HATCH-90-6T-4	1492	1392	1420	1320	900	1500	1400	940	1000	1300	1200
THT/HATCH-100-4T-10	1492	1392	1420	1320	1000	1500	1400	940	1000	1300	1200
THT/HATCH-100-4T-15	1492	1392	1420	1320	1000	1500	1400	940	1000	1300	1200
THT/HATCH-100-4T-20	1492	1392	1420	1320	1000	1500	1400	940	1000	1300	1200
THT/HATCH-100-6T-5'5	1492	1392	1420	1320	1000	1500	1400	940	1000	1300	1200
THT/HATCH-100-6T-7'5	1492	1392	1420	1320	1000	1500	1400	940	1000	1300	1200

## Esquema instalación

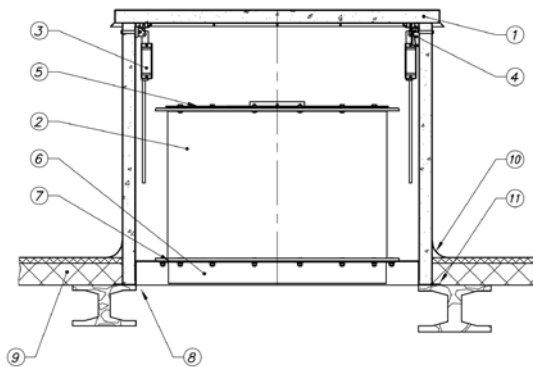

1. Exutorio THT/HATCH
2. Ventilador THT
3. Brazos motorizados (230V AC o 24V DC x2)
4. Final de carrera
5. Rejilla de protección impulsión
6. Brida de conexión conducto aspiración
7. Rejilla de protección aspiración (opcional)
8. Abertura tejado
9. Cubierta
10. Protección contra la filtración de agua
11. Montaje directo usando el zócalo de adaptación

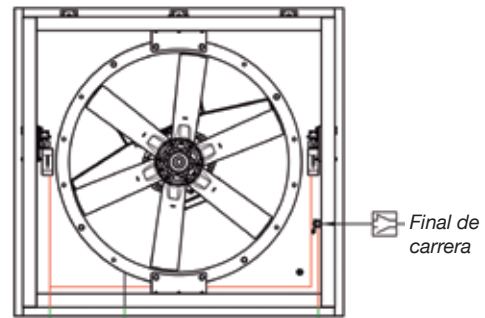

Alimentación actuador 1x230V 50Hz o 24 VDC  
 Alimentación motor 3x400V 50Hz  
 Conexión final de carrera

— Pre-instalación suministrada por el fabricante  
 - - - A realizar por el instalador

Nota: Para motores superiores a 5,5kW es aconsejable utilizar arrancador electrónico

## Curvas características

Q= Caudal en m<sup>3</sup>/h, m<sup>3</sup>/s y cfm.

Pe= Presión estática en Pa e inwg.

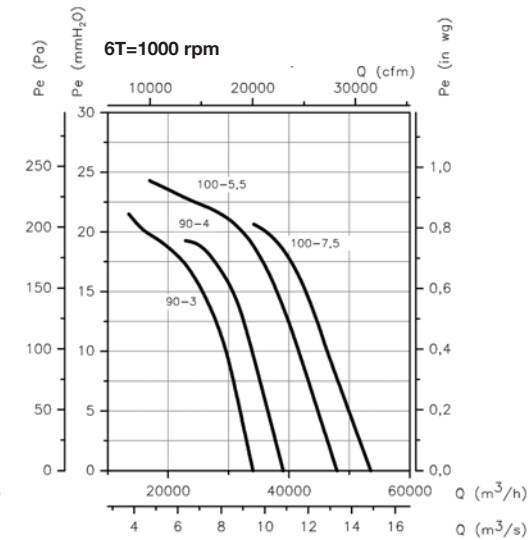
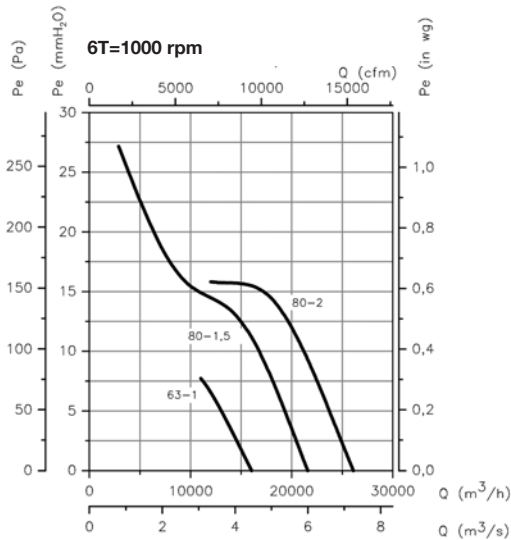
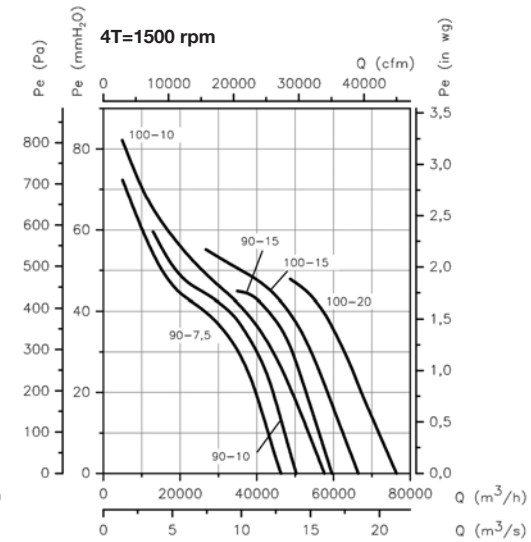
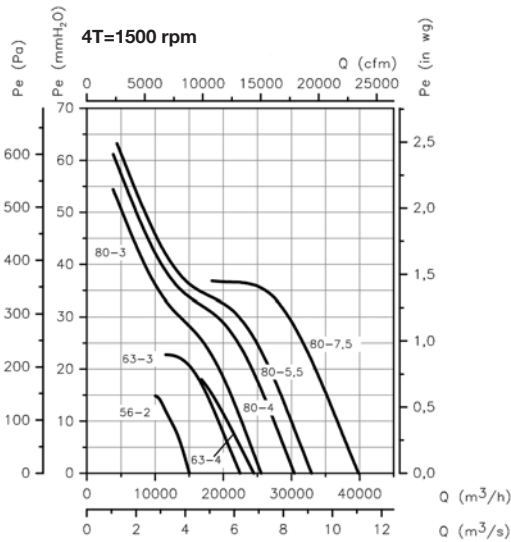
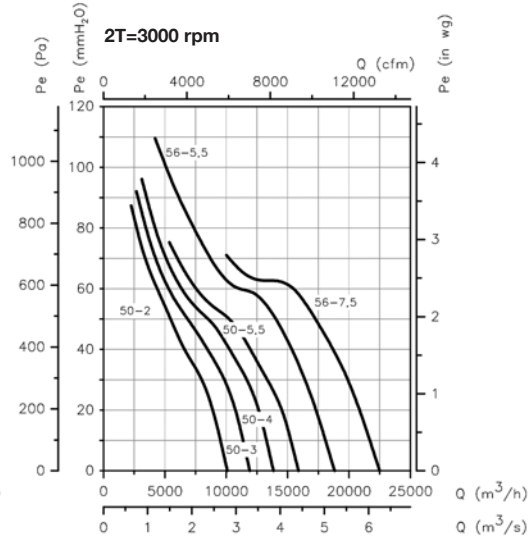
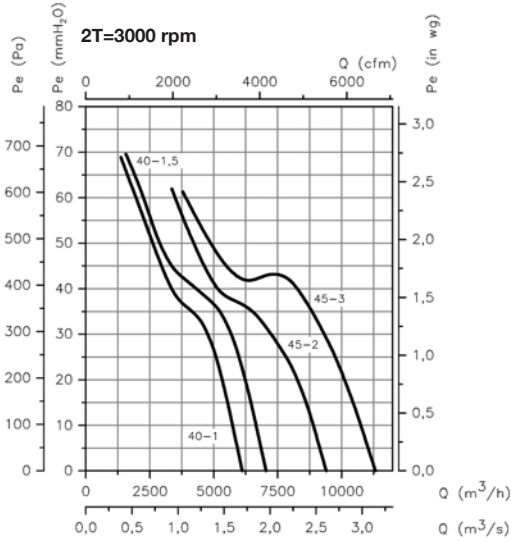



# THT/IMP

## Jet fans de gran alcance 400°C/2h, 300°C/2h y 200°C/2h, unidireccionales o reversibles

Jet fans de gran alcance 200°C/2h, 300°C/2h y 400°C/2h unidireccionales o reversibles con diseño circular (THT/IMP-C), octogonal (THT/IMP-L) o octogonal pintada (THT/IMP-O)



THT/IMP-C



THT/IMP-O

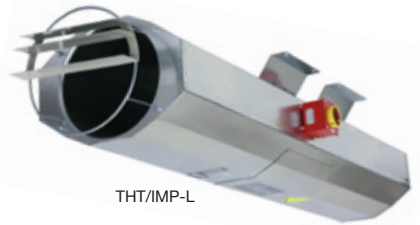

THT/IMP-L

### Ventilador:

- Conjunto de ventilador unidireccional o reversible compuesto de ventilador, silenciadores, deflectores y soportes, homologados para evacuación de humos, según norma EN 12101-3:2002/AC:2006, con certificación N°: 0370-CPR-0394
- Hélices orientables en fundición de aluminio, diseñadas para obtener grandes empujes
- Rejilla de protección contra contactos según norma UNE-EN ISO 12499, en los modelos unidireccionales
- Deflector para aumento de alcance del aire, en el lado de impulsión. Los modelos reversibles van equipados con deflectores en ambos lados.
- Silenciadores de alta atenuación con aislamiento térmico y acústico
- Interruptor de seguridad, serie IAT incorporado en el ventilador (THT/IMP-L Y THT/IMP-O) o bajo demanda (THT/IMP-C)
- Dirección aire motor-hélice o reversible 100%
- THT/IMP-C: Envoltorio circular en chapa de acero
- THT/IMP-L: Envoltorio en chapa de acero galvanizada
- THT/IMP-O: Envoltorio en chapa pintada
- THT/IMP-LS: Envoltorio de longitud reducida

### Motor:

- Motores clase H, uso continuo S1 y uso emergencia S2, con rodamientos a bolas, protección IP55, de 2 velocidades
- Trifásicos 400V.-50Hz. DHALANDER
- Temperatura máxima del aire a transportar: Servicio S1 -20°C+ 40°C en continuo, Servicio S2 200°C/2h, 300°C/2h, 400°C/2h

### Acabado:

- Anticorrosivo en resina de poliéster polimerizada a 190 °C, previo desengrase con tratamiento nanotecnológico libre de fosfatos (THT/IMP-C, THT/IMP-O) o anticorrosivo en chapa de acero galvanizado (THT/IMP-L)

### Bajo demanda:

- Prestaciones de empuje distintas a las indicadas



Deflector para aumento de alcance

### Código de pedido

**THT/IMP O — UNI — 38 — 2/4T — 1,5 — F-400**

THT/IMP: Jet fans de gran alcance

Diseño C: Envoltorio circular  
O: Envoltorio pintado  
L: Envoltorio chapa galvanizada  
LS: Envoltorio reducida

Dirección del aire UNI: Unidireccional  
REV: Reversible

Diámetro hélice en cm.

Número de polos motor  
2=2900 r/min. 50 Hz  
4=1400 r/min. 50 Hz  
6=900 r/min. 50 Hz  
8=750 r/min. 50 Hz  
12=500 r/min. 50 Hz

T=Trifásico

Potencia motor (c.v)

F-200: Homologación 200°C/2h  
F-300: Homologación. Probado para 300°C/2h.  
F-400: Homologación 400°C/2h

### Características técnicas

Modelo	Velocidad (r/min)	Intensidad máxima 400V (A)	Caudal (m³/h)	Empuje (N)	Velocidad impulsión (m/s)	Potencia instalada (kW)	Presión sonora LpA a 10m dB(A)	Peso aprox. (Kg)
<b>Unidireccional</b>								
THT/IMP-C-UNI-31-2/4T	2860 / 1430	1,50 / 0,55	4260 / 2130	21/ 5	15,6 / 7,8	0,55 / 0,15	51 / 36	65
THT/IMP-C-UNI-35-2/4T	2875 / 1430	2,10 / 0,80	6360 / 3180	36/ 9	17,8 / 8,9	0,85 / 0,20	52 / 37	70
THT/IMP-C-UNI-38-2/4T-1,5	2900 / 1450	2,90 / 1,10	8450 / 4225	57/ 15	20,7 / 10,3	1,10 / 0,25	47 / 32	89
THT/IMP-C-UNI-40-2/4T-1,5	2900 / 1450	2,90 / 1,10	9250 / 4625	60/ 15	20,4 / 10,2	1,10 / 0,25	53 / 38	98
THT/IMP-C-UNI-45-2/4T-2	2940 / 1460	4,40 / 1,40	10800 / 5400	62/ 15	18,1 / 9,0	1,50 / 0,37	57 / 42	132
THT/IMP-C-UNI-45-2/4T-3	2930 / 1450	5,70 / 1,80	13200 / 6600	92/ 23	22,1 / 11,0	2,20 / 0,60	58 / 43	133
THT/IMP-C-UNI-50-2/4T-6	2930 / 1450	10,00 / 3,20	19700 / 9850	165/ 41	26,4 / 13,2	4,50 / 1,30	60 / 45	220
THT/IMP-O-UNI-29-2/4T	2860 / 1430	1,50 / 0,55	4000 / 2000	21/ 5	16,8 / 8,4	0,55 / 0,15	37 / 22	69
THT/IMP-O-UNI-35-2/4T	2875 / 1430	2,10 / 0,80	6360 / 3180	36/ 9	17,8 / 8,9	0,85 / 0,20	52 / 37	70
THT/IMP-O-UNI-38-2/4T-1,5	2900 / 1450	2,90 / 1,10	8450 / 4225	57/ 15	20,7 / 10,3	1,10 / 0,25	47 / 32	94
THT/IMP-O-UNI-40-2/4T-1,5	2900 / 1450	2,90 / 1,10	9250 / 4625	60/ 15	20,4 / 10,2	1,10 / 0,25	53 / 38	104
THT/IMP-O-UNI-45-2/4T-2	2940 / 1460	4,40 / 1,40	10800 / 5400	62/ 15	18,1 / 9,0	1,50 / 0,37	57 / 42	140
THT/IMP-O-UNI-45-2/4T-3	2930 / 1450	5,70 / 1,80	13200 / 6600	92/ 23	22,1 / 11,0	2,20 / 0,60	58 / 43	141
THT/IMP-O-UNI-50-2/4T-6	2930 / 1450	10,00 / 3,20	19700 / 9850	165/ 41	26,4 / 13,2	4,50 / 1,30	60 / 45	234
THT/IMP-L-UNI-29-2/4T	2860 / 1430	1,50 / 0,55	4000 / 2000	21/ 5	16,8 / 8,4	0,55 / 0,15	37 / 22	69
THT/IMP-L-UNI-35-2/4T	2875 / 1430	2,10 / 0,80	6360 / 3180	36/ 9	17,8 / 8,9	0,85 / 0,20	52 / 37	70
THT/IMP-L-UNI-38-2/4T-1,5	2900 / 1450	2,90 / 1,10	8450 / 4225	57/ 15	20,7 / 10,3	1,10 / 0,25	47 / 32	94
THT/IMP-L-UNI-40-2/4T-1,5	2900 / 1450	2,90 / 1,10	9250 / 4625	60/ 15	20,4 / 10,2	1,10 / 0,25	53 / 38	104
THT/IMP-L-UNI-45-2/4T-2	2940 / 1460	4,40 / 1,40	10800 / 5400	62/ 15	18,1 / 9,0	1,50 / 0,37	57 / 42	140
THT/IMP-L-UNI-45-2/4T-3	2930 / 1450	5,70 / 1,80	13200 / 6600	92/ 23	22,1 / 11,0	2,20 / 0,60	58 / 43	141
THT/IMP-L-UNI-50-2/4T-6	2930 / 1450	10,00 / 3,20	19700 / 9850	165/ 41	26,4 / 13,2	4,50 / 1,30	60 / 45	234
THT/IMP-LS-UNI-29-2/4T	2860 / 1430	1,50 / 0,55	4000 / 2000	21/ 5	16,8 / 8,4	0,55 / 0,15	39 / 24	55
THT/IMP-LS-UNI-35-2/4T	2875 / 1430	2,10 / 0,80	6360 / 3180	36/ 9	17,8 / 8,9	0,85 / 0,20	54 / 39	56
THT/IMP-LS-UNI-38-2/4T-1,5	2900 / 1450	2,90 / 1,10	8450 / 4225	57/ 15	20,7 / 10,3	1,10 / 0,25	49 / 34	76
THT/IMP-LS-UNI-40-2/4T-1,5	2900 / 1450	2,90 / 1,10	9250 / 4625	60/ 15	20,4 / 10,2	1,10 / 0,25	55 / 40	83
THT/IMP-LS-UNI-45-2/4T-2	2940 / 1460	4,40 / 1,40	10800 / 5400	62/ 15	18,1 / 9,0	1,50 / 0,37	59 / 44	112
THT/IMP-LS-UNI-45-2/4T-3	2930 / 1450	5,70 / 1,80	13200 / 6600	92/ 23	22,1 / 11,0	2,20 / 0,60	60 / 45	113
THT/IMP-LS-UNI-50-2/4T-6	2930 / 1450	10,00 / 3,20	19700 / 9850	165/ 41	26,4 / 13,2	4,50 / 1,30	62 / 47	187
<b>Reversible</b>								
THT/IMP-C-REV-31-2/4T	2860 / 1430	1,50 / 0,55	3840 / 1920	17/ 4	14,1 / 7,0	0,55 / 0,15	50 / 35	63
THT/IMP-C-REV-35-2/4T	2875 / 1430	2,10 / 0,80	5940 / 2970	31/ 8	16,7 / 8,3	0,85 / 0,20	51 / 36	70
THT/IMP-C-REV-38-2/4T-2	2940 / 1460	4,40 / 1,40	8200 / 4100	54/ 14	20,1 / 10,0	1,50 / 0,37	49 / 34	91
THT/IMP-C-REV-40-2/4T-2	2940 / 1460	4,40 / 1,40	9250 / 4625	60/ 15	20,4 / 10,2	1,50 / 0,37	52 / 37	100
THT/IMP-C-REV-45-2/4T-2	2940 / 1460	4,40 / 1,40	10300 / 5150	56/ 14	17,2 / 8,6	1,50 / 0,37	56 / 41	131
THT/IMP-C-REV-45-2/4T-3	2930 / 1450	5,70 / 1,80	12800 / 6400	87/ 22	21,4 / 10,7	2,20 / 0,60	57 / 42	133
THT/IMP-C-REV-50-2/4T-6	2930 / 1450	10,00 / 3,20	19000 / 9500	153/ 38	25,4 / 12,7	4,50 / 1,30	60 / 45	267
THT/IMP-O-REV-29-2/4T	2860 / 1430	1,50 / 0,55	3400 / 1700	15/ 4	14,3 / 7,1	0,55 / 0,15	38 / 23	67
THT/IMP-O-REV-35-2/4T	2875 / 1430	2,10 / 0,80	5940 / 2970	31/ 8	16,7 / 8,3	0,85 / 0,20	51 / 36	70
THT/IMP-O-REV-38-2/4T-2	2940 / 1460	4,40 / 1,40	8200 / 4100	54/ 14	20,1 / 10,0	1,50 / 0,37	49 / 34	97
THT/IMP-O-REV-40-2/4T-2	2940 / 1460	4,40 / 1,40	9250 / 4625	60/ 15	20,4 / 10,2	1,50 / 0,37	52 / 37	106
THT/IMP-O-REV-45-2/4T-2	2940 / 1460	4,40 / 1,40	10300 / 5150	56/ 14	17,2 / 8,6	1,50 / 0,37	56 / 41	139
THT/IMP-O-REV-45-2/4T-3	2930 / 1450	5,70 / 1,80	12800 / 6400	87/ 22	21,4 / 10,7	2,20 / 0,60	57 / 42	141
THT/IMP-O-REV-50-2/4T-6	2930 / 1450	10,00 / 3,20	19000 / 9500	153/ 38	25,4 / 12,7	4,50 / 1,30	60 / 45	284
THT/IMP-L-REV-29-2/4T	2860 / 1430	1,50 / 0,55	3400 / 1700	15/ 4	14,3 / 7,1	0,55 / 0,15	38 / 23	67
THT/IMP-L-REV-35-2/4T	2875 / 1430	2,10 / 0,80	5940 / 2970	31/ 8	16,7 / 8,3	0,85 / 0,20	51 / 36	70
THT/IMP-L-REV-38-2/4T-2	2940 / 1460	4,40 / 1,40	8200 / 4100	54/ 14	20,1 / 10,0	1,50 / 0,37	49 / 34	97
THT/IMP-L-REV-40-2/4T-2	2940 / 1460	4,40 / 1,40	9250 / 4625	60/ 15	20,4 / 10,2	1,50 / 0,37	52 / 37	106
THT/IMP-L-REV-45-2/4T-2	2940 / 1460	4,40 / 1,40	10300 / 5150	56/ 14	17,2 / 8,6	1,50 / 0,37	56 / 41	139
THT/IMP-L-REV-45-2/4T-3	2930 / 1450	5,70 / 1,80	12800 / 6400	87/ 22	21,4 / 10,7	2,20 / 0,60	57 / 42	141
THT/IMP-L-REV-50-2/4T-6	2930 / 1450	10,00 / 3,20	19000 / 9500	153/ 38	25,4 / 12,7	4,50 / 1,30	60 / 45	284
THT/IMP-LS-REV-29-2/4T	2860 / 1430	1,50 / 0,55	3400 / 1700	15/ 4	14,3 / 7,1	0,55 / 0,15	40 / 25	55
THT/IMP-LS-REV-35-2/4T	2875 / 1430	2,10 / 0,80	5940 / 2970	31/ 8	16,7 / 8,3	0,85 / 0,20	53 / 38	56
THT/IMP-LS-REV-38-2/4T-2	2940 / 1460	4,40 / 1,40	8200 / 4100	54/ 14	20,1 / 10,0	1,50 / 0,37	51 / 36	77
THT/IMP-LS-REV-40-2/4T-2	2940 / 1460	4,40 / 1,40	9250 / 4625	60/ 15	20,4 / 10,2	1,50 / 0,37	53 / 39	85
THT/IMP-LS-REV-45-2/4T-2	2940 / 1460	4,40 / 1,40	10300 / 5150	56/ 14	17,2 / 8,6	1,50 / 0,37	58 / 43	111
THT/IMP-LS-REV-45-2/4T-3	2930 / 1450	5,70 / 1,80	12800 / 6400	87/ 22	21,4 / 10,7	2,20 / 0,60	59 / 44	113
THT/IMP-LS-REV-50-2/4T-6	2930 / 1450	10,00 / 3,20	19000 / 9500	153/ 38	25,4 / 12,7	4,50 / 1,30	62 / 47	227

Dimensiones mm

C: Envolverte circular

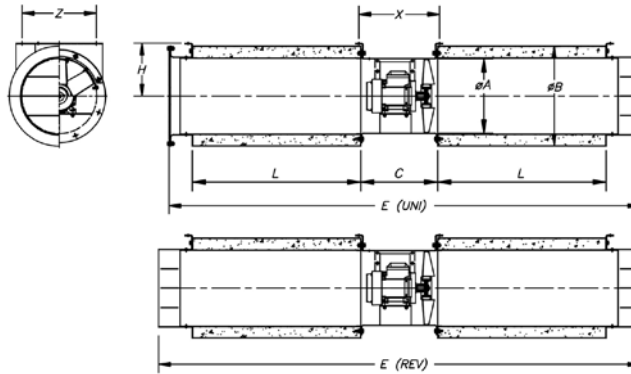

Modelo	$\varnothing A$	$\varnothing B$	C	L	$\varnothing d$	E (UNI)	E (REV)	H	X	Z
THT/IMP-C-31	315	415	320	700	10	1956	2000	220	345	275
THT/IMP-C-35	355	460	325	700	12	1960	2005	250	346	300
THT/IMP-C-38	380	415	340	1000	12	2570	2620	225	530	517
THT/IMP-C-40	410	510	340	950	12	2485	2540	280	376	340
THT/IMP-C-45	460	630	360	950	12	2500	2554	355	396	440

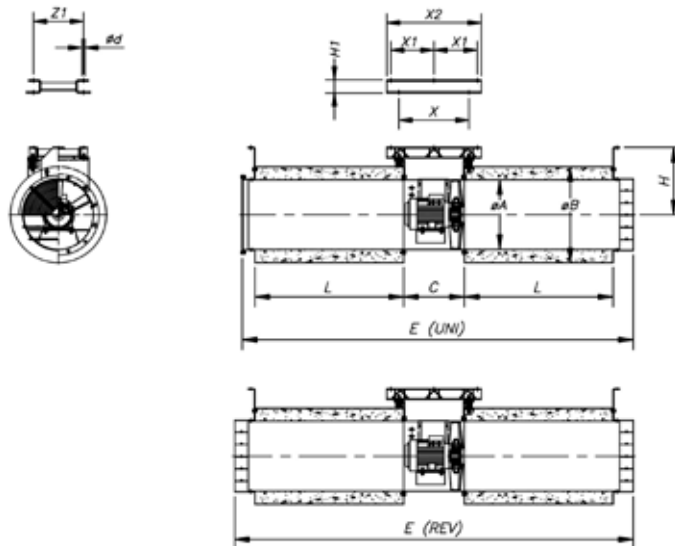

Modelo	$\varnothing A$	$\varnothing B$	C	L	$\varnothing d$	E(UNI)	E(REV)	H	H1-	X	X1	X2	Z	Z1
THT/IMP-C-50	514	710	450	1100	12	2895	2950	498	80	518	320	700	380	370

O: Envoltorio pintada  
 L: Envoltorio chapa galvanizada  
 LS: Envoltorio reducida

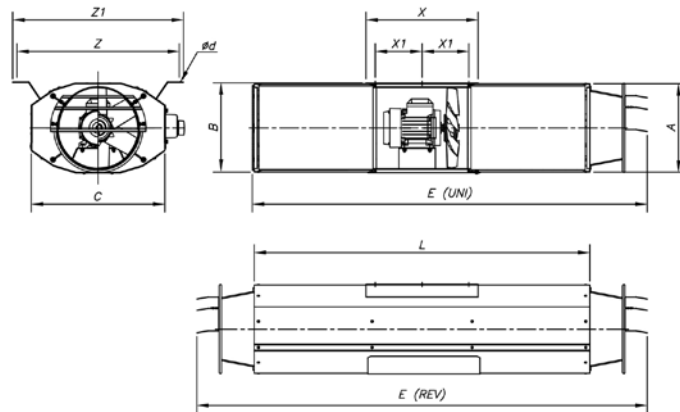

	A	B	C	ød	E (UNI)	E (REV)	L	X	X1	Z	Z1
THT/IMP-LS-29	319,5	324	479	12x26	1410	1610	1200	400	167	580	610
THT/IMP-L-29	319,5	324	479	12x26	2210	2410	2000	400	167	580	610
THT/IMP-O-29	319,5	324	479	12x26	2210	2410	2000	400	167	580	610
THT/IMP-LS-35	383	386	523	12x26	1410	1610	1200	400	167	614	644
THT/IMP-L-35	383	386	523	12x26	2210	2410	2000	400	167	614	644
THT/IMP-O-35	383	386	523	12x26	2210	2410	2000	400	167	614	644
THT/IMP-LS-38	406	409	550	12x26	1410	1610	1200	400	170	640	670
THT/IMP-L-38	406	409	550	12x26	2210	2410	2000	400	170	640	670
THT/IMP-O-38	406	409	550	12x26	2210	2410	2000	400	170	640	670
THT/IMP-LS-40	436	439	582	12x26	1410	1610	1200	400	170	670	700
THT/IMP-L-40	436	439	582	12x26	2210	2410	2000	400	170	670	700
THT/IMP-O-40	436	439	582	12x26	2210	2410	2000	400	170	670	700
THT/IMP-LS-45	486	489	630	12x26	1410	1610	1200	400	170	724	754
THT/IMP-L-45	486	489	630	12x26	2210	2410	2000	400	170	724	754
THT/IMP-O-45	486	489	630	12x26	2210	2410	2000	400	170	724	754
THT/IMP-LS-50	546	549	742	12x26	1445	1675	1200	580	255	778	808
THT/IMP-L-50	546	549	742	12x26	2245	2475	2000	580	255	778	808
THT/IMP-O-50	546	549	742	12x26	2245	2475	2000	580	255	778	808

## Aplicación en garajes

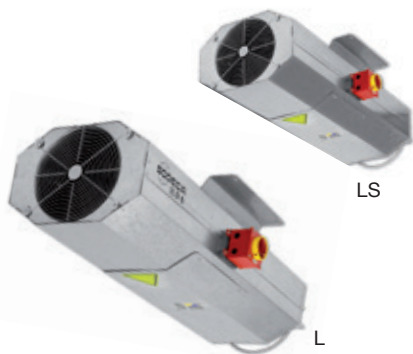

Instalación del Jet Fan en la zona de riesgo de incendio



## Accesorios

Ver apartado accesorios



# TÚNEL JET FAN



**Jet fans especialmente diseñados para ventilación de túneles. Certificados 400°C/2h, 300°C/2h y 200°C/2h según modelo**

Jet fans de impulso de gran alcance, diseñados especialmente para la ventilación de túneles y para la evacuación de humo en caso de incendios 400°C/2h, 300°C/2h y 200°C/2h según modelo.

Jet fan unidireccional, gran robustez y construcción de la hélice en fundición de aluminio para empujes medios. Certificados 400°C/2h, 300°C/2h y 200°C/2h



#### Ventilador:

- Envoltorio tubular en chapa de acero de gran espesor
- Soporte de motor soldado al envoltorio.
- Entrada aerodinámica y cono de descarga.
- Óptima protección superficial mediante acero de alta calidad.
- Hélice unidireccional, construida en fundición de aluminio
- Silenciador tubular acoplado a ambos extremos que proporciona un alto aislamiento térmico y acústico.
- Base soporte especialmente diseñada para la sustentación de todo el conjunto. A partir del diámetro 560mm incorpora muelles antivibratorios
- Conexión eléctrica en caja de bornes externa.
- Cable tipo E90 con protección metálica.
- Pies soporte o bancada soporte según modelo, incluidos en el conjunto
- Amortiguadores de vibraciones
- Anclaje de seguridad incluido
- Homologación según norma: EN 12101-3:2002/AC:2006 con certificación N° 0370-CPR-0305.



Hélice de alto rendimiento

#### Motor:

- Motores clase H, uso continuo S1 y uso emergencia S2 con rodamientos a bolas, protección IP-55
- Trifásicos 400/690V.-50Hz.
- Temperatura máxima del aire a transportar:
- Servicio S1 -20°C +70°C en continuo
- Servicio S2 400°C/2h, 300°C/2h y 200°C/2h

#### Bajo demanda:

- Motores normalizados IP-55, motores ATEX y de 2 Velocidades
- Construcción total en acero inoxidable
- Construcción en acero galvanizado en caliente

#### Acabado:

- Acero de alta protección anticorrosivo, imprimación especial y pintura de alta calidad para ambientes corrosivos.



Directrices para ganancia de presión



## Código de pedido

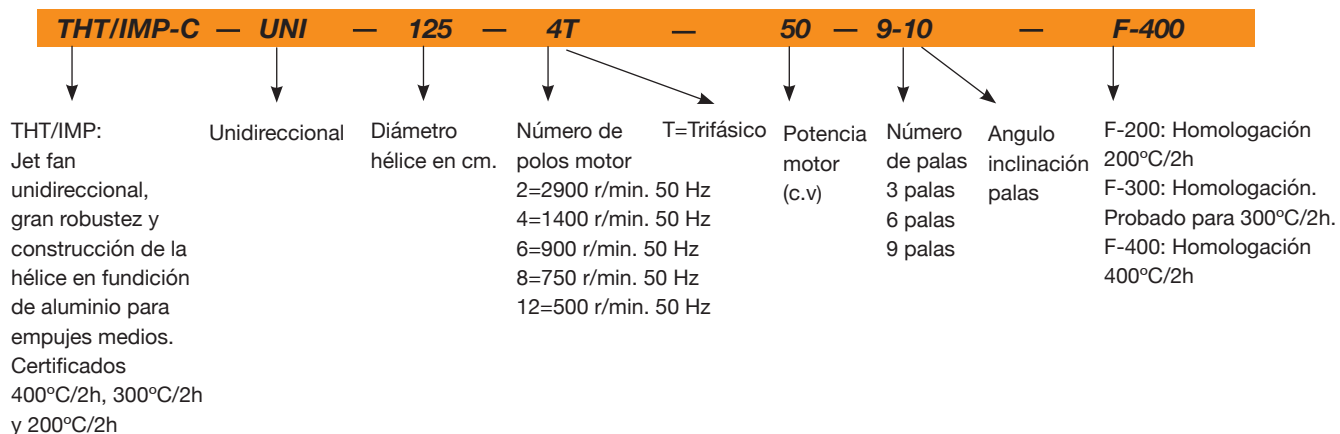

## Características técnicas

Modelo	Velocidad (r/min)	Intensidad máxima admisible a 400V (A)	Caudal (m³/h)	Empuje (N)	Velocidad impulsión (m/s)	Potencia instalada (kW)	Presión sonora LpA a 10m dB(A)	Peso aprox. (Kg)
THT/IMP-C-UNI-56-2T-12	2950	19,20	29500	312	37,6	9,00	64	273
THT/IMP-C-UNI-56-4T-2	1425	3,80	14550	76	16,4	1,50	50	197
THT/IMP-C-UNI-63-2T-22	2960	32,30	40050	455	37,1	16,00	68	323
THT/IMP-C-UNI-63-4T-3	1435	5,30	21550	132	19,2	2,20	53	241
THT/IMP-C-UNI-71-4T-4	1430	6,60	28550	182	20,0	3,00	65	279
THT/IMP-C-UNI-80-4T-5,5	1440	8,40	36900	239	20,4	4,00	63	414
THT/IMP-C-UNI-90-4T-10	1460	17,70	52000	375	22,7	7,50	65	495
THT/IMP-C-UNI-100-4T-15	1455	23,00	66500	497	23,5	11,00	63	667
THT/IMP-C-UNI-125-4T-30	1470	42,00	98100	692	22,2	22,00	59	980
THT/IMP-C-UNI-125-4T-50	1480	73,00	123700	1101	28,0	37,00	62	1110

## Dimensiones mm

### THT/IMP-C

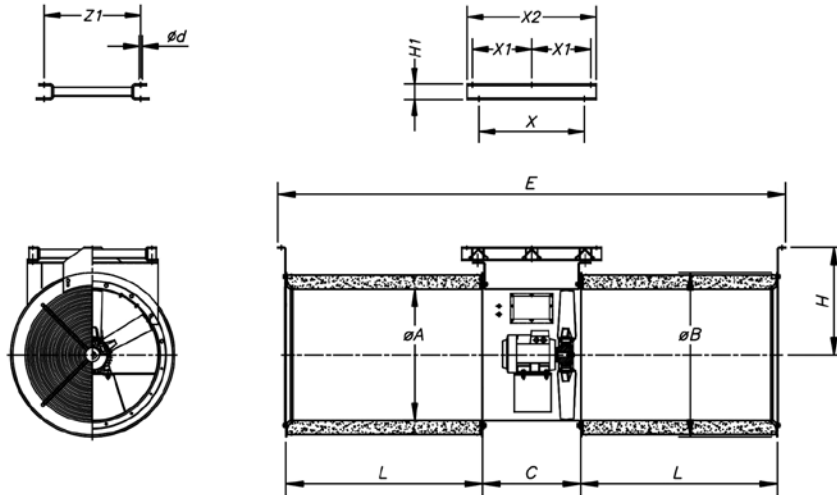

Modelo	ØA	ØB	C	L	Ød	E	H	H1-	X	X1	X2	Z	Z1
THT/IMP-C-56	560	750	500	1200	12	3093	503	80	558	345	750	475	465
THT/IMP-C-63	640	800	650	1200	14	3242	525	80	706	418	900	550	545
THT/IMP-C-71	710	900	500	1200	14	3092	600	80	558	345	750	475	465
THT/IMP-C-80	800	1000	600	1200	14	3104	655	80	656	395	855	730	730
THT/IMP-C-90	900	1100	600	1200	14	3105	675	80	677	405,5	876	825	825
THT/IMP-C-100	1000	1200	700	1200	14	3205	730	80	767	450	965	884	884
THT/IMP-C-125	1250	1503	650	1350	17	3455	953	100	717	575	1250	1150	1150

## Curvas características

Q= Caudal en m<sup>3</sup>/h, m<sup>3</sup>/s y cfm. Pe= Presión estática en mmH<sub>2</sub>O, Pa e inwg.

— Presión - - - Empuje (N)

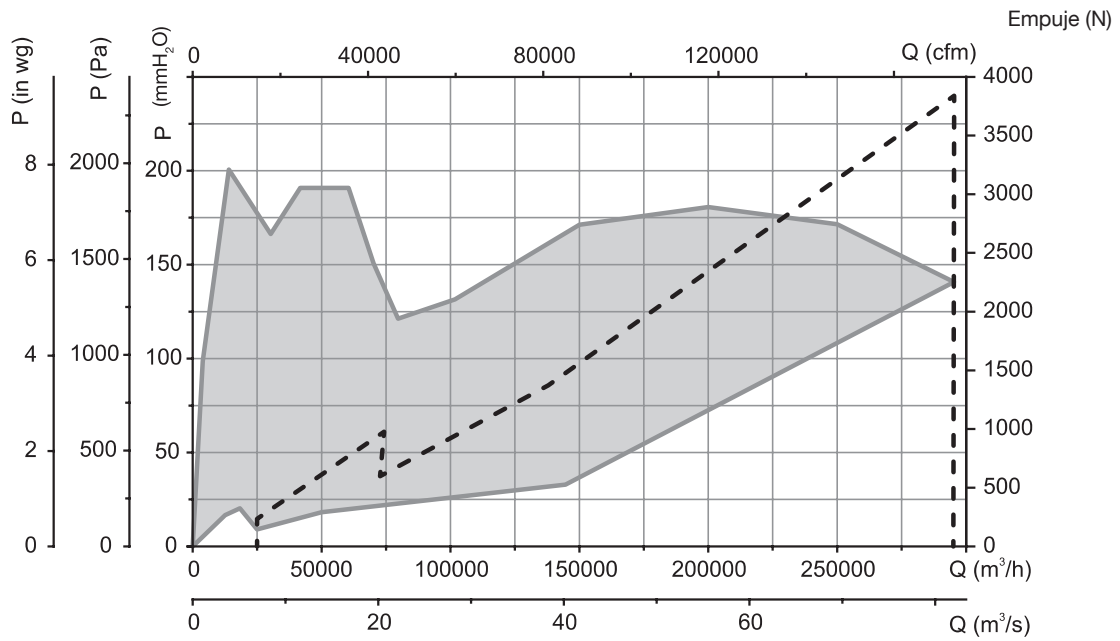

## Ejemplos de aplicación

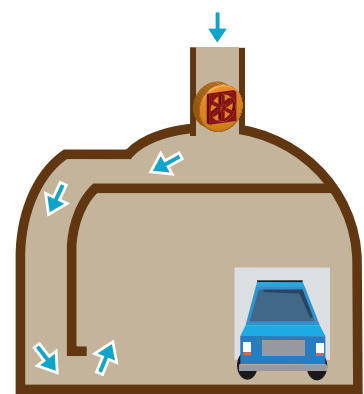
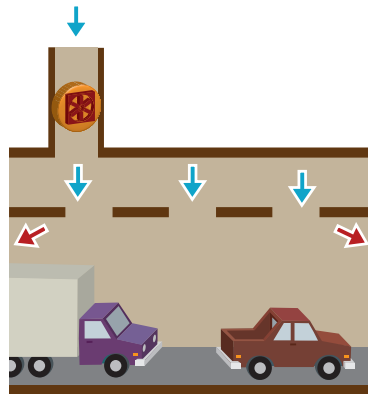

## Accesorios

Ver apartado accesorios



INT

IAT

CABLE BOX

C2V

AET

AR

CENTRAL CO

VSD

P-400

R/VMSF

RT



# CI



Caja de conexiones en el exterior  
Pies fijación

## Jet fans centrífugos de inducción y de gran alcance 300°C/2h y 400°C/2h, para trabajar dentro de la zona de riesgo de incendio, con bajo perfil

Jet fans centrífugos de inducción y de gran alcance 300°C/2h y 400°C/2h, para trabajar dentro de la zona de riesgo de incendio, con bajo perfil

### Ventilador:

- Envoltente en chapa de acero
- Turbina con álabes a reacción en chapa de acero de gran robustez
- Caja de conexiones en el exterior
- Pies fijación incluidos

### Motor:

- Motores clase H, uso continuo S1 y uso emergencia S2, con rodamientos a bolas, protección IP-55 de 1 o 2 velocidades según modelo
- Trifásicos 230/400V 50Hz
- Temperatura máxima del aire a transportar:  
Servicio S1 -20°C +40°C en continuo,  
Servicio S2 300°C/2h y 400°C/2h.

### Acabado:

- Anticorrosivo en resina de poliéster polimerizada a 190 °C, previo desengrase con tratamiento nanotecnológico libre de fosfatos.



## Código de pedido

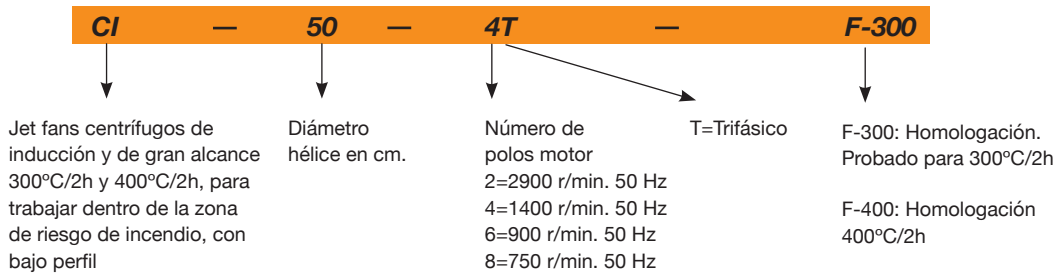

## Características técnicas

Modelo	Velocidad (r/min)	Intensidad máxima admisible (A)		Caudal (m³/h)	Empuje (N)	Potencia instalada (kW)	Presión sonora LpA a 1m dB(A)	Peso aprox. (Kg)
		230V	400V					
CI-50-4T	1395	5,00	2,90	6050	50	1,20	78	83
CI-50-4/8T	1395/650		2,90 / 1,20	6050 / 3020	50 / 13	1,20 / 0,30	78/63	83
CI-75-4T	1450	9,00	5,20	8080	75	2,20	85	139
CI-75-4/8T	1450/730		5,20 / 2,05	8080 / 4040	75 / 19	2,20 / 0,37	85/70	139
CI-100-4T	1445	9,90	5,70	9340	100	2,40	89	141
CI-100-4/8T	1445/715		5,70 / 2,20	9340 / 4670	100 / 25	2,40 / 0,55	89/14	141

**Dimensiones mm**

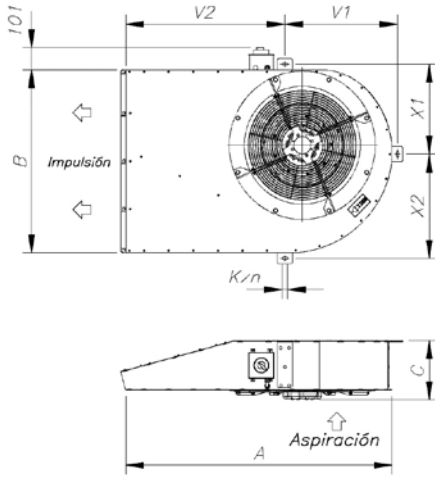

Modelo	A	B	C	V2	V1	X1	X2	Kxn
CI-50-F300	1240	840	272,5	741,5	524,5	413	477	12x26
CI-50-F400	1240	840	261,5	741,5	524,5	413	477	12x26
CI-75-F300	1778	1040	311	1143	662	494	596	12x26
CI-75-F400	1778	1040	299	1143	662	494	596	12x26
CI-100 F-300	1778	1040	323	1143	662	494	596	12x26
CI-100 F-400	1778	1040	323	1143	662	494	596	12x26

**Accesorios**

Ver apartado accesorios



INT IAT CABLE BOX C2V AET AR CENTRAL CO VSD

# HTMF

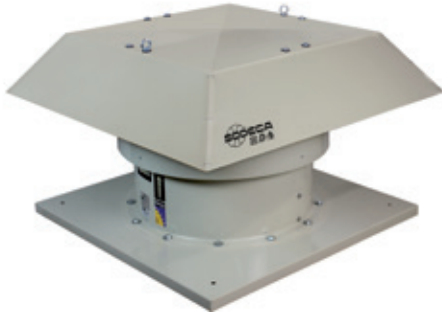

## Extractores de cubierta multifuncional 400°C/2h y 300°C/2h

Extractores de cubierta multifuncional 400°C/2h, para trabajar inmersos en zonas de riesgo de incendios, diseñados para evacuación de humos en naves industriales o similares

### Ventilador:

- Base soporte en chapa de acero
- Hélices orientables en fundición de aluminio
- Rejilla de protección contra contactos según norma UNE-EN ISO 12499
- Sombrero en chapa de acero, con salida de aire natural. Homologación según norma EN 12101-3:2002/AC:2006, con certificación N° 0370-CPR-0544

### Motor:

- Motores clase H, uso continuo S1 y uso emergencia S2, con rodamientos a bolas, protección IP55, de 1 ó 2 velocidades según modelo
- Trifásicos 230/400V.-50Hz.(hasta 4CV.) y 400/690V.-50Hz.(potencias superiores a 4CV.)
- Temperatura máxima del aire a transportar: Servicio S1 -20°C+ 40°C en continuo, Servicio S2 300°C/2h, 400°C/2h

### Acabado:

- Anticorrosivo en resina de poliéster polimerizada a 190 °C, previo desengrase con tratamiento nanotecnológico libre de fosfatos.

### Bajo demanda:

- Extractores con motor de 200°C/2h de 1 ó 2 velocidades



## Código de pedido

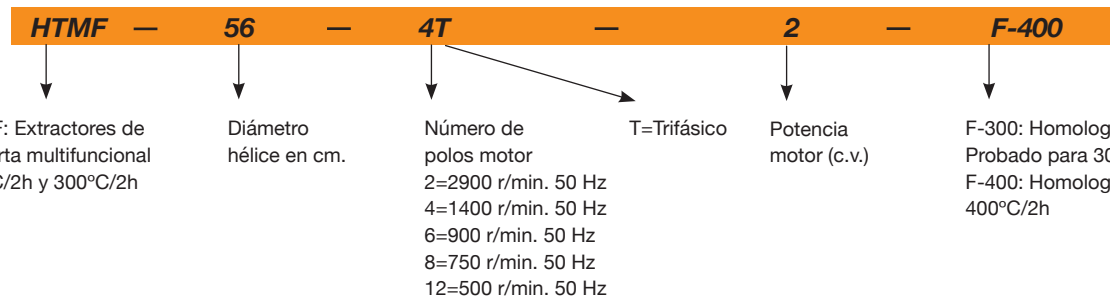

## Características técnicas

Modelo	Velocidad (r/min)	Intensidad máxima admisible (A)			Potencia instalada (kW)	Caudal máximo (m³/h)	Nivel presión (1) sonora dB(A)		Peso aprox. (Kg)
		230V	400V	690V			Aspiración	Descarga	
HTMF-56-4T-1	1430	3,80	2,20		0,75	10545	62	59	79
HTMF-56-4T-1,5	1420	4,70	2,70		1,10	11400	63	60	79
HTMF-56-4/8T-1,5	1440/710		2,90 / 1,40		1,10/0,25	11400 / 5700	63 / 48	60 / 45	79
HTMF-56-6T-0,75	930	3,30	1,90		0,55	8170	51	49	80
HTMF-63-4T-1,5	1420	4,70	2,70		1,10	13870	65	62	94
HTMF-63-4/8T-1,5	1440/710		2,90 / 1,40		1,10/0,25	13870 / 6935	65 / 50	62 / 47	94
HTMF-63-4T-2	1425	6,60	3,80		1,50	15485	66	63	96
HTMF-63-4/8T-2	1415/715		3,60 / 1,50		1,50/0,30	15485 / 7742	66 / 51	63 / 48	106
HTMF-63-4T-3	1435	9,20	5,30		2,20	17955	67	64	108
HTMF-63-4/8T-3	1415/715		5,20 / 1,90		2,20/0,45	17955 / 8977	67 / 52	64 / 49	112
HTMF-63-6T-0,75	930	3,30	1,90		0,55	10260	56	54	95
HTMF-63-6T-1	940	4,40	2,60		0,75	11305	57	55	95
HTMF-71-4T-2	1425	6,60	3,80		1,50	16150	69	66	109
HTMF-71-4/8T-2	1415/715		3,60 / 1,50		1,50/0,30	16150 / 8075	69 / 54	66 / 51	119
HTMF-71-4T-3	1435	9,20	5,30		2,20	18430	71	68	122
HTMF-71-4/8T-3	1415/715		5,20 / 1,90		2,20/0,45	18430 / 9215	71 / 56	68 / 53	125
HTMF-71-4T-4	1430	11,40	6,60		3,00	22610	72	69	133
HTMF-71-4/8T-4	1420/705		6,90 / 2,30		3,00/0,60	22610 / 11305	72 / 57	69 / 54	135
HTMF-71-6T-1	940	4,40	2,60		0,75	13205	58	56	109

## Características técnicas

Modelo	Velocidad (r/min)	Intensidad máxima admisible (A)			Potencia instalada (kW)	Caudal máximo (m³/h)	Nivel presión (1) sonora dB(A)		Peso aprox. (Kg)
		230V	400V	690V			Aspiración	Descarga	
HTMF-71-6T-1,5	945	6,40	3,70		1,10	16245	59	57	116
HTMF-80-4T-4	1430	11,40	6,60		3,00	27600	73	70	163
HTMF-80-4/8T-4	1420/705		6,90 / 2,30		3,00/0,60	27600 / 13800	73 / 58	70 / 55	165
HTMF-80-4T-5,5	1440		8,40	4,85	4,00	30176	74	71	163
HTMF-80-4/8T-5,5	1450/720		9,40 / 3,50		4,00/0,80	30176 / 15088	74 / 59	71 / 56	195
HTMF-80-6T-1,5	945	6,40	3,70		1,10	19412	62	60	145
HTMF-80-6T-2	945	7,40	4,30		1,50	22172	63	61	148
HTMF-80-6T-3	950	10,30	5,90		2,20	24932	64	62	160
HTMF-80-8T-1	710	4,80	2,80		0,75	16376	61	60	151
HTMF-90-4T-5,5	1440		8,40	4,85	4,00	35052	79	76	208
HTMF-90-4/8T-5,5	1450/720		9,40 / 3,50		4,00/0,80	35052 / 17526	79 / 64	76 / 61	238
HTMF-90-4T-7,5	1430		11,50	6,64	5,50	38456	81	78	240
HTMF-90-4/8T-7,5	1455/725		12,80 / 4,60		5,50/1,10	38456 / 19228	81 / 66	78 / 63	243
HTMF-90-4T-10	1460		17,70	10,22	7,50	41308	82	79	244
HTMF-90-4/8T-9	1455/725		15,50 / 5,50		6,70/1,50	41308 / 20654	82 / 67	79 / 64	243
HTMF-90-6T-3	950	10,30	5,90		2,20	29256	68	66	205
HTMF-90-6/12T-3	940/470		5,60 / 2,20		2,20/0,37	29256 / 14628	68 / 53	66 / 51	245
HTMF-90-6T-4	945	15,00	8,70		3,00	32016	69	67	235
HTMF-90-6/12T-4	970/475		8,90 / 3,50		3,00/0,55	32016 / 16008	69 / 54	67 / 52	245
HTMF-90-8T-1	710	4,80	2,80		0,75	17020	61	60	196
HTMF-90-8T-2	700	9,00	5,20		1,50	19596	63	62	208
HTMF-100-4T-7,5	1430		11,50	6,64	5,50	40756	84	81	265
HTMF-100-4/8T-7,5	1455/725		12,80 / 4,60		5,50/1,10	40756 / 20378	84 / 69	81 / 66	269
HTMF-100-4T-10	1460		17,70	10,22	7,50	47564	85	82	269
HTMF-100-4/8T-9	1455/725		15,50 / 5,50		6,70/1,50	44528 / 22264	84 / 69	81 / 66	269
HTMF-100-4T-15	1455		23,00	13,28	11,00	51336	86	83	332
HTMF-100-4/8T-14	1470/725		23,20 / 8,70		11,00/2,80	48300 / 24150	85 / 70	82 / 67	301
HTMF-100-6T-3	950	10,30	5,90		2,20	32476	74	72	231
HTMF-100-6/12T-3	940/470		5,60 / 2,20		2,20/0,37	32476 / 16238	74 / 59	72 / 57	271
HTMF-100-6T-4	945	15,00	8,70		3,00	35420	75	73	260
HTMF-100-6/12T-4	970/475		8,90 / 3,50		3,00/0,55	35420 / 17710	75 / 60	73 / 58	271
HTMF-100-6T-5,5	970		11,00	6,35	4,00	40020	76	74	277
HTMF-100-6/12T-5,5	970/480		11,30 / 4,20		4,00/0,65	40020 / 20010	76 / 61	74 / 59	289
HTMF-100-8T-3	705	13,20	7,60		2,20	26404	69	68	260
HTMF-100-8T-4	710	15,60	9,00		3,00	28704	70	69	270
HTMF-THT-125-4T/3-10	1460		13,90	8,06	7,50	55250	75	72	330
HTMF-THT-125-4T/3-15	1470		20,90	12,10	11,00	72150	76	73	369
HTMF-THT-125-4T/3-20	1465		27,90	16,20	15,00	83120	78	75	391
HTMF-THT-125-4T/6-15	1470		20,90	12,10	11,00	66800	76	73	384
HTMF-THT-125-4T/6-20	1465		27,90	16,20	15,00	72900	76	73	406
HTMF-THT-125-4T/9-20	1465		27,90	16,20	15,00	76310	75	72	422
HTMF-THT-125-6T/6-5,5	970		11,00	6,35	4,00	47760	63	61	341
HTMF-THT-125-6T/6-7,5	970		14,00	8,08	5,50	55600	63	61	341
HTMF-THT-125-6T/6-10	975		14,80	8,58	7,50	66170	65	63	389
HTMF-THT-125-6T/6-15	975		21,90	12,70	11,00	76380	67	65	411
HTMF-THT-125-6T/9-7,5	970		14,00	8,08	5,50	50000	64	62	357
HTMF-THT-125-6T/9-10	975		14,80	8,58	7,50	59340	64	62	405
HTMF-THT-125-6T/9-15	975		21,90	12,70	11,00	71890	67	65	427
HTMF-THT-125-6T/9-20	975		28,20	16,30	15,00	83660	70	68	422
HTMF-THT-125-8T/6-4	710	15,60	9,00		3,00	47510	56	55	346
HTMF-THT-125-8T/6-5,5	710		13,00	7,51	4,00	52770	58	57	385
HTMF-THT-125-8T/6-7,5	710		15,10	8,72	5,50	60410	60	59	394
HTMF-THT-125-8T/6-10	715		20,60	11,89	7,50	66030	61	60	416
HTMF-THT-125-8T/9-5,5	710		13,00	7,51	4,00	51330	58	57	401
HTMF-THT-125-8T/9-7,5	710		15,10	8,72	5,50	54480	61	60	410
HTMF-THT-125-8T/9-10	715		20,60	11,89	11,00	65660	64	63	432
HTMF-THT-125-8T/9-15	725		21,70	12,53	7,50	73870	63	62	472

(1) Los valores de los niveles sonoros, son presiones en dB(A) medidos a 6 metros, en campo libre.



## Erp. Características del punto de máxima eficiencia (BEP)

<b>MC</b>	Categoría de medición	<b>ηe[%]</b>	Eficiencia
<b>EC</b>	Categoría de eficiencia	<b>N</b>	Grado de eficiencia
	<b>S</b> Estática	<b>[kW]</b>	Potencia eléctrica
	<b>T</b> Total	<b>[m³/h]</b>	Caudal
<b>VSD</b>	Variador de velocidad	<b>[mmH₂O]</b>	Presión estática o total (Según EC)
<b>SR</b>	Relación específica	<b>[RPM]</b>	Velocidad

Modelo	MC	EC	VSD	SR	ηe[%]	N	(kW)	(m³/h)	(mmH₂O)	(RPM)
HTMF-56-4T-1	C	S	NO	1,00	35,4%	38,2	0,85	7901	14,07	1443
HTMF-56-4T-1,5	B	T	NO	1,00	48,5%	49,7	1,16	11340	18,14	1438
HTMF-56-4/8T-1,5	B	T	NO	1,00	44,9%	46,9	1,33	11588	18,94	1449
HTMF-56-6T-0,75	B	T	NO	1,00	42,7%	45,4	0,52	9212	8,77	955
HTMF-63-4T-1,5	C	S	NO	1,00	48,2%	49,6	1,11	10387	18,88	1440
HTMF-63-4/8T-1,5	C	S	NO	1,00	41,3%	46,6	1,38	10605	19,68	1447
HTMF-63-4T-2	C	S	NO	1,00	42,4%	41,9	1,54	12016	20,00	1444
HTMF-63-4/8T-2	C	S	NO	1,00	37,2%	41,7	1,70	11892	19,59	1430
HTMF-63-4T-3	B	T	NO	1,00	62,4%	62,1	2,19	19423	25,86	1450
HTMF-63-4/8T-3	B	T	NO	1,00	56,0%	58,2	2,42	19373	25,73	1432
HTMF-63-6T-0,75	B	T	NO	1,00	56,1%	58,6	0,55	11393	9,86	956
HTMF-63-6T-1	B	T	NO	1,00	54,9%	55,3	0,80	13916	11,57	957
HTMF-71-4T-2	C	S	NO	1,00	48,5%	47,3	1,49	13409	19,84	1446
HTMF-71-4/8T-2	C	S	NO	1,00	42,6%	47,1	1,65	13275	19,45	1433
HTMF-71-4T-3	C	S	NO	1,00	44,7%	45,7	2,16	16356	21,67	1450
HTMF-71-4/8T-3	C	S	NO	1,00	40,1%	42,8	2,39	16314	21,56	1433
HTMF-71-4T-4	B	T	NO	1,00	68,4%	66,3	2,87	23676	30,48	1447
HTMF-71-4/8T-4	B	T	NO	1,00	61,6%	65,2	3,24	23797	30,80	1433
HTMF-71-6T-1	B	T	NO	1,00	62,4%	61,1	0,82	14945	12,60	957
HTMF-71-6T-1,5	B	T	NO	1,00	59,2%	59,1	1,15	18001	13,88	960
HTMF-80-4T-4	C	S	NO	1,00	46,9%	46,2	3,22	20108	27,62	1441
HTMF-80-4/8T-4	C	S	NO	1,00	42,3%	45,4	3,64	20222	27,93	1424
HTMF-80-4T-5,5	C	S	NO	1,00	45,5%	45,1	4,55	23694	32,11	1444
HTMF-80-4/8T-5,5	C	S	NO	1,00	43,3%	40,8	4,70	23552	31,72	1457
HTMF-80-6T-1,5	C	S	NO	1,00	38,9%	40,4	1,36	15261	12,68	953
HTMF-80-6T-2	B	T	NO	1,00	61,3%	61,4	1,85	24165	17,21	950
HTMF-80-6T-3	B	T	NO	1,00	64,9%	63,5	2,29	26615	20,53	960
HTMF-80-8T-1	B	T	NO	1,00	51,2%	56,4	1,13	18865	11,24	710
HTMF-90-4T-5,5	C	S	NO	1,00	51,0%	50,3	4,50	27512	30,65	1445
HTMF-90-4/8T-5,5	C	S	NO	1,00	48,6%	45,5	4,64	27348	30,28	1457
HTMF-90-4T-7,5	C	S	NO	1,00	47,8%	45,3	6,35	31725	35,17	1435
HTMF-90-4/8T-7,5	C	S	NO	1,00	43,0%	40,2	6,93	31525	34,73	1459
HTMF-90-4T-10	C	S	NO	1,01	45,4%	38,4	7,97	35188	37,75	1469
HTMF-90-4/8T-9	C	S	NO	1,00	43,0%	39,2	7,86	33548	36,97	1461
HTMF-90-6T-3	C	S	NO	1,00	42,8%	43,2	2,40	23147	16,33	958
HTMF-90-6/12T-3	C	S	NO	1,00	37,5%	41,4	2,64	22863	15,94	947
HTMF-90-6T-4	B	T	NO	1,00	63,7%	58,5	3,21	32972	22,77	957
HTMF-90-6/12T-4	B	T	NO	1,00	55,3%	57,4	3,70	32972	22,77	973
HTMF-90-8T-1	C	S	NO	1,00	36,4%	42,1	1,04	15838	8,76	713
HTMF-90-8T-2	B	T	NO	1,00	58,5%	55,4	1,40	24325	12,38	720
HTMF-100-4T-7,5	C	S	NO	1,00	50,5%	47,7	6,31	33024	35,42	1435
HTMF-100-4/8T-7,5	C	S	NO	1,00	45,4%	42,3	6,89	32817	34,98	1459
HTMF-100-4T-10	C	S	NO	1,00	48,1%	38,9	8,33	37734	39,02	1468
HTMF-100-4/8T-9	C	S	NO	1,00	45,8%	41,8	7,93	35548	37,50	1461
HTMF-100-4T-15	C	S	NO	1,01	44,1%	40,6	12,15	44732	43,97	1459
HTMF-100-4/8T-14	C	S	NO	1,01	39,0%	40,9	14,13	45164	44,82	1468
HTMF-100-6T-3	C	S	NO	1,00	45,4%	45,4	2,51	24808	16,87	956
HTMF-100-6/12T-3	C	S	NO	1,00	39,8%	43,6	2,75	24492	16,44	944
HTMF-100-6T-4	C	S	NO	1,00	41,1%	38,5	3,72	29458	19,07	950
HTMF-100-6/12T-4	C	S	NO	1,00	35,7%	38,1	4,29	29458	19,07	969
HTMF-100-6T-5,5	B	T	NO	1,00	61,3%	57,5	4,86	44005	24,89	972
HTMF-100-6/12T-5,5	B	T	NO	1,00	56,5%	55,4	5,44	44437	25,38	970
HTMF-100-8T-3	B	T	NO	1,00	52,5%	55,1	2,67	33957	15,20	710
HTMF-100-8T-4	B	T	NO	1,00	54,2%	55,3	2,77	41581	13,28	722
HTMF-THT-125-4T/3-10	C	S	NO	1,00	52,3%	53,2	7,59	41511	35,13	1468
HTMF-THT-125-4T/3-15	C	S	NO	1,01	56,1%	56,0	11,80	57655	42,19	1471
HTMF-THT-125-4T/3-20	C	S	NO	1,01	55,2%	54,9	15,29	67316	46,06	1472
HTMF-THT-125-4T/6-15	C	S	NO	1,01	57,8%	57,8	11,81	48508	51,71	1471
HTMF-THT-125-4T/6-20	C	S	NO	1,01	56,9%	56,7	14,20	52757	56,25	1474



## Erp. Características del punto de máxima eficiencia (BEP)

Modelo	MC	EC	VSD	SR	ηe[%]	N	(kW)	(m³/h)	(mmH₂O)	(RPM)
HTMF-THT-125-4T/9-20	C	S	NO	1,01	70,4%	70,1	17,44	37304	120,90	1474
HTMF-THT-125-6T/6-5,5	C	S	NO	1,00	53,1%	55,5	4,28	34565	24,14	972
HTMF-THT-125-6T/6-7,5	C	S	NO	1,00	54,7%	56,3	5,53	41832	26,55	974
HTMF-THT-125-6T/6-10	C	S	NO	1,00	55,2%	55,9	7,84	53067	29,95	972
HTMF-THT-125-6T/6-15	C	S	NO	1,00	51,2%	51,2	11,09	61349	34,01	972
HTMF-THT-125-6T/9-7,5	C	S	NO	1,00	57,2%	58,8	5,67	36967	32,26	973
HTMF-THT-125-6T/9-10	C	S	NO	1,00	55,1%	56,2	6,74	48390	28,19	976
HTMF-THT-125-6T/9-15	C	S	NO	1,00	50,9%	50,9	11,00	61885	33,25	973
HTMF-THT-125-6T/9-20	C	S	NO	1,01	49,7%	49,5	15,00	69606	39,35	968
HTMF-THT-125-8T/6-4	C	S	NO	1,00	47,4%	50,3	3,53	38680	15,89	709
HTMF-THT-125-8T/6-5,5	C	S	NO	1,00	46,8%	49,1	4,42	42659	17,80	715
HTMF-THT-125-8T/6-7,5	C	S	NO	1,00	45,5%	47,0	5,87	50667	19,37	727
HTMF-THT-125-8T/6-10	B	T	NO	1,00	65,4%	66,1	7,79	65294	28,66	727
HTMF-THT-125-8T/9-5,5	C	S	NO	1,00	44,6%	46,7	4,79	43462	18,07	712
HTMF-THT-125-8T/9-7,5	C	S	NO	1,00	46,5%	48,0	5,75	48507	20,26	728
HTMF-THT-125-8T/9-10	C	S	NO	1,00	45,9%	46,7	7,65	55731	23,16	728
HTMF-THT-125-8T/9-15	B	T	NO	1,00	67,6%	67,6	10,90	72088	37,51	728

Datos del ventilador interno

## Características acústicas

Valores tomados a la aspiración con caudal máximo.

Valores tomados a la descarga con caudal máximo.

Espectro de potencia sonora Lw(A) en dB(A) por banda de frecuencia en Hz

Modelo	63	125	250	500	1000	2000	4000	8000
56-4-1	46	67	74	79	82	78	71	60
56-4-1,5	47	68	75	80	83	79	72	61
56-6-0,75	35	56	63	68	71	67	60	49
56-8-1,5	32	53	60	65	68	64	57	46
63-4-1,5	49	70	77	82	85	81	74	63
63-4-2	50	71	78	83	86	82	75	64
63-4-3	51	72	79	84	87	83	76	65
63-6-0,75	40	61	68	73	76	72	65	54
63-6-1	41	62	69	74	77	73	66	55
63-8-1,5	34	55	62	67	70	66	59	48
63-8-2	35	56	63	68	71	67	60	49
63-8-3	36	57	64	69	72	68	61	50
71-4-2	53	74	81	86	89	85	78	67
71-4-3	55	76	83	88	91	87	80	69
71-4-4	56	77	84	89	92	88	81	70
71-6-1	42	63	70	75	78	74	67	56
71-6-1,5	43	64	71	76	79	75	68	57
71-8-2	38	59	66	71	74	70	63	52
71-8-3	40	61	68	73	76	72	65	54
71-8-4	41	62	69	74	77	73	66	55
80-4-4	57	78	85	90	93	89	82	71
80-4-5,5	58	79	86	91	94	90	83	72
80-6-1,5	46	67	74	79	82	78	71	60
80-6-2	47	68	75	80	83	79	72	61
80-6-3	48	69	76	81	84	80	73	62
80-8-1	45	66	73	78	81	77	70	59
80-8-4	42	63	70	75	78	74	67	56
80-8-5,5	43	64	71	76	79	75	68	57
90-4-5,5	63	84	91	96	99	95	88	77
90-4-7,5	65	86	93	98	101	97	90	79
90-4-9	66	87	94	99	102	98	91	80
90-4-10	66	87	94	99	102	98	91	80
90-6-3	52	73	80	85	88	84	77	66
90-6-4	53	74	81	86	89	85	78	67
90-8-1	45	66	73	78	81	77	70	59
90-8-2	47	68	75	80	83	79	72	61
90-8-5,5	48	69	76	81	84	80	73	62
90-8-7,5	50	71	78	83	86	82	75	64
90-8-9	51	72	79	84	87	83	76	65

Modelo	63	125	250	500	1000	2000	4000	8000
56-4-1	43	64	71	76	79	75	68	57
56-4-1,5	44	65	72	77	80	76	69	58
56-6-0,75	33	54	61	66	69	65	58	47
56-8-1,5	29	50	57	62	65	61	54	43
63-4-1,5	46	67	74	79	82	78	71	60
63-4-2	47	68	75	80	83	79	72	61
63-4-3	48	69	76	81	84	80	73	62
63-6-0,75	38	59	66	71	74	70	63	52
63-6-1	39	60	67	72	75	71	64	53
63-8-1,5	31	52	59	64	67	63	56	45
63-8-2	32	53	60	65	68	64	57	46
63-8-3	33	54	61	66	69	65	58	47
71-4-2	50	71	78	83	86	82	75	64
71-4-3	52	73	80	85	88	84	77	66
71-4-4	53	74	81	86	89	85	78	67
71-6-1	40	61	68	73	76	72	65	54
71-6-1,5	41	62	69	74	77	73	66	55
71-8-2	35	56	63	68	71	67	60	49
71-8-3	37	58	65	70	73	69	62	51
71-8-4	38	59	66	71	74	70	63	52
80-4-4	54	75	82	87	90	86	79	68
80-4-5,5	55	76	83	88	91	87	80	69
80-6-1,5	44	65	72	77	80	76	69	58
80-6-2	45	66	73	78	81	77	70	59
80-6-3	46	67	74	79	82	78	71	60
80-8-1	44	65	72	77	80	76	69	58
80-8-4	39	60	67	72	75	71	64	53
80-8-5,5	40	61	68	73	76	72	65	54
90-4-5,5	60	81	88	93	96	92	85	74
90-4-7,5	62	83	90	95	98	94	87	76
90-4-9	63	84	91	96	99	95	88	77
90-4-10	63	84	91	96	99	95	88	77
90-6-3	50	71	78	83	86	82	75	64
90-6-4	51	72	79	84	87	83	76	65
90-8-1	44	65	72	77	80	76	69	58
90-8-2	46	67	74	79	82	78	71	60
90-8-5,5	45	66	73	78	81	77	70	59
90-8-7,5	47	68	75	80	83	79	72	61
90-8-9	48	69	76	81	84	80	73	62

## Características acústicas

Valores tomados a la aspiración con caudal máximo.

Valores tomados a la descarga con caudal máximo.

Espectro de potencia sonora Lw(A) en dB(A) por banda de frecuencia en Hz

Modelo	63	125	250	500	1000	2000	4000	8000	Modelo	63	125	250	500	1000	2000	4000	8000
90-12-3	37	58	65	70	73	69	62	51	90-12-3	35	56	63	68	71	67	60	49
90-12-4	38	59	66	71	74	70	63	52	90-12-4	36	57	64	69	72	68	61	50
100-4-7,5	68	89	96	101	104	100	93	82	100-4-7,5	65	86	93	98	101	97	90	79
100-4-9	68	89	96	101	104	100	93	82	100-4-9	65	86	93	98	101	97	90	79
100-4-10	69	90	97	102	105	101	94	83	100-4-10	66	87	94	99	102	98	91	80
100-4-14	69	90	97	102	105	101	94	83	100-4-14	66	87	94	99	102	98	91	80
100-4-15	70	91	98	103	106	102	95	84	100-4-15	67	88	95	100	103	99	92	81
100-6-3	58	79	86	91	94	90	83	72	100-6-3	56	77	84	89	92	88	81	70
100-6-4	59	80	87	92	95	91	84	73	100-6-4	57	78	85	90	93	89	82	71
100-6-5,5	60	81	88	93	96	92	85	74	100-6-5,5	58	79	86	91	94	90	83	72
100-8-3	53	74	81	86	89	85	78	67	100-8-3	52	73	80	85	88	84	77	66
100-8-4	54	75	82	87	90	86	79	68	100-8-4	53	74	81	86	89	85	78	67
100-8-7,5	53	74	81	86	89	85	78	67	100-8-7,5	50	71	78	83	86	82	75	64
100-8-9	53	74	81	86	89	85	78	67	100-8-9	50	71	78	83	86	82	75	64
100-8-14	54	75	82	87	90	86	79	68	100-8-14	51	72	79	84	87	83	76	65
100-12-3	43	64	71	76	79	75	68	57	100-12-3	41	62	69	74	77	73	66	55
100-12-4	44	65	72	77	80	76	69	58	100-12-4	42	63	70	75	78	74	67	56
100-12-5,5	45	66	73	78	81	77	70	59	100-12-5,5	43	64	71	76	79	75	68	57
125-4T/3-10	66	73	84	94	95	90	82	78	125-4T/3-10	63	70	81	91	92	87	79	75
125-4T/3-15	67	74	85	95	96	91	83	79	125-4T/3-15	64	71	82	92	93	88	80	76
125-4T/3-20	69	76	87	97	98	93	85	81	125-4T/3-20	66	73	84	94	95	90	82	78
125-4T/6-15	63	72	87	94	97	91	85	81	125-4T/6-15	60	69	84	91	94	88	82	78
125-4T/6-20	63	72	87	94	97	91	85	81	125-4T/6-20	60	69	84	91	94	88	82	78
125-4T/9-20	62	71	87	93	95	89	84	80	125-4T/9-20	59	68	84	90	92	86	81	77
125-6T/6-5,5	56	66	78	81	83	79	68	64	125-6T/6-5,5	54	64	76	79	81	77	66	62
125-6T/6-7,5	56	66	78	81	83	79	68	64	125-6T/6-7,5	54	64	76	79	81	77	66	62
125-6T/6-10	58	68	80	83	85	81	70	66	125-6T/6-10	56	66	78	81	83	79	68	64
125-6T/6-15	60	70	82	85	87	83	72	68	125-6T/6-15	58	68	80	83	85	81	70	66
125-6T/9-7,5	54	65	79	83	83	81	70	66	125-6T/9-7,5	52	63	77	81	81	79	68	64
125-6T/9-10	54	65	79	83	83	81	70	66	125-6T/9-10	52	63	77	81	81	79	68	64
125-6T/9-15	57	68	82	86	86	84	73	69	125-6T/9-15	55	66	80	84	84	82	71	67
125-6T/9-20	60	71	85	89	89	87	76	72	125-6T/9-20	58	69	83	87	87	85	74	70
125-8T/6-4	50	59	70	75	75	69	58	54	125-8T/6-4	49	58	69	74	74	68	57	53
125-8T/6-5,5	52	61	72	77	77	71	60	56	125-8T/6-5,5	51	60	71	76	76	70	59	55
125-8T/6-7,5	54	63	74	79	79	73	62	58	125-8T/6-7,5	53	62	73	78	78	72	61	57
125-8T/6-10	55	64	75	80	80	74	63	59	125-8T/6-10	54	63	74	79	79	73	62	58
125-8T/9-5,5	49	61	70	76	78	72	61	57	125-8T/9-5,5	48	60	69	75	77	71	60	56
125-8T/9-7,5	52	64	73	79	81	75	64	60	125-8T/9-7,5	51	63	72	78	80	74	63	59
125-8T/9-10	54	66	75	81	83	77	66	62	125-8T/9-10	53	65	74	80	82	76	65	61
125-8T/9-15	55	67	76	82	84	78	67	63	125-8T/9-15	54	66	75	81	83	77	66	62

## Dimensiones mm

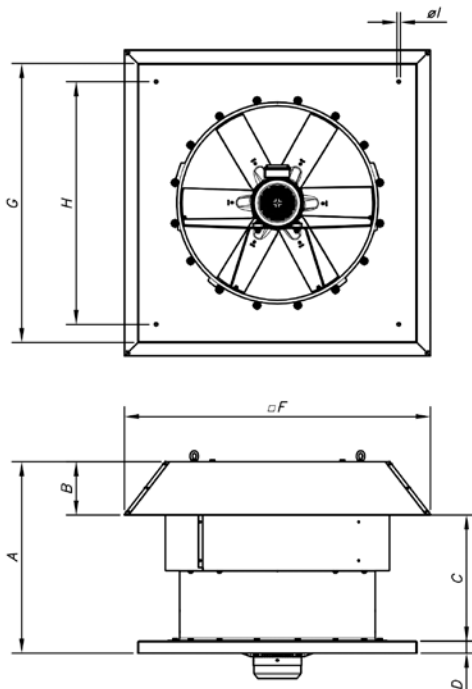

	A	B	C	D	F	G	H	I
HTMF-56	650	185	425	40	963	900	750	14
HTMF-63	680	215	425	40	1093	1000	850	14
HTMF-71	760	195	525	40	1223	1000	850	14
HTMF-80	790	220	520	50	1263	1150	1000	14
HTMF-90	910	232	638	50	1380	1150	1000	14
HTMF-100	1025	262	713	50	1525	1250	1100	14
HTMF-125	1170	310	859	50	1802	1600	1450	17

**Curvas características**

Q= Caudal en m<sup>3</sup>/h, m<sup>3</sup>/s y cfm.

Pe= Presión estática en mmH<sub>2</sub>O, Pa e inwg.

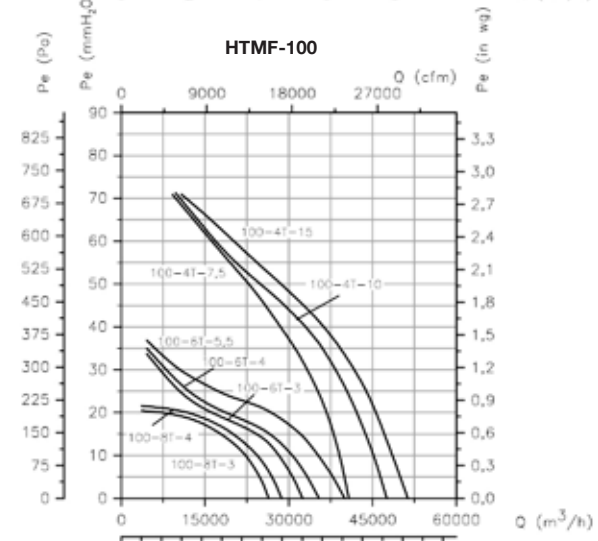
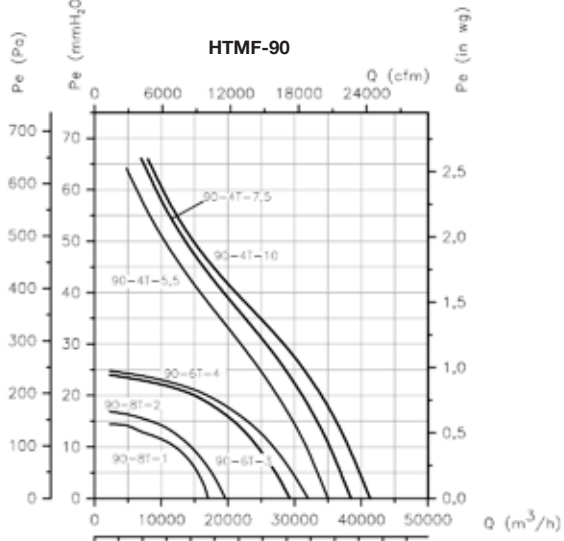
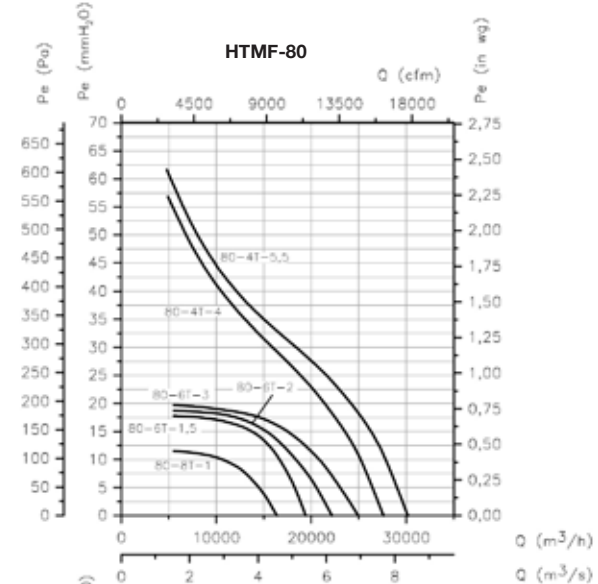
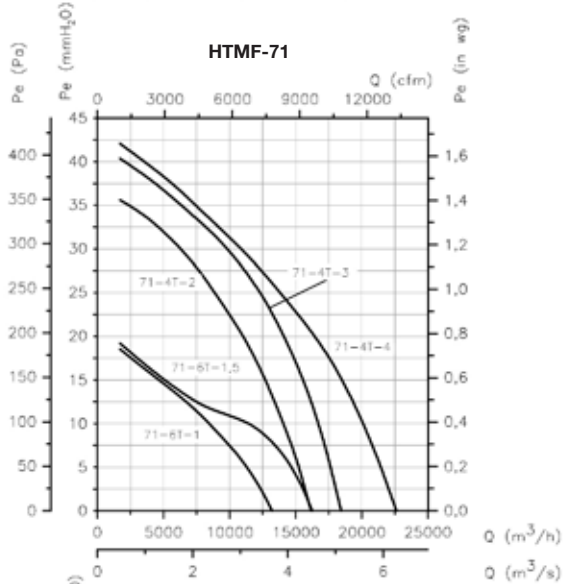
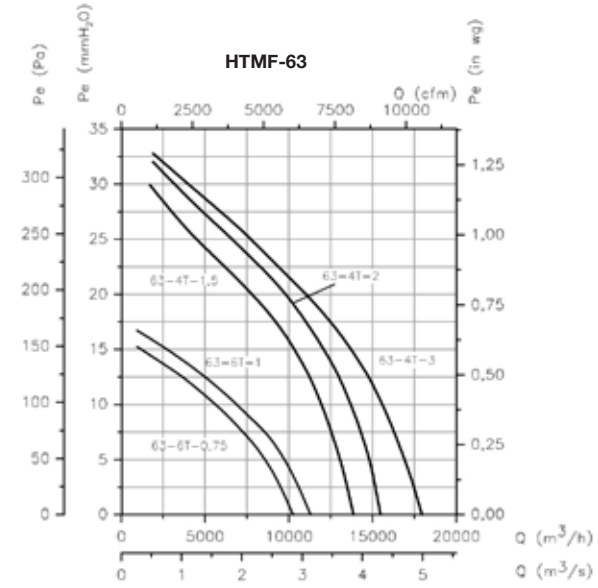
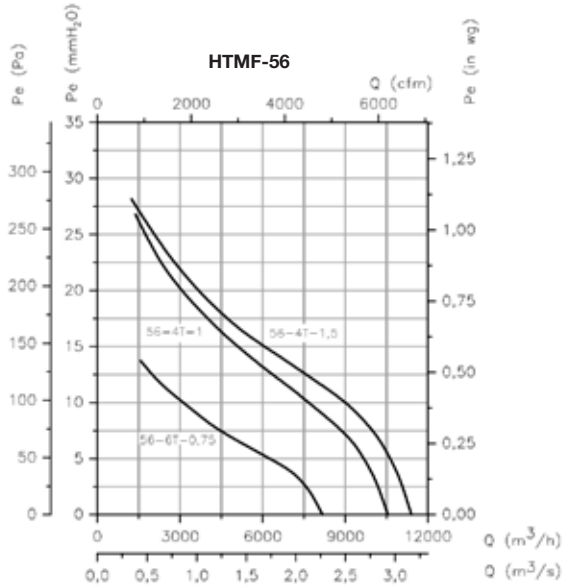



## Curvas características

Q= Caudal en m<sup>3</sup>/h, m<sup>3</sup>/s y cfm.

Pe= Presión estática en mmH<sub>2</sub>O, Pa e inwg.

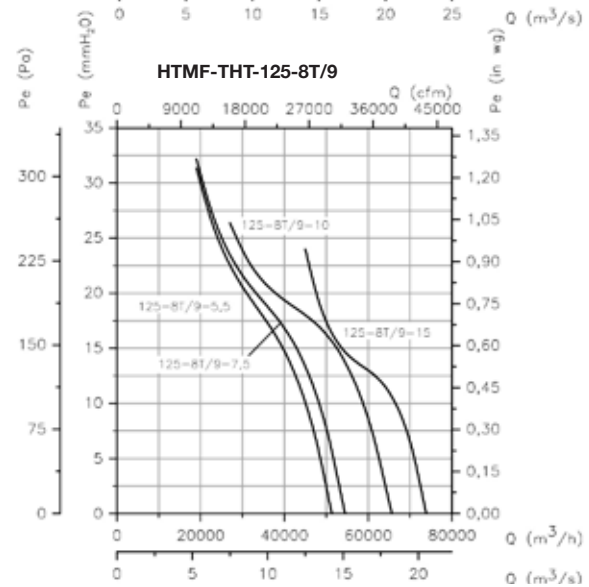
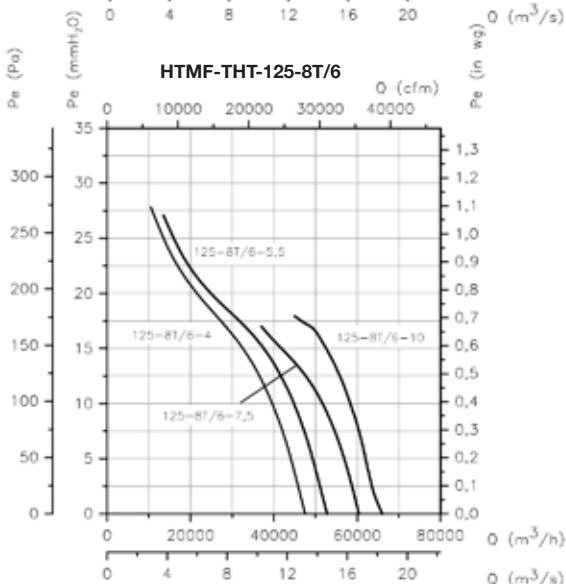
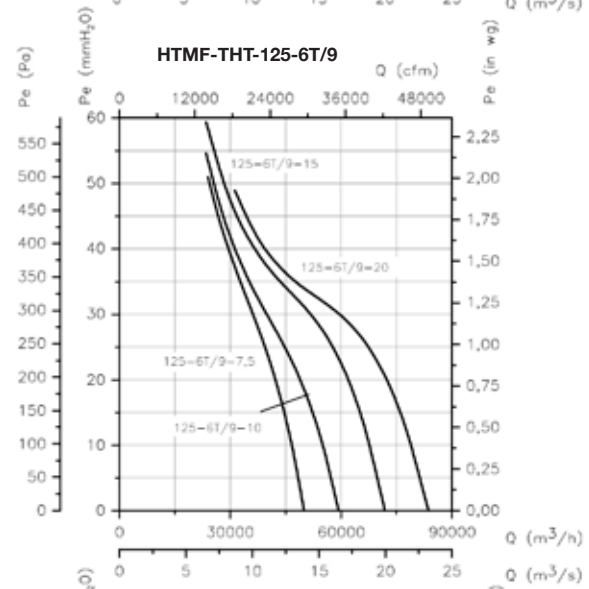
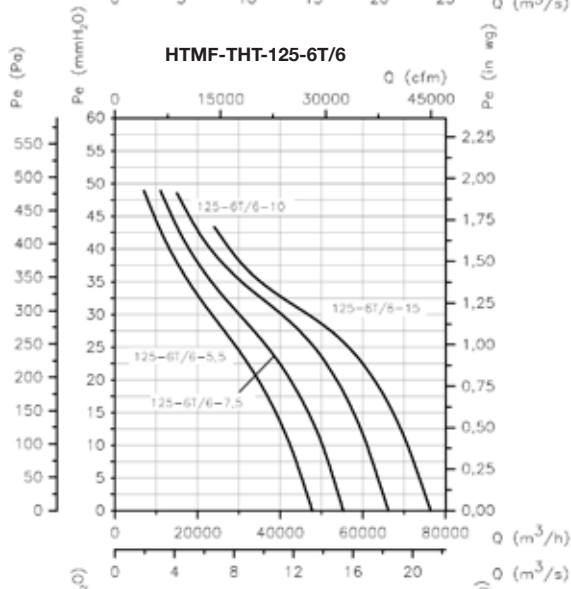
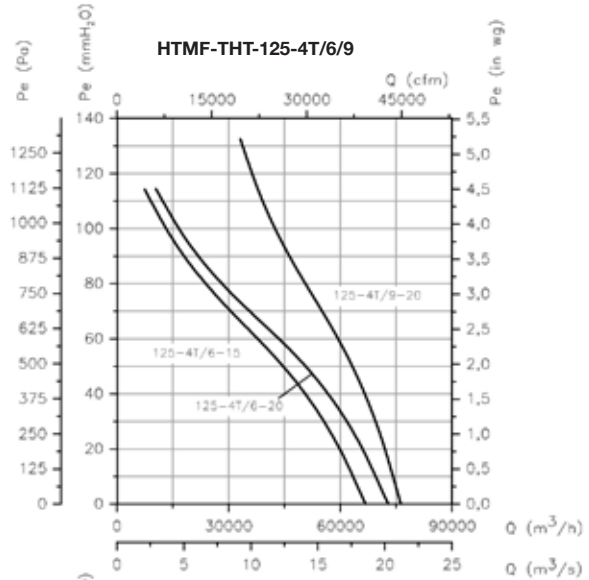
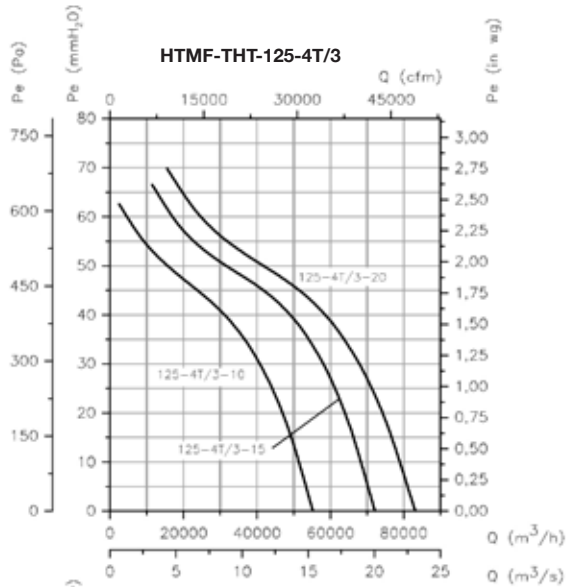

**Validación de la presión sonora según distancia**

El nivel sonoro puede variar dependiendo de la estructura de la cubierta o tejado.

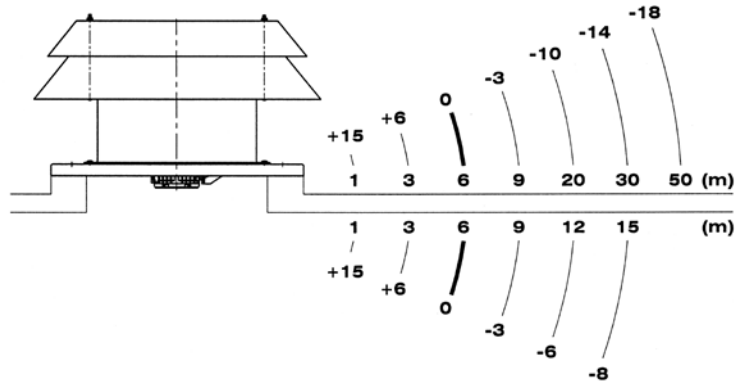

**Accesorios**

Ver apartado accesorios

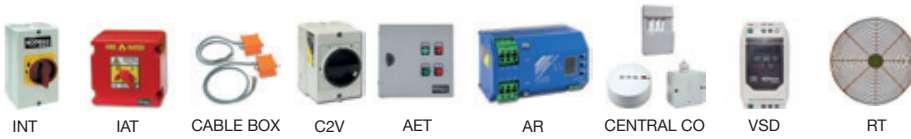

INT IAT CABLE BOX C2V AET AR CENTRAL CO VSD RT

# CJBDT/CBDT



**Unidades de extracción y extractores centrifugos de doble aspiración con motor directo, para trabajar inmersos en zonas de riesgo de incendio 400C/2h y 300°C/2h, con posibilidad de motor monofásico**



Unidades de extracción y extractores centrifugos de doble aspiración con motor directo, para trabajar inmersos en zonas de riesgo de incendio 400C/2h, con posibilidad de motor monofásico



**Ventilador:**

- Envoltente en chapa de acero galvanizado
- Turbina con álabes hacia delante, en chapa de acero galvanizado
- Caja de conexiones exterior
- Amortiguadores antivibratorios (CJBDT)
- Homologación según norma EN 12101-3:2002/AC:2006, con certificación N°0370-CPR-0580

**Motor:**

- Motores clase H, uso continuo S1 y uso emergencia S2, con rodamientos a bolas, protección IP-55 de 1 o 2 velocidades según modelo.
- Monofásicos 230V 50Hz, y Trifásicos 230/400V 50Hz (hasta 4CV) y 400/690V 50 Hz (potencias superiores a 4CV)
- Temperatura máxima del aire a transportar: Servicio S1 -20°C +60°C en continuo, Servicio S2 300°C/2h, 400°C/2h

**Acabado:**

- Anticorrosivo en chapa de acero galvanizado.

**Bajo demanda:**

- Extractores con impulsión circular
- Extractores con salida vertical



Caja de conexiones exterior y pies soporte



Motores monofásicos 400°C/2h

**Código de pedido**

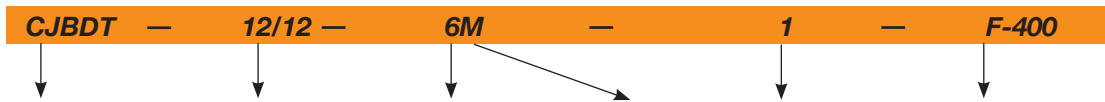

CJBDT: Unidades de extracción de doble aspiración con motor directo, para trabajar inmersos en zonas de riesgo de incendio 400C/2h y 300°C/2h, con posibilidad de motor monofásico

Tamaño turbina

Número de polos motor  
 2=2900 r/min. 50 Hz  
 4=1400 r/min. 50 Hz  
 6=900 r/min. 50 Hz  
 8=750 r/min. 50 Hz  
 12=500 r/min. 50 Hz

M=Monofásico Potencia motor (c.v.)  
 T=Trifásico

F-300: Homologación. Probado para 300°C/2h.  
 F-400: Homologación 400°C/2h

CBDT: Extractores centrifugos de doble aspiración con motor directo, para trabajar inmersos en zonas de riesgo de incendio 400C/2h y 300°C/2h, con posibilidad de motor monofásico

## Características técnicas

Modelo		Velocidad (r/min)	Intensidad máxima admisible (A)			Potencia instalada (kW)	Caudal máximo (m³/h)	Nivel presión sonora dB(A)		Peso aprox. (Kg)	
			230V	400V	690V			CJBDT	CBDT	CJBDT	CBDT
CJBDT-9/9-4T	CBDT-9/9-4T	1420	2,90	1,70		0,55	3000	64	66	44	24
CJBDT-9/9-4/8T	CBDT-9/9-4/8T	1440 / 710		1,76 / 0,76		0,55 / 0,15	3000 / 1750	64 / 51	66 / 53	45	25
CJBDT-9/9-4M	CBDT-9/9-4M	1410	4,10			0,55	3000	64	66	44	23
CJBDT-9/9-6T	CBDT-9/9-6T	920	1,50	0,90		0,25	2100	60	61	42	22
CJBDT-9/9-6M	CBDT-9/9-6M	900	2,20			0,25	2100	60	61	42	21
CJBDT-10/10-4T	CBDT-10/10-4T	1420	2,90	1,70		0,55	3450	67	68	49	26
CJBDT-10/10-4/8T	CBDT-10/10-4/8T	1440 / 710		1,76 / 0,76		0,55 / 0,15	3450 / 1750	67 / 54	68 / 55	50	27
CJBDT-10/10-4M	CBDT-10/10-4M	1410	4,10			0,55	3450	67	68	49	25
CJBDT-10/10-6T	CBDT-10/10-6T	920	1,50	0,90		0,25	2250	63	64	47	24
CJBDT-10/10-6M	CBDT-10/10-6M	900	2,20			0,25	2250	63	64	47	23
CJBDT-12/12-6T-1	CBDT-12/12-6T-1	940	4,40	2,60		0,75	4800	64	65	69	37
CJBDT-12/12-6/12T-1	CBDT-12/12-6/12T-1	935 / 430		2,50 / 1,03		0,75 / 0,15	4800 / 2600	64 / 52	65 / 53	72	41
CJBDT-12/12-6M-1	CBDT-12/12-6M-1	920	5,80			0,75	4800	64	65	69	37
CJBDT-12/12-6T-1,5	CBDT-12/12-6T-1,5	945	6,40	3,70		1,10	6200	65	67	71	39
CJBDT-12/12-6/12T-1,5	CBDT-12/12-6/12T-1,5	940 / 450		3,30 / 1,20		1,10 / 0,18	6200 / 3250	65 / 53	67 / 55	75	44
CJBDT-12/12-6M-1,5	CBDT-12/12-6M-1,5	920	8,40			1,10	6200	65	67	71	39
CJBDT-15/15-6T	CBDT-15/15-6T	950	10,30	5,90		2,20	8250	67	68	110	68
CJBDT-15/15-6/12T	CBDT-15/15-6/12T	940 / 470		5,60 / 2,20		2,20 / 0,37	8250 / 4600	67 / 54	68 / 55	116	74
CJBDT-18/18-6T	CBDT-18/18-6T	970		11,00	6,35	4,00	11800	67	69	175	109
CJBDT-18/18-6/12T	CBDT-18/18-6/12T	970 / 480		11,30 / 4,20		4,00 / 0,65	11800 / 6600	67 / 54	69 / 56	183	117
CJBDT-20/20-6T	CBDT-20/20-6T	970		14,00		5,50	14300	68	70	247	151
CJBDT-20/20-6/12T	CBDT-20/20-6/12T	970 / 480		13,70 / 5,60		5,50 / 1,00	14300 / 9700	68 / 55	70 / 57	255	159
CJBDT-22/22-6T	CBDT-22/22-6T	960		18,40	10,60	7,50	18050	69	71	309	190
CJBDT-22/22-6/12T	CBDT-22/22-6/12T	970 / 480		19,00 / 8,00		7,50 / 1,40	18050 / 11800	69 / 56	71 / 58	319	200



## Erp. Características del punto de máxima eficiencia (BEP)

<b>MC</b>	Categoría de medición	<b>ηe[%]</b>	Eficiencia
<b>EC</b>	Categoría de eficiencia	<b>N</b>	Grado de eficiencia
<b>S</b>	Estática	<b>[kW]</b>	Potencia eléctrica
<b>T</b>	Total	<b>[m³/h]</b>	Caudal
<b>VSD</b>	Variador de velocidad	<b>[mmH₂O]</b>	Presión estática o total (Según EC)
<b>SR</b>	Relación específica	<b>[RPM]</b>	Velocidad

Modelo	MC	EC	VSD	SR	ηe[%]	N	(kW)	(m³/h)	(mmH₂O)	(RPM)
CBDT-9/9-4T	A	S	NO	1,00	26,2%	34,0	0,588	1568	36,26	1453
CBDT-9/9-4/8T	A	S	NO	1,00	26,0%	33,7	0,596	1580	36,14	1465
CBDT-9/9-4M	A	S	NO	1,00	25,7%	33,4	0,598	1561	36,32	1447
CBDT-9/9-6T	A	S	NO	1,00	25,9%	37,2	0,165	1112	14,14	953
CBDT-9/9-6M	A	S	NO	1,00	25,4%	36,6	0,167	1098	14,23	942
CBDT-10/10-4T	A	S	NO	1,00	35,2%	42,1	0,808	2097	47,28	1437
CBDT-10/10-4/8T	A	S	NO	1,00	35,1%	42,0	0,814	2120	47,03	1453
CBDT-10/10-4M	A	S	NO	1,00	35,0%	41,9	0,811	2085	47,40	1429
CBDT-10/10-6T	A	S	NO	1,00	32,1%	42,5	0,225	1393	19,03	938
CBDT-10/10-6M	A	S	NO	1,00	31,7%	42,1	0,226	1370	19,22	923
CBDT-12/12-6T-1	A	S	NO	1,00	34,9%	42,1	0,728	3087	30,42	966
CBDT-12/12-6/12T-1	A	S	NO	1,00	34,8%	42,0	0,727	3078	30,45	963
CBDT-12/12-6M-1	A	S	NO	1,00	34,7%	41,9	0,723	3051	30,53	955
CBDT-12/12-6T-1,5	A	S	NO	1,00	35,4%	42,2	0,877	3723	30,11	973
CBDT-12/12-6/12T-1,5	A	S	NO	1,00	35,4%	42,1	0,877	3714	30,14	970
CBDT-12/12-6M-1,5	A	S	NO	1,00	35,3%	42,1	0,870	3676	30,28	960
CBDT-15/15-6T	A	S	NO	1,00	39,5%	43,9	2,101	5911	51,34	967
CBDT-15/15-6/12T	A	S	NO	1,00	38,7%	43,0	2,129	5870	51,37	960
CBDT-18/18-6T	A	S	NO	1,01	39,8%	42,1	4,421	9715	66,29	979
CBDT-18/18-6/12T	A	S	NO	1,01	39,6%	41,9	4,429	9673	66,39	974
CBDT-20/20-6T	A	S	NO	1,01	44,7%	46,6	5,208	9157	92,71	984
CBDT-20/20-6/12T	A	S	NO	1,01	43,8%	45,7	5,298	9126	92,73	980
CBDT-22/22-6T	A	S	NO	1,01	47,1%	47,8	7,827	13228	102,71	969
CBDT-22/22-6/12T	A	S	NO	1,01	46,1%	46,8	8,035	13333	102,54	977

## Características acústicas

Los valores indicados, se determinan mediante medidas de nivel de presión y potencia sonora en dB(A) obtenidas en campo libre a una distancia equivalente a dos veces la envergadura del ventilador más el diámetro de la hélice, con un mínimo de 1,5 mts.

Espectro de potencia sonora Lw(A) en dB(A) por banda de frecuencia en Hz

Modelo CDBT	63	125	250	500	1000	2000	4000	8000	Modelo CJBDT	63	125	250	500	1000	2000	4000	8000
9/9-4	46	56	64	68	73	72	69	61	9/9-4	51	66	70	69	68	65	65	55
9/9-6	43	54	59	66	67	67	62	56	9/9-6	47	62	66	65	64	61	61	51
9/9-8	34	45	51	57	60	59	55	48	9/9-8	44	51	57	57	54	50	53	48
10/10-4	48	58	66	70	75	74	71	63	10/10-4	54	69	73	72	71	68	68	58
10/10-6	46	57	62	69	70	70	65	59	10/10-6	50	65	69	68	67	64	64	54
10/10-8	36	47	53	59	62	61	57	50	10/10-8	47	54	60	60	57	53	56	51
12/12-6-1	47	58	63	70	71	71	66	60	12/12-6-1	51	66	70	69	68	65	65	55
12/12-6-1,5	49	60	65	72	73	73	68	62	12/12-6-1,5	52	67	71	70	69	66	66	56
12/12-12-1	34	45	51	57	60	59	55	48	12/12-12-1	45	52	58	58	55	51	54	49
12/12-12-1,5	46	53	59	59	56	52	55	50	12/12-12-1,5	46	53	59	59	56	52	55	50
15/15-6	63	72	74	76	71	70	64	55	15/15-6	63	72	74	76	71	70	64	55
15/15-12	51	54	63	60	58	60	60	48	15/15-12	51	54	63	60	58	60	60	48
18/18-6	64	74	76	78	73	72	66	57	18/18-6	64	74	76	78	73	72	66	57
18/18-12	53	56	65	62	60	62	62	50	18/18-12	53	56	65	62	60	62	62	50
20/20-6	67	77	79	80	76	74	69	60	20/20-6	67	77	79	80	76	74	69	60
20/20-12	55	59	68	65	63	65	64	53	20/20-12	55	59	68	65	63	65	64	53
22/22-6	69	79	81	83	78	77	71	62	22/22-6	69	79	81	83	78	77	71	62
22/22-12	58	61	70	67	65	67	67	55	22/22-12	58	61	70	67	65	67	67	55

## Dimensiones mm

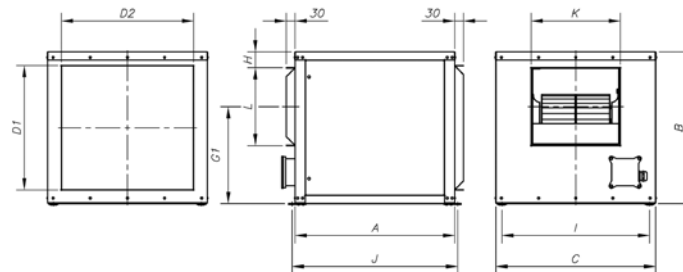

	A	B	C	D1	D2	G1	H	I	J	K	L
CJBDT-9/9	550	522	550	428	456	333,5	54,5	509	570	308	268
CJBDT-10/10	600	575	600	480	505	361,5	65,5	559	620	334	296
CJBDT-12/12	650	650	700	555	605	418	57,5	659	670	395	349
CJBDT-15/15	755	755	800	660	705	485	64	759	775	478	412
CJBDT-18/18	1000	900	1000	804	904	585	69,5	934	1041	550	491
CJBDT-20/20	1200	1175	1100	1070	1000	701	167,5	1040	1247	610	613
CJBDT-22/22	1280	1250	1250	1154	1154	739,5	158,8	1190	1327	664	704

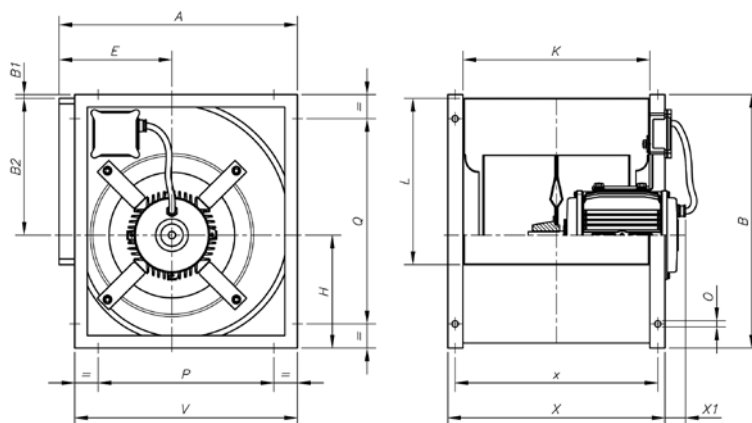

Situación caja de bornes:

CBDT-9/9  
10/10  
12/12  
15/15

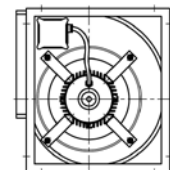

CBDT-18/18  
20/20  
22/22

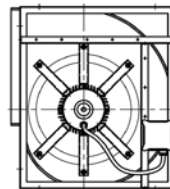

	A	B	B1	B2	E	H	K	L	P	Q	V	X	X1	x	O
CBDT-9/9	390	402	1,5	218	183	181	300	263	280	280	358	360	49	332	9x17
CBDT-10/10	430	448	2	246	202	204	326	292	326	326	398	388	33	360	9x17
CBDT-12/12	501	534	4	290	230	239,5	387	342	384	384	470	448	57	420	9x17
CBDT-15/15	584	630	-	348	265	280	473	405	460	460	550	535	58	507	9x17
CBDT-18/18	694	756	4	415	323	336	540	482	553	608	665	600	85	570	9x17
CBDT-20/20	839	935	6	523	372	406	602	604	595	735	795	682	58	642	12
CBDT-22/22	907	1019	6	571	399	442	655	695	663	819	863	735	105	695	12

Curvas características

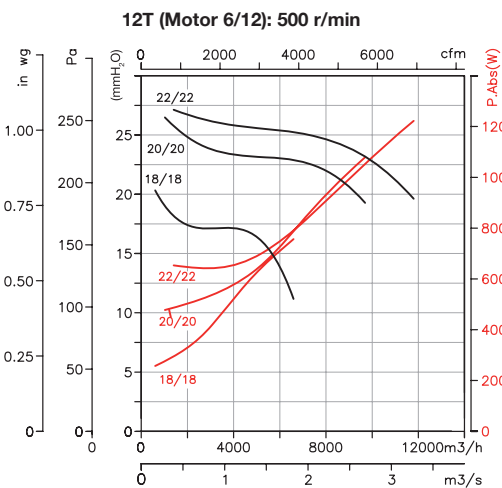
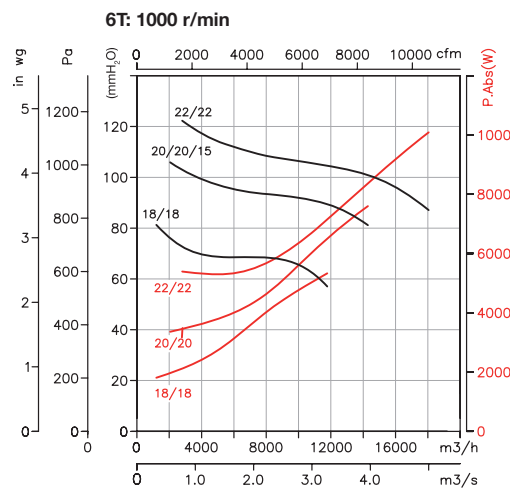
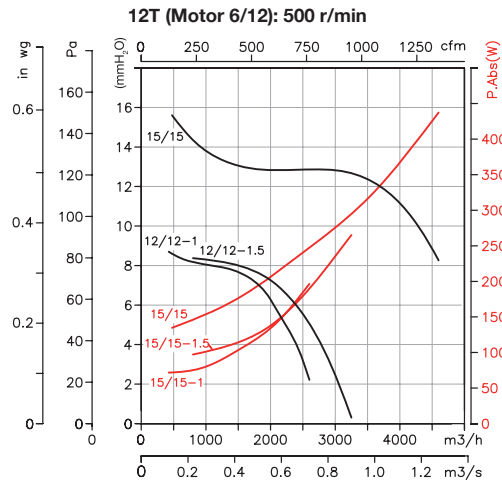
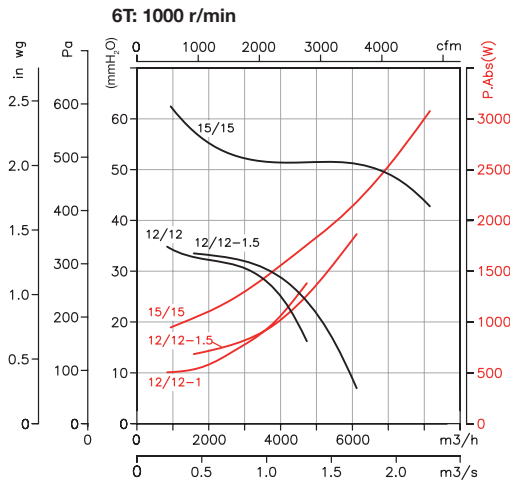
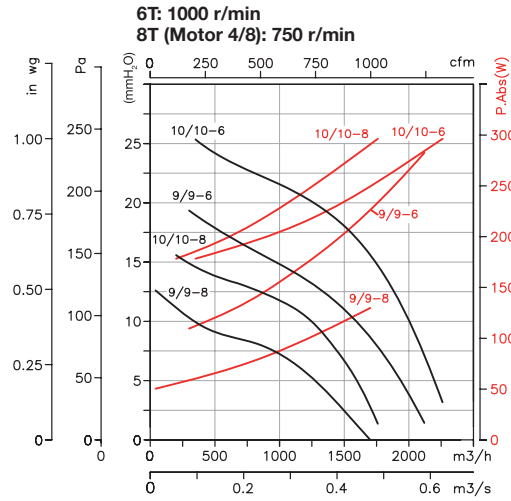
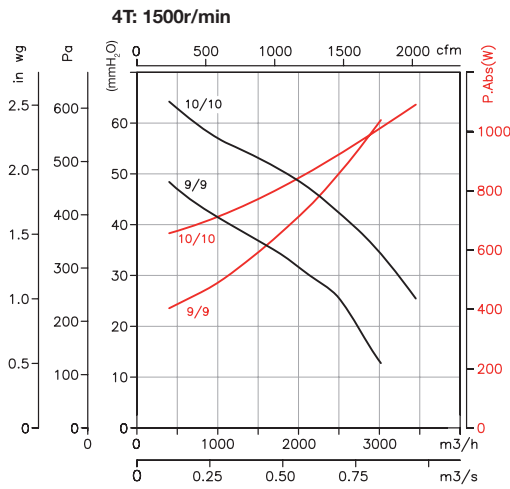

Accesorios

Ver apartado accesorios



# TCR



## Extractores centrífugos 400°C/2h y 300°C/2h, con turbina a reacción

Extractores centrífugos para trabajar inmersos en zonas de riesgo de incendios 400°C/2h, de media presión y simple aspiración, de gran robustez, equipados con turbina con álabes hacia atrás



Turbina a reacción de alto rendimiento, y gran robustez

### Ventilador:

- Envoltorio en chapa de acero
- Turbina con álabes a reacción, en chapa de acero de gran robustez, con pintura anticorrosiva
- Homologación según norma EN 12101-3:2002/AC:2006, con certificación N°: 0370-CPR-0384

### Motor:

- Motores clase H, uso continuo S1 y uso emergencia S2, con rodamientos a bolas, protección IP55
- Trifásicos 230/400V.-50Hz.(hasta 4CV.) y 400/690V.-50Hz.(potencias superiores a 4CV.)
- Temperatura máxima del aire a transportar: Servicio S1 -20°C+ 120°C en continuo, Servicio S2 300°C/2h, 400°C/2h

### Acabado:

- Anticorrosivo en resina de poliéster polimerizada a 190 °C, previo desengrase con tratamiento nanotecnológico libre de fosfatos.

### Bajo demanda:

- Extractores con motor de 200°C/2h de 1 ó 2 velocidades

## Código de pedido

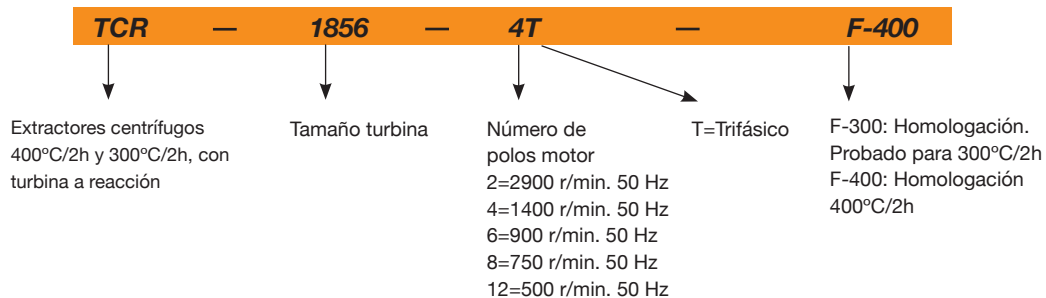

## Orientaciones

Suministro standard LG 270



## Características técnicas

Modelo	Velocidad (r/min)	Intensidad máxima admisible (A)			Potencia instalada (kW)	Caudal máximo (m³/h)	Nivel presión sonora dB(A)	Peso aprox. (Kg)
		230V	400V	690V				
TCR-1240-4T	1430	3,80	2,20		0,75	5800	71	76
TCR-1445-4T	1420	4,70	2,70		1,10	8030	72	98
TCR-1650-4T	1425	6,60	3,80		1,50	10500	74	118
TCR-1650-6T	940	4,40	2,60		0,75	7410	64	118
TCR-1856-4T	1430	11,40	6,60		3,00	15150	79	158
TCR-1856-6T	945	6,40	3,70		1,10	10050	70	150
TCR-2063-4T	1430		11,50	6,64	5,50	24450	80	257
TCR-2063-6T	945	7,40	4,30		1,50	16100	71	212
TCR-2271-4T	1455		23,00	13,28	11,00	34610	85	380
TCR-2271-6T	945	15,00	8,70		3,00	22750	76	313



**Erp. Características del punto de máxima eficiencia (BEP)**

<b>MC</b>	Categoría de medición	<b>ηe[%]</b>	Eficiencia
<b>EC</b>	Categoría de eficiencia	<b>N</b>	Grado de eficiencia
<b>S</b>	Estática	<b>[kW]</b>	Potencia eléctrica
<b>T</b>	Total	<b>[m³/h]</b>	Caudal
<b>VSD</b>	Variador de velocidad	<b>[mmH₂O]</b>	Presión estática o total (Según EC)
<b>SR</b>	Relación específica	<b>[RPM]</b>	Velocidad

Modelo	MC	EC	VSD	SR	ηe[%]	N	(kW)	(m³/h)	(mmH₂O)	(RPM)
TCR-1240-4T	A	S	NO	1,00	45,7%	58,5	0,608	2924	34,89	1461
TCR-1445-4T	A	S	NO	1,01	50,2%	60,4	1,065	3883	50,49	1442
TCR-1650-4T	A	S	NO	1,01	50,7%	58,7	1,759	5378	60,90	1437
TCR-1650-6T	A	S	NO	1,00	45,5%	58,3	0,592	4109	24,02	969
TCR-1856-4T	A	S	NO	1,01	54,3%	59,4	3,277	8342	78,29	1440
TCR-1856-6T	A	S	NO	1,00	48,4%	58,7	1,054	5632	33,24	963
TCR-2063-4T	B	T	NO	1,01	70,5%	72,4	6,537	13932	121,38	1432
TCR-2063-6T	A	S	NO	1,00	56,7%	64,2	1,930	9620	41,77	948
TCR-2271-4T	B	T	NO	1,01	69,9%	69,6	13,078	22380	149,81	1455
TCR-2271-6T	B	T	NO	1,01	57,4%	61,5	4,069	15016	57,11	945

**Características acústicas**

Los valores indicados, se determinan mediante medidas de nivel de presión y potencia sonora en dB(A) obtenidas en campo libre a una distancia equivalente a dos veces la envergadura del ventilador más el diámetro de la turbina, con un mínimo de 1,5 mts.

Espectro de potencia sonora Lw(A) en dB(A) por banda de frecuencia en Hz

Modelo	63	125	250	500	1000	2000	4000	8000	Modelo	63	125	250	500	1000	2000	4000	8000
1240	56	70	76	79	79	80	70	59	1856-6	61	69	81	83	80	81	71	60
1445	59	72	78	83	80	83	78	64	2063-4	80	85	91	93	91	88	81	73
1650-4	64	74	82	84	83	85	76	66	2063-6	69	70	82	82	81	83	73	63
1650-6	53	65	72	77	73	69	62	54	2271-4	83	84	93	96	98	99	95	82
1856-4	69	78	91	87	90	91	85	71	2271-6	73	73	87	86	90	90	79	68

**Dimensiones mm**

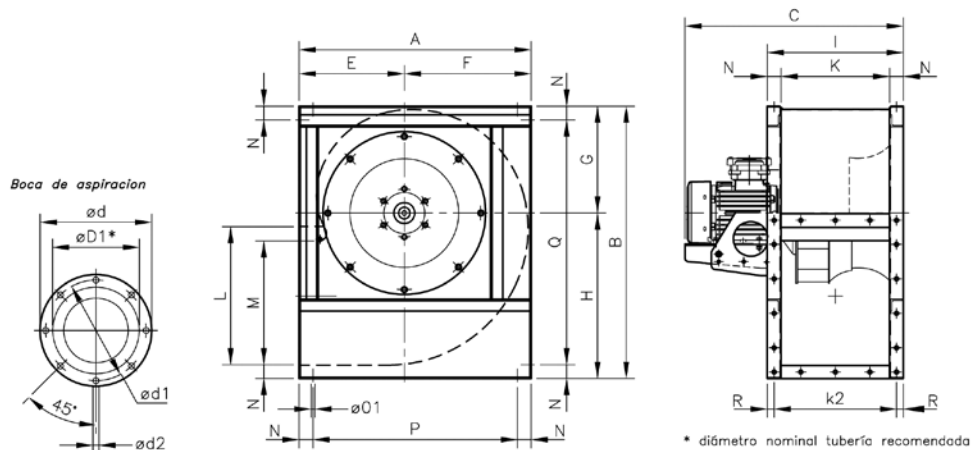

Modelo	A	B	C	ØD1*	Ød	Ød1	Ød2	E	F	G	H	M	N	Ø01	P	Q	R
1240-4T	673	790	634	400	472	444	M.8	305	368	310	480	358.5	40	11	593	710	20
1445-4T	765	880	727	450	522	494	M.8	350	415	339	541	407	45	11	675	790	20
1650-4T	832	970	770.5	500	582	555	M.10	375	457	378	592	445	45	13	742	880	20
1650-6T	832	970	770.5	500	582	555	M.10	375	457	378	592	445	45	13	742	880	20
1856-4T	925	1084	857.5	560	645	615	M.10	415	510	424	660	493	50	13	825	984	25
1856-6T	925	1084	828	560	645	615	M.10	415	510	424	660	493	50	13	825	984	25
2063-4T	1037	1218	955	630	720	688	M.10	465	572	477	741	530	60	13	917	1098	30
2063-6T	1037	1218	932	630	720	688	M.10	465	572	477	741	530	60	13	917	1098	30
2271-4T	1173	1375	1149	710	800	768	M.12	525	648	538	837	603.5	65	13	1043	1245	32.5
2271-6T	1173	1375	1112	710	800	768	M.12	525	648	538	837	603.5	65	13	1043	1245	32.5



**Dimensiones mm**

Boca de Impulsión

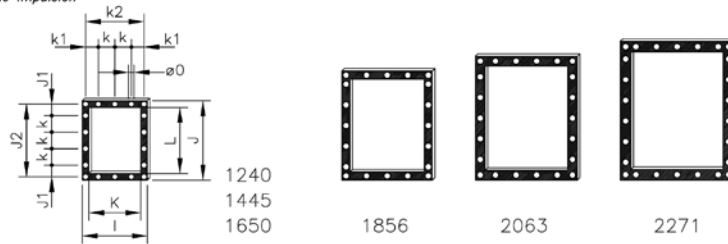

Modelo	I	J	J1	J2	K	k	k1	k2	L	Ø0
1240	395	480	70	440	315	100	77.5	355	400	11
1445	445	540	99	498	355	100	102.5	405	450	11
1650	490	590	87.5	550	400	125	100	450	500	13
1856	550	660	55	610	450	125	125	500	560	13
2063	620	750	95	690	500	125	92.5	560	630	13
2271	690	840	75	775	560	125	62.5	625	710	13

**Curvas características**

Q= Caudal en m³/h, m³/s y cfm.

Pe= Presión estática en mmH2O, Pa e inwg.

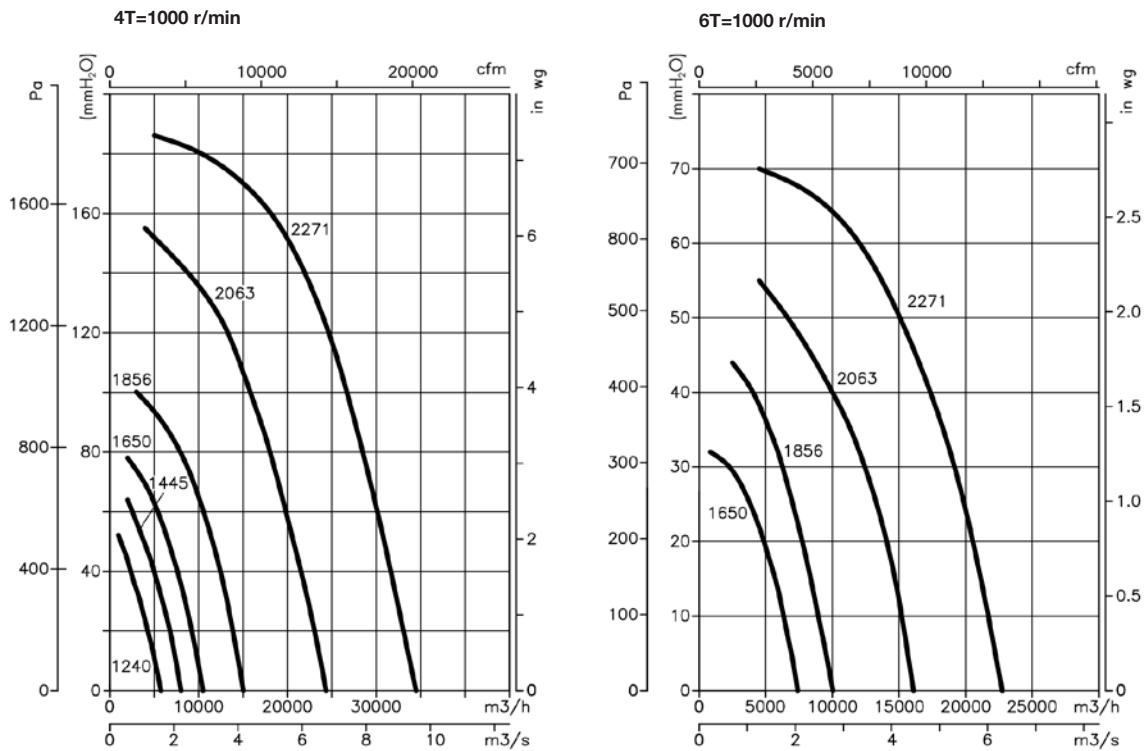

**Accesorios**

Ver apartado accesorios



# CTMP



Turbina multipala de alto rendimiento y núcleos de gran robustez

## Extractores centrífugos 400°C/2h y 300°C/2h, con turbina multipala

Extractores centrífugos para trabajar inmersos en zonas de riesgo de incendios 400°C/2h, de media presión y simple aspiración con envolvente y turbina en chapa de acero

**Ventilador:**

- Envolverte en chapa de acero
- Turbina con álabes hacia delante, en chapa de acero galvanizado
- Homologación según norma EN 12101-3:2002/AC:2006, con certificación N°: 0370-CPR-0397

**Motor:**

- Motores clase H, uso continuo S1 y uso emergencia S2, con rodamientos a bolas, protección IP55
- Trifásicos 230/400V.-50Hz.(hasta 4CV.) y 400/690V.-50Hz.(potencias superiores a 4CV.)
- Temperatura máxima del aire a transportar: Servicio S1 -20°C+ 120°C en continuo, Servicio S2 300°C/2h, 400°C/2h

**Acabado:**

- Anticorrosivo en resina de poliéster polimerizada a 190 °C, previo desengrase con tratamiento nanotecnológico libre de fosfatos.

**Bajo demanda:**

- Extractores con motor de 2 velocidades



### Código de pedido

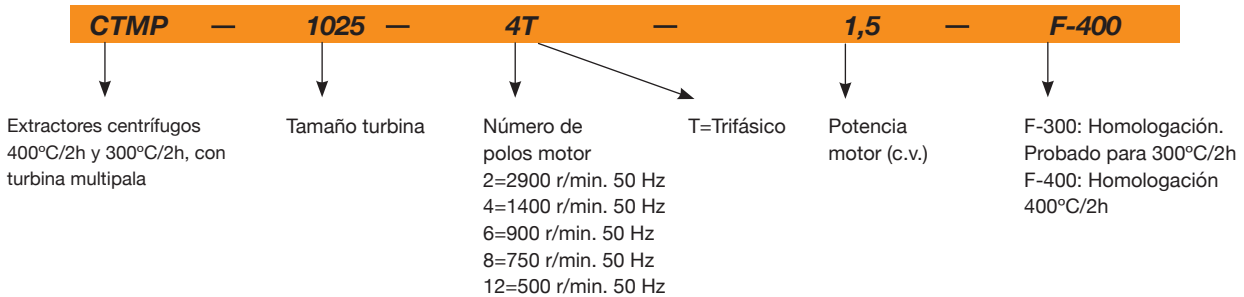

### Características técnicas

Modelo	Velocidad (r/min)	Intensidad máxima admisible (A)			Potencia instalada (kW)	Caudal máximo (m³/h)	Nivel presión sonora dB(A)	Peso aprox. (Kg)
		230V	400V	690V				
CTMP-922-4T	1430	3,80	2,20		0,75	2450	66	30
CTMP-1025-4T-1,5	1420	4,70	2,70		1,10	3385	70	36
CTMP-1025-4T-2	1425	6,60	3,80		1,50	3650	72	38
CTMP-1128-4T-3	1435	9,20	5,30		2,20	5005	74	47
CTMP-1128-4T-4	1430	11,40	6,60		3,00	5450	75	51
CTMP-1128-6T	940	4,40	2,60		0,75	3300	60	41
CTMP-1231-4T-3	1435	9,20	5,30		2,20	4740	73	54
CTMP-1231-4T-4	1430	11,40	6,60		3,00	5910	75	59
CTMP-1231-4T-5,5	1440		8,40	4,85	4,00	6850	77	69
CTMP-1231-6T	945	7,40	4,30		1,50	5115	64	55
CTMP-1435-6T	950	10,30	5,90		2,20	6400	68	70
CTMP-1640-6T	950	10,30	5,90		2,20	8105	71	89
CTMP-1845-6T	950	10,30	5,90		2,20	7500	77	98
CTMP-2050-6T	970		11,00	6,35	4,00	11000	79	152



**Erp. Características del punto de máxima eficiencia (BEP)**

<b>MC</b>	Categoría de medición	<b>ηe[%]</b>	Eficiencia
<b>EC</b>	Categoría de eficiencia	<b>N</b>	Grado de eficiencia
<b>S</b>	Estática	<b>[kW]</b>	Potencia eléctrica
<b>T</b>	Total	<b>[m³/h]</b>	Caudal
<b>VSD</b>	Variador de velocidad	<b>[mmH₂O]</b>	Presión estática o total (Según EC)
<b>SR</b>	Relación específica	<b>[RPM]</b>	Velocidad

Modelo	MC	EC	VSD	SR	ηe[%]	N	(kW)	(m³/h)	(mmH₂O)	(RPM)
CTMP-922-4T	A	S	NO	1,00	34,3%	43,7	0,326	1187	34,59	1479
CTMP-1025-4T-1,5	A	S	NO	1,01	35,5%	43,5	0,553	1501	48,06	1470
CTMP-1025-4T-2	A	S	NO	1,01	35,9%	43,8	0,572	1541	48,88	1479
CTMP-1128-4T-3	A	S	NO	1,01	37,4%	43,5	1,086	2303	64,68	1475
CTMP-1128-4T-4	A	S	NO	1,01	40,2%	46,3	1,059	2370	65,85	1480
CTMP-1128-6T	A	S	NO	1,00	33,1%	42,1	0,386	1622	28,94	980
CTMP-1231-4T-3	A	S	NO	1,01	38,5%	43,5	1,606	2927	77,43	1463
CTMP-1231-4T-4	A	S	NO	1,01	38,1%	42,9	1,746	3143	77,62	1468
CTMP-1231-4T-5,5	A	S	NO	1,01	39,0%	43,8	1,750	3120	80,29	1479
CTMP-1231-6T	A	S	NO	1,00	35,5%	43,1	0,624	2332	34,85	983
CTMP-1435-6T	A	S	NO	1,01	37,2%	43,6	0,964	3441	38,22	983
CTMP-1640-6T	A	S	NO	1,01	41,1%	46,5	1,388	3946	53,00	976
CTMP-1845-6T	A	S	NO	1,01	44,2%	48,3	2,202	5546	64,33	962
CTMP-2050-6T	A	S	NO	1,01	33,3%	35,6	4,370	6929	77,00	975

**Características acústicas**

Los valores indicados, se determinan mediante medidas de nivel de presión y potencia sonora en dB(A) obtenidas en campo libre a una distancia equivalente a dos veces la envergadura del ventilador más el diámetro de la turbina, con un mínimo de 1,5 mts.

Espectro de potencia sonora Lw(A) en dB(A) por banda de frecuencia en Hz

Modelo	63	125	250	500	1000	2000	4000	8000	Modelo	63	125	250	500	1000	2000	4000	8000
922	41	51	62	69	73	70	68	61	1231-4-4	53	62	73	80	84	82	80	73
1025-4-1,5	45	55	66	73	77	74	72	65	1231-4-5,5	55	64	75	82	86	84	82	75
1025-4-2	47	57	68	75	79	76	74	67	1231-6	42	51	62	69	73	71	69	62
1128-4-3	49	59	70	77	81	78	76	69	1435	46	55	66	73	77	75	73	66
1128-4-4	50	60	71	78	82	79	77	70	1640	49	58	69	76	80	78	76	69
1128-6	35	45	56	63	67	64	62	55	1845	56	66	77	84	88	86	84	76
1231-4-3	51	60	71	78	82	80	78	71	2050	58	68	79	86	90	88	86	78

**Dimensiones mm**

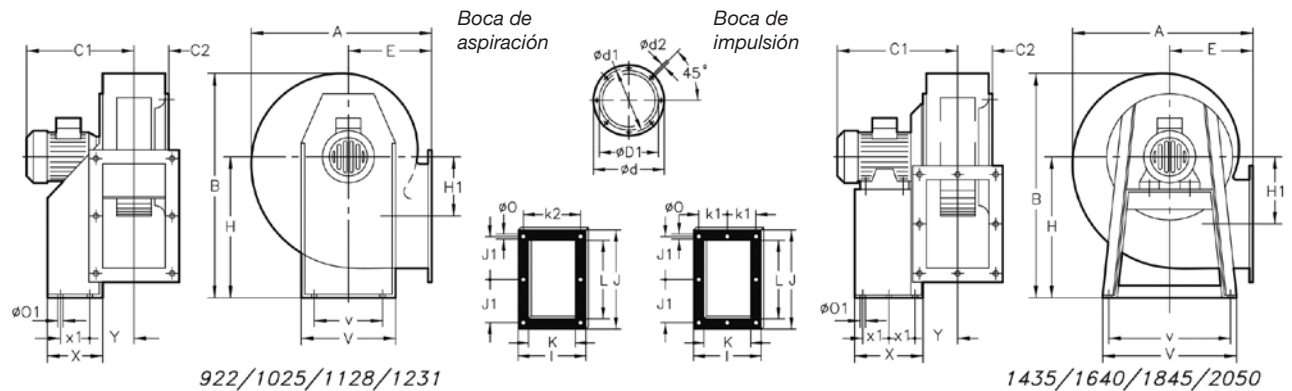

Modelo	A	B	C1	C2	ØD1*	Ød	Ød1	Ød2	E	H	H1	I	J	J1	K	k1	k2	L	Ø0	Ø01	V	v	X	x1	Y
922	388,5	455	344	73,5	224	278	256	M.8	180	280	134	204	282,5	128	140	-	180	215	9,5	10,5	290	220	114	50	105
1025	427	503	356,5	86	250	305	282	M.8	197	310	144	229	312,5	145	165	-	205	250	9,5	12,5	315	228	134	74	115,5
1128-4T	472	553	439	93,5	280	348	320	M.8	216	340	152	244	364	170	180	-	220	296,5	9,5	12,5	348	245	144	95	122,5
1128-6T	472	553	364	93,5	280	348	320	M.8	216	340	152	244	364	170	180	-	220	296,5	9,5	12,5	348	245	144	95	122,5
1231-3	526	630	449	103,5	315	382	354	M.8	238	390	179,5	264	382,5	180	200	-	240	320	11,5	13	382	322	183	140	126
1231-4	526	630	449	103,5	315	382	354	M.8	238	390	179,5	264	382,5	180	200	-	240	320	11,5	13	382	322	183	140	126
1231-5,5	526	630	449	103,5	315	382	354	M.8	238	390	179,5	264	382,5	180	200	-	240	320	11,5	13	382	322	183	140	126
1231-6T	526	630	449	103,5	315	382	354	M.8	238	390	179,5	264	382,5	180	200	-	240	320	11,5	13	382	322	183	140	126
1435-6T	573,5	715	463	118	355	422	394	M.8	250	445	242,5	292	342,5	159	228	133	-	280	11,5	13	456	420	333	136,5	150
1640-6T	634	799	475	130	400	464	438	M.8	270	495	271	336	404	185	250	150	-	321	11,5	13	500	460	327	133,5	162,5
1845-6T	711	901	492	147	450	515	485	M.8	302	560	305	370	444	202	284	164	-	361	11,5	13	538	502	340	140	179,5
2050-6T	797	987	574,5	162,5	500	565	535	M.10	345	610	313	411	544	250	315	182,5	-	451	11,5	13	635	615	435	188	196

\* Diámetro nominal tubería recomendada

**Curvas características**

Q= Caudal en m<sup>3</sup>/h, m<sup>3</sup>/s y cfm.

Pe= Presión estática en mmH<sub>2</sub>O, Pa e inwg.

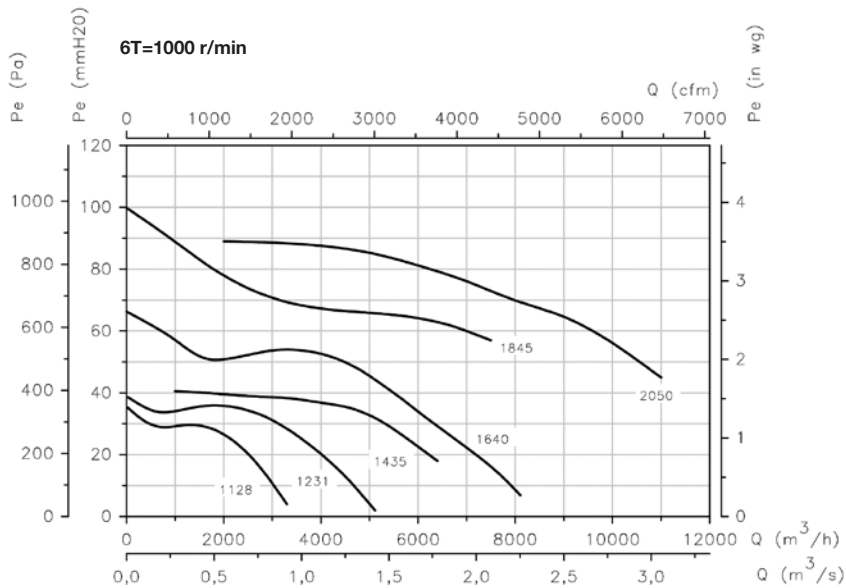
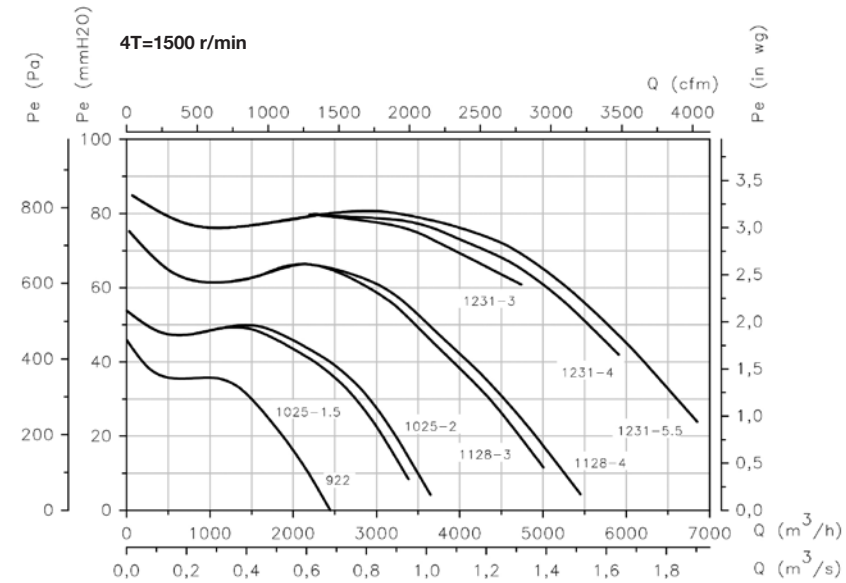

**Orientaciones**

Suministro standard LG 270

Posiciones LG 180 y RD 180 bajo demanda y con medidas de anclaje especiales.



**Accesorios**

Ver apartado accesorios





Construcción con paneles tipo sándwich para reducir la irradiación de ruidos

### Unidades de extracción 400°C/2h y 300°C/2h, con tapas intercambiables

Unidades de extracción con caja aislada acústicamente, con panel tipo sándwich, para trabajar inmersas en zonas de riesgo de incendios 400°C/2h

#### Ventilador:

- Estructura en chapa de acero galvanizado, con aislamiento térmico y acústico
- Turbina con álabes a reacción, en chapa de acero
- Tapas intercambiables para tener la impulsión en cualquiera de los laterales
- De serie se suministra con impulsión rectangular, con el accesorio TAC, puede convertirse la impulsión en circular
- Homologación según norma EN 12101-3:2002/AC:2006, con certificación N°: 0370-CPR-0398
- Dirección aire sentido lineal

#### Motor:

- Motores clase H, uso continuo S1 y uso emergencia S2, con rodamientos a bolas, protección IP55, de 1 ó 2 velocidades según modelo
- Trifásicos 230/400V.-50Hz.(hasta 4CV.) y 400/690V.-50Hz.(potencias superiores a 4CV.)
- Temperatura máxima del aire a transportar: Servicio S1 -20°C+ 40°C en continuo, Servicio S2 300°C/2h, 400°C/2h

#### Acabado:

- Anticorrosivo en chapa de acero galvanizado

#### Bajo demanda:

- Extractores con motor de 2 velocidades
- Ejecución especial para trabajo vertical



### Código de pedido

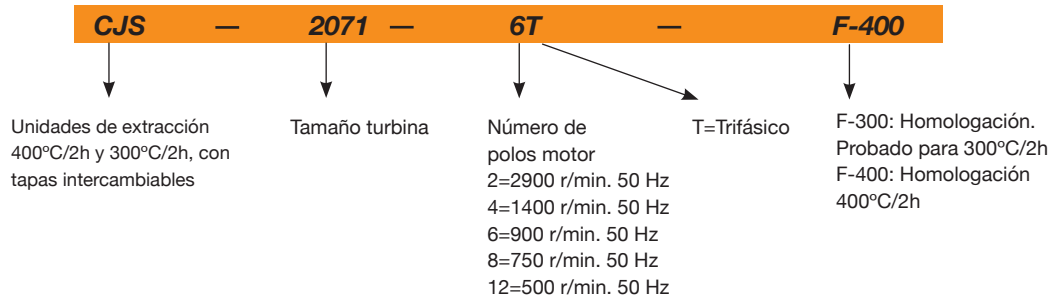

### Características técnicas

Modelo	Velocidad (r/min)	Intensidad máxima admisible (A)			Potencia instalada (kW)	Caudal máximo (m³/h)	Nivel presión sonora dB(A)	Peso aprox. (Kg)
		230V	400V	690V				
CJS-1240-6T	930	1,90	1,90		0,55	2750	59	87
CJS-1850-4T	1425	6,60	3,80		1,50	6700	70	87
CJS-1850-4/8T	1415/715		3,60 / 1,50		1,50/0,30	6700/3350	70 / 55	92
CJS-1850-6T	930	3,30	1,90		0,55	4000	60	85
CJS-2056-4T	1435	9,20	5,30		2,20	9500	72	133
CJS-2056-4/8T	1415/715		5,20 / 1,90		2,20/0,45	9500/4750	72 / 57	146
CJS-2056-6T	940	4,40	2,60		0,75	6500	62	128
CJS-2263-4T	1430		11,50	6,64	5,50	17400	74	196
CJS-2263-4/8T	1455/725		12,80 / 4,60		5,50/1,10	17400/8700	74 / 59	215
CJS-2263-6T	945	6,40	3,70		1,10	9000	64	139
CJS-2071-4T	1455		23,00	13,28	11,00	25000	83	285
CJS-2071-4/8T	1470/725		23,20 / 8,70		11,00/2,80	25000/12500	83 / 68	285
CJS-2071-6T-3	950	10,30	5,90		2,20	12500	68	156
CJS-2071-6T-5,5	970		11,00	6,35	4,00	16000	70	251
CJS-2880-6T	970		11,00	6,35	4,00	17100	71	249



## Erp. Características del punto de máxima eficiencia (BEP)

<b>MC</b>	Categoría de medición	<b><math>\eta_e</math>[%]</b>	Eficiencia
<b>EC</b>	Categoría de eficiencia	<b>N</b>	Grado de eficiencia
<b>S</b>	Estática	<b>[kW]</b>	Potencia eléctrica
<b>T</b>	Total	<b>[m³/h]</b>	Caudal
<b>VSD</b>	Variador de velocidad	<b>[mmH₂O]</b>	Presión estática o total (Según EC)
<b>SR</b>	Relación específica	<b>[RPM]</b>	Velocidad

Modelo	MC	EC	VSD	SR	$\eta_e$ [%]	N	(kW)	(m³/h)	(mmH₂O)	(RPM)
CJS-1240-6T	C	S	NO	1,00	44,5%	62,1	0,203	2636	12,58	983
CJS-1850-4T	C	S	NO	1,01	58,5%	67,2	1,317	5311	53,29	1435
CJS-1850-4/8T	C	S	NO	1,01	58,5%	67,2	1,317	5311	53,29	1427
CJS-1850-6T	C	S	NO	1,00	48,4%	62,3	0,458	3506	23,21	962
CJS-2056-4T	C	S	NO	1,01	57,3%	64,0	2,310	10049	48,37	1447
CJS-2056-4/8T	C	S	NO	1,01	61,2%	67,8	2,165	10049	48,37	1439
CJS-2056-6T	C	S	NO	1,00	54,7%	66,5	0,642	7300	17,65	966
CJS-2263-4T	C	S	NO	1,01	60,7%	64,1	4,407	10554	93,08	1437
CJS-2263-4/8T	C	S	NO	1,01	60,7%	63,6	4,407	10554	93,08	1464
CJS-2263-6T	C	S	NO	1,00	56,9%	65,1	1,510	7467	42,27	947
CJS-2071-4T	C	S	NO	1,01	63,9%	64,4	7,869	17360	106,36	1473
CJS-2071-4/8T	C	S	NO	1,01	63,9%	64,4	7,869	17360	106,36	1482
CJS-2071-6T-3	C	S	NO	1,01	57,3%	63,1	2,637	11095	49,97	954
CJS-2071-6T-5,5	C	S	NO	1,01	60,1%	64,9	3,150	13428	51,77	982
CJS-2880-6T	C	S	NO	1,01	53,7%	57,5	4,079	15923	50,52	976

\*Datos del plug fan interno

## Características acústicas

Los valores indicados, se determinan mediante medidas de nivel de presión y potencia sonora en dB(A) obtenidas en campo libre a una distancia equivalente a dos veces la envergadura del ventilador más el diámetro de la turbina, con un mínimo de 1,5 mts.

Espectro de potencia sonora Lw(A) en dB(A) por banda de frecuencia en Hz

Modelo	63	125	250	500	1000	2000	4000	8000	Modelo	63	125	250	500	1000	2000	4000	8000
1240	44	58	64	67	67	68	58	47	2263-6	61	67	72	73	77	76	69	62
1850-4	66	72	77	78	81	80	73	68	2263-8	59	64	70	72	70	67	60	52
1850-6	56	62	67	68	71	70	63	58	2271-4	80	81	89	92	95	96	92	78
1850-8	51	57	62	63	66	65	58	53	2271-6-3	65	71	76	77	81	80	73	66
2056-4	67	73	79	79	83	83	75	68	2271-6-5.5	66	65	80	79	83	83	72	61
2056-6	57	63	69	69	73	73	65	58	2271-8	65	66	74	77	80	81	77	63
2056-8	52	58	64	64	68	68	60	53	2880	68	74	79	80	84	83	76	69
2263-4	74	79	85	87	85	82	75	67									

## Dimensiones mm

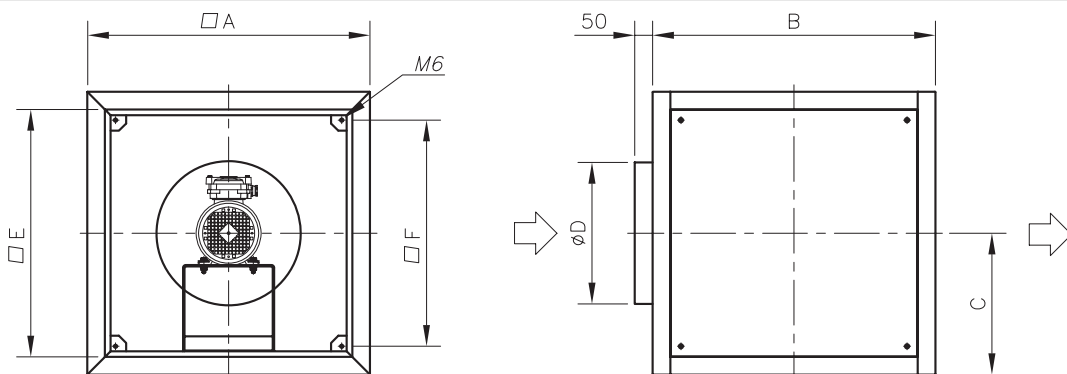

Modelo	A	B	C	D	E	F
CJS-1240-6T	800	800	400	400	700	640
CJS-1850-4T	800	800	400	400	700	640
CJS-1850-6T	800	800	400	400	700	640
CJS-2056-4T	925	925	462.5	450	825	765
CJS-2056-6T	925	925	462.5	450	825	765
CJS-2263-4T	1000	1000	500	630	900	840
CJS-2263-6T	925	925	462.5	560	825	765
CJS-2071-4T	1060	1060	530	710	960	900
CJS-2071-6T-3	1000	1000	500	630	900	840
CJS-2071-6T-5.5	1060	1060	530	710	960	900
CJS-2880-6T	1060	1060	530	710	960	900

**Curvas características**

Q= Caudal en m<sup>3</sup>/h, m<sup>3</sup>/s y cfm.

Pe= Presión estática en mmH<sub>2</sub>O, Pa e inwg.

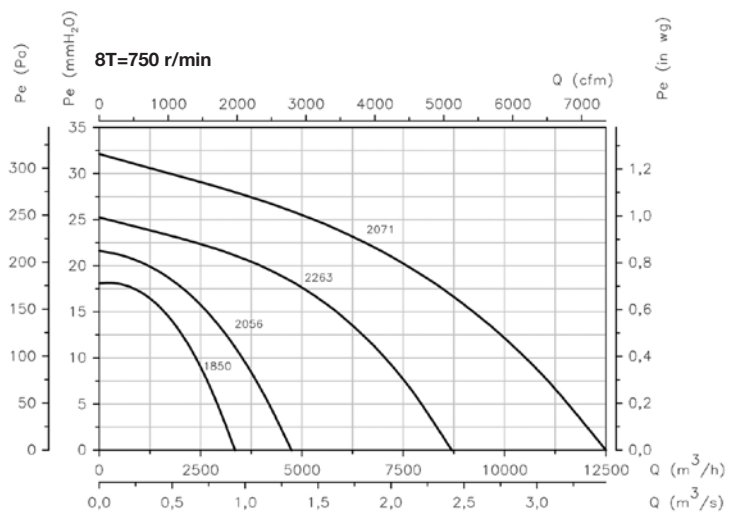
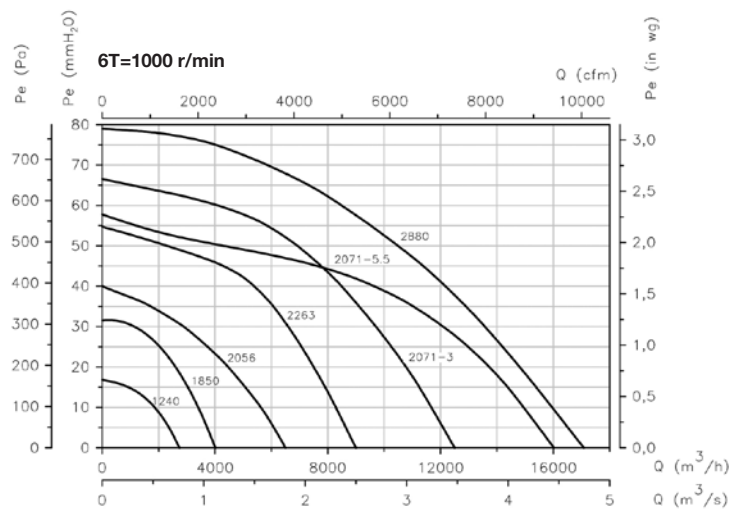
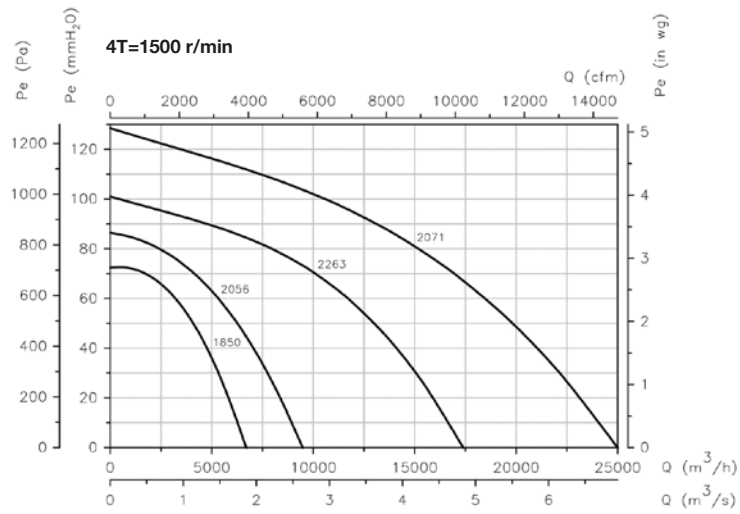

**Accesorios**

Ver apartado accesorios

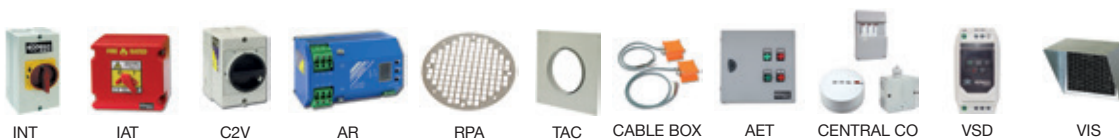

INT

IAT

C2V

AR

RPA

TAC

CABLE BOX

AET

CENTRAL CO

VSD

VIS

# CJMD

## Unidades de extracción 400°C/2h y 300°C/2h, con entrada y salida lineal



Los laterales de los modelos grandes, construidos con pliegues para asegurar su robustez

Unidades de extracción con caja aislada acústicamente, para trabajar inmersas en zonas de riesgo de incendios 400°C/2h

**Ventilador:**

- Estructura en chapa de acero galvanizado, con aislamiento térmico y acústico
- Turbina con álabes a reacción y multipala en chapa de acero
- Homologación según norma EN 12101-3:2002/AC:2006, con certificación N°: 0370-CPR-0399
- Dirección aire sentido lineal

**Motor:**

- Motores clase H, uso continuo S1 y uso emergencia S2, con rodamientos a bolas, protección IP55
- Trifásicos 230/400V.-50Hz.(hasta 4CV.) y 400/690V.-50Hz.(potencias superiores a 4CV)
- Temperatura máxima del aire a transportar: Servicio S1 -20°C+ 40°C en continuo, Servicio S2 300°C/2h y 400°C/2h

**Acabado:**

- Anticorrosivo en chapa de acero galvanizado

**Bajo demanda:**

- Extractores con motor de 2 velocidades



### Código de pedido

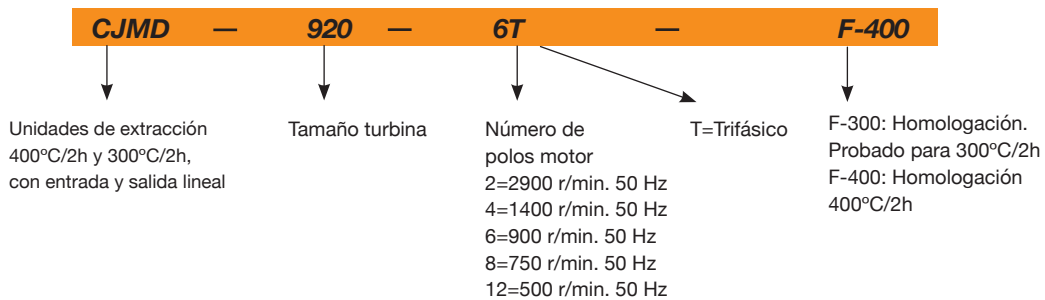

### Características técnicas

Modelo	Velocidad (r/min)	Intensidad máxima admisible (A)			Potencia instalada (kW)	Caudal máximo (m³/h)	Nivel presión sonora dB(A)	Peso aprox. (Kg)
		230V	400V	690V				
CJMD-600-4T	1430	3,80	2,20		0,75	2445	58	68
CJMD-665-4T	1420	4,70	2,70		1,10	3385	62	80
CJMD-730-4T	1435	9,20	5,30		2,20	5005	66	100
CJMD-730-6T	940	4,40	2,60		0,75	3300	52	95
CJMD-800-4T	1440		8,40	4,85	4,00	6850	69	132
CJMD-800-6T	945	7,40	4,30		1,50	5115	56	116
CJMD-825-6T	950	10,30	5,90		2,20	6400	60	146
CJMD-885-6T	950	10,30	5,90		2,20	8105	63	164
CJMD-905-4T	1430	3,80	2,20		0,75	5800	63	133
CJMD-920-6T	950	10,30	5,90		2,20	7500	69	184
CJMD-960-4T	1420	4,70	2,70		1,10	8030	64	185
CJMD-1020-4T	1425	6,60	3,80		1,50	10500	66	198
CJMD-1020-6T	940	4,40	2,60		0,75	7410	56	197
CJMD-1160-6T	970		11,00	6,35	4,00	11000	71	263
CJMD-1225-4T	1430	11,40	6,60		3,00	15150	71	279
CJMD-1225-6T	945	6,40	3,70		1,10	10050	62	274
CJMD-1330-4T	1430		11,50	6,64	5,50	24450	72	409
CJMD-1330-6T	945	7,40	4,30		1,50	16100	63	370
CJMD-1550-4T	1455		23,00	13,28	11,00	34610	77	553
CJMD-1550-6T	945	15,00	8,70		3,00	22750	68	501





**Erp. Características del punto de máxima eficiencia (BEP)**

<b>MC</b>	Categoría de medición	<b>ηe[%]</b>	Eficiencia
<b>EC</b>	Categoría de eficiencia	<b>N</b>	Grado de eficiencia
<b>S</b>	Estática	<b>[kW]</b>	Potencia eléctrica
<b>T</b>	Total	<b>[m³/h]</b>	Caudal
<b>VSD</b>	Variador de velocidad	<b>[mmH<sub>2</sub>O]</b>	Presión estática o total (Según EC)
<b>SR</b>	Relación específica	<b>[RPM]</b>	Velocidad

Modelo	MC	EC	VSD	SR	ηe[%]	N	(kW)	(m³/h)	(mmH <sub>2</sub> O)	(RPM)
CJMD-600-4T	A	S	NO	1,00	34,3%	43,7	0,326	1187	34,59	1479
CJMD-665-4T	A	S	NO	1,01	35,5%	43,5	0,553	1501	48,06	1470
CJMD-730-4T	A	S	NO	1,01	37,4%	43,5	1,086	2303	64,68	1475
CJMD-730-6T	A	S	NO	1,00	33,1%	42,1	0,386	1622	28,94	980
CJMD-800-4T	A	S	NO	1,01	39,0%	43,8	1,750	3120	80,29	1479
CJMD-800-6T	A	S	NO	1,00	35,5%	43,1	0,624	2332	34,85	983
CJMD-825-6T	A	S	NO	1,01	37,2%	43,6	0,964	3441	38,22	983
CJMD-885-6T	A	S	NO	1,01	41,1%	46,5	1,388	3946	53,00	976
CJMD-905-4T	A	S	NO	1,00	45,7%	58,5	0,608	2924	34,89	1461
CJMD-920-6T	A	S	NO	1,01	44,2%	48,3	2,202	5546	64,33	962
CJMD-960-4T	A	S	NO	1,01	50,2%	60,4	1,065	3883	50,49	1442
CJMD-1020-4T	A	S	NO	1,01	50,7%	58,7	1,759	5378	60,90	1437
CJMD-1020-6T	A	S	NO	1,00	45,5%	58,3	0,592	4109	24,02	969
CJMD-1160-6T	A	S	NO	1,01	33,3%	35,6	4,370	6929	77,00	975
CJMD-1225-4T	A	S	NO	1,01	54,3%	59,4	3,277	8342	78,29	1440
CJMD-1225-6T	A	S	NO	1,00	48,4%	58,7	1,054	5632	33,24	963
CJMD-1330-4T	B	T	NO	1,01	70,5%	72,4	6,537	13932	121,38	1432
CJMD-1330-6T	A	S	NO	1,00	56,7%	64,2	1,930	9620	41,77	948
CJMD-1550-4T	B	T	NO	1,01	69,9%	69,6	13,078	22380	149,81	1455
CJMD-1550-6T	B	T	NO	1,01	57,4%	61,5	4,069	15016	57,11	945

**Características acústicas**

Los valores indicados, se determinan mediante medidas de nivel de presión y potencia sonora en dB(A) obtenidas en campo libre a una distancia equivalente a dos veces la envergadura del ventilador más el diámetro de la turbina, con un mínimo de 1,5 mts.

Espectro de potencia sonora Lw(A) en dB(A) por banda de frecuencia en Hz

Modelo	63	125	250	500	1000	2000	4000	8000	Modelo	63	125	250	500	1000	2000	4000	8000
600-4	33	43	54	61	65	62	60	53	960-4	51	64	70	75	72	75	70	56
665-4	37	47	58	65	69	66	64	57	1020-4	56	66	74	76	75	77	68	58
730-4	41	51	62	69	73	70	68	61	1020-6	45	57	64	69	65	61	54	46
730-6	27	37	48	55	59	56	54	47	1160-6	50	60	71	78	82	80	78	70
800-4	47	56	67	74	78	76	74	67	1225-4	61	70	83	79	82	83	77	63
800-6	34	43	54	61	65	63	61	54	1225-6	53	61	73	75	72	73	63	52
825-6	38	47	58	65	69	67	65	58	1330-4	72	77	83	85	83	80	73	65
885-6	41	50	61	68	72	70	68	61	1330-6	61	62	74	74	73	75	65	55
905-4	48	62	68	71	71	72	62	51	1550-4	75	76	85	88	90	91	87	74
920-6	48	58	69	76	80	78	76	68	1550-6	65	65	79	78	82	82	71	60

**Dimensiones mm**

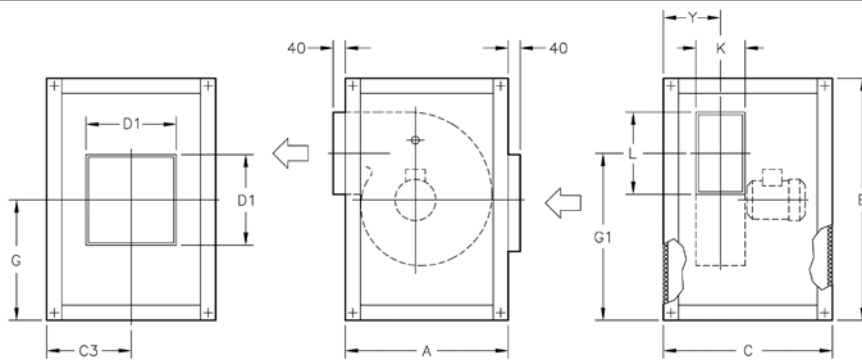

Modelo	A	B	C	C3	D1	G	G1	K	L	Y	Modelo	A	B	C	C3	D1	G	G1	K	L	Y
CJMD-600-4T	735	755	604	302	400	378	500	140	215	190	CJMD-960-4T	1060	1080	966	483	600	540	694	355	450	443
CJMD-665-4T	790	810	678	339	400	405	540	165	250	215	CJMD-1020-4T	1150	1170	1038	519	800	585	756	400	500	490
CJMD-730-4T	855	874	748	374	400	437	577	180	295	237	CJMD-1020-6T	1150	1170	1038	519	800	585	756	400	500	490
CJMD-730-6T	855	874	748	374	400	437	577	180	295	237	CJMD-1160-6T	1375	1395	1098	549	800	698	999	315	450	414
CJMD-800-4T	941	961	798	399	500	481	653	200	320	264	CJMD-1225-4T	1204	1284	1258	629	800	642	836	450	560	545
CJMD-800-6T	941	961	798	399	500	481	653	200	320	264	CJMD-1225-6T	1204	1284	1258	629	800	642	836	450	560	545
CJMD-825-6T	1039	1059	892	446	500	530	770	230	280	296	CJMD-1330-4T	1338	1418	1474	737	800	709	921	500	630	620
CJMD-885-6T	1148	1168	938	469	500	585	849	250	320	330	CJMD-1330-6T	1338	1418	1474	737	800	709	921	500	630	620
CJMD-905-4T	970	990	896	448	500	495	636	315	400	398	CJMD-1550-4T	1495	1575	1648	824	1000	788	1032	560	710	675
CJMD-920-6T	1268	1287	954	477	600	644	945	284	360	372	CJMD-1550-6T	1495	1575	1648	824	1000	788	1032	560	710	675

**Curvas características**

Q= Caudal en m<sup>3</sup>/h, m<sup>3</sup>/s y cfm.

Pe= Presión estática en mmH<sub>2</sub>O, Pa e inwg.

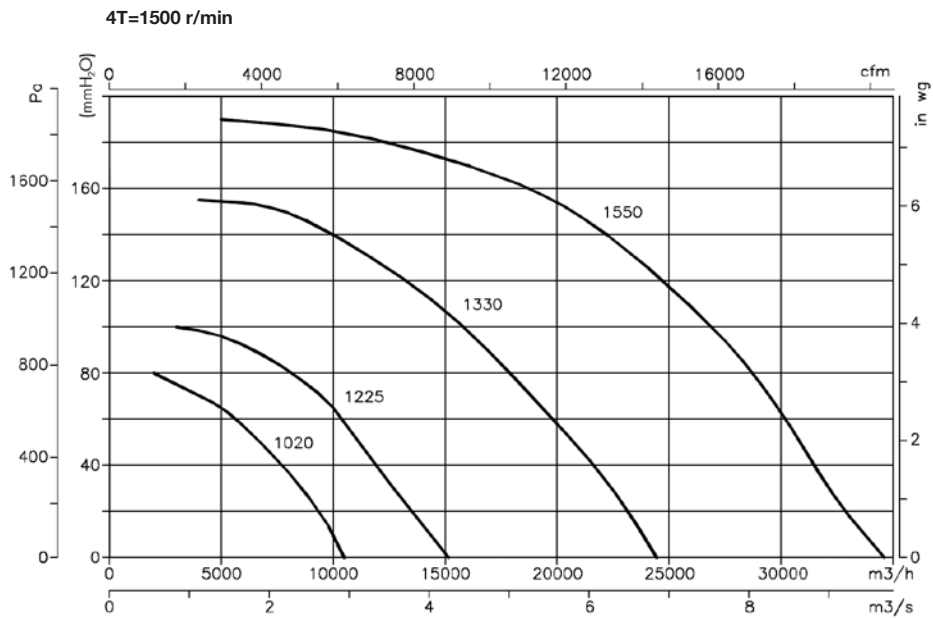
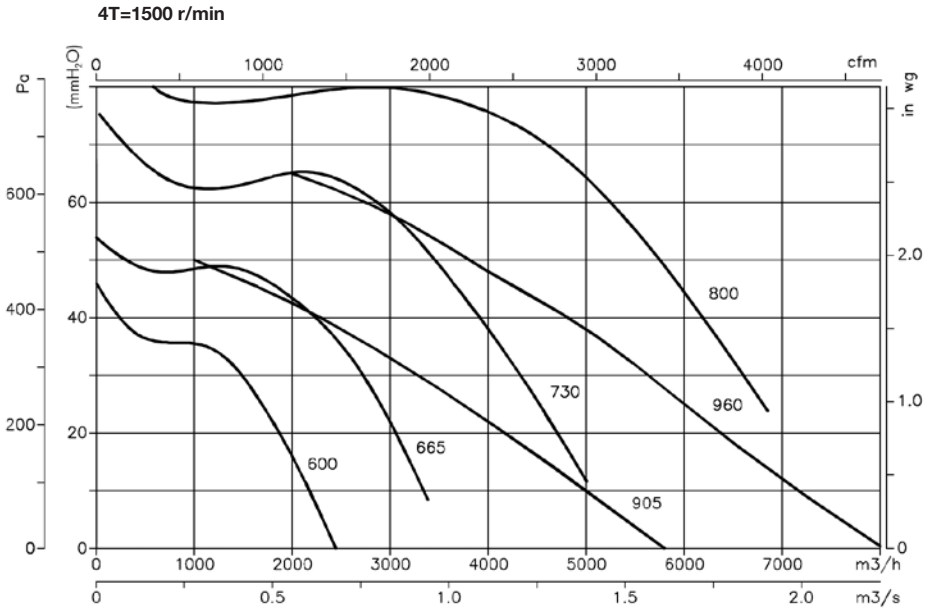

**Curvas características**

Q= Caudal en m<sup>3</sup>/h, m<sup>3</sup>/s y cfm.

Pe= Presión estática en mmH<sub>2</sub>O, Pa e inwg.

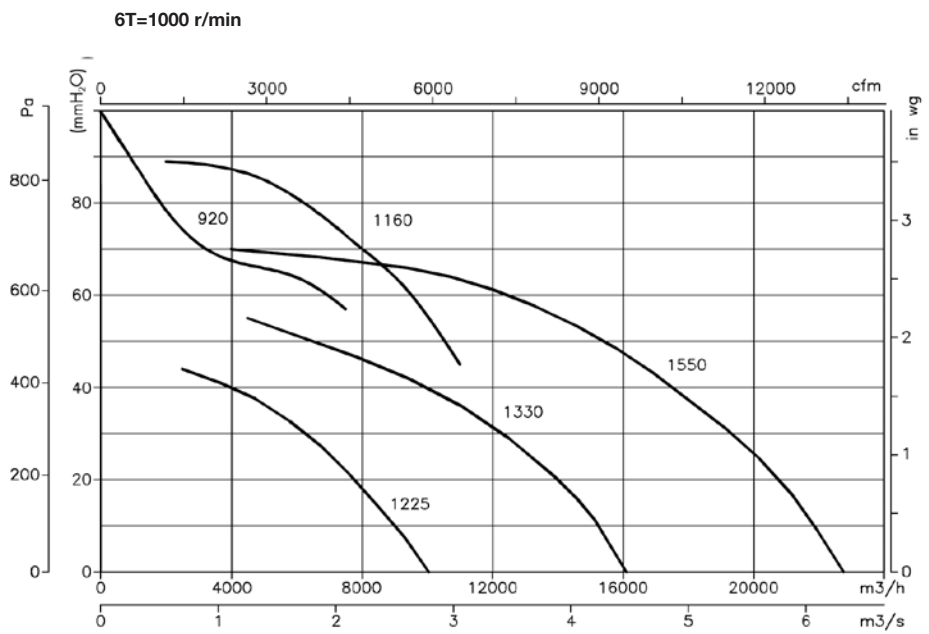
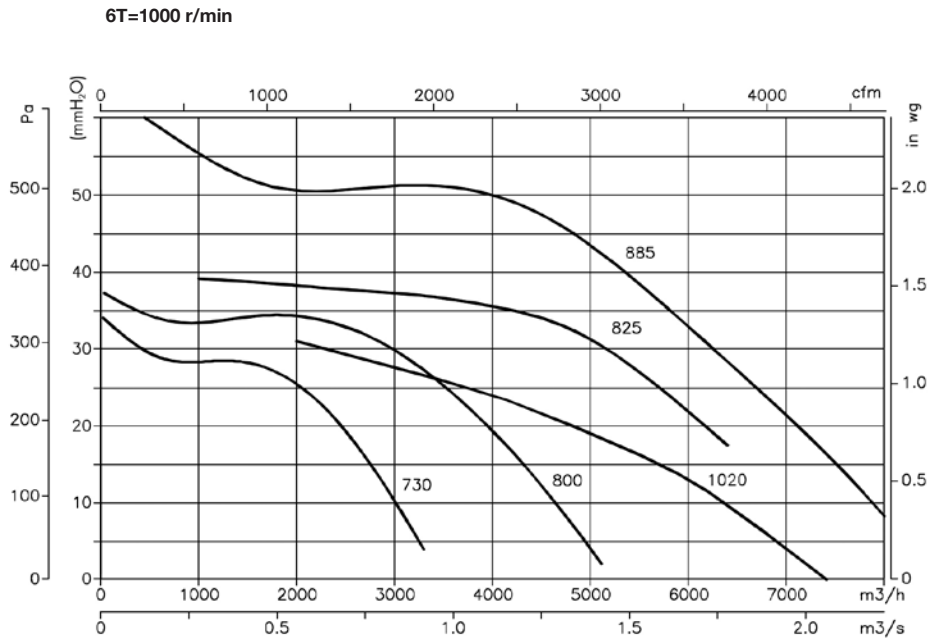

**Accesorios**

Ver apartado accesorios



# TCR/R CJTCR/R



## Extractores centrífugos y unidades de extracción 400°C/2h, con turbina a reacción

TCR/R: Extractores centrífugos 400°C/2h, para trabajar en el exterior de la zona de riesgo de incendios, de simple aspiración y gran robustez, equipados con turbina con álabes hacia atrás

CJTCR/R: Unidades de extracción 400°C/2h con caja aislada acústicamente, para trabajar en el exterior de la zona de riesgo de incendios, de simple aspiración y gran robustez



TCR/R



CJTCR/R

### Ventilador:

- Envoltente en chapa de acero
- Turbina con álabes a reacción, en chapa de acero de gran robustez, con pintura anticorrosiva
- Homologación según norma EN 12101-3:2002/AC:2006, con certificación N°: 0370-CPR-0400 (TCR/R), y N°: 0370-CPR-0401 (CJTCR/R)

### Motor:

- Motores clase F, con rodamientos a bolas, protección IP55
- Trifásicos 230/400V.-50Hz.(hasta 5,5CV) y 400/690V.-50Hz.(potencias superiores a 5,5CV)
- Temperatura máxima del aire a transportar: Servicio S1 -20°C+ 250°C en continuo, Servicio S2 200°C/2h, 300°C/2h y 400°C/2h

### Acabado:

- Anticorrosivo en resina de poliéster polimerizada a 190 °C, previo desengrase con tratamiento nanotecnológico libre de fosfatos.
- CJTCR/R: Anticorrosivo en chapa de acero galvanizado

### Bajo demanda:

- Extractores con motor de 2 velocidades
- Extractores a transmisión



Turbina a reacción de alto rendimiento, y gran robustez

## Código de pedido

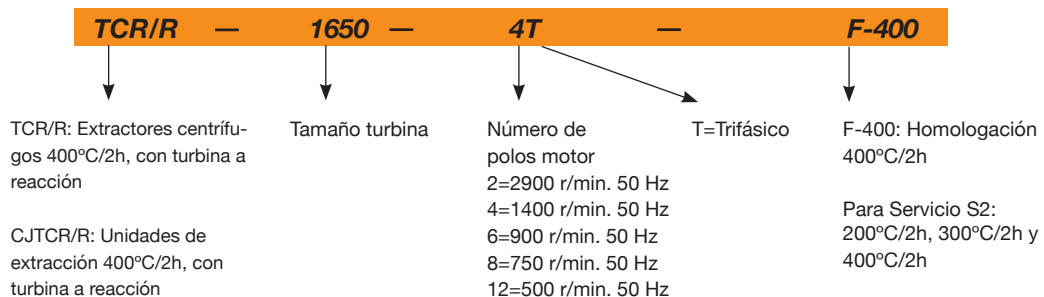

## Características técnicas

Modelo	Velocidad (r/min)	Intensidad máxima admisible (A)			Potencia instalada (kW)	Caudal máximo (m³/h)	Nivel presión sonora dB(A)		Peso aprox. (Kg)	
		230V	400V	690V			TCR/R	CJTCR/R	TCR/R	CJTCR/R
TCR/R CJTCR/R 1240-2T	2870	13,60	7,82		4,00	11100	86	81	93	147
TCR/R CJTCR/R 1240-4T	1410	3,10	1,79		0,75	5800	71	66	71	125
TCR/R CJTCR/R 1445-2T	2870		14,50	8,37	7,50	16500	87	82	126	210
TCR/R CJTCR/R 1445-4T	1400	4,03	2,32		1,10	8030	72	67	93	177
TCR/R CJTCR/R 1650-4T	1430	5,96	3,44		1,50	10500	74	68	114	189
TCR/R CJTCR/R 1650-6T	945	3,90	2,20		0,75	7410	64	59	111	186
TCR/R CJTCR/R 1856-4T	1445	10,96	6,33		3,00	15150	79	74	152	273
TCR/R CJTCR/R 1856-6T	945	4,88	2,82		1,10	10050	70	65	145	266
TCR/R CJTCR/R 2063-4T	1440		11,60	6,70	5,50	24450	80	75	225	380
TCR/R CJTCR/R 2063-6T	955	6,42	3,71		1,50	16100	71	66	209	364
TCR/R CJTCR/R 2271-4T	1460		20,20	11,66	11,00	34610	85	79	315	508
TCR/R CJTCR/R 2271-6T	960	12,70	7,30		3,00	22750	76	71	280	473



## Erp. Características del punto de máxima eficiencia (BEP)

<b>MC</b>	Categoría de medición	<b>ηe[%]</b>	Eficiencia
<b>EC</b>	Categoría de eficiencia	<b>N</b>	Grado de eficiencia
<b>S</b>	Estática	<b>[kW]</b>	Potencia eléctrica
<b>T</b>	Total	<b>[m³/h]</b>	Caudal
<b>VSD</b>	Variador de velocidad	<b>[mmH₂O]</b>	Presión estática o total (Según EC)
<b>SR</b>	Relación específica	<b>[RPM]</b>	Velocidad

Modelo	MC	EC	VSD	SR	ηe[%]	N	(kW)	(m³/h)	(mmH₂O)	(RPM)
1240-2T	A	S	NO	1,02	67,6%	71,1	4,622	6744	169,95	2871
1240-4T	A	S	NO	1,00	50,6%	63,8	0,550	2924	34,89	1448
1445-2T	A	S	NO	1,02	63,4%	64,5	7,943	8951	206,50	2879
1445-4T	A	S	NO	1,01	55,3%	66,0	0,966	3883	50,49	1428
1650-4T	A	S	NO	1,01	58,3%	66,8	1,532	5378	60,90	1441
1650-6T	A	S	NO	1,00	47,6%	60,7	0,566	4109	24,02	969
1856-4T	A	S	NO	1,01	58,8%	64,2	3,028	8342	78,29	1453
1856-6T	A	S	NO	1,00	50,4%	60,8	1,013	5632	33,24	960
2063-4T	B	T	NO	1,01	76,4%	78,7	6,032	13932	121,38	1442
2063-6T	A	S	NO	1,00	61,2%	69,0	1,790	9620	41,77	957
2271-4T	B	T	NO	1,01	75,4%	75,3	12,117	22380	149,81	1460
2271-6T	B	T	NO	1,01	65,9%	70,6	3,546	15016	57,11	960

## Características acústicas

Los valores indicados, se determinan mediante medidas de nivel de presión y potencia sonora en dB(A) obtenidas en campo libre a una distancia equivalente a dos veces la envergadura del ventilador más el diámetro de la turbina, con un mínimo de 1,5 mts.

Espectro de potencia sonora Lw(A) en dB(A) por banda de frecuencia en Hz

Modelo TCR/R	63	125	250	500	1000	2000	4000	8000	Modelo CJTCR/R	63	125	250	500	1000	2000	4000	8000
1240-2	68	83	81	93	90	94	96	83	1240-2	63	78	76	88	85	89	91	78
1240-4	56	40	76	79	79	80	70	59	1240-4	51	65	71	74	74	75	65	54
1445-2	73	85	83	95	93	97	99	89	1445-2	68	80	78	90	88	92	94	84
1445-4	59	72	78	83	80	83	78	64	1445-4	54	67	73	78	75	78	73	59
1650-4	64	74	82	84	83	85	76	66	1650-4	58	68	76	78	77	79	70	60
1650-6	53	65	72	77	73	69	62	54	1650-6	48	60	67	72	68	64	57	49
1856-4	69	78	91	87	90	91	85	71	1856-4	64	73	86	82	85	86	80	66
1856-6	61	69	81	83	80	81	71	60	1856-6	56	64	76	78	75	76	66	55
2063-4	80	85	91	93	91	88	81	73	2063-4	75	80	86	88	86	83	76	68
2063-6	69	70	82	82	81	83	73	63	2063-6	64	65	77	77	76	78	68	58
2271-4	83	84	93	96	98	99	95	82	2271-4	77	78	87	90	92	93	89	76
2271-6	73	73	87	86	90	90	79	68	2271-6	68	68	82	81	85	85	74	63

## Orientaciones

Suministro standard LG 270



Dimensiones mm

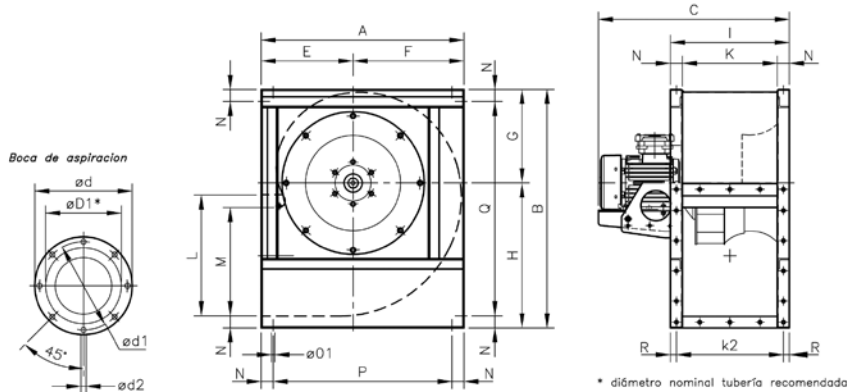

Modelo	A	B	C	ØD1*	Ød	Ød1	Ød2	E	F	G	H	I	M	N	Ø01	P	Q	R
TCR/R 1240-2T	673	790	734	400	472	444	M.8	305	368	310	480	395	358.5	40	11	593	710	20
TCR/R 1240-4T	673	790	634	400	472	444	M.8	305	368	310	480	395	358.5	40	11	593	710	20
TCR/R 1445-2T	765	880	815	450	522	494	M.8	350	415	339	541	445	407	45	11	675	790	20
TCR/R 1445-4T	765	880	727	450	522	494	M.8	350	415	339	541	445	407	45	11	675	790	20
TCR/R 1650-4T	832	970	770.5	500	582	555	M.10	375	457	378	592	490	445	45	13	742	880	20
TCR/R 1650-6T	832	970	770.5	500	582	555	M.10	375	457	378	592	490	445	45	13	742	880	20
TCR/R 1856-4T	925	1084	857.5	560	645	615	M.10	415	510	424	660	550	493	50	13	825	984	25
TCR/R 1856-6T	925	1084	828	560	645	615	M.10	415	510	424	660	550	493	50	13	825	984	25
TCR/R 2063-4T	1037	1218	955	630	720	688	M.10	465	572	477	741	620	530	60	13	917	1098	30
TCR/R 2063-6T	1037	1218	932	630	720	688	M.10	465	572	477	741	620	530	60	13	917	1098	30
TCR/R 2271-4T	1173	1375	1149	710	800	768	M.12	525	648	538	837	690	603.5	65	13	1043	1245	32.5
TCR/R 2271-6T	1173	1375	1112	710	800	768	M.12	525	648	538	837	690	603.5	65	13	1043	1245	32.5

Boca impulsión

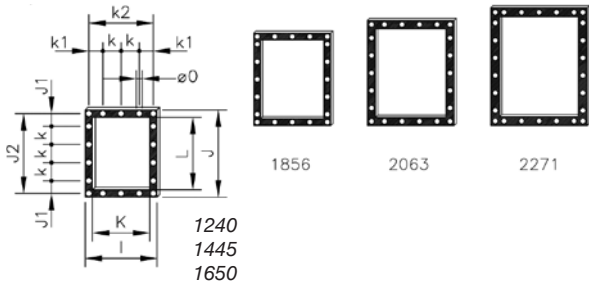

Modelo	I	J	J1	J2	K	k	k1	k2	L	Ø0
TCR/R-1240	395	480	70	440	315	100	77.5	355	400	11
TCR/R-1445	445	540	99	498	355	100	102.5	405	450	11
TCR/R-1650	490	590	87.5	550	400	125	100	450	500	13
TCR/R-1856	550	660	55	610	450	125	125	500	560	13
TCR/R-2063	620	750	95	690	500	125	92.5	560	630	13
TCR/R-2271	690	840	75	775	560	125	62.5	625	710	13

Suministro standard: LG-270

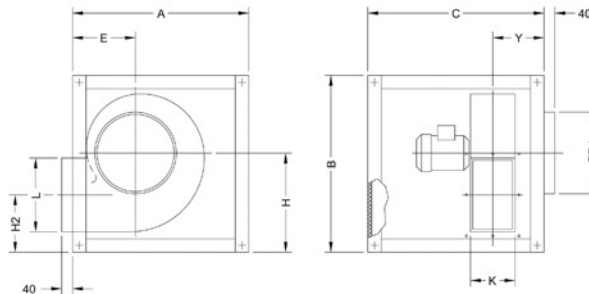

Modelo	A	B	C	ØD1	E	H	H2	K	L	Y
CJTCR/R-1240	970	970	970	400	312	549	308	315	400	307.5
CJTCR/R-1445	1070	1070	1070	450	357	610	339	355	450	333.5
CJTCR/R-1650	1160	1160	1160	500	382	660	365	400	500	355
CJTCR/R-1856	1260	1260	1050	560	422	727	399	450	560	360
CJTCR/R-2063	1400	1400	1200	630	472	810	444	500	630	395
CJTCR/R-2271	1555	1555	1355	710	532	906	560	560	715	430

## Dimensiones mm

Suministro bajo demanda: LG-0

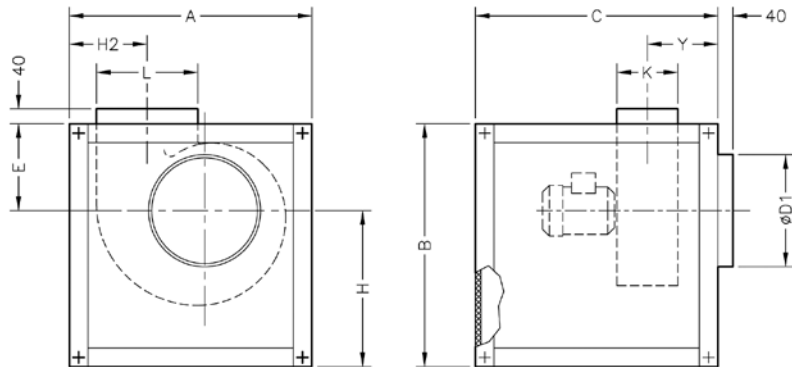

Modelo	A	B	C	ØD1	E	H	H2	K	L	Y
CJTCR/R-1240	970	970	970	400	533	437	322	315	400	307.5
CJTCR/R-1445	1070	1070	1070	450	586	484	367	355	450	333.5
CJTCR/R-1650	1160	1160	1160	500	634.5	525.5	391.5	400	500	355
CJTCR/R-1856	1260	1260	1050	560	681.5	578.5	442.5	450	560	360
CJTCR/R-2063	1400	1400	1200	630	759	641	482	500	630	395
CJTCR/R-2271	1555	1555	1355	710	838	717	518.5	560	715	430

Suministro bajo demanda: LG-90

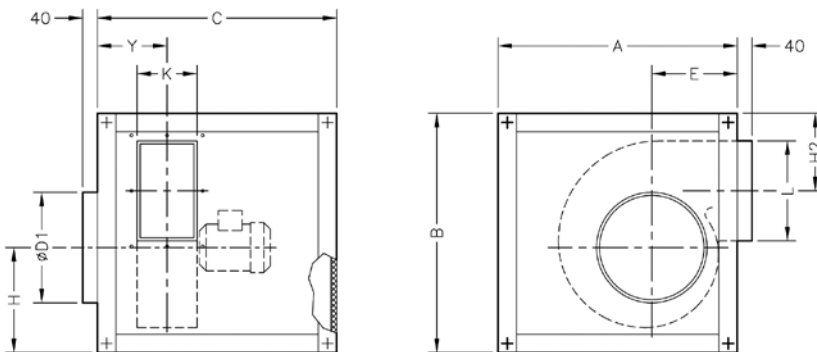

Detalle taladros boca impulsión

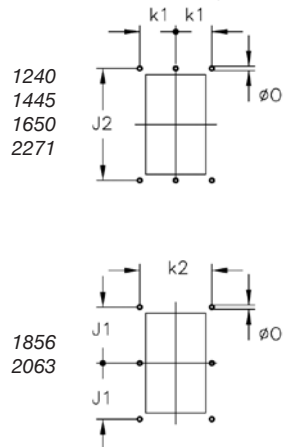

Modelo	A	B	C	ØD1	E	H	H2	K	L	Y
CJTCR/R-1240	970	970	970	400	312	379	350	315	400	307.5
CJTCR/R-1445	1070	1070	1070	450	357	408	391	355	450	333.5
CJTCR/R-1650	1160	1160	1160	500	382	447	419	400	500	355
CJTCR/R-1856	1260	1260	1050	560	422	495	438	450	560	360
CJTCR/R-2063	1400	1400	1200	630	472	546	488	500	630	395
CJTCR/R-2271	1555	1555	1355	710	532	607	532	560	715	430

Modelo	k1	k2	J1	J2	Ø0
CJTCR/R-1240	177.5	-	-	440	11
CJTCR/R-1445	202.5	-	-	498	11
CJTCR/R-1650	225	-	-	550	13
CJTCR/R-1856	-	500	305	-	13
CJTCR/R-2063	-	560	345	-	13
CJTCR/R-2271	312.5	-	-	775	13

## Curvas características

Q= Caudal en m<sup>3</sup>/h, m<sup>3</sup>/s y cfm.

Pe= Presión estática en mmH<sub>2</sub>O, Pa e in.wg.

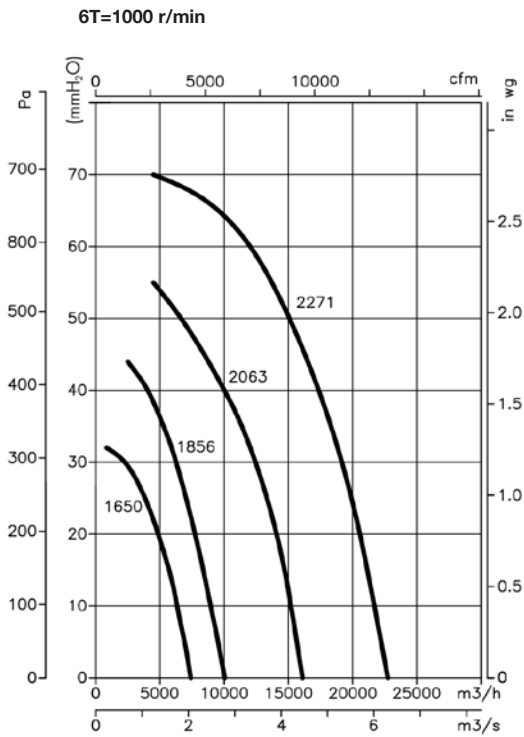
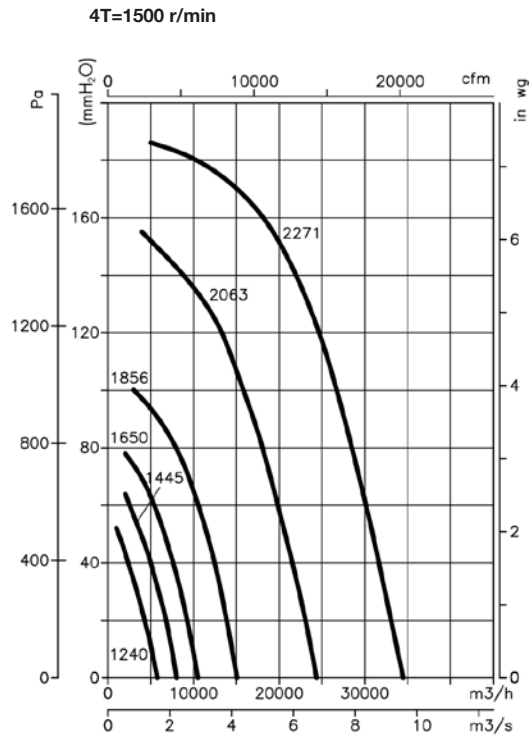
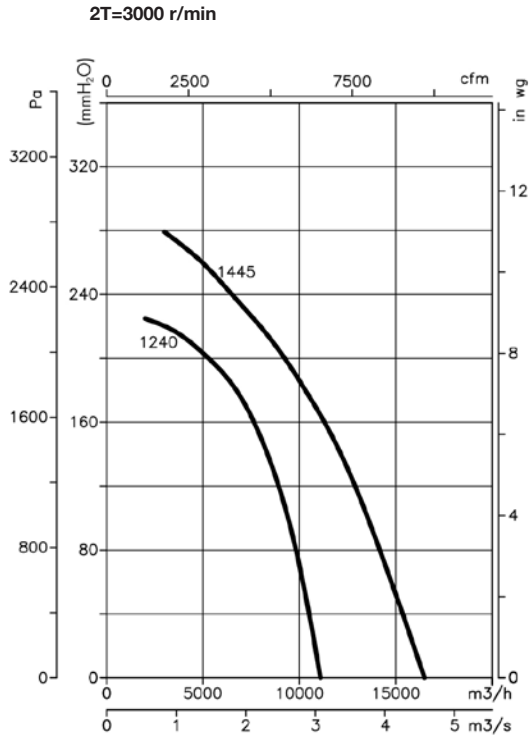

## Accesorios

Ver apartado accesorios





# TCMP CJMP



TCMP



CJMP

## Extractores centrífugos y unidades de extracción 400°C/2h, con turbina multipala

TCMP: Extractores centrífugos 400°C/2h, para trabajar en el exterior de la zona de riesgo de incendios, de simple aspiración

CJMP: Unidades de extracción 400°C/2h con caja aislada acústicamente, para trabajar en el exterior de la zona de riesgo de incendios, de simple aspiración

### Ventilador:

- Envoltente en chapa de acero
- Turbina con álabes hacia delante, en chapa de acero galvanizado
- Homologación según norma EN 12101-3:2002/AC:2006, con certificación N°: 0370-CPR-0313 (TCMP), N°: 0370-CPR-0402 (CJMP)

### Motor:

- Motores clase F, con rodamientos a bolas, protección IP55
- Trifásicos 230/400V.-50Hz.(hasta 5,5CV) y 400/690V.-50Hz.(potencias superiores a 5,5CV)
- Temperatura máxima del aire a transportar: Servicio S1 -20°C+ 250°C en continuo, Servicio S2 200°C/2h, 300°C/2h y 400°C/2h

### Acabado:

- Anticorrosivo en resina de poliéster polimerizada a 190 °C, previo desengrase con tratamiento nanotecnológico libre de fosfatos.
- CJMP: Anticorrosivo en chapa de acero galvanizado

### Bajo demanda:

- Extractores con motor de 2 velocidades
- Extractores a transmisión



## Código de pedido

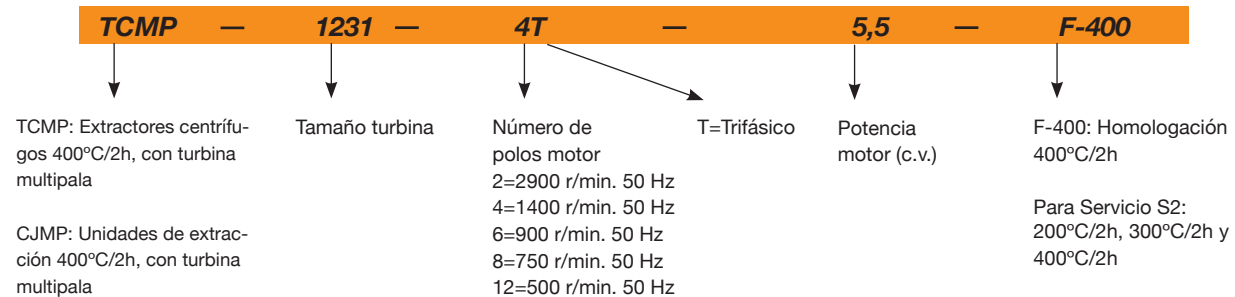

## Características técnicas

Modelo	Velocidad (r/min)	Intensidad máxima admisible (A)			Potencia instalada (kW)	Caudal máximo (m³/h)	Nivel presión sonora dB(A)		Peso aprox. (Kg)	
		230V	400V	690V			TCMP	CJMP	TCMP	CJMP
TCMP CJMP 820-4T	1350	1,66	0,96		0,25	1665	65	59	11	25
TCMP CJMP 922-4T	1380	2,92	1,69		0,55	2450	66	60	20	55
TCMP CJMP 1025-4T-1,5	1400	4,03	2,32		1,10	3385	70	64	28	69
TCMP CJMP 1025-4T-2	1430	5,96	3,44		1,50	3650	72	66	31	72
TCMP CJMP 1128-4T-3	1445	8,36	4,83		2,20	5005	74	68	38	87
TCMP CJMP 1128-4T-4	1445	10,96	6,33		3,00	5450	75	69	41	90
TCMP CJMP 1128-6T	945	3,90	2,20		0,75	3300	60	55	30	79
TCMP CJMP 1231-4T-3	1445	8,36	4,83		2,20	4740	73	67	45	103
TCMP CJMP 1231-4T-4	1445	10,96	6,33		3,00	5910	75	69	48	106
TCMP CJMP 1231-4T-5,5	1440	14,10	8,12		4,00	6850	77	71	55	113
TCMP CJMP 1231-6T	955	6,42	3,71		1,50	5115	64	59	45	103
TCMP CJMP 1435-4T-4	1445	10,96	6,33		3,00	5395	76	70	55	126
TCMP CJMP 1435-4T-5,5	1440	14,10	8,12		4,00	6575	78	72	62	133
TCMP CJMP 1435-4T-7,5	1440		11,60	6,70	5,50	7940	80	74	72	143
TCMP CJMP 1435-4T-10	1455		14,20	8,20	7,50	9370	82	76	80	151
TCMP CJMP 1435-6T	955	9,30	5,30		2,20	6400	68	63	57	128
TCMP CJMP 1640-4T-5,5	1440	14,10	8,12		4,00	7000	77	71	81	151
TCMP CJMP 1640-4T-7,5	1440		11,60	6,70	5,50	8035	80	74	91	161
TCMP CJMP 1640-4T-10	1455		14,20	8,20	7,50	9710	82	76	99	169

**Características técnicas**

Modelo	Velocidad (r/min)	Intensidad máxima admisible (A)			Potencia instalada (kW)	Caudal máximo (m³/h)	Nivel presión sonora dB(A)		Peso aprox. (Kg)	
		230V	400V	690V			TCMP	CJMP	TCMP	CJMP
TCMP CJMP 1640-6T 955		9,30	5,30		2,20	8105	71	66	76	146
TCMP CJMP 1845-4T-7,5 1440			11,60	6,70	5,50	8000	82	76	100	181
TCMP CJMP 1845-4T-10 1455			14,20	8,20	7,50	10000	85	79	108	189
TCMP CJMP 1845-6T 955		9,30	5,30		2,20	7500	77	72	85	166
TCMP CJMP 2050-4T-10 1455			14,20	8,20	7,50	8975	83	77	130	233
TCMP CJMP 2050-4T-15 1460			20,20	11,66	11,00	12525	87	81	154	257
TCMP CJMP 2050-4T-20 1460			27,50	15,88	15,00	16500	89	83	166	269
TCMP CJMP 2050-6T 960		16,50	9,46		4,00	11000	79	74	125	228



**Erp. Características del punto de máxima eficiencia (BEP)**

<b>MC</b>	Categoría de medición	<b>ηe[%]</b>	Eficiencia
<b>EC</b>	Categoría de eficiencia	<b>N</b>	Grado de eficiencia
<b>S</b>	Estática	<b>[kW]</b>	Potencia eléctrica
<b>T</b>	Total	<b>[m³/h]</b>	Caudal
<b>VSD</b>	Variador de velocidad	<b>[mmH₂O]</b>	Presión estática o total (Según EC)
<b>SR</b>	Relación específica	<b>[RPM]</b>	Velocidad

Modelo	MC	EC	VSD	SR	ηe[%]	N	(kW)	(m³/h)	(mmH₂O)	(RPM)
820-4T	A	S	NO	1,00	35,2%	46,5	0,165	721	29,53	1441
922-4T	A	S	NO	1,00	36,4%	46,0	0,307	1187	34,59	1437
1025-4T-1,5	A	S	NO	1,01	38,9%	47,1	0,506	1501	48,06	1462
1025-4T-2	A	S	NO	1,01	35,3%	43,1	0,582	1541	48,88	1478
1128-4T-3	A	S	NO	1,01	40,5%	46,8	1,002	2303	64,68	1479
1128-4T-4	A	S	NO	1,01	40,2%	46,3	1,059	2370	65,85	1483
1128-6T	A	S	NO	1,00	36,8%	46,0	0,348	1622	28,94	981
1231-4T-3	A	S	NO	1,01	41,7%	46,9	1,482	2927	77,43	1469
1231-4T-4	A	S	NO	1,01	41,2%	46,2	1,613	3143	77,62	1475
1231-4T-5,5	A	S	NO	1,01	41,3%	46,2	1,653	3120	80,29	1478
1231-6T	A	S	NO	1,00	38,3%	46,1	0,579	2332	34,85	986
1435-4T-4	A	S	NO	1,01	42,4%	46,3	2,428	3916	96,46	1462
1435-4T-5,5	A	S	NO	1,01	42,4%	46,3	2,425	3865	97,59	1468
1435-4T-7,5	A	S	NO	1,01	42,5%	46,3	2,492	3904	99,52	1476
1435-4T-10	A	S	NO	1,01	42,5%	46,6	2,271	3629	97,61	1470
1435-6T	A	S	NO	1,01	39,6%	46,2	0,906	3441	38,22	985
1640-4T-5,5	A	S	NO	1,01	55,4%	58,7	3,000	4685	130,10	1461
1640-4T-7,5	A	S	NO	1,01	48,0%	50,6	3,899	5080	135,33	1463
1640-4T-10	A	S	NO	1,02	43,1%	45,2	4,596	5382	135,00	1476
1640-6T	A	S	NO	1,01	43,9%	49,5	1,300	3946	53,00	978
1845-4T-7,5	A	S	NO	1,02	57,0%	58,3	6,385	7900	169,13	1439
1845-4T-10	A	S	NO	1,02	56,7%	57,6	7,387	8599	178,87	1461
1845-6T	A	S	NO	1,01	47,0%	51,3	2,070	5546	64,33	965
2050-4T-10	A	S	NO	1,02	54,9%	55,4	8,393	8977	188,36	1455
2050-4T-15	A	S	NO	1,02	55,7%	56,0	9,285	9695	195,91	1470
2050-4T-20	B	T	NO	1,03	69,8%	69,5	16,819	16500	261,08	1459
2050-6T	A	S	NO	1,01	36,5%	39,0	3,988	6929	77,00	966

**Características acústicas**

Los valores indicados, se determinan mediante medidas de nivel de presión y potencia sonora en dB(A) obtenidas en campo libre a una distancia equivalente a dos veces la envergadura del ventilador más el diámetro de la turbina, con un mínimo de 1,5 mts.

Modelo CJMP	Espectro de potencia sonora Lw(A) en dB(A) por banda de frecuencia en Hz																
	63	125	250	500	1000	2000	4000	8000	Modelo CJMP	63	125	250	500	1000	2000	4000	8000
820	40	50	61	68	72	69	67	60	1435-4-4	54	63	74	81	85	83	81	74
922	41	51	62	69	73	70	68	61	1435-4-5,5	56	65	76	83	87	85	83	76
1025-4-1,5	45	55	66	73	77	74	72	65	1435-4-7,5	58	67	78	85	89	87	85	78
1025-4-2	47	57	68	75	79	76	74	67	1435-4-10	60	69	80	87	91	89	87	80
1128-4-3	49	59	70	77	81	78	76	69	1435-6	46	55	66	73	77	75	73	66
1128-4-4	50	60	71	78	82	79	77	70	1640-4-5,5	55	64	75	82	86	84	82	75
1128-6	35	45	56	63	67	64	62	55	1640-4-7,5	58	67	78	85	89	87	85	78
1231-4-3	51	60	71	78	82	80	78	71	1640-4-10	60	69	80	87	91	89	87	80
1231-4-4	53	62	73	80	84	82	80	73	1640-6	49	58	69	76	80	78	76	69
1231-4-5,5	55	64	75	82	86	84	82	75	1845-4-7,5	61	71	82	89	93	91	89	81
1231-6	42	51	62	69	73	71	69	62	1845-4-10	64	74	85	92	96	94	92	84

Características acústicas

1845-6	56	66	77	84	88	86	84	76	1435-4-4	48	57	68	75	79	77	75	68
2050-4-10	62	72	83	90	94	92	90	82	1435-4-5,5	50	59	70	77	81	79	77	70
2050-4-15	66	76	87	94	98	96	94	86	1435-4-7,5	52	61	72	79	83	81	79	72
2050-4-20	68	78	89	96	100	98	96	88	1435-4-10	54	63	74	81	85	83	81	74
2050-6	58	68	79	86	90	88	86	78	1435-6	41	50	61	68	72	70	68	61
820	34	44	55	62	66	63	61	54	1640-4-5,5	49	58	69	76	80	78	76	69
922	35	45	56	63	67	64	62	55	1640-4-7,5	52	61	72	79	83	81	79	72
1025-4-1,5	39	49	60	67	71	68	66	59	1640-4-10	54	63	74	81	85	83	81	74
1025-4-2	41	51	62	69	73	70	68	61	1640-6	44	53	64	71	75	73	71	64
1128-4-3	43	53	64	71	75	72	70	63	1845-4-7,5	55	65	76	83	87	85	83	75
1128-4-4	44	54	65	72	76	73	71	64	1845-4-10	58	68	79	86	90	88	86	78
1128-6	30	40	51	58	62	59	57	50	1845-6	51	61	72	79	83	81	79	71
1231-4-3	45	54	65	72	76	74	72	65	2050-4-10	56	66	77	84	88	86	84	76
1231-4-4	47	56	67	74	78	76	74	67	2050-4-15	60	70	81	88	92	90	88	80
1231-4-5,5	49	58	69	76	80	78	76	69	2050-4-20	62	72	83	90	94	92	90	82
1231-6	37	46	57	64	68	66	64	57	2050-6	53	63	74	81	85	83	81	73

Dimensiones mm

Boca de aspiración

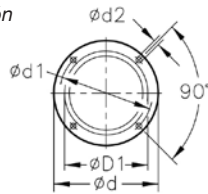

Boca de impulsión

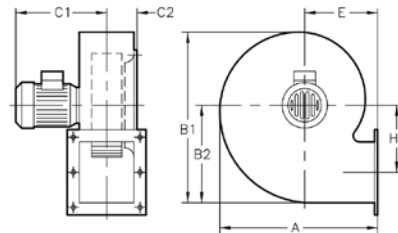
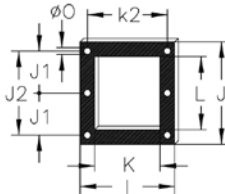

Modelo	A	B1	B2	C1	C2	$\phi D1^*$	$\phi d$	$\phi d1$	$\phi d2$	E	H1	I	J	J1	J2	K	k2	L	$\phi O$
820-4T	322	377	223	272	68.5	200	247	230	M.6	137.5	137	184	213	94.5	189	130	160	156	9

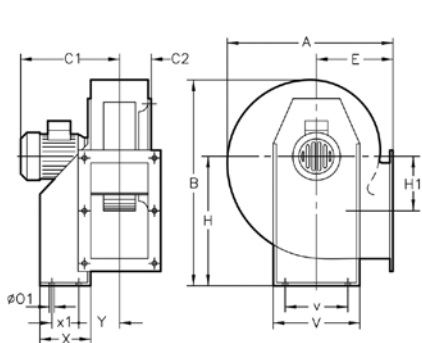

922/1025/1128/1231

Boca de aspiración

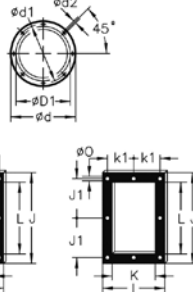

Boca de impulsión

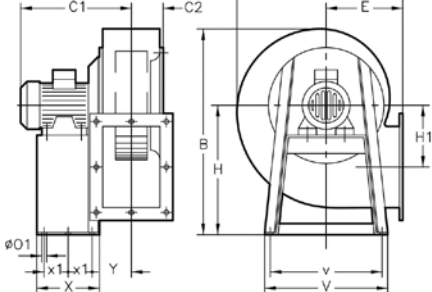

1435/1640/1845/2050

Modelo	A	B	C1	C2	$\phi D1^*$	$\phi d$	$\phi d1$	$\phi d2$	E	H	H1	I	J	J1	K	k1	k2	L	$\phi O$	$\phi O1$	V	v	X	x1	Y
922	388,5	455	332	73,5	224	278	256	M.8	180	280	134	204	282,5	128	140	-	180	215	9,5	10,5	290	220	114	50	105
1025	427	503	393	86	250	305	282	M.8	197	310	144	229	312,5	145	165	-	205	250	9,5	12,5	315	228	134	74	115,5
1128-4T	472	553	430	93,5	280	348	320	M.8	216	340	152	244	364	170	180	-	220	296,5	9,5	12,5	348	245	144	95	122,5
1128-6T	472	553	400	93,5	280	348	320	M.8	216	340	152	244	364	170	180	-	220	296,5	9,5	12,5	348	245	144	95	122,5
1231-3	526	630	440	103,5	315	382	354	M.8	238	390	179,5	264	382,5	180	200	-	240	320	11,5	13	382	322	183	140	126
1231-4	526	630	440	103,5	315	382	354	M.8	238	390	179,5	264	382,5	180	200	-	240	320	11,5	13	382	322	183	140	126
1231-5,5	526	630	463	103,5	315	382	354	M.8	238	390	179,5	264	382,5	180	200	-	240	320	11,5	13	382	322	183	140	126
1231-6T	526	630	440	103,5	315	382	354	M.8	238	390	179,5	264	382,5	180	200	-	240	320	11,5	13	382	322	183	140	126
1435-4	573,5	715	464	118	355	422	394	M.8	250	445	242,5	292	342,5	159	228	133	-	280	11,5	13	456	420	333	136,5	150
1435-5,5	573,5	715	477	118	355	422	394	M.8	250	445	242,5	292	342,5	159	228	133	-	280	11,5	13	456	420	333	136,5	150
1435-7,5	573,5	715	525	118	355	422	394	M.8	250	445	242,5	292	342,5	159	228	133	-	280	11,5	13	456	420	333	136,5	150
1435-10	573,5	715	525	118	355	422	394	M.8	250	445	242,5	292	342,5	159	228	133	-	280	11,5	13	456	420	333	136,5	150
1435-6T	573,5	715	487	118	355	422	394	M.8	250	445	242,5	292	342,5	159	228	133	-	280	11,5	13	456	420	333	136,5	150
1640-5,5	634	799	499	130	400	464	438	M.8	270	495	271	336	404	185	250	150	-	321	11,5	13	500	460	327	133,5	162,5
1640-7,5	634	799	537	130	400	464	438	M.8	270	495	271	336	404	185	250	150	-	321	11,5	13	500	460	327	133,5	162,5
1640-10	634	799	537	130	400	464	438	M.8	270	495	271	336	404	185	250	150	-	321	11,5	13	500	460	327	133,5	162,5
1640-6T	634	799	499	130	400	464	438	M.8	270	495	271	336	404	185	250	150	-	321	11,5	13	500	460	327	133,5	162,5
1845-4T	711	901	554	147	450	515	485	M.8	302	560	305	370	444	202	284	164	-	361	11,5	13	538	502	340	140	179,5
1845-6T	711	901	516	147	450	515	485	M.8	302	560	305	370	444	202	284	164	-	361	11,5	13	538	502	340	140	179,5
2050-10	797	987	572	162,5	500	565	535	M.10	345	610	313	411	544	250	315	182,5	-	451	11,5	13	635	615	435	188	196
2050-12,5	797	987	624	162,5	500	565	535	M.10	345	610	313	411	544	250	315	182,5	-	451	11,5	13	635	615	435	188	196
2050-15	797	987	677	162,5	500	565	535	M.10	345	610	313	411	544	250	315	182,5	-	451	11,5	13	635	615	435	188	196
2050-20	797	987	677	162,5	500	565	535	M.10	345	610	313	411	544	250	315	182,5	-	451	11,5	13	635	615	435	188	196
2050-6T	797	987	572	162,5	500	565	535	M.10	345	610	313	411	544	250	315	182,5	-	451	11,5	13	635	615	435	188	196

\* Diámetro nominal tubería recomendada

Dimensiones mm

Suministro standard impulsión:: LG-270

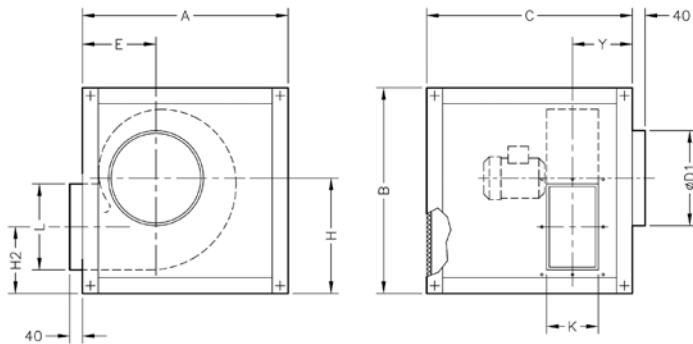

Modelo	A	B	C	ØD1	E	H	H2	K	L	Y
CJMP-820	400	450	450	200	142	263	126	130	156	112
CJMP-922	610	610	610	224	187	349	215	140	215	176
CJMP-1025	660	660	660	250	204	379	235	165	250	178.5
CJMP-1128	720	720	720	280	223	409	257	180	295	191
CJMP-1231	800	800	800	315	245	459	279.5	200	320	205
CJMP-1435	880	880	880	355	257	514	271.5	230	280	291
CJMP-1640	970	970	970	400	277	564	293	250	320	324
CJMP-1845	1070	1070	1070	450	309	629	324	284	360	357
CJMP-2050	1160	1160	1160	500	352	679	366	315	450	385.5

Detalle taladros boca impulsión

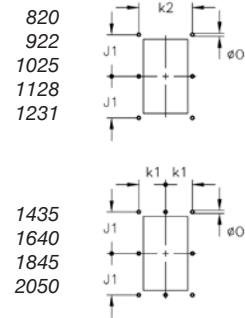

Modelo	k1	k2	J1	Ø0
CJMP-820	-	160	94.5	9
CJMP-922	-	180	128	9.5
CJMP-1025	-	205	145	9.5
CJMP-1128	-	220	170	9.5
CJMP-1231	-	240	180	11.5
CJMP-1435	133	-	159	11.5
CJMP-1640	150	-	185	11.5
CJMP-1845	164	-	202	11.5
CJMP-2050	182.5	-	250	11.5

Suministro bajo demanda: LG-0

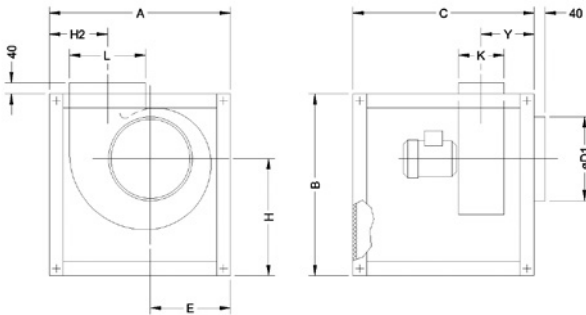

Modelo	A	B	C	ØD1	E	H	H2	K	L	Y
CJMP-922	610	610	610	224	279	349	197	140	215	176
CJMP-1025	660	660	660	250	302	379	214	165	250	178.5
CJMP-1128	720	720	720	280	335	409	233	180	295	191
CJMP-1231	800	800	800	315	366	459	255	200	320	205
CJMP-1435	880	880	880	355	385	514	253	230	280	291
CJMP-1640	970	970	970	400	412	564	287	250	320	324
CJMP-1845	1070	1070	1070	450	446	629	319	284	360	357
CJMP-2050	1160	1160	1160	500	485	679	362	315	450	383.5

Suministro bajo demanda: LG-90

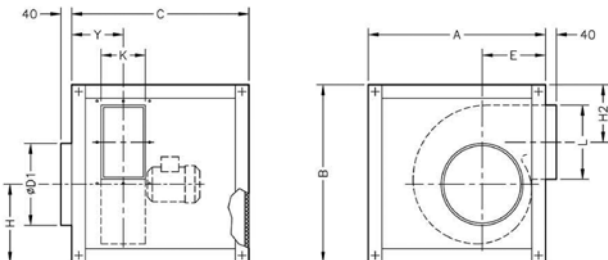

Modelo	A	B	C	ØD1	E	H	H2	K	L	Y
CJMP-922	720	720	720	224	187	349	237	140	215	176
CJMP-1025	800	800	800	250	204	379	277	165	250	178
CJMP-1128	880	880	880	280	223	409	319	180	295	191
CJMP-1231	970	970	970	315	245	459	332	200	320	205
CJMP-1435	1070	1070	1070	355	257	514	314	230	280	291
CJMP-1640	1160	1160	1160	400	277	564	325	250	320	325
CJMP-1845	865	1260	1050	450	309	629	326	284	360	357
CJMP-2050	965	1400	1200	500	352	679	408	315	450	383.5

## Curvas características

Q= Caudal en m<sup>3</sup>/h, m<sup>3</sup>/s y cfm.

Pe= Presión estática en mmH<sub>2</sub>O, Pa e inwg.

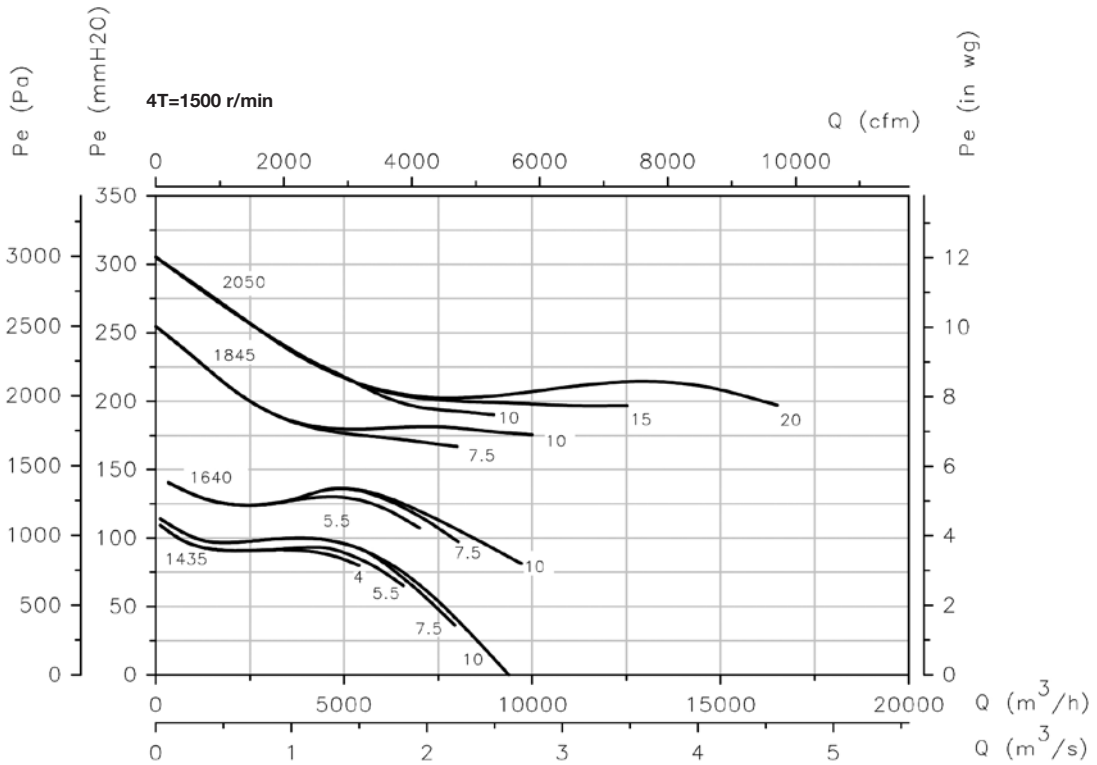
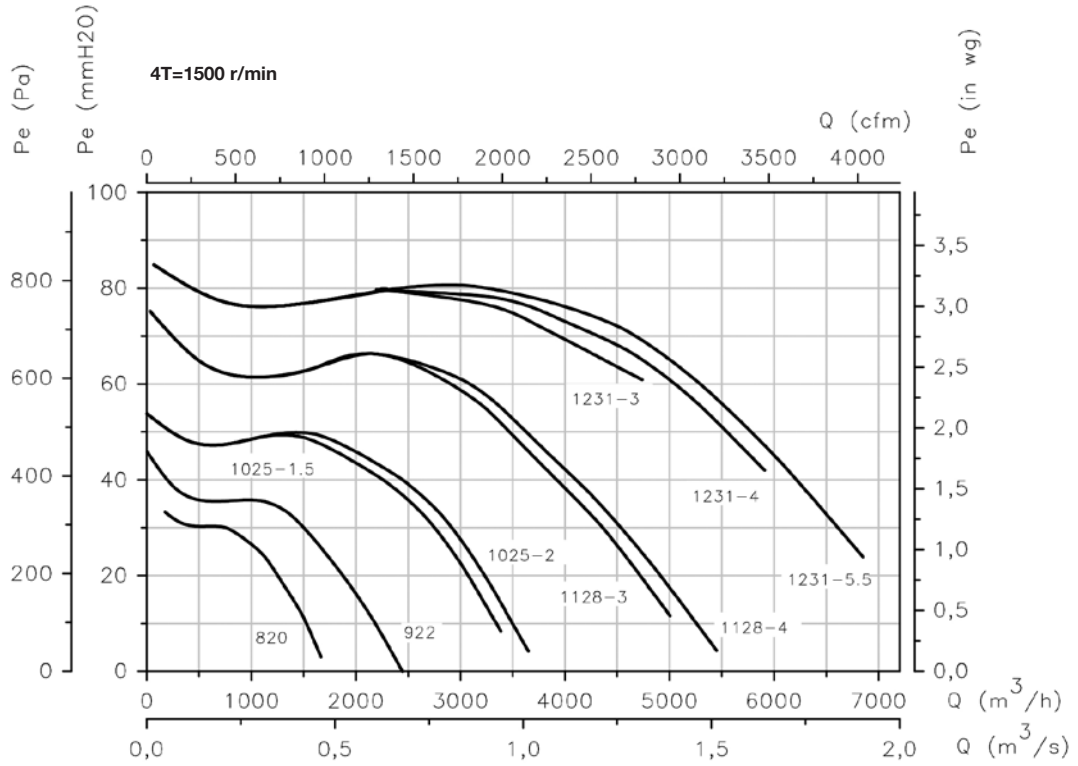

**Curvas características**

Q= Caudal en m<sup>3</sup>/h, m<sup>3</sup>/s y cfm.

Pe= Presión estática en mmH2O, Pa e inwg.

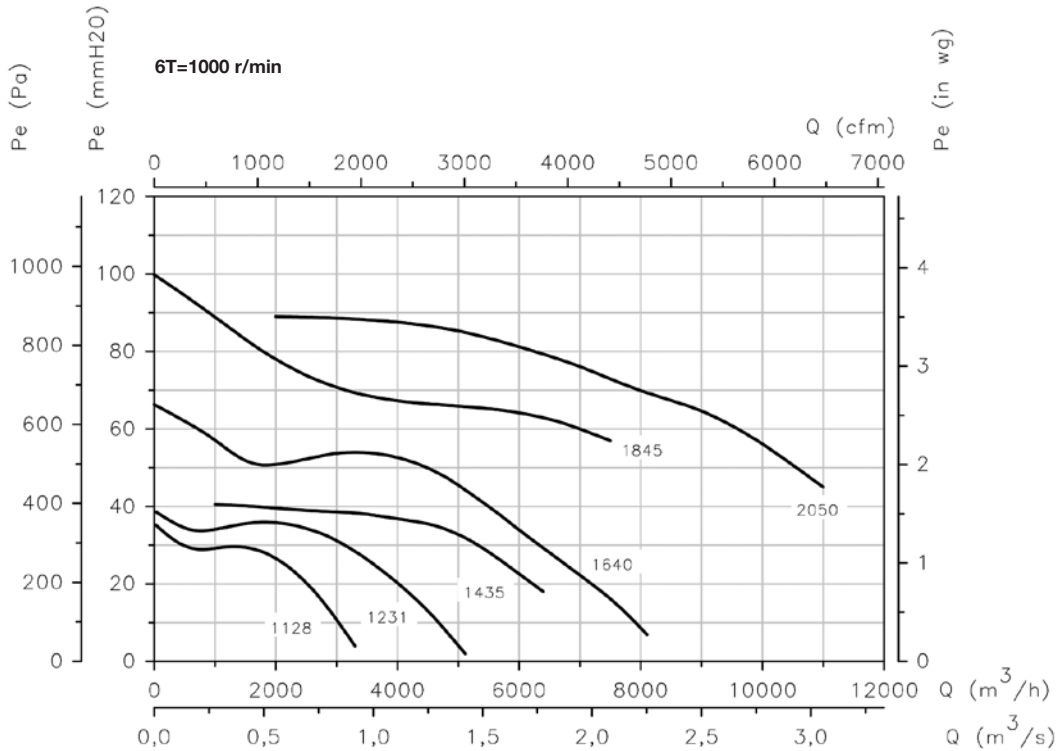

**Orientaciones**

Suministro standard LG 270

Posiciones LG 180 y RD 180 bajo demanda y con medidas de anclaje especiales.



**Accesorios**

Ver apartado accesorios



# CJTX-C



## Unidades de extracción 400°C/2h, a transmisión con ventilador de doble aspiración

Unidades de extracción 400°C/2h, con motor y transmisión en el interior de la caja, para trabajar en el exterior de la zona de riesgo de incendios

### Ventilador:

- Estructura en chapa de acero galvanizado
- Turbina con álabes hacia delante, en chapa de acero galvanizado
- Homologación según norma EN 12101-3:2002/AC:2006, con certificación N°: 0370-CPR-0468
- Dirección aire sentido lineal

### Motor:

- Motores clase F, con rodamientos a bolas, protección IP55, de 1 ó 2 velocidades según modelo
- Trifásicos 230/400V.-50Hz.(hasta 5,5CV) y 400/690V.-50Hz.(potencias superiores a 5,5CV)
- Temperatura máxima del aire a transportar: Servicio S1 -20°C+ 120°C en conti-

nuo, Servicio S2 200°C/2h, 300°C/2h y 400°C/2h

### Acabado:

- Anticorrosivo en chapa de acero galvanizado

### Bajo demanda:

- Extractores con salida vertical



## Código de pedido

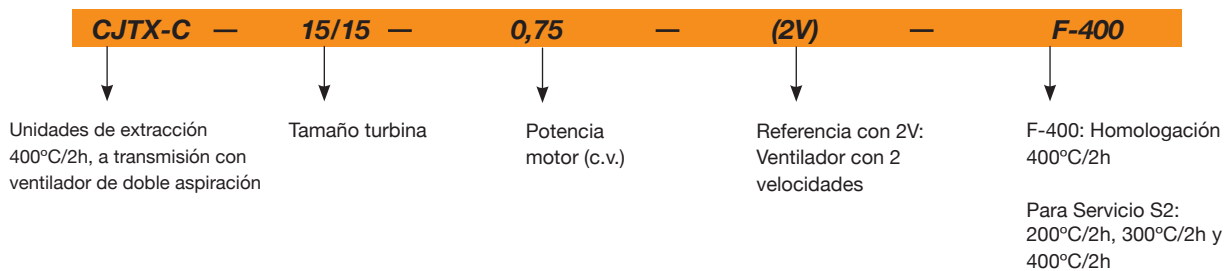

## Características técnicas

Modelo	Velocidad (r/min)	Intensidad máxima admisible (A)			Potencia instalada (kW)	Caudal máximo (m³/h)	Nivel presión sonora dB(A)	Peso aprox. (Kg)
		230V	400V (A)	690V				
CJTX-C-7/7-0,25	1000	0,96	0,55		0,18	1600	58	53
CJTX-C-7/7-0,33	1200	1,90	1,10		0,25	1825	60	54
CJTX-C-7/7-0,33 2V	1200 / 600		0,70 / 0,30		0,25 / 0,10	1825 / 915	60 / 45	54
CJTX-C-7/7-0,5	1400	1,84	1,06		0,37	2100	64	54
CJTX-C-7/7-0,5 2V	1400 / 700		1,05 / 0,50		0,37 / 0,11	2100 / 1050	64 / 49	57
CJTX-C-7/7-0,75	1600	2,28	1,31		0,55	2350	67	58
CJTX-C-7/7-0,75 2V	1600 / 800		1,70 / 0,80		0,55 / 0,19	2350 / 1175	67 / 52	58
CJTX-C-7/7-1	1800	2,83	1,63		0,75	2600	69	62
CJTX-C-7/7-1 2V	1800 / 900		2,00 / 0,90		0,75 / 0,20	2600 / 1300	69 / 54	61
CJTX-C-9/9-0,33	850	1,90	1,10		0,25	2300	58	65
CJTX-C-9/9-0,33 2V	850 / 425		0,70 / 0,30		0,25 / 0,10	2300 / 1150	58 / 43	65
CJTX-C-9/9-0,5	960	1,84	1,06		0,37	2800	61	66
CJTX-C-9/9-0,5 2V	960 / 480		1,05 / 0,50		0,37 / 0,11	2800 / 1400	61 / 46	67
CJTX-C-9/9-0,75	1060	2,28	1,31		0,55	3200	65	69
CJTX-C-9/9-0,75 2V	1060 / 530		1,70 / 0,80		0,55 / 0,19	3200 / 1600	65 / 50	69
CJTX-C-9/9-1	1200	2,83	1,63		0,75	3500	67	73
CJTX-C-9/9-1 2V	1200 / 600		2,00 / 0,90		0,75 / 0,20	3500 / 1750	67 / 52	72
CJTX-C-9/9-1,5	1340	4,03	2,32		1,10	4100	70	80
CJTX-C-9/9-1,5 2V	1340 / 670		2,90 / 1,30		1,10 / 0,25	4100 / 2050	70 / 55	74
CJTX-C-9/9-2	1500	5,96	3,44		1,50	4400	72	84
CJTX-C-9/9-2 2V	1500 / 750		3,50 / 1,50		1,50 / 0,37	4400 / 2200	72 / 57	76
CJTX-C-10/10-0,33	660	1,90	1,10		0,25	2800	57	77

## Características técnicas

Modelo	Velocidad (r/min)	Intensidad máxima admisible (A)			Potencia instalada (kW)	Caudal máximo (m³/h)	Nivel presión sonora dB(A)	Peso aprox. (Kg)
		230V	400V (A)	690V				
CJTX-C-10/10-0,33 2V	660 / 330		0,70 / 0,30		0,25 / 0,10	2800 / 1400	57 / 42	77
CJTX-C-10/10-0,5	800	1,84	1,06		0,37	3300	61	77
CJTX-C-10/10-0,5 2V	800 / 400		1,05 / 0,50		0,37 / 0,11	3300 / 1650	61 / 46	79
CJTX-C-10/10-0,75	880	2,28	1,31		0,55	3800	63	81
CJTX-C-10/10-0,75 2V	880 / 440		1,70 / 0,80		0,55 / 0,19	3800 / 1900	63 / 48	81
CJTX-C-10/10-1	1000	2,83	1,63		0,75	4200	65	85
CJTX-C-10/10-1 2V	1000 / 500		2,00 / 0,90		0,75 / 0,20	4200 / 2100	65 / 50	84
CJTX-C-10/10-1,5	1130	4,03	2,32		1,10	4800	68	92
CJTX-C-10/10-1,5 2V	1130 / 565		2,90 / 1,30		1,10 / 0,25	4800 / 2400	68 / 53	85
CJTX-C-10/10-2	1270	5,96	3,44		1,50	5300	71	94
CJTX-C-10/10-2 2V	1270 / 635		3,50 / 1,50		1,50 / 0,37	5300 / 2650	71 / 56	86
CJTX-C-10/10-3	1450	8,36	4,83		2,20	5900	74	89
CJTX-C-10/10-3 2V	1450 / 725		4,90 / 1,70		2,20 / 0,45	5900 / 2950	74 / 59	93
CJTX-C-12/12-0,5	600	1,84	1,06		0,37	4200	60	96
CJTX-C-12/12-0,5 2V	600 / 300		1,05 / 0,50		0,37 / 0,11	4200 / 2100	60 / 45	98
CJTX-C-12/12-0,75	700	2,28	1,31		0,55	4600	63	99
CJTX-C-12/12-0,75 2V	700 / 350		1,70 / 0,80		0,55 / 0,19	4600 / 2300	63 / 48	100
CJTX-C-12/12-1	800	2,83	1,63		0,75	5100	65	104
CJTX-C-12/12-1 2V	800 / 400		2,00 / 0,90		0,75 / 0,20	5100 / 2550	65 / 50	103
CJTX-C-12/12-1,5	880	4,03	2,32		1,10	5700	68	111
CJTX-C-12/12-1,5 2V	880 / 440		2,90 / 1,30		1,10 / 0,25	5700 / 2850	68 / 53	104
CJTX-C-12/12-2	1020	5,96	3,44		1,50	6400	70	113
CJTX-C-12/12-2 2V	1020 / 510		3,50 / 1,50		1,50 / 0,37	6400 / 3200	70 / 55	105
CJTX-C-12/12-3	1140	8,36	4,83		2,20	7400	73	107
CJTX-C-12/12-3 2V	1140 / 570		4,90 / 1,70		2,20 / 0,45	7400 / 3700	73 / 58	110
CJTX-C-12/12-4	1250	10,96	6,33		3,00	8200	75	115
CJTX-C-12/12-4 2V	1250 / 625		6,50 / 2,30		3,00 / 0,60	8200 / 4100	75 / 60	118
CJTX-C-15/15-0,75	530	2,28	1,31		0,55	4700	59	126
CJTX-C-15/15-0,75 2V	530 / 265		1,60 / 0,65		0,55 / 0,09	4700 / 2350	59 / 44	126
CJTX-C-15/15-1	560	2,83	1,63		0,75	6000	61	130
CJTX-C-15/15-1 2V	560 / 280		2,20 / 0,87		0,75 / 0,15	6000 / 3000	61 / 46	129
CJTX-C-15/15-1,5	630	4,03	2,32		1,10	7000	64	138
CJTX-C-15/15-1,5 2V	630 / 315		3,00 / 1,15		1,10 / 0,18	7000 / 3500	64 / 49	131
CJTX-C-15/15-2	700	5,96	3,44		1,50	7800	66	141
CJTX-C-15/15-2 2V	700 / 350		4,60 / 1,90		1,50 / 0,25	7800 / 3900	66 / 51	133
CJTX-C-15/15-3	800	8,36	4,83		2,20	9000	69	135
CJTX-C-15/15-3 2V	800 / 400		5,60 / 2,20		2,20 / 0,37	9000 / 4500	69 / 54	140
CJTX-C-15/15-4	880	10,96	6,33		3,00	10000	72	144
CJTX-C-15/15-4 2V	880 / 440		9,00 / 3,50		3,00 / 0,55	10000 / 5000	72 / 57	147
CJTX-C-15/15-5,5	970	14,10	8,12		4,00	11000	73	145
CJTX-C-15/15-5,5 2V	970 / 485		11,00 / 4,00		4,00 / 0,65	11000 / 5500	73 / 58	151
CJTX-C-18/18-1	460	2,83	1,63		0,75	7500	60	163
CJTX-C-18/18-1 2V	460 / 230		2,20 / 0,87		0,75 / 0,15	7500 / 3750	60 / 45	163
CJTX-C-18/18-1,5	510	4,03	2,32		1,10	9000	61	171
CJTX-C-18/18-1,5 2V	510 / 255		3,00 / 1,15		1,10 / 0,18	9000 / 4500	61 / 46	165
CJTX-C-18/18-2	540	5,96	3,44		1,50	10800	64	175
CJTX-C-18/18-2 2V	540 / 270		4,60 / 1,90		1,50 / 0,25	10800 / 5400	64 / 49	167
CJTX-C-18/18-3	610	8,36	4,83		2,20	12500	67	170
CJTX-C-18/18-3 2V	610 / 305		5,60 / 2,20		2,20 / 0,37	12500 / 6250	67 / 52	173
CJTX-C-18/18-4	680	10,96	6,33		3,00	14000	70	177
CJTX-C-18/18-4 2V	680 / 340		9,00 / 3,50		3,00 / 0,55	14000 / 7000	70 / 55	180
CJTX-C-18/18-5,5	750	14,10	8,12		4,00	15000	72	178
CJTX-C-18/18-5,5 2V	750 / 375		11,00 / 4,00		4,00 / 0,65	15000 / 7500	72 / 57	184
CJTX-C-18/18-7,5	850		11,60	6,72	5,50	16500	74	188
CJTX-C-18/18-7,5 2V	850 / 425		13,20 / 5,30		5,50 / 1,00	16500 / 8250	74 / 59	204
CJTX-C-18/18-10	930		14,20	8,20	7,50	18000	77	202
CJTX-C-18/18-10 2V	930 / 465		16,90 / 5,50		7,50 / 1,30	18000 / 9000	77 / 62	213
CJTX-C-20/20-2	450	5,96	3,44		1,50	13000	64	276
CJTX-C-20/20-2 2V	450 / 225		4,60 / 1,90		1,50 / 0,25	13000 / 6500	64 / 49	268
CJTX-C-20/20-3	530	8,36	4,83		2,20	15000	68	270
CJTX-C-20/20-3 2V	530 / 265		5,60 / 2,20		2,20 / 0,37	15000 / 7500	68 / 53	274
CJTX-C-20/20-4	580	10,96	6,33		3,00	16300	70	277
CJTX-C-20/20-4 2V	580 / 290		9,00 / 3,50		3,00 / 0,55	16300 / 8150	70 / 55	280
CJTX-C-20/20-5,5	660	14,10	8,12		4,00	18000	72	279



## Características técnicas

Modelo	Velocidad (r/min)	Intensidad máxima admisible (A)			Potencia instalada (kW)	Caudal máximo (m³/h)	Nivel presión sonora dB(A)	Peso aprox. (Kg)	
		230V	400V (A)	690V					
CJTX-C-20/20-5,5 2V	660 / 330	11,00 / 4,00			4,00 / 0,65	18000 / 9000	72 / 57	285	
CJTX-C-20/20-7,5	740	11,60			6,72	5,50	20500	74	289
CJTX-C-20/20-7,5 2V	740 / 370	13,20 / 5,30			5,50 / 1,00	20500 / 10250	74 / 59	305	
CJTX-C-20/20-10	815	14,20			8,20	7,50	22500	77	304
CJTX-C-20/20-10 2V	815 / 407,5	16,90 / 5,50			7,50 / 1,30	22500 / 11250	77 / 62	314	
CJTX-C-22/22-2	380	5,96	3,44		1,50	14000	62	318	
CJTX-C-22/22-2 2V	380 / 190	4,60 / 1,90			1,50 / 0,25	14000 / 7000	62 / 47	310	
CJTX-C-22/22-3	430	8,36	4,83		2,20	16000	64	312	
CJTX-C-22/22-3 2V	430 / 215	5,60 / 2,20			2,20 / 0,37	16000 / 8000	64 / 49	316	
CJTX-C-22/22-4	480	10,96	6,33		3,00	18000	68	320	
CJTX-C-22/22-4 2V	480 / 240	9,00 / 3,50			3,00 / 0,55	18000 / 9000	68 / 53	323	
CJTX-C-22/22-5,5	520	14,10	8,12		4,00	20000	69	323	
CJTX-C-22/22-5,5 2V	520 / 260	11,00 / 4,00			4,00 / 0,65	20000 / 10000	69 / 54	329	
CJTX-C-22/22-7,5	580	11,60			6,72	5,50	22500	72	333
CJTX-C-22/22-7,5 2V	580 / 290	13,20 / 5,30			5,50 / 1,00	22500 / 11250	72 / 57	350	
CJTX-C-22/22-10	650	14,20			8,20	7,50	25000	74	346
CJTX-C-22/22-10 2V	650 / 325	16,90 / 5,50			7,50 / 1,30	25000 / 12500	74 / 59	357	
CJTX-C-22/22-15	740	20,20			11,60	11,00	28000	77	358
CJTX-C-22/22-15 2V	740 / 370	23,20 / 8,70			11,00 / 2,80	28000 / 14000	77 / 62	389	
CJTX-C-22/22-20	780	29,80			17,30	15,00	31000	79	424
CJTX-C-22/22-20 2V	780 / 390	31,72 / 11,75			15,00 / 3,80	31000 / 15500	79 / 64	413	
CJTX-C-25/25-3	340	8,36	4,83		2,20	20000	66	369	
CJTX-C-25/25-3 2V	340 / 170	5,60 / 2,20			2,20 / 0,37	20000 / 10000	66 / 51	372	
CJTX-C-25/25-4	380	10,96	6,33		3,00	22000	68	376	
CJTX-C-25/25-4 2V	380 / 190	9,00 / 3,50			3,00 / 0,55	22000 / 11000	68 / 53	379	
CJTX-C-25/25-5,5	420	14,10	8,12		4,00	24000	70	377	
CJTX-C-25/25-5,5 2V	420 / 210	11,00 / 4,00			4,00 / 0,65	24000 / 12000	70 / 55	383	
CJTX-C-25/25-7,5	470	11,60			6,72	5,50	26500	73	393
CJTX-C-25/25-7,5 2V	470 / 235	13,20 / 5,30			5,50 / 1,00	26500 / 13250	73 / 58	409	
CJTX-C-25/25-10	510	14,20			8,20	7,50	29000	75	401
CJTX-C-25/25-10 2V	510 / 255	16,90 / 5,50			7,50 / 1,30	29000 / 14500	75 / 60	412	
CJTX-C-25/25-15	570	20,20			11,60	11,00	34000	78	419
CJTX-C-25/25-15 2V	570 / 285	23,20 / 8,70			11,00 / 2,80	34000 / 17000	78 / 63	450	
CJTX-C-25/25-20	630	29,80			17,30	15,00	38000	80	482
CJTX-C-25/25-20 2V	630 / 315	31,72 / 11,75			15,00 / 3,80	38000 / 19000	80 / 65	471	
CJTX-C-30/28-3	250	8,36	4,83		2,20	25000	64	502	
CJTX-C-30/28-3 2V	250 / 125	5,60 / 2,20			2,20 / 0,37	25000 / 12500	64 / 49	507	
CJTX-C-30/28-4	280	10,96	6,33		3,00	27000	66	516	
CJTX-C-30/28-4 2V	280 / 140	9,00 / 3,50			3,00 / 0,55	27000 / 13500	66 / 51	519	
CJTX-C-30/28-5,5	340	14,10	8,12		4,00	29000	68	517	
CJTX-C-30/28-5,5 2V	340 / 170	11,00 / 4,00			4,00 / 0,65	29000 / 14500	68 / 53	523	
CJTX-C-30/28-7,5	360	11,60			6,72	5,50	32500	71	530
CJTX-C-30/28-7,5 2V	360 / 180	13,20 / 5,30			5,50 / 1,00	32500 / 16250	71 / 56	546	
CJTX-C-30/28-10	410	14,20			8,20	7,50	36000	73	545
CJTX-C-30/28-10 2V	410 / 205	16,90 / 5,50			7,50 / 1,30	36000 / 18000	73 / 58	556	
CJTX-C-30/28-15	480	20,20			11,60	11,00	40000	76	557
CJTX-C-30/28-15 2V	480 / 240	23,20 / 8,70			11,00 / 2,80	40000 / 20000	76 / 61	588	
CJTX-C-30/28-20	520	29,80			17,30	15,00	45000	78	627
CJTX-C-30/28-20 2V	520 / 260	31,72 / 11,75			15,00 / 3,80	45000 / 22500	78 / 63	616	
CJTX-C-30/28-25	550	35,00			20,00	18,50	49000	79	609
CJTX-C-30/28-25 2V	550 / 275	33,00 / 11,00			17,00 / 3,40	49000 / 24500	79 / 64	643	



## Erp. Características del punto de máxima eficiencia (BEP)

<b>MC</b>	Categoría de medición	<b>ηe[%]</b>	Eficiencia
<b>EC</b>	Categoría de eficiencia	<b>N</b>	Grado de eficiencia
<b>S</b>	Estática	<b>[kW]</b>	Potencia eléctrica
<b>T</b>	Total	<b>[m³/h]</b>	Caudal
<b>VSD</b>	Variador de velocidad	<b>[mmH<sub>2</sub>O]</b>	Presión estática o total (Según EC)
<b>SR</b>	Relación específica	<b>[RPM]</b>	Velocidad

Modelo	MC	EC	VSD	SR	ηe[%]	N	(kW)	(m³/h)	(mmH <sub>2</sub> O)	(RPM)
CJTX-C-7/7-0,25	C	S	NO	1,00	28,3%	40,5	0,114	907	13,07	1000
CJTX-C-7/7-0,33	C	S	NO	1,00	32,0%	43,1	0,174	1088	18,82	1200
CJTX-C-7/7-0,33-2V	C	S	NO	1,00	29,5%	40,4	0,189	1088	18,82	1200
CJTX-C-7/7-0,5	C	S	NO	1,00	31,5%	41,3	0,281	1269	25,61	1400
CJTX-C-7/7-0,5-2V	C	S	NO	1,00	31,8%	41,7	0,278	1269	25,61	1400
CJTX-C-7/7-0,75	C	S	NO	1,00	34,3%	43,2	0,385	1450	33,45	1600
CJTX-C-7/7-0,75-2V	C	S	NO	1,00	30,9%	39,6	0,428	1450	33,45	1600
CJTX-C-7/7-1	C	S	NO	1,00	37,1%	45,3	0,508	1632	42,33	1800
CJTX-C-7/7-1-2V	C	S	NO	1,00	31,7%	39,5	0,593	1632	42,33	1800
CJTX-C-9/9-0,33	C	S	NO	1,00	37,7%	49,5	0,138	1293	14,74	850
CJTX-C-9/9-0,33-2V	C	S	NO	1,00	34,8%	46,3	0,149	1293	14,74	850
CJTX-C-9/9-0,5	C	S	NO	1,00	37,2%	47,9	0,201	1460	18,80	960
CJTX-C-9/9-0,5-2V	C	S	NO	1,00	37,6%	48,3	0,199	1460	18,80	960
CJTX-C-9/9-0,75	C	S	NO	1,00	40,5%	50,6	0,249	1612	22,92	1060
CJTX-C-9/9-0,75-2V	C	S	NO	1,00	36,5%	46,3	0,276	1612	22,92	1060
CJTX-C-9/9-1	C	S	NO	1,00	43,8%	53,1	0,334	1825	29,38	1200
CJTX-C-9/9-1-2V	C	S	NO	1,00	37,5%	46,4	0,390	1825	29,38	1200
CJTX-C-9/9-1,5	C	S	NO	1,00	44,9%	53,4	0,453	2038	36,63	1340
CJTX-C-9/9-1,5-2V	C	S	NO	1,00	38,4%	46,5	0,530	2038	36,63	1340
CJTX-C-9/9-2	C	S	NO	1,00	45,3%	52,9	0,630	2281	45,90	1500
CJTX-C-9/9-2-2V	C	S	NO	1,00	39,8%	47,1	0,716	2281	45,90	1500
CJTX-C-10/10-0,33	C	S	NO	1,00	31,9%	42,5	0,210	1575	15,63	660
CJTX-C-10/10-0,33-2V	C	S	NO	1,00	29,4%	39,8	0,228	1575	15,63	660
CJTX-C-10/10-0,5	C	S	NO	1,00	31,5%	40,4	0,380	1909	22,97	800
CJTX-C-10/10-0,5-2V	C	S	NO	1,00	31,8%	40,8	0,376	1909	22,97	800
CJTX-C-10/10-0,75	C	S	NO	1,00	34,2%	42,7	0,465	2100	27,79	880
CJTX-C-10/10-0,75-2V	C	S	NO	1,00	30,9%	39,0	0,515	2100	27,79	880
CJTX-C-10/10-1	C	S	NO	1,00	37,0%	44,6	0,631	2387	35,89	1000
CJTX-C-10/10-1-2V	C	S	NO	1,00	31,7%	38,9	0,736	2387	35,89	1000
CJTX-C-10/10-1,5	C	S	NO	1,00	37,9%	44,6	0,888	2697	45,83	1130
CJTX-C-10/10-1,5-2V	C	S	NO	1,00	32,5%	38,7	1,037	2697	45,83	1130
CJTX-C-10/10-2	C	S	NO	1,01	38,3%	44,0	1,248	3031	57,89	1270
CJTX-C-10/10-2-2V	C	S	NO	1,01	33,7%	39,1	1,419	3031	57,89	1270
CJTX-C-10/10-3	C	S	NO	1,01	39,0%	43,7	1,824	3461	75,46	1450
CJTX-C-10/10-3-2V	C	S	NO	1,01	34,9%	39,3	2,040	3461	75,46	1450
CJTX-C-12/12-0,5	C	S	NO	1,00	33,1%	43,0	0,266	2423	13,33	600
CJTX-C-12/12-0,5-2V	C	S	NO	1,00	33,4%	43,4	0,263	2423	13,33	600
CJTX-C-12/12-0,75	C	S	NO	1,00	36,0%	44,9	0,388	2827	18,15	700
CJTX-C-12/12-0,75-2V	C	S	NO	1,00	32,5%	41,1	0,431	2827	18,15	700
CJTX-C-12/12-1	C	S	NO	1,00	38,9%	47,0	0,536	3231	23,70	800
CJTX-C-12/12-1-2V	C	S	NO	1,00	33,3%	40,9	0,626	3231	23,70	800
CJTX-C-12/12-1,5	C	S	NO	1,00	39,9%	47,2	0,696	3554	28,68	880
CJTX-C-12/12-1,5-2V	C	S	NO	1,00	34,2%	41,1	0,813	3554	28,68	880
CJTX-C-12/12-2	C	S	NO	1,00	40,3%	46,4	1,074	4119	38,53	1020
CJTX-C-12/12-2-2V	C	S	NO	1,00	35,4%	41,2	1,221	4119	38,53	1020
CJTX-C-12/12-3	C	S	NO	1,01	41,0%	46,3	1,472	4604	48,13	1140
CJTX-C-12/12-3-2V	C	S	NO	1,01	36,7%	41,7	1,646	4604	48,13	1140
CJTX-C-12/12-4	C	S	NO	1,01	41,6%	46,2	1,914	5048	57,87	1250
CJTX-C-12/12-4-2V	C	S	NO	1,01	37,7%	42,0	2,111	5048	57,87	1250
CJTX-C-15/15-0,75	C	S	NO	1,00	35,7%	44,2	0,465	3849	15,85	530
CJTX-C-15/15-0,75-2V	C	S	NO	1,00	32,4%	40,5	0,514	3849	15,85	530
CJTX-C-15/15-1	C	S	NO	1,00	38,6%	46,8	0,508	4067	17,70	560
CJTX-C-15/15-1-2V	C	S	NO	1,00	32,6%	40,3	0,603	4067	17,70	560
CJTX-C-15/15-1,5	C	S	NO	1,00	39,6%	46,9	0,705	4576	22,40	630
CJTX-C-15/15-1,5-2V	C	S	NO	1,00	34,1%	41,0	0,819	4576	22,40	630
CJTX-C-15/15-2	C	S	NO	1,00	40,0%	46,4	0,958	5084	27,66	700
CJTX-C-15/15-2-2V	C	S	NO	1,00	35,5%	41,6	1,079	5084	27,66	700
CJTX-C-15/15-3	C	S	NO	1,00	40,7%	46,1	1,404	5810	36,12	800
CJTX-C-15/15-3-2V	C	S	NO	1,00	35,6%	40,6	1,609	5810	36,12	800

Datos del ventilador interno sin caja



## Erp. Características del punto de máxima eficiencia (BEP)

<b>MC</b>	Categoría de medición	<b>ηe[%]</b>	Eficiencia
<b>EC</b>	Categoría de eficiencia	<b>N</b>	Grado de eficiencia
	<b>S</b> Estática	<b>[kW]</b>	Potencia eléctrica
	<b>T</b> Total	<b>[m³/h]</b>	Caudal
<b>VSD</b>	Variador de velocidad	<b>[mmH<sub>2</sub>O]</b>	Presión estática o total (Según EC)
<b>SR</b>	Relación específica	<b>[RPM]</b>	Velocidad

Modelo	MC	EC	VSD	SR	ηe[%]	N	(kW)	(m³/h)	(mmH <sub>2</sub> O)	(RPM)
CJTX-C-15/15-4	C	S	NO	1,00	41,3%	46,0	1,843	6391	43,71	880
CJTX-C-15/15-4-2V	C	S	NO	1,00	35,2%	39,4	2,162	6391	43,71	880
CJTX-C-15/15-5,5	C	S	NO	1,01	42,0%	45,9	2,426	7045	53,11	970
CJTX-C-15/15-5,5-2V	C	S	NO	1,01	37,8%	41,4	2,695	7045	53,11	970
CJTX-C-18/18-1	C	S	NO	1,00	46,1%	52,9	0,836	6738	21,01	460
CJTX-C-18/18-1-2V	C	S	NO	1,00	38,9%	45,2	0,993	6738	21,01	460
CJTX-C-18/18-1,5	C	S	NO	1,00	47,3%	53,3	1,112	7471	25,82	510
CJTX-C-18/18-1,5-2V	C	S	NO	1,00	40,7%	46,3	1,291	7471	25,82	510
CJTX-C-18/18-2	C	S	NO	1,00	47,7%	53,3	1,307	7910	28,95	540
CJTX-C-18/18-2-2V	C	S	NO	1,00	42,4%	47,6	1,472	7910	28,95	540
CJTX-C-18/18-3	C	S	NO	1,00	48,6%	53,2	1,851	8935	36,94	610
CJTX-C-18/18-3-2V	C	S	NO	1,00	42,4%	46,7	2,120	8935	36,94	610
CJTX-C-18/18-4	C	S	NO	1,01	49,3%	53,1	2,528	9961	45,91	680
CJTX-C-18/18-4-2V	C	S	NO	1,01	42,0%	45,4	2,965	9961	45,91	680
CJTX-C-18/18-5,5	C	S	NO	1,01	50,2%	53,2	3,333	10986	55,85	750
CJTX-C-18/18-5,5-2V	C	S	NO	1,01	45,1%	47,9	3,703	10986	55,85	750
CJTX-C-18/18-7,5	C	S	NO	1,01	50,7%	52,8	4,797	12451	71,73	850
CJTX-C-18/18-7,5-2V	C	S	NO	1,01	47,5%	49,4	5,123	12451	71,73	850
CJTX-C-18/18-10	C	S	NO	1,01	51,1%	52,5	6,233	13623	85,87	930
CJTX-C-18/18-10-2V	C	S	NO	1,01	47,3%	48,4	6,734	13623	85,87	930
CJTX-C-20/20-2	C	S	NO	1,00	40,0%	46,4	0,987	7226	20,05	450
CJTX-C-20/20-2-2V	C	S	NO	1,00	35,5%	41,6	1,112	7226	20,05	450
CJTX-C-20/20-3	C	S	NO	1,00	40,7%	45,8	1,583	8511	27,81	530
CJTX-C-20/20-3-2V	C	S	NO	1,00	35,6%	40,3	1,814	8511	27,81	530
CJTX-C-20/20-4	C	S	NO	1,00	41,3%	45,7	2,046	9314	33,30	580
CJTX-C-20/20-4-2V	C	S	NO	1,00	35,2%	39,2	2,400	9314	33,30	580
CJTX-C-20/20-5,5	C	S	NO	1,00	42,0%	45,4	2,963	10598	43,13	660
CJTX-C-20/20-5,5-2V	C	S	NO	1,00	37,8%	40,9	3,292	10598	43,13	660
CJTX-C-20/20-7,5	C	S	NO	1,01	42,5%	45,0	4,129	11883	54,21	740
CJTX-C-20/20-7,5-2V	C	S	NO	1,01	39,8%	42,1	4,409	11883	54,21	740
CJTX-C-20/20-10	C	S	NO	1,01	42,9%	44,5	5,472	13087	65,76	815
CJTX-C-20/20-10-2V	C	S	NO	1,01	39,7%	41,1	5,912	13087	65,76	815
CJTX-C-22/22-2	C	S	NO	1,00	41,9%	48,4	0,936	8293	17,33	380
CJTX-C-22/22-2-2V	C	S	NO	1,00	37,2%	43,3	1,054	8293	17,33	380
CJTX-C-22/22-3	C	S	NO	1,00	42,6%	48,2	1,331	9385	22,19	430
CJTX-C-22/22-3-2V	C	S	NO	1,00	37,2%	42,4	1,525	9385	22,19	430
CJTX-C-22/22-4	C	S	NO	1,00	43,2%	47,9	1,826	10476	27,65	480
CJTX-C-22/22-4-2V	C	S	NO	1,00	36,9%	41,1	2,142	10476	27,65	480
CJTX-C-22/22-5,5	C	S	NO	1,00	44,0%	48,1	2,282	11349	32,45	520
CJTX-C-22/22-5,5-2V	C	S	NO	1,00	39,6%	43,4	2,535	11349	32,45	520
CJTX-C-22/22-7,5	C	S	NO	1,00	44,5%	47,7	3,130	12658	40,37	580
CJTX-C-22/22-7,5-2V	C	S	NO	1,00	41,7%	44,7	3,343	12658	40,37	580
CJTX-C-22/22-10	C	S	NO	1,01	44,8%	47,1	4,371	14186	50,71	650
CJTX-C-22/22-10-2V	C	S	NO	1,01	41,5%	43,6	4,722	14186	50,71	650
CJTX-C-22/22-15	C	S	NO	1,01	45,4%	46,7	6,370	16150	65,72	740
CJTX-C-22/22-15-2V	C	S	NO	1,01	43,3%	44,4	6,687	16150	65,72	740
CJTX-C-22/22-20	C	S	NO	1,01	46,0%	46,9	7,362	17023	73,02	780
CJTX-C-22/22-20-2V	C	S	NO	1,01	43,1%	43,8	7,852	17023	73,02	780
CJTX-C-25/25-3	C	S	NO	1,00	40,6%	46,2	1,310	11456	17,04	340
CJTX-C-25/25-3-2V	C	S	NO	1,00	35,5%	40,7	1,500	11456	17,04	340
CJTX-C-25/25-4	C	S	NO	1,00	41,2%	45,9	1,803	12804	21,28	380
CJTX-C-25/25-4-2V	C	S	NO	1,00	35,1%	39,4	2,115	12804	21,28	380
CJTX-C-25/25-5,5	C	S	NO	1,00	41,9%	45,8	2,392	14152	26,00	420
CJTX-C-25/25-5,5-2V	C	S	NO	1,00	37,7%	41,4	2,658	14152	26,00	420
CJTX-C-25/25-7,5	C	S	NO	1,00	42,4%	45,4	3,314	15837	32,56	470
CJTX-C-25/25-7,5-2V	C	S	NO	1,00	39,7%	42,6	3,540	15837	32,56	470
CJTX-C-25/25-10	C	S	NO	1,00	42,7%	45,1	4,201	17184	38,34	510
CJTX-C-25/25-10-2V	C	S	NO	1,00	39,5%	41,7	4,539	17184	38,34	510
CJTX-C-25/25-15	C	S	NO	1,01	43,3%	44,8	5,794	19206	47,89	570

Datos del ventilador interno sin caja



## Erp. Características del punto de máxima eficiencia (BEP)

<b>MC</b>	Categoría de medición	<b><math>\eta_e</math>[%]</b>	Eficiencia
<b>EC</b>	Categoría de eficiencia	<b>N</b>	Grado de eficiencia
<b>S</b>	Estática	<b>[kW]</b>	Potencia eléctrica
<b>T</b>	Total	<b>[m³/h]</b>	Caudal
<b>VSD</b>	Variador de velocidad	<b>[mmH₂O]</b>	Presión estática o total (Según EC)
<b>SR</b>	Relación específica	<b>[RPM]</b>	Velocidad

Modelo	MC	EC	VSD	SR	$\eta_e$ [%]	N	(kW)	(m³/h)	(mmH₂O)	(RPM)
CJTX-C-25/25-15-2V	C	S	NO	1,01	41,2%	42,6	6,082	19206	47,89	570
CJTX-C-25/25-20	C	S	NO	1,01	43,8%	44,6	7,719	21228	58,50	630
CJTX-C-25/25-20-2V	C	S	NO	1,01	41,1%	41,7	8,233	21228	58,50	630
CJTX-C-30/28-3	C	S	NO	1,00	42,2%	47,7	1,376	14691	14,51	250
CJTX-C-30/28-3-2V	C	S	NO	1,00	36,9%	41,9	1,576	14691	14,51	250
CJTX-C-30/28-4	C	S	NO	1,00	42,8%	47,4	1,906	16453	18,20	280
CJTX-C-30/28-4-2V	C	S	NO	1,00	36,5%	40,6	2,235	16453	18,20	280
CJTX-C-30/28-5,5	C	S	NO	1,00	43,6%	46,6	3,354	19979	26,83	340
CJTX-C-30/28-5,5-2V	C	S	NO	1,00	39,2%	41,9	3,726	19979	26,83	340
CJTX-C-30/28-7,5	C	S	NO	1,00	44,1%	46,6	3,936	21154	30,08	360
CJTX-C-30/28-7,5-2V	C	S	NO	1,00	41,3%	43,7	4,203	21154	30,08	360
CJTX-C-30/28-10	C	S	NO	1,00	44,4%	45,9	5,768	24092	39,02	410
CJTX-C-30/28-10-2V	C	S	NO	1,00	41,1%	42,4	6,232	24092	39,02	410
CJTX-C-30/28-15	C	S	NO	1,01	45,0%	45,2	9,142	28206	53,48	480
CJTX-C-30/28-15-2V	C	S	NO	1,01	42,8%	43,0	9,597	28206	53,48	480
CJTX-C-30/28-20	C	S	NO	1,01	45,6%	45,5	11,471	30556	62,77	520
CJTX-C-30/28-20-2V	C	S	NO	1,01	42,7%	42,6	12,234	30556	62,77	520
CJTX-C-30/28-25	C	S	NO	1,01	45,1%	44,9	13,723	32319	70,22	550
CJTX-C-30/28-25-2V	C	S	NO	1,01	46,5%	46,4	13,289	32319	70,22	550

Datos del ventilador interno sin caja

## Dimensiones mm

Suministro standard impulsión horizontal (H): LG-90

VISTA EN PLANTA

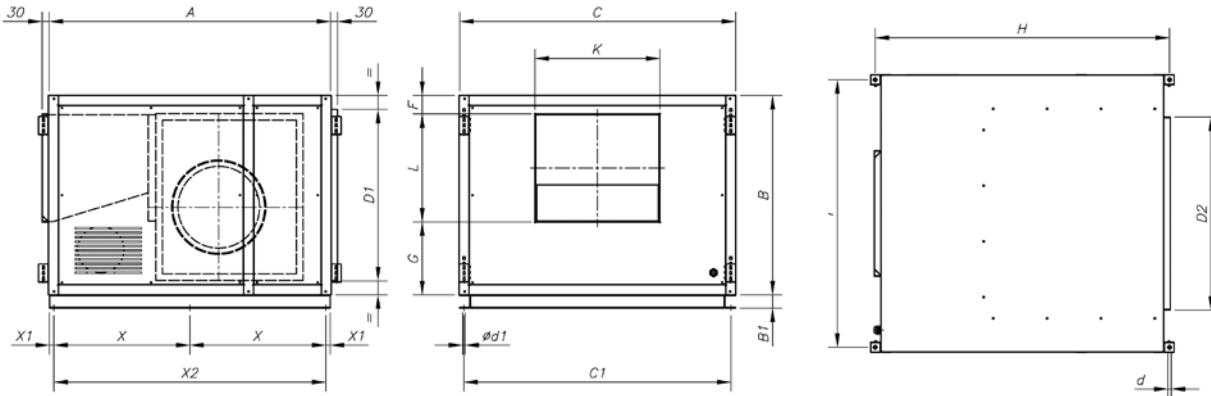

	A	B	B1	C	C1	ød	ød1	D1	D2	F	G	H	I	K	L	X	X1	X2
CJTX-C-7/7	700	480	-	730	695	10,5	9	354	470	62	202	750	685	239	216	-	-	-
CJTX-C-9/9	785	592	-	759	716	10,5	9	466	490	92	230	835	714	305	270	-	-	-
CJTX-C-10/10	860	618	-	825	782	10,5	9	492	520	87	235	910	780	334	296	-	-	-
CJTX-C-12/12	970	680	-	945	902	10,5	9	554	620	80	250	1020	900	395	350	-	-	-
CJTX-C-15/15	1100	776	-	1100	1057	10,5	9	650	720	80	285	1150	1055	483	411	-	-	-
CJTX-C-18/18	1278	900	60	1250	1207	10,5	11	774	870	95	325	1328	1205	552	480	614,5	20	1229
CJTX-C-20/20	1495	1050	60	1474	1431	13	11	954	1100	122	347	1555	1419	611	611	722,5	20	1545
CJTX-C-22/22	1640	1180	60	1625	1582	13	11	1054	1250	125	350	1700	1570	665	705	795,5	20	1591
CJTX-C-25/25	1800	1300	60	1825	1782	13	11	1174	1450	125	369	1860	1770	775	806	875,5	20	1751
CJTX-C-30/28	2000	1525	60	2134	2091	13	11	1399	1760	118	465	2060	2079	900	942	975,5	20	1951

## Dimensiones mm

Suministro bajo demanda: Impulsión vertical(V): LG-0

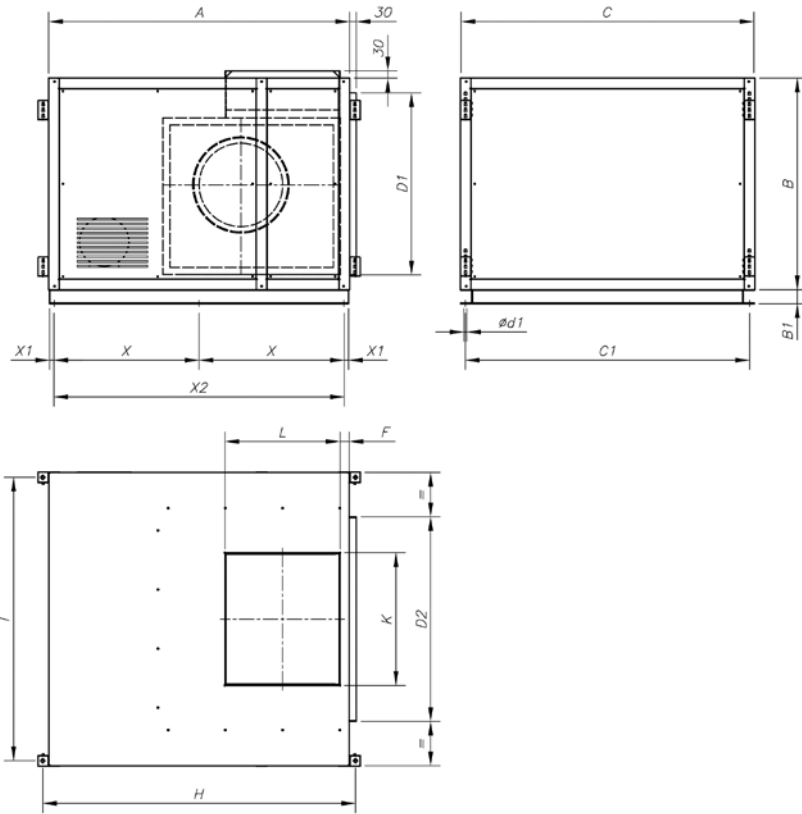

	A	B	B1	C	C1	Ød	Ød1	D1	D2	F	H	I	K	L	X	X1	X2
CJTX-C-7/7	700	480	-	730	695	10,5	9	354	470	165	750	685	238	210	-	-	-
CJTX-C-9/9	785	592	-	759	716	10,5	9	466	490	157	835	714	312	272	-	-	-
CJTX-C-10/10	860	618	-	825	782	10,5	9	492	520	135	910	780	333	300	-	-	-
CJTX-C-12/12	970	680	-	945	902	10,5	9	554	620	183	1020	900	397	355	-	-	-
CJTX-C-15/15	1100	776	-	1100	1057	10,5	9	650	720	197	1150	1055	479	421	-	-	-
CJTX-C-18/18	1278	900	60	1250	1207	10,5	11	774	870	281	1328	1205	550	495	614,5	20	1229
CJTX-C-20/20	1495	1050	60	1474	1431	13	11	954	1100	283	1555	1419	610	611	722,5	20	1545
CJTX-C-22/22	1640	1180	60	1625	1582	13	11	1054	1250	325	1700	1570	666	701	795,5	20	1591
CJTX-C-25/25	1800	1300	60	1825	1782	13	11	1174	1450	367	1860	1770	775	798	875,5	20	1751
CJTX-C-30/28	2000	1525	60	2134	2091	13	11	1399	1760	407	2060	2079	894	947	975,5	20	1951

**Curvas características**

Q= Caudal en m<sup>3</sup>/h, m<sup>3</sup>/s y cfm.

Pe= Presión estática en mmH<sub>2</sub>O, Pa e inwg.

**CJTX-C-7/7**

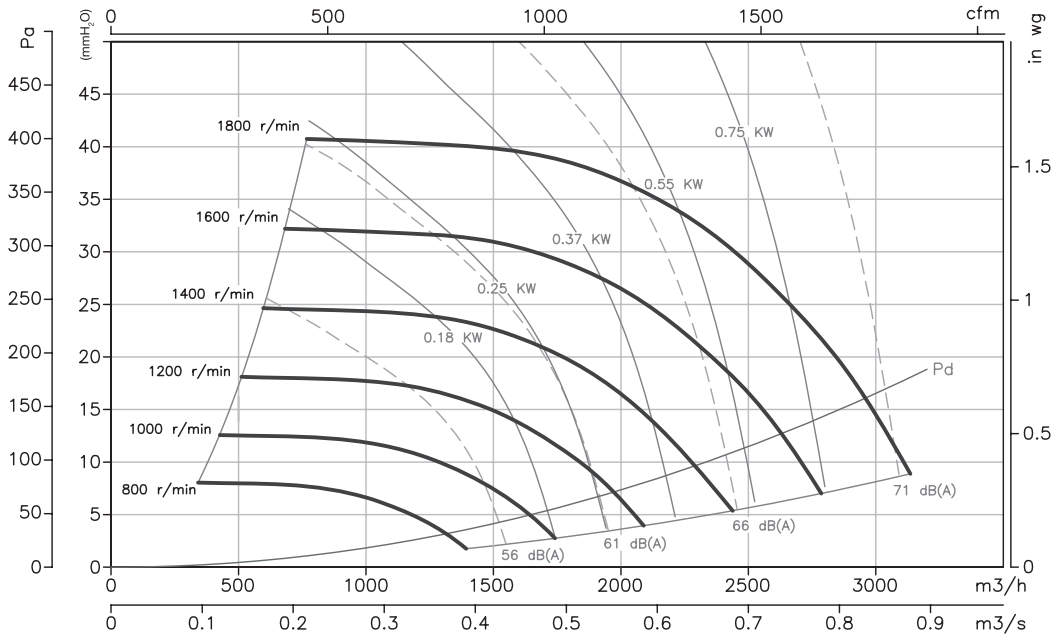

**CJTX-C-9/9**

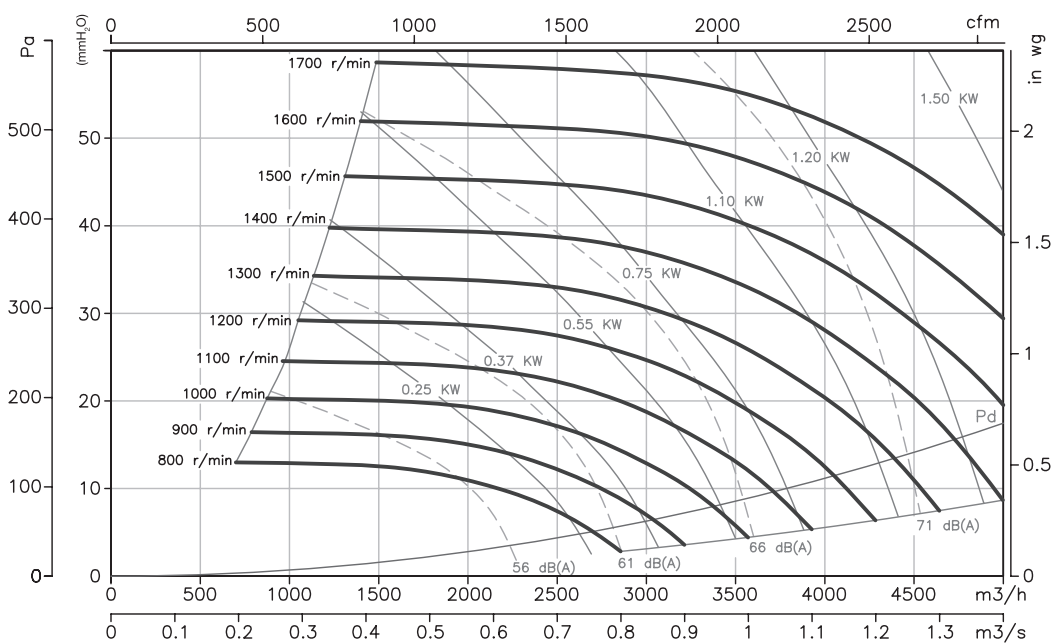

**Curvas características**

Q= Caudal en m<sup>3</sup>/h, m<sup>3</sup>/s y cfm.

Pe= Presión estática en mmH<sub>2</sub>O, Pa e inwg.

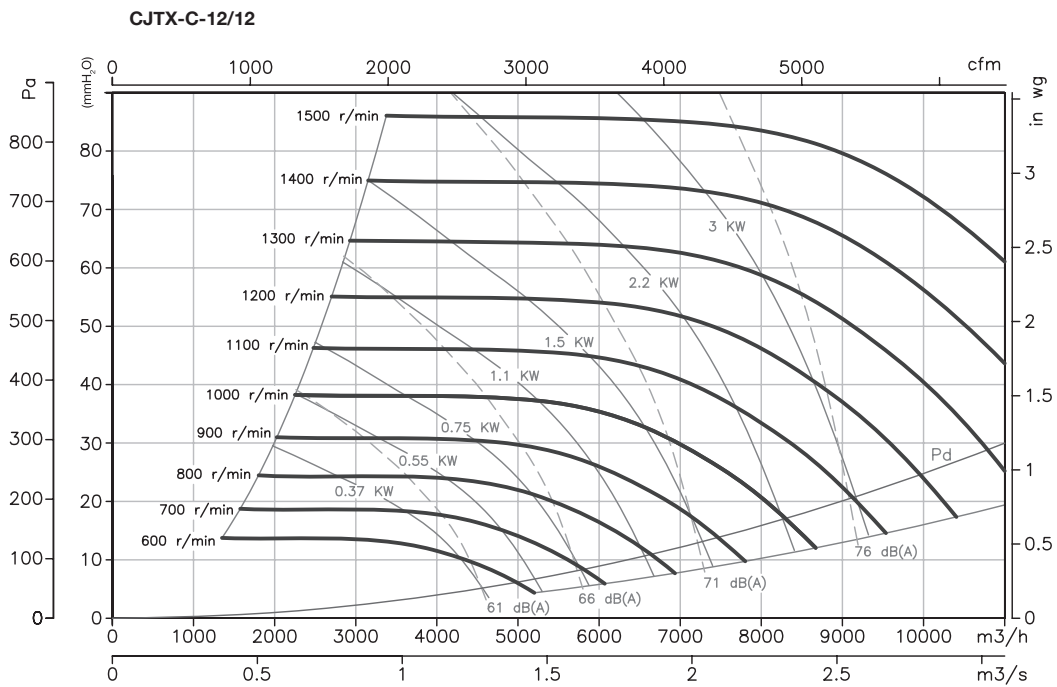
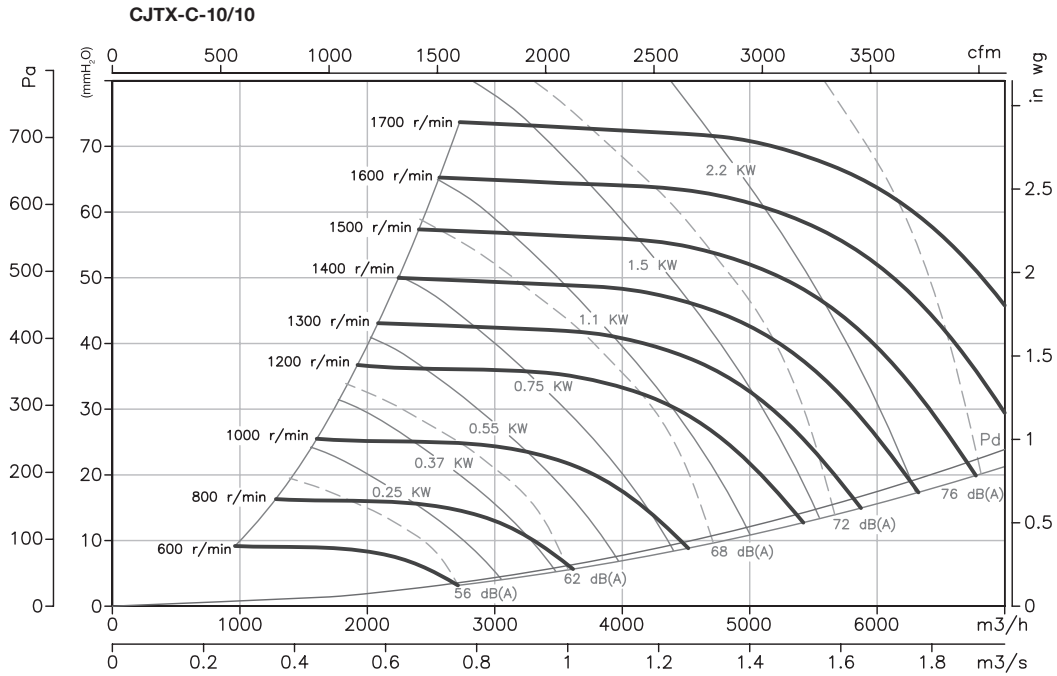

**Curvas características**

Q= Caudal en m<sup>3</sup>/h, m<sup>3</sup>/s y cfm.

Pe= Presión estática en mmH<sub>2</sub>O, Pa e inwg.

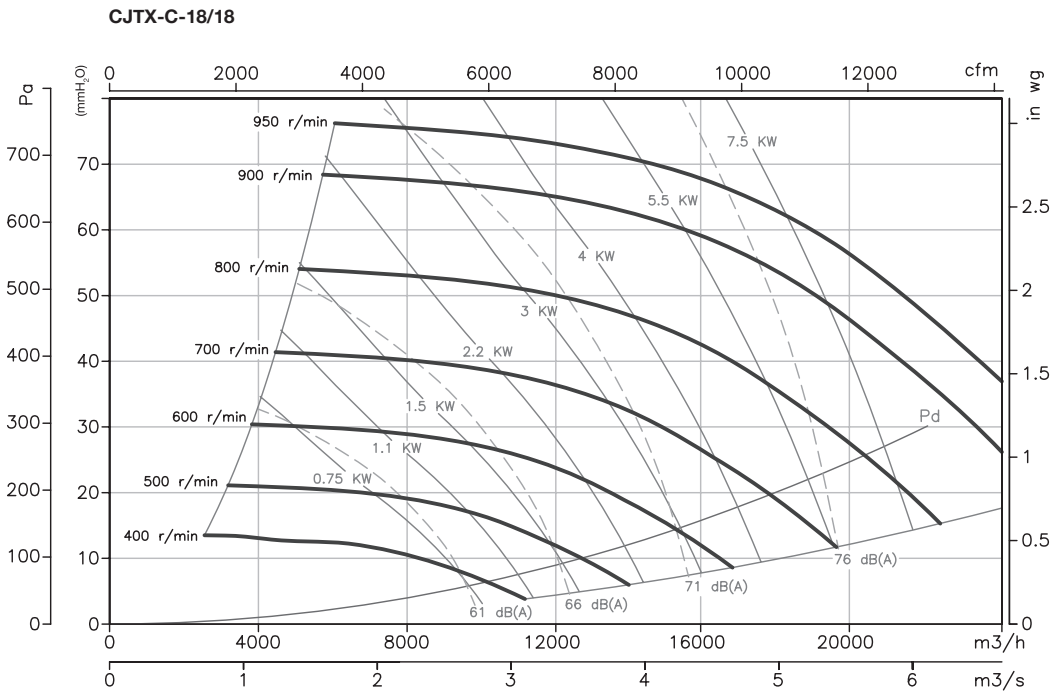
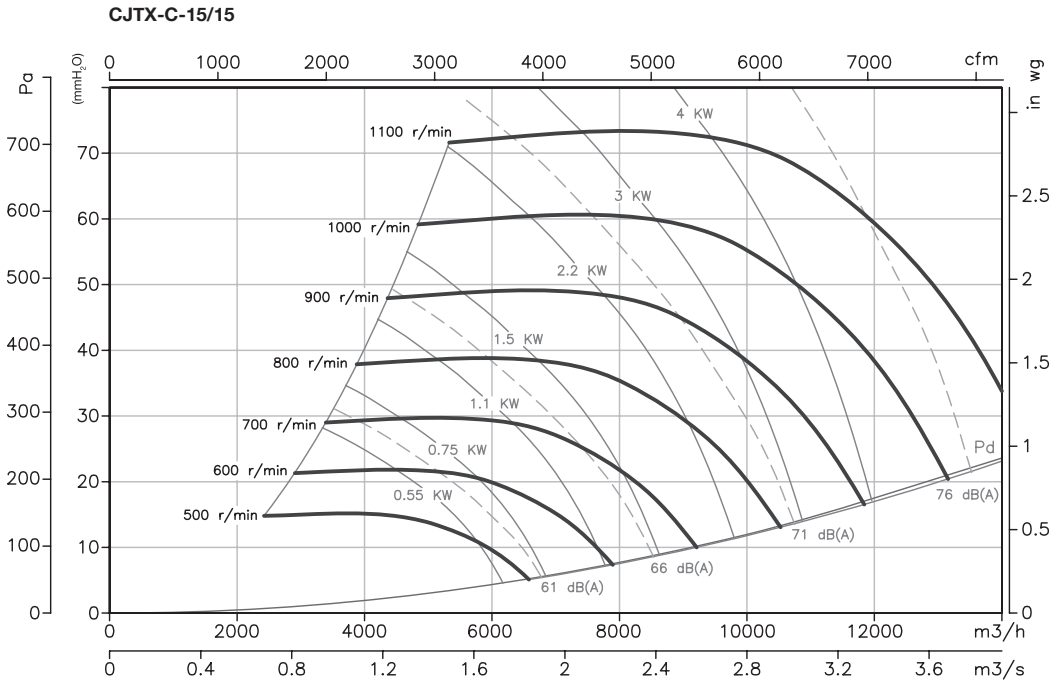



## Curvas características

Q= Caudal en m<sup>3</sup>/h, m<sup>3</sup>/s y cfm.

Pe= Presión estática en mmH<sub>2</sub>O, Pa e inwg.

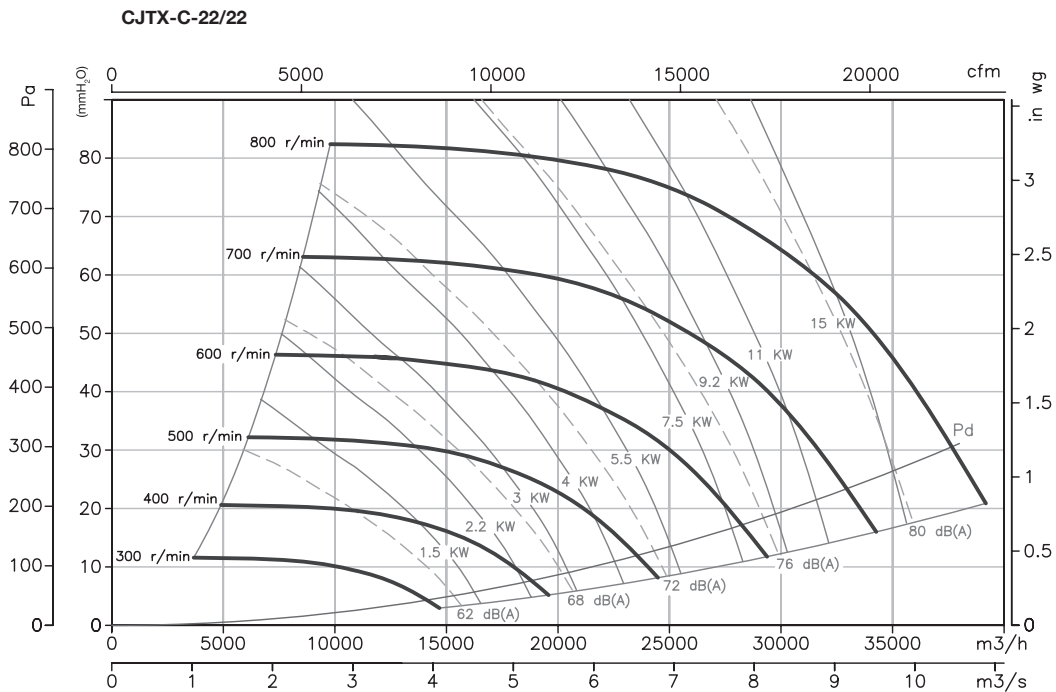
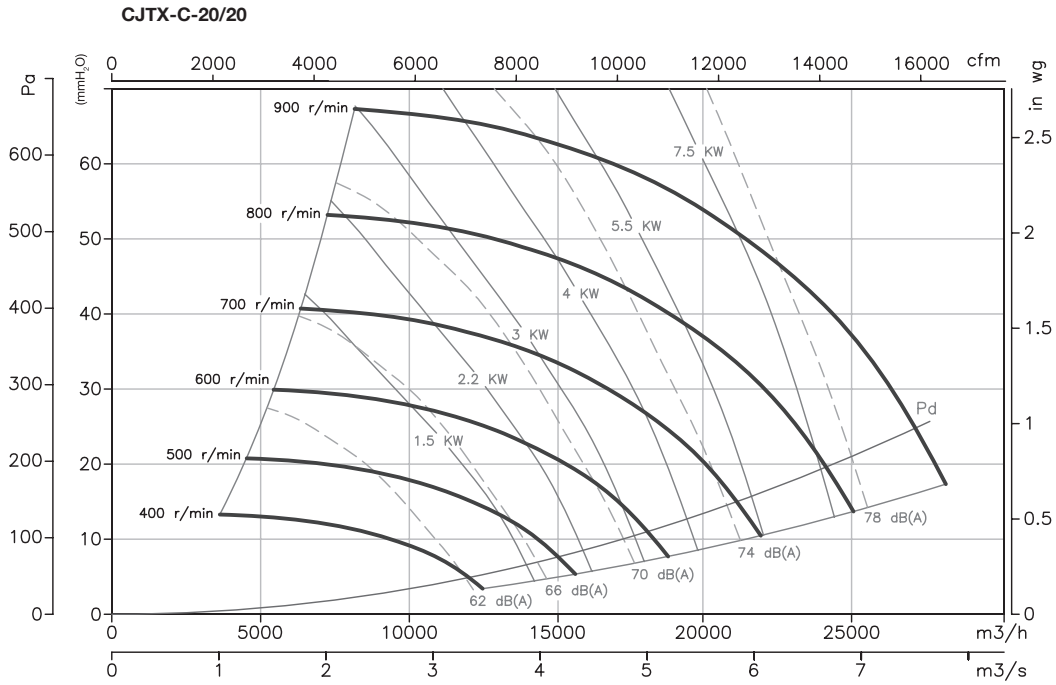

**Curvas características**

Q= Caudal en m<sup>3</sup>/h, m<sup>3</sup>/s y cfm.

Pe= Presión estática en mmH<sub>2</sub>O, Pa e inwg.

**CJTX-C-25/25**

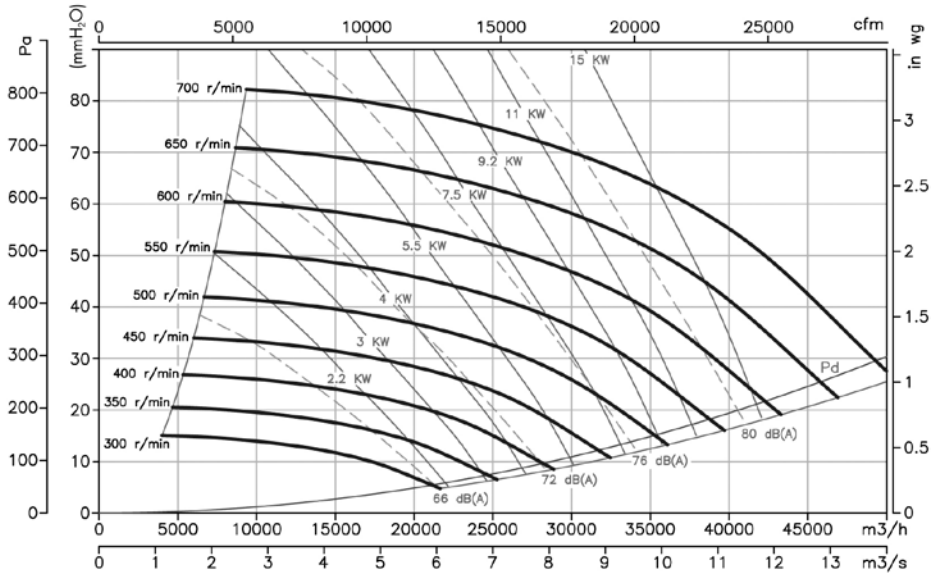

**CJTX-C-30/28**

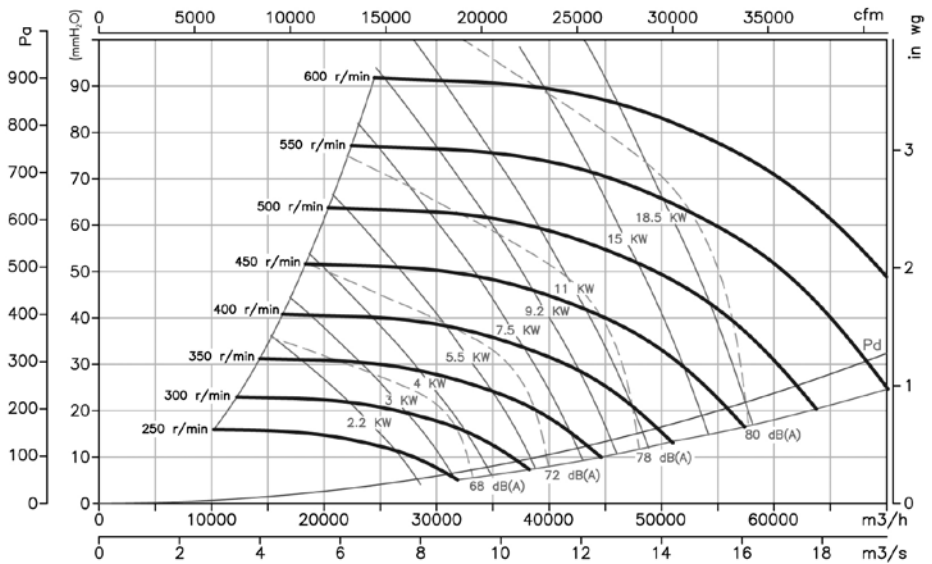

**Accesorios**

Ver apartado accesorios



# CJSX



Motor fuera del paso del aire

## Unidades de extracción 400°C/2h, a transmisión con ventilador de simple aspiración

Unidades de extracción 400°C/2h, con motor fuera del paso del aire, para trabajar en el exterior de la zona de riesgo de incendios

### Ventilador:

- Estructura en chapa de acero galvanizado
- Turbina con álabes hacia delante, en chapa de acero galvanizado
- Homologación según norma EN 12101-3:2002/AC:2006, con certificación N°: 0370-CPR-0503

### Motor:

- Motores clase F, con rodamientos a bolas, protección IP55
- Trifásicos 230/400V.-50Hz.(hasta 5,5CV) y 400/690V.-50Hz.(potencias superiores a 5,5CV)
- Temperatura máxima del aire a transportar: Servicio S1 -20°C+ 120°C en continuo, Servicio S2 200°C/2h, 300°C/2h y 400°C/2h

### Acabado:

- Anticorrosivo en chapa de acero galvanizado

### Bajo demanda:

- Extractores con motor de 2 velocidades
- Extractores con salida vertical

## Código de pedido

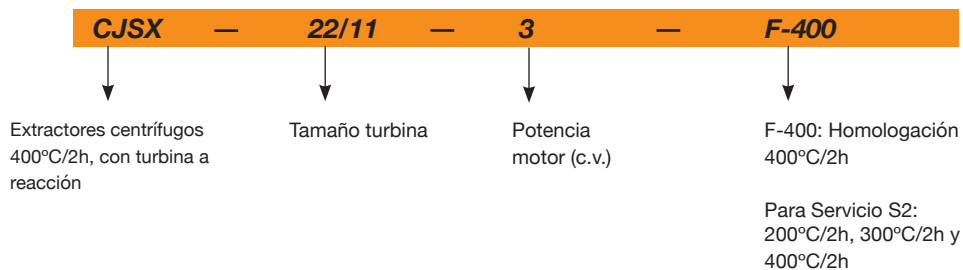

## Características técnicas

Modelo	Velocidad (r/min)	Intensidad máxima admisible (A)			Potencia instalada (kW)	Caudal máximo (m³/h)	Nivel presión sonora dB(A)	Peso aprox. (Kg)
		230V	400V (A)	690V				
CJSX-12/6-0,75	1000	2,28	1,31		0,55	2600	69	73
CJSX-12/6-1	1100	3,10	1,79		0,75	3100	71	74
CJSX-12/6-1,5	1250	4,03	2,32		1,10	3500	74	77
CJSX-12/6-2	1300	5,96	3,44		1,50	4250	77	80
CJSX-12/6-3	1500	8,36	4,83		2,20	4800	79	85
CJSX-15/7-1	800	3,10	1,79		0,75	4000	67	92
CJSX-15/7-1,5	850	4,03	2,32		1,10	4800	69	95
CJSX-15/7-2	920	5,96	3,44		1,50	5400	72	98
CJSX-15/7-3	1000	8,36	4,83		2,20	6400	75	103
CJSX-15/7-4	1050	10,96	6,33		3,00	7400	77	106
CJSX-18/9-1,5	750	4,03	2,32		1,10	5800	68	111
CJSX-18/9-2	790	5,96	3,44		1,50	6600	70	114
CJSX-18/9-3	800	8,36	4,83		2,20	8200	74	119
CJSX-18/9-4	850	10,96	6,33		3,00	9000	76	122
CJSX-18/9-5,5	920	14,10	8,12		4,00	10500	78	125
CJSX-20/10-2	650	5,96	3,44		1,50	8100	65	203
CJSX-20/10-3	690	8,36	4,83		2,20	10100	68	208
CJSX-20/10-4	750	10,96	6,33		3,00	11500	70	211
CJSX-20/10-5,5	790	14,10	8,12		4,00	13100	73	214

### Características técnicas

Modelo	Velocidad (r/min)	Intensidad máxima admisible (A)			Potencia instalada (kW)	Caudal máximo (m³/h)	Nivel presión sonora dB(A)	Peso aprox. (Kg)
		230V	400V (A)	690V				
CJSX-20/10-7,5	850		11,60	6,72	5,50	15000	75	227
CJSX-22/11-3	580	8,36	4,83		2,20	11200	67	219
CJSX-22/11-4	610	10,96	6,33		3,00	13000	70	222
CJSX-22/11-5,5	650	14,10	8,12		4,00	15000	72	225
CJSX-22/11-7,5	690		11,60	6,72	5,50	17000	74	238
CJSX-22/11-10	750		14,20	8,20	7,50	19000	76	246
CJSX-22/11-15	830		20,20	11,60	11,00	22000	79	273
CJSX-22/11-20	910		27,50	15,90	15,00	24500	81	292
CJSX-22/11-25	1000		35,00	20,00	18,50	26000	83	322
CJSX-25/13-4	520	10,96	6,33		3,00	14000	62	254
CJSX-25/13-5,5	550	14,10	8,12		4,00	17000	65	257
CJSX-25/13-7,5	590		11,60	6,72	5,50	19500	67	270
CJSX-25/13-10	620		14,20	8,20	7,50	23000	70	278
CJSX-25/13-15	690		20,20	11,60	11,00	26500	74	305
CJSX-25/13-20	750		27,50	15,90	15,00	29500	75	324
CJSX-25/13-25	810		35,00	20,00	18,50	32000	77	354
CJSX-30/14-5,5	400	14,10	8,12		4,00	21000	69	331
CJSX-30/14-7,5	425		11,60	6,72	5,50	24000	72	344
CJSX-30/14-10	460		14,20	8,20	7,50	27500	74	352
CJSX-30/14-15	500		20,20	11,60	11,00	33000	77	379
CJSX-30/14-20	550		27,50	15,90	15,00	36500	78	398
CJSX-30/14-25	600		35,00	20,00	18,50	38000	81	428



### Erp. Características del punto de máxima eficiencia (BEP)

<b>MC</b>	Categoría de medición	<b>ηe[%]</b>	Eficiencia
<b>EC</b>	Categoría de eficiencia	<b>N</b>	Grado de eficiencia
<b>S</b>	Estática	<b>[kW]</b>	Potencia eléctrica
<b>T</b>	Total	<b>[m³/h]</b>	Caudal
<b>VSD</b>	Variador de velocidad	<b>[mmH₂O]</b>	Presión estática o total (Según EC)
<b>SR</b>	Relación específica	<b>[RPM]</b>	Velocidad

Modelo	MC	EC	VSD	SR	ηe[%]	N	(kW)	(m³/h)	(mmH₂O)	(RPM)
CJSX-12/6-0,75	C	S	NO	1,00	36,0%	44,7	0,423	1532	36,46	1000
CJSX-12/6-1	C	S	NO	1,00	40,4%	48,6	0,502	1685	44,12	1100
CJSX-12/6-1,5	C	S	NO	1,01	41,6%	48,9	0,715	1915	56,97	1250
CJSX-12/6-2	C	S	NO	1,01	42,0%	49,0	0,796	1992	61,62	1300
CJSX-12/6-3	C	S	NO	1,01	42,8%	48,6	1,201	2298	82,04	1500
CJSX-15/7-1	C	S	NO	1,00	45,9%	54,7	0,403	2011	33,76	800
CJSX-15/7-1,5	C	S	NO	1,00	47,3%	55,7	0,469	2137	38,11	850
CJSX-15/7-2	C	S	NO	1,00	47,8%	55,5	0,589	2313	44,64	920
CJSX-15/7-3	C	S	NO	1,01	48,6%	55,8	0,743	2514	52,74	1000
CJSX-15/7-4	C	S	NO	1,01	49,3%	56,1	0,848	2639	58,15	1050
CJSX-18/9-1,5	C	S	NO	1,00	56,0%	63,6	0,622	2983	42,82	750
CJSX-18/9-2	C	S	NO	1,00	56,5%	63,8	0,720	3143	47,51	790
CJSX-18/9-3	C	S	NO	1,00	57,6%	64,7	0,734	3182	48,72	800
CJSX-18/9-4	C	S	NO	1,01	58,4%	65,1	0,868	3381	55,00	850
CJSX-18/9-5,5	C	S	NO	1,01	59,4%	65,5	1,082	3660	64,44	920
CJSX-20/10-2	C	S	NO	1,00	58,5%	66,0	0,647	3584	38,75	650
CJSX-20/10-3	C	S	NO	1,00	59,5%	66,6	0,761	3804	43,67	690
CJSX-20/10-4	C	S	NO	1,01	60,4%	66,8	0,963	4135	51,59	750
CJSX-20/10-5,5	C	S	NO	1,01	61,4%	67,5	1,106	4356	57,24	790
CJSX-20/10-7,5	C	S	NO	1,01	62,2%	67,7	1,360	4686	66,27	850
CJSX-22/11-3	C	S	NO	1,00	49,8%	55,0	1,471	6976	38,50	580
CJSX-22/11-4	C	S	NO	1,00	50,6%	55,5	1,684	7337	42,59	610
CJSX-22/11-5,5	C	S	NO	1,01	51,6%	56,1	1,996	7818	48,36	650
CJSX-22/11-7,5	C	S	NO	1,01	52,4%	56,4	2,352	8299	54,49	690
CJSX-22/11-10	C	S	NO	1,01	53,1%	56,5	2,980	9021	64,38	750
CJSX-22/11-15	C	S	NO	1,01	54,3%	56,8	3,952	9983	78,85	830
CJSX-22/11-20	C	S	NO	1,01	55,4%	57,2	5,105	10946	94,78	910
CJSX-22/11-25	C	S	NO	1,01	55,3%	56,4	6,785	12028	114,46	1000
CJSX-25/13-4	C	S	NO	1,00	47,2%	52,3	1,546	6778	39,51	520
CJSX-25/13-5,5	C	S	NO	1,00	48,2%	52,9	1,793	7169	44,20	550
CJSX-25/13-7,5	C	S	NO	1,01	48,9%	53,1	2,181	7691	50,87	590
CJSX-25/13-10	C	S	NO	1,01	49,4%	53,2	2,503	8082	56,17	620
CJSX-25/13-15	C	S	NO	1,01	50,5%	53,5	3,379	8994	69,57	690



**Erp. Características del punto de máxima eficiencia (BEP)**

Modelo	MC	EC	VSD	SR	$\eta_e$ [%]	N	(kW)	(m <sup>3</sup> /h)	(mmH <sub>2</sub> O)	(RPM)
CJSX-25/13-20	C	S	NO	1,01	51,3%	53,7	4,264	9776	82,20	750
CJSX-25/13-25	C	S	NO	1,01	51,5%	53,3	5,354	10558	95,87	810
CJSX-30/14-5,5	C	S	NO	1,00	50,3%	54,5	2,235	11535	35,79	400
CJSX-30/14-7,5	C	S	NO	1,00	51,1%	54,8	2,640	12256	40,40	425
CJSX-30/14-10	C	S	NO	1,01	51,8%	54,9	3,300	13265	47,33	460
CJSX-30/14-15	C	S	NO	1,01	52,9%	55,3	4,152	14419	55,91	500
CJSX-30/14-20	C	S	NO	1,01	54,0%	55,7	5,410	15861	67,66	550
CJSX-30/14-25	C	S	NO	1,01	53,8%	54,8	7,056	17303	80,52	600

**Dimensiones mm**

Suministro standard impulsión horizontal (H) RD-90

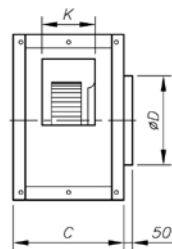
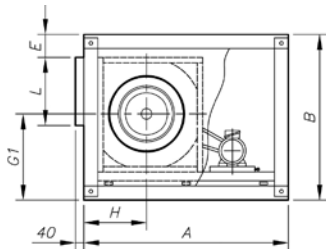

Bajo demanda impulsión vertical (V) RD-90

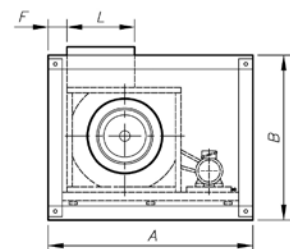
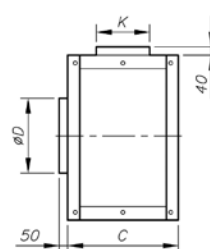

Bajo demanda impulsión horizontal (H) LG-90

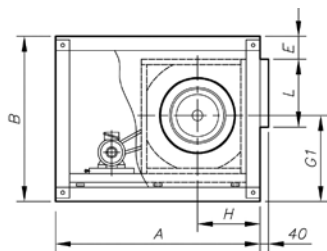
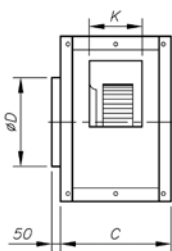

Bajo demanda impulsión vertical (V) LG-90

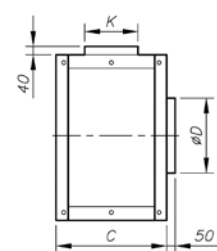
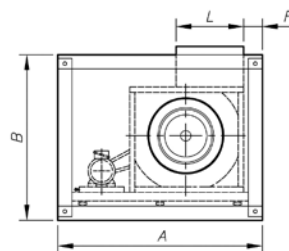

Modelo	A	B	C	ØD	E	con bancada E	F	G1	con bancada G1	H	L	con bancada L	K
CJSX-12/6-H	850	650	540	330	74	-	-	288	-	288	346	-	210
CJSX-12/6-V	850	650	540	330	-	-	30	318	-	328	346	-	210
CJSX-15/7-H	1000	755	600	400	74	-	-	328	-	328	411	-	270
CJSX-15/7-V	1000	755	600	400	-	-	30	378	-	383	411	-	270
CJSX-18/9-H	1200	875	620	480	74	-	-	383	-	388	491	-	305
CJSX-18/9-V	1200	875	620	480	-	-	30	433	-	448	491	-	305
CJSX-20/10-H	1485	1175	730	565	175	120	-	475	530	440	613	605	343
CJSX-20/10-V	1485	1175	730	565	-	-	75	535	-	585	613	-	343
CJSX-22/11-H	1570	1250	760	615	165	110	-	510	565	470	708	700	373
CJSX-22/11-V	1570	1250	760	615	-	-	75	570	-	640	708	-	373
CJSX-25/13-H	1610	1375	820	685	175	120	-	550	605	495	803	795	423
CJSX-25/13-V	1610	1375	820	685	-	-	75	625	-	705	803	-	423
CJSX-30/14-H	1845	1600	855	820	160	95	-	655	710	580	943	935	488
CJSX-30/14-V	1845	1600	855	820	-	-	75	760	-	825	943	-	488

**Curvas características**

Q= Caudal en m<sup>3</sup>/h, m<sup>3</sup>/s y cfm.

Pe= Presión estática en mmH<sub>2</sub>O, Pa e inwg.

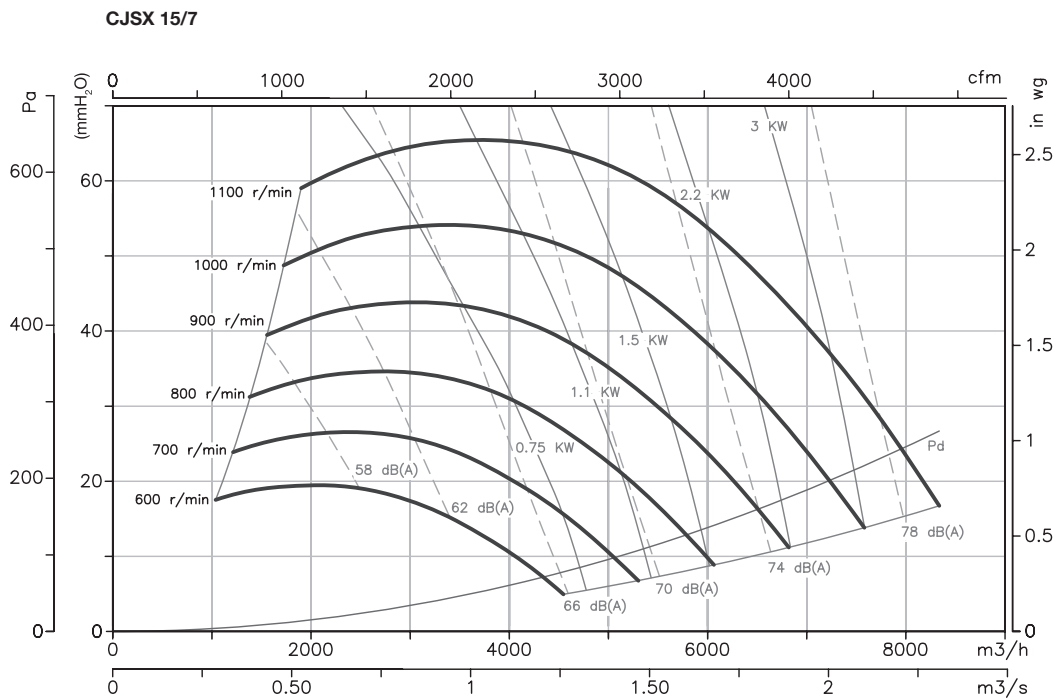
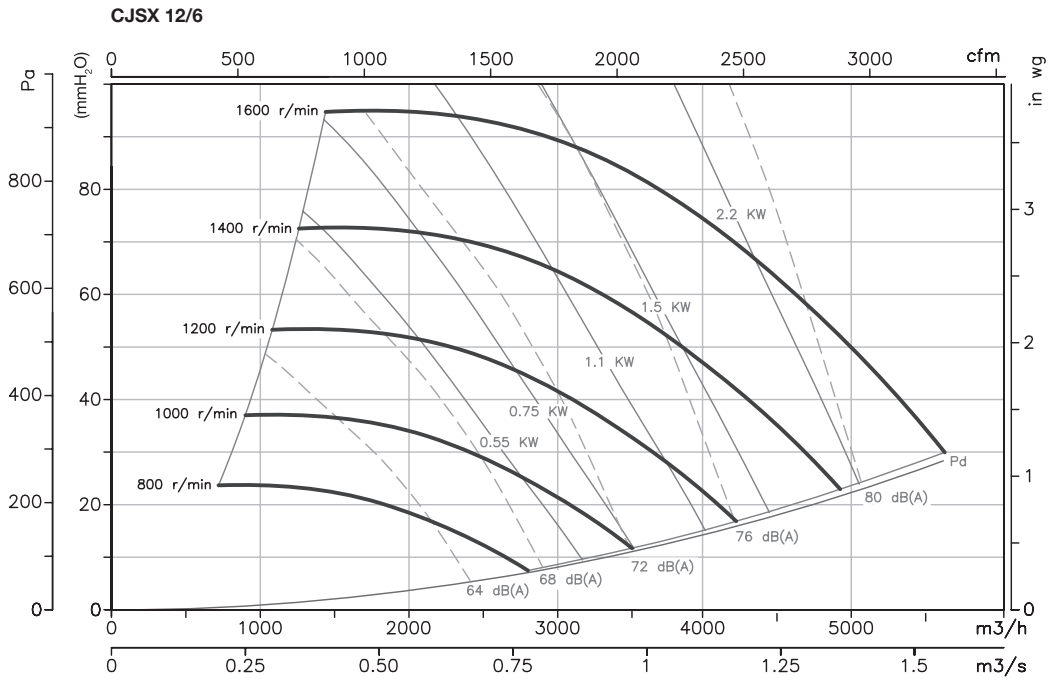

**Curvas características**

Q= Caudal en m<sup>3</sup>/h, m<sup>3</sup>/s y cfm.

Pe= Presión estática en mmH<sub>2</sub>O, Pa e inwg.

**CJSX 18/9**

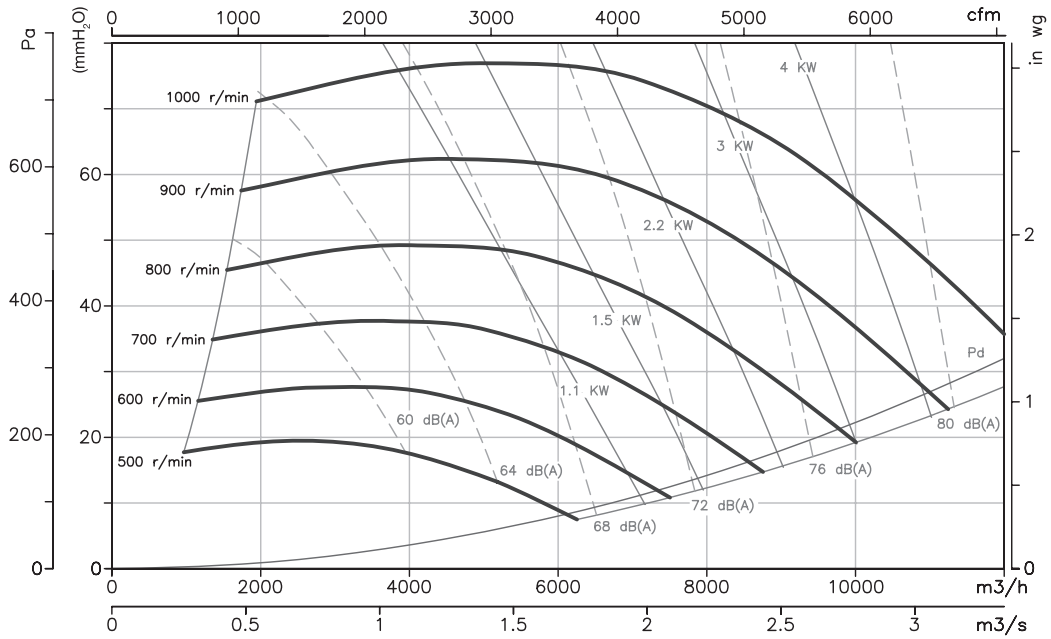

**CJSX 20/10**

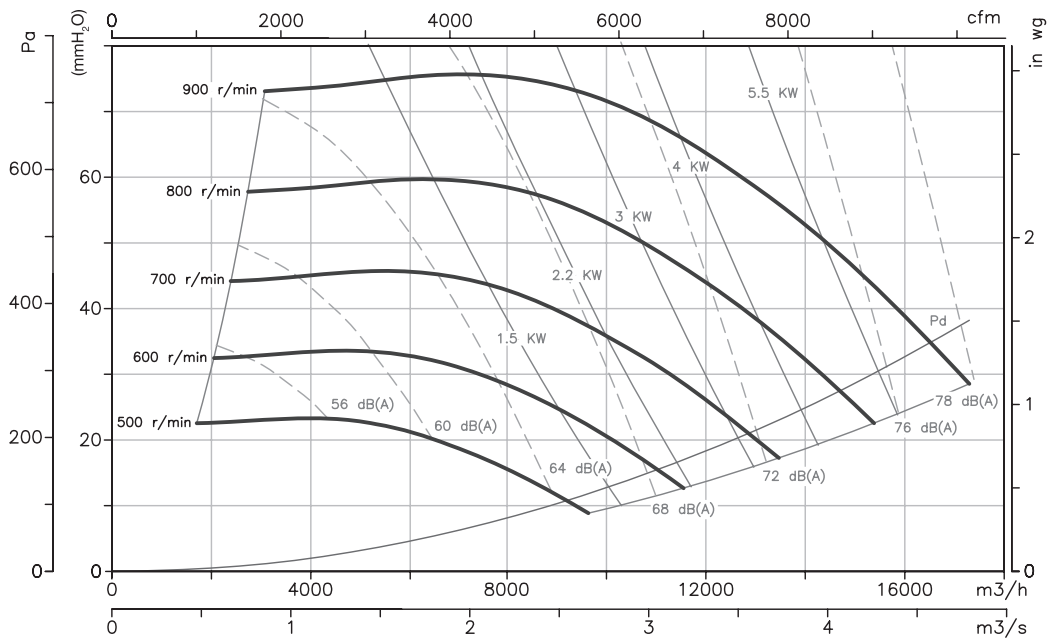

**Curvas características**

Q= Caudal en m<sup>3</sup>/h, m<sup>3</sup>/s y cfm.

Pe= Presión estática en mmH<sub>2</sub>O, Pa e inwg.

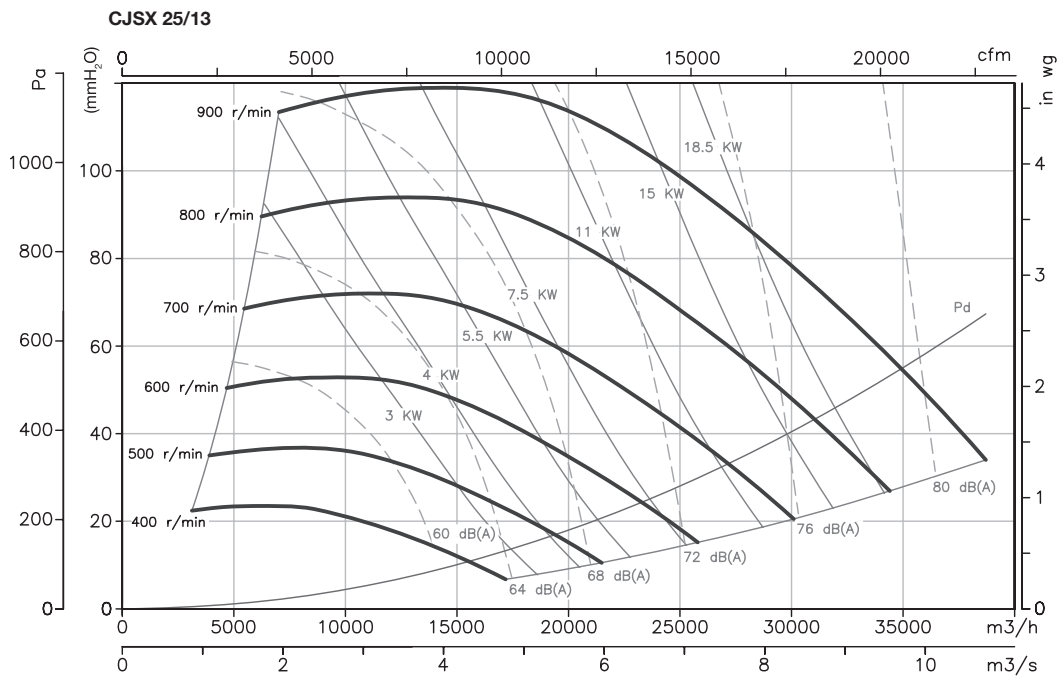
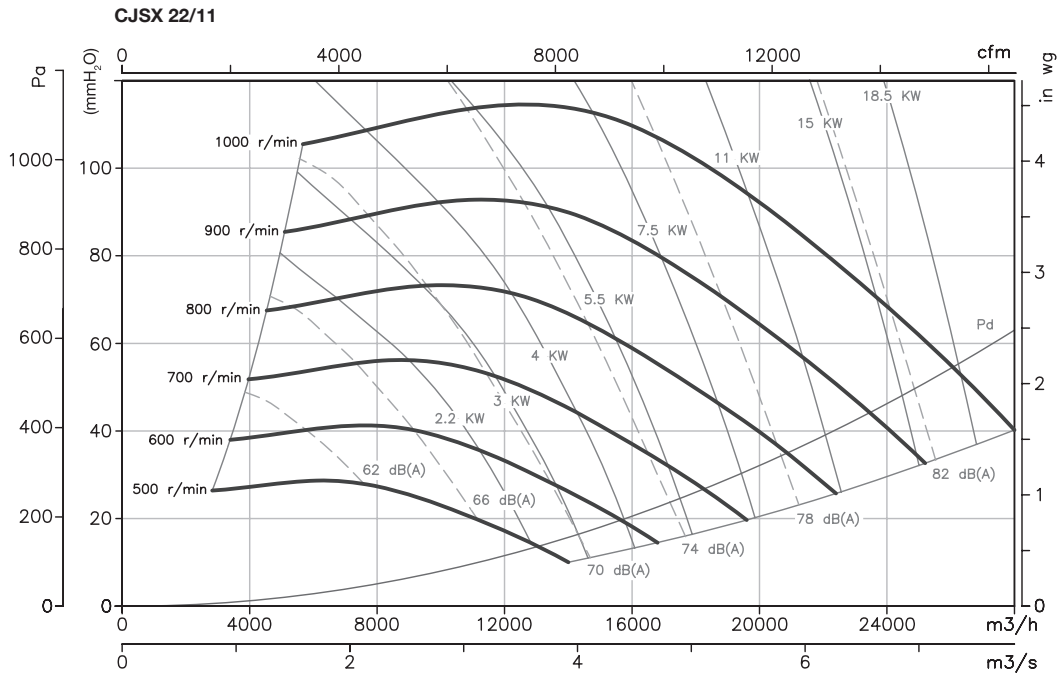



**Curvas características**

Q= Caudal en m<sup>3</sup>/h, m<sup>3</sup>/s y cfm.

Pe= Presión estática en mmH<sub>2</sub>O, Pa e inwg.

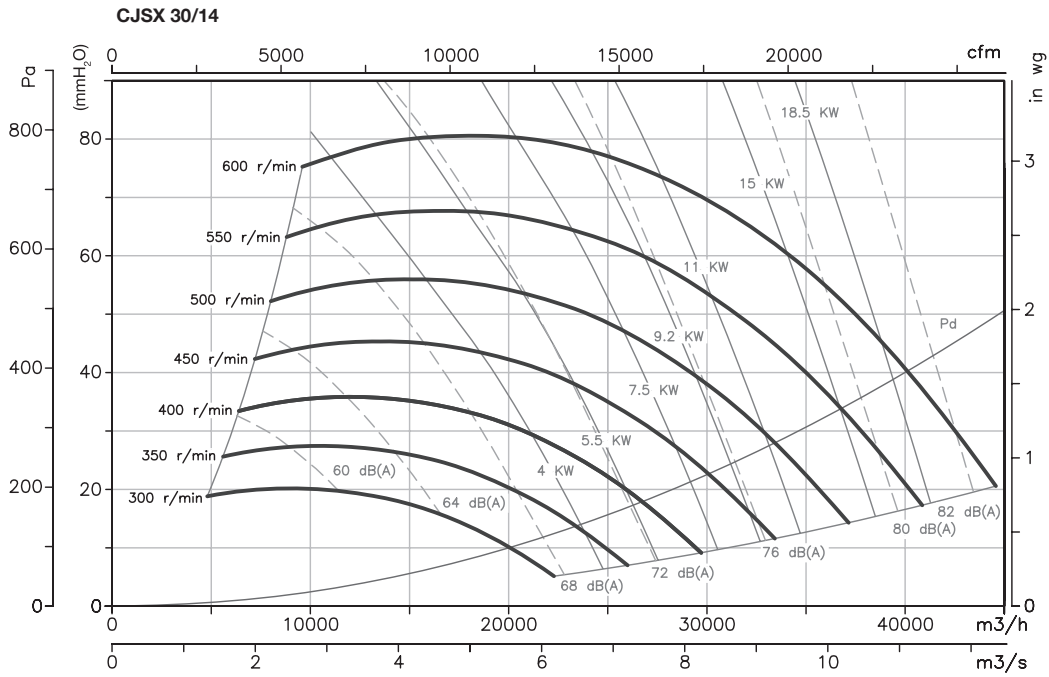

**Accesorios**

Ver apartado accesorios



# CJSX-SILENT



**Unidades de extracción 400°C/2h, a transmisión con ventilador de simple aspiración, en chapa prelacada, con doble pared de aislante acústico de 40 mm.**

Unidades de extracción 400°C/2h, con motor fuera del paso del aire, para trabajar en el exterior de la zona de riesgo de incendios

#### Ventilador:

- Estructura en perfilería de aluminio
- Doble pared de aislante acústico de 40mm y chapa perforada
- Turbina con álabes hacia delante, en chapa de acero galvanizado
- Homologación según norma EN 12101-3:2002/AC:2006, con certificación N°: 0370-CPR-0503

#### Motor:

- Motores eficiencia IE-2, excepto potencias inferiores a 0,75 kw, monofásicos, y 2 velocidades
- Motores clase F, con rodamientos a bolas, protección IP55
- Trifásicos 230/400V.-50Hz.(hasta 5,5CV.) y 400/690V.-50Hz.(potencias superiores a 5,5CV.)
- Temperatura máxima del aire a transportar:

Servicio S1 -20°C+ 120°C en continuo, Servicio S2 200°C/2h, 300°C/2h y 400°C/2h

#### Acabado:

- Anticorrosivo en chapa de acero prelacada

#### Bajo demanda:

- Extractores con motor de 2 velocidades
- Extractores con salida vertical

### Código de pedido

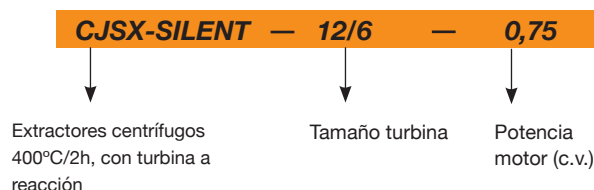

### Características técnicas

Modelo	Velocidad (r/min)	Intensidad máxima admisible (A)			Potencia instalada (kW)	Caudal máximo (m³/h)	Nivel presión sonora dB(A)	Peso aprox. (Kg)
		230V	400V (A)	690V				
CJSX-SILENT-12/6-0.75	1000	2,28	1,31		0,55	2600	63	82
CJSX-SILENT-12/6-1	1100	3,10	1,79		0,75	3100	65	83
CJSX-SILENT-12/6-1.5	1250	4,03	2,32		1,10	3500	68	86
CJSX-SILENT-12/6-2	1300	5,96	3,44		1,50	4250	71	89
CJSX-SILENT-12/6-3	1500	8,36	4,83		2,20	4800	73	94
CJSX-SILENT-15/7-1	800	3,10	1,79		0,75	4000	60	103
CJSX-SILENT-15/7-1.5	850	4,03	2,32		1,10	4800	62	106
CJSX-SILENT-15/7-2	920	5,96	3,44		1,50	5400	65	109
CJSX-SILENT-15/7-3	1000	8,36	4,83		2,20	6400	68	114
CJSX-SILENT-15/7-4	1050	10,96	6,33		3,00	7400	70	117
CJSX-SILENT-18/9-1.5	750	4,03	2,32		1,10	5800	62	126
CJSX-SILENT-18/9-2	790	5,96	3,44		1,50	6600	64	129
CJSX-SILENT-18/9-3	800	8,36	4,83		2,20	8200	68	134
CJSX-SILENT-18/9-4	850	10,96	6,33		3,00	9000	70	137
CJSX-SILENT-18/9-5.5	920	14,10	8,12		4,00	10500	72	140
CJSX-SILENT-20/10-2	650	5,96	3,44		1,50	8100	58	226
CJSX-SILENT-20/10-3	690	8,36	4,83		2,20	10100	61	231
CJSX-SILENT-20/10-4	750	10,96	6,33		3,00	11500	63	234
CJSX-SILENT-20/10-5.5	790	14,10	8,12		4,00	13100	66	237
CJSX-SILENT-20/10-7.5	850		11,60	6,72	5,50	15000	68	250



## Erp. Características del punto de máxima eficiencia (BEP)

<b>MC</b>	Categoría de medición	<b><math>\eta_e</math>[%]</b>	Eficiencia
<b>EC</b>	Categoría de eficiencia	<b>N</b>	Grado de eficiencia
<b>S</b>	Estática	<b>[kW]</b>	Potencia eléctrica
<b>T</b>	Total	<b>[m³/h]</b>	Caudal
<b>VSD</b>	Variador de velocidad	<b>[mmH₂O]</b>	Presión estática o total (Según EC)
<b>SR</b>	Relación específica	<b>[RPM]</b>	Velocidad

Modelo	MC	EC	VSD	SR	$\eta_e$ [%]	N	(kW)	(m³/h)	(mmH₂O)	(RPM)
CJSX-SILENT-12/6-0.75	C	S	NO	1,00	36,0%	44,7	0,423	1532	36,46	1000
CJSX-SILENT-12/6-1	C	S	NO	1,00	40,4%	48,6	0,502	1685	44,12	1100
CJSX-SILENT-12/6-1.5	C	S	NO	1,01	41,6%	48,9	0,715	1915	56,97	1250
CJSX-SILENT-12/6-2	C	S	NO	1,01	42,0%	49,0	0,796	1992	61,62	1300
CJSX-SILENT-12/6-3	C	S	NO	1,01	42,8%	48,6	1,201	2298	82,04	1500
CJSX-SILENT-15/7-1	C	S	NO	1,00	45,9%	54,7	0,403	2011	33,76	800
CJSX-SILENT-15/7-1.5	C	S	NO	1,00	47,3%	55,7	0,469	2137	38,11	850
CJSX-SILENT-15/7-2	C	S	NO	1,00	47,8%	55,5	0,589	2313	44,64	920
CJSX-SILENT-15/7-3	C	S	NO	1,01	48,6%	55,8	0,743	2514	52,74	1000
CJSX-SILENT-15/7-4	C	S	NO	1,01	49,3%	56,1	0,848	2639	58,15	1050
CJSX-SILENT-18/9-1.5	C	S	NO	1,00	56,0%	63,6	0,622	2983	42,82	750
CJSX-SILENT-18/9-2	C	S	NO	1,00	56,5%	63,8	0,720	3143	47,51	790
CJSX-SILENT-18/9-3	C	S	NO	1,00	57,6%	64,7	0,734	3182	48,72	800
CJSX-SILENT-18/9-4	C	S	NO	1,01	58,4%	65,1	0,868	3381	55,00	850
CJSX-SILENT-18/9-5.5	C	S	NO	1,01	59,4%	65,5	1,082	3660	64,44	920
CJSX-SILENT-20/10-2	C	S	NO	1,00	58,5%	66,0	0,647	3584	38,75	650
CJSX-SILENT-20/10-3	C	S	NO	1,00	59,5%	66,6	0,761	3804	43,67	690
CJSX-SILENT-20/10-4	C	S	NO	1,01	60,4%	66,8	0,963	4135	51,59	750
CJSX-SILENT-20/10-5.5	C	S	NO	1,01	61,4%	67,5	1,106	4356	57,24	790
CJSX-SILENT-20/10-7.5	C	S	NO	1,01	62,2%	67,7	1,360	4686	66,27	850

### Dimensiones mm

#### Suministro standard impulsión horizontal (H) RD-90

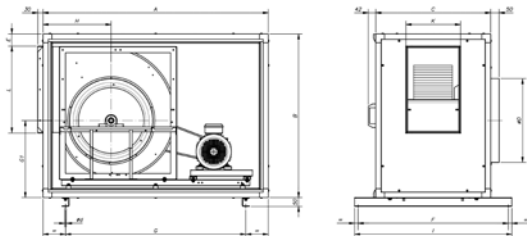

#### Bajo demanda impulsión horizontal (H) LG-90

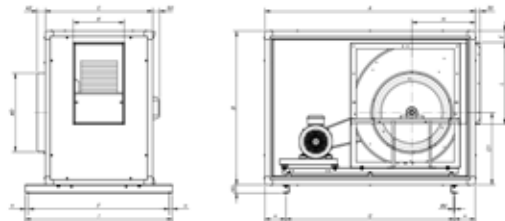

	A	B	C	ØD	Ød	E	F	G	G1	H	I	K	L
CJSX-SILENT-12/6-H	940	710	560	325	13	78	760	710	336	296	800	218	351
CJSX-SILENT-15/7-H	1080	800	620	400	13	67	820	870	381	330	860	276	413
CJSX-SILENT-18/9-H	1275	925	650	475	13	69	850	1020	435	386	890	308	492
CJSX-SILENT-20/10-H	1515	1160	775	575	13	111	975	1260	522	379	1015	338	612

#### Bajo demanda impulsión vertical (V) RD-0

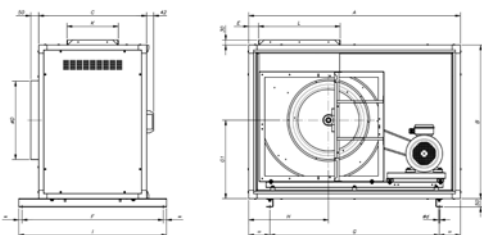

#### Bajo demanda impulsión vertical (V) LG-0

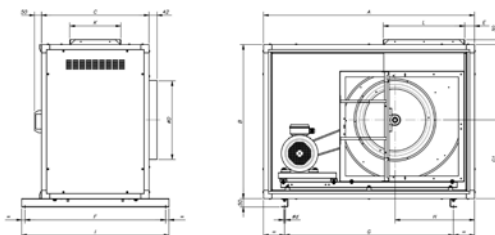

	A	B	C	ØD	Ød	E	F	G	G1	H	I	K	L
CJSX-SILENT-12/6-V	940	710	560	325	13	67	760	710	369	363	800	218	351
CJSX-SILENT-15/7-V	1080	800	620	400	13	62	820	870	419	415	860	276	413
CJSX-SILENT-18/9-V	1275	925	650	475	13	62	850	1020	472	431	890	308	492
CJSX-SILENT-20/10-V	1515	1160	775	575	13	101	975	1260	590	576	1015	338	612

**Curvas características**

Q= Caudal en m<sup>3</sup>/h, m<sup>3</sup>/s y cfm.

Pe= Presión estática en mmH<sub>2</sub>O, Pa e inwg.

**CJSX- SILENT 12/6**

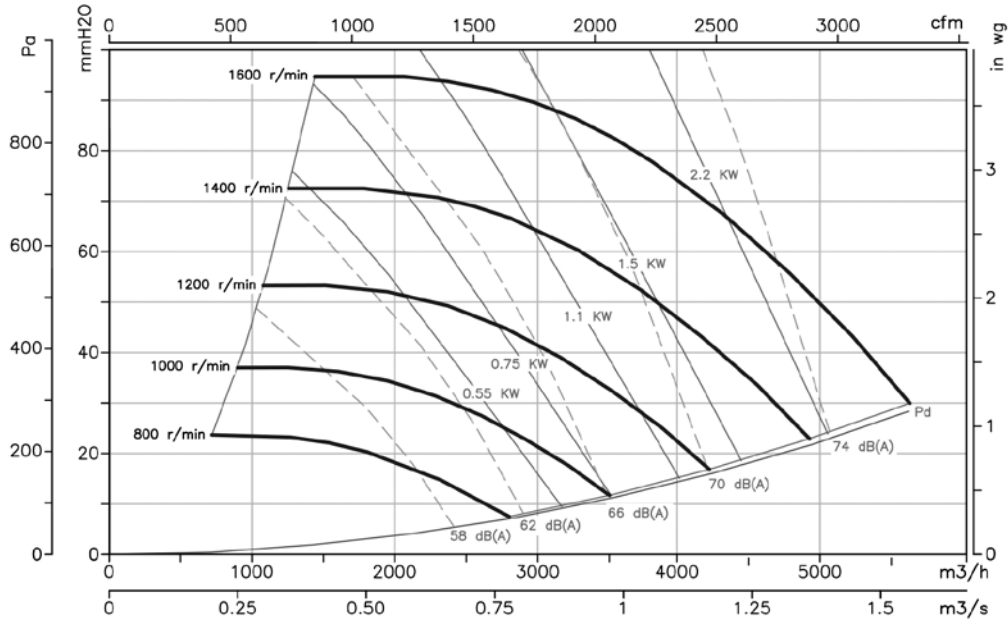

**CJSX- SILENT 15/7**

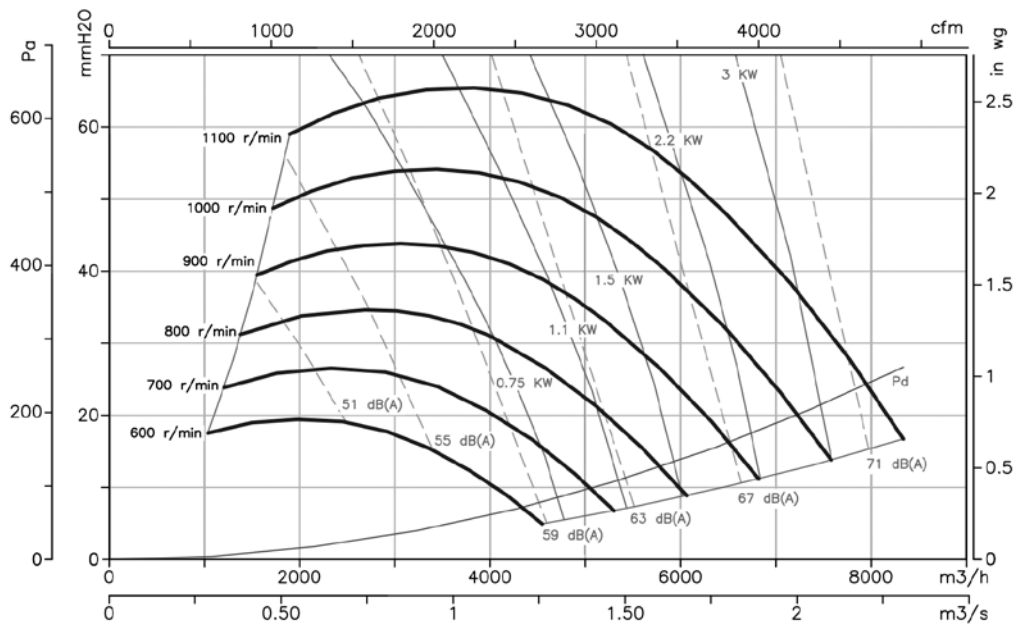

## Curvas características

Q= Caudal en m<sup>3</sup>/h, m<sup>3</sup>/s y cfm.

Pe= Presión estática en mmH<sub>2</sub>O, Pa e in wg.

**CJSX- SILENT 18/9**

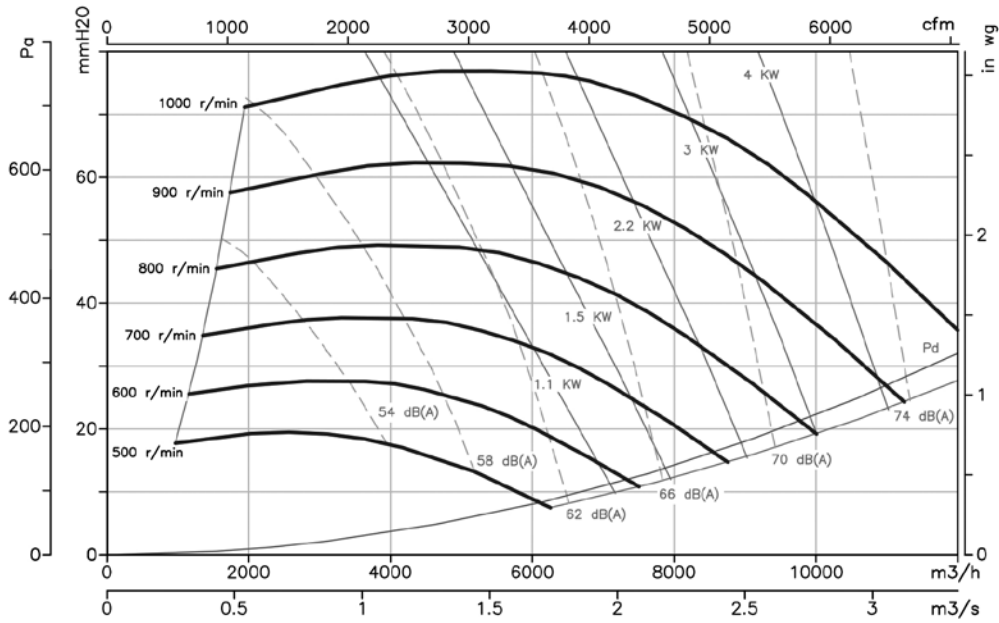

**CJSX- SILENT 20/10**

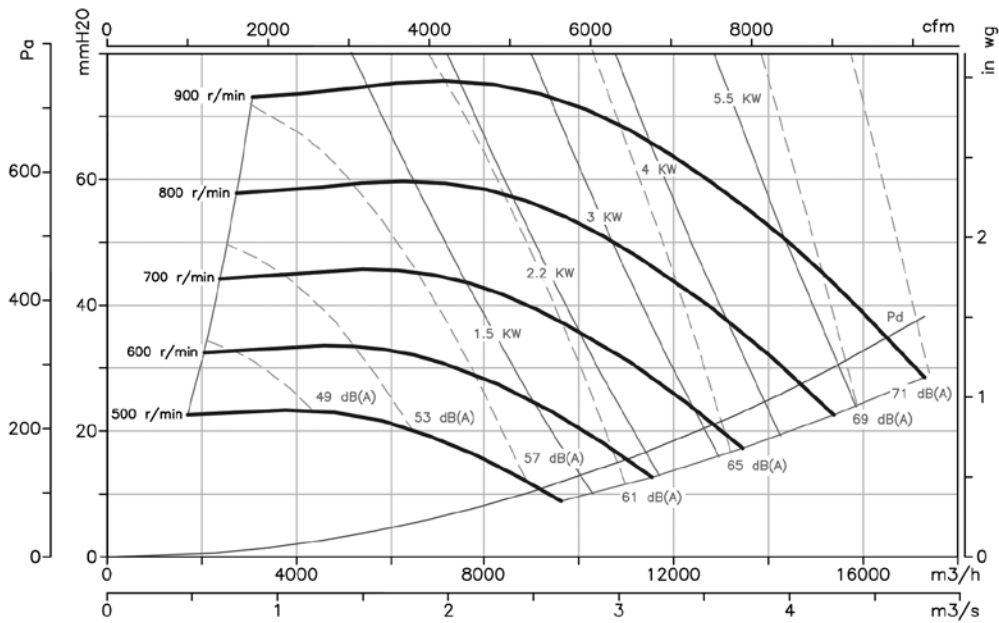

# CSX

## Extractores centrífugos 400 °C/2h para trabajar en el exterior de la zona de riesgo de incendios, accionados a transmisión con turbina a reacción



Extractores centrífugos 400 °C/2h accionados a transmisión con turbina a reacción equipados con motor eléctrico, conjunto de poleas, correas y protectores normalizados según norma ISO-13852

**Ventilador:**

- Envoltente en chapa de acero
- Turbina con álabes a reacción en chapa de acero
- Homologación según norma EN 12101-3:2002/AC:2006 con certificación número 0370-CPR-1577
- Conjunto de poleas, correas y protectores normalizados según norma ISO-13852



Turbina a reacción de alto rendimiento, y gran robustez

**Motor:**

- Motores eficiencia IE-2, excepto potencias inferiores a 0,75 kW monofásico y 2 velocidades
- Motores clase F, con rodamientos a bolas, protección IP55
- Trifásicos 230/400V-50Hz (hasta 5,5CV) y 400/690V-50Hz (potencias superiores a 5,5CV)
- Temperatura máxima del aire a transportar: -20°C + 150°C

**Acabado:**

- Anticorrosivo en resina de poliéster polimerizada a 190 °C, previo desengrase con tratamiento nanotecnológico libre de fosfatos.

**Bajo demanda:**

- Bobinados especiales para diferentes tensiones

### Código de pedido



CSX: Extractores centrífugos 400 °C/2h para trabajar en el exterior de la zona de riesgo de incendios, accionados a transmisión

Tamaño turbina

Potencia motor (c.v.)

F-400: Homologación 400°C/2h

### Características técnicas

Modelo	Velocidad (r/min)	Intensidad máxima admisible (A)			Potencia instalada (kW)	Caudal máximo (m³/h)	Peso aprox. (Kg)
		230V	400V (A)	690V			
CSX 315-0,5	1650	1,84	1,06	-	0,37	2700	56
CSX 315-0,75	1880	2,35	1,35	-	0,55	3075	58
CSX 315-1	2095	3,13	1,80	-	0,75	3430	57
CSX 315-1,5	2375	4,35	2,50	-	1,10	3885	62
CSX 315-2	2655	5,83	3,35	-	1,50	4345	63
CSX 315-3	3000	7,60	4,37	-	2,20	4910	75
CSX 315-4	3380	10,35	5,95	-	3,00	5530	77
CSX 355-0,5	1385	1,84	1,06	-	0,37	3235	64
CSX 355-0,75	1580	2,43	1,40	-	0,55	3685	65
CSX 355-1	1765	3,13	1,80	-	0,75	4120	65
CSX 355-1,5	2010	4,35	2,50	-	1,10	4690	70
CSX 355-2	2225	5,83	3,35	-	1,50	5190	71
CSX 355-3	2530	7,60	4,37	-	2,20	5905	82
CSX 355-4	2860	10,35	5,95	-	3,00	6675	84
CSX 355-5,5	3100	13,22	7,60	-	4,00	7235	94
CSX 400-0,75	1320	2,35	1,35	-	0,55	4375	81
CSX 400-1	1465	3,30	1,90	-	0,75	4855	84
CSX 400-1,5	1665	4,50	2,59	-	1,10	5515	86
CSX 400-2	1845	5,83	3,35	-	1,50	6110	93
CSX 400-3	2100	7,60	4,37	-	2,20	6955	101
CSX 400-4	2370	10,35	5,95	-	3,00	7850	99
CSX 400-5,5	2610	13,22	7,60	-	4,00	8645	109

**Características técnicas**

Modelo	Velocidad (r/min)	Intensidad máxima admisible (A)			Potencia instalada (kW)	Caudal máximo (m³/h)	Peso aprox. (Kg)
		230V	400V (A)	690V			
CSX 450-0,75	1095	2,43	1,40	-	0,55	5045	101
CSX 450-1	1220	3,30	1,90	-	0,75	5620	106
CSX 450-1,5	1390	4,50	2,59	-	1,10	6405	106
CSX 450-2	1540	6,00	3,45	-	1,50	7095	113
CSX 450-3	1750	8,35	4,80	-	2,20	8065	121
CSX 450-4	1980	10,35	5,95	-	3,00	9120	119
CSX 450-5,5	2180	13,22	7,60	-	4,00	10045	129
CSX 450-7,5	2420	-	10,50	6,09	5,50	11150	151
CSX 450-10	2670	-	13,90	8,06	7,50	12300	154
CSX 500-1	1005	3,30	1,90	-	0,75	6465	132
CSX 500-1,5	1140	4,50	2,59	-	1,10	7330	132
CSX 500-2	1270	6,00	3,45	-	1,50	8165	138
CSX 500-3	1445	8,35	4,80	-	2,20	9290	147
CSX 500-4	1635	11,27	6,48	-	3,00	10510	149
CSX 500-5,5	1800	13,91	8,00	-	4,00	11570	158
CSX 500-7,5	2000	-	11,10	6,43	5,50	12855	176
CSX 500-10	2220	-	13,90	8,06	7,50	14270	179
CSX 500-15	2300	-	20,50	11,88	11,00	14785	204
CSX 560-2	1035	6,00	3,45	-	1,50	9885	189
CSX 560-3	1185	8,35	4,80	-	2,20	11360	191
CSX 560-4	1340	11,27	6,48	-	3,00	12880	194
CSX 560-5,5	1475	13,91	8,00	-	4,00	14210	203
CSX 560-7,5	1640	-	11,10	6,43	5,50	15830	221
CSX 560-10	1815	-	14,80	8,58	7,50	17555	224
CSX 560-15	2065	-	20,50	11,88	11,00	20010	249
CSX 630-3	1010	8,35	4,80	-	2,20	12120	216
CSX 630-4	1140	11,27	6,48	-	3,00	13680	218
CSX 630-5,5	1255	13,91	8,00	-	4,00	15060	227
CSX 630-7,5	1395	-	11,10	6,43	5,50	16740	245
CSX 630-10	1550	-	14,80	8,58	7,50	18600	248
CSX 630-15	1760	-	22,00	12,75	11,00	21120	273
CSX 630-20	1900	-	29,00	16,81	15	22800	303
CSX 710-4	960	11,27	6,48	-	3,00	17065	260
CSX 710-5,5	1060	13,91	8,00	-	4,00	18845	269
CSX 710-7,5	1180	-	11,10	6,43	5,50	20980	287
CSX 710-10	1305	-	14,80	8,58	7,50	23200	289
CSX 710-15	1485	-	22,00	12,75	11,00	26400	315
CSX 710-20	1670	-	29,00	16,81	15,00	29690	345
CSX 710-25	1750	-	36,50	21,16	18,50	31110	363
CSX 800-4	765	11,27	6,48	-	3,00	19975	306
CSX 800-5,5	845	13,91	8,00	-	4,00	22065	315
CSX 800-7,5	940	-	11,10	6,43	5,50	24545	333
CSX 800-10	1040	-	14,80	8,58	7,50	27155	336
CSX 800-15	1185	-	22,00	12,75	11,00	30940	361
CSX 800-20	1330	-	29,00	16,81	15,00	34730	391
CSX 800-25	1420	-	36,50	21,16	18,50	37080	409
CSX 900-4	640	11,27	6,48	-	3,00	21200	385
CSX 900-5,5	705	13,91	8,00	-	4,00	23355	394
CSX 900-7,5	785	-	11,10	6,43	5,50	26005	412
CSX 900-10	870	-	14,80	8,58	7,50	28820	415
CSX 900-15	990	-	22,00	12,75	11,00	32795	440
CSX 900-20	1100	-	29,00	16,81	15,00	36440	470
CSX 900-25	1150	-	36,50	21,16	18,50	38095	488
CSX 900-30	1200	-	42,00	24,35	22,00	39750	522
CSX 1000-5,5	575	13,91	8,00	-	4,00	25555	487
CSX 1000-7,5	645	-	11,10	6,43	5,50	28665	479
CSX 1000-10	715	-	14,80	8,58	7,50	31780	482
CSX 1000-15	815	-	22,00	12,75	11,00	36220	507
CSX 1000-20	915	-	29,00	16,81	15,00	40665	537
CSX 1000-25	980	-	36,50	21,16	18,50	43555	555
CSX 1000-30	1040	-	42,00	24,35	22,00	46220	589
CSX 1000-40	1120	-	59,00	34,2	30,00	49780	619



### Erp. Características del punto de máxima eficiencia (BEP)

<b>MC</b>	Categoría de medición	<b><math>\eta_e</math>[%]</b>	Eficiencia
<b>EC</b>	Categoría de eficiencia	<b>N</b>	Grado de eficiencia
<b>S</b>	Estática	<b>[kW]</b>	Potencia eléctrica
<b>T</b>	Total	<b>[m³/h]</b>	Caudal
<b>VSD</b>	Variador de velocidad	<b>[mmH₂O]</b>	Presión estática o total (Según EC)
<b>SR</b>	Relación específica	<b>[RPM]</b>	Velocidad

Modelo	MC	EC	VSD	SR	$\eta_e$ [%]	N	(kW)	(m³/h)	(mmH₂O)	(RPM)
315-0,5	C	S	NO	1,00	42,7%	57,1	0,423	1503	44,14	1650
315-0,75	C	S	NO	1,01	44,6%	57,4	0,599	1712	57,30	1880
315-1	C	S	NO	1,01	49,0%	60,8	0,755	1908	71,16	2095
315-1,5	C	S	NO	1,01	50,0%	60,2	1,078	2163	91,45	2375
315-2	C	S	NO	1,01	51,0%	59,7	1,478	2418	114,29	2655
315-3	C	S	NO	1,01	53,1%	60,4	2,045	2732	145,92	3000
315-4	C	S	NO	1,02	53,9%	59,6	2,883	3078	185,22	3380
355-0,5	C	S	NO	1,00	51,3%	66,4	0,367	1700	40,59	1385
355-0,75	C	S	NO	1,01	53,6%	67,0	0,521	1940	52,82	1580
355-1	C	S	NO	1,01	58,8%	71,2	0,661	2167	65,91	1765
355-1,5	C	S	NO	1,01	60,1%	70,8	0,957	2467	85,48	2010
355-2	C	S	NO	1,01	61,1%	70,5	1,276	2731	104,75	2225
355-3	C	S	NO	1,01	63,7%	71,5	1,800	3106	135,43	2530
355-4	C	S	NO	1,02	64,5%	70,8	2,565	3511	173,07	2860
355-5,5	C	S	NO	1,02	66,0%	71,2	3,194	3805	203,33	3100
400-0,75	C	S	NO	1,00	49,0%	62,0	0,578	2362	44,01	1320
400-1	C	S	NO	1,01	52,7%	64,6	0,735	2622	54,21	1465
400-1,5	C	S	NO	1,01	54,3%	64,6	1,047	2979	70,02	1665
400-2	C	S	NO	1,01	54,9%	63,8	1,409	3302	85,98	1845
400-3	C	S	NO	1,01	56,2%	63,5	2,030	3758	111,39	2100
400-4	C	S	NO	1,01	56,8%	62,5	2,886	4241	141,88	2370
400-5,5	C	S	NO	1,02	58,2%	62,7	3,761	4670	172,06	2610
450-0,75	C	S	NO	1,00	48,1%	60,9	0,599	2807	37,69	1095
450-1	C	S	NO	1,00	51,7%	63,4	0,771	3127	46,79	1220
450-1,5	C	S	NO	1,01	53,3%	63,3	1,106	3563	60,73	1390
450-2	C	S	NO	1,01	53,9%	62,6	1,487	3947	74,55	1540
450-3	C	S	NO	1,01	55,2%	62,3	2,132	4485	96,27	1750
450-4	C	S	NO	1,01	55,8%	61,3	3,052	5075	123,23	1980
450-5,5	C	S	NO	1,01	57,3%	61,5	3,972	5588	149,39	2180
450-7,5	C	S	NO	1,02	58,7%	61,5	5,305	6203	184,09	2420
450-10	C	S	NO	1,02	59,6%	61,3	7,008	6843	224,09	2670
500-1	C	S	NO	1,00	53,2%	65,0	0,753	3608	40,71	1005
500-1,5	C	S	NO	1,01	54,8%	65,0	1,067	4093	52,38	1140
500-2	C	S	NO	1,01	55,4%	64,2	1,458	4560	65,01	1270
500-3	C	S	NO	1,01	56,7%	63,8	2,098	5188	84,16	1445
500-4	C	S	NO	1,01	58,0%	63,5	2,973	5870	107,74	1635
500-5,5	C	S	NO	1,01	59,5%	63,8	3,866	6463	130,58	1800
500-7,5	C	S	NO	1,02	60,2%	63,2	5,237	7181	161,22	2000
500-10	C	S	NO	1,02	61,3%	62,9	7,041	7971	198,63	2220
500-15	C	S	NO	1,02	62,5%	63,7	7,672	8258	213,21	2300
560-2	C	S	NO	1,01	54,9%	63,6	1,485	5921	50,50	1035
560-3	C	S	NO	1,01	56,2%	63,2	2,175	6780	66,20	1185
560-4	C	S	NO	1,01	57,5%	62,9	3,076	7666	84,65	1340
560-5,5	C	S	NO	1,01	59,0%	63,2	3,997	8439	102,57	1475
560-7,5	C	S	NO	1,01	60,5%	63,3	5,362	9383	126,80	1640
560-10	C	S	NO	1,02	60,7%	62,2	7,239	10384	155,30	1815
560-15	C	S	NO	1,02	61,9%	62,0	10,447	11814	201,03	2065
630-3	C	S	NO	1,01	58,6%	65,4	2,257	7231	67,17	1010
630-4	C	S	NO	1,01	60,0%	65,2	3,173	8162	85,58	1140
630-5,5	C	S	NO	1,01	61,6%	65,6	4,123	8985	103,71	1255
630-7,5	C	S	NO	1,01	63,1%	65,8	5,524	9987	128,14	1395
630-10	C	S	NO	1,02	63,3%	64,6	7,559	11097	158,20	1550
630-15	C	S	NO	1,02	64,6%	64,6	10,844	12600	203,97	1760
630-20	C	S	NO	1,02	65,2%	64,9	13,523	13603	237,71	1900
710-4	C	S	NO	1,01	64,9%	69,8	3,357	12025	66,44	960
710-5,5	C	S	NO	1,01	66,7%	70,4	4,397	13277	81,00	1060
710-7,5	C	S	NO	1,01	68,3%	70,7	5,917	14781	100,38	1180
710-10	C	S	NO	1,01	68,9%	69,9	7,941	16346	122,77	1305
710-15	C	S	NO	1,02	69,7%	69,6	11,557	18601	158,97	1485
710-20	C	S	NO	1,02	70,3%	69,9	16,292	20918	201,05	1670
710-25	C	S	NO	1,02	69,9%	69,2	18,872	21920	220,78	1750
800-4	C	S	NO	1,01	59,0%	64,4	3,084	11226	59,47	765





**Erp. Características del punto de máxima eficiencia (BEP)**

<b>MC</b>	Categoría de medición	<b>ηe[%]</b>	Eficiencia
<b>EC</b>	Categoría de eficiencia	<b>N</b>	Grado de eficiencia
<b>S</b>	Estática	<b>[kW]</b>	Potencia eléctrica
<b>T</b>	Total	<b>[m³/h]</b>	Caudal
<b>VSD</b>	Variador de velocidad	<b>[mmH₂O]</b>	Presión estática o total (Según EC)
<b>SR</b>	Relación específica	<b>[RPM]</b>	Velocidad

Modelo	MC	EC	VSD	SR	ηe[%]	N	(kW)	(m³/h)	(mmH₂O)	(RPM)
800-5,5	C	S	NO	1,01	60,6%	64,7	4,048	12400	72,56	845
800-7,5	C	S	NO	1,01	62,1%	64,9	5,437	13794	89,79	940
800-10	C	S	NO	1,01	62,3%	63,7	7,338	15262	109,91	1040
800-15	C	S	NO	1,01	63,6%	63,6	10,638	17390	142,69	1185
800-20	C	S	NO	1,02	64,1%	63,8	14,907	19517	179,75	1330
800-25	C	S	NO	1,02	63,7%	63,1	18,264	20838	204,90	1420
900-4	C	S	NO	1,01	58,4%	63,7	3,123	12272	54,55	640
900-5,5	C	S	NO	1,01	60,0%	64,1	4,067	13518	66,19	705
900-7,5	C	S	NO	1,01	61,5%	64,2	5,476	15052	82,07	785
900-10	C	S	NO	1,01	61,7%	63,0	7,433	16682	100,80	870
900-15	C	S	NO	1,01	62,9%	62,9	10,733	18983	130,53	990
900-20	C	S	NO	1,02	63,5%	63,1	14,592	21092	161,15	1100
900-25	C	S	NO	1,02	63,1%	62,6	16,785	22051	176,13	1150
900-30	C	S	NO	1,02	63,4%	62,8	18,966	23010	191,78	1200
1000-5,5	C	S	NO	1,01	61,0%	65,3	3,883	16465	52,78	575
1000-7,5	C	S	NO	1,01	62,5%	65,4	5,344	18470	66,41	645
1000-10	C	S	NO	1,01	62,8%	64,3	7,250	20474	81,61	715
1000-15	C	S	NO	1,01	64,1%	64,1	10,521	23338	106,04	815
1000-20	C	S	NO	1,01	64,7%	64,3	14,757	26201	133,65	915
1000-25	C	S	NO	1,02	64,2%	63,6	18,252	28063	153,32	980
1000-30	C	S	NO	1,02	64,6%	63,8	21,693	29781	172,66	1040
1000-40	C	S	NO	1,02	65,3%	64,3	26,798	32072	200,25	1120

**Dimensiones mm**

Suministro standard RD-90

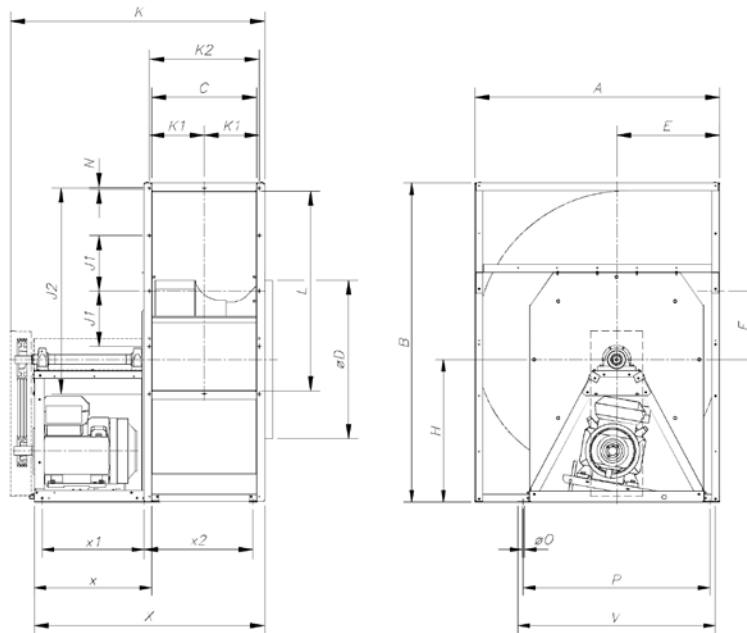

	A	B	C	L	K2	K1	J2	J1	N	øD	H	E	F	K	X	øD	P	V	x1	x2	x
CSX-315	522	771,5	223	404	253	126,5	434	-	13x9	313	400	236	139,5	769	679	12	454	504	315	264	415
CSX-355	582,5	869,5	247	453	277	138,5	483	-	13x9	353	450	261	158	793	703	12	496	546	315	288	415
CSX-400	651	963	274	507	304	152	537	-	13x9	398	500	290	179,5	820	730	12	542	592	315	315	415
CSX-450	727,5	1067	308	569	338	169	599	-	13x9	448	550	322	202,5	959	829	12	595	645	380	349	480
CSX-500	801	1180	344	638	374	187	658	-	13x9	498	600	352	221	1005	875	12	654	704	380	380	480
CSX-560	892,5	1295	383	715	413	206,5	745	-	13x9	558	650	390	247,5	1202	1064	12	715	765	515	424	630
CSX-630	998,5	1489,5	432	801	462	231	831	-	13x9	628	769	434	280	1251	1113	12	780	830	515	473	630
CSX-710	1117	1547	479	902	508	254	928	200	13x9	708	730	481,5	316	1298	1160	14	890	930	515	520	630
CSX-800	1250	1665,5	533	1010	563	283,5	1037	250	13x9	798	762	535	358,5	1362	1219	14	980	1050	515	574,5	630
CSX-900	1408	1525	595	1130	625	312,5	1160	300	13x9	898	850	604	407	1424	1281	14	1080	1150	515	636,5	630
CSX-1000	1546	2016	663	1260	693	346,5	1297	350	13x9	998	900	651	433	1600	1456	14	1180	1250	642	690	742

**Curvas características**

Q= Caudal en m<sup>3</sup>/h, m<sup>3</sup>/s y cfm.

Pe= Presión estática en mmH<sub>2</sub>O, Pa e inwg.

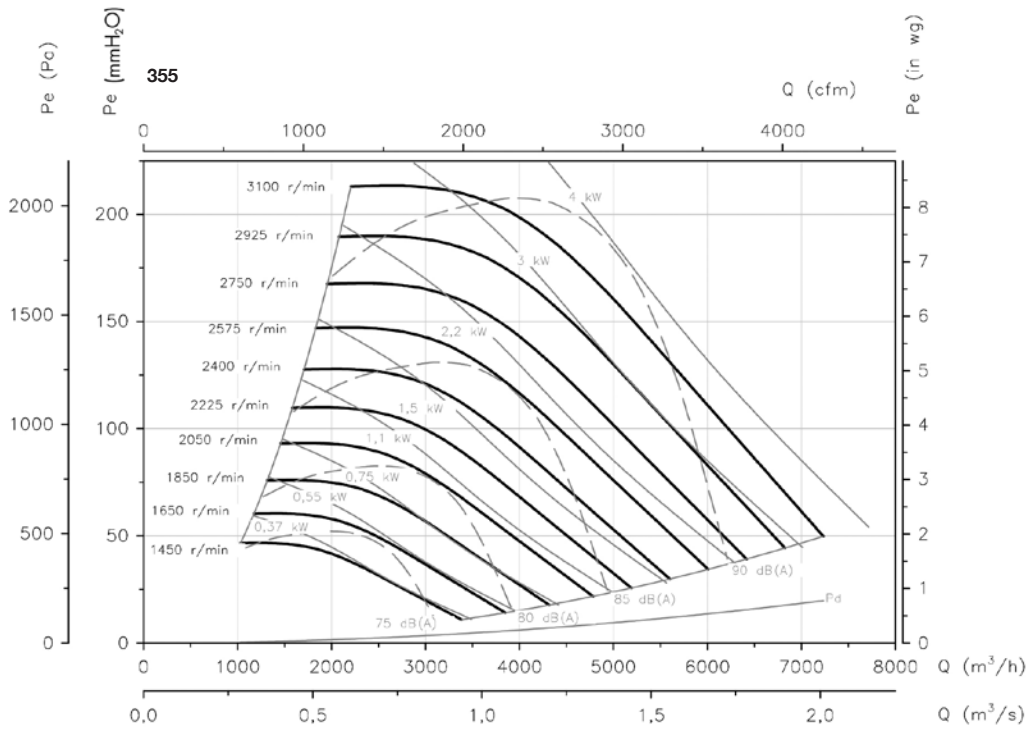
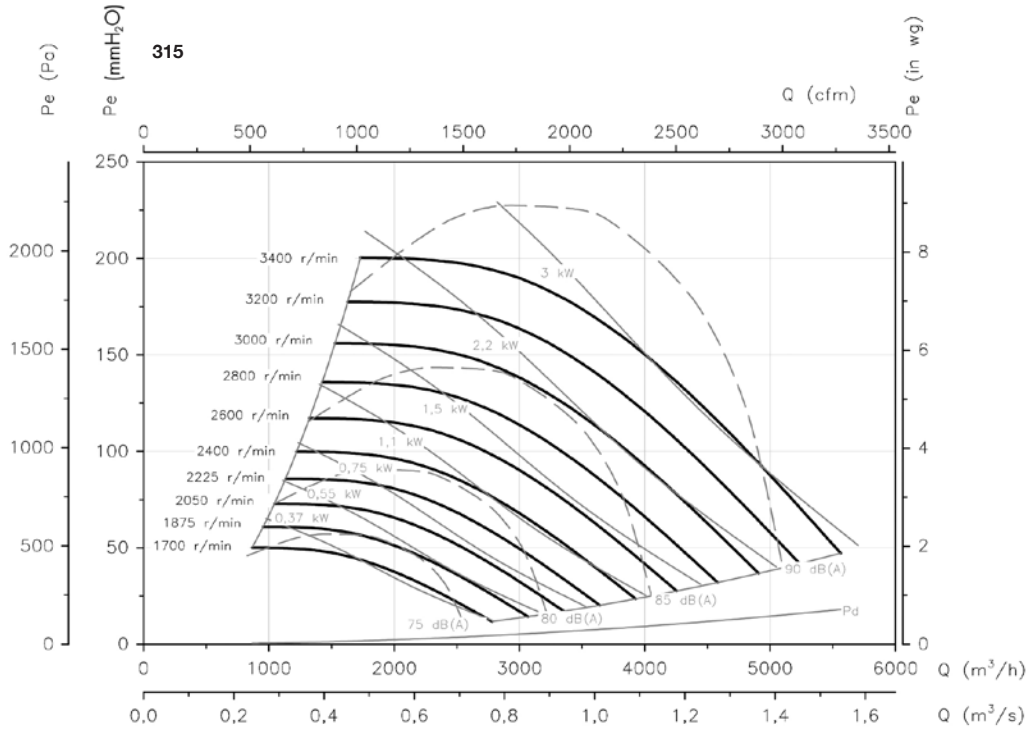

**Curvas características**

Q= Caudal en m<sup>3</sup>/h, m<sup>3</sup>/s y cfm.

Pe= Presión estática en mmH<sub>2</sub>O, Pa e inwg.

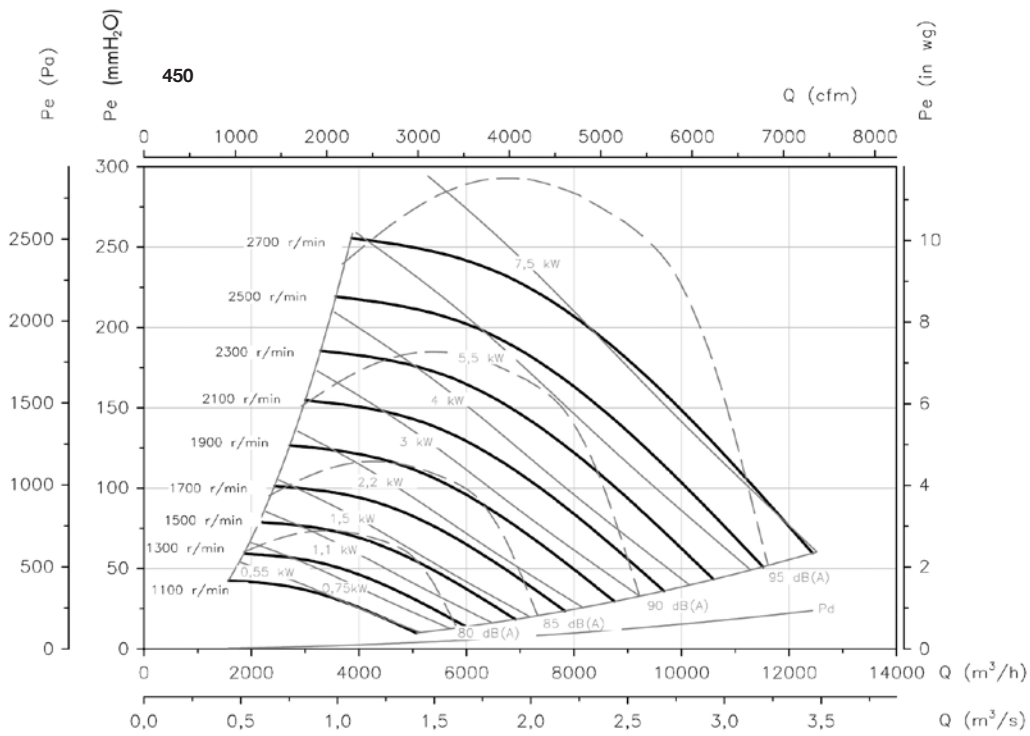
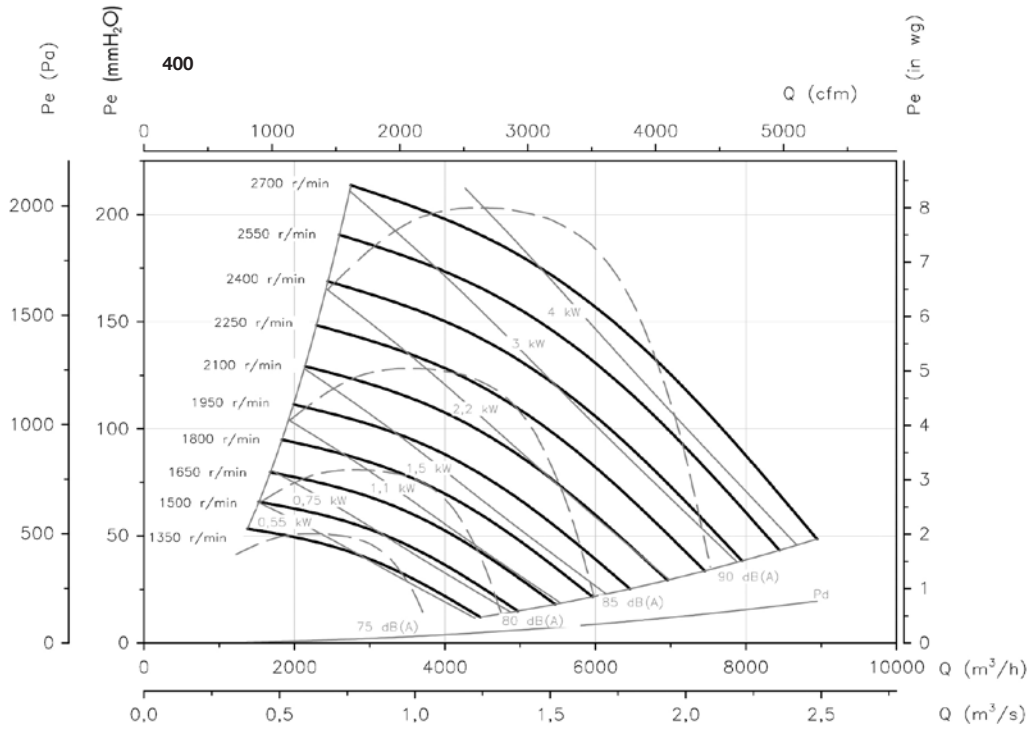

**Curvas características**

Q= Caudal en m<sup>3</sup>/h, m<sup>3</sup>/s y cfm.

Pe= Presión estática en mmH<sub>2</sub>O, Pa e inwg.

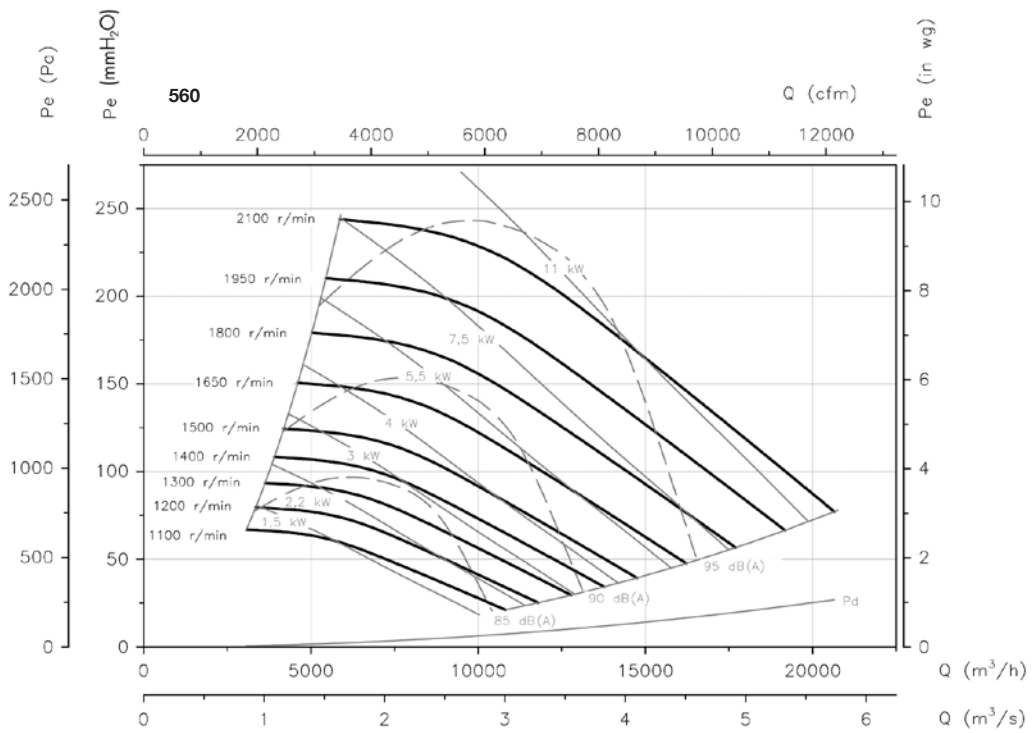
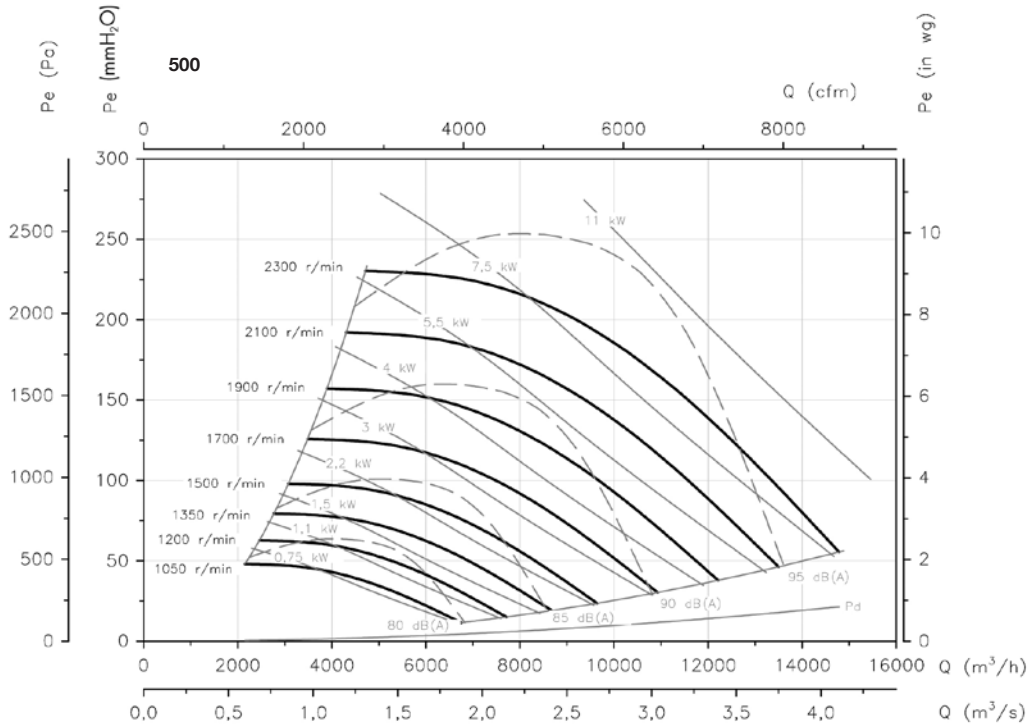

**Curvas características**

Q= Caudal en m<sup>3</sup>/h, m<sup>3</sup>/s y cfm.

Pe= Presión estática en mmH<sub>2</sub>O, Pa e inwg.

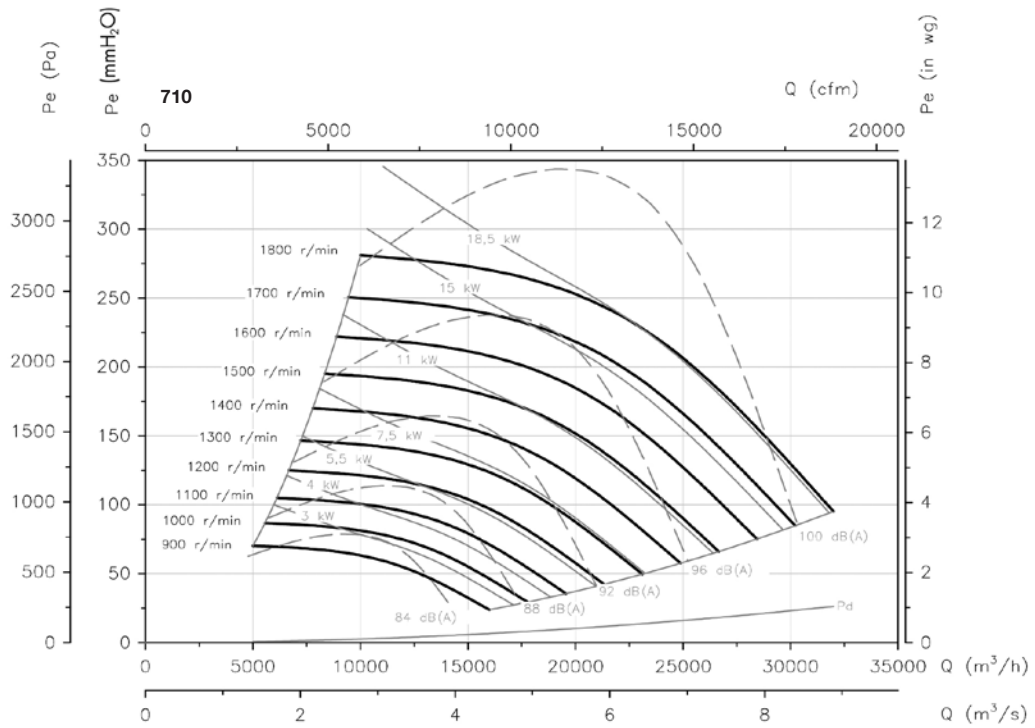
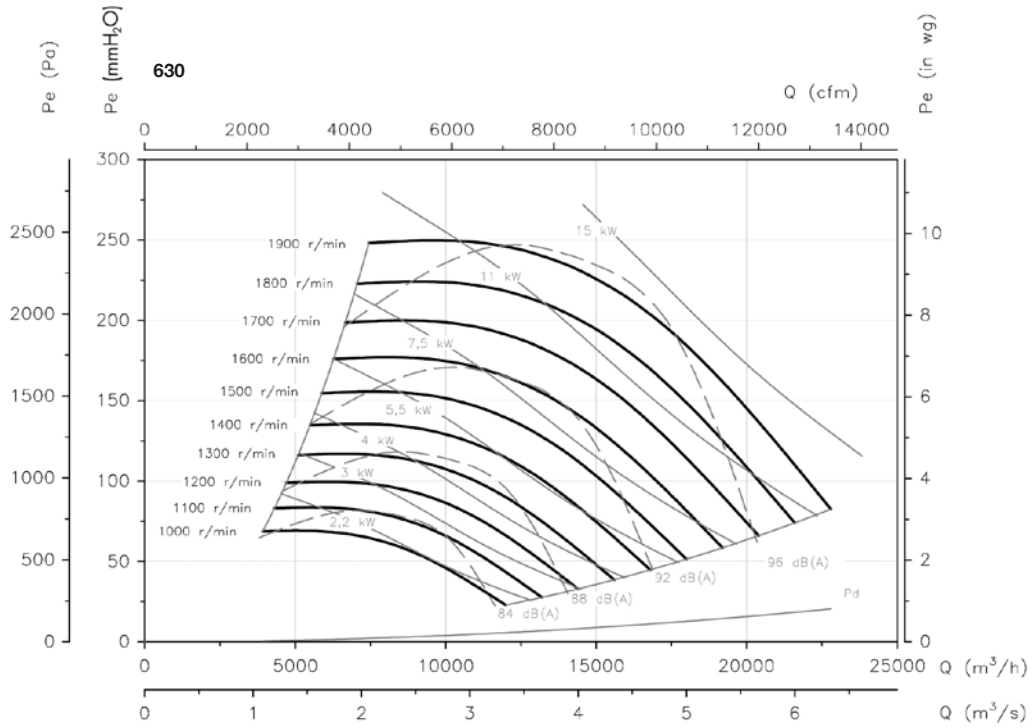

**Curvas características**

Q= Caudal en m<sup>3</sup>/h, m<sup>3</sup>/s y cfm.

Pe= Presión estática en mmH<sub>2</sub>O, Pa e inwg.

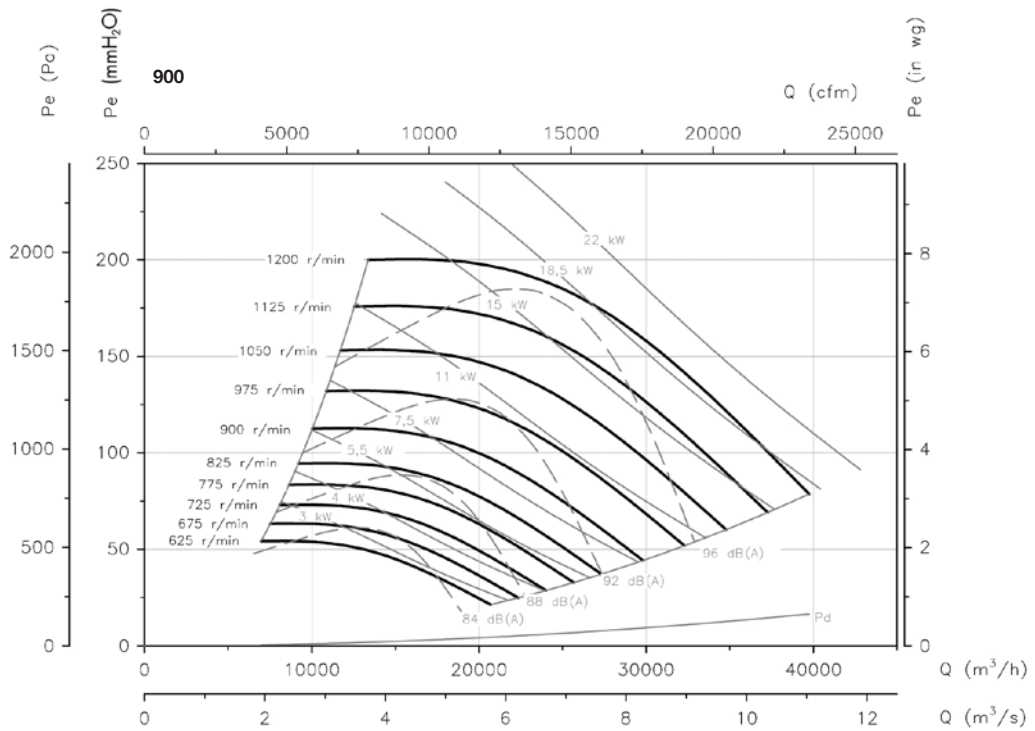
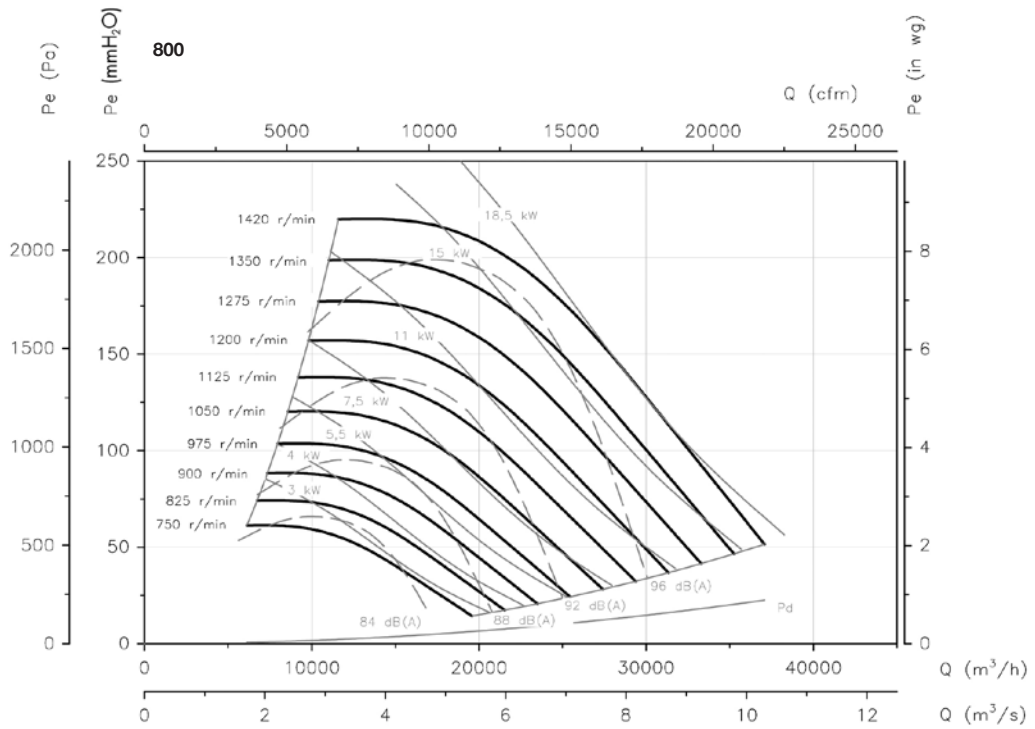

**Curvas características**

Q= Caudal en m<sup>3</sup>/h, m<sup>3</sup>/s y cfm.

Pe= Presión estática en mmH<sub>2</sub>O, Pa e inwg.

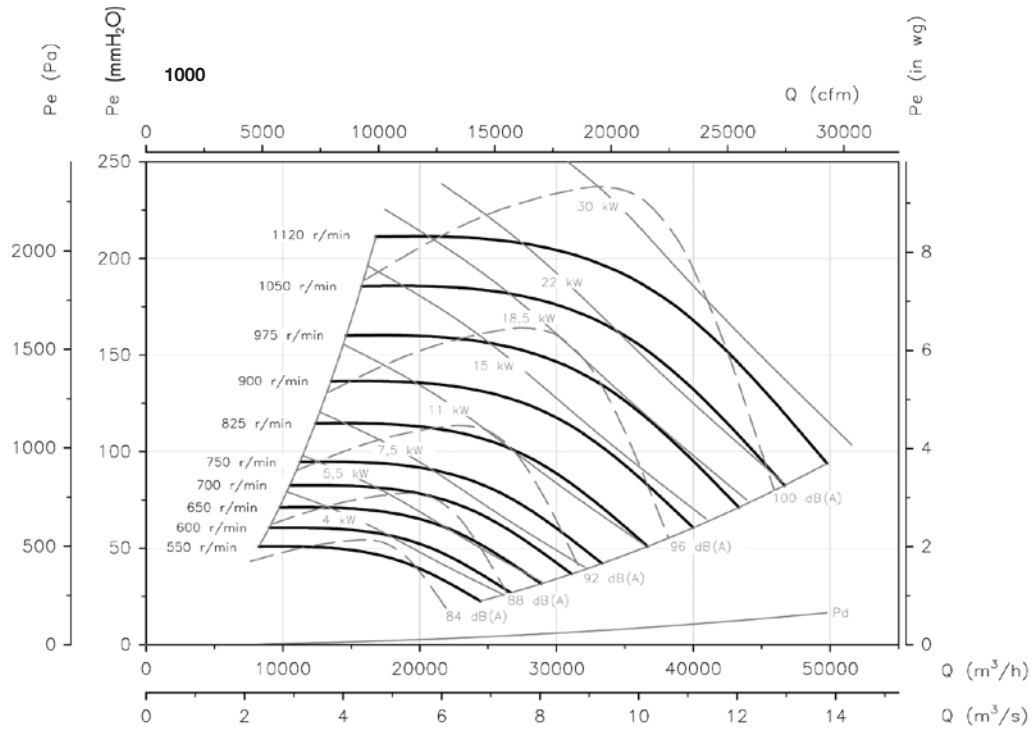

**Accesorios**

Ver apartado accesorios



# CJSRX



Turbina a reacción de alto rendimiento, y gran robustez

## Unidades de extracción 400 °C/2h para trabajar en el exterior de la zona de riesgo de incendios, accionados a transmisión con turbina a reacción

Unidades de extracción 400°C/2h, accionados a transmisión con turbina a reacción equipados con motor eléctrico, conjunto de poleas, correas y protectores normalizados según norma ISO-13857:2008

### Ventilador:

- Envolverte en chapa de acero
- Turbina con álabes a reacción en chapa de acero
- Homologación según norma EN 12101-3:2002/AC:2006 con certificación número 0370-CPR-1578
- Conjunto de poleas, correas y protectores normalizados según norma ISO-13852

### Motor:

- Motores eficiencia IE-2, excepto potencias inferiores a 0,75 kW monofásico y 2 velocidades
- Motores clase F, con rodamientos a bolas, protección IP55
- Trifásicos 230/400V-50Hz (hasta 5,5CV) y 400/690V-50Hz (potencias superiores a 5,5CV)
- Temperatura máxima del aire a transportar: -20°C + 150°C

### Acabado:

- Anticorrosivo en chapa de acero galvanizado

### Bajo demanda:

- Bobinados especiales para diferentes tensiones



## Código de pedido

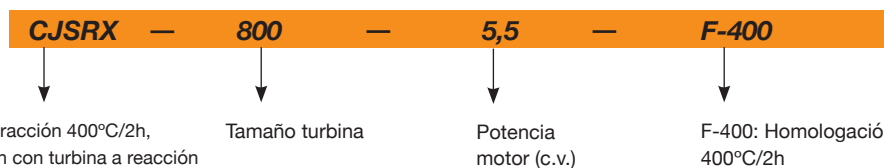

## Características técnicas

Modelo	Velocidad (r/min)	Intensidad máxima admisible (A)			Potencia instalada (kW)	Caudal máximo (m³/h)	Peso aprox. (Kg)
		230V	400V (A)	690V			
CJSRX-315-0,5	1650	1,84	1,06	-	0,37	2700	109
CJSRX-315-0,75	1880	2,57	1,49	-	0,55	3075	111
CJSRX-315-1	2095	2,78	1,6	-	0,75	3430	110
CJSRX-315-1,5	2375	4,2	2,4	-	1,1	3885	115
CJSRX-315-2	2655	5,44	3,13	-	1,5	4345	116
CJSRX-315-3	3000	7,77	4,47	-	2,2	4910	128
CJSRX-315-4	3380	10,18	5,88	-	3	5530	130
CJSRX-355-0,5	1385	1,84	1,06	-	0,37	3235	125
CJSRX-355-0,75	1580	2,57	1,49	-	0,55	3685	126
CJSRX-355-1	1765	2,78	1,6	-	0,75	4120	126
CJSRX-355-1,5	2010	4,2	2,4	-	1,1	4690	131
CJSRX-355-2	2225	5,44	3,13	-	1,5	5190	132
CJSRX-355-3	2530	7,77	4,47	-	2,2	5905	143
CJSRX-355-4	2860	10,18	5,88	-	3	6675	145
CJSRX-355-5,5	3100	13,6	7,82	-	4	7235	155
CJSRX-400-0,75	1320	2,28	1,31	-	0,55	4375	151
CJSRX-400-1	1465	3,1	1,79	-	0,75	4855	154
CJSRX-400-1,5	1665	4,03	2,32	-	1,1	5515	156
CJSRX-400-2	1845	5,96	3,44	-	1,5	6110	163
CJSRX-400-3	2100	8,36	4,83	-	2,2	6955	171
CJSRX-400-4	2370	10,18	5,88	-	3	7850	169
CJSRX-400-5,5	2610	13,6	7,82	-	4	8645	179



**Características técnicas**

Modelo	Velocidad (r/min)	Intensidad máxima admisible (A)			Potencia instalada (kW)	Caudal máximo (m³/h)	Peso aprox. (Kg)
		230V	400V (A)	690V			
CJSRX-450-0,75	1095	2,28	1,31	-	0,55	5045	180
CJSRX-450-1	1220	3,1	1,79	-	0,75	5620	185
CJSRX-450-1,5	1390	4,03	2,32	-	1,1	6405	185
CJSRX-450-2	1540	5,96	3,44	-	1,5	7095	192
CJSRX-450-3	1750	8,36	4,83	-	2,2	8065	200
CJSRX-450-4	1980	10,18	5,88	-	3	9120	198
CJSRX-450-5,5	2180	13,6	7,82	-	4	10045	208
CJSRX-450-7,5	2420	-	10,5	6,09	5,5	11150	230
CJSRX-450-10	2670	-	14,5	8,41	7,5	12300	233
CJSRX-500-1	1005	3,1	1,79	-	0,75	6465	224
CJSRX-500-1,5	1140	4,03	2,32	-	1,1	7330	224
CJSRX-500-2	1270	5,96	3,44	-	1,5	8165	230
CJSRX-500-3	1445	8,36	4,83	-	2,2	9290	239
CJSRX-500-4	1635	10,96	6,33	-	3	10510	241
CJSRX-500-5,5	1800	14,1	8,12	-	4	11570	250
CJSRX-500-7,5	2000	-	10,5	6,09	5,5	12855	268
CJSRX-500-10	2220	-	14,5	8,41	7,5	14270	271
CJSRX-500-15	2300	-	20,2	11,6	11	14785	296
CJSRX-560-2	1035	5,96	3,44	-	1,5	9885	296
CJSRX-560-3	1185	8,36	4,83	-	2,2	11360	298
CJSRX-560-4	1340	10,96	6,33	-	3	12880	301
CJSRX-560-5,5	1475	14,1	8,12	-	4	14210	310
CJSRX-560-7,5	1640	-	11,6	6,72	5,5	15830	328
CJSRX-560-10	1815	-	14,5	8,41	7,5	17555	331
CJSRX-560-15	2065	-	20,2	11,6	11	20010	356
CJSRX-630-3	1010	8,36	4,83	-	2,2	12120	338
CJSRX-630-4	1140	10,96	6,33	-	3	13680	340
CJSRX-630-5,5	1255	14,1	8,12	-	4	15060	349
CJSRX-630-7,5	1395	-	11,6	6,72	5,5	16740	367
CJSRX-630-10	1550	-	14,5	8,41	7,5	18600	370
CJSRX-630-15	1760	-	20,2	11,6	11	21120	395
CJSRX-630-20	1900	-	27,5	15,9	15	22800	425
CJSRX-710-4	960	10,96	6,33	-	3	17065	411
CJSRX-710-5,5	1060	14,1	8,12	-	4	18845	420
CJSRX-710-7,5	1180	-	11,6	6,72	5,5	20980	438
CJSRX-710-10	1305	-	14,2	8,2	7,5	23200	440
CJSRX-710-15	1485	-	20,2	11,6	11	26400	466
CJSRX-710-20	1670	-	27,5	15,9	15	29690	496
CJSRX-710-25	1750	-	35	20	18,5	31110	514



**Erp. Características del punto de máxima eficiencia (BEP)**

Ver características del punto de máxima eficiencia (BEP) de la serie CSX

**Dimensiones mm**

**Suministro standard  
impulsión horizontal (H) RD 90**

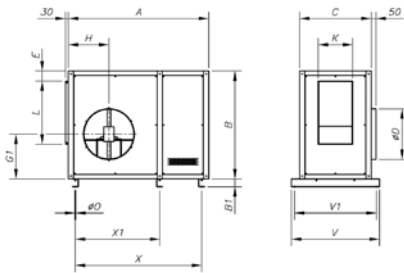

**Bajo demanda  
impulsión horizontal (H) LG 90**

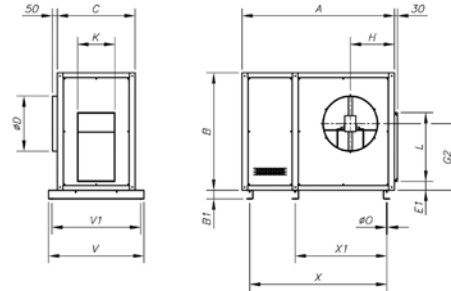

**Bajo demanda  
impulsión vertical (V) RD 0**

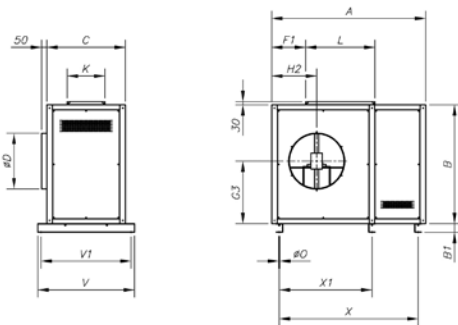

**Bajo demanda  
impulsión vertical (V) LG 0**

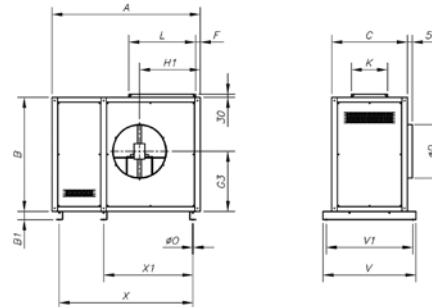

	A	B	B1	C	ØD	E	E1	F	F1	G1	G2	G3	H	H1	H2	L	K	V	X	X1	X2
CJSRX-315	1170	740	60	600	315	82	84,2	113	281	317,5	423,2	366,2	305	451,5	346,3	405	224	760	880	-	155
CJSRX-355	1265	815	60	650	365	85	86,5	112,5	302,5	347,2	470,2	398	338	496	373	454	248	810	1020	-	152
CJSRX-400	1370	900	60	680	400	82	90,2	111	331	386,2	522,2	447,2	359	543	407	508	275	840	1120	-	152
CJSRX-450	1480	990	60	716	448	82	91,2	112,8	360	422,2	577,2	491	383	598	443	570	309	876	1240	-	152
CJSRX-500	1625	1080	60	760	510	80,5	91	111,7	381,3	461,2	629,2	534,2	409	650	482	639	345	920	1340	670	152
CJSRX-560	1760	1195	60	810	580	86,8	94,2	128	426	506,2	696,2	590	462	731	540	716	384	970	1490	745	152
CJSRX-630	1880	1322	60	850	635	85,2	89,6	113,4	455,6	557,7	768,7	648,2	488	792,5	578,5	802	433	1010	820	1610	158
CJSRX-710	2180	1500	80	910	710	103	108,2	100	491	632,2	873,2	737,2	562	865	624	899	479	1070	955	1910	168

**Curvas Características**

Ver curvas características serie CSX

**Accesorios**

Ver apartado accesorios



# CJLINE

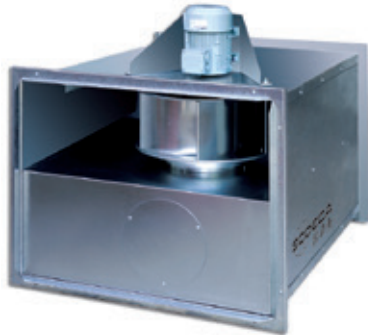

Facilidad de conexión a conductos rectangulares

## Unidades de extracción 400°C/2h, con entrada y salida lineal

Unidades de extracción en línea 400°C/2h, para trabajar en el exterior de la zona de riesgo de incendio

### Ventilador:

- Estructura en chapa de acero galvanizado
- Turbina con álabes a reacción, en chapa de acero
- Homologación según norma EN 12101-3:2002/AC:2006, con certificación N°: 0370-CPR-0594
- Dirección aire sentido lineal

### Motor:

- Motores clase F, con rodamientos a bolas, protección IP55, de 1 ó 2 velocidades según modelo
- Trifásicos 230/400V.-50Hz. (hasta 5,5CV) y 400/690V-50Hz (potencias superiores a 5,5CV)
- Temperatura máxima del aire a transportar: Servicio S1 -20°C.+ 120°C. en continuo. Servicio S2 200°C/2h, 300°C/2h y 400°C/2h

### Acabado:

- Anticorrosivo en chapa de acero galvanizado

### Bajo demanda:

- Extractores con motor de 2 velocidades



## Código de pedido

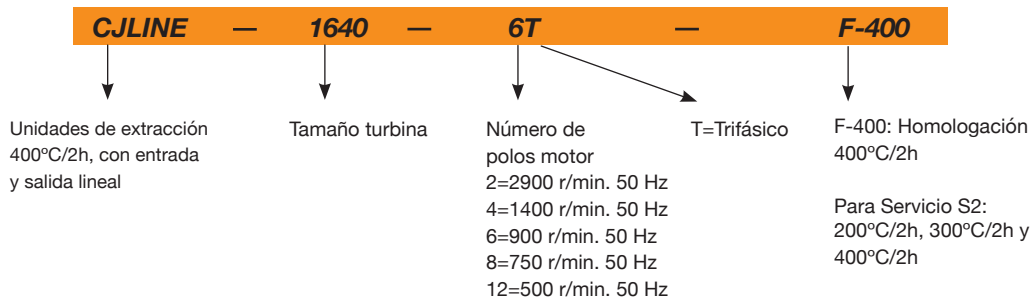

## Características técnicas

Modelo	Velocidad (r/min)	Intensidad máxima admisible (A)			Potencia instalada (kW)	Caudal máximo (m³/h)	Nivel sonoro dB(A)	Peso aprox. (Kg)
		230V	400V (A)	690V				
CJLINE-1131-4T	1350	1,66	0,96		0,25	1920	51	39
CJLINE-1131-4/8T	1400/700		0,70 / 0,30		0,25/0,10	1920/960	51/36	40
CJLINE-1235-4T	1350	1,66	0,96		0,25	3550	56	54
CJLINE-1235-4/8T	1400/700		0,70 / 0,30		0,25/0,10	3550/1775	56/41	55
CJLINE-1235-6T	880	1,22	0,70		0,18	2300	50	55
CJLINE-1640-4T	1370	2,02	1,17		0,37	4800	61	65
CJLINE-1640-4/8T	1440/700		1,05 / 0,50		0,37/0,11	4800/2400	61/46	67
CJLINE-1640-6T	900	1,51	0,87		0,25	2950	54	66
CJLINE/H-1650-4T	1430	5,96	3,44		1,50	9650	74	99
CJLINE-1845-4T	1410	3,10	1,79		0,75	6800	65	83
CJLINE-1845-4/8T	1430/710		2,00 / 0,90		0,75/0,20	6800/3400	65/50	84
CJLINE-1845-6T	900	2,24	1,30		0,37	4360	57	81
CJLINE/H-1856-4T	1445	10,96	6,33		3,00	13580	77	117
CJLINE-1856-6T	900	2,99	1,73		0,55	7720	59	142
CJLINE-1856-6/12T	930/450		1,60 / 0,65		0,55/0,09	7720/3860	59/44	143
CJLINE-1856-8T	695	1,94	1,12		0,25	5800	52	143
CJLINE/H-2063-4T	1440		11,60	6,72	5,50	20900	79	228
CJLINE-2063-6T	945	3,90	2,20		0,75	11100	61	185

## Características técnicas

Modelo	Velocidad (r/min)	Intensidad máxima admisible (A)			Potencia instalada (kW)	Caudal máximo (m³/h)	Nivel sonoro dB(A)	Peso aprox. (Kg)
		230V	400V (A)	690V				
CJLINE-2063-6/12T	935/435	2,20 / 0,87			0,75/0,15	11100/5550	61/46	190
CJLINE-2063-8T	700	2,77	1,60		0,37	7730	54	188
CJLINE/H-2271-4T	1460	20,20		11,60	11,00	31170	84	283
CJLINE-2271-6T	955	6,42	3,71		1,50	14300	65	205
CJLINE-2271-6/12T	970/470	4,60 / 1,90			1,50/0,25	14300/7150	65/50	216
CJLINE-2271-8T	705	4,68	2,70		0,75	9900	57	204
CJLINE-2880-6T	960	12,70	7,30		3,00	22800	67	275
CJLINE-2880-6/12T	960/480	9,00 / 3,50			3,00/0,55	22800/11400	67/52	289
CJLINE-2880-8T	705	9,53	5,50		2,20	17200	58	275



## Erp. Características del punto de máxima eficiencia (BEP)

<b>MC</b>	Categoría de medición	<b>ηe[%]</b>	Eficiencia
<b>EC</b>	Categoría de eficiencia	<b>N</b>	Grado de eficiencia
<b>S</b>	Estática	<b>[kW]</b>	Potencia eléctrica
<b>T</b>	Total	<b>[m³/h]</b>	Caudal
<b>VSD</b>	Variador de velocidad	<b>[mmH₂O]</b>	Presión estática o total (Según EC)
<b>SR</b>	Relación específica	<b>[RPM]</b>	Velocidad

Modelo	MC	EC	VSD	SR	ηe[%]	N	(kW)	(m³/h)	(mmH₂O)	(RPM)
CJLINE-1131-4T	C	S	NO	1,00	41,2%	59,2	0,187	1246	22,75	1430
CJLINE-1131-4/8T	C	S	NO	1,00	43,7%	61,9	0,186	1269	23,59	1456
CJLINE-1235-4T	C	S	NO	1,00	48,5%	63,1	0,330	2218	26,47	1354
CJLINE-1235-4/8T	C	S	NO	1,00	51,4%	66,2	0,350	2307	28,63	1408
CJLINE-1235-6T	C	S	NO	1,00	62,0%	83,7	0,089	1338	15,13	966
CJLINE-1640-4T	C	S	NO	1,00	47,8%	61,3	0,451	2214	35,73	1393
CJLINE-1640-4/8T	C	S	NO	1,00	50,5%	64,3	0,485	2311	38,90	1453
CJLINE-1640-6T	C	S	NO	1,00	55,9%	74,5	0,175	1785	20,18	959
CJLINE/H-1650-4T	C	S	NO	1,01	52,3%	61,4	1,399	4746	56,59	1462
CJLINE-1845-4T	C	S	NO	1,00	64,6%	75,7	0,863	5376	38,07	1436
CJLINE-1845-4/8T	C	S	NO	1,00	55,6%	66,0	1,015	5399	38,40	1442
CJLINE-1845-6T	C	S	NO	1,00	48,9%	63,6	0,383	3346	20,55	935
CJLINE/H-1856-4T	C	S	NO	1,01	53,3%	59,5	2,704	6685	79,17	1472
CJLINE-1856-6T	C	S	NO	1,00	49,0%	60,3	0,731	4768	27,62	909
CJLINE-1856-6/12T	C	S	NO	1,00	49,0%	60,3	0,799	4911	29,30	936
CJLINE-1856-8T	C	S	NO	1,00	46,4%	61,4	0,302	4441	11,59	701
CJLINE/H-2063-4T	C	S	NO	1,01	67,6%	71,6	4,336	9344	115,11	1473
CJLINE-2063-6T	C	S	NO	1,00	60,6%	71,2	1,001	4849	45,92	957
CJLINE-2063-6/12T	C	S	NO	1,00	53,8%	63,9	1,077	4776	44,57	943
CJLINE-2063-8T	C	S	NO	1,00	46,4%	59,3	0,488	3908	21,29	702
CJLINE/H-2271-4T	C	S	NO	1,01	61,5%	61,7	10,225	18767	123,11	1479
CJLINE-2271-6T	C	S	NO	1,00	56,1%	63,8	1,925	7551	52,49	967
CJLINE-2271-6/12T	C	S	NO	1,00	51,6%	59,0	2,149	7621	53,48	976
CJLINE-2271-8T	C	S	NO	1,00	48,9%	59,3	0,888	6062	26,31	713
CJLINE-2880-6T	C	S	NO	1,01	62,7%	68,1	3,351	12895	59,85	975
CJLINE-2880-6/12T	C	S	NO	1,01	54,4%	59,1	3,816	12845	59,39	971
CJLINE-2880-8T	C	S	NO	1,00	58,0%	65,5	1,774	10729	35,22	726

Datos del Plug Fan interno

## Características acústicas

Los valores indicados, se determinan mediante medidas de nivel de presión y potencia sonora en dB(A) obtenidas en campo libre a una distancia equivalente a dos veces la envergadura del ventilador más el diámetro de la turbina, con un mínimo de 1,5 mts.

Espectro de potencia sonora Lw(A) en dB(A) por banda de frecuencia en Hz

Modelo	63	125	250	500	1000	2000	4000	8000	Modelo	63	125	250	500	1000	2000	4000	8000
CJLINE 1131-4	42	51	57	56	60	60	52	46	CJLINE 1856-8	51	57	62	63	66	65	58	53
CJLINE 1131-8	27	36	42	41	45	45	37	31	CJLINE 1856-12	43	49	54	55	58	57	50	45
CJLINE 1235-4	49	58	64	63	67	66	59	53	CJLINE/H 2063-4	81	86	93	94	93	90	83	75
CJLINE 1235-6	43	52	58	57	61	60	53	47	CJLINE 2063-6	60	66	72	72	76	76	68	61
CJLINE 1235-8	34	43	59	48	52	51	44	38	CJLINE 2063-8	53	59	65	65	69	69	61	54
CJLINE 1640-4	56	62	67	68	71	73	65	59	CJLINE 2063-12	45	51	57	57	61	61	53	46
CJLINE 1640-6	49	55	60	61	64	66	58	52	CJLINE/H 2271-4	83	84	93	96	99	99	95	82
CJLINE 1640-8	41	47	52	53	56	58	50	44	CJLINE 2271-6	64	70	76	76	80	80	72	65
CJLINE/H 1650	64	74	82	84	83	85	76	66	CJLINE 2271-8	56	62	68	68	72	72	64	57
CJLINE 1845-4	60	66	71	72	75	77	69	63	CJLINE 2271-12	49	55	61	61	65	65	57	50
CJLINE 1845-6	52	58	63	64	67	69	61	55	CJLINE 2880-6	66	72	78	78	82	82	74	67
CJLINE 1845-8	45	51	56	57	60	62	54	48	CJLINE 2880-8	57	63	69	69	73	73	65	58
CJLINE 1856-6	58	64	69	70	73	72	65	60	CJLINE 2880-12	51	57	63	63	67	67	59	52
CJLINE/H 1856-4	69	77	91	87	90	90	85	71									

## Dimensiones mm

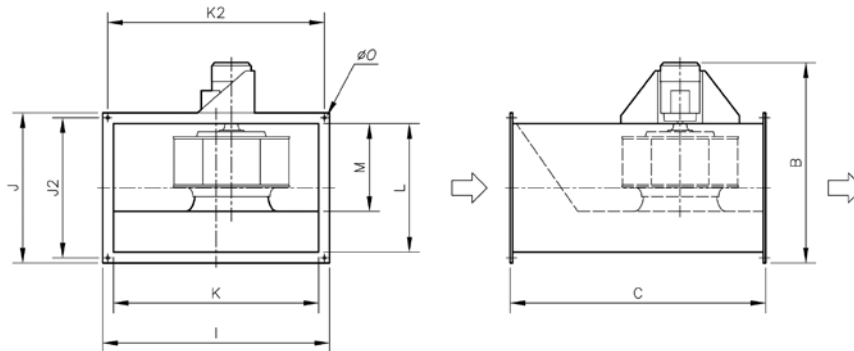

Modelo	B	C	I	J	J2	K	k2	L	M	ØO
CJLINE-1131	760	710	620	510	483	560	593	450	175	10
CJLINE-1235	830	800	680	560	533	620	653	500	213	10
CJLINE-1640	890	900	770	620	593	710	743	560	262	10
CJLINE-1650/H	942	1000	860	690	663	800	833	630	290	10
CJLINE-1845	1010	1000	860	690	663	800	833	630	290	10
CJLINE-1856	1280	1250	1060	860	833	1000	1033	800	378	10
CJLINE-1856/H	1150	1250	1060	860	833	1000	1033	800	378	10
CJLINE-2063	1390	1400	1205	980	938	1125	1163	900	378	12
CJLINE-2063/H	1320	1400	1205	980	938	1125	1163	900	378	12
CJLINE-2271	1470	1400	1270	980	938	1190	1228	900	378	12
CJLINE-2271/H	1518	1400	1270	980	938	1190	1228	900	378	12
CJLINE-2880	1590	1500	1330	1080	1038	1250	1288	1000	490	12

**Curvas características**

Q= Caudal en m<sup>3</sup>/h, m<sup>3</sup>/s y cfm.

Pe= Presión estática en mmH<sub>2</sub>O, Pa e inwg.

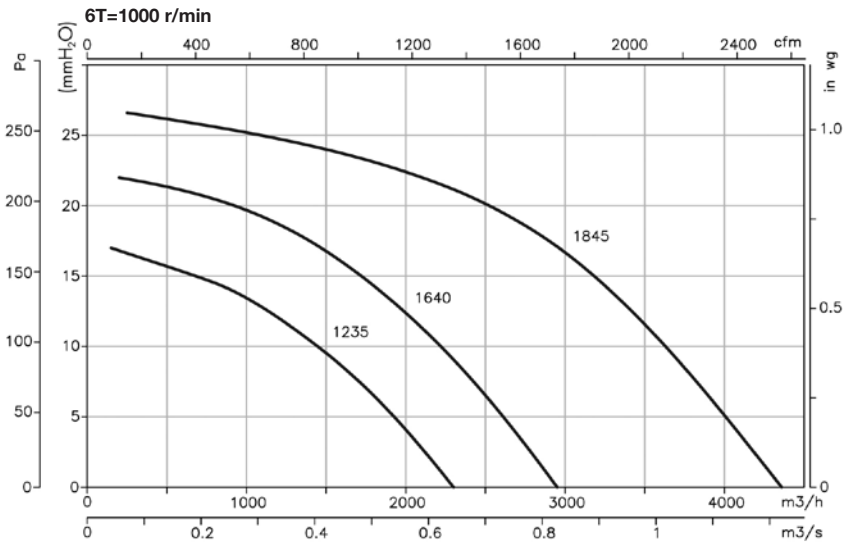
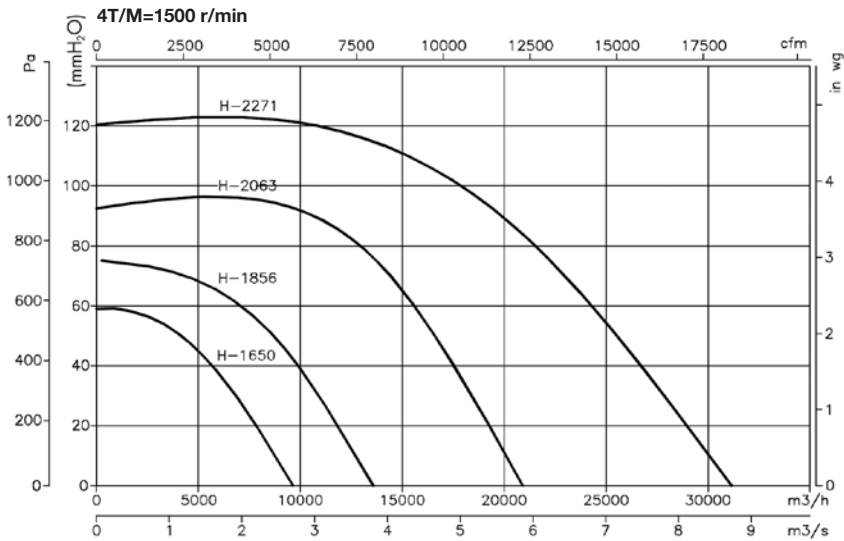
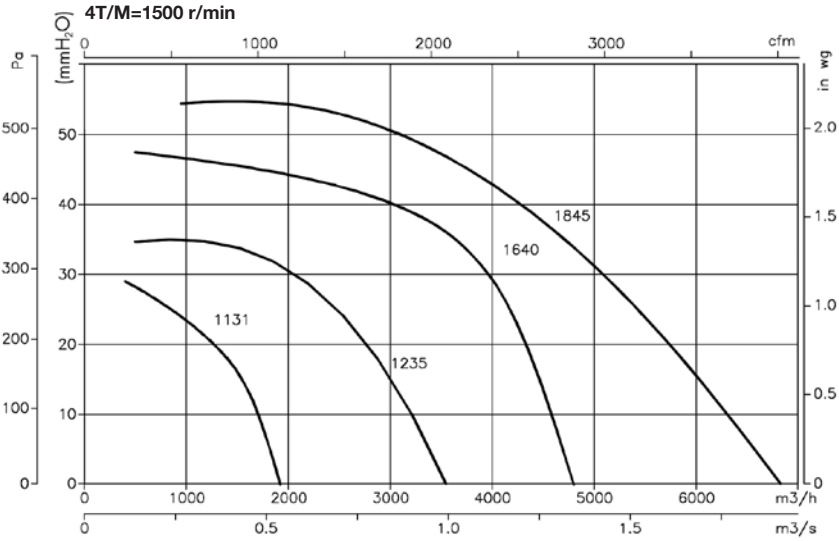

**Curvas características**

Q= Caudal en m³/h, m³/s y cfm.

Pe= Presión estática en mmH<sub>2</sub>O, Pa e inwg.

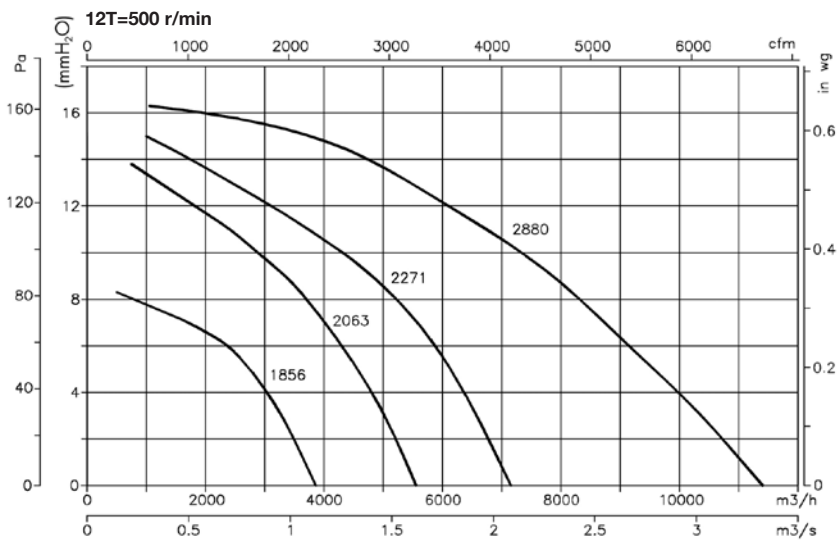
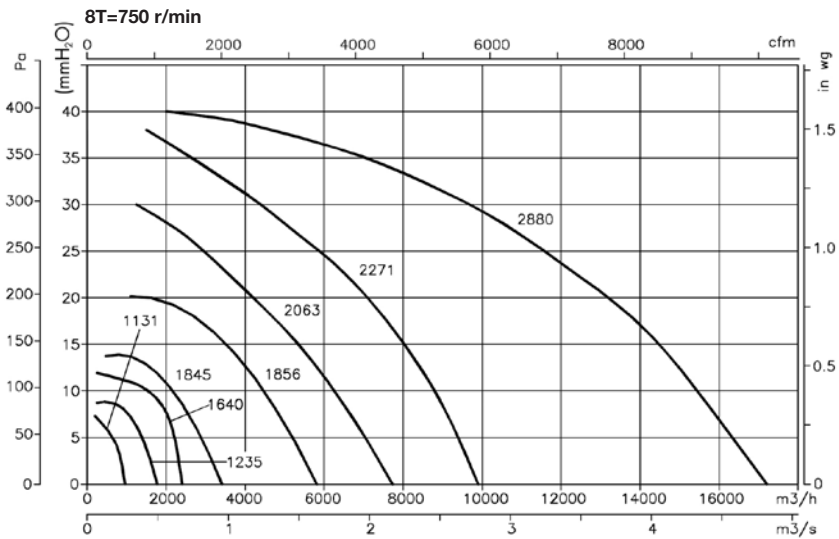
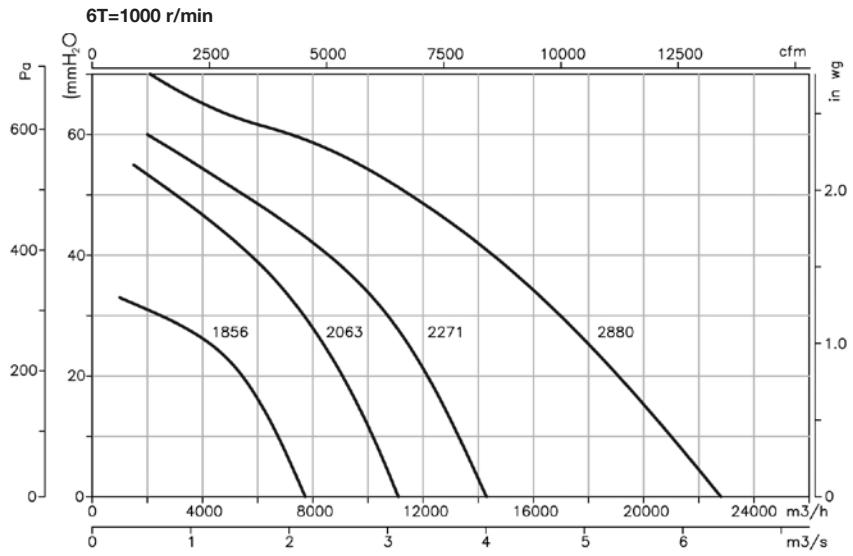

**Accesorios**

Ver apartado accesorios



# CJEC



Facilidad de desmontaje conjunto motor-turbina

## Unidades de extracción 400°C/2h con puerta de gran dimensión para poder realizar el mantenimiento con gran facilidad

Unidades de extracción con puerta de gran dimensión para poder realizar el mantenimiento con gran facilidad.

### Ventilador:

- Estructura en chapa de acero galvanizado
- Turbina con álabes a reacción, en chapa de acero galvanizado
- Homologación según norma EN 12101-3:2002/AC:2006, con certificación N°: 0370-CPR-0382
- Posibilidad de montar la boca de impulsión en cualquier lateral de la caja, durante la instalación

### Motor:

- Motores clase F, con rodamientos a bolas, protección IP55 de 2 velocidades
- Trifásicos 400V-50Hz DHALANDER
- Temperatura máxima del aire a transportar: -20°C + 120°C

### Acabado:

- Anticorrosivo en chapa de acero galvanizado

### Bajo demanda:

- Con motores de 1 velocidad



## Código de pedido

**CJEC — 280 — 4M**

Unidades de extracción con puerta de gran dimensión para poder realizar el mantenimiento con gran facilidad

Tamaño turbina

Número de polos motor

2=2900 r/min 50 Hz  
4=1400 r/min 50 Hz

6=900 r/min 50 Hz  
8=750 r/min 50 Hz  
12=500 r/min 50 Hz

M= Monofásico  
T=Trifásico

## Características técnicas

Modelo	Velocidad (r/min)	Intensidad máxima admisible (A)		Potencia instalada (kW)	Caudal máximo (m³/h)	Nivel sonoro dB(A)		Peso aprox. (Kg)
		230V	400V			Aspiración	Descarga	
CJEC-280-4/8T	1380 / 720		0,60 / 0,70	0,18 / 0,04	1370 / 685	55 / 40	60 / 45	61
CJEC-280-4M	1380	0,65		0,25	1370	55	60	61
CJEC-315-4/8T	1440 / 700		1,05 / 0,50	0,37 / 0,11	1650 / 825	59 / 44	63 / 48	63
CJEC-315-4M	1380	0,95		0,25	1650	59	63	63
CJEC-355-4/8T	1440 / 700		1,05 / 0,50	0,37 / 0,11	3000 / 1500	61 / 46	66 / 51	75
CJEC-355-4M	1380	1,35		0,25	3000	61	66	75
CJEC-400-4/8T	1450 / 720		1,70 / 0,80	0,55 / 0,19	4000 / 2000	65 / 50	69 / 54	79
CJEC-400-4M	1380	3,30		0,55	4000	65	69	79
CJEC-450-4/8T	1430 / 710		2,00 / 0,90	0,75 / 0,20	5500 / 2750	68 / 53	72 / 57	89
CJEC-450-4M	1380	4,40		0,75	5500	68	72	89
CJEC-500-4/8T	1420 / 700		3,50 / 1,50	1,50 / 0,37	7600 / 3800	70 / 55	75 / 60	110
CJEC-560-6/12T	940 / 460		3,50 / 1,20	1,30 / 0,20	9500 / 4750	77 / 62	82 / 67	129



## Erp. Características del punto de máxima eficiencia (BEP)

<b>MC</b>	Categoría de medición	<b>ηe[%]</b>	Eficiencia
<b>EC</b>	Categoría de eficiencia	<b>N</b>	Grado de eficiencia
<b>S</b>	Estática	<b>[kW]</b>	Potencia eléctrica
<b>T</b>	Total	<b>[m³/h]</b>	Caudal
<b>VSD</b>	Variador de velocidad	<b>[mmH₂O]</b>	Presión estática o total (Según EC)
<b>SR</b>	Relación específica	<b>[RPM]</b>	Velocidad

Modelo	MC	EC	VSD	SR	ηe[%]	N	(kW)	(m³/h)	(mmH₂O)	(RPM)
CJEC-280-4/8T	-	-	-	-	-	-	0,114	858	18,92	1460
CJEC-280-4M	-	-	-	-	-	-	0,097	836	17,95	1422
CJEC-315-4/8T	C	S	NO	1,00	49,2%	67,9	0,167	1241	24,28	1474
CJEC-315-4M	C	S	NO	1,00	41,5%	59,9	0,177	1197	22,58	1421
CJEC-355-4/8T	C	S	NO	1,00	51,6%	67,8	0,292	1765	31,32	1469
CJEC-355-4M	C	S	NO	1,00	43,6%	59,6	0,299	1683	28,45	1400
CJEC-400-4/8T	C	S	NO	1,00	48,5%	61,1	0,630	3391	33,11	1463
CJEC-400-4M	C	S	NO	1,00	46,6%	59,3	0,608	3305	31,45	1426
CJEC-450-4/8T	C	S	NO	1,00	49,8%	60,2	1,028	4749	39,64	1432
CJEC-450-4M	C	S	NO	1,00	49,5%	60,0	0,994	4684	38,56	1412
CJEC-500-4/8T	C	S	NO	1,01	50,4%	58,9	1,545	4846	59,02	1447
CJEC-560-6/12T	C	S	NO	1,00	51,2%	64,4	0,549	4670	22,08	1009

Datos del Plug Fan interno



**Características acústicas**

Los valores indicados, se determinan mediante medidas de nivel de presión y potencia sonora en dB(A) obtenidas en campo libre a una distancia equivalente a dos veces la envergadura del ventilador más el diámetro de la turbina, con un mínimo de 1,5 mts.

Espectro de potencia sonora Lw(A) en dB(A) por banda de frecuencia en Hz

Valores tomados a la aspiración con caudal máximo.									Valores tomados a la descarga con caudal máximo.								
Modelo	63	125	250	500	1000	2000	4000	8000	Modelo	63	125	250	500	1000	2000	4000	8000
280-4	42	47	62	59	60	58	53	45	280-4	42	45	65	66	65	65	58	49
280-8	27	32	47	44	45	43	38	30	280-8	27	30	50	51	50	50	43	34
315-4	53	62	64	64	64	62	54	42	315-4	45	59	67	69	68	68	60	53
315-8	38	47	49	49	49	47	39	27	315-8	30	44	52	54	53	53	45	38
355-4	52	62	68	63	64	66	62	53	355-4	48	67	68	71	72	71	64	55
355-8	37	47	53	48	49	51	47	38	355-8	33	52	53	56	57	56	49	40
400-4	60	69	72	65	68	69	65	56	400-4	52	70	73	73	75	74	70	59
400-8	45	54	57	50	53	54	50	41	400-8	37	55	58	58	60	59	55	44
450-4	56	65	71	76	72	71	65	57	450-4	56	69	75	77	79	76	71	61
450-8	56	69	75	77	79	76	71	61	450-8	41	54	60	62	64	61	56	46
500-4	57	62	73	76	76	75	69	60	500-4	58	67	78	79	83	80	74	63
500-8	42	47	58	61	61	60	54	45	500-8	43	52	63	64	68	65	59	48
560-6	69	78	80	81	82	82	79	57	560-6	65	79	85	86	90	86	81	72
560-12	54	63	65	66	67	67	64	57	560-12	50	64	70	71	75	71	66	57

**Dimensiones mm**

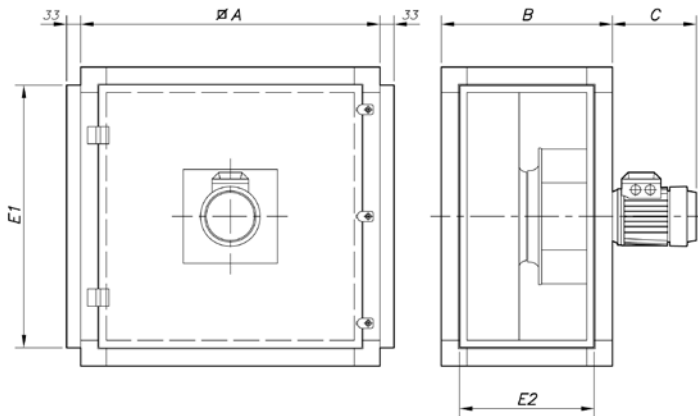

Modelo	ØA	B	C	E1	E2
CJEC-280	700	400	200	618	318
CJEC-315	700	400	200	618	318
CJEC-355	800	505	200	718	423
CJEC-400	800	505	225	718	423
CJEC-450	900	550	225	818	468
CJEC-500	900	550	260	818	468
CJEC-560	1000	700	290	918	618

**Curvas características**

Q= Caudal en m<sup>3</sup>/h, m<sup>3</sup>/s y cfm Pe= Presión estática en mmH<sub>2</sub>O, Pa e inwg

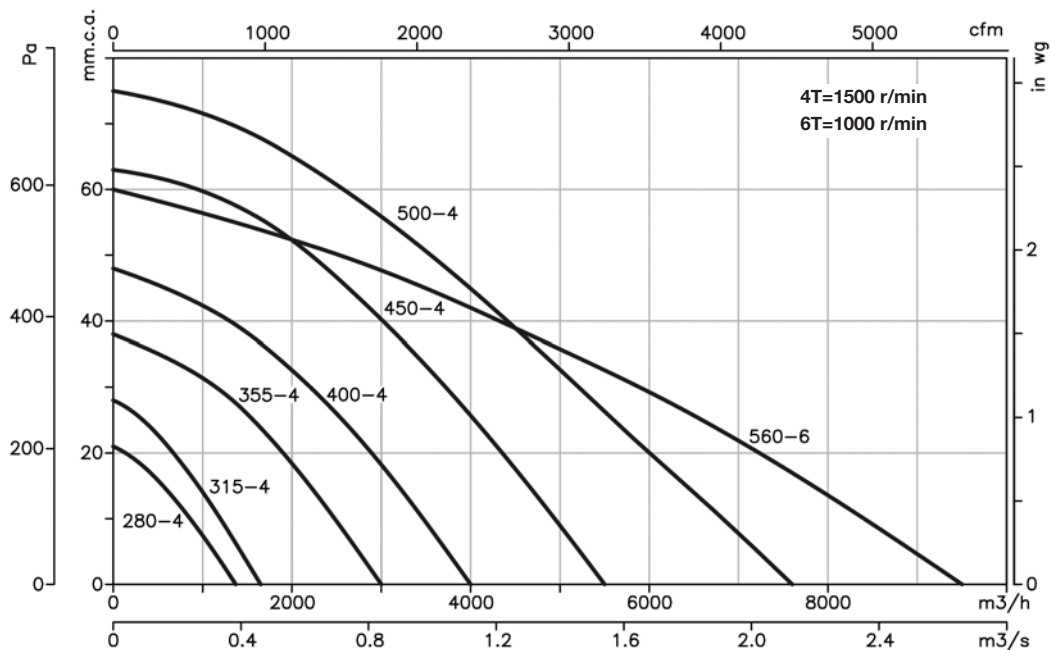

**Curvas características**

Q= Caudal en m<sup>3</sup>/h, m<sup>3</sup>/s y cfm

Pe= Presión estática en mmH<sub>2</sub>O, Pa e inwg

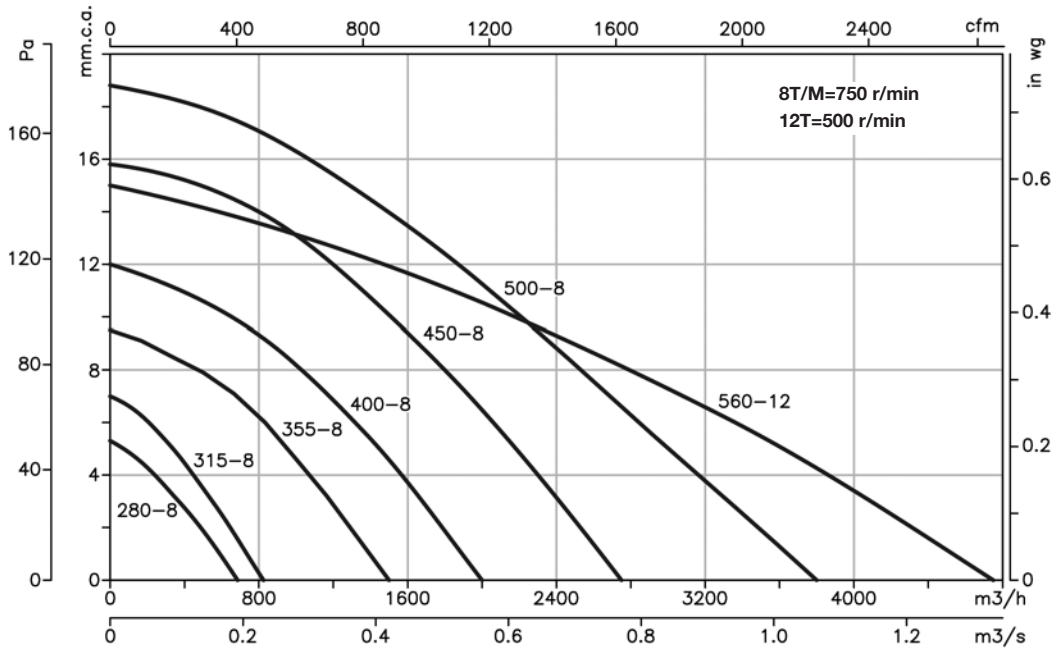

**Instalaciones CJEC**

Posibilidad de instalación de la serie CJEC cambiando la colocación de los paneles de aspiración e impulsión.

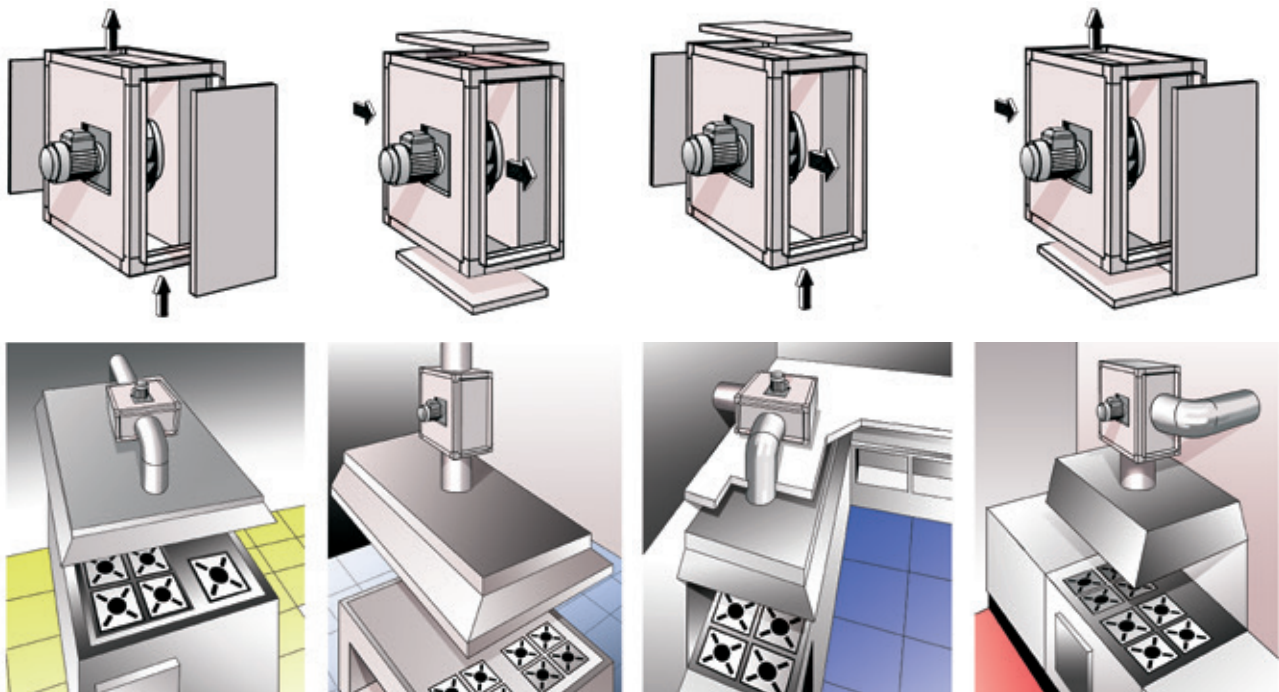

**Accesorios**

Ver apartado accesorios



# CHT CVT

## Extractores centrífugos de tejado 400°C/2h, con salida de aire horizontal o vertical

CHT: Extractores centrífugos de tejado 400°C/2h, con salida de aire horizontal, sombrero en aluminio

CVT: Extractores centrífugos de tejado 400°C/2h, con salida de aire vertical, sombrero en aluminio



CHT



CVT

### Ventilador:

- Base soporte en chapa de acero galvanizado
- Turbina con álabes a reacción, en chapa de acero galvanizado
- Rejilla de protección antipájaros
- Sombrero deflector antilluvia en aluminio
- Homologación según norma EN 12101-3:2002/AC:2006, con certificación N°: 0370-CPR-0897

### Motor:

- Motores eficiencia IE-2, excepto potencias inferiores a 0,75 kW, monofásicos y 2 velocidades.
- Motores clase F, con rodamientos a bolas, protección IP55, excepto modelos monofásicos, protección IP54, de 1 ó 2 velocidades según modelo
- Monofásicos 230V-50Hz, y trifásicos 230/400V-50Hz
- Temperatura máxima del aire a transportar: -25°C+ 120°C

### Acabado:

- Anticorrosivo en chapa de acero galvanizado y aluminio

### Bajo demanda:

- Bobinados especiales para diferentes tensiones.
- Certificación ATEX Categoría 3.



Soportes que facilitan la colocación al tejado



## Código de pedido

**CHT — 200 — 4T — BS**

CHT: Extractores centrífugos de tejado 400°C/2h, con salida de aire horizontal

CVT: Extractores centrífugos de tejado 400°C/2h, con salida de aire vertical

Tamaño turbina

Número de polos motor  
 2=2900 r/min. 50 Hz  
 4=1400 r/min. 50 Hz  
 6=900 r/min. 50 Hz  
 8=750 r/min. 50 Hz  
 12=500 r/min. 50 Hz

T=Trifásico

BS: Base soporte elevada  
 BSS: Base soporte elevada con silenciador

## Características técnicas

Modelo	Velocidad (r/min)	Intensidad máxima admisible (A)		Potencia instalada (kW)	Caudal máximo (m³/h)	Nivel sonoro dB(A)		Peso aprox. (Kg)
		230V	400V			Aspiración	Descarga	
CHT CVT 200-4T	1350	1,66	0,96	0,25	1450	37	43	25
CHT CVT 200-4M	1380	0,65		0,25	1450	37	43	25
CHT CVT 225-4T	1350	1,66	0,96	0,25	2100	41	47	25
CHT CVT 225-4M	1380	0,95		0,25	2100	41	47	25
CHT CVT 225-6T	900	1,51	0,87	0,25	1400	30	36	26
CHT CVT 225-6M	890	0,50		0,25	1400	30	36	26
CHT CVT 250-4T	1350	1,66	0,96	0,25	3100	45	50	34
CHT CVT 250-4M	1380	1,35		0,25	3100	45	50	34
CHT CVT 250-6T	900	1,51	0,87	0,25	2000	33	40	35
CHT CVT 250-6M	890	0,65		0,25	2000	33	40	35
CHT CVT 315-4T	1380	2,92	1,69	0,55	4950	48	54	39
CHT CVT 315-4/8T	1450/720		1,70 / 0,80	0,55 / 0,19	4950 / 2475	48 / 33	54 / 39	40

## Características técnicas

Modelo	Velocidad (r/min)	Intensidad máxima admisible (A)		Potencia instalada (kW)	Caudal máximo (m³/h)	Nivel sonoro dB(A)		Peso aprox. (Kg)
		230V	400V			Aspiración	Descarga	
CHT CVT 315-4M	1380	3,30		0,55	4950	48	54	39
CHT CVT 315-6T	900	2,24	1,30	0,37	3200	37	43	39
CHT CVT 315-6M	910	0,95		0,37	3200	37	43	39
CHT CVT 400-4T	1410	3,10	1,79	0,75	7000	55	61	57
CHT CVT 400-4/8T	1430 / 710		2,00 / 0,90	0,75 / 0,20	7000 / 3500	55 / 40	61 / 46	58
CHT CVT 400-4M	1380	4,40		0,75	7000	55	61	57
CHT CVT 400-6T	900	2,24	1,30	0,37	4500	44	50	56
CHT CVT 400-6M	910	1,80		0,37	4500	44	50	56
CHT CVT 450-4T	1430	5,96	3,44	1,50	10200	59	64	66
CHT CVT 450-4/8T	1420 / 700		3,50 / 1,50	1,50 / 0,37	10200 / 5100	59 / 43	64 / 49	66
CHT CVT 450-6T	900	2,24	1,30	0,37	6900	47	54	59
CHT CVT 450-6/12T	930 / 450		1,60 / 0,65	0,55 / 0,09	6900 / 3450	47 / 32	54 / 39	63
CHT CVT 450-6M	910	2,00		0,37	6900	47	54	59
CHT CVT 500-6T	945	4,88	2,82	1,10	12000	51	57	103
CHT CVT 500-6/12T	950 / 470		3,00 / 1,15	1,10 / 0,18	12000 / 6000	51 / 36	57 / 42	110
CHT CVT 500-8T	695	3,53	2,04	0,55	8900	44	50	103
CHT CVT 560-6T	955	9,30	5,30	2,20	17300	54	61	126
CHT CVT 560-6/12T	940 / 470		5,60 / 2,20	2,20 / 0,37	17300 / 8650	54 / 39	61 / 46	120
CHT CVT 560-8T	705	5,63	3,25	1,10	12900	46	53	110
CHT CVT 630-6T	960	16,50	9,46	4,00	24700	58	64	166
CHT CVT 630-6/12T	970 / 480		11,00 / 4,00	4,00 / 0,65	24700 / 12350	58 / 43	64 / 49	161
CHT CVT 630-8T	705	7,10	4,10	1,50	18400	50	57	148

(1) Los valores de los niveles sonoros, son presiones en dB(A), medidos a 6 metros, y a 2/3 del caudal máximo (2/3 Qmáx.)



## Erp. Características del punto de máxima eficiencia (BEP)

Modelo	MC	EC	VSD	SR	ηe[%]	N	(kW)	(m³/h)	(mmH₂O)	(RPM)
200-4T	-	-	-	-	-	-	0,099	855	17,36	1462
200-4M	-	-	-	-	-	-	0,114	888	18,71	1467
225-4T	C	S	NO	1,00	41,2%	59,9	0,169	1205	21,26	1430
225-4M	C	S	NO	1,00	42,0%	60,1	0,189	1257	23,15	1442
225-6T	-	-	-	-	-	-	0,054	826	10,00	981
225-6M	-	-	-	-	-	-	0,068	875	11,21	986
250-4T	C	S	NO	1,00	45,0%	61,1	0,292	1788	26,99	1359
250-4M	C	S	NO	1,00	43,5%	59,3	0,315	1813	27,75	1377
250-6T	-	-	-	-	-	-	0,106	1262	13,44	959
250-6M	C	S	NO	1,00	40,6%	60,1	0,138	1344	15,26	971
315-4T	C	S	NO	1,00	50,4%	63,3	0,588	2652	41,02	1381
315-4/8T	C	S	NO	1,00	50,2%	62,4	0,690	2794	45,50	1454
315-4M	C	S	NO	1,00	48,1%	60,6	0,653	2705	42,67	1408
315-6T	C	S	NO	1,00	43,4%	61,4	0,192	1689	18,09	956
315-6M	C	S	NO	1,00	45,5%	62,9	0,219	1792	20,35	963
400-4T	C	S	NO	1,00	60,8%	72,4	0,788	4472	39,34	1411
400-4/8T	C	S	NO	1,00	52,3%	63,0	0,956	4536	40,48	1432
400-4M	C	S	NO	1,00	48,3%	59,1	0,942	4343	38,48	1419
400-6T	C	S	NO	1,00	48,9%	64,6	0,319	3148	18,20	926
400-6M	C	S	NO	1,00	51,3%	66,4	0,363	3338	20,46	933
450-4T	C	S	NO	1,01	60,6%	67,9	2,018	7176	62,55	1440
450-4/8T	C	S	NO	1,01	53,3%	60,1	2,254	7133	61,81	1431
450-6T	C	S	NO	1,00	54,1%	66,5	0,667	4779	27,75	959
450-6/12T	C	S	NO	1,00	49,0%	60,7	0,767	4844	28,51	948
450-6M	C	S	NO	1,00	47,6%	59,1	0,796	4854	28,63	925
500-6T	C	S	NO	1,00	62,9%	72,5	1,238	6832	41,88	923
500-6/12T	C	S	NO	1,00	61,7%	70,8	1,372	7023	44,25	957
500-8T	C	S	NO	1,00	47,1%	59,4	0,674	5027	23,21	695
560-6T	C	S	NO	1,01	59,4%	66,1	2,282	9457	52,64	956
560-6/12T	C	S	NO	1,01	53,4%	59,9	2,422	9313	51,05	942
560-8T	C	S	NO	1,00	53,0%	63,2	1,060	7052	29,27	713
630-6T	C	S	NO	1,01	63,0%	67,3	3,879	14310	62,66	968
630-6/12T	C	S	NO	1,01	58,3%	62,2	4,250	14377	63,25	973
630-8T	C	S	NO	1,00	58,0%	66,3	1,629	10429	33,28	706

Datos del punto de máxima eficiencia del conjunto motor turbina

## Características acústicas

Los valores indicados, se determinan mediante medidas de nivel de presión y potencia sonora en dB(A) obtenidas en campo libre a una distancia de 6 mts.

Espectro de potencia sonora Lw(A) en dB(A) por banda de frecuencia en Hz

Valores tomados a la aspiración con 2/3 caudal máximo (2/3Qmax).

Modelo	63	125	250	500	1000	2000	4000	8000
200	35	41	52	55	56	52	50	44
225-4	42	51	56	56	60	59	52	46
225-6	31	40	45	45	49	48	41	35
250-4	46	55	60	60	64	63	56	50
250-6	34	43	48	48	52	51	44	38
315-4	50	56	62	62	65	68	59	53
315-6	39	45	51	51	54	57	48	42
315-8	35	41	47	47	50	53	44	38
400-4	57	63	69	69	72	75	66	60
400-6	46	52	58	58	61	64	55	49
400-8	42	48	54	54	57	60	51	45
450-4	62	69	74	74	78	77	70	65
450-6	50	57	62	62	66	65	58	53
450-8	46	53	58	58	62	61	54	49
450-12	35	42	47	47	51	50	43	38
500-6	54	60	65	66	70	69	62	55
500-8	47	53	58	59	63	62	55	48
500-12	39	45	50	51	55	54	47	40
560-6	57	63	68	69	73	72	65	58
560-8	49	55	60	61	65	64	57	50
560-12	42	48	53	54	58	57	50	43
630-6	61	67	72	73	77	76	69	62
630-8	53	59	64	65	69	68	61	54
630-12	46	52	57	58	62	61	54	47

Valores tomados a la descarga con 2/3 caudal máximo (2/3Qmax).

Modelo	63	125	250	500	1000	2000	4000	8000
200	39	44	58	60	61	61	56	51
225-4	41	50	60	64	67	64	57	51
225-6	30	39	49	53	56	53	46	40
250-4	44	53	63	67	70	67	60	54
250-6	34	43	53	57	60	57	50	44
315-4	49	61	69	71	72	72	64	56
315-6	38	50	58	60	61	61	53	45
315-8	34	46	54	56	57	57	49	41
400-4	56	68	76	78	79	79	71	63
400-6	45	57	65	67	68	68	60	52
400-8	41	53	61	63	64	64	56	48
450-4	60	72	80	82	83	80	73	65
450-6	50	62	70	72	73	70	63	55
450-8	45	57	65	67	68	65	58	50
450-12	35	47	55	57	58	55	48	40
500-6	50	64	72	76	75	72	66	60
500-8	43	57	65	69	68	65	59	53
500-12	35	49	57	61	60	57	51	45
560-6	54	68	76	80	79	76	70	64
560-8	46	60	68	72	71	68	62	56
560-12	39	53	61	65	64	61	55	49
630-6	57	71	79	83	72	79	73	67
630-8	50	64	72	76	72	72	66	60
630-12	42	56	64	68	67	64	58	52

Para obtener los espectros de potencia sonora Lwa en dB(A) en la aspiración a caudal máximo (Qmax), sumar al nivel de presión sonora LpA dado en las curvas características, los valores de la tabla siguiente:

Banda de frecuencia en Hz							
63	125	250	500	1000	2000	4000	8000
2	9	15	15	18	18	11	5

## Dimensiones mm

### CHT

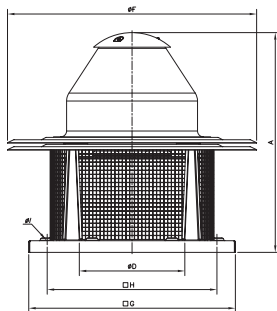

Modelo	A	øD*	øF	G	H	øI
CHT-200	552	250	570	450	360	12
CHT-225	570	250	570	450	360	12
CHT-250	632	355	726	560	450	12
CHT-315	682	355	726	560	450	12
CHT-400	755	500	856	710	590	12
CHT-450	770	500	856	710	590	12
CHT-500	846	630	1075	900	750	14
CHT-560	1035	710	1300	1100	900	14
CHT-630	1098	710	1300	1100	900	14

(\*) Diámetro nominal tubería recomendada

### CVT

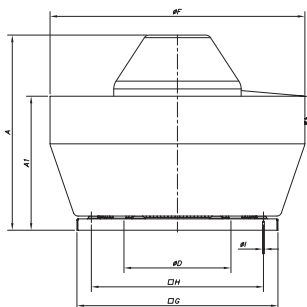

Modelo	A	A1	øD*	øF	G	H	øI
CVT-200	500	308	250	530	450	360	12
CVT-225	517	308	250	530	450	360	12
CVT-250	580	380	355	705	560	450	12
CVT-315	630	380	355	705	560	450	12
CVT-400	690	475	500	900	710	590	12
CVT-450	705	475	500	900	710	590	12
CVT-500	775	545	630	1100	900	750	14
CVT-560	956	676	710	1295	1100	900	14
CVT-630	1017	676	710	1295	1100	900	14

(\*) Diámetro nominal tubería recomendada

## Accesorios

Ver apartado accesorios



**Curvas características**

Q= Caudal en m<sup>3</sup>/h, m<sup>3</sup>/s y cfm.

Pe= Presión estática en mmH<sub>2</sub>O, Pa e inwg.

Los niveles sonoros L<sub>p</sub> (dB(A)) indicados en las curvas, son presiones medidas a 6 metros, a la aspiración y en campo libre.

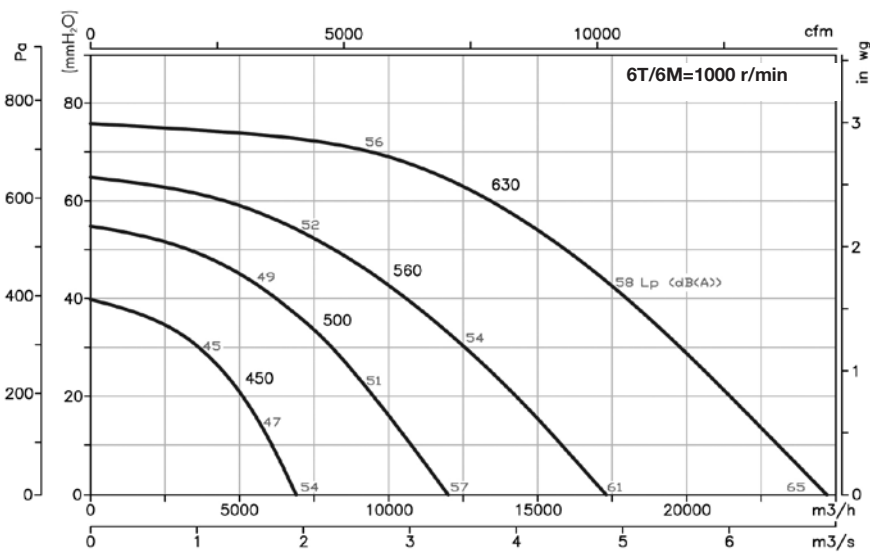
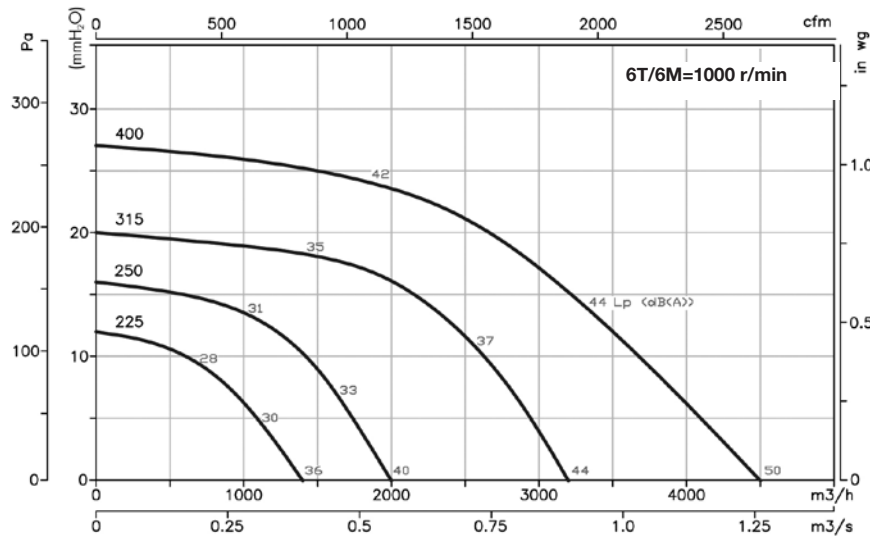
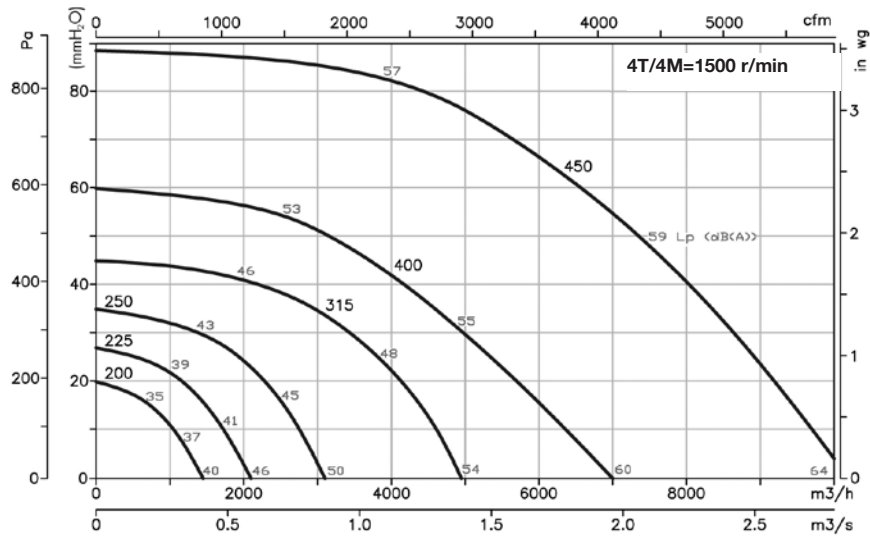

## Curvas características

Q= Caudal en m<sup>3</sup>/h, m<sup>3</sup>/s y cfm.

Pe= Presión estática en mmH<sub>2</sub>O, Pa e inwg.

Los niveles sonoros L<sub>p</sub> (dB(A)) indicados en las curvas, son presiones medidas a 6 metros, a la aspiración y en campo libre.

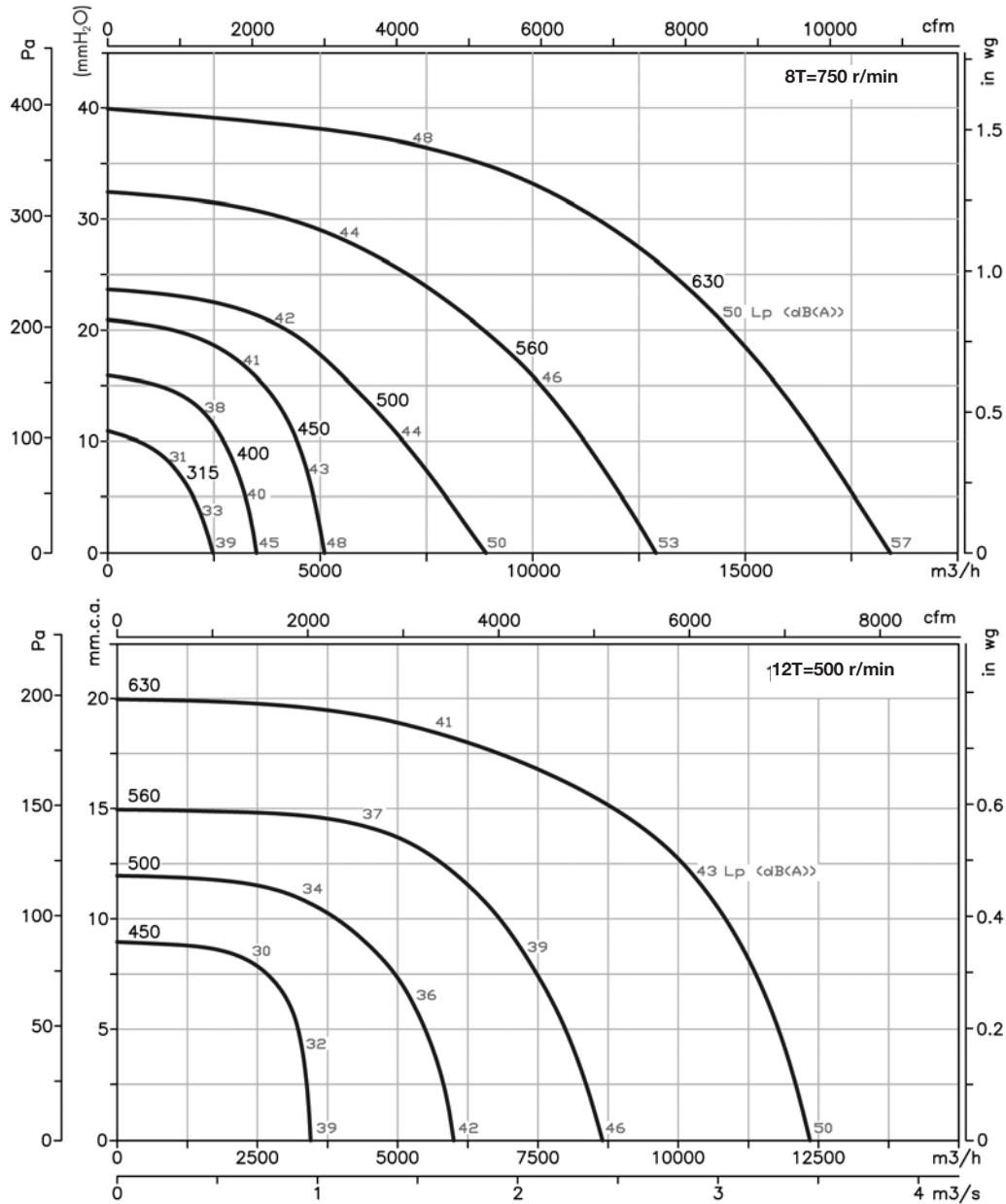

### Variación de la presión sonora según distancia

El nivel sonoro puede variar dependiendo de la estructura de la cubierta o tejado.

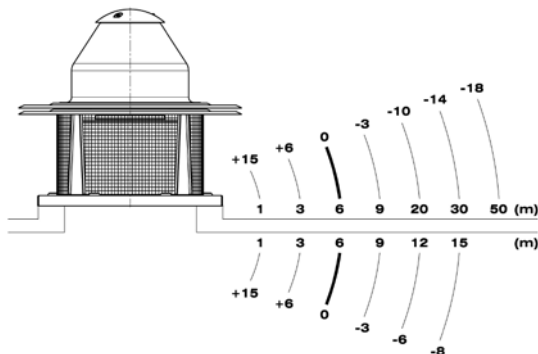

### Ejemplo de aplicación

Extractores idóneos para aplicación en cocinas industriales

Para la correcta aplicación de la norma:

- C.T.E. Código Técnico de la Edificación. Documento Básico SI de seguridad en caso de incendio. Documento Básico HS de salubridad.

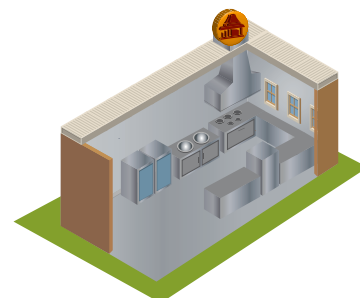

# KIT SOBREPRESIÓN

**El sistema de presurización de escaleras, vías de escape o de confinamiento, permite controlar de forma automática el caudal y mantener una presión diferencial de 50 Pa en una sola etapa, según norma UNE EN 12101-6-2006**

KIT SOBREPRESIÓN DE ESCALERAS  
Para equipos trifásicos



## KIT SOBREPRESIÓN DE ESCALERAS

- Kit sobrepresión de escaleras, formado por un cuadro de control (BOXPRES KIT) y unidades de impulsión (CJHCH o CJBD), para la presurización de las escaleras y rutas de escape. También disponible para equipos monofásicos NEOLINEO Y CJBC.

## KIT SOBREPRESIÓN CON VENTILADOR DE RESERVA

- Kit de sobrepresión con ventilador de reserva, formado por un cuadro de control (BOXPRES KIT II), que incorpora un sistema de conmutación automático para mantener la sobrepresión en caso de fallo del ventilador principal, y unidades de impulsión de aire con ventilador de reserva serie TWIN o CJHCH/DUPLEX.

KIT SOBREPRESIÓN DE ESCALERAS  
Para equipos monofásicos



## BOXPRES



- Fácil instalación
- Solución compacta y autónoma
- Mantenimiento preventivo
- Fácil puesta en marcha
- Instalación segura y funcional



- El buen funcionamiento de los sistemas de presurización, depende no solo del buen diseño de los mismos, sino también de la buena regulación que realice el sistema, por lo que es de vital importancia contar con elementos de regulación calibrados y de gran precisión, que permitan simultanear las dos situaciones presentes en caso de incendio, de forma rápida y estable.
- El cuadro de control BOXPRES, además de cumplir con las máximas exigencias, simplifica al máximo el trabajo del instalador.

KIT SOBREPRESIÓN CON  
VENTILADOR DE RESERVA



Incluye:

- Variador de frecuencia programado a 50 Pa
- Sonda de presión diferencial
- Magneto térmico
- Led de línea y fallo
- Pulsador de chequeo

BOXPRES, es un equipo con todas sus conexiones entre sí realizadas y probadas

- Listo para funcionar y desempeñar su función sobre el control de la presión de la instalación.
- Posibilidad de chequeo de la instalación para evitar fallos
- Solo se debe conectar la línea de alimentación, el ventilador de impulsión y la señal de incendio.

Los cuadros para equipos monofásicos incluyen:

- Regulador de tensión programado a 50 Pa
- Sonda de presión diferencial externa al equipo.

## Código de pedido

**KIT SOBREPRESIÓN — 7.100**

Kit sobrepresión: Conjunto de sobrepresión para escaleras  
Kit sobrepresión II: Conjunto de sobrepresión con ventilador de reserva

Caudal máximo



## Características técnicas

Modelo	Alimentación	Salida	Unidad de impulsión	Caudal (m <sup>3</sup> /h)	Nivel sonoro irradiado * dB(A)
KIT SOBREPRESION-1060-LED	230 Vac II	230 Vac II	NEOLINEO-200	1060	38
KIT SOBREPRESION-2300-LED	230 Vac II	230 Vac II	NEOLINEO-315	2300	47
KIT SOBREPRESION-2880-LED	230 Vac II	230 Vac II	CJBC-2828-6M 1/3	2880	61
KIT SOBREPRESION-7100-LED	230 Vac II	230 Vac III	CJHCH-45-4T-0,5	7100	55
KIT SOBREPRESION-7800-LED	230 Vac II	230 Vac III	CJBD-3333-6T-1,5	7800	55
KIT SOBREPRESION-12900-LED	230 Vac II	230 Vac III	CJHCH-56-4T-1	12900	60
KIT SOBREPRESION-17000-LED	230 Vac II	230 Vac III	CJHCH-63-4T-1,5	17000	61
KIT SOBREPRESION-7100-BOX	400 Vac III	400 Vac III	CJHCH-45-4T-0,5	7100	55
KIT SOBREPRESION-7800-BOX	400 Vac III	400 Vac III	CJBD-3333-6T-1,5	7800	55
KIT SOBREPRESION-12900-BOX	400 Vac III	400 Vac III	CJHCH-56-4T-1	12900	60
KIT SOBREPRESION-17000-BOX	400 Vac III	400 Vac III	CJHCH-63-4T-1,5	17000	61
KIT SOBREPRESION II-6240-BOX	400 Vac III	400 Vac III	TWIN-12/12-6T-1,5	6240	55
KIT SOBREPRESION II-9520-BOX	400 Vac III	400 Vac III	TWIN-15/15-6T-3	9520	54
KIT SOBREPRESION II-12900-BOX	400 Vac III	400 Vac III	CJHCH/DUPLEX-56-4T-1-H	12900	60
KIT SOBREPRESION II-17000-BOX	400 Vac III	400 Vac III	CJHCH/DUPLEX-63-4T-1,5-H	17000	61
SI-PRESIÓN TPDA					
SI-PRESIÓN TPDA c/DISPLAY					
BOXPRES KIT-3A 230Vac	230 Vac II	230 Vac II			
BOXPRES KIT-10A 230Vac	230 Vac II	230 Vac II			
BOXPRES KIT-0,75KW 230Vac	230 Vac II	230 Vac III			
BOXPRES KIT-1,5KW 230Vac	230 Vac II	230 Vac III			
BOXPRES KIT-0,75KW 400Vac	400 Vac III	400 Vac III			
BOXPRES KIT-1,5KW 400Vac	400 Vac III	400 Vac III			
BOXPRES KIT-2,2KW 400Vac	400 Vac III	400 Vac III			
BOXPRES KIT II - 1,5KW 400Vac	400 Vac III	400 Vac III			
BOXPRES KIT II - 2,2KW 400Vac	400 Vac III	400 Vac III			

## Dimensiones mm

### CJHCH

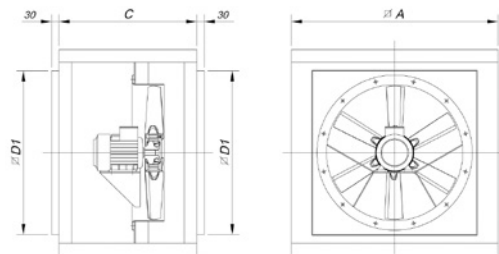

Modelo	∅A	C	∅D1
CJHCH-40/45/50	700	550	565
CJHCH-56/63	825	550	690

### CJBD

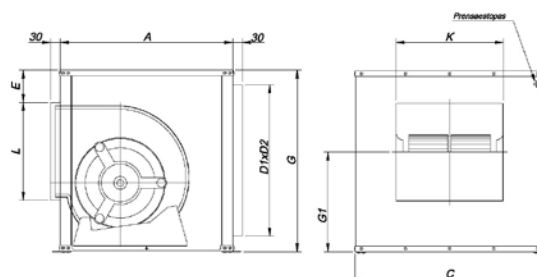

Modelo	Equiv. pulgadas	A	B	C	E	D1xD2	G1	L	K
CJBD-3333	12/12	650	650	700	92	556X606	379	358	400

## Dimensiones mm

### TWIN

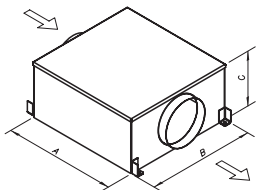

Modelo	A	B	C
TWIN-12/12	1103	1139	610
TWIN 15/15	1279	1639	698

### CJHCH/DUPLEX

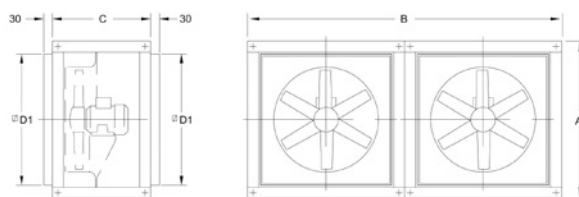

Modelo	∅A	B	C	∅D1
CJHCH/DUPLEX-56/63	825	1650	550	690

### NEOLINEO

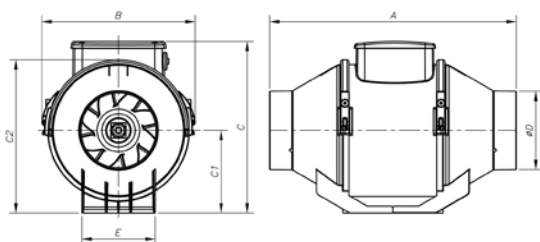

Modelo	A	B	C	C1	C2	∅D	E
NEOLINEO-200	300	234,5	260,5	125,5	235	196	140
NEOLINEO-315	448	361,5	392,5	188,5	359	312	220,5

### CJBC

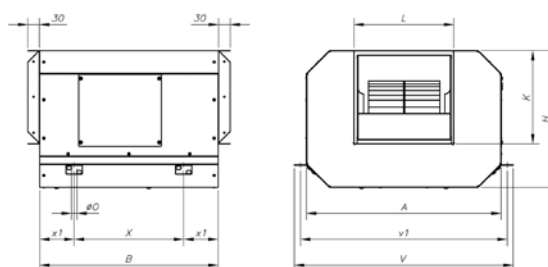

Modelo	A	B	H	K	L	∅O	V	v1	X	x1
CJBC-2828-6M-1/3	696	645	460	290	320	15	755	725	445	100

## BOXPRESS KIT SOBREPRESIÓN

### Características técnicas y dimensiones

Modelo	Potencia kW	Alimentación (V/Hz)	Salida (V/Hz)	Intensidad salida (A)	Tamaño	Medidas (largo x ancho x fondo)
BOXPRES KIT-3A 230Vac	-	230 Vac II	230 Vac II	3	-	255 x 170 x 140 mm
BOXPRES KIT-10A 230Vac	-	230 Vac II	230 Vac II	10	-	255 x 170 x 140 mm
BOXPRES KIT-0,75kW 230Vac	0,75	230 V II / 50Hz	230 V III / 50Hz	4,3	1	270 x 270 x 170 mm
BOXPRES KIT-1,5kW 230Vac	1,5	230 V II / 50Hz	230 V III / 50Hz	7	1	270 x 270 x 170 mm
BOXPRES KIT-0,75KW 400Vac	0,75	400 V III / 50Hz	400 V III / 50Hz	2,2	1	270 x 270 x 170 mm
BOXPRES KIT-1,5KW 400Vac	1,5	400 V III / 50Hz	400 V III / 50Hz	4,1	1	270 x 270 x 170 mm
BOXPRES KIT-2,2KW 400Vac	2,2	400 V III / 50Hz	400 V III / 50Hz	5,8	2	360 x 360 x 205 mm

### Prensaestopas de entrada cable a equipo

#### BOXPRES KIT-3A / KIT-10A



#### BOXPRES KIT tamaño 1 y 2

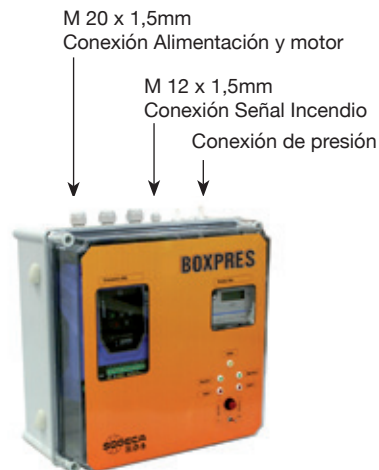

## BOXPRES KIT SOBREPRESIÓN II

Para equipos con ventilador de reserva.

### Características técnicas y dimensiones

Modelo	Potencia kW	Alimentación (V/Hz)	Salida (V/Hz)	Intensidad salida (A)	Tamaño	Medidas (largo x ancho x fondo)
BOXPRES KIT II - 1,5KW 400Vac	1,5	400 V III / 50Hz	400 V III / 50Hz	4,1	1	270 x 270 x 170 mm
BOXPRES KIT II - 2,2KW 400Vac	2,2	400 V III / 50Hz	400 V III / 50Hz	5,4	2	360 x 360 x 205 mm

\* Los dos motores nunca funcionan simultáneamente

### Prensaestopas de entrada cable a equipo

#### BOXPRES KIT tamaño 1 y 2

M 20 x 1,5mm  
Conexión Alimentación y motor

M 12 x 1,5mm  
Conexión Señal Incendio  
Conexión de presión

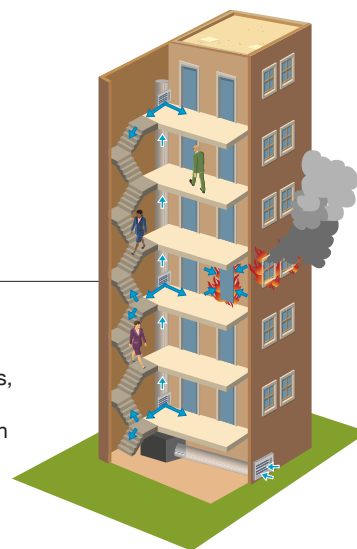

### Ejemplo de aplicación

Método de control de humo por Sobrepresión, este sistema consiste en la presurización mediante inyección de aire en habitáculos que son utilizados como vías de escape de personas en caso de incendio, tales como cajas de escalera, pasillos, corredores, elevadores, etc. Sobre todo en edificios de altura con gran ocupación. Este método está basado en el control del humo mediante la velocidad del aire y la barrera artificial que crea la sobre presión del aire sobre el humo, para que este no pueda entrar en las vías de escape.

# CENTRAL CO

Centrales de detección de monóxido, para el control de la ventilación en aparcamientos



Para cumplir el Real Decreto 2367/1985 y el Código Técnico de la Edificación.

Las centrales de detección de monóxido de carbono, han sido diseñadas para su aplicación en aparcamientos de vehículos subterráneos, túneles u otros lugares donde pueden acumularse concentraciones peligrosas de CO.

El sistema consiste en la instalación de una central de 1 a 3 módulos de zonas con display indicador y cada módulo permite la conexión de hasta 32 detectores conectados con 2 hilos, con una distancia máxima hasta el último detector de 2km.

Los detectores pueden ser distribuidos a lo largo de 2000 metros de longitud y cada detector cubre 200m<sup>2</sup> de superficie como máximo, tal y como define la actual normativa

A través de la tarjeta opcional FM-TC500 se puede controlar un regulador de velocidad serie VSD1/A-RFM o VSD3/A-RFT, con el fin de reducir el consumo energético y el nivel acústico de los extractores.

Estos sistemas tienen como resultado un importante ahorro energético.

- Sistema Certificado según norma UNE-EN 50545-1:2012
- Certificación LOM 09MOGA3054.
- Central modular y ampliable.
- Hasta 19000 m<sup>2</sup> de gestión.
- Versiones de 1, 2, y 3 módulos de zonas.
- Indicación de la concentración por zona.
- 2 salidas de relés de extracción por zona.
- 1 salida de relé de alarma por zona.
- Hasta 32 detectores por zona.
- Conexión de los detectores a 2 hilos.
- Modo de funcionamiento para bajo consumo.
- Opción de Control por Variador de Velocidad para reducir consumo energético y nivel acústico.
- Opción de Control remoto del sistema e integración con sistemas de análisis energético.

Modelo	Aplicación
FMC-C-501	Central para 1 zona
FMC-C-502	Central para 2 zona
FMC-C-503	Central para 3 zona
FM-M-509	Módulo ampliación de zona
FM-DP500	Detector de CO de pared
FM-D500	Detector de CO de techo
FM-TC500	Tarjeta control por variador



### CENTRALES: Serie FMC-C-501/502/503

- Para 1, 2 o 3 zonas según modelo
- Tensión de Alimentación: 90 ~264VAC
- Potencia: 45 W
- Módulo ampliación de zona FM-M-509

- Conexión de la zona: 2 hilos
- Distancia máxima de la línea de zona: 2 km. con cable 1,5 mm<sup>2</sup>
- Nº detectores por zona: 32 detectores



### Detector CO: Serie FM-DP500/FM-D500

- Detector CO de pared o techo según modelo
- Tecnología: Célula electroquímica
- Vida útil: 5 años
- Resolución: 1 ppm
- Tiempo de reacción: 10 segundos

- Temperatura almacenamiento: -10°C a + 80°C
- Área de trabajo: 200m<sup>2</sup> limitado por norma
- Índice IP de FM-D500: IP20
- Índice IP de FM-DP500: IP 54



### Tarjeta Control por variador. Serie FM-TC500

- Módulo con salidas PWM que permite atacar los motores de extracción mediante reguladores de velocidad (Ahorro energético).
- Módulo de comunicaciones para realizar acciones de tele mantenimiento y tele gestión.
- Protocolo abierto de comunicaciones para integración con otros sistemas.

# ACCESORIOS

## INT



Interruptores de seguridad paro-marcha, para cumplir la Norma UNE-EN 60204-1

198

## IAT



Interruptor de seguridad paro-marcha, para 200°C/2h, 400°C/2h

198

## CABLE BOX



Kit de cable eléctrico y caja de conexiones 400°C/2h

198

## C2V



Interruptor conmutador para motores de 2 velocidades

198

## RM



Reguladores electrónicos de velocidad

199

## AR



Arrancadores suaves para motores trifásicos

199

## VSD3/A-RFT VSD1/A-RFM



Convertidores de frecuencia para motores trifásicos 400v.

200

## CUADROS ELÉCTRICOS



Cuadros eléctricos

201

## PL P P-400



Persianas de sobrepresión certificadas 400°C/2h

202

## R/THT



Rejilla de protección para la aspiración de ventiladores helicoidales

203

## RT

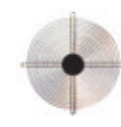

Rejilla de protección para la aspiración o impulsión de ventiladores helicoidales tubulares

203

## RPA



Rejilla de protección para la aspiración de ventiladores centrífugos

203

## BTUB



Brida de acoplamiento para ventiladores helicoidales

203

## B



Brida de acoplamiento para ventiladores centrífugos

204

## BD



Brida de acoplamiento doble y elástica para ventiladores centrífugos

204

## BAC



Brida de acoplamiento doble y elástica para ventiladores helicoidales

205

## BIC



Brida conversión de rectangular a circular, para ventiladores centrífugos

205

## PS



Conjunto de pies de soporte para ventiladores tubulares

205

## MS



Marco soporte para facilitar el montaje en obra

205

## PA



Placa de adaptación para montaje de accesorios en extractores de tejado

206

## BS BSS



Base soporte elevada y base soporte elevada con silenciador

206

## PT PT-400



Obturadores de cierre automático para trabajo vertical

206

## ACE-400



Acoplamiento elástico 400°C/2h, para amortiguar vibraciones

207

## REG



Registro de regulación manual

207

## VIS

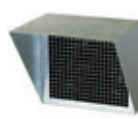

Viseras de impulsión con rejilla de protección

207

## TEJ



Tejadillos para intemperie

208

## CM

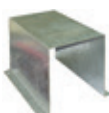

Cubre motores para trabajo en intemperie

208

## TAC



Tapa de acoplamiento circular

208

## S



Silenciadores para acoplar a la aspiración o impulsión

208

## CENTRAL CO



Centrales de detección de CO

196

## KIT SOBREPRESIÓN



192



## INT

Interruptores de seguridad paro-marcha para cumplir la Norma UNE-EN 60204-1

Características:

- Interruptores para instalar al lado del ventilador, y de esta forma poder cortar la corriente antes de manipular el ventilador
- Protección IP65
- Ventiladores trifásicos o de 2 velocidades, utilizar interruptor de 6 polos
- Ventiladores monofásicos, utilizar interruptor de 3 polos

Modelo	Intensidad (A)	Entrada cables (mm)	Modelo	Intensidad (A)	Entrada cables (mm)		
INT-CA 10/3CA	20	5,5	19	INT-CA 10/6CA	20	5,5	19
INT-KG 10/3CA	20	5,5	23	INT-KG 10/6CA	20	5,5	23
INT-KG 20/3CA	25	7,5	29	INT-KG 20/6CA	25	7,5	29
INT-KG 32/3CA	32	11	29	INT-KG 32/6CA	32	11	29
INT-KG 41/3CA	40	15	37,5	INT-KG 41/6CA	40	15	37,5
INT-KG 64/3CA	63	22	37,5	INT-KG 64/6CA	63	22	37,5
INT-KG 80/3CA	80	30	37,5	INT-KG 80/6CA	80	30	37,5
INT-KG 100/3CA	100	37	37,5	INT-KG 100/6CA	100	37	37,5



## IAT

Interruptores de seguridad paro-marcha para 400°C/2h, para cumplir la Norma UNE-EN 60204-1

Características:

- Interruptores 400°C/2h para instalar al lado del ventilador, y de esta forma poder cortar la corriente antes de manipular el ventilador
- Protección IP65 modelo 400°C/2h

Modelo	Intensidad (A)	Modelo	Intensidad (A)
IAT-400-20/3P	20	IAT-400-20/6P	20
IAT-400-32/3P	32	IAT-400-32/6P	32
IAT-400-63/3P	63	IAT-400-63/6P	63
IAT-400-125/3P	125	IAT-400-125/6P	125



## CABLE BOX

Kit con cable eléctrico y caja de conexiones 400°C/2h, para conexiones externas al motor, en instalaciones anti-incendios

Características:

- Cable eléctrico de 6 hilos + toma de tierra, con longitud de 1,5 m y terminales en cada extremo
- Caja de bornes en fundición de aluminio

- Regleta de conexiones en material cerámico
- Kit certificado conjuntamente con la serie de extractores CJBTD, con certificación N° 0370-CPR-0580

Modelo	Potencia máx. motor 3x400V (kW)
CABLE BOX-1-400	5,5
CABLE BOX-2-400	18,5



## C2V

Interruptor conmutador para motores de 2 velocidades

Características:

- Conmutador de 3 posiciones 1-0-2 para el accionamiento de motores de 2 velocidades conexión de Dahlander
- Protección IP67

Modelo	Intensidad (A)	(kW)	Entrada cables (mm)
C2V-CG10 A441	20	5,5	20

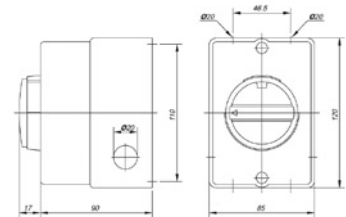



## RM Reguladores electrónicos de velocidad

### Características:

- Reguladores electrónicos de velocidad especialmente diseñados para ventiladores con motores monofásicos, según norma EN-60335
- Modelos RM-1, RM-2 y RM-3 Protección IP54. Modelos RM-00, RM-01 y RM-02 Protección IP44
- De acuerdo a las Directivas de Compatibilidad Electromagnética 92/31/CEE y 93/68/CEE y de acuerdo a la Directiva de Baja tensión 73/23/CEE
- Conmutador paro-marcha
- Ajuste de velocidad mínima
- Con filtros EMC, según norma EN-55014

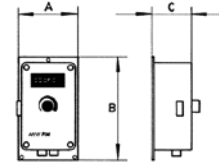

Modelo	Tensión entrada	Protección	Intensidad máxima (A)
RM-00	230 V-50/60 Hz	IP-44	0,5
RM-01	230 V-50/60 Hz	IP-44	1
RM-02	230 V-50/60 Hz	IP-44	2
RM-1	230 V-50/60 Hz	IP-54	3
RM-2	230 V-50/60 Hz	IP-54	5
RM-3	230 V-50/60 Hz	IP-54	10

Modelo	A	B	C
RM-00	81	81	66
RM-01	81	81	66
RM-02	81	81	66
RM-1	80	145	80
RM-2	96	164	85
RM-3	96	164	85



## AR Arrancadores suaves para motores trifásicos.

### Características:

- Especialmente diseñados para reducir el pico de intensidad producido durante el arranque de ventiladores con motores trifásicos
- Tensión de alimentación 400V + - 10% 50/60Hz
- Montado en caja para carril DIN-35
- Posibilidad de ajustar el par de arranque, tiempo de aceleración y tiempo de desaceleración

Modelo	AR-2	AR-4	AR-7,5	AR-10	AR-15	AR-20	AR-30
Tensión de alimentación	400 V ±10% 50/60 Hz						
Potencia motor en kW a 400 V	1,5	3	5,5	7,5	11	15	22
Mínima potencia motor	40% de la potencia nominal del motor			20% de la potencia nominal del motor			
Fusibles externos (rápidos) en (A)	16	25	35	25	35/40	50	63
Corriente nominal en (A)	3,5	6,5	12	17	25	32	45
Rango de ajuste del par de arranque	De 0 al 80%						
Rango de ajuste del tiempo de arranque	De 0,5 a 12 s			De 0,5 a 10 s			
Par de frenado	Nivel fijado al 70%						
Rango de ajuste del tiempo de desaceleración	De 0,5 a 12 s			De 0,5 a 10 s			
Tiempo de inicialización	200 ms						
Temperatura de trabajo	0°C....45°C						
Temperatura de almacenamiento	-25°C....75°C						
Grado de protección	IP20						
Condiciones de ambiente	Sobre-tensión categoría III, Grado de polución 2						
Reducción de potencia con la temperatura máx.	1% por cada 1°C de aumento de la temperatura máxima						
Altura máxima de montaje	Hasta 1000 m						
Reducción de potencia con la altura máxima.	0,5% por cada 100 m a partir de 1000 m.						
Humedad	93% máximo sin condensación						
Ciclos máximos por horas (3 x I nom, 10 seg)	90/h	60/h	30/h	60/h	40/h	30/h	20/h
Peso en kg.	0,4			1,0			
Dimensiones	Ancho (W) mm	45		45			52,5
	Alto (H) mm	73		173			178
	Profundo (D) mm	122		152			158
Montaje	Anclaje A x B		Sobre guía DIN				



# VSD3/A-RFT VSD1/A-RFM

Variadores electrónicos de velocidad para motores AC

Características:

- Convertidores para la variación de velocidad mediante tensión y frecuencia, de ventiladores helicoidales y centrífugos con motores trifásicos asíncronos
- Alimentación del convertidor:
  - . Monofásico (VSD1/A-RFM): 200-240V 50/60 Hz
  - . Trifásico (VSD3/A-RFT): 380-480V 50/60 Hz
- De acuerdo con la Directiva de Compatibilidad Electromagnética 2004/108/EC, la Directiva de Baja tensión 2006/95/EC y la Directiva de Seguridad de máquinas 2006/42/ EC.
- De acuerdo con las normas: -EN 61800-3:2004: Accionamientos eléctricos de potencia de velocidad variable. Norma de producto relativa a CEM incluyendo métodos de ensayos específicos. -EN 61800-5-1:2003: Accionamientos eléctricos de potencia de velocidad variable. Requisitos de seguridad. Eléctricos, térmicos y energéticos. -EN 60204-1:2006: Seguridad de las máquinas. Equipo eléctrico de las máquinas. Requisitos generales. -EN 55011:2007: Límites y métodos de medida de las características relativas a las perturbaciones radioeléctricas de los aparatos industriales, científicos y médicos (ICM) que producen energía en radiofrecuencia. -EN 60529:1992: Especificaciones para los grados de protección en los recintos.
- Entrada paro/marcha para deshabilitar/habilitar el variador.
- Entrada 0-10V para el control de velocidad.
- Conexión a bus ModBus RTU disponible.
- Modelo estándar con grado de protección IP20. Disponible también en versión IP66 hasta 10 CV.

1. En general, todos los ventiladores SODECA con motor trifásico en ejecución normal, son adecuados para trabajar alimentados con convertidor de frecuencia estático (según IEC 60034-17). No obstante algunos motores requieren medidas especiales. La máxima frecuencia o velocidad de funcionamiento, nunca deberá exceder la de diseño del ventilador. Las aplicaciones con par cuadrático tales como ventiladores y bombas, cuando varía la velocidad, la potencia absorbida es directamente proporcional al cubo de la velocidad de rotación:  $P_{a_2} = P_{a_1} (n_2 / n_1)^3$
2. El aislamiento de los motores acoplados a los ventiladores es suficiente para trabajar sin restricciones con convertidor de frecuencia hasta tensiones de < 500 V. La utilización de filtros senoidales a la salida del convertidor, contribuirán en el buen funcionamiento del motor, minimizando averías y aumentando la vida útil del mismo. Se recomienda que para motores de tamaño > 225, éstos sean solicitados con devanados especiales para funcionar con convertidor de frecuencia.
3. La longitud de los cables de salida del convertidor al ventilador, influyen especialmente en las características de la tensión en bornes del motor. La definición de "cables largos" dependerá del valor nominal y tipo de convertidor, siendo necesario consultar la documentación técnica del fabricante.
4. Para los motores Antideflagrantes EEx-d, estos deben solicitarse para ser accionados mediante convertidor de frecuencia. El fabricante del motor pedirá información de la aplicación mediante un cuestionario, para definir los parámetros de trabajo. Además dichos motores deberán llevar incorporadas sondas PTC.
5. Los motores de seguridad aumentada EEx-e, no pueden accionarse con convertidor de frecuencia (para ello sería necesario la certificación conjunta motor y convertidor).

## VSD1/A-RFM

Modelo		VSD1/A-RFM-0,5	VSD1/A-RFM-1	VSD1/A-RFM-2	VSD1/A-RFM-3
Potencia (CV)		0,50	1,00	2,00	3,00
Potencia (kW)		0,37	0,75	1,50	2,20
Intensidad máxima (A)		2,3	4,3	7,0	10,5
<b>Entrada</b>					
Tipo entrada		Monofásica	Monofásica	Monofásica	Monofásica
Voltage (V)		200-240 V	200-240 V	200-240 V	200-240 V
Frecuencia (Hz)		50-60 Hz	50-60 Hz	50-60 Hz	50-60 Hz
<b>Salida</b>					
Tipo Salida		Trifásica	Trifásica	Trifásica	Trifásica
Voltage (V)		200-240 V	200-240 V	200-240 V	200-240 V
Frecuencia (Hz)		0-500 Hz	0-500 Hz	0-500 Hz	0-500 Hz
Grados de protección		Estándar: IP20. Bajo pedido: IP66.			
Refrigeración		IP20: Forzada. IP66: Natural			

## VSD3/A-RFT

Modelo	VSD3/A-RFT-1	VSD3/A-RFT-2	VSD3/A-RFT-3	VSD3/A-RFT-5.5	VSD3/A-RFT-7.5	VSD3/A-RFT-10	VSD3/A-RFT-15	VSD3/A-RFT-20	VSD3/A-RFT-25	VSD3/A-RFT-30	
Potencia (CV)	1,00	2,00	3,00	5,50	7,50	10,00	15,00	20,00	25,00	30,00	
Potencia (kW)	0,75	1,50	2,20	4,00	5,50	7,50	11,00	15,00	18,50	22,00	
Intensidad máxima(A)	2,2	4,1	5,8	9,5	14,0	18,0	24,0	30,0	39,0	46,0	
<b>Entrada</b>											
Tipo entrada	Trifásica	Trifásica	Trifásica	Trifásica	Trifásica	Trifásica	Trifásica	Trifásica	Trifásica	Trifásica	
Voltage (V)	380-480 V	380-480 V	380-480 V	380-480 V	380-480 V	380-480 V	380-480 V	380-480 V	380-480 V	380-480 V	
Frecuencia (Hz)	50-60 Hz	50-60 Hz	50-60 Hz	50-60 Hz	50-60 Hz	50-60 Hz	50-60 Hz	50-60 Hz	50-60 Hz	50-60 Hz	
<b>Salida</b>											
Tipo Salida	Trifásica	Trifásica	Trifásica	Trifásica	Trifásica	Trifásica	Trifásica	Trifásica	Trifásica	Trifásica	
Voltage (V)	380-480 V	380-480 V	380-480 V	380-480 V	380-480 V	380-480 V	380-480 V	380-480 V	380-480 V	380-480 V	
Frecuencia (Hz)	0-500 Hz	0-500 Hz	0-500 Hz	0-500 Hz	0-500 Hz	0-500 Hz	0-500 Hz	0-500 Hz	0-500 Hz	0-500 Hz	
Grados de protección	Estándar: IP20. Bajo pedido: IP66							IP20	IP20	IP20	IP20
Refrigeración	IP20 e IP55: Forzada. IP66: Natural										





## KME - 10K

Kit mando externo de paro, marcha y control de velocidad para los convertidores de frecuencia VSD1/A-RFM y VSD3/A-RFT

Características:

- Paro y marcha mediante pulsación del mando
- Visualización mediante LED de la posición de paro o marcha
- Memoria de la última posición de regulación de velocidad
- Posibilidad de montaje en superficie o empotrado



## GMP

Cuadro eléctrico de arranque y protección de ventiladores con motor trifásico, con pulsadores de paro y marcha

Características:

- Paro y marcha mediante pulsador
- Incorpora contactor y relé térmico regulable totalmente cableados, para protección del motor
- El pulsador de paro, se utiliza como rearme del relé térmico, en caso de disparo por sobrecarga
- Para montaje en superficie, protección IP-55

Para ventilador con motor trifásico 230V

Modelo	Intensidad de regulación (A)	Potencia motor 3x230V (kW)
GMP-0,2-0,33/230	1,2-1,8	0,25
GMP-02-0,75/230	1,8-2,8	0,37 / 0,55
GMP-02-1/230	2,8-4	0,75
GMP-02-1,5/230	4-6,3	1,10
GMP-02-2/230	5,6-8	1,50
GMP-04-3/230	7-10	2,20
GMP-04-4/230	8-12,5	3,00
GMP-04-5,5/230	11-17	4,00
GMP-04-7,5/230	15-23	5,50
GMP-04-10/230	22-32	7,50
GMP-06-12,5/230	25-40	9,20
GMP-06-15/230	25-40	11,00

Para ventilador con motor trifásico 400V

Modelo	Intensidad de regulación (A)	Potencia motor 3x400V (kW)
GMP-0,2-0,33/400	0,56-0,8	0,25
GMP-02-0,5/400	0,8-1,2	0,37
GMP-02-0,75/400	1,2-1,8	0,55
GMP-02-1,5/400	1,8-2,8	1,10
GMP-02-2/400	2,8-4	1,50
GMP-02-3/400	4-3	2,20
GMP-02-4/400	5,6-8	3,00
GMP-04-5,5/400	7-10	4,00
GMP-04-7,5/400	8-12,5	5,50
GMP-04-10/400	11-17	7,50
GMP-06-12,5/400	15-23	9,20
GMP-06-15/400	15-23	11,00
GMP-06-20/400	22-32	15,00
GMP-06-25/400	25-40	18,50



## GMM

Cuadro eléctrico de arranque y protección de sobrecarga y cortocircuito de ventiladores trifásicos, con mando rotativo

Características:

- Paro y marcha mediante mando rotativo con posibilidad de bloqueo con tres candados
- Incorpora relé térmico regulable para protección de sobrecarga y cortocircuito
- Para montaje en superficie, protección IP-55

Para ventilador con motor trifásico 400

Modelo	Intensidad de regulación (A)	Potencia motor 3x400V (kW)
GMM-01-1/400	1,6-2,5	0,75
GMM-01-2/400	2,5-4	1,10 1,50
GMM-01-3/400	4-6,3	2,20
GMM-01-5,5/400	6,3-10	3,00 4,00
GMM-01-7,5/400	10-16	5,50
GMM-01-10/400	16-20	7,50
GMM-01-15/400	20-25	11,00
GMM-01-20/400	25-32	15,00



## AET

Cuadro eléctrico de arranque estrella / triángulo, y protección de ventiladores trifásicos, con pulsadores de paro y marcha

Características:

- Paro y marcha mediante pulsador
- Visualización de estado mediante pilotos luminosos
- Incorpora relé térmico regulable para protección del motor
- Totalmente cableado
- Caja metálica para montaje en superficie, protección IP-65

Para ventilador con motor trifásico 230V/400V. Alimentación 3x230V

Modelo	Intensidad regulación relé térmico (A)	Potencia motor 3x230/400V (kW)
AET-01-3/230	4-6,3	2,2
AET-01-4/230	5-8	3,0
AET-01-5,5/230	7-10	4,0
AET-01-7,5/230	12-18	5,5
AET-01-10/230	12-18	7,5
AET-01-15/230	18-26	11,0
AET-01-20/230	24-36	15,0
AET-01-25/230	28-40	18,5
AET-02-30/230	34-50	22,0
AET-02-40/230	45-65	30,0
AET-02-50/230	63-85	37,0

Para ventilador con motor trifásico 400V/690V. Alimentación 3x400V+N

Modelo	Intensidad regulación relé térmico (A)	Potencia motor 3x400/690V (kW)
AET-01-5,5/400	4-6,3	4
AET-01-7,5/400	5-8	5,5
AET-01-10/400	7-10	7,5
AET-01-15/400	12-18	11
AET-01-20/400	12-18	15
AET-02-30/400	18-26	18,5/22,0
AET-02-40/400	28-40	30
AET-02-50/400	34-50	37
AET-02-60/400	45-65	45
AET-02-75/400	45-65	55



## AD Cuadro eléctrico de arranque y protección de ventiladores con motor trifásico de 2 velocidades DAHLANDER

Características:

- Conmutador para la selección de la velocidad (1-0-2), velocidad lenta-paro-velocidad rápida.
- Visualización de estado mediante pilotos luminosos
- Incorpora relé térmico regulable para protección del motor
- Totalmente cableado
- Caja metálica para montaje en superficie, protección IP-65

Para ventilador con motor trifásico 400V Dahlander.  
Alimentación 3x400V+N

Modelo	Intensidad regulación relé térmico	
	Velocidad rápida (A)	Velocidad lenta (A)
AD-01-2,5-1/400	1,6-2,5	0,63-1
AD-01-4-1,6/400	2,5-4	1-1,6
AD-01-4-2,5/400	2,5-4	1,6-2,5
AD-01-6-2,5/400	4-6	1,6-2,5
AD-01-9-2,5/400	6-9	1,6-2,5
AD-01-9-4/400	6-9	2,5-4
AD-02-13-4/400	9-13	2,5-4
AD-02-18-6/400	12-18	4-6
AD-02-18-9/400	12-18	6-9
AD-02-26-9/400	18-26	6-9
AD-02-36-9/400	24-36	6-9
AD-02-36-13/400	24-36	9-13
AD-02-40-18/400	28-40	12-18



## PL Persianas de sobrepresión en material plástico

Características:

- La persiana de sobrepresión se adapta directamente sobre la pared en que se instala el ventilador
- Apertura mediante sobrepresión por el flujo de aire
- Se cierran cuando el ventilador está en reposo
- Construcción en material plástico
- Velocidad máxima recomendable de 12m/seg. para los modelos 80,90 y 100

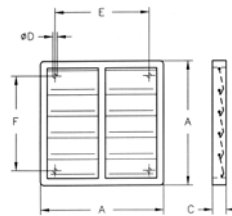

Modelo	Dimensiones				
	A	C	ØD	E	F
PL-20	240	28	5,2	193	167
PL-25	294	26	5	232	232
PL-31	347	26	5	276	276
PL-35	397	26	5	310	310
PL-40	459	26	5	364	364
PL-45	501	26	5	395	395
PL-50	549	31	5	445	445
PL-56	605	28	5	522	522
PL-63	696	31	5	626	626
PL-71	760	40	5	692	692
PL-80	840	40	5	772	772
PL-90	940	40	5	872	87
PL-100	1040	40	5	972	972



## P Persianas de sobrepresión en aluminio

Características:

- La persiana de sobrepresión se adapta directamente sobre la pared en que se instala el ventilador
- Apertura mediante sobrepresión por el flujo de aire
- Se cierran cuando el ventilador está en reposo
- Construcción en chapa de aluminio
- Velocidad máxima recomendable de 18m/seg. para los modelos 90 y 100

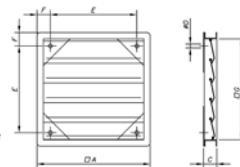

Modelo	Dimensiones					
	G	A	C	ØD	E	F
P 25	240	290	51	6	180	55
P 35	350	400	51	6	290	55
P 45	450	500	51	6	390	55
P 56	550	600	51	6	440	80
P 63	645	715	72	6	555	80
P 71	710	780	72	6	620	80
P 80	805	875	72	6	695	90
P 90	900	970	72	6	790	90
P 100	1000	1070	72	6	890	90



## P-400 Persianas de sobrepresión, certificadas 400°C/2h.

Características:

- Se suministran montadas en la caja con su correspondiente adaptador
- Homologación según norma EN 12101-3:2002/AC:2006, con certificación N°: 0370-CPR-0312
- Construcción marco en chapa de acero y lamas en chapa de aluminio
- Puede ser utilizada para otras aplicaciones 400°C/2h

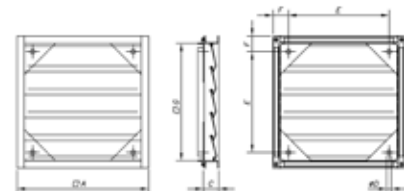

MOD.	G	A	C	ØD	E	F
P-400-56	565	615	51	6	455	80
P-400-63	690	760	72	6	600	80
P-400-80	850	920	72	6	740	90
P-400-100	1050	1120	72	6	940	90



## R/THT **Rejilla de protección para la aspiración de ventiladores helicoidales**

Características:

- Previene contra contactos con la hélice y posibles entradas de objetos, según norma UNE-EN ISO 12499
- Construida con varilla electrosoldada

Modelo	Aplicable a los modelos
R-THT-40	THT-40
R-THT-45	THT-45
R-THT-50	THT-50
R-THT-56	THT-56 (Motores tam.80/90)
R-THT-56-1	THT-56 (Motores tam.100/112)
R-THT-63	THT-63 (Motores tam.80/90)
R-THT-63-1	THT-63 (Motores tam.100/112)
R-THT-63-2	THT-63 (Motor tam.132)
R-THT-63-3	THT-63 (Motor tam.160)
R-THT-71	THT-71 (Motores tam.80/90)
R-THT-71-1	THT-71 (Motores tam.100/112)
R-THT-80	THT-80 (Motores tam.90/100)
R-THT-80-1	THT-80 (Motores tam.112)
R-THT-80-2	THT-80 (Motor tam.132)
R-THT-90	THT-90 (Motor tam.90)
R-THT-90-1	THT-90 (Motores tam.100/112)
R-THT-90-2	THT-90 (Motor tam.132)

Modelo	Aplicable a los modelos
R-THT-90-3	THT-90 (Motor tam.160)
R-THT-100	THT-100 (Motor tam.112)
R-THT-100-1	THT-100 (Motor tam.132)
R-THT-100-2	THT-100 (Motor tam.160)
R-THT-125	THT-125 (Motor tam.132)
R-THT-125-1	THT-125 (Motor tam.160)
R-THT-125-2	THT-125 (Motor tam.180)
R-THT-125-3	THT-125 (Motor tam.200)
R-THT-125-4	THT-125 (Motores tam.225/250)
R-THT-140	THT-140 (Motores tam.132/180)
R-THT-140-1	THT-140 (Motores tam.160/200)
R-THT-140-2	THT-140 (Motores tam.225/250)
R-THT-160	THT-160 (Motores tam.132/180)
R-THT-160-1	THT-160 (Motores tam.160/200)
R-THT-160-2	THT-160 (Motores tam.225/250)
R-THT-160-3	THT-160 (Motor tam.280)



## RT **Rejilla de protección para la aspiración o impulsión de ventiladores helicoidales tubulares**

Características:

- Previene contra contactos con la hélice y posibles entradas de objetos, según norma UNE-EN ISO 12499
- Construida con varilla electrosoldada

Aplicable a los modelos		Aplicable a los modelos	
Modelo	THT	Modelo	THT
RT-25	-	RT-63	63
RT-31/B	-	RT-71	71
RT-31	-	RT-80	80
RT-35	-	RT-90	90
RT-40	40	RT-100	100
RT-45	45	RT-125	125
RT-50	50	RT-125/CC	125
RT-56	56		

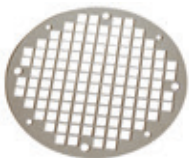

## RPA **Rejilla de protección para la aspiración de ventiladores centrífugos**

Características:

- Previene contra contactos con la turbina y posibles entradas de objetos, según norma UNE-EN ISO 12499
- Construida en chapa de acero

Aplicable a los modelos			Aplicable a los modelos		
Modelo	CTMP TCMP	TCR TCR/R	Modelo	CTMP TCMP	TCR TCR/R
RPA-25	820	-	RPA-47	1640	1240
RPA-28	922	-	RPA-52	1845	1445
RPA-31	1025	-	RPA-60	2050	1650
RPA-35	1128	-	RPA-66	-	1856
RPA-38	1231	-	RPA-73	-	2063
RPA-42	1435	-	RPA-81	-	2271



## BTUB

**Brida de acoplamiento para ventiladores helicoidales**

Características:

- Se adapta a la boca de aspiración y de impulsión
- Facilita la instalación al conducto

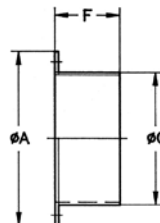

	C	A	F		C	A	F
BTUB-250	250	310	80	BTUB-630	630	720	80
BTUB-280	280	350	80	BTUB-710	710	800	80
BTUB-315	315	380	80	BTUB-800	800	890	100
BTUB-355	355	430	80	BTUB-900	900	1000	100
BTUB-400	400	480	80	BTUB-1000	1000	1100	100
BTUB-450	450	530	80	BTUB-1250	1250	1365	100
BTUB-500	500	590	80	BTUB-1400	1400	1520	100
BTUB-560	560	650	80	BTUB-1600	1600	1720	100



## B Brida de acoplamiento para ventiladores centrífugos

Características:

- Se adapta a la boca de aspiración y de impulsión
- Facilita la instalación al conducto

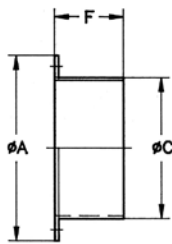

	A	C	F		A	C	F		A	C	F		A	C	F
B-52-E	100	52	67	B-224	280	224	60	B-355/2	430	355	80	B-500/5	590	500	80
B-63	110	63	60	B-250/1	310	250	80	B-355/3	430	355	80	B-560/1	650	560	80
B-80	150	80	60	B-250/2	310	250	80	B-355/4	430	355	80	B-560/2	650	560	80
B-80-E	150	80	60	B-250/3	310	250	80	B-400/1	480	400	80	B-560/3	650	560	80
B-100	150	100	60	B-250/4	310	250	80	B-400/2	480	400	80	B-630/1	720	630	80
B-100-E	170	100	60	B-250/5	310	250	80	B-400/3	480	400	80	B-630/2	720	630	80
B-112	160	112	60	B-280/1	350	280	80	B-400/4	480	400	80	B-630/3	720	630	80
B-125	180	125	60	B-280/2	350	280	80	B-450/1	530	450	80	B-630/4	720	630	80
B-140	190	140	60	B-280/3	350	280	80	B-450/2	530	450	80	B-710/1	800	710	80
B-150	210	150	60	B-315/1	350	315	80	B-450/3	530	450	80	B-710/2	800	710	80
B-160	220	160	60	B-315/2	380	315	80	B-500/1	590	500	80	B-710/3	800	710	80
B-160/1	220	160	60	B-315/3	380	315	80	B-500/2	590	500	80	B-800	890	800	100
B-180	240	180	60	B-315/4	380	315	80	B-500/3	590	500	80	B-900/1	1000	900	100
B-200	260	200	60	B-355/1	430	355	80	B-500/4	590	500	80	B-1000/1	1100	1000	100

Aplicable a los modelos

	CVT CHT	CTMP TCMP	TCR TCR/R
B-112	-	512	-
B-140	-	514	-
B-160	-	616	-
B-180	-	718	-
B-200	-	620/820	-
B-224	-	922	-
B-250/3	200/225	1025	-

Aplicable a los modelos

	CVT CHT	CTMP TCMP	TCR TCR/R
B-280/2	-	1128	-
B-315/3	-	-	1031
B-315/4	-	1231	-
B-355/1	-	-	1135
B-355/3	250/315	1435	-
B-400/1	-	1640	-
B-400/2	-	-	1240

Aplicable a los modelos

	CVT CHT	CTMP TCMP	TCR TCR/R
B-450/1	-	1845	-
B-450/2	-	-	1445
B-500/1	-	2050	-
B-500/2	-	-	1650
B-500/4	400/450	-	-
B-560/2	-	-	1856
B-630/2	-	-	2063

Aplicable a los modelos

	CVT CHT	CTMP TCMP	TCR TCR/R
B-630/3	500	2563	-
B-710/1	-	-	2271
B-710/2	560/630	-	-
B-800	-	-	2380
B-900/1	-	-	2590
B-1000/1	-	-	28100



## BD Brida de acoplamiento doble para ventiladores centrífugos

Características:

- Se adapta a la boca de aspiración
- Facilita la instalación al conducto con brida

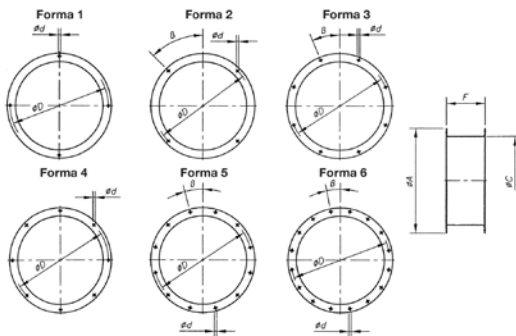

	ØA	ØC	ØD	Ød	F	β	Forma	CTMP TCMP	TCR TCR/R
BD-200	260	200	225	7	80	15°	2	820	
BD-224	280	224	254	7	80	-	1	922	
BD-250/1	310	250	280	10	80	45°	2	1025	
BD-280	350	280	320	10	100	-	4	1128	
BD-315/3	390	315	355	10	100	22°30'	3	1231	
BD-355/3	430	355	395	10	100	22°30'	3	1435	
BD-400/1	480	400	450	12	100	22°30'	3	1640	
BD-400/2	480	400	450	12	100	22°30'	3		1240
BD-450/1	530	450	500	12	100	22°30'	3	2050	
BD-450/2	530	450	500	12	100	22°30'	3		1445
BD-500/2	590	500	560	12	100	15°	5		1650
BD-560	650	560	620	12	120	15°	5		1856
BD-630/2	720	630	690	12	120	15°	5		2063
BD-710	800	710	770	12	120	11°15'	6		2271

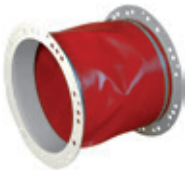

## BAC

### Brida de acoplamiento doble y elástica para ventiladores helicoidales

#### Características:

- Se adapta a la boca de aspiración e impulsión
- Facilita la instalación al conducto con brida
- Evita la transmisión de vibraciones

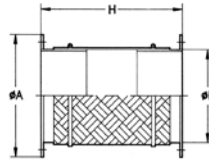

	ØD*	ØA*	H	CVT/CHT	THT
BAC-250	250	310	340	200/225	-
BAC-355	355	430	340	250/315	-
BAC-400	400	480	340	-	40
BAC-450	450	530	340	-	45
BAC-500	500	590	340	400/450	50
BAC-560	560	650	340	-	56
BAC-630	630	720	340	500	63
BAC-710	710	800	340	560/630	71
BAC-800	800	890	340	-	80
BAC-900	900	1000	340	-	90
BAC-1000	1000	1100	340	-	100
BAC-1250	1250	1365	340	-	125

\*Diámetro nominal tubería

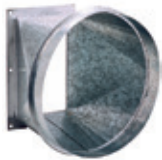

## BIC

### Brida conversión de rectangular a circular para ventiladores centrífugos

#### Características:

- Se adapta a la boca de impulsión
- Facilita la instalación al conducto circular

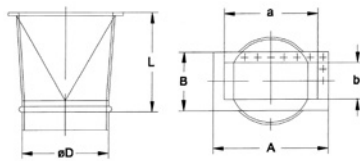

	L	D	a	b	A	B	Aplicable a los modelos
BIC-820	300	200	160	130	213	184	TCMP-820
BIC-922	300	224	216	140	282	204	CTMP/TCMP-922
BIC-1025	300	250	250	165	314	229	CTMP/TCMP-1025
BIC-1128	300	280	300	180	364	244	CTMP/TCMP-1128
BIC-1231	300	315	320	200	384	266	CTMP/TCMP-1231
BIC-1435	300	355	280	228	344	294	CTMP/TCMP-1435
BIC-1640	300	400	320	250	404	336	CTMP/TCMP-1640
BIC-1845	450	450	360	284	444	370	CTMP/TCMP-1845
BIC-2050	450	500	450	315	545	412	CTMP/TCMP-2050
BIC-2563	450	630	600	410	706	512	TCMP-2563



## PS

### Conjunto de pies soporte, para ventiladores tubulares.

- Al fijarse a la brida facilita la fijación sobre superficies planas

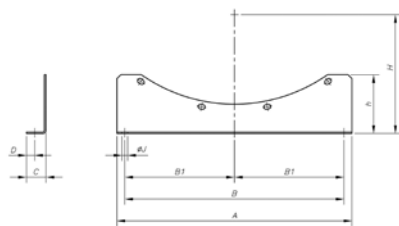

Modelo	A	B	B1	C	D	h	H	ØJ	HEPT	HCT	HGT	HPX	THT
PS-25/31	275	225	-	25	10,5	90	165	10	-	25	-	-	-
	275	225	-	25	10,5	90	191,5	10	-	31	-	-	-
	275	225	-	25	10,5	90	205	10	31	-	-	-	-
PS-35/40	240	200	-	30	13	60	230	10	35	35	-	35	-
	240	200	-	30	13	60	255,5	10	40	40	-	-	40
PS-45/50	450	400	200	35	14,5	125	278	12	45	45	-	45	45
	450	400	200	35	14,5	125	305	12	50	50	-	50	50
PS-56/63	520	430	215	40	17	155	338	13	56	56	-	56	56
	520	430	215	40	17	155	385,5	13	63	63	-	63	63
PS-71	490	450	225	50	21	150	445	13	-	71	-	71	71
PS-80	600	560	280	50	21	150	490	13	-	80	-	80	80
PS-90	620	560	280	60	28	175	547,5	18	-	90	-	90	90
PS-100	680	560	280	60	28	185	597,5	18	-	100	-	100	100
PS-125	1000	900	300	60	28	285	726,5	18	-	-	125	-	125



## MS

### Marco soporte para facilitar el montaje en obra

#### Características:

- Utilizado para facilitar el montaje del ventilador en conductos de obra

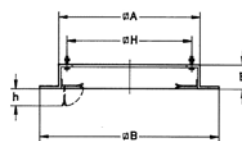

	ØA	ØB	E	ØH	h	Aplicable a los modelos
MS-443	443	615	60	360	70	200/225
MS-553	553	725	60	450	70	250/315
MS-701	701	875	60	590	90	400/450
MS-891	891	1065	60	750	90	500
MS-1086	1086	1260	60	850	90	560/630



# PA

Placa de adaptación para montaje de accesorios, en extractores de tejado

Características:

- Se utiliza para el montaje de los accesorios PT, B, BTUB, BAC. Permite separar el ventilador de su base sin desmontar el conjunto de accesorios

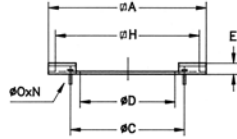

Aplicable a los modelos

	ØA	ØC	ØD	E	ØH	ØO	N	CVT/CHT
PA-440/250	440	280	249	20	360	M.6	4X90°	220/225
PA-550	550	395	354	20	450	M.6	8X45°	250/315
PA-700/500	700	560	499	20	590	M.10	12X30°	400/450
PA-890/630	890	690	629	20	750	M.10	12X30°	500
PA-1085	1085	770	709	20	850	M.10	16X22°30'	560/630



# BS BSS

Base soporte elevada y base soporte elevada con silenciador

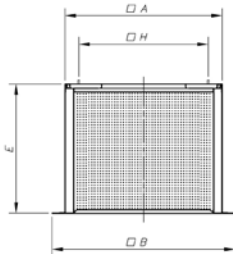

Modelo	A	B	H	E	CHT/CHV	HT	CHRE
BS BSS - 348	348	520	295	800	-	-	722
BS BSS - 393	393	565	320	800	-	-	825
BS BSS - 443	449	616	360	800	200/225	25	1131
BS BSS - 493	493	665	410	800	-	31	-
BS BSS - 553	554	724	450	800	250/315	35	1135/1240
BS BSS - 623	623	795	530	800	-	40	-
BS BSS - 701	706	876	590	900	400/450	45	1445-1650
BS BSS - 791	791	965	680	900	-	50	-
BS BSS - 891	896	1076	750	900	500	56	-
BS BSS - 991	991	1165	850	900	-	63/71	-
BS BSS - 1086	1092	1272	900	900	560/630	-	-
BS BSS - 1140	1140	1314	1000	900	-	80/90	-
BS BSS - 1240	1240	1414	1100	900	-	100	-



# PT PT-...-400

Obturadores de cierre automático para trabajo vertical y horizontal versión 400 certificada 400°C/2h

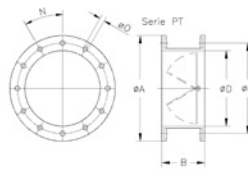

# PT/H PT.../H-400

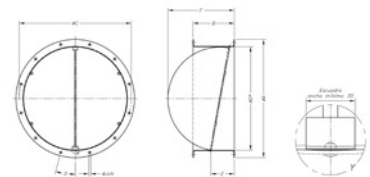

	ØA	B	ØC	ØD*	ØO	N	CHT/CHV	CHRE
PT-160	220	150	200	160	10	4x90°	-	722
PT-180	240	150	210	180	10	4x90°	-	825
PT-250	310	150	280	250	10	4x90°	200/225	1131
PT-355	435	200	395	355	10	8x45°	250/315	1135/1240
PT-500	600	280	560	500	12	12x30°	400/450	1445/1650
PT-630	730	355	690	630	12	12x30°	500	-
PT-710	810	400	770	710	12	16x22°30'	560/630	-

	ØA	B	ØC	ØD*	E	F	ØJ	N
PT-450/H	540	254	500	460	185	340	22° 30'	12
PT-500/H	600	254	560	514	185	346	15°	12
PT-560/H	660	254	620	560	185	363	15°	12
PT-630/H	730	254	690	640	185	409	15°	12
PT-710/H	810	254	770	710	185	443	11°15'	12
PT-800/H	900	254	860	800	185	488	11°15'	12
PT-900/H	1015	254	970	900	185	555	11°15'	15
PT-1000/H	1115	254	1070	1000	185	609	11°15'	15
PT-1250/H	1365	254	1320	1250	185	736,5	9°	15



## ACE/400

Acoplamiento elástico 400°C/2h para amortiguar vibraciones

Características:

- Se utiliza entre la boca del ventilador 400°C/2h y el conducto para evitar la transmisión de vibraciones

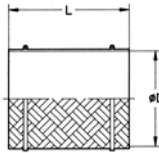

	Aplicable a los modelos					Aplicable a los modelos					
	ØD*	L	THT	TCMP	TCR/R	ØD*	L	THT	TCMP	TCR/R	
ACE/400-200	200	200	-	820	-	ACE/400-500	500	300	50	2050	1650
ACE/400-224	224	200	-	922	-	ACE/400-560	560	300	56	-	1856
ACE/400-250	250	300	-	1025	-	ACE/400-630	630	300	63	-	2063
ACE/400-280	280	300	-	1128	-	ACE/400-710	710	300	71	-	2271
ACE/400-315	315	300	-	1231	-	ACE/400-800	800	300	80	-	-
ACE/400-355	355	300	-	1435	-	ACE/400-900	900	300	90	-	-
ACE/400-400	400	300	40	1640	1240	ACE/400-1000	1000	300	100	-	-
ACE/400-450	450	300	45	1845	1445	ACE/400-1250	1250	300	125	-	-



## REG

Registro de regulación manual

Características:

- Su construcción permite incorporarlos en los sistemas de conductos, para la regulación del caudal

Modelo	L	ØD*	Modelo	L	ØD*
REG-80	100	80	REG-250	100	250
REG-100	100	100	REG-280	100	280
REG-112	100	112	REG-315	100	315
REG-125	100	125	REG-355	100	355
REG-140	100	140	REG-400	100	400
REG-150	100	150	REG-450	150	450
REG-160	100	160	REG-500	150	500
REG-180	100	180	REG-560	150	560
REG-200	100	200	REG-630	250	630
REG-224	100	224	REG-800	250	800

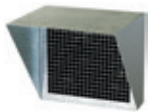

## VIS

Viseras de impulsión con rejilla de protección.

Características:

- Evita la entrada de objetos y agua al interior del ventilador

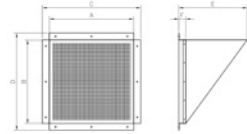

	A	B	C	D	E	F	CJTX-C
VIS-7/7	269	246	309	286	200	50	7/7
VIS-9/9	335	300	375	340	200	50	9/9
VIS-10/10	364	326	404	366	250	50	10/10
VIS-12/12	425	380	465	420	250	50	12/12
VIS-15/15	513	441	573	501	300	50	15/15
VIS-18/18	582	510	642	570	350	50	18/18
VIS-20/20	641	641	741	741	400	50	20/20
VIS-22/22	695	735	795	835	450	50	22/22
VIS-25/25	805	836	905	936	500	50	25/25
VIS-30/28	930	972	1030	1072	600	50	30/28

	A	B	C	D	E	F	CJBDT
VIS-CJBDT-9/9	310	270	-	-	200	80	9/9
VIS-CJBDT-10/10	336	298	-	-	200	80	10/10
VIS-CJBDT-12/12	397	351	-	-	300	80	12/12
VIS-CJBDT-15/15	480	414	-	-	300	80	15/15
VIS-CJBDT-18/18	552	493	-	-	300	80	18/18
VIS-CJBDT-20/20	612	615	-	-	500	80	20/20
VIS-CJBDT-22/22	666	706	-	-	500	80	22/22

	A	B	C	D	E	F	CJMP	CJTCR/R
VIS-820	132	157	-	-	170	56,5	820	-
VIS-922	142	216	-	-	215	56,5	922	-
VIS-1025	167	251	-	-	240	56,5	1025	-
VIS-1128	182	296	-	-	270	56,5	1128	-
VIS-1231	202	321	-	-	290	56,5	1231	-

VIS-1240	317	401	-	-	350	56,5	-	1240
VIS-1435	232	281	-	-	260	56,5	1435	-
VIS-1445	357	451	-	-	385	56,5	-	1445
VIS-1640	252	321	-	-	290	56,5	1640	-
VIS-650	402	501	-	-	420	56,5	-	1650
VIS-1845	286	361	-	-	320	56,5	1845	-
VIS-1856	452	561	-	-	-	-	-	1856
VIS-2050	317	451	-	-	385	56,5	2050	-
VIS-2063	502	631	-	-	515	56,5	-	2063
VIS-2271	562	716	-	-	575	56,5	-	2271

	A	B	C	D	E	F	CJLINE	CJS
VIS-1131	560	450	-	-	250	100	1131	-
VIS-1235	620	500	-	-	250	100	1235	-
VIS-1640/E	710	560	-	-	250	100	1640	-
VIS-1845/E	800	630	-	-	250	100	1845/1650/H	-
VIS-1856/E	1000	800	-	-	250	100	1856-1856/H	-
VIS-2063/E	1120	900	-	-	250	100	2063-2063/H	-
VIS-2271/E	1190	900	-	-	250	100	2271-2271/H	-
VIS-2880	1250	1000	-	-	250	100	2880	-
VIS-100	600	600	698	698	485	-	-	1240/1850
VIS-200	725	725	823	823	576	-	-	2056/2263-6T
VIS-300	800	800	898	898	630	-	-	2263-4T/2071-6T-3
VIS-400	860	860	958	958	674	-	-	-2071-4T/6T-5,5/2880



## TEJ Tejadillos para intemperie

- Características:
- Evita la entrada de agua, en unidades de ventilación instaladas en el exterior

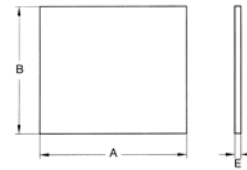

Aplicable a los modelos

	A	B	E	CJMP	CJTCCR/R	CJS
TEJ-820	500	550	26	820	-	-
TEJ-922	710	710	26	922	-	-
TEJ-1025	760	760	26	1025	-	-
TEJ-1128	820	820	26	1128	-	-
TEJ-1231	900	900	26	1231	-	1240/1850
TEJ-1435	980	980	26	1435	-	-

Aplicable a los modelos

	A	B	E	CJMP	CJTCCR/R	CJS
TEJ-1640	1071	1070	26	1640	1240	2056/2263-6T
TEJ-1845	1170	1170	26	1845	1445	2263-4T/2071/2280
TEJ-1856	1360	1150	26	-	1856	-
TEJ-2050	1260	1260	26	2050	1650	-
TEJ-2063	1500	1300	26	-	2063	-
TEJ-2271	1655	1455	26	-	2271	-

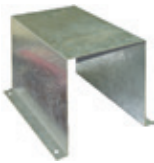

## CM Cubre motores para trabajos en intemperie

- Características:
- Evita la entrada de agua, en motores instalados en el exterior

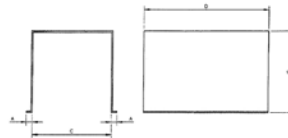

Aplicable a motores de

Modelo	A	B	C	D	CV
CM-1	15	260	200	300	0,25 a 1
CM-2	15	260	240	300	1,5 a 2
CM-5,5	15	300	270	330	3 a 5,5
CM-10	15	380	320	450	7,5 a 10
CM-20	15	440	350	530	15 a 20
CM-30	15	440	360	550	más de 20



## TAC Tapa de acoplamiento circular

- Características:
- Para convertir la impulsión rectangular de la unidad CJS y CJLINE a circular

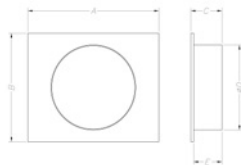

Aplicable a los modelos

	A	B	C	ØD	E	CJS	CJLINE
TAC-100	698	698	80	400	50	1240/1850	-
TAC-200	823	823	80	560	50	2056/2263-6T	-
TAC-300	898	898	80	630	50	2263-4T/2071-6T-3	-
TAC-400	958	958	80	710	50	2071-4T/6T-5,5/2880	-
TAC-1131	615	505	165	400	150	-	1131
TAC-1235	695	575	165	450	150	-	1235
TAC-1640	785	635	165	500	150	-	1640
TAC-1845	875	705	165	560	150	-	1845
TAC-1856	1075	875	165	700	150	-	1856
TAC-2063	1195	975	165	800	150	-	2063
TAC-2271	1265	975	165	800	150	-	2271
TAC-2880	1325	1075	165	900	150	-	2880



## S Silenciadores para acoplar a la aspiración o impulsión.

- Características:
- Silenciadores circulares o rectangulares para acoplar a la aspiración o impulsión, de ventiladores centrífugos o helicoidales

ASPIRACIÓN / IMPULSIÓN (Sección rectangular)

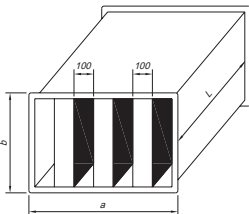

	L	a	b	Kg	Amortiguación de sustitución (dB) en banda de octavos (Hz)						
					125	250	500	1000	2000	4000	Aplicable
SR-1000/900/900	900	1000	900	64	4	10	21	37	44	37	THT-63
SR-1200/900/900	900	1200	900	74	4	10	21	37	44	37	THT-71
SR-1400/1200/900	900	1400	1200	102	4	12	25	41	47	42	THT-80
SR-1800/1200/1200	1200	1800	1200	169	4	12	25	41	47	42	THT-90
SR-1800/1500/1200	1200	1800	1504	195	4	12	25	41	47	42	THT-100

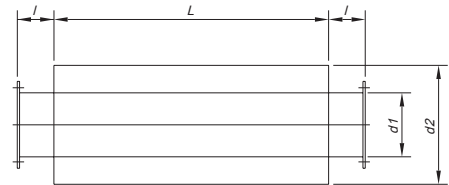
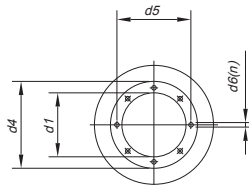

ASPIRACIÓN / IMPULSIÓN (Sección circular)

	L	d1	d2	l	d3	d4	d5	d6	n	Kg	Amortiguación de sustitución (dB) en banda de octavos (Hz)						
											125	250	500	1000	2000	4000	Aplicable
SC-630/900	900	630	800	100	630	720	690	12	12x30°	44	5	8	14	12	13	9	THT-63
SC-710/900	900	710	900	100	710	800	770	12	16x22°30'	65	5	8	13	11	12	8	THT-71
SC-800/900	900	800	1000	100	800	900	860	12	16x22°30'	70	4	8	11	9	9	8	THT-80
SC-900/1200	1200	900	1120	100	900	1000	970	15	16x22°30'	87	5	7	11	11	7	5	THT-90
SC-1000/1200	1200	1000	1200	100	1000	1100	1070	15	16x22°30'	95	4	7	11	10	7	6	THT-100



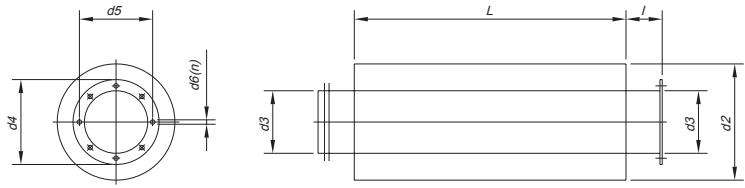

## ASPIRACIÓN

	L	d2	d3	d4	d5	d6	n	Kg	Amortiguación de sustitución (dB) en banda de octavos (Hz)						
									125	250	500	1000	2000	4000	Aplicable
S-250/600	600	450	250	310	280	10	4x90°	14	5	12	20	24	23	14	CVT-CHT-200/225
S-355/900	900	560	355	430	395	10	8x45°	25	4	12	20	24	18	14	CVT-CHT-250/315
S-500/900	900	710	500	590	560	12	12x30°	35	4	11	18	16	14	11	CVT-CHT-400/450
S-630/900	900	800	630	720	690	12	12x30°	41	5	8	14	12	13	9	CVT-CHT-500
S-710/900	900	900	710	800	770	12	16x22°30'	65	5	8	13	11	12	8	CVT-CHT-560/630

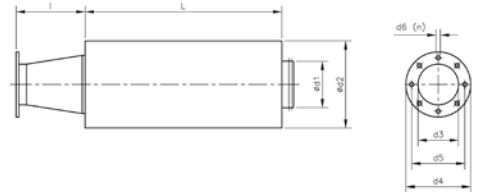

## ASPIRACIÓN

	L	d1	d2	l	d3	d4	d5	d6	n	Kg	Amortiguación de sustitución (dB) en banda de octavos (Hz)						
											125	250	500	1000	2000	4000	Aplicable
S-315/600/922-A	600	315	500	238	220	278	256	9	8x45°	16	4	8	14	17	14	12	TCMP/CTMP-922
S-355/900/1025-A	900	355	560	224	245	305	282	9	8x45°	25	4	12	20	24	23	14	TCMP/CTMP-1025
S-400/900/1128-A	900	400	600	250	270	348	320	9	8x45°	29	5	12	19	22	18	13	TCMP/CTMP-1128
S-450/900/1231-A	900	450	630	291	295	382	354	9	8x45°	32	5	12	18	20	16	12	TCMP/CTMP-1231
S-500/900/1435-A	900	500	710	284	345	422	394	9	8x45°	35	4	11	18	16	14	11	TCMP/CTMP-1435
S-500/900/1640-A	900	500	710	227	395	464	438	9	8x45°	35	4	11	18	16	14	11	TCMP/CTMP-1640
S-560/900/1845-A	900	560	750	241	445	515	485	9	8x45°	41	4	10	16	14	13	10	TCMP/CTMP-1845
S-630/1200/2050-A	1200	630	800	269	495	565	535	11	8x45°	56	6	13	18	15	15	12	TCMP/CTMP-2050
S-800/1200/2563-A	1200	800	1000	370	595	710	675	14	8x45°	80	5	9	13	11	11	9	TCMP/CTMP-2563
S-400/900/1031-A	900	400	600	202	320	383	356	9	8x45°	29	5	12	19	22	18	13	TCR/R / TCR-1031
S-450/900/1135-A	900	450	630	216	345	425	398	9	8x45°	32	5	12	18	20	16	12	TCR/R / TCR-1135
S-500/900/1240-A	900	500	710	227	395	472	444	11	8x45°	35	4	11	18	16	14	11	TCR/R / TCR-1240
S-560/900/1445-A	900	560	750	241	445	522	495	11	8x45°	41	4	10	16	14	13	10	TCR/R / TCR-1445
S-630/1200/1650-A	1200	630	800	269	495	582	555	11	8x45°	56	6	13	18	15	15	12	TCR/R / TCR-1650
S-710/900/1856-A	900	710	900	301	555	645	615	11	8x45°	65	5	8	13	11	12	8	TCR/R / TCR-1856
S-800/900/2063-A	900	800	1000	329	625	720	688	11	8x45°	70	4	8	11	9	9	8	TCR/R / TCR-2063
S-800/1200/2271-A	1200	800	1000	224	705	800	768	13	8x45°	80	5	9	13	11	11	9	TCR/R / TCR-2271

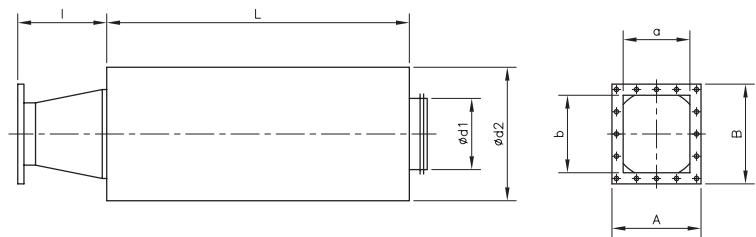

## IMPULSIÓN (Brida rectangular)

	L	d1	d2	l	a	b	A	B	Kg	Amortiguación de sustitución (dB) en banda de octavos (Hz)						
										125	250	500	1000	2000	4000	Aplicable
S-315/600/922-I	600	315	500	300	216	140	282	204	16	4	8	14	17	14	12	TCMP/CTMP-922
S-355/900/1025-I	900	355	560	300	250	165	314	229	25	4	12	20	24	23	14	TCMP/CTMP-1025
S-400/900/1128-I	900	400	600	300	300	180	364	544	29	5	12	19	22	18	13	TCMP/CTMP-1128
S-450/900/1231-I	900	450	630	300	320	200	384	266	32	5	12	18	20	16	12	TCMP/CTMP-1231
S-500/900/1435-I	900	500	710	300	280	228	344	394	35	4	11	18	16	14	11	TCMP/CTMP-1435
S-500/900/1640-I	900	500	710	300	320	250	404	336	35	4	11	18	16	14	11	TCMP/CTMP-1640
S-560/900/1845-I	900	560	750	450	360	284	444	370	41	4	10	16	14	13	10	TCMP/CTMP-1845
S-630/1200/2050-I	1200	630	800	450	450	315	545	412	56	6	13	18	15	15	12	TCMP/CTMP-2050
S-800/1200/2563-I	1200	800	1000	450	600	410	706	512	80	5	9	13	11	11	9	TCMP/CTMP-2563
S-400/900/1031-I	900	400	600	300	315	250	385	320	29	5	12	19	22	18	13	TCR/R / TCR-1031
S-450/900/1135-I	900	450	630	450	355	280	425	350	32	5	12	18	20	16	12	TCR/R / TCR-1135
S-500/900/1240-I	900	500	710	450	400	315	480	395	35	4	11	18	16	14	11	TCR/R / TCR-1240
S-560/900/1445-I	900	560	750	450	450	355	540	445	41	4	10	16	14	13	10	TCR/R / TCR-1445
S-630/1200/1650-I	1200	630	800	450	500	400	590	490	56	6	13	18	15	15	12	TCR/R / TCR-1650
S-710/900/1856-I	900	710	900	450	560	450	660	550	65	5	8	13	11	12	8	TCR/R / TCR-1856
S-800/900/2063-I	900	800	1000	450	630	500	750	620	70	4	8	11	9	9	8	TCR/R / TCR-2063
S-800/1200/2271-I	1200	800	1000	450	710	560	840	690	80	5	9	13	11	11	9	TCR/R / TCR-2271
S-800/1201/2380-I	1200	800	1000	450	560	800	680	920	90	5	9	13	11	11	9	TCR/R / TCR-2380

## Índice Alfabético de Referencias. VENTILADORES

CBDT	115	CJTHT/PLUS	20
CHT	187	CJTX-C	143
CI	105	CSX	166
CJBDT	115	CTMP	122
CJEC	184	CVT	187
CJLINE	179	HTMF	107
CJMD	128	KIT SOBREPRESIÓN	192
CJMP	137	TCMP	137
CJS	125	TCR	119
CJSRX	176	TCR/R	132
CJSX	155	THT	12
CJSX-SILENT	162	THT/HATCH	92
CJTCR/R	132	THT/IMP	97
CJTHT	24	TÚNEL JET FAN	101
CJTHT/DUPLEX/ATEX	30		

## Índice Alfabético de Referencias. ACCESORIOS

ACE-400	207	P-400	202
AR	199	PA	206
B	204	PL	202
BAC	205	PS	205
BD	204	PT	206
BIC	205	R/THT	203
BS - BSS	206	REG	207
BTUB	203	RM	199
C2V	198	RPA	203
CABLE BOX	198	RT	203
CENTRAL CO	196	S	208
CM	208	TAC	208
CUADROS ELÉCTRICOS	201	TEJ	208
IAT	198	VIS	207
INT	198	VSD1/A-RFM	200
MS	205	VSD3/A-RFT	200
P	202		





EFFICIENT WORK FANS



# SOLution DEvelopment CAPacity

Fast and flexible industrial fan solutions and tailored fans

Large experience in smoke control systems and ATEX applications

Wide range of certified products for specific markets

VENTILADORES  
HELICOIDALES Y  
EXTRACTORES DE TEJADO



VENTILADORES  
CENTRÍFUGOS Y EXTRACTORES  
EN LÍNEA



EXTRACTORES  
PARA EVACUACIÓN  
DE HUMOS



VENTILADORES HEAVY DUTY  
Y EXTRACTORES PARA  
ATMÓSFERAS EXPLOSIVAS ATEX



RECUPERADORES DE CALOR,  
UNIDADES DE FILTRACIÓN  
Y TRATAMIENTO DE AIRE



CORTINAS DE AIRE PARA  
APLICACIONES COMERCIALES E  
INDUSTRIALES



SISTEMAS DE VENTILACIÓN  
PARA VIVIENDAS



SOLICÍTENOS  
INFORMACIÓN



[www.sodeca.com](http://www.sodeca.com)



Ctra. de Berga, km 0,7  
E-08580 SANT QUIRZE DE BESORA  
(Barcelona - Spain)  
Tel. +34 93 852 91 11  
Fax +34 93 852 90 42  
comercial@sodeca.com  
Export sales: ventilation@sodeca.com  
www.sodeca.com

## Red Comercial España

### Barcelona

Ctra. de Berga, km. 0'7  
08580 Sant Quirze de Besora (Barcelona)  
Tel. 938529111 - Fax 938529042  
comercial@sodeca.com  
Provincias: Barcelona, Tarragona, Lleida y Girona

### Baleares

Sr. Miquel Àngel Morán  
Móvil: 682912100  
baleares@sodeca.com  
Provincias: Baleares

### Bilbao

Pitalven S.L.  
Sr. Jon Garin  
Pza. Jaro de Arana, 3 4º  
48012 Bilbao  
Tel./Fax 944214223  
Móvil 615749646  
jgarin@sodeca.com  
Provincias: Vizcaya, Guipúzcoa, Álava,  
Santander, Navarra y Rioja

### Canarias

Stra. Mª del Mar Castilla  
C/Juan Rumeu García, 84  
38008 Santa Cruz de Tenerife  
Móvil: 669 351 935  
Tfno./fax 822174111  
mcastilla@sodeca.com  
Provincias: Islas Canarias

### Córdoba

Sr. Juan Manuel Ceballos  
Imprenta de la Alborada, parc.224, nº 1  
14014 Córdoba  
Tel. 957325512 - Fax 957325274  
Móvil 689637163  
jceballos@sodeca.com  
Sr. Francisco Campos  
Móvil 636569796  
sevilla@sodeca.com  
Provincias: Sevilla, Huelva, Cádiz, Córdoba,  
Jaén, Cáceres y Badajoz

### A Coruña

Sr. Ricard Fernández  
Rua a Granxa, 6 (Lorbe)  
15177 Oleiros  
Tel./Fax 981628196  
Móvil 615145104  
rfernandez@sodeca.com  
Provincias: A Coruña, Lugo, Ourense  
y Pontevedra

### Gijón

Sr. Roberto González  
Cean Bermúdez, 12 bajo  
33208/ Gijón (Asturias)  
Tel. 985149581 - Fax 985165313  
Móvil 629073929  
rgonzalez@sodeca.com  
Provincias: Asturias y León

### Madrid

Stra. Almudena Hernández  
Apartado de Correos 6103  
Calle San Isidro Labrador, 3 (local).  
28005 Madrid  
Tel. 913667045  
Fax 913666045  
Móvil 670744420  
sodecacentro@sodeca.com  
Provincias: Madrid, Toledo, Ciudad Real,  
Guadalajara, Segovia, Ávila y Cuenca

### Murcia

Sr. Francisco José Hurtado  
Apartado de Correos 6103  
30080 Murcia  
Tel. 675767025 - Fax 968970250  
hurtado@sodeca.com  
Provincias: Murcia, Almería, Granada  
y Málaga



### Valencia

Tacifer s.l.  
Sr. Javier Talens  
Timoneda, 8, 1º  
46008 Valencia  
Tel. 963841480 - Fax 963820207  
Móvil 670696289  
javiertalens@sodeca.com  
csebastian@sodeca.com  
Provincias: Valencia, Castellón,  
Alicante y Albacete

### Valladolid

Sr. Álvaro San José  
Móvil 606974916  
sodecacastilla@sodeca.com  
Provincias: Salamanca, Valladolid, Palencia,  
Burgos y Zamora

### Zaragoza

Hernández Silbe s.l.  
Stra. Silvia Hernández  
Alfonso I, casa 15  
50410 Cuarte de Huerva - Zaragoza  
Tel. 630263224 - Fax 976937430  
sodecaragon@sodeca.com  
Provincias: Huesca, Zaragoza,  
Teruel y Soria



### SODECA EXPORT

Sodeca S.L.U.  
Ctra. de Berga, km 0,7  
E-08580 SANT QUIRZE  
DE BESORA  
Barcelona, SPAIN  
Tel. +34 93 852 91 11  
Fax +34 93 852 90 42  
ventilation@sodeca.com

### PORTUGAL

Sodeca Portugal Lda  
Sr. Luiz Araújo  
Rua Veloso Salgado 1120/1138  
4450-801 Leça de Palmeira,  
Porto, PORTUGAL  
Tel. +351 229 991 100  
Fax. +351 229 991 119  
geral@sodeca.pt

### PORTUGAL

Sodeca Portugal Lda  
Sr. Luiz Araújo  
P. E. da Granja - Pavilhão 8  
2625-607 Vialonga,  
Lisboa, PORTUGAL  
Tel. +351 219 748 491  
Fax. +351 219 748 493  
geral@sodeca.pt

### FINLAND

Sodeca Finland Oy  
Mr. Kai Yli-Sipilä  
Metsälinnankatu 30, PL2,  
FI-32700 Huitinen,  
FINLAND  
Tel. + 358 400 320 125  
orders.finland@sodeca.com

### CHILE

Sodeca Ventiladores Ltda  
Sr. Francisc Bertran  
Avda. Puerta Sur  
03380 San Bernardo,  
Santiago, CHILE  
Tel. +56 22 840 5582  
ventas.chile@sodeca.com

### ÁREA CARIBE

Sodeca Cuba  
Sr. Carlos Hernández  
Residencial Miramar  
Apto. Nº 108  
Ave. 7ma Nº 1805 entre 18 y 20  
Miramar Playa, Havana, CUBA  
Tel. 00537 20 43721  
sodeca@sodeca.co.cu

### RUSSIA

Sodeca, L.L.C.  
Mr. Stanislav Alifanov  
Russia, 140180, Moscow region,  
Zhukovskiy, Myasisheva str, 1,  
room 603  
Business Center "Chaika"  
Tel:+7 495 955 90 50  
alifanov@sodeca.com



Ctra. de Berga, km 0,7  
E-08580 SANT QUIRZE DE BESORA  
(Barcelona - Spain)  
Tel. +34 93 852 91 11  
Fax +34 93 852 90 42  
comercial@sodeca.com  
Export sales: ventilation@sodeca.com

**www.sodeca.com**

