

Standard Range Catalogue 5.2

Helios Ventilation Systems.



AIRTECHNIC
www.airtechnic.gr

Air-Conditioning & Ventilation Components & Systems





Small room fans

Small room fans, wall fans, inline fans, window fans, ceiling fans and heater fans.

20



Domestic ventilation

Controlled domestic ventilation according to DIN 18017-3. Mono tube ventilation systems and central ventilation systems.

40



Ventilation with heat recovery

Comfort ventilation with heat recovery. System solutions from one source.

88



Axial and VAR fans

High performance axial fans. Medium pressure axial fans. RADAX® VAR high pressure round duct fans.

170



Box fans

GigaBox centrifugal fans. MegaBox centrifugal fans. Fresh air boxes.

273



Round duct fans

MultiVent®, flat and Acoustic Line centrifugal round duct fans.

350



Rectangular duct fans

Forward curved, backward curved, sound-insulated.

426



Air treatment

Filters. Heating. Sound insulation.

473



Roof fans

Vertical, horizontal and diagonal outlets.

489



Accessories

Shutters, wall and roof outlets. Flow elements and valves. Fire protection systems.

553



Measure. Control. Regulate.

Sensors, speed controllers and control systems.

591

Type	Page	Type	Page	Type	Page
ABV AbluVent	570	DS Speed switch	595	ELFZ / ELF-ZLE Repl. air filter for ZLA / ZLE	579 f
ACL Air quality controller	608	DSEL Speed switch	594	ELS / ..EC ultraSilence® Mono tube vent. system	44 ff
AE Extract air elements	567 ff 80, 86	DSTS / DSTS Ex Flexible connectors (for roof fans)	551 497 ff	– Casing flush-m. / surface-m.	62 ff
ALB Fresh air boxes and accessories	332 ff	DSZ Speed switch	594	– Fan inserts	70 f
ALEF Intake air elements	581 71, 80, 86	DVAM / DVAV Ceiling fans	38	– Types with EC technology	58 f
ALF Helioflex ventilation duct	87, 562	DV EC Roof fans with EC technology	498 ff 78 f	– Accessories	70 f
AMD / AMW Medium pressure axial fans	218 ff	DVS Shutters (for roof fans)	551 497 ff	ELS-D Fire protection ceiling seal	588 71, 81
AS Connectors	562	DVW Ceiling fans	38	ESA / ESU Electronic speed controller contin. variable, for 1~ fans	597
ASD / ASD-SGD Intake nozzles	269	DX Centrifugal fan, Ø 100 mm	32	ESD Electronic speed controller contin. variable, for 3~ fans	601
AV External wall extract air fans	34 f	EBR Mounting rings for disc valves	575 ff	ESE Built-in speed controller	597
AVD DK / RK High-performance axial fans Short nozzle / short duct	210 ff	EDR Elec. differential press. controller	606	EST Four-step thermostat	600
BAE / BAK Fire shutoff element, damper	584 f 80	EDT Differential temp. controller	609	ETR Electronic temp. controller	606
BA-S End switch (accessories BAE/BAK/BTK)	584 ff	EH Mounting sleeve	584 f	ETS Plug-in cross talk silencer	571
BLS Fire protection ventilation tiles	590	EHR-K/EHR-R TR Electric heating element	480, 477 f	ETW Electronic transformer controller for 1~ fans	601
BM Pipe clamp connectors	377 ff	EHS / EHSD Electronic temperature control system for EHR	479	EUR 6 C / EUR EC Universal controller	604 f
BSX Operating switch	597	EKLF Repl. air filter cartridges (for KLF)	475	EVK Electric shutters	554 f
BTV / BTK Fire prot. disc valve, damper	586 f	ELF Replacement air filter mats (for LF und LFBR)	474, 476	F Fittings for square-shaped shutters	562
CO₂ AP-A/AP/UP CO ₂ -Monitor	610 f	ELF-ABV Repl. air filter mats for ABV	570	F Flat duct system	160
DDF Roof outlet	561	ELF-ALB Replacement air filters for ALB	335 ff	FAP Flange connection plate	81
DDS Differential pressure switch	608	ELF-DLV Replacement air filters for DLV	573	FDH Flat roof outlet	560
DFR Counterflange (for roof fans)	551 497 ff	ELF / ELS Perm. filter for ultraSilence® ELS	71	FDP Flat roof pan tile (for DH)	560
DH Roof outlet	560 87	ELF-KWL Repl. air filter for KWL® units	94 ff	FDR Feuchte-Differenz-Regelung	611
DIF Diffuser	272	ELF-LEWT Repl. air filters for LEWT-A	169	FDS Flat roof base (for roof fans)	552 497 ff, 81
DLV / DLVZ Design ventilation valves	572 f	ELF-SEWT Repl. air filters for SEWT-W	167	FES Window mounting kit	29 f, 36 f
DR Install. kit for double windows	37	ELF-VFE Replacement air filters for VFE	570	FF Flat flange	175 ff, 270
DRVM / DRVS Shutter (for roof fans)	551 497 ff	ELF-ZS Repl. air filters for ELS-ZS	71	FK Flat duct system, galv. steel	160 f
				FM / ..Ex / ..T120 Flexible connecting sleeve	270 373, 314 ff

Type	Page	Type	Page	Type	Page
FR Counterflange – for round duct fans – for roof fans	177+249 ff, 270 551, 497 ff	HWD / HWW / ..EC – High-performance axial fans, low pressure, with wall ring – Types with EC technology	192 ff 174 ff	M1 MiniVent® small room fans Connection Ø 100, 120, 150 mm	22 ff
FR Operating switch for window fans GX	594 37	HY Hygrostat	608	M Motor protection circuit breaker	596
FRS FlexPipe® plus – Flex. duct system, round+oval – Design grille	146 ff 151	IP IsoPipe® Insulated duct system	156 ff	MBD / MBW / ..EC – MegaBox centrifugal fans – Types with EC technology	323 ff 314 ff
FRS FlexPipe® Flexible duct system, round	154 ff	JVK Multi-leaf dampers	472	MBR Mounting panel for M1/100, HR 90 KE	23, 29
FSD Flexible cross talk silencer	487	KAK Cold smoke shutters	589	MD / MW Motor protection circuit breaker	596
FSK Fittings, rectangular to round	431 ff	KLB Tape	157, 161 ff	MF Mounting flange for M1/100, HR 90 K	23, 29
FU Frequency converter	602 f	KLF Duct air filter	475	MK Mounting brackets – for centrif. round duct fans – for axial, VAR fans	373, 379 ff 271
G Ventilation grille, fixed	558	KR Wall duct for wall installation	37	MRV Mounting ring	272
GBD / GBW / ..EC – GigaBox centrifugal fans – Types with EC technology	296 ff 278 ff	KRD / KRW / ..EC – InlineVent® rect. duct fans – Types with EC technology	460 ff 444 ff	MSA Motor protection circuit breaker	596
GF Counterflange	472	KSB Cold shrink tape	161	MTVA / MTVZ Metal disc valves, extr./supp. air	574 576
GVK Weather protection grille with shutter (accessories HV)	31	KSD Duct silencer	487	MV / ..EC – MultiVent® round duct fans – Types with EC technology	360 ff 356 ff
GX Window fans up to 1600 m³/h	37	KTRD / KTRW Clim. transf. contr., 400V/230V	600	MVB Operating switch	23 ff, 32 361 ff
HDH Roof ventilation hoods	550	KTVA / KTVZ Plastic disc valves, extr./supp. air	575, 577	MVS Protection grille	361 ff
HQD / HQW / ..EC – High-performance axial fans, low pressure, with square plate and inlet nozzle – Types with EC technology	192 ff 174 ff	KVD / KVV InlineVent® rect. duct fans, forward curved	430 ff	MWS Transformer speed controlle	598
HR HelioVent® mini fans with electric inner shutter	28 f	KWL® Ventilation units with heat recovery and accessories	88 ff	NG 24 Mains adapter for EDR / ETR	606
HRFD / HRFW / ..EC – High-performance axial fans, low pressure, with pipe sleeve and flanges on both ends – Types with EC technology	192 ff 174 ff	KWL® Yoga Ventilation units with heat recovery and accessories	134 ff	PA / PU Speed potentiometer	607
HSD / HSW High-performance axial fans, low pressure, with cylindrical pipe sleeve and smooth ends	192 ff	LDF Air pressure difference sensor	604 f	PDA / PDU Pole changing switch for Dahlander winding	595
HSDV Hood silencer (for roof fans)	550	LEWT Ground-to-air heat exchanger	168 f	PGWA / PGWU Pole changing switch for separate winding	595
HV HelioVent® wall fan 450, 840 m³/h	31	LF / LFBR Air filter / air filter box	474, 476	PWDA / PWGW Reverser and pole ch. switch	595
HVR HelioVent® flush-mounted wall and window fans	30 36	LGF Air velocity sensor	604 f	QVK Ventilation grille, adjustable	558
		LGK / LGM Ventilation grille, plastic/metal	559	RAG Rain-repellent grille	557
		LGR Ventilation grille, adjustable	558	RDD / RDW / ..EC – Centrifugal roof fans, horizontal outlet – Types with EC technology	526 ff 504 ff
		LTA Outdoor temperature sensor	604 ff	RDS Transformer speed controller	599
		LTGB / LTGW Door ventilation grilles	559		
		LTK / LTR Duct/room temperature sensor	604 ff		

Type	Page	Type	Page	Type	Page
REW Inline fans	33	SKRD / SKRW / ..EC – InlineVent® rect. duct fans, sound-insulated – Types with EC technology	464 ff 448 ff	VDD / VDW / ..EC – Centrifugal roof fans, vertical outlet – Types with EC technology	526 ff 504 ff
RHS Isolator / main switch	595	SSD Base silencer (for roof fans)	552 497 ff	VFE Attachment filter element	570
RP RenoPipe Air distribution system	158 f	STH Electric heater fans	39	VH Extension sleeves	193 ff
RR / RRK / ..EC – Centrifugal round duct fans made of steel or plastic – Types with EC technology	388 ff 376 ff	STM Damper servo motor, auxiliary switch (access. JVK)	472	VK Shutters, automatic	554 f
RRK Ex Centrifugal round duct fans, explosion-proof	372 f	STS / STS Ex Flanged flexible connector – for axial round duct fans – for roof fans	270, 175 ff 551, 497 ff	VKH Volume flow stabiliser	564 f
RS Isolator switch	550 , 594	STSSD / STSSW Five-step operating switch for TSSD / TSSW	598 f	VR Extension ducts	270
RSD Duct silencer	488	STV Pipe joint (accessories DH)	560	VS / VS Ex Connectors	472
RSK / RSKK Duct shutters	556	SWV / SVR / ..EC – Centrifugal round duct fans – Types with EC technology	375, 388 ff 376 ff	WDS Corrugat. roof base (for roof fans)	552 497
RVB / RVBD Duct connector / with seal	562	SVS / ..EC – Centrifugal round duct fans, sound-insulated – Types with EC technology	416 ff 402 ff	WER Feed duct for flush wall install. (accessories HV, GX)	31, 37
RVE Inline duct shutters	556	SVE Sound insulation element	563	WES Wall mounting kit	23 ff
RVK Shutters, adjustable	554	SWE / SWT Flow monitor	609	WHR Warm water heating element	481 f
RVM / RVS Duct shutters	556	TFK / TFR Duct / room sensor (for EHS, EHR-R)	479 f	WHST 300 T38 / T50 Temp. control systems for warm water heater element WHR	483 163
RZ Reducers	562	TFR-ALB Room temp. sensor for ALB	335 ff	WHS HE / WHSH HE Temperature control system	484 f
SA / SU Three level switch	607	TFR-ALB/KWL Room temp. sensor for KWL® and ALB	121 ff 335 ff	WS Reverser	594
SB Screw fastenings (for GX)	37	TME Thermostats	608	WSG Weather protection grille	557
SB / SBD / ..EC – SilentBox®, round duct fans – Types with EC technology	416 ff 402 ff	TMK Telescopic wall kit	561	WSUP / WSUP-S Weekly timer	593
SCH Hose clips	562	TS T-pieces	562	Z Turn-off delay timer	593
SDD / SDZ Vibration dampers	271	TSD / TSSD Transformer speed controller for 3~ fans	599	ZAV Supply air-extract air valves	162
SDD-U Vibration damper base	271	TSW / TSSW Transformer speed controller for 1~ fans	598	ZEB / ..EC Central extract ventilation box Type with EC technology	82 ff 85
SDE Silencer (for KWL® units)	157	TWH Telescopic wall sleeves	23 ff 30, 36	ZLA 125 Automatic supply air element	72 f
SDH Gable roof outlet	561	UDP Universal pan tile (for DH)	560	ZLA / ZLE Auto. element/supp. air element	579 f
SDS Pitched roof base for roof fans	552 497 ff	VARD / VARW High pressure round duct fans	244 ff	ZLA LE Soffit element	74 f
SEWT Ground-to-brine heat exchanger	166 f			ZLS-DV EC Central ventilation system	76 ff, 499 ff
SG Protection grille	269			ZTV Thermostat disc valves, supp. air	578
SGR Protection grille for RRK Ex/RR	373 377 ff				

Lower power axial fans
Series MiniVent® M1, HR 90 KE, HV, REW, GX

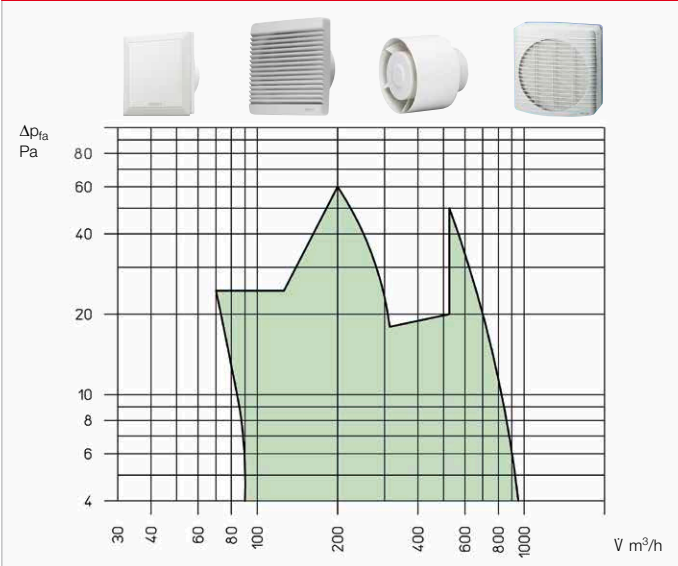

High performance axial fans
from \varnothing 200 – 1000 mm, Series HQ, HW, HS, HRF, AMD, AVD

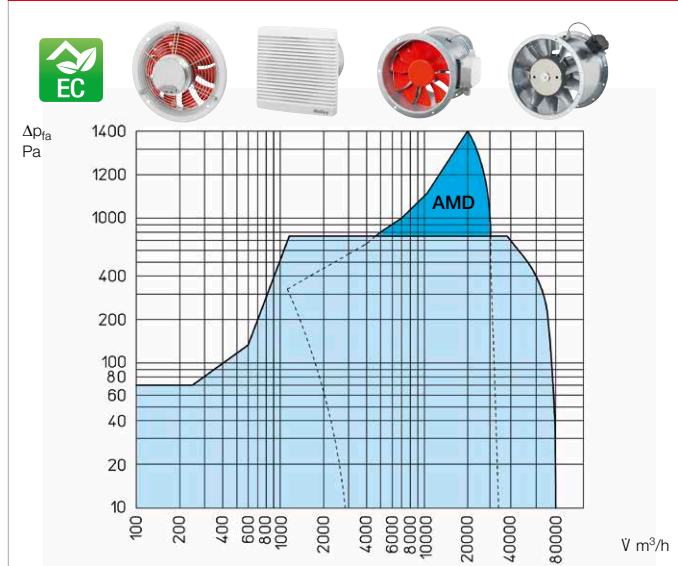

Centrifugal round and rectangular duct fans, fresh air boxes etc.
Series AV, DX, MV, RR, SB, SV, KV, KR, SKR, ALB EC

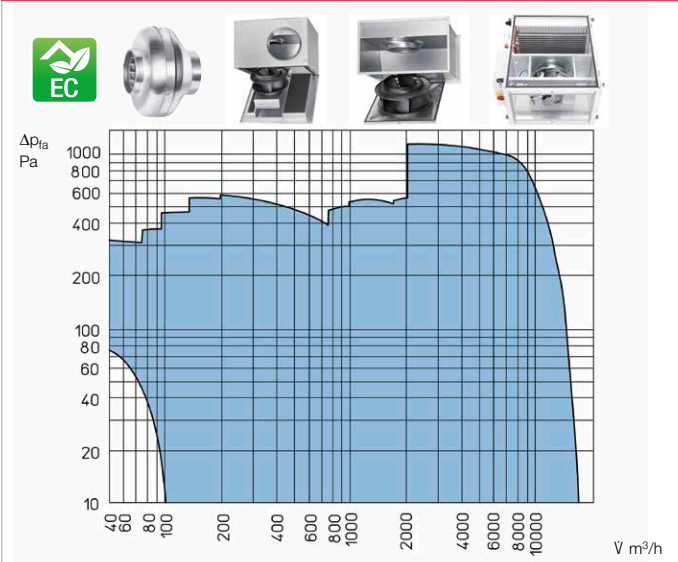

Centrifugal roof fans
Series DV EC, RD EC, VD EC

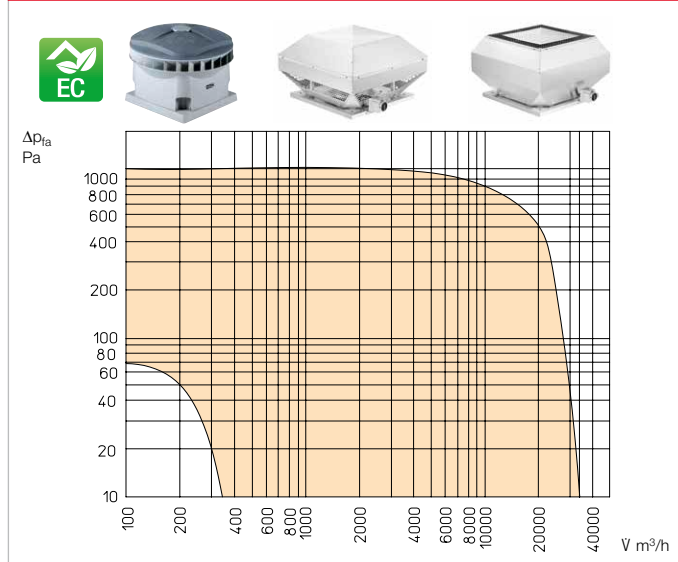

High pressure round duct and centrifugal fans
Series VAR, MB, GB

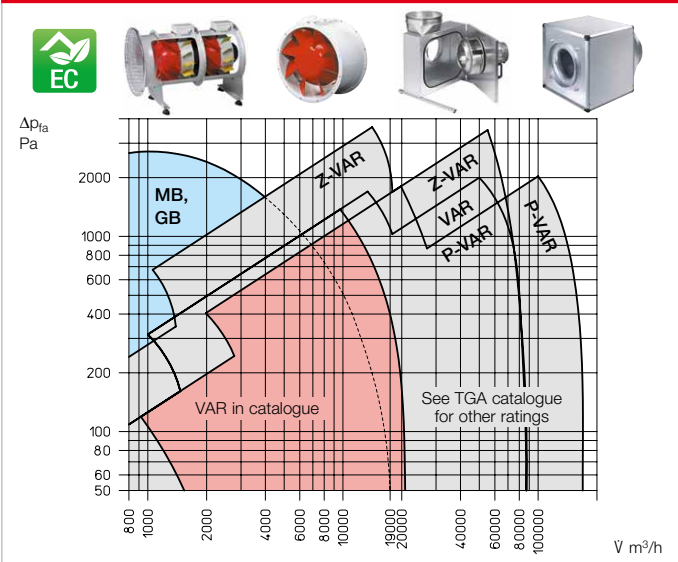

Large axial fans
from 1000 – 7100 mm impeller- \varnothing

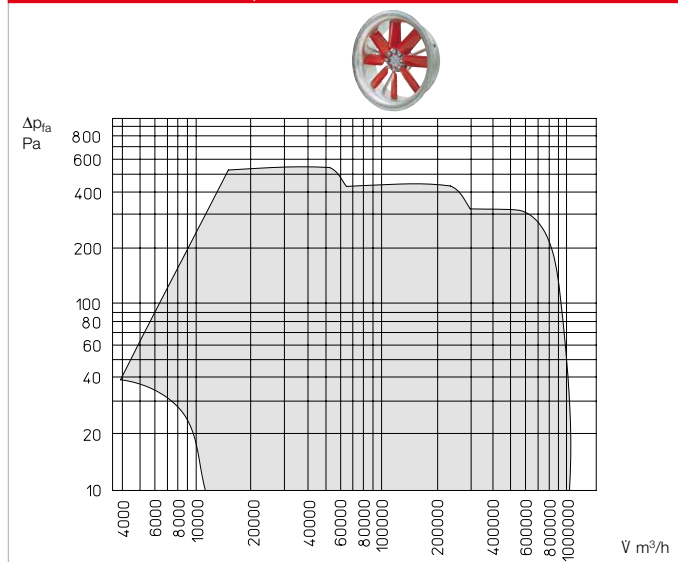

By inventors for discoverers. Welcome to the Heliosphere.

You can find all **new products and innovations as well as practical applications** relating to ventilation in the Heliosphere. Let us show you various application areas in a hands-on way and dive deep into the specific requirements, for which we will show you suitable system solutions.

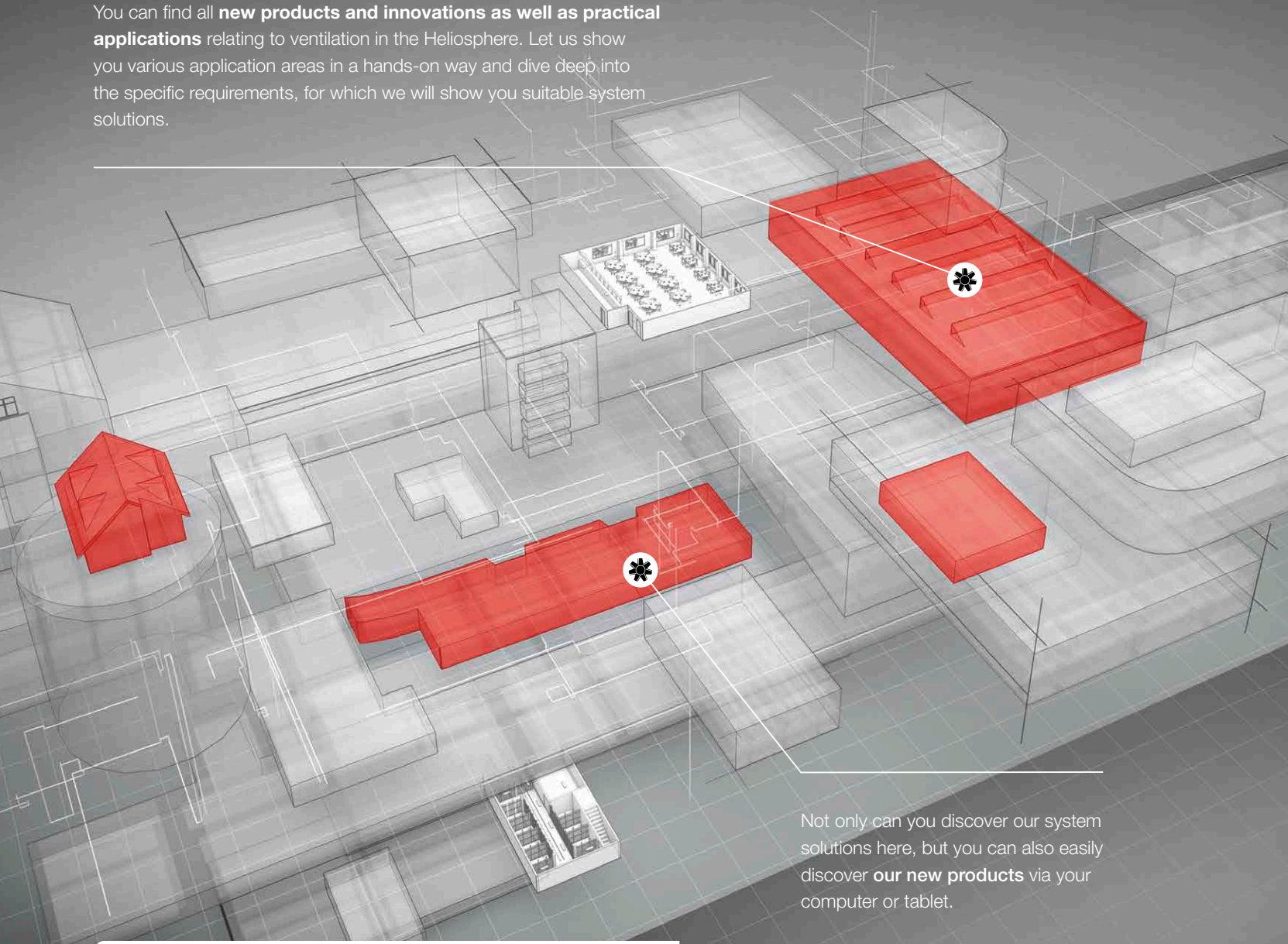

Not only can you discover our system solutions here, but you can also easily discover **our new products** via your computer or tablet.

We invite you:
heliosventilatoren.com/heliosphere

Discover now:



easyControls 3.0

■ KWL® easyControls 3.0

With easyControls 3.0, you can not only expect our brand new control generation, but also a new range with optimal flow rate capacity for all living situations. All central Helios KWL units can be operated intuitively and flexibly and adapted to any need with easyControls 3.0: whether with the new touch control element or Smartphone, from home or on the move.



100ff

■ KWL® Yoga

Maximum energy efficiency and extremely low operating noise as well as flexible control options – KWL Yoga with heat recovery impresses both in schools and offices as well as in commercial facilities of all kinds. The extremely compact design and simple installation without an air distribution system also make KWL Yoga perfect for renovation projects.



134ff

■ KWL® EcoVent Verso

Our decentralised ventilation system with heat recovery KWL EcoVent Verso is available with a diameter of just 160 mm. The efficient A+ unit is therefore even more compact and easier to install – with the same technical performance. Smart control features also offer greater comfort, e.g. password protection, snooze function or extract air mode.



92ff

■ Solutions for commercial kitchen extract air

Commercial kitchens are a real challenge for ventilation systems because heat, odours and grease pollute the indoor air. The new VD T120 roof fans provide an optimal VDI 2052-compliant extract air solution for all catering facilities.



489ff

■ Helios AIR1® compact ventilation units

Whether for ceiling installation or floor-standing installation, with highly efficient cross counterflow or rotary heat exchangers and for internal and external application. Helios AIR1 offers numerous options for practically all areas of application with 4 series and more than 27 unit types.



More details at:
HeliosAIR1.com

Helios Ventilatoren – Your partner for innovative ventilation systems.

Ventilation is our passion. A passion that has moved us, driven us forward and fascinated us for many decades. As one of the leading manufacturers of ventilation systems, we are continuously setting milestones in the ventilation industry and we always guarantee the right solution for your individual projects.

The success story.

The origin of Helios goes back to the foundation of

Fernwellen Apparatebau AG in 1923. The company manufactured headphones, horn loudspeakers and detector elements. Production of dynamos and headlights began in the early 1930s, which were successfully sold under the brand name “Helios” coined from the sun god in Greek mythology. The company started to manufacture fans in 1951. The company initially manufactured table fans, ceiling fans and pedestal fans.

The following decades were characterised by the successful and continuous expansion of the core business.

Premium products.

The Helios brand stands for innovation, quality and an extensive range of products. We offer a finely tuned series range in all performance classes for all conceivable areas of application. More than 3,500 catalogued unit types make it easy to find the right solution, even in case

of complicated operating conditions.

System competence.

Each project is individual. Therefore, at Helios, we do not simply produce good products, but rather optimally coordinated system solutions. We thereby ensure that everything fits perfectly from the start of your project.



Visit us at:



Helios Online-Tools.

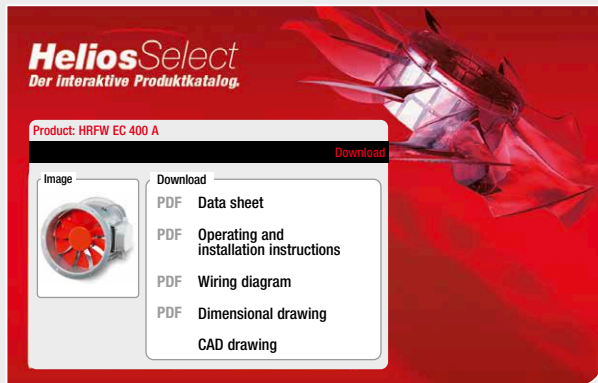

■ **Find your desired product quickly and easily with HeliosSelect.**

Whatever product information you need – the electronic catalogue HeliosSelect will quickly help you to your objective. You can find all unit data here, from the dimensional drawing, technical information and wiring diagrams through to the installation instructions.

www.HeliosSelect.com



■ **Design, bills of quantities and ventilation concept with KWLeasyPlan.**

For the safe and easy planning of complete KWL systems with Helios system components including bills of quantities. Proof of ventilation concept is provided in just a few steps. KWLeasyPlan can be operated directly in the browser as an online application without installation. Your project results can be stored and processed ready for printing.

www.KWLeasyPlan.de

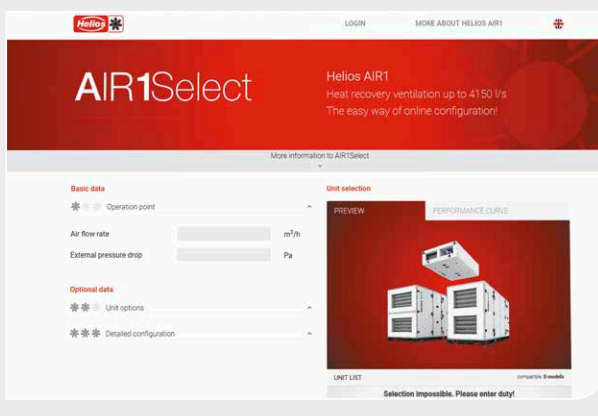

■ **AIR1Select: The online tool for configuring RLT units.**

In order to assist you with the selection of an optimal compact ventilation unit, we developed AIR1Select – an online configuration tool especially for Helios AIR1 ventilation units. AIR1Select allows the configuration of your ventilation unit with a few self-explanatory inputs. You can save, export and call up your results at any time.

www.AIR1Select.com

The volume of air to be supplied or extracted from a room largely depends on the room usage and pollution or odour levels. The air volume requirement in industrial and commercial facilities can also be determined by the generated process heat.

The volume flow can be determined according to various criteria using the following formulas and tables. If multiple criteria can be used for the calculation, the most unfavourable assumption must be made.

Determination of volume flow using the air exchange rate

Air exchange rates (see table 1) are empirical values without particular loads due to pollutants and contaminants.

$$\dot{V} = V_R \cdot LW/h \text{ [m}^3\text{/h]}$$

V_R : Room volume m³
 LW : Air exchange 1/h from table 1

Determination of volume flow using the number of persons
(DIN EN 16798-3)

The values per person should be increased by 20 m³/h in rooms with additional loads (e.g. tobacco smoke).

$$\dot{V} = P \cdot A_{RP} \text{ [m}^3\text{/h]}$$

P : Number of persons
 A_{RP} : Intake air rate per person from table 2

Determination of volume flow using AGW values

$$\dot{V} = \frac{M}{k_{AGW} - k_a} \text{ [m}^3\text{/h]}$$

M : Accumulating pollutant load per hour mg/h
 k_{AGW} : Max. permissible pollutant concentration mg/m³ (from AGW table 3)
 k_a : Pollutant content in supply air mg/m³ (AGW table by C. Hermanns Verlag, Cologne)

Determination of volume flow for moisture removal

$$\dot{V} = \frac{G}{(x_2 - x_1) \cdot \rho} \text{ [m}^3\text{/h]}$$

G : Water volume g/h
 x_2 : Water content in extract air g water / kg air
 x_1 : Water content in supply air g water / kg air
 ρ : Air density kg/m³ (air 20 °C, 1013 mbar = 1.2 kg/m³)

Determination of volume flow for heat dissipation

$$\dot{V} = \frac{\dot{Q} \cdot 3600}{\rho \cdot c_p \cdot \Delta T} \text{ [m}^3\text{/h]}$$

\dot{Q} : Heat output to be dissipated kW
 c_p : Spec. air heat kJ/(kg · K) (air 20 °C: $c_p \approx 1$)
 ΔT : Temperature difference between fresh air and heated air K
 ρ : Air density kg/m³ (air 20 °C, 1013 mbar = 1.2 kg/m³ (1 kWh = 3600 kJ))

Determination of heat output for heating the intake air

$$\dot{Q}_L = \frac{\dot{V} \cdot \rho \cdot c_p \cdot \Delta T}{3600} \text{ [kW]}$$

\dot{Q}_L : Ventilation heat/heat output kW
 \dot{V} : Volume flow m³/h
 ρ : Air density 1.2 kg/m³ (20 °C)
 c_p : Spec. heat kJ/(kg · K)
 ΔT : Temperature difference (K) between ϑ_i room temperature and ϑ_a outdoor temperature

$$\Delta T = \vartheta_i - \vartheta_a \text{ [K]}$$

Table 1 Air exchange rate and sound pressure (rec. guide values)

Room type	LW/h	Max. sound press. level dB(A)	Remark
WCs in apartments	4 – 5	40	Extract ventilation
commercial/public	5 – 15	50	Extract ventilation
Battery rooms	5 – 10	70	"Ex" required
Bathrooms	5 – 7	45	Preheating Supply air
Pickling plants	5 – 15	70	Acid protection
Libraries	4 – 5	35 – 40	
Office rooms	4 – 8	45	
Shower rooms	15 – 25	65 – 70	Preheating Supply air
Dyeing facilities	5 – 15	70	"Ex" test, acid protection
Paint spray facilities	25 – 50	70	"Ex" required
Garages	aprx. 5	70	Extract ventilation
Cloakrooms	4 – 6	50	
Restaurants, casinos	8 – 12	40 – 55	Supply and extract ventilation
Foundries	8 – 15	80	Extr. vent. Create heat balance
Hardening plants	up to 80	80	Extr. vent. Create heat balance
Lecture halls	6 – 8	35 – 40	Supply and extract ventilation
Cinemas and theatres	5 – 8	35 / 25	Supply and extract ventilation
Classrooms	5 – 7	40	
Conference rooms	6 – 8	45	
Kitchens private	15 – 25	45 – 50	Extract ventilation
Kitchens commercial	15 – 30	50 – 60	Extract ventilation
Laboratories	8 – 15	60	Extract vent., Ex, acid protection
Paint shops	10 – 20	70	"Ex" required
Copyshops	10 – 15	60	Extract ventilation
Machine rooms	10 – 40	60 – 80	Create heat balance
Assembly halls	4 – 8	60 – 70	
Sheet metal works	8 – 12	60	Extr. vent. Create heat balance
Welding shops	20 – 30	70 – 80	Workstation extraction
Indoor swimming pools	3 – 4	50	Preheating Supply air
Meeting rooms	6 – 8	40	
Vaults	3 – 6	60	
Changing rooms	6 – 8	60	Extract ventilation
Gymnasiums	4 – 6	50	
Salesrooms	4 – 8	50 – 60	
Meeting facilities	5 – 10	45	
Waiting rooms	4 – 6	45	
Laundrettes	10 – 20	60 – 70	Create heat balance
Workshops with high air deterioration	10 – 20	60 – 70	
with low air deterioration	3 – 6	60 – 70	

Living rooms according to DIN 1946-6 and DIN 18017-3 (see also www.KWLeasyPlan.de).

Table 2 Intake air rate per person by room type

Room type	m ³ h x persons	Room type	m ³ h x persons
Individual office	40	Reading room	20
Open-plan office	60	Classroom	30
Theatre, concert	20	Lecture hall	30
Canteen	30	Exhibition hall	30
Conference room	20	Salesroom	20
Cinema	30	Museum	30
Ballroom	30	Workshop	40
Rest room	30	Hotel room	40
Break room	30	Gymnasium and sports hall with spectators	30

Table 3 Extraction Occupational exposure limit values (AGW)*

Pollutants	cm ³ m ³	mg m ³	Pollutants	cm ³ m ³	mg m ³
Acetone	500	1200	Formaldehyde	0.3	0.37
Aniline	2	7.7	HCL	2	3
Ammonia	20	14	Methanol	100	130
Butane	1000	2400	Propane	1000	1800
Chlorine	0.5	1.5	Mercury	—	0.02
CO	30	35	Nitric acid	1	2.6
CO ₂	5000	9100	SO ₂ (H ₂ SO ₄)	1 (–)	2.7 (0.1)

* TRGS 900 (see quarterly lists from the Institute for Occupational Safety and Health BGIA, Sankt Augustin).

The fan noise level must be taken into account when designing and planning a ventilation system. The noise impact of a noise source (fan) on the rooms to be ventilated and the vicinity can be roughly calculated using the following information. Noises are primarily generated by the fan, but possibly also by duct components, aggregates, ventilation grilles, etc. if the air flow velocity is too high. Therefore, a velocity of approx. 7 m/s should not be exceeded. The sound-insulated installation of components and fans should also be taken into account. The maximum permissible noise emission values are regulated in the relevant regulations and they must not be exceeded. Noise reductions, i.e. sound power level reductions, are achieved through a greater distance to the noise source, ducts, fittings, ventilation grilles, etc. and above all by using silencers. As a matter of principle, the noises should be kept as low as possible at source, i.e. low-noise fans should be selected.

The fan sound power output at the air outlet must be converted to sound pressure for the sensitivity of the human ear. In relation to "free field" conditions, the reduction depending on distance can be seen in Figure 4. The room absorption capacity is of great importance for the calculation in a room.

Noise level in the vicinity of buildings (TA noise)

The industrial code defines the following maximum values:

Area	Emission value dB(A)	
	Day	Night
Purely commercial area	70	70
Predominantly commercial area	65	50
Mixed area	60	45
Predominantly residential area	55	40
Purely residential area	50	35
Spa area Hospitals	45	35

Figure 4
Difference from sound power to sound pressure with distance

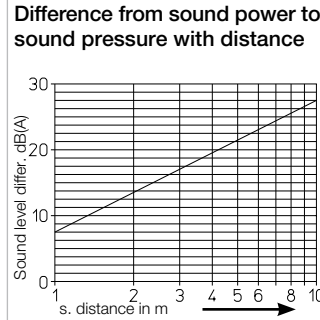

Example:
Sound power of fan = 70 dB(A)
Sound pressure at 1 m distance (free field) = 70 dB(A) minus 8 = 62 dB(A)

Figure 6
Addition of multiple noise sources with the same sound levels

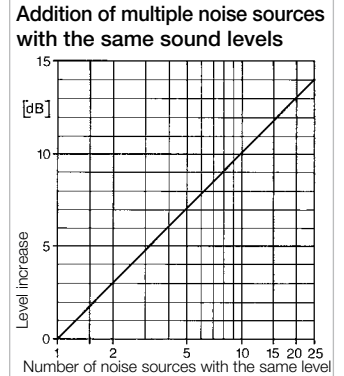

Example: 10 noise sources at 60 dB(A)
Total volume: 60 dB(A) + 10 dB(A) = 70 dB(A)

Figure 5
Sound pressure reduction with distance

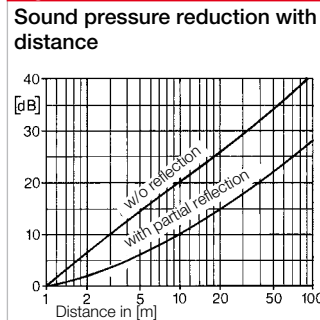

Example:
Sound pressure at 1 m distance = 60 dB(A)
Sound pressure at 5 m distance w/o reflection (free field) minus 15 = 45 dB(A)
w/ partial reflection minus 5 = 55 dB(A)

Figure 7
Addition of multiple noise sources with different sound levels

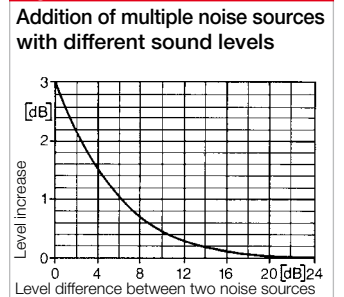

Example: 2 noise sources 60 dB(A) and 64 dB(A)
Total volume: 64 dB(A) + 1.5 dB(A) = 65.5 dB(A)

Room absorption (Figure 8)

Every room has damping properties. These depend on the condition of its walls, flooring, ceiling, furniture and size. The sound pressure level L_{PA} is different at every point in the room and it is lower than the sound power level L_{WA} of the existing noise source. The average room absorption can be calculated in "m² sabins" from the volume and average absorption coefficients.

Direction factor Q

The direction factor depends on the location of the noise source and the location of the listener. Sound incidence 45°, Q = 4
Sound incidence 0°, Q = 8

Room damping ΔL

Difference from sound power to sound pressure (VDI 2081 sheet 1)

$$\text{Sound pressure in room } L_{PA} = L_{WA} - \Delta L \text{ [dB]}$$

Example Classroom

- Volume: 72 m³
- Average absorption coefficient: 0.1 α_m
- Average Room absorpt. area: Sabins 14 m²
- Room point 1, Outlet in middle of room
Sound incidence 0°, Q = 8
Distance 1.8 m
 $\Delta L = 2.5$ (dB)
- Room point 2, Outlet in corner of room
Sound outlet 45°, Q = 4
Distance 4 m
 $\Delta L = 5$ (dB)

Figure 8

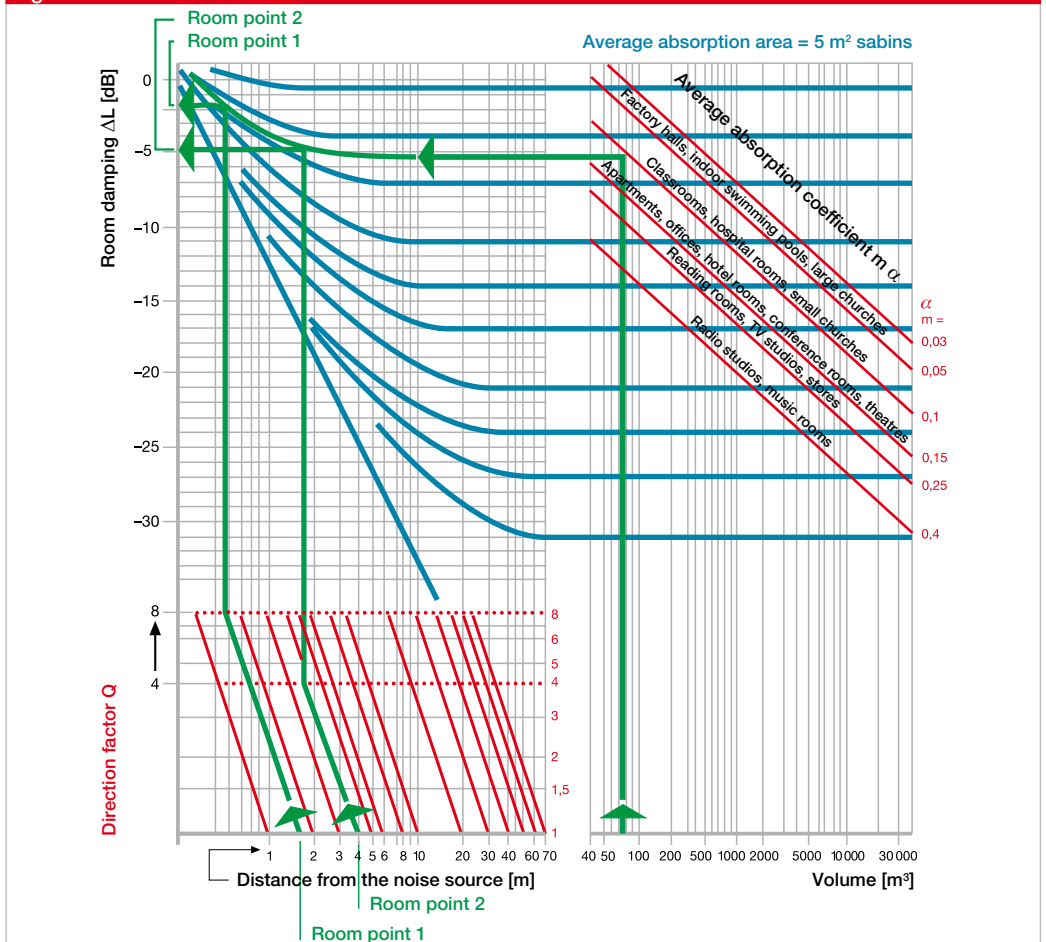

Pressure losses

Ventilation systems often consist of multiple components, such as: fan, deflectors, grilles, heat exchangers, filters, etc.

All these components cause pressure losses which are crucial for the selection of the right fan. The pressure loss Δp_{fa} (static pressure difference) of the entire system is calculated by the addition of all individual resistances (see Figure 9).

Figure 9 Pressure losses in a ventilation system

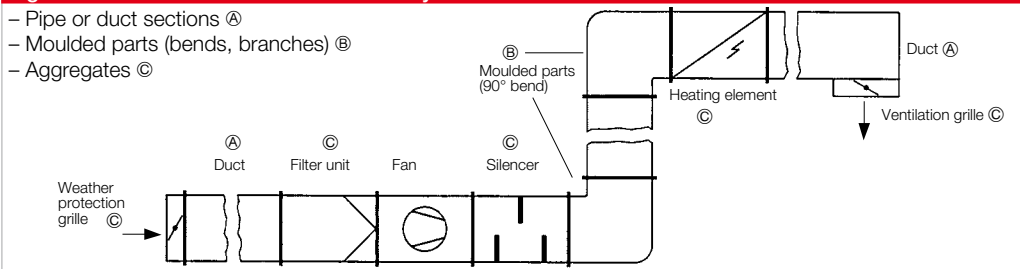

Pressure loss in pipe or duct sections

$$\text{A) } \Sigma \Delta p = \Delta p_{f1} \cdot L_1 + \Delta p_{f2} \cdot L_2 + \dots \text{ [Pa]}$$

$\Delta p_{f1,2,\dots}$: From the diagram Figure 10 [Pa/m]
L: Duct length [m]
Auxiliary value d_h

Equivalent diameter d_h

$$d_h = \frac{2 \cdot b \cdot h}{b + h} \text{ [mm]}$$

b: Duct width [mm]
h: Duct height [mm]
Equivalent diameter d_h

d_h for duct fans

w x h [cm]	d_h [mm]
30 x 15	200
40 x 20	260
50 x 25	330
60 x 30	375
60 x 35	400
70 x 40	500
80 x 50	600
100 x 50	650

Correction factor for roughness ϵ

$$\Delta p_R = \Delta p_{\epsilon=0} \cdot \text{Corr. factor}$$

Pressure loss in moulded parts e.g. bends, branches, cross-section changes

$$\text{B) } \Sigma \Delta p_F = \Delta p_{F1} + \Delta p_{F2} + \dots \text{ [Pa]}$$

$$\Delta p_F = \zeta \cdot \frac{\rho}{2} c^2 \text{ [Pa]}$$

$\Delta p_{F1,2,\dots}$: From the diagrams Figures 12-15 [Pa]
Equivalent diameter c: Flow velocity [m/s]
 ζ : Pressure loss coefficient

Resistances of aggregates

$$\text{C) } \Sigma P_{Agg} = \Delta p_{Agg1} + \Delta p_{Agg2} + \dots \text{ [Pa]}$$

$\Delta p_{Agg1,2,\dots}$: From table 11 or diagram

Dynamic pressure at outlet cross-section of ventilation system

$$\text{D) } p_{d,outlet} = \frac{\rho}{2} c_{d,outlet}^2 \text{ [Pa]}$$

ρ : Air density [kg/m³]
(air 20 °C, 1013 mbar = 1.2 kg/m³)
c: Flow velocity [m/s]

Figure 10 Duct friction losses

Δp [Pa/m] (roughness $\epsilon = 0$), \dot{V} [m³/h], c [m/s], d [mm]

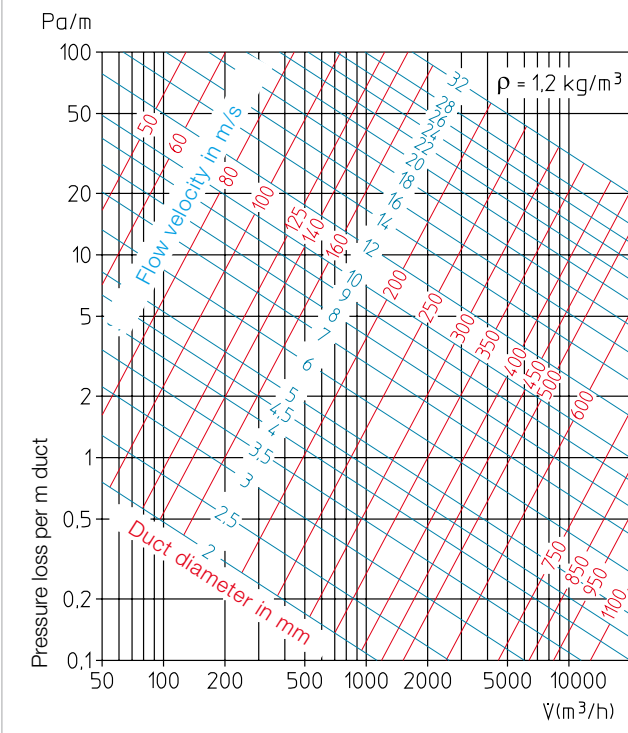

Correction factor for roughness ϵ of different pipes/ducts

Folded sheet metal ducts	1.5	Wooden ducts	1.5
Flexible hoses	7.0	Concrete ducts	2.0
Fibre cement	1.5	Brick-lined ducts	3.0

Table 11 Resistances of aggregates
(for rough calculation)

Aggregate / Component	Flow resistance Δp Aggregate [Pa]
Ventilation grilles, automatic shutters, weather protection grilles*	20 – 40
Helios VK shutters*	10 – 20
Heating elements, heat exchangers*	100 – 150
Filters clean*	40 – 60
Filters contaminated*	250 – 300
Silencers*	40 – 80
Disc valves*	10 – 200
Cyclones	500 – 750

*See product page for exact values.

Dynamic pressure at fan outlet cross-section

$$\text{E) } p_d = \frac{\rho}{2} \cdot c_a^2 \text{ [Pa]}$$

ρ : Air density [kg/m³]
(air 20 °C, 1013 mbar = 1.2 kg/m³)
c: Flow velocity [m/s]

Total resistance calculation

$$\Delta p_{tot} = \text{A} + \text{B} + \text{C} + \text{D} - \text{E} \text{ [Pa]}$$

E: Amount E is only taken into account for systems with pressure-side duct connection to the fan.

Resistances of moulded parts

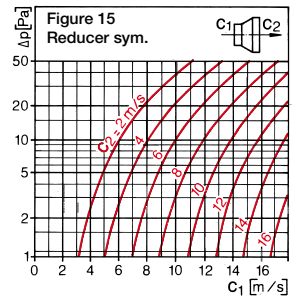
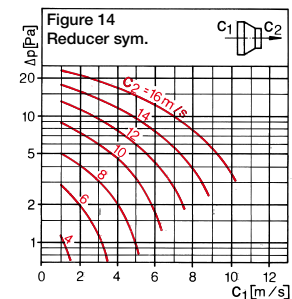
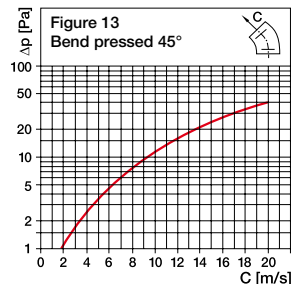
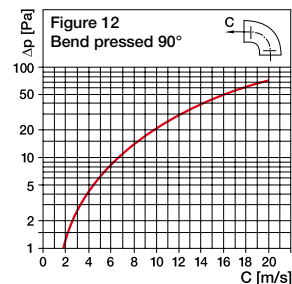

Auxiliary value Flow velocity

$$c = \frac{\dot{V}}{A \cdot 3600} \text{ [m/s]}$$

A: Flow cross-section [m²]
V: Volume flow [m³/h]

Fan parameters

Volume flow V [m³/h, m³/s]
 Total pressure increase $\Delta p_{tot} = \Delta p_{fa} + p_d$ [Pa]
 Static pressure increase $\Delta p_{fa} = \Delta p_{tot} - p_d$ [Pa]
 Dynamic pressure $p_d = \rho/2 \cdot c^2$ [Pa]
 Shaft power P_w [W, kW]
 Elec. consum. power P [W, kW]
 Sound power/pressure level L_{WA}, L_{pA} , [dB(A)]

These values have been determined on an inlet-side chamber test rig according to DIN EN ISO 5801. The noise measurements in the reverberation chamber/free field correspond to DIN 45635-1 and DIN EN ISO 3741.

Fan performance curves

The operating characteristics of a fan are presented in the form of a performance curve. The volume flow depending on static pressure (Δp_{fa}) or total pressure (Δp_{tot}) is specified in the performance curve.

Please note for design:

$$\Delta p_{fa} = \Delta p_{tot} - p_d$$

System performance curve

The pressure loss of a system is proportional to the square of the volume flow.

$$\Delta p = k \cdot V^2$$

Operating point

The operating point BP is the point where the system performance curve meets the fan performance curve (Δp_{fa}). The volume flow, which is adjusted in the system, can be seen on the horizontal axis.

Figure 16: The performances of 1~ fans (green) and 3~ fans (blue) are shown in the performance diagram for controllable high-performance axial fans and VAR types. The static pressure can be seen. The velocity line @ is used to determine the flow velocity with corresponding volume flows. The operating point (BP) lies at the point of intersection between the fan performance curve and the system performance curve.

Figure 17: Performance diagram of a speed-controllable fan with volume flows and pressures according to the different voltages.

Figure 18: The volume flow and static pressure can be set to the calculated operating point by changing the angle of the impeller blades (adjustment of the individual blades at standstill) for AVD over Ø 710.

Figure 19: The performance-oriented performance curve graph for the AMD series allows the adjustment of the motor output to the respective project requirements.

Figure 16

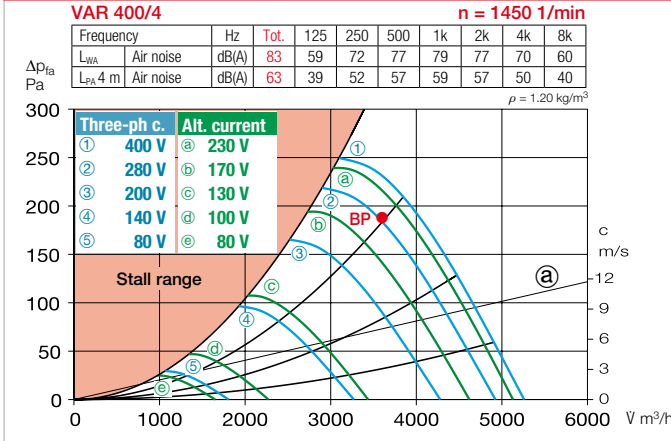

Figure 17

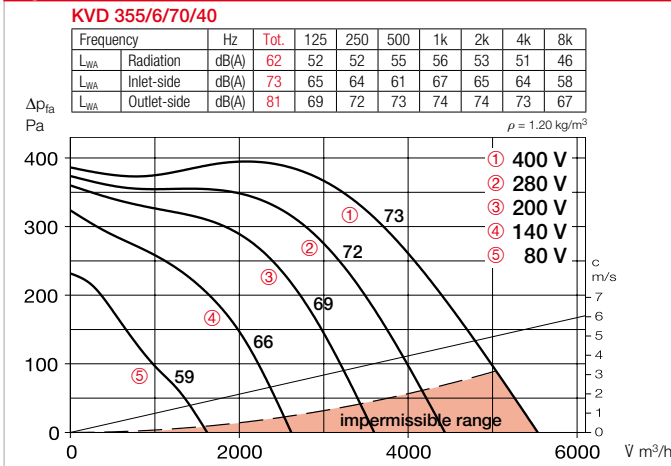

Figure 18

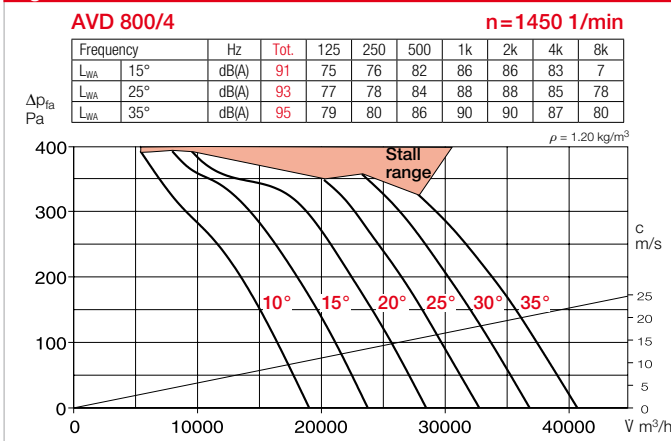
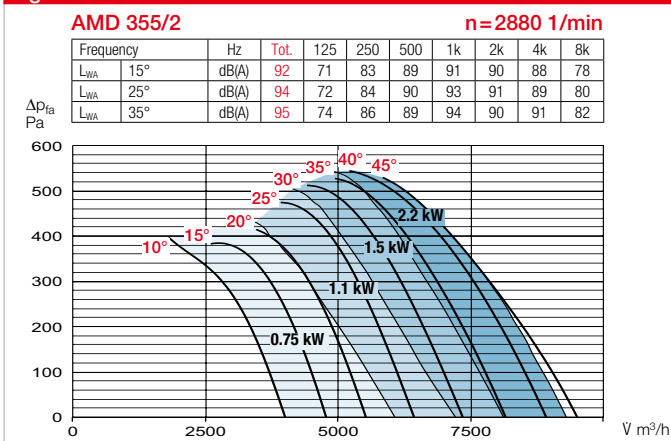

Figure 19



Drive output at the fan shaft

$$P_{W1} = \frac{V \cdot \Delta p_{tot}}{1000 \cdot \eta} \text{ [kW]}$$

Δp_{tot} = Total pressure increase [Pa]
 η = Fan efficiency
 V = [m³/s]

Use of a pole-changeable motor

Pole no.	Volume flow	Pressure	Output
n_1/n_2	$\frac{V_2}{V_1}$	$\frac{\Delta p_2}{\Delta p_1}$	$\frac{P_{W2}}{P_{W1}}$
4/2			
8/4	2	4	8
12/6			
6/4	1.5	2.25	3.38
8/6	1.33	1.78	2.37

Conversions, affinity designations

The performance data for a geometrically similar fan series can be converted depending on speed, diameter and air density.

Speed change:

$$V_2 = V_1 \cdot \frac{n_2}{n_1}; \Delta p_2 = \Delta p_1 \left(\frac{n_2}{n_1} \right)^2;$$

$$P_{W2} = P_{W1} \left(\frac{n_2}{n_1} \right)^3$$

Diameter change:

$$V_2 = V_1 \cdot \left(\frac{D_2}{D_1} \right)^3; \Delta p_2 = \Delta p_1 \left(\frac{D_2}{D_1} \right)^2;$$

$$P_{W2} = P_{W1} \left(\frac{D_2}{D_1} \right)^5$$

Density, temperature change:

$$V_1 = V_2 = \text{const.}$$

$$\frac{\Delta p_2}{\Delta p_1} = \frac{\rho_2}{\rho_1} = \frac{T_1}{T_2}$$

$$\Delta p_2 = \Delta p_1 \frac{\rho_2}{\rho_1} = \Delta p_1 \frac{T_1}{T_2} \text{ [Pa]}$$

$$P_{W2} = P_{W1} \frac{\rho_2}{\rho_1} = P_{W1} \frac{T_1}{T_2} \text{ [kW]}$$

T: Absolute temperature (T = 273+1) [K]

t: Air flow temperature [°C]

Index 1: Initial state

Index 2: Changed state

Use of a fan at a greater geodetic height

Air density

$$\rho = \frac{p_a \text{ [hPa]} \cdot 100}{R_i \cdot T} \text{ [kg/m}^3\text{]}$$

p_a : Air pressure [hPa, mbar]

R_i : Gas constant (Air: 287 J/(kgK))

■ **Explosion protection according to Directive 2014/34/EU (ATEX)**

- Helios explosion-proof fans for operation in potentially explosive atmospheres or for the transportation of potentially explosive gas, vapour and air mixtures in compliance with the requirements of Directive 2014/34/EU (ATEX).
- The fans obtain the markings according to ④.

■ **Zoning, unit groups, categories ①**

□ **Zoning**

Potentially explosive atmospheres are determined according to Directive 1999/92/EC, the Ordinance on Industrial Safety and Health (BetrSichV) and the Ordinance on Hazardous Substances (GefStoffV). The zones should be determined by the operator and it shall be their responsibility. In cases of doubt and special cases, the supervisory authority can also make the determination. Potentially explosive atmospheres are divided into zones according to the probability of the occurrence of hazardous explosive atmospheres as a basis for the assessment of the requirements to be met.

□ **Unit groups**

Unit group I: Use in underground operations and above-ground facilities, which can be endangered by firedamp and combustible dust.

Unit group II: Use in all other areas which can be endangered by explosive atmospheres.

□ **Unit categories**

- 1 – Extremely high degree of safety.
 - 2 – High degree of safety.
 - 3 – Normal degree of safety.
- The categories in unit group II are followed by the letters G for gases and D for dust.
- The explosion-proof fans by Helios correspond to unit group II, category 2G or 3G (see product-specific info) for operation in zone 1 or 2 and they meet the essential health and safety requirements when professionally installed.
 - All binding information can be found on the motor type plate. This also includes the tE time for the motor protection circuit breaker according to DIN EN 60079-0 / VDE 0170 / 0171 or DIN EN 60079-10-1 / VDE 0165-101.
 - The relevant regulations must be observed for connection.
 - Special designs, abnormal voltages, ignition protection types “d”, “pressure-resistant enclosures” are possible on request.
 - Vibration monitoring is required for certain types according to DIN EN 14986.

■ **Ignition protection type ②**

□ **Designation:**

- “e” – Increased safety
- “d” – Press.-resist. enclosure
- “de” – Press.-resist. enclosure with subgroup “e”
- “c” – Constructional safety
- “h” – Constructional safety acc. DIN EN ISO 80079-36/-37

Ignition protection type “e” or “de” is normally used for fan motors with connection boxes.

□ **Explosion group ②**

Additional subdivisions: I = firedamp protection or II = explosion protection. The explosion groups are divided into IIA, IIB and IIC. The hazard level of the gases increases from IIA to IIC. For example, operating equipment which is approved for IIB can also be used for explosion group IIA. In accordance with EN 14986, fans may only be operated with gases from explosion groups IIA and IIB (except hydrogen H2 from explosion group IIC, provided the fan type plate has the marking IIB+H2).

■ **Ignition temp., surface temp. and temperature classes ②, ③**

- The ignition temp. ③, i.e. the temperature at which heat ignition can occur, e.g. due to a hot equipment surface, depends on the type of occurring gases or vapours. The max. surface temp. of el. equipment must always be lower than the ignition temp. of the gas or vapour mixture in which it is used (DIN EN 60079-0 / DIN EN 60079-10-1).
- In order to easily identify and select electrical equipment in unit group II with regard to its max. surface temp., multiple temp. classes are distinguished. Accordingly, the gases can be allocated to these classes by their ignition temperature. Equipment in a higher temp. class (e.g. T5) is also permitted for applications in lower temp. classes (e.g. T2, T3).
- The temperature class, the maximum permissible surface temp, and ignition temp. can be found in the relevant tables ②, ③.
- The temperature class is marked on the respective catalogue page; binding information can be found on the motor type plate.

■ **Operation**

- Explosion-proof motors in ignition protection type “e” (increased safety) do not have thermal contacts. Explosion-proof duct fans, roof fans, high-performance axial fans and VAR fans with higher output are equipped with PTC thermistors.

① **Zoning, unit groups and unit categories**

Flamm. substance	Zone DIN EN 60079-10-1	Explanations	Unit group	Unit category
Gases, vapours, mist	Zone 0	Areas in which hazardous explosive atmospheres are present constantly or long term.	II	1G
	Zone 1	Areas in which it is expected that hazardous explosive atmospheres occur occasionally.	II	1G or 2G
	Zone 2	Areas in which it is expected that hazardous explosive atmospheres occur only rarely and then only briefly.	II	3G, 2G or 1G
Dust	Zone 20	Areas in which hazardous explosive atmospheres are present long-term or frequently	II	1D
	Zone 21	Areas in which it is expected that hazardous explosive atmospheres occur occasionally due to whirling up of deposited dust.	II	2D or 1D
	Zone 22	Areas in which hazardous explosive atmospheres do not normally occur in the form of flammable dust in the air, or only briefly.	II	3D

② **Safety-related figures for flammable gases and vapours**
Ignition temperature, temperature class, explosion group

Substance name	Ignition temp. °C	Temperature class	Explosion group
Acetaldehyde	155		T4 II A
Acetone	535	T1	II A
Acetylene	305	T2	II C
Ethane	515	T1	II A
Ethyl acetate	470	T1	II A
Ethyl ether	175		T4 II B
Ethyl alcohol	400	T2	II B
Ethyl chloride	510	T1	II A II B
Ethylene	440	T2	II B
Ethylene oxide	435 auto-degrad.	T2	II B
Ethyl glycol	235	T3	II B
Ammonia	630	T1	II A
i-Amyl acetate	380	T2	II A
Benzene, petrol	220 to 300	T3	II A
Industrial spirit	220 to 300	T3	II A
Benzene (pure)	555	T1	II A
n-Butane	365	T2	II A
n-Butyl alcohol	325	T2	II B
Cyclohexanone	430	T2	II A
1,2-Dichlorethane	440	T2	II A
Diesel	220 to 300	T3	II A
Jet fuel	220 to 300	T3	II A
Acetic acid	485	T1	II A
Acetic anhydride	330	T2	II A
Heating oil EL	220 to 300	T3	II A
Heating oil L	220 to 300	T3	II A
Heating oil M and S	220 to 300	T3	II A
n-Hexane	230	T3	II A
Carbon monoxide	605	T1	II A
Methane	595	T1	II A
Methanol	440	T2	II A
Methyl chloride	625	T1	II A
Naphthalene	540	T1	II A
Oleic acid	250 auto-degrad.	T3	**
Phenol	595	T1	II A
Propane	470	T1	II A
n-Propyl alcohol	385	T2	II B
Carbon disulphide	95	T6	II C
Hydrogen sulphide	270	T3	II B
City gas (illuminating gas)	560	T1	II B
Tetralin (Tetrahydronaphthalene)	390	T2	**
Toluene	535	T1	II A
Hydrogen	560	T1	II C

* Extract from “Safety-related figures” tables, vol. 1: Flammable liquids and gases, Physikalisch-Technische Bundesanstalt, Brunswick, by E. Brandes/W. Möller. ISBN 3-89701-745-8.
** The explosion group for this substance has not yet been determined.

③ **Temperature class, surface temp. and ignition temperature**

Temperature class	Max. permissible surface temperature of equipment	Ignition temp. of flammable substances
T1	450 °C	> 450 °C
T2	300 °C	> 300 °C
T3	200 °C	> 200 °C
T4	135 °C	> 135 °C
T5	100 °C	> 100 °C
T6	85 °C	> 85 °C

④ **Marking acc. to EN ISO 80079-38**

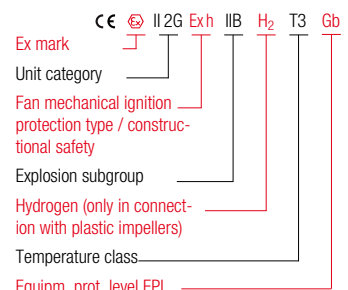

■ Technically perfect solutions are of the utmost importance for Helios. Experience and the consistent further development of ideas and processes mean that Helios products are appreciated around the globe.

The company's continuous research and development is represented in its wide product range, which is the basis for advanced solutions. Helios is also your partner of choice for custom-made products. The combination of state-of-the-art technology with high quality requirements and exemplary design results in major product advantages, such as

- Economical operation due to the high degree of efficiency. Fans and motors are optimally coordinated with each other.
- Maximum reliability, under even the harshest conditions, due to bath impregnation, double-sealed bearings, multiple quality controls, etc.
- Easy performance adjustment through good control characteristics for transformer or electrical speed control.
- Exemplary, aerodynamic design of unit components.
- The Helios fans are among the "quiet runners" due to their low sound values.
- Easy installation and handling, maintenance-free operation, electrical and mechanical safety provide optimal benefits for installers and operators.

■ **Use and operation of fans**

This requires attention to operational influencing factors as well as serviceability and performance, because these have an influence on electrical and mechanical safety. Before using a fan and accessories, the task and the resulting operating conditions must be aligned with the suitability of the fan. Improper use is not compatible with the specified performance features, safety-critical and therefore impermissible.

■ **Motors**

Fan motors occupy a special position. For this reason, Helios itself develops and manufactures a variety of AC motors and especially controllable motors. This guarantees optimal adaptation to special fan drive requirements. The consistent result is special drives which meet the respective requirements of the fan type.

For example, this guarantees:

- Excellent controllability.
- Low current consumption.
- Low maintenance.
- Trouble-free continuous operation, even under harsh conditions.

– Design according to the relevant standards, such as DIN EN 60034 / VDE 0530-1 and DIN EN 60335-1 / VDE 0700-1.

□ **Helios motor design**

- Casings made of aluminium or grey cast iron, completely enclosed, with cooling fins, Protection category: see info on type page.
- Bearings: Maintenance-free (due to sufficient lubricant supply for service life) and dust-tight due to lip seal. Lubrication for temperature range from -40 to +140 °C.
- Moisture-protected winding (tropicalised) as standard in at least insulation material class B.

□ When using other motor brands, the design complies with the relevant standards and guidelines and depends on the manufacturer. Deviating specifications upon request.

■ **Performance data**

Technical information (power, noise, etc.) provided according to DIN 24166 Technical terms of delivery for fans Accuracy class 2 or 3, DIN 44974, pt.1-3 Electric household fans, DIN EN 60335-1 / VDE 0700-1.

□ **Flow rate**

The pressure increase and volume flow can be found in the performance curves on the product pages or the selection tables.

□ The performance data is determined on chamber test rigs according to DIN EN ISO 5801. The **volume flow \dot{V}** , **pressure increase Δp_{fa}** in the installation type A (free intake, free discharge) are measured. The **total pressure increase Δp_{tot}** in the installation type A (free intake, free discharge) are measured p_d .

□ Round duct fans and rectangular duct fans are measured with inlet nozzles and downstream pipe or duct pieces with the approximate length of the hydraulic diameter. In case of deviating installation conditions (barriers, bends, etc.), a reduction in performance must be expected.

□ The presented **performance curves** refer to an air density $\rho = 1.2 \text{ kg/m}^3$ and the speed specified in the graph (rated speed). The actual speeds of individual fan types may vary and they can be found in the assigned tables. The specified flow velocity c and the dynamic pressure p_d refer to the respective outlet cross-section (pipe, duct cross-section).

□ **Electrical performance data**

The type tables show the voltage, frequency, power consumption, total input power or rated motor power, protection category and a reference to the necessary wiring diagram. The information refers to standard operating conditions (Density $\rho = 1.2 \text{ kg/m}^3$, Temperature $T = 20 \text{ °C}$, mains frequency 50 Hz). The actual values may vary within the permissible tolerances due to operational or environmental factors. The information on the rating plate of the unit used is definitive for the electrical system design. In case of deviating environmental conditions, especially low temperatures, increased current and power values must be expected. This must be taken into account when designing the electrical power supply (cables, contactors, protection devices). In case of doubt, please contact us.

□ **Noise data**

Information on noise emissions is specified in the performance curves and type tables as A-weighted sound power levels and/or sound pressure levels at a specified distance (normally 1 m or 4 m). The sound pressure levels are valid for noise radiation under free field conditions and they are influenced by different radiation conditions. The values refer to the design described in the "Performance data" section and they comply with DIN 24166. Different installation conditions and disrupted inlet or outlet flows may result in considerable noise increases.

The **sound pressure level** perceived by the human ear at a certain distance from the

noise source is always less than the sound power level and it depends on the distance from the noise source and the environmental conditions.

■ **Electrical connection**

The type table shows the wiring diagram to be used for the connection; it is included with every fan. Every fan must be connected according to the relevant provisions and local regulations and have all-pole protection against overloading, phase failure, etc. at all speeds with a motor protection circuit breaker or using built-in thermal contacts and a motor protection device. The information on the rating plate is definitive for the selection of a motor protection circuit breaker. Non-compliance with these provisions can result in malfunctions and release us from any warranty claims.

■ **Classification of air filters – VDMA guideline**

According to DIN EN 779	According to DIN EN ISO 16890			
	Coarse	ePM10	ePM2.5	ePM1
G1	—	—	—	—
G2	30 % – 50 %	—	—	—
G3	45 % – 65 %	—	—	—
G4	60 % – 85 %	—	—	—
M5	80 % – 95 %	40 % – 70 %	10 % – 45 %	5 % – 35 %
M6	> 90 %	45 % – 80 %	20 % – 50 %	10 % – 40 %
F7	> 95 %	80 % – 90 %	50 % – 75 %	40 % – 65 %
F8	> 95 %	90 % – 100 %	75 % – 95 %	65 % – 90 %
F9	> 95 %	90 % – 100 %	75 % – 95 %	65 % – 90 %

M5 to F9 based on Eurovent Recommendation 4/23 (2017).

DIN EN ISO 16890 has superseded standard EN 779:2012 in Germany and Europe.

Filter classes G (for coarse filters), M (for medium filters) and F (for fine filters) are affected.

The most important differences from EN 779 are the consideration of a broader particle spectrum, the division into groups with additional specification of filtration efficiency instead of classes, the consideration of the minimum filtration efficiency and the use of test aerosols instead of synthetic ASHRAE test dust.



Motor protection for AC motors

All 1~ motors are equipped with thermal contacts as standard. These are partly wired in series to the winding and partly to the terminal block.

The majority of controllable 3~ motors (except explosion-proof versions) are also equipped with external thermal contacts.

Motors with thermal contacts whose connections are made to the terminal block

Motor protection circuit breakers (see accessories) or so-called triggering devices must be used for correct connection. These must be connected to the stranded wires marked with "TK" in accordance with the wiring diagram. In case of an impermissibly high winding temperature increase (e.g. caused by tight bearings, blocking of the impeller, insufficient cooling, excessively high air flow temperature, 2-phase operation), the circuit breaker will disconnect the motor from the mains power supply. The motor must be recommissioned through manual activation. In case of recurrence, the cause of the fault must be determined. This solution offers comprehensive motor protection, even in control mode. It requires the motor to be equipped with "external" thermal contacts. Most Helios 1~ and 3~ fans are equipped with these as standard (see type table information). It is usually possible at an extra charge for other types.

Motors with thermal contacts "connected in series"

The majority of low power Helios 1~ fans (see type table information) are equipped with thermal contacts which are internally wired to the winding. These react to impermissible temperature increases in the motor and break the circuit. They automatically reactivate after cooling down. The thermal contact response indicates the existence of a cause of a fault (sluggishness, contamination, excessive air flow temperature). This cause must be determined and eliminated before further operation.

Motors with built-in PTC thermistors

These motors are preferred for higher outputs with rapid temperature increases and difficult operating conditions. In order to guarantee comprehensive protection, every winding phase should be equipped with a PTC thermistor temperature sensor (upon order at an extra charge; comes as standard for higher power explosion-proof rectangular duct fans and roof fans as well as high-performance axial fans and VAR fans. See type table information). These sensors are temperature-depen-

dent resistors. Their resistance increases sharply once the nominal response temperature is reached. A special triggering device (Type MSA, see accessories) must be used for their connection.

Motors without thermal overload protection

These motors can be protected by overcurrent motor protection circuit breakers with bimetal relays. These are installed in the mains supply line. However, this solution does not protect speed-controlled fans against impermissibly high air flow temperatures and insufficient motor cooling. Every speed must be adequately protected for pole-changing motors.

Air flow temperatures

The standard version can be used in the range from -30 °C to at least +40 °C, but also higher in the short term (except explosion-proof fans). Versions for higher continuous temperatures are specified in the type tables or possible in the area of custom production.

Control mode

Speed-controlled operating mode causes higher motor self-heating. The max. air flow temperature specified in the type table should be reduced by 10 °C, if necessary.

Flow medium

The standard version is designed to transport normally contaminated, non-aggressive and normally humid air. In case of different operating conditions, please contact us.

Contact protection

Some fans are equipped with protection grilles according to DIN EN 60335-1 / VDE 0700-1 or DIN EN ISO 13857. Additional protection devices may be necessary depending on the installation conditions. The installers and operators are responsible for complying with safety regulations.

The applicable occupational safety and accident protection guidelines as well as contact protection according to DIN EN ISO 13857 must be observed during installation. Contact with rotating parts must be prevented. It must be ensured that there are no loose substances in the intake area. Fans which are protected by their installation type (e.g. installation in ventilation duct or closed aggregates) do not require a protection grille if the system provides sufficient safety. Please note that the installer can be held liable for accidents as the result of the lack of protection devices. Suitable

protection grilles are available as accessories.

Explosion protection according to Directive 2014/34/EU (ATEX)

Helios explosion-proof fans are delivered in line with the requirements of Directive 2014/34/EU.

Helios explosion-proof fans are suitable for:

- operation in potentially explosive atmospheres.
- transporting potentially explosive gas, vapour and air mixtures.

The declaration of conformity enclosed with the explosion-proof products confirms compliance with the requirements according to ATEX Directive 2014/34/EU.

The standard motors in our explosion-proof fans correspond to ignition protection type "e" (increased safety). Use in zone 1 and 2. Unit group II, category 2G and 3G.

The mechanical parts of the explosion-proof fans meet the requirements of DIN EN 14986.

The motor protection circuit breaker must be selected and configured according to VDE 0165, DIN EN 60079-0 or DIN EN 60079-10-1.

The t_E time can be found on the motor type plate.

Speed control is only permissible for specific types in connection with the triggering device MSA.

Depending on the selected motor brand, the electrical data may vary from the catalogue information on the product page. The type plate data must be requested for designing potential control units.

Special versions, abnormal voltages and ignition protection type "d" (pressure-resistant enclosure) are possible upon request.

IP protection categories

These categories determine the protection against the intrusion of solid objects (1st clause) or the ingress of water (2nd clause):

- IPX4 – Protection against spray water from any direction.
- IPX5 – Protection against jet water from a nozzle from any direction.
- IP4X – Protection against solid foreign objects > 1 mm.
- IP5X – Moderate protection against dust.

Test marks – Approvals

Helios units have a high quality standard and their designs comply with national and international standards. They also comply with the provisions of the German Machine Safety Law and those of the trade associations. Various products are subject to third-party production monitoring by the TÜV, VDE and the Research and Material Testing Institute of Baden-Württemberg, Otto Graf Institute. Accordingly, various unit series have the following marks:

	VDE approval from VDE test centre
	SEV mark of conformity, Switzerland
	Test mark of the Austrian Electrotechnical Association
	DEMKO safety mark of the Danmarks Elektriske Materielkontrol
	SEMKO safety mark of the Svenska Elektriska Materielkontrollanstalten
	NEMKO safety mark of the Norges Elektriske Materielkontroll
	M.E.E.I. safety mark of the MAGYAR ELEKTROTECHNIKAI ELLENORZO INTEZET, Hungary
	Safety mark of the STAVEBNÍHO INŽENÝRSTVÍ, Czech Republic
	Safety mark of the DRŽAVNI ZAVOD ZA NORMIZACIJU I MJERITELJSTVO, Republic of Croatia
	Safety mark of the Institut Ukrmetrestandard, Ukraine
	Safety mark of the Federal Association for Agricultural Employer's Liability Insurance
	Production monitoring mark of the Material Testing Institute Stuttgart University and TÜV SÜD
	Technical approval from the German Institute for Structural Engineering
	Explosion protection according to ATEX Directive
	EU – Conformity mark
	Protection category IPX4
	Protection category IPX5
	Protection class II

Design

The innovation and functionality in relation to the product design of various Helios fans are confirmed by:

DESIGN AWARD 2021	reddot design award winner 2008	GERMAN DESIGN AWARD WINNER 2021

■ **Power control by AC motor speed change**

The demand for power control for ventilation systems and air conditioning systems is based on several factors.

- To meet comfort requirements.
- To guarantee an operating mode that adapts to changing requirements (change in room occupancy, air deterioration, temperature change, etc.).
- To perform economical operations.

Fan power control by speed control represents the best solution in terms of energy requirements and noise levels. The impeller power requirement reduces by the cube of the speed, i.e. when the speed is halved, the power requirement drops to one eighth of the value at full speed.

$$\frac{P_L}{P_{L,0}} = \left(\frac{n}{n_0}\right)^3$$

The power reduction amount left as energy cost savings is strongly dependent on the characteristics of the drive motor and the speed control unit.

Helios motor characteristics are specifically adapted to the power requirement of the impeller. This guarantees optimal efficiency levels in rated load operation and control mode.

■ **Control units**

One or more fans (until the max. rated current is reached) can be operated with the available speed control units. The maximum possible current for control (see type table information) must be taken as a basis when dimensioning instead of the rated motor current. In case of doubt, there should be 20 % reserve capacity.

□ **Frequency inverter**

There are four different frequency inverter series in the following versions "Basic", "Basic Sine", "Comfort" and "Comfort Sine" for controlling the speed of 3~motors. All frequency inverters are specifically adapted to the properties of the Helios fans. When using different brands, specific fan versions are required (please contact us). The "Basic" frequency inverter types are designed for easy speed control in connection with speed potentiometers (accessories) or for speed control in connection with electronic control units (accessories). With regard to the "Comfort" series, the control parameters are set via a display and operating keys, or

even more conveniently via the integrated Modbus. They are equipped with a full-featured controller for controlling temperature, pressure and air velocity, and the required sensors are available as accessories. The frequency inverter capability shall be specified when ordering the fan for product series without sine filters.

FU "Basic" and FU "Comfort" are suitable for the operation of an individual frequency inverter-capable fan, and the shielded cable length between the frequency inverter and fan should not exceed 10 metres.

"Basic Sine" and "Comfort Sine" are suitable for the parallel operation of multiple fans in series (up to max. current) and they do not require additional EMC measures in the customer-side wiring.

The use of third-party controller brands can lead to functional problems and motor/controller defects.

When using such units (not approved by Helios), any warranty and liability claims shall be void.

- **Electronic speed control units**, which function on the basis of the phase control principle, can generate motor humming noises which may be perceived as disturbing in the lower speed/voltage range. Transformer control units which do not generate noise should therefore be used in noise-critical applications.

■ **Comparison of different control concepts**

1. Speed control
2. Throttling or bypass
3. Activation/deactivation
4. Guide/rotor blade adjustm.

The adjacent diagram shows the major advantages of controlling the speed in comparison to other solutions commonly used in practice.

Helios fans are power-controllable through voltage reduction, frequency conversion or pole-changeable motors with two speeds. The suitable unit ranges are offered as accessories on the "MCR Measure – Control – Regulate" pages.

■ **Fan parameter behaviour during speed control**

Another advantage of speed control lies in the distinct noise reduction. The noise level reduction can be up to

$$\Delta L \approx 50 \text{ Lg} \left(\frac{n}{n_0}\right) \text{ dB}$$

(no: rated speed)

and it is thus particularly suitable for the night operation of ventilation and air conditioning units.

Example: When the speed is halved, the noise level reduces by up to 15 dB.

The diagram schematically shows how the volume flow, pressure loss, power requirement and noise level parameters behave during speed control.

■ **Speed-controllable types**

are marked as such on the product pages. Suitable speed control units can be found in the type table. Models which are not approved for control mode may only be operated at rated speed.

■ **Warranty conditions, delivery conditions, guarantee**

The warranty period is 12 months from the delivery date. The scope of the warranty is defined in the Helios delivery conditions. Changes made to the units, interference or non-compliance with the relevant Installation and connection provisions shall release Helios from any warranty obligations. All information in this catalogue is entirely non-binding and can be changed without prior notice.

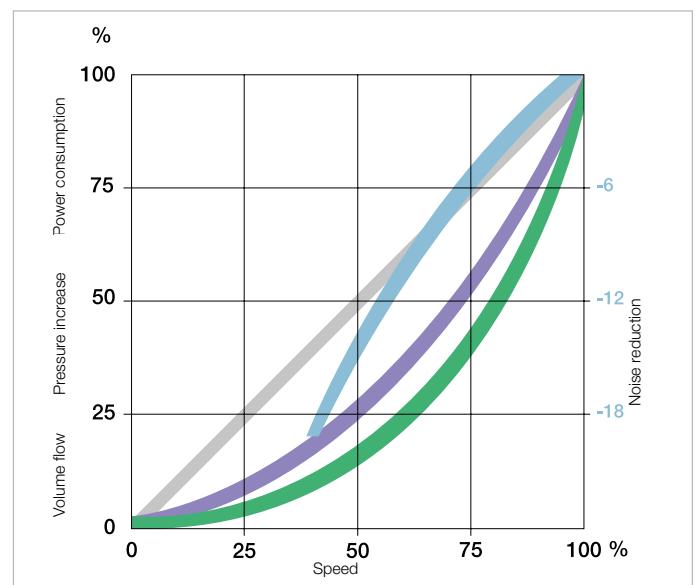
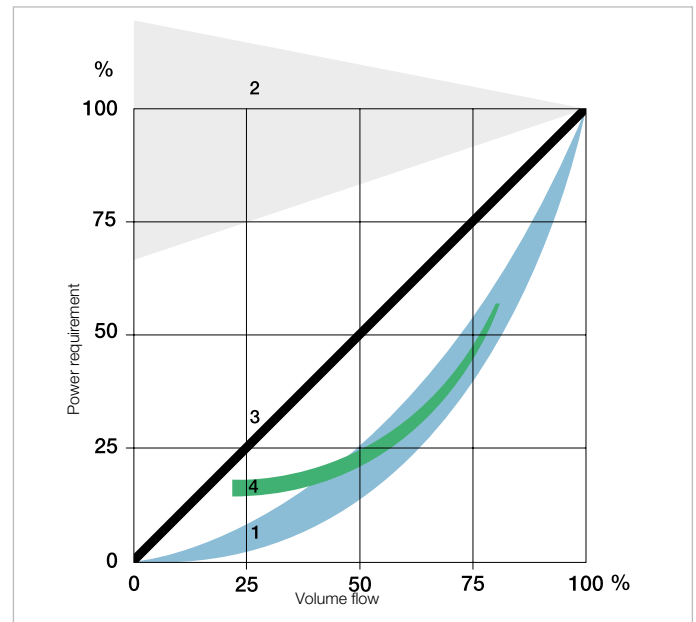

EC technology



EC technology

EC drive technology is increasingly used in fan technology, since EC motors (EC = electronically commutated) offer significant advantages in comparison to AC drives (AC = alternating current). An AC motor runs according to its number of pole pairs and mains frequency (normally 50 Hz) and the resulting static rotating field depending on slip.

Example for a 2-pole motor, 50 Hz:
50 Hz x 60 sec. / pole pair
– 5% slip
= 2850 revolutions / min.

- In contrast, the EC drive is a brushless direct current motor, designed as an external rotor motor. With regard to this motor type, the magnetic field is generated by a ring-shaped permanent magnet in the rotor. The laminated stator core with the coils is (unlike conventional collector motors) fixed to the motor bearing cover and does not rotate. The angular position of the permanent magnet in the rotor is detected by three hall sensors and evaluated by electronics integrated in the motor. Based on the angular position of the rotor and the desired direction of rotation, the corresponding coils are energised by the electronics to generate the required torque. The entire process takes place without wear and tear and spark formation. Thanks to the commutation, there is no wear on the motor and the ball bearing is the only remaining wear part. Permanent magnets form the magnetic poles and the mains frequency is of no importance in this respect. Depending on the desired maximum speed, the motor winding is alternately powered with a defined switching frequency.
- This means that continuously variable, almost linear control is possible over the entire speed range (see Figure 1).

Figure 1

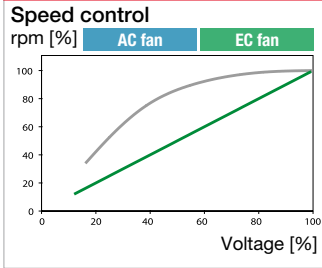
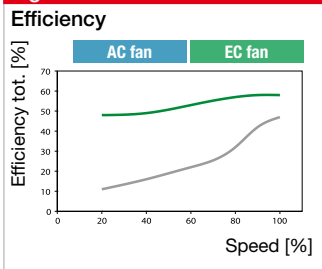

Figure 2



- The use of modern, energy-efficient EC drive technology results in significantly higher fan efficiencies (see Fig. 2), since there are almost no losses due to iron, copper and slip in EC motors.
- EC fans are also wear-free and maintenance-free and they are characterised by low-noise operation. EC motors make no brush noises whatsoever and they are virtually silent (except for low air flow noises). The disrupting magnetisation humming made by AC motors is eliminated. The end result is that EC motors are always quieter than comparable collector motors.

Energy conservation

Ventilation technology fans are usually designed for the "worst case" scenario. I.e. the fans are designed for the maximum expected flow rate. However, this operating condition is very rare in practice. Ventilation and air conditioning systems are normally demand-oriented. The ventilation requirement is determined based on various parameters (e.g. air temperature, humidity, CO2 content, etc.) and the required supply air volume flow is derived from these parameters. In concrete terms, the fans must therefore be reduced to partial load operation using control or regulating devices.

- Due to its significantly higher motor efficiency, the EC fan has considerable energy-related benefits in full-load operation in comparison to its AC counterpart. These are even more obvious in partial load operation. While the EC motor losses remain almost the same even at reduced speeds, the AC motor losses increase considerably at

lower speeds.

- With regard to specific applications, EC motors have considerable energy-saving potential and thus the potential for operating cost-savings due to their improved partial load performance.

Figure 3

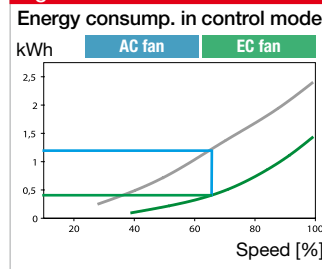

- Thanks to the energy-efficient EC technology, energy savings of more than 50 % are achieved in speed-controlled operation in comparison to conventional AC technology (see Figure 3). Overall, it should be noted that the necessary control and regulating devices for EC technology have considerably lower investment costs.

Controllability / Partial load performance

- The advantages of EC technology are obvious, particularly in partial load operation. While standard AC motors can be controlled by step transformers or phase control in partial load, the control components for EC motors are already integrated in the commutation electronics. This means only one 0-10 V control signal (speed potentiometer) is required for speed control.
- The electronics integrated in the motor enables additional control variants such as pressure or volume flow stabilisation control. Cost-effective universal control units are available for this purpose. The EC motor is set apart by its almost proportional performance curve, % voltage = % speed, and conversely the AC motor is significantly less favourable. With regard to controllability, AC motors are improved by so-called "softening". A "soft AC motor" is a synonym for a motor with high slip (speed difference between stator and rotor). However, a simultaneous reduction in motor efficiency caused by the optimisation of controllability must be taken into account.

Advantages of EC technology

- Maximum efficiency levels, especially in control mode.
- Up to 30% energy savings in full-load operation and more than 50% in partial load operation.
- Short amortisation.
- Continuously variable, almost linear control behaviour.
- Simple and cost-effective control using speed potentiometer.
- Integrated control electronics (0–10 V signal) save on lossy, expensive solutions such as transformer or phase control.
- Integrated electronic temperature monitoring.
- Low-noise, smooth operation without magnetisation humming.
- Universally applicable for the mains voltage range 200–270 V or 380–480 V as well as in 50 Hz and 60 Hz mains networks.

Performance curve

EC fan control is continuously variable using a simple potentiometer or through continuously variable speed control with a universal control system. For example, the performance curve shows the performance levels depending on the control voltage (e.g. 2, 4, 6, 8, 10 V). Due to the continuously variable controllability, any operating point within the performance diagram is possible. With regard to the free blowing (without system resistances) operating state (except high-performance axial fans), the details for speed (n), (power consumption (P), current consumption (I), sound pressure level (Lp) and specific fan power (SFP) are specified for the respective control voltage below each EC performance curve in table form. With regard to high-performance axial fans, the max. current and max. power consumption are specified.

Cost-effectiveness analysis

In terms of investment costs, ventilation units with AC motors offer a cost advantage which refers exclusively to the fan. As soon as the normally required speed control is included in the analysis, the supposed advantage is quickly balanced out again:

- AC motors are often speed-controlled using more expensive transformer speed controllers or frequency inverters.
- On the other hand, with regard to EC fans, the mains voltage is connected directly to the motor on site and converted to a corresponding DC voltage by the electronics integrated in the motor. Only one control signal (0-10 V) from the setpoint adjuster is required to control the speed. Inexpensive potentiometers are therefore used as field devices.

□ When comparing the total cost of all necessary ventilation investment components, not only do they balance each other out, the cost advantage very often lies with the EC technology.

□ Due to its advantages in terms of efficiency in full-load operation and especially in partial load operation, the EC motor is primarily suitable for installation for long operating periods and changing operating states.

□ The following example using the H.. series illustrates the operating cost advantage of EC technology (see table 1: Cost-effectiveness analysis).

Figure 1 and figure 2 show the electrical power consumption for free blowing operation. Figure 1 represents full-load operation (1400 min⁻¹), figure 2 represents partial load operation (700 min⁻¹).

Speed is shown on the X axis. The power consumption in Watts is shown on the Y axis on the left. The Y axis on the right shows the benefit of EC in comparison to AC in Euros/year with the corresponding partial load and the specified boundary conditions.

Performance curve GBD EC 560

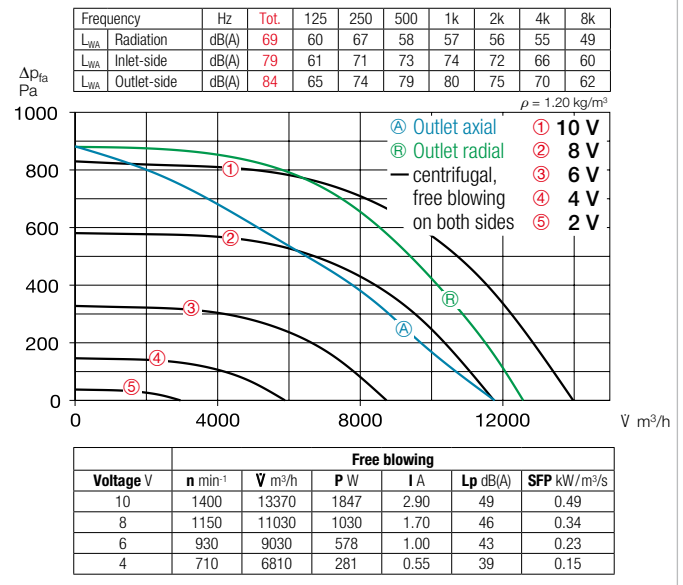

Figure 1: Full-load operation

Calculation based on the following boundary conditions:
Flow rate free blowing. Operation 4 h/day, 365 days/year = 1460 h/year
Electricity rate 0.27 Euros/kWh

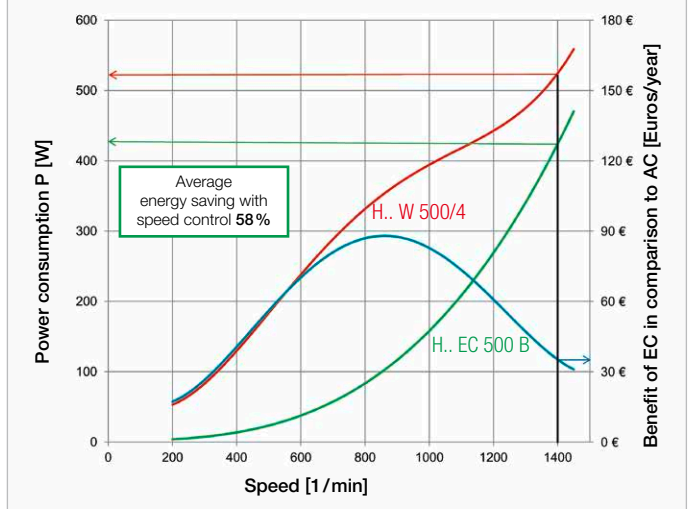

Figure 2: Partial load operation

Calculation based on the following boundary conditions:
Flow rate free blowing. Operation 8 h/day, 365 days/year = 2920 h/year
Electricity rate 0.27 Euros/kWh

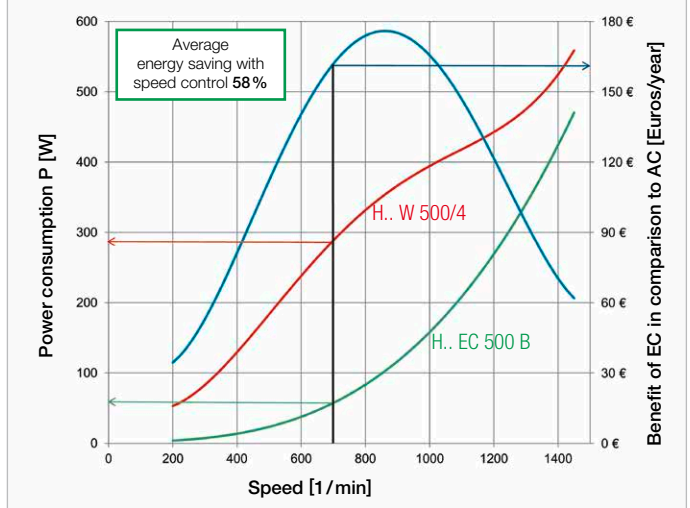

Table 1: Cost-effectiveness analysis

	AC Type H.. W 500/4	EC Type H.. EC 500 B	Saving
Operating mode 1	Full load 100 %	Full load 100 %	
Electrical power consumption W	525	424	
Operating hours p.a. (at 4h/day)	1460	1460	
Energy consumption kWh/a	767	619	148 kWh/a
Elec. costs p.a. (0.27 Euro/kWh)	207.09 Euros	167.13 Euros	39.96 Euros p.a.
Saving in % p.a.			19.3 %
Operating mode 2	Partial 50 % (140 V)	Partial 50 % (5 V)	
Electrical power consumption W	289	57	
Operating hours p.a. (at 8h/day)	2920	2920	
Energy consumption kWh/a	844	166	678 kWh/a
Elec. costs p.a. (0.27 Euro/kWh)	227.88 Euros	44.82 Euros	183.06 Euros p.a.
Saving in % p.a.			80.3 %
Mixed operation 1 + 2	Mixed operation	Mixed operation	
Energy consumption kWh/a	1611	785	826 kWh/a
Elec. costs p.a. (0.27 Euro/kWh)	434.97 Euros	211.95 Euros	223.02 Euros p.a.
Saving in % p.a.			51.3 %

Small room fans. Premium design with maximum energy efficiency.



MiniVent[®] M1 with ultraSilence[®] technology.

Watertight building envelopes and contaminating environmental influences make mechanical ventilation indispensable nowadays. The traditional ventilation of an apartment or workplace by opening the window is no longer an effective solution and it wastes valuable energy.

The small room fans MiniVent M1 stand for the highest pressure performance, lowest noise levels and maximum energy efficiency.

Two performance levels, jet water protection IPX5 and high-quality long-life ball bearings are standard equipment features with clear added value.

Equipped with Helios ultraSilence technology, MiniVent operates almost silently and consumes around a third less energy than conventional small room fans.

The minimalist premium design stands out in any room with understated elegance. Fully developed and made in Germany, MiniVent guarantees compliance with the highest quality standards.

In addition to MiniVent, Helios offers a wide range of fans for the supply and extract ventilation of living rooms and smaller commercial spaces. The units impress with innovative design and meet the highest technical requirements.

■ Fans for wall installation, ceiling installation and window installation



Also available in version:



22^{ff}

■ Centrifugal fans with outlet connectors Ø 100 mm



32

■ Inline fans



33

■ External wall extract air fans



34^f

■ Window fans



Also available in version:



36^f

■ Ceiling fans



38

■ Heater fans



39^f

■ Controlled domestic ventilation systems

40^{ff}

M1/100



Dimensions M1/100

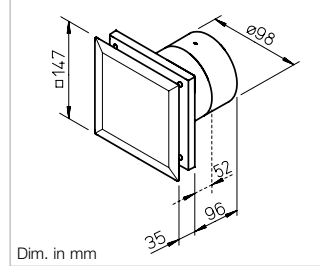

Performance curve M1/100

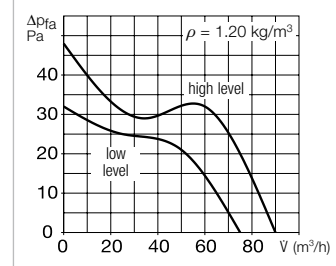

Premium class small room fans. The design and performance of the MiniVent M1/100 set new standards in the field of compact fans.

With its multi-award-winning design, the MiniVent M1/100 blends in harmoniously in all environments. The enclosed, well-designed facade completely prevents viewing of the fan clogging zone.

All M1/100 models come with 2 performance levels and tight-closing backdraught shutters as standard.

The noise level is extremely low thanks to Helios ultraSilence technology.

Available with turn-off delay mode and interval mode or barrier-free automatic functions, such as the presence detector or humidity control function. The humidity control function responds to the rate of humidity increase with intelligent electronics and effectively prevents mould formation.

Universally applicable for the ventilation of bathrooms, WCs and other small rooms.

Features

- Extremely low power consumption of just 5 Watts at $\dot{V} = 75 \text{ m}^3/\text{h}$.
- Ultra quiet thanks to ultraSilence technology; just 25 dB(A) at $\dot{V} = 75 \text{ m}^3/\text{h}$.
- Pressure performance: $60 \text{ m}^3/\text{h}$ volume flow at 31 Pa resistance. $90 \text{ m}^3/\text{h}$ free blowing, ΔP max. 45 Pa.
- In case of restricted space conditions, the M1/100 guide wheel can be easily removed. This reduces the installation depth from 96 to just 52 mm.
- Compact dimensions for universal flush-mounted installation in walls, shafts and ceilings with NW 100.
- All parts are made of high-quality plastic, colour: white.
- Ball bearings and motor are designed for continuous loads, constant output and lifelong functional reliability.
- Motor with thermal overload protection, maintenance-free and radio interference-free.
- Applicable in wet room zone 1 according to DIN VDE 0100-701.
- Electrical supply line can be surface or flush-mounted.
- Practical quick installation due to screwless connection terminals.

Type	M1/100	M1/100/N/C	M1/100 F	M1/100 P
Ref. no.	06171	06172	06175	06174
Version	Standard model with two speed levels	Like M1/100, with codeable turn-off delay & interval model ¹⁾	Like M1/100, with humidity control function ^{1) 4)}	Like M1/100, with presence detector ¹⁾
Turn-off delay time, min. optional at high or low level	—	6, 10, 15, 21 adjustable	6, 12, 18, 24 adjustable ³⁾	6
Interval mode, hours optional at high or low level	—	0, 8, 12, 24 adjustable	—	—
Start-up delay approx. sec.	—	0, 45, 90, 120	0 or 45 ³⁾	—
Inner shutter, removable	Yes	Yes	Yes	Yes
Flow rate free blowing m^3/h	90 / 75	90 / 75	90 / 75	90 / 75
Impeller \varnothing mm	92	92	92	92
Speed min^{-1}	2650 / 2250	2650 / 2250	2650 / 2250	2650 / 2250
Voltage / Frequency 50 Hz	230 V	230 V	230 V	230 V
Power consumption W	9 / 5	9 / 5	9 / 5	9 / 5
Rated current A	0.06 / 0.04	0.06 / 0.04	0.06 / 0.04	0.06 / 0.04
Sound pressure level dB(A) at 3 m ²⁾	30 / 25	30 / 25	30 / 25	30 / 25
Wiring diagram no.	915	917	919	918
Electrical supply line NYM-O in mm ²	3 x 1.5	4 x 1.5	4 x 1.5	3 x 1.5
Protection class II, protection category	IP45	IP45	IP45	IP45
Max. air flow temperature	+40 °C	+40 °C	+40 °C	+40 °C
Weight approx. kg	0.80	0.80	0.80	0.80

¹⁾ All electronic functions optionally adjustable at high or low performance level.

²⁾ Free field conditions.

³⁾ For manual operation.

⁴⁾ Limit value 60, 70, 80, 90 % adjustable.

Beautiful and clean

Air flows into the M1 from all sides. The front facade is completely closed and elegantly conceals the bothersome clogging zone in conventional compact fans.

The M1 blends in harmoniously in all environments. The smooth-surfaced front facade always remains easy to maintain and clean.

Intelligent humidity control function

The humidity control function of type M1/100 F automatically activates the fan depending on the humidity increase rate. The turn-off delay time depends on the room humidity reduction. In case of constantly high humidity, the fan will automatically switch to interval mode.



Rapid connection

The electrical connection is enormously facilitated by a generously dimensioned, circumferential cable storage space on the back of the unit, the full rotatability of the casing and screwless terminals.

Long-life ball bearings for 40.000 operating hours allow installation in any position, even directly in the ceiling.

Flexible installation depth

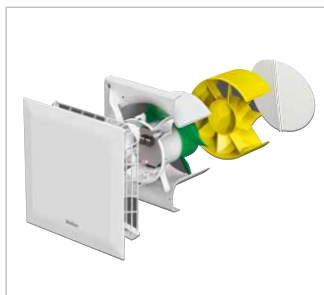
The removeable guide wheel reduces the installation depth from 96 to 52 mm. Installation possible with or without backdraught shutters.

Applicable in wet room zone 1

MiniVent M1/100 complies with jet water protection IPX5, insulation protection class II and may be used in zone 1 according to DIN VDE 0100-701.

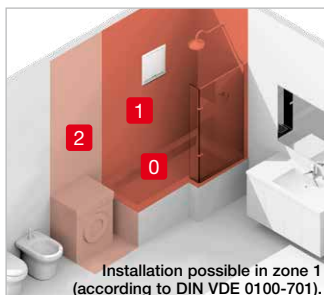

Wall mounting kit

WES 100 Ref. no. 00717

Two telescoping plastic ducts serve as the wall/feed duct; for flush-mounted installation.

External wall connection possible in two ways:

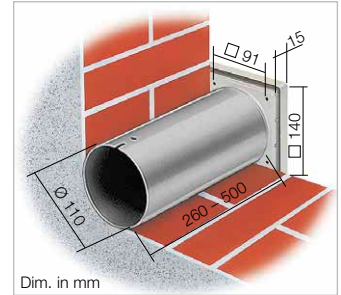
- Frame with three blades as an automatic shutter.
 - Use of the frame with fixed grille.
- All parts made of high-quality plastic.

Telescopic wall sleeve

TWH 100 Ref. no. 06352

Like WES, but without shutter and grille.

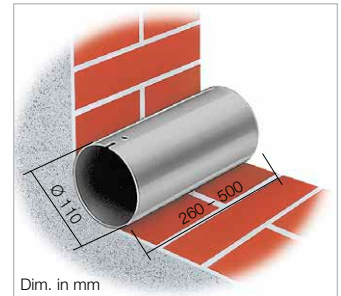
Operating and speed switch
0-1-2 for standard model

MVB Ref. no. 06091

With functions On/Off, low and high speed.

Load capacity 3 A (ind.)
 Voltage 230 V, 1~, 50/60 Hz
 Protection category IP 30
 Installation in standard flush-mounted box
 Dimensions mm W 80 x H 80 x D 15
 Weight approx. 0.1 kg



Mounting panel

MBR 90/160/300 Ref. no. 00281

Made of high-quality, impact-resistant plastic, colour: alpine white. Ideal for use in renovations.

All M1/100 models can be easily installed in existing, rectangular shaft openings with the mounting panel.

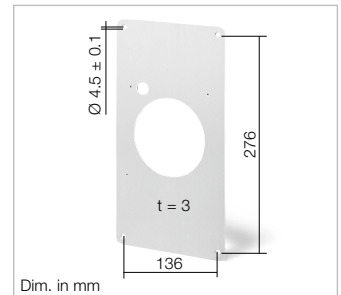
The panel can be fully painted or wallpapered in order to hide it.

Mounting flange

MF 100 Ref. no. 06188

For installation depth reduction in case of thin walls, narrow shafts and short bends. Also suitable for the installation of a drawcord switch (accessories). If required, multiple MF 100 can be connected to each other.

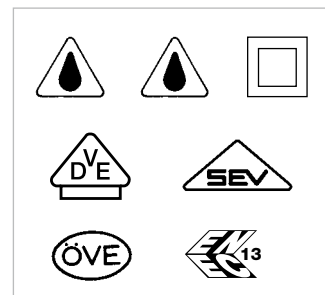
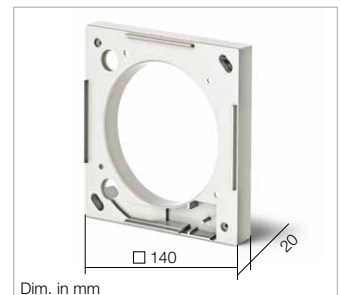

Accessory details Page

Flexible ventilation ducts, roof outlets and ventilation grilles	553 ff.
Intake air elements	578 ff.

M1/120

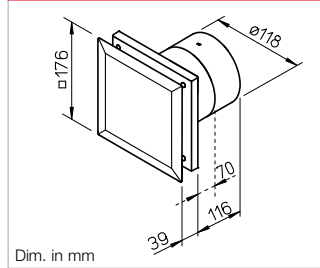

Dimensions M1/120



Performance curve M1/120

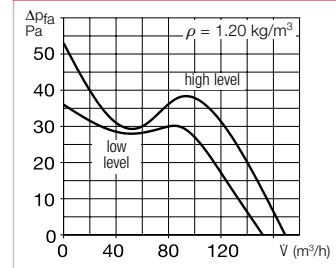

Premium class small room fans. The design and performance of the MiniVent M1/120 set new standards in the field of compact fans.

With its multi-award-winning design, the MiniVent M1/120 blends in harmoniously in all environments. The enclosed, well-designed facade completely prevents viewing of the fan clogging zone.

All M1/120 models come with 2 performance levels and tight-closing backdraught shutters as standard.

The noise level is extremely low thanks to Helios ultraSilence technology.

Available with turn-off delay mode and interval mode or barrier-free automatic functions, such as the presence detector or humidity control function. The humidity control function responds to the rate of humidity increase with intelligent electronics and effectively prevents mould formation.

Universally applicable for the ventilation of small to medium-sized rooms in private, commercial and industrial buildings.

Features

- Extremely low power consumption of just 10 Watts at $V = 150 \text{ m}^3/\text{h}$.
- Ultra quiet thanks to ultraSilence technology; just 32 dB(A) at $V = 150 \text{ m}^3/\text{h}$.
- Pressure performance: $120 \text{ m}^3/\text{h}$ volume flow at 31 Pa resistance. $170 \text{ m}^3/\text{h}$ free blowing, ΔP max. 53 Pa.
- In case of restricted space conditions, the M1/120 guide wheel can be easily removed. This reduces the installation depth from 116 to just 70 mm.
- Compact dimensions for universal flush-mounted installation in walls, shafts and ceilings with NW 120/125.
- All parts are made of high-quality plastic, colour: white.
- Ball bearings and motor are designed for continuous loads, constant output and lifelong functional reliability.
- Motor with thermal overload protection, maintenance-free and radio interference-free.
- Applicable in wet room zone 1 according to DIN VDE 0100-701.
- Electrical supply line can be surface or flush-mounted.
- Practical quick installation due to screwless connection terminals.

Type	M1/120	M1/120/N/C	M1/120 F	M1/120 P
Ref. no.	06360	06361	06364	06363
Version	Standard model with two speed levels	Like M1/120, with codeable turn-off delay & interval model ¹⁾	Like M1/120, with humidity control function ^{1) 4)}	Like M1/120, with presence detector ¹⁾
Turn-off delay time, min. optional at high or low level	—	6, 10, 15, 21 adjustable	6, 12, 18, 24 adjustable ³⁾	6
Interval mode, hours optional at high or low level	—	0, 8, 12, 24 adjustable	—	—
Start-up delay approx. sec.	—	0, 45, 90, 120	0 or 45 ³⁾	—
Inner shutter, removable	Yes	Yes	Yes	Yes
Flow rate free blowing m^3/h	170 / 150	170 / 150	170 / 150	170 / 150
Impeller \varnothing mm	111	111	111	111
Speed min^{-1}	2350 / 2050	2350 / 2050	2350 / 2050	2350 / 2050
Voltage / Frequency 50 Hz	230 V	230 V	230 V	230 V
Power consumption W	13 / 10	13 / 10	13 / 10	13 / 10
Rated current A	0.09 / 0.08	0.09 / 0.08	0.09 / 0.08	0.09 / 0.08
Sound pressure level dB(A) at 3 m^2	36 / 32	36 / 32	36 / 32	36 / 32
Wiring diagram no.	915	917	919	918
Electrical supply line NYM-O in mm^2	3 x 1.5	4 x 1.5	4 x 1.5	3 x 1.5
Protection class II, protection category	IP45	IP45	IP45	IP45
Max. air flow temperature	+40 °C	+40 °C	+40 °C	+40 °C
Weight approx. kg	1.05	1.05	1.05	1.05

¹⁾ All electronic functions optionally adjustable at high or low performance level.

²⁾ Free field conditions.

³⁾ For manual operation.

⁴⁾ Limit value 60, 70, 80, 90% adjustable.

Beautiful and clean

Air flows into the M1 from all sides. The front facade is completely closed and elegantly conceals the bothersome clogging zone in conventional compact fans.

The M1 blends in harmoniously in all environments. The smooth-surfaced front facade always remains easy to maintain and clean.



Intelligent humidity control function

The humidity control function of type M1/120 F automatically activates the fan depending on the humidity increase rate. The turn-off delay time depends on the room humidity reduction. In case of constantly high humidity, the fan will automatically switch to interval mode.



Rapid connection

The electrical connection is enormously facilitated by a generously dimensioned, circumferential cable storage space on the back of the unit, the full rotatability of the casing and screwless terminals.

Long-life ball bearings for 40.000 operating hours allow installation in any position, even directly in the ceiling.



Wall mounting kit

WES 120 Ref. no. 00486

Two telescoping plastic ducts serve as the wall/feed duct. The external wall connection is carried out by using the frame with blades as an automatic shutter.

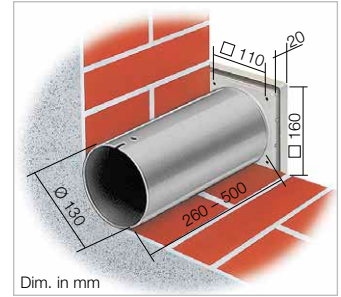

Dim. in mm

Telescopic wall sleeve

TWH 120 Ref. no. 06353

Like WES, but without shutter.

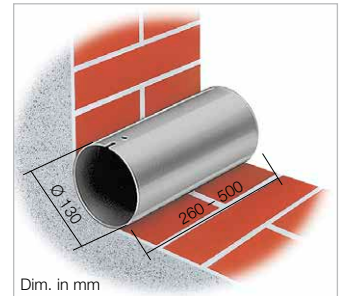

Dim. in mm

Operating and speed switch 0-1-2 for standard model

MVB Ref. no. 06091

With functions On/Off, low and high speed.

Load capacity 3 A (ind.)

Voltage 230 V, 1~, 50/60 Hz

Protection category IP 30

Installation in standard flush-mounted box

Dimensions mm W 80 x H 80 x D 15

Weight approx. 0.1 kg



Accessory details Page

Flexible ventilation ducts, roof outlets and ventilation grilles	553 ff.
Intake air elements	578 ff.

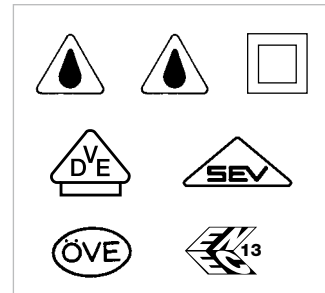

Flexible installation depth

The removeable guide wheel reduces the installation depth from 116 to 70 mm. Installation possible with or without back-draught shutters.

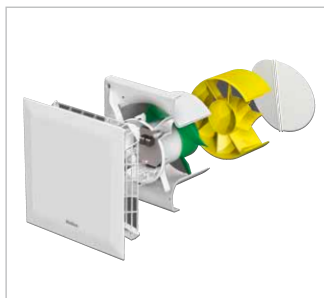

Applicable in wet room zone 1

MiniVent M1/120 complies with jet water protection IPX5, insulation protection class II and may be used in zone 1 according to DIN VDE 0100-701.

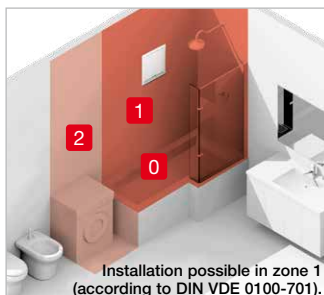

Installation possible in zone 1 (according to DIN VDE 0100-701).

M1/150



Dimensions M1/150

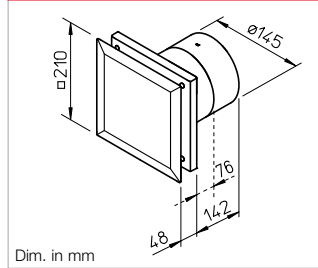

Performance curve M1/150

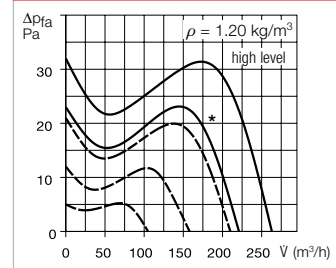

* low level
--- Example performance levels of 0-10 V type with continuously variable control

Premium class small room fans. The design and performance of the MiniVent M1/150 set new standards in the field of compact fans. With its multi-award-winning design, the M1/150 blends in harmoniously in all environments. The enclosed, well-designed facade completely prevents viewing of the fan clogging zone. All M1/150 models come with high efficiency EC drive technology, with 2 performance levels or continuously variable and tight-closing back-draught shutters as standard. The noise level is extremely low thanks to Helios ultraSilence technology. Available with turn-off delay mode and interval mode, continuously variable speed control or barrier-free automatic functions, such as the humidity control function. The humidity control function responds to the

rate of humidity increase with intelligent electronics and effectively prevents mould formation. Universally applicable for the ventilation of medium-sized rooms in private, commercial and industrial buildings.

■ Features

- Extremely low power consumption of just 6 Watts at $\dot{V} = 220 \text{ m}^3/\text{h}$.
- Ultra quiet thanks to ultraSilence technology; just 35 dB(A) at $\dot{V} = 220 \text{ m}^3/\text{h}$.
- Pressure performance: $180 \text{ m}^3/\text{h}$ volume flow at 31 Pa resistance. $260 \text{ m}^3/\text{h}$ free blowing, ΔP max. 33 Pa.
- In case of restricted space conditions, the M1/150 guide wheel can be easily removed. This reduces the installation depth from 142 to just 76 mm.

- Compact dimensions for universal flush-mounted installation in walls, shafts and ceilings with NW 150/160
- All parts are made of high-quality plastic, colour: white.
- Ball bearings and motor are designed for continuous loads, constant output and lifelong functional reliability.
- Motor with thermal overload protection, maintenance-free and radio interference-free.
- Applicable in wet room zone 1 according to DIN VDE 0100-701.
- Electrical supply line can be surface or flush-mounted.
- Practical quick installation due to screwless connection terminals.
- The 0-10 V type offers a wide range of applications in combination with CO_2 , VOC or temperature sensors. The min./max. speed is fully adjustable and

continuously variable control via potentiometer is also possible. Control takes place via three level switches or continuously variably via universal control systems or electronic differential pressure/temperature controllers. A potential-free relay outlet is available as standard for the connection of an electrical shut-

Type	M1/150	M1/150/N/C	M1/150 F	M1/150 0-10 V
Ref. no.	06041	06042	06043	06044
Version	Standard model with two speed levels	Like M1/150, with codeable turn-off delay & interval model ¹⁾	Like M1/150, with humidity control function ¹⁾⁴⁾	Continuously variable control
Turn-off delay time, min., optional at high, low or both levels	—	6, 10, 15, 21 adjustable	6, 12, 18, 24 adjustable ³⁾	6
Interval mode, hours, optional at high, low or both levels	—	0, 8, 12, 24 adjustable	—	—
Start-up delay approx. sec.	—	0, 45, 90, 120	0, 45, 90, 120 ³⁾	—
Inner shutter, removable	Yes	Yes	Yes	Yes
Flow rate free blowing m^3/h	260 / 220	260 / 220	260 / 220	260-50
Impeller \varnothing mm	137	137	137	137
Speed min^{-1}	1900 / 1600	1900 / 1600	1900 / 1600	1900 -980
Voltage / Frequency 50 Hz	230 V	230 V	230 V	230 V
Power consumption W	8 / 4.5	8 / 5	9 / 6	9 / min. 3.5
Rated current A	0.08 / 0.06	0.10 / 0.09	0.08 / 0.06	0.08 / 0.035
Sound pressure level dB(A) at 3 m ²⁾	39 / 35	39 / 35	39 / 35	max. 39
Wiring diagram no.	1080	1081	1082	1083
Electrical supply line NYM-O in mm ²	3 x 1.5	4 x 1.5	4 x 1.5	2 x 1.5 ⁵⁾
Protection class II, protection category	IP45	IP45	IP45	IP45
Max. air flow temperature	+40 °C	+40 °C	+40 °C	+40 °C
Weight approx. kg	1.20	1.20	1.20	1.20

¹⁾ All codeable times and electronic functions optionally adjustable at high, low or both performance levels. ²⁾ Free field conditions. ³⁾ For manual operation. ⁴⁾ Limit values from 40-90 % continuously variably adjustable. ⁵⁾ Additional connection cable provided for relay output.

Beautiful and clean

Air flows into the M1 from all sides. The front facade is completely closed and elegantly conceals the bothersome clogging zone in conventional compact fans.

The M1 blends in harmoniously in all environments. The smooth-surfaced front facade always remains easy to maintain and clean.

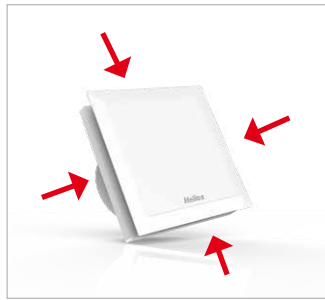
Intelligent humidity control function

The humidity control function of type M1/150 F automatically activates the fan depending on the humidity increase rate. The turn-off delay time depends on the room humidity reduction. In case of constantly high humidity, the fan will automatically switch to interval mode.



Rapid connection

The electrical connection is enormously facilitated by a generously dimensioned, circumferential cable storage space on the back of the unit, the full rotatability of the casing and screwless terminals.

Long-life ball bearings for 40.000 operating hours allow installation in any position, even directly in the ceiling.

Flexible installation depth

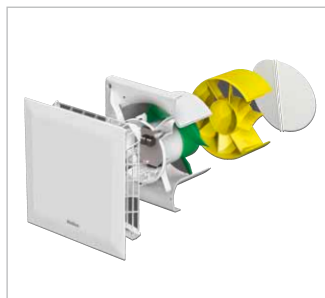
The removeable guide wheel reduces the installation depth from 142 to 76 mm. Installation possible with or without back-draught shutters.

Applicable in wet room zone 1

MiniVent M1/150 complies with jet water protection IPX5, insulation protection class II and may be used in zone 1 according to DIN VDE 0100-701.

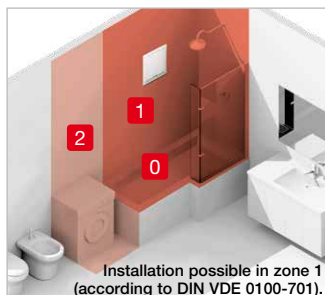

Wall mounting kit

WES 150 Ref. no. 00537

Two telescoping plastic ducts serve as the wall/feed duct; for flush-mounted installation.

External wall connection possible in two ways:

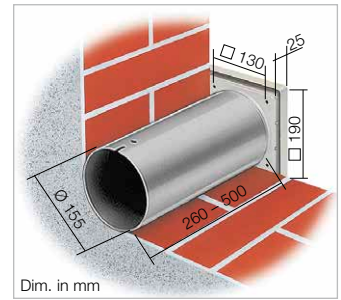
- a) Frame with three blades as an automatic shutter.
- b) Use of the frame with fixed grille. All parts made of high-quality plastic.

Telescopic wall sleeve

TWH 150 Ref. no. 06354

Like WES, but without shutter and grille.

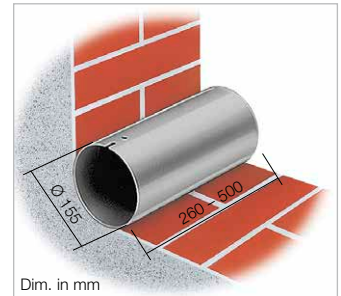
Operating and speed switch
0-1-2 for standard model

MVB Ref. no. 06091

With functions On/Off, low and high speed.

Load capacity 3 A (ind.)
 Voltage 230 V, 1~, 50/60 Hz
 Protection category IP 30
 Installation in standard flush-mounted box
 Dimensions mm W 80 x H 80 x D 15
 Weight approx. 0.1 kg

Speed switch for
M1/150 N/C and M1/150 F

DSEL 2 Ref. no. 01306

With functions On/Off, low and high speed.

Load capacity 3 A (ind.)
 Voltage 230 V, 1~, 50/60 Hz
 Protection category IP 30
 Installation in standard flush-mounted box
 Dimensions mm W 80 x H 80 x D 15
 Weight approx. 0.1 kg

Speed potentiometer for M1/150
0-10 V

With functions On/Off, continuously variable speed control.

PU 10 Ref. no. 01734
 For flush-mounted installation.

Installation in standard flush-mounted box
 Dim. mm W 80 x H 80 x D 21 protr.

PA 10 Ref. no. 01735
 For surface-mounted installation.

Casing Surface installation
 Dimensions mm W 80 x H 80 x D 65

Accessory details Page

Flexible ventilation ducts, roof outlets and ventilation grilles	553 ff.
Intake air elements	578 ff.
Universal control system, Speed potentiometer	605 ff.

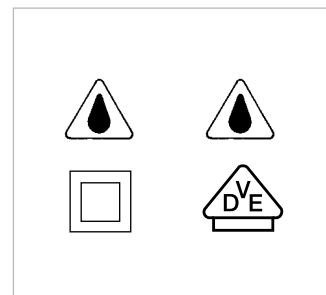

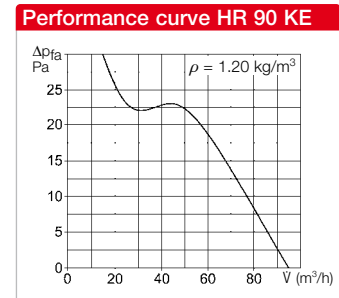
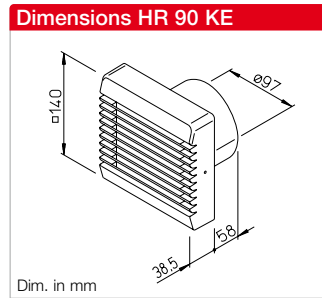

High-quality mini fans with electrical inner shutter. The shutter blades behind the facade open and close completely silently and automatically when the fan is activated/deactivated. This ensures a rattle-free intake air connection when the fan is at a standstill. The design with long-life ball bearings ensures maintenance-free operation, low-noise running and it allows installation in any position.

Designed to be unobtrusive, the HR 90 KE fits in any room environment. The upward facing blades prevent viewing of the fan clogging zone. Universally applicable for the ventilation of bathrooms, WCs and other small rooms.

Highlights

- Smooth running and functionally reliable, even in continuous operation.
- Maintenance, relubrication and cleaning are unnecessary. The ball bearings have a lubricant supply which is adequate for their entire service life of approx. 30.000 operating hours.
- The noise-tested long-life ball bearings guarantee lifelong smooth running without any disturbing squeaking, even under the most difficult operating conditions.
- The ball bearings and motor are designed for continuous loads, constant output and lifelong functional reliability.

- Applicable in wet room zone 1 according to DIN VDE 0100-701.
- Flush-mounted installation in Rohre und Schächte mit NW 100.
- Applicable practically anywhere due to short installation depth and small dimensions.
- Attractive softline design in pleasant white.
- All casing parts made of high-quality plastic.
- Contact protection according to DIN EN ISO 13857.
- Motor with thermal overload protection, maintenance-free and radio interference-free, for continuous operation.
- Electrical supply line can be surface or flush-mounted.
- Practical quick installation due to screwless terminals for electrical connection.
- Plug claw connection for insertion in ducts 100 mm or screw fastening in larger openings.

Type	HR 90 KE	HR 90 KEZ
Ref. no.	00334	00335
Built-in turn-off delay switch ¹⁾ , Turn-off delay time approx. 2-8 min.	—	Yes ²⁾
Electrical inner shutter	Yes	Yes
Flow rate free blowing m ³ /h ³⁾	95	95
Impeller Ø mm	93	93
Speed min ⁻¹	2550	2550
Voltage / Frequency 50/60 Hz	230 V	230 V
Power consumption W	17	20
Rated current A	0.12	0.14
Sound pressure level dB(A) at 1 m	44	44
Wiring diagram no.	483	484
Protection class II, protection category	IP45	IP45
Max. air flow temperature	+40 °C	+40 °C
Weight approx. kg	0.60	0.62

¹⁾ Initiates start-up delay of approx. 1 min.

²⁾ NYM-O 3 x 1.5 mm² required. ³⁾ Calculated with outlet side duct, length 2 x D.

Reference
HR 90 K 12 V –
with safety extra-low voltage
upon request

■ **Mini fans HR 90 KE especially for ceiling installation**

Ball bearing mounted fans are best suited for vertical installation in the ceiling. The mounting flange MF 90 (accessories) prevents the ingress of condensate into the fans from vertical pipes.



■ **Screwless installation**

HR 90 KE have screwless terminals for electrical connection. The facade can be quickly attached due to a snap-in mechanism. Side spring clips facilitate installation in ducts with NW 100.



■ **Applicable in wet room zone 1**

The HR 90 KE models comply with protection category IP X5 (jet water protection) and may be used in zone 1 according to DIN VDE 0100-701.

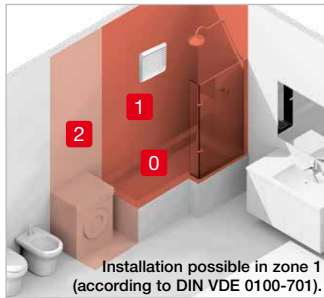

■ **Installation in any position**

HR 90 KE is equipped with electrical inner shutter and high-quality long-life ball bearings as standard. This allows wall and ceiling installation in any position – vertical, horizontal or diagonal.

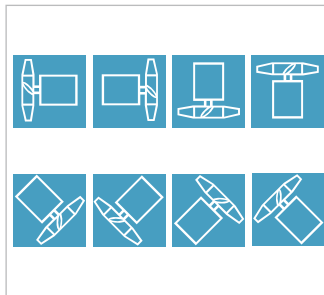

■ **Test marks**

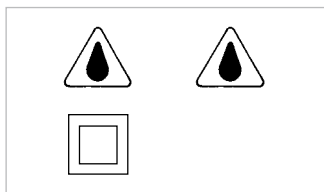

Wall mounting kit

WES 90 Ref. no. 00717

Two telescoping plastic ducts serve as the wall/feed duct; for flush-mounted installation. External wall connection possible in two ways:
a) Frame with three blades as an automatic shutter.
b) Use of the frame with fixed grille. All parts made of high-quality plastic.

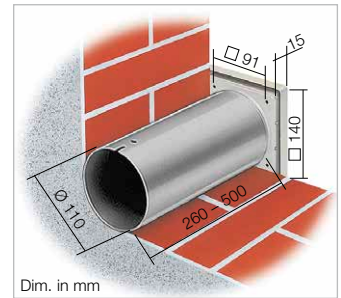

Telescopic wall sleeve

TWH 90 Ref. no. 06352

Like WES, but without shutter and grille.

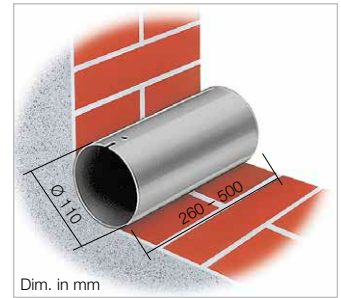

Window mounting kit

FES 90 Ref. no. 00462

For the installation of HR 90 KE models in single and double glazed windows, thin walls and panels. Possible pane / wall thickness 1 to 40 mm. External cover with flat rain-repellent grille just 29 mm thick. Drawcord operation. Protection category IP20.

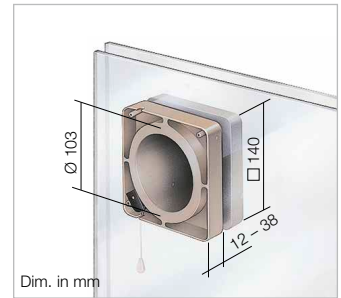

Mounting panel

MBR 90/160/300 Ref. no. 00281

Made of high-quality, impact-resistant plastic, colour: alpine white. Ideal for use in renovations. HR 90 KE models can be easily installed in existing, rectangular shaft openings with the mounting panel. The panel can be fully painted or wallpapered in order to hide it.

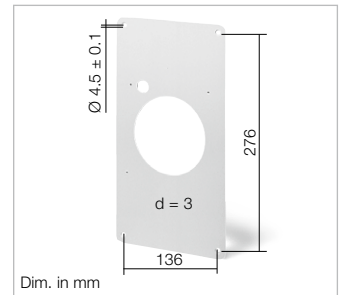

Mounting flange

MF 90 Ref. no. 00819

Areas of application:
1. Required for ceiling installation. MF prevents the ingress of condensate into the fan from vertical extract air ducts.
2. For the simple installation of connection cables in case of an inconvenient wall outlet, because the fan is raised from the wall by 23 mm.
3. For the simple installation of the fan in narrow shafts. In case of 90° bend with a short duct connection, the MF reduces the installation depth of the fan.
4. In case of installation in thin walls, the installation depth of the fan can be reduced as follows: To 35 mm with 1 mounting flange. To 7 mm with 2 mounting flanges. Colour: Alpine white.

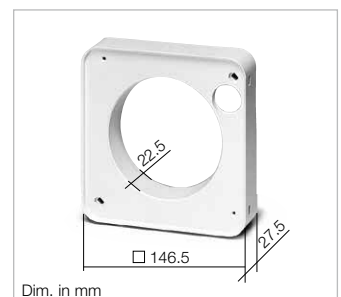

■ **Accessory details Page**

Flexible ventilation ducts, roof outlets and ventilation grilles	553 ff.
Intake air elements	578 ff.
Speed controllers, controllers & turn-off delay switches	591 ff.

HVR 150



Dimensions HVR 150

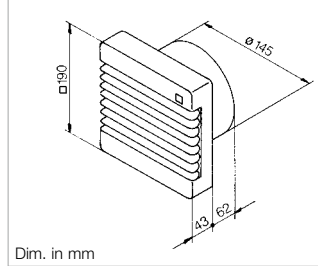

Performance curve HVR 150

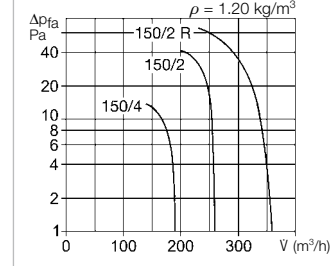

HelioVent wall and window fans are suitable for the ventilation of small to medium-sized rooms in private, commercial and industrial buildings.

The standard equipment with ball bearings guarantees:

- Installation in any position.
- Smooth running and functional reliability in continuous operation.
- Quiet and maintenance-free operation over the entire service life.

Features

- Ventilation grille can be removed without tools and easily cleaned in a water bath.
- Low installation depth prevents potential installation problems.
- Versatile installation in walls, ceilings or shafts in any position.
- Flow rate adjustment through continuously variable, electronic speed control.
- Motor protection through integrated thermal contacts.

Description

The unit blends in harmoniously in all room environments. All parts, including the fan casing and impeller, made of high-quality plastic. Facade: white. Visual operation indicator through built-in indicator lights. High pressure and volume performance due to 8-bladed high performance impeller and an additional inlet guide wheel.

Enclosed motor with low-noise ball bearings for continuous operation. Installation possible in any position. Maintenance-free and radio interference-free. Contact protection according to DIN EN ISO 13857. Electrical supply line can be surface or flush-mounted.

Window mounting kit

FES 150 Ref. no. 00463

For the installation of all models, preferably types with electrical inner shutter, for single and double glazed windows, thin walls and panels. Protection category IP20. External cover with flat rain-repellent grille with fixed blades. Operation via supplied drawcord or remote on-site switch.

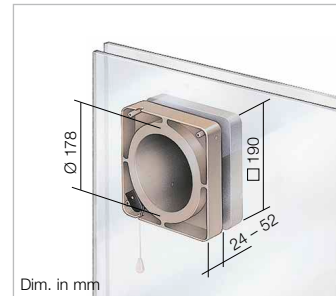

Wall mounting kit

WES 150 Ref. no. 00537

For flush-mounted wall installation; consisting of: Two wall telescoping plastic ducts and the external wall connection. This can be installed as an automatic shutter or with a rain-repellent grille for HVR E models. Both elements are included in delivery.

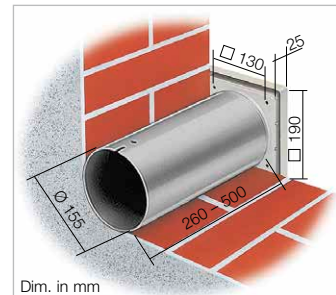

Telescopic wall sleeve

TWH 150 Ref. no. 06354

Like WES, but without shutter and grille.

Accessory details Page

Roof outlets and ventilation grilles	553 ff.
Intake air elements	578 ff.
Speed controllers, controllers & turn-off delay switches	591 ff.

Type	HVR 150/4 E	HVR 150/2 E	HVR 150/2 RE
Ref. no.	00283	00285	00286
Electrical inner shutter	Yes	Yes	Yes
Reversible (supply and extract ventilation)	—	—	DSEL 2¹⁾ Ref. no. 01306
Flow rate free blowing m ³ /h	180	260	360
Impeller Ø mm	140	140	140
Speed min ⁻¹ ca.	1300	1800	2600
Voltage / Frequency	230 V~ / 50 Hz	230 V~ / 50 Hz	230 V~ / 50 Hz
Power consumption W	30	35	50
Rated current A	0.20	0.15	0.25
Sound pressure level dB(A) at 1 m	46	58	64
Wiring diagram no.	283	283	284.1
Protection class II, protection category	IP44	IP44	IP44
Max. air flow temperature	+40 °C	+40 °C	+40 °C
Weight approx. kg	1.2	1.4	1.5

¹⁾ NYM-O 3 x 1.5 mm² required for reverse operation.

HV 200 / HV 250



Dimensions HV 200 / HV 250

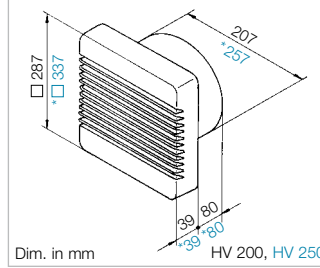

Charac. curve HV 200 / HV 250

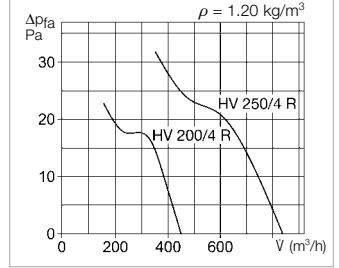

HelioVent wall fans fit in every room atmosphere thanks to their timeless design: In living rooms and dining rooms, offices and conference rooms, restaurants or foyers.

Universally applicable. For supply and extract ventilation (reversible). Installation in walls or ceilings, even in an inclined position.

■ HelioVent at a glance

- Compact, low-noise fan unit with clever design features:
- HelioVent fits in unobtrusively in all environments.
- No view of the contaminated fan openings.
- High performance and low air noise due to low flow resistances.
- Ideal for maintenance. Facade can be removed with one hand. Easy to clean in a water bath.

■ Installation – connection

Installation is very easy and completed in minutes. The electrical connection is convenient. Reliable plug-in terminals and large cable storage space simplify the process. The supply line can be flush-mounted or surface-mounted.

■ Speed control

Possible in the range from 0–100 % using voltage reduction via electronic or transformer control units.

■ Description

- Room-side facade and fan casing made from high-quality and impact-resistant plastic in alpine white.
- Powerful capacitor motor with high level of efficiency. Fully enclosed. Corrosion-proof in die-cast aluminium casing, protected against dust and water (protection category IP54). Winding with humidity protection through bath impregnation in ISO class B.
- Protected against overloading by built-in thermal contact (automatically reactivating).
- Noise-tested ball bearings ensure quiet running.
- The large terminal box (protection category IP55) and huge cable storage space facilitate connection work.
- Profiled high-performance impeller with high efficiency ensures low-noise operation.
- Radio interference-free and maintenance-free.
- Contact protection according to DIN EN ISO 13857 guaranteed by room-side facade.
- Service and connection-friendly.

■ Accessory details Page

Roof outlets and ventilation grilles	553 ff.
Intake air elements	578 ff.
Speed controllers, controllers & turn-off delay switches	591 ff.

Installation in wall or ceiling

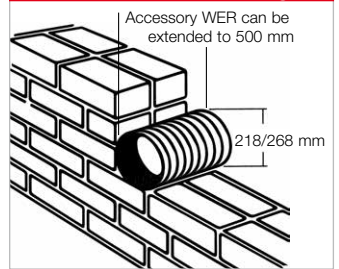

Installation in thin panels

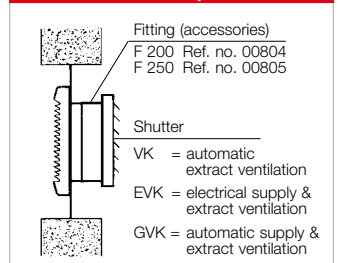

Type	HV 200/4 R	HV 250/4 R
Ref. no.	00957	00958
Reversible (supply and extract ventilation)	Yes	Yes
Flow rate free blowing m³/h	450	840
Impeller Ø mm	200	250
Speed min⁻¹	1360	1380
Voltage / Frequency	230 V~ / 50 Hz	230 V~ / 50 Hz
Power consumption W	30	40
Rated current A	0.13	0.20
Sound pressure level dB(A) at 15 Pa at 1 m distance (free field conditions)	52	55
Sound power dB(A)	60	63
Wiring diagram no.	439	439
Protection category	IP54	IP54
Max. air flow temperature	+40 °C	+40 °C
Weight approx. kg	2.1	2.6

Accessories Description	Fan type	HV 200	HV 250
Feed duct for flush-mounted wall installation	Type Ref. no.	WER 200 00368	WER 250/225 00369
Shutter for extract air operation	Type Ref. no.	VK 200 00758	VK 250 00759
Shutter for supply and extract ventilation	Type Ref. no.	GVK 200 00370	GVK 250 00371
Reversing switch for supply and extract ventilation	Type Ref. no.	DSEL 2 1) 01306	DSEL 2 1) 01306
Reversing switch with speed controller continuously variable	Type Ref. no.	BSK 00240	BSK 00240
Speed controller flush-mounted	Type Ref. no.	ESU 1 00236	ESU 1 00236
Speed controller surface-mounted	Type Ref. no.	ESA 1 00238	ESA 1 00238

1) NYM-J 4 x 1.5 mm² required for reverse operation.

DX 200



Dimensions DX 200

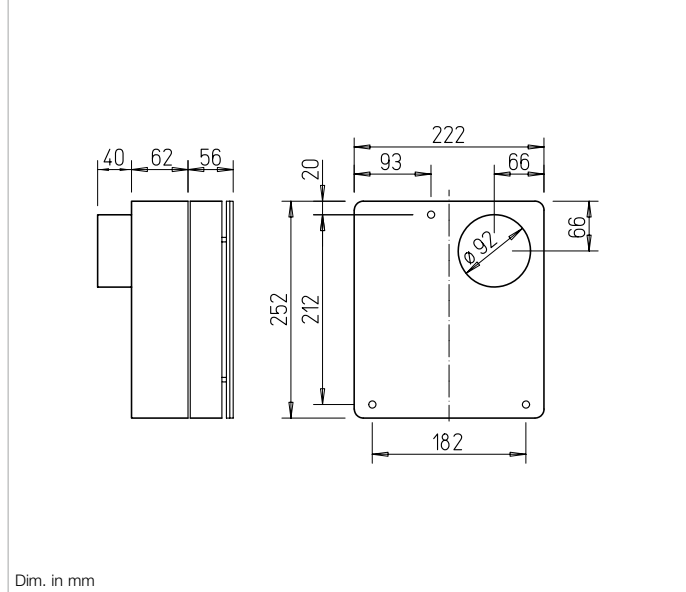

The universal series DX is characterised by attractive design and a hidden inlet opening. The unit is powerful, easy to install and suitable for the extract ventilation of small rooms in private, commercial and industrial buildings.

Description

- The convenient function control for various operating modes allows individual adjustment to room conditions and user requirements.
- Easy wall installation; can also be flush-mounted by removing the rear casing frame.
- Air outlet connectors can be inserted into ducts NW 100.
- The facade is easily removeable without tools for cleaning and maintenance.
- With integrated backdraught shutter.
- Maintenance-free motor with thermal overload protection.

Performance curves DX 200

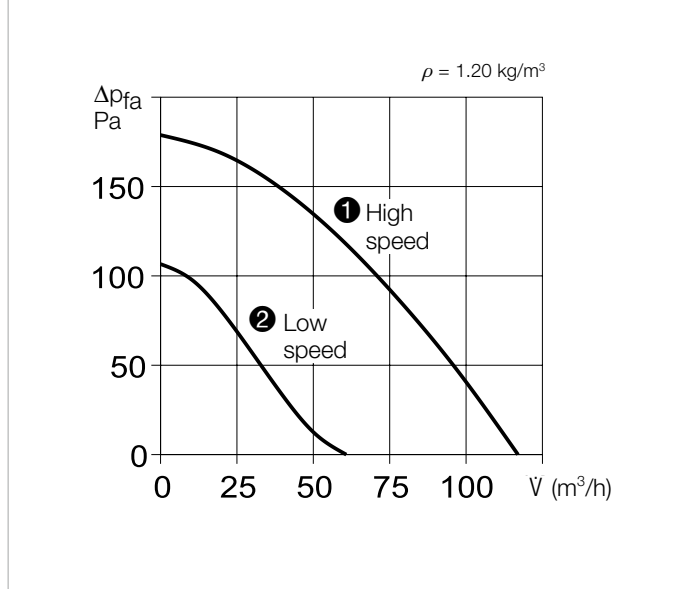

Technical data	
Type	DX 200
Ref. no.	01703
Operating mode	Continuously variable with electronic controller ESU 1 / ESA 1, Ref. no. 00236 / 00238. Two speed levels available using operating switch MVB, Ref. no. 06091.
Flow rate at level free blowing m³/h ¹⁾	① 120 ② 60
Speed min ⁻¹	2660
Voltage / Frequency	230 V~ / 50 Hz
Power consumption W	33
Rated current A	0.24
Sound pressure level dB(A) at 1 m ¹⁾	55 42
Wiring diagram no.	693.1
Protection category	IPX5
Max. air flow temperature	+40 °C
Weight approx. kg	1.7

Accessory details	Page
Flexible ventilation ducts, wall outlets and ventilation grilles	553 ff.
Intake air elements	578 ff.
Speed controllers, controllers & turn-off delay switches	591 ff.

¹⁾ Values refer to the different performance levels.

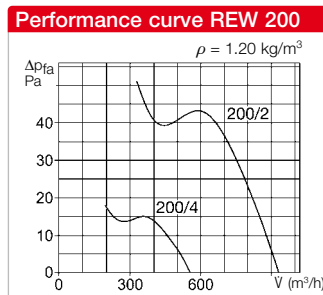
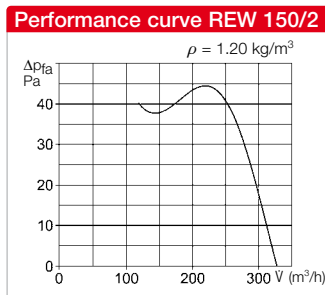
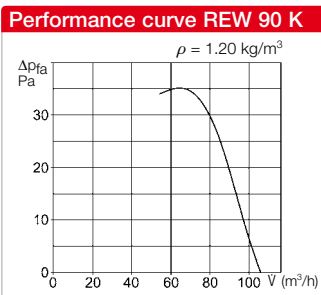
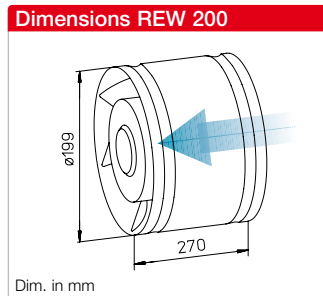
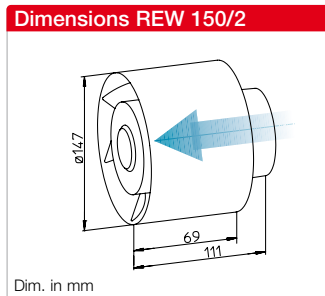
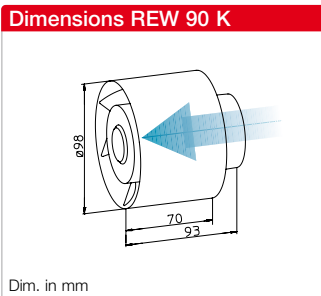

Description REW 90 K

Suitable for insertion in ducts with NW 100. Casing made of high-quality, impact-resistant plastic with integrated guide apparatus. Profiled high-performance impeller with 5 blades made of plastic. Motor with thermal overload protection for continuous operation with maintenance-free, lifetime lubricated ball bearings. Terminal box at rear of the motor for electrical connection.

Description REW 150/2

Suitable for insertion in ducts with NW 150. Casing made of high-quality, impact-resistant plastic with integrated guide apparatus. Profiled high-performance impeller with 8 blades made of plastic. Motor with thermal overload protection for continuous operation with maintenance-free, lifetime lubricated ball bearings, reversible, for continuous operation. Terminal box at rear of the motor for electrical connection.

Description REW 200

Suitable for insertion in ducts with NW 200. Casing with two outward-facing reinforcing beads made of galvanised steel sheet. Profiled impeller with 7 blades made of plastic. Enclosed motor with thermal overload protection for continuous operation and die-cast aluminium casing. Tropicalised winding with humidity protection. Ball bearing mounted, maintenance and radio interference-free; reversible. Term. box on motor.

Use options

Versatile axial fans for delivering small to medium volume flows against low resistances. Unit can be used for room ventilation, air circulation, cooling, drying, etc.

Installation

Unit can be installed in any position. The flow direction depends on the installation position. Suitable for insertion or interpositioning in pipes. In this context, note possible pressure performance and resistances. In case of higher resistances, use centrifugal inline fans. Electrical connection at rear of the motor. During installation makes sure that the fan remains accessible for inspection.

Accessories

Speed controller with reverser
(for REW 150 and 200)
BSX Ref. no. 00240

Accessory details Page

Flexible ventilation ducts, roof outlets and ventilation grilles	553 ff.
Extract, supply, intake air elements and disc valves	566 ff.
Speed controllers, controllers & turn-off delay switches	591 ff.

Type	REW 90 K	REW 150/2	REW 200/4	REW 200/2
Ref. no.	00441	00440	07504	07505
Reversible (supply and extract ventilation)	No	DSEL 2 ¹⁾ No. 01306	DSEL 2 ²⁾ No. 01306	DSEL 2 ²⁾ No. 01306
Flow rate free blowing m ³ /h	105	330	550	930
Impeller Ø mm	93	140	200	200
Speed min ⁻¹	2320	2100	1350	2280
Voltage / Frequency	230 V~ / 50 Hz	230 V~ / 50 Hz	230 V~ / 50 Hz	230 V~ / 50 Hz
Power consumption W	15	29	40	70
Rated current A	0.10	0.13	0.28	0.33
Sound pressure level dB(A) at 1 m	45	56	44	57
Wiring diagram no.	479	478	439	439
Protection category	IP55	IP44	IP54	IP54
Max. air flow temperature	+40 °C	+40 °C	+50 °C	+50 °C
Weight approx. kg	0.46	1.1	2.0	2.5

¹⁾ NYM-O 3 x 1.5 mm² required for reverse operation.

²⁾ NYM-J 4 x 1.5 mm² required for reverse operation.

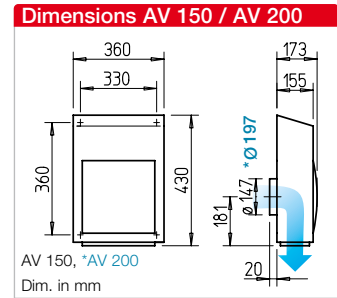
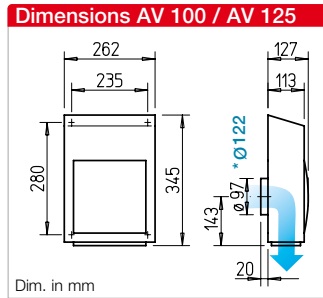

Application

Designed for external wall installation for the ventilation of all small and medium-sized rooms. Suitable for a number of applications in residential, commercial and industrial buildings.

Powerful, efficient centrifugal fans allow the connection of duct systems and overcome resistances from filters and system components. The unit is the ideal solution for the extract ventilation of domestic kitchens because the annoying noises from extraction hoods are minimised. This also applies for other applications and the connection of duct systems because the fan noise moves outside. Ideal for retrofitting in renovations and conversions.

Special features

- No disturbing fan noises inside the rooms due to external wall installation.
- Easy and cost-effective installation through anchoring of the operational unit.
- Weatherproof casing. Tight-closing shutter blades with spring return.
- Connectors according to standard duct Ø for connection to wall duct or duct system.
- Solid base plate made of plastic also allows installation on uneven surfaces.
- Electrical supply line can be flush-mounted from behind or surface-mounted from the side.
- Casing**
 - Waterproof cover hood made of galvanised steel sheet, powder-coated, alpine white.
 - Outlet-side bird protection grille and two shutter blades with spring return.

Power control

All models come with three power levels as standard. Continuously variable with electronic controllers or 5 step transformers.

Drive

Enclosed, ball bearing mounted motor with humidity protection, insulation class F, for continuous operation, maintenance-free and radio interference-free.

Motor protection

Motor protected by thermal overload protection in the winding.

Impeller

Energy-efficient centrifugal impeller with backward curved blading made of plastic, dynamically balanced.

Note

The fan may only be commissioned if impeller contact protection according to DIN EN ISO 13857 is provided.

Noise

The total level and range for the sound power level are specified above the performance diagram. The sound pressure at 3 m (free field conditions) is also specified in the type table.

Reference	Page
Speed controllers, controllers & turn-off delay switches	591 ff.

Type	Ref. no.	Conne- ction Ø	Max. flow rate	Max. speed	Max. sound press. level case-radiated	Voltage 50 Hz	Max. power consumption	Max. current consumption	Wiring diagram	Max. air flow temperature	Weight net approx.	Transformer speed controller 5-step	
		mm	ṽ m³/h	min ⁻¹	dB(A) at 3 m		Volt	W		A		No.	+ °C
AV 100	02654	100	310/150/70	2710/2050/1190	46/38/26	230	55/28/13	0.24/0.13/0.05	1386	60	4.6	TSW 1.5	01495
AV 125	02655	125	360/170/80	2471/1510/930	45/38/25	230	54/26/13	0.24/0.12/0.06	1386	60	4.6	TSW 1.5	01495
AV 150	02656	150	620/330/210	2520/1520/1070	50/43/33	230	100/57/40	0.44/0.25/0.18	1386	55	8.3	TSW 1.5	01495
AV 200	02657	200	680/350/240	2530/1970/1450	51/37/35	230	100/53/40	0.44/0.23/0.18	1386	55	8.3	TSW 1.5	01495

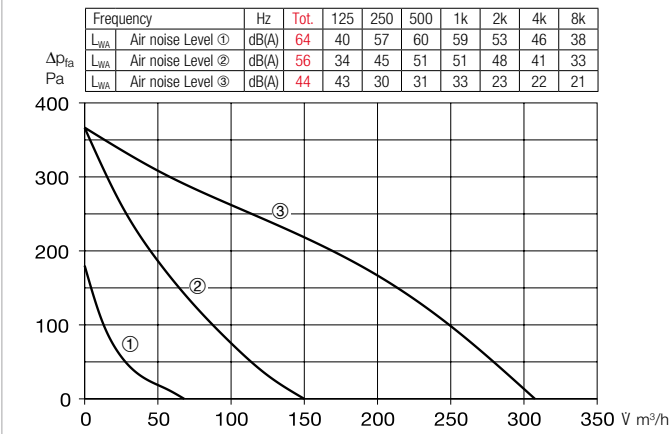
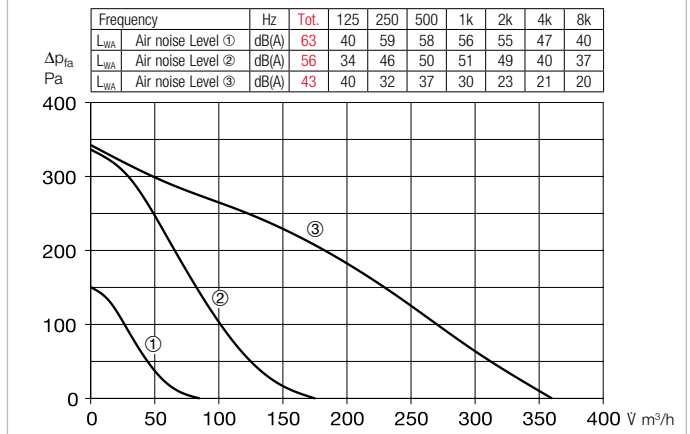
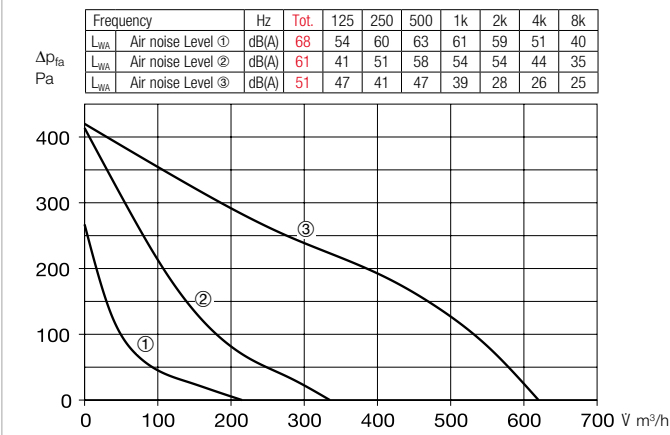
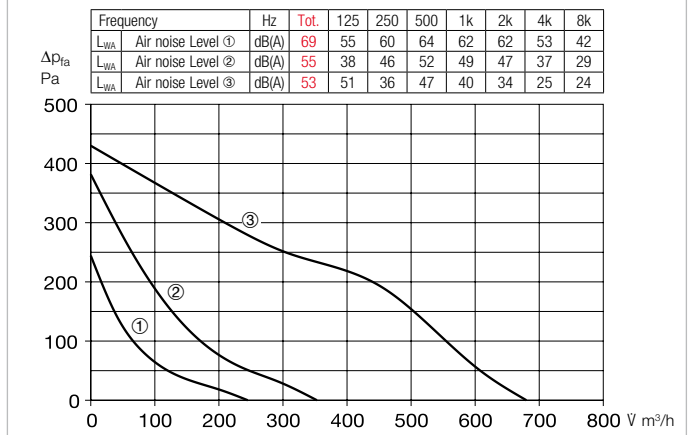
Performance curve AV 100

Performance curve AV 125

Performance curve AV 150

Performance curve AV 200

Accessories

Transformer speed controller TSW 1.5 Ref. no. 01495
 Five-step, for surface installation.
 1~ alternating current, 230 V.
 Max. load 1.5 A
 Wiring diagram no. 437.1
 Dim. mm W 154 x H 200 x D 79



Three-step speed and operating switch with 0 position DSZ Ref. no. 01598
 Convenient flush-mounted speed switch for fans with three performance levels. Room light cannot be switched in parallel. Can be used with central ventilation box ZEB EC.
 Load capacity AC 3 / 2.2 kW, AC 15 / 6 A
 Protection category IP 20
 Install. in flush-m. box w/ 55 mm depth
 Wiring diagram no. 735
 Dimensions mm W 80 x H 80 x D 23



Electronic speed controller ESU 1 Ref. no. 00236
 For flush-mounted installation.
 Front and rotary knob made of white plastic. Installation in standard flush-mounted box. Operation indicator via light ring.
 Max. load 1 A.
 Minimum load 0.15 A
 Protection category (built-in) IP30
 Wiring diagram no. 556.1
 Dim. mm W 80 x H 80 x D 21 protr.



Electronic speed controller ESA 1 Ref. no. 00238
 For surface installation.
 White plastic casing, operation indicator via light ring in rotary knob.
 Max. load 1 A.
 Minimum load 0.15 A
 Protection category IP40
 Wiring diagram no. 556.1
 Dimensions mm W 80 x H 80 x D 65



Electronic speed controller, contin. variable flush / surface-mounted		Speed controller, 3-step flush-mounted	
Type	Ref. no.	Type	Ref. no.
ESU 1/ESA 1	00236/00238	DSZ	01598
ESU 1/ESA 1	00236/00238	DSZ	01598
ESU 1/ESA 1	00236/00238	DSZ	01598
ESU 1/ESA 1	00236/00238	DSZ	01598

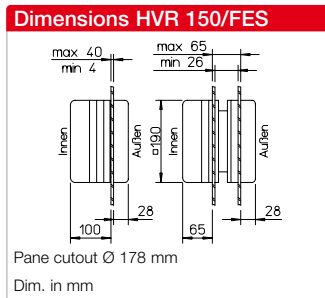
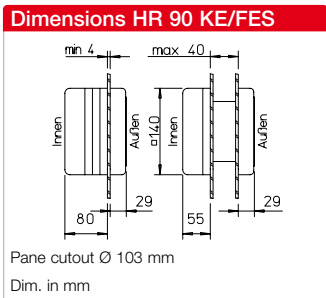

Elegant compact window fans with flow rates of 80–360 m³/h.

Area of application
All rooms and windows in private buildings as well as small to medium-sized commercial spaces.

Special features and common features

Universal application
Prepared for installation in panels, single glazed windows, double glazed windows and composite windows (HR 90 KE/FES not for hinged composite window) as standard. Suitable for wall installation with anchoring using wall sleeve (accessories).

- **Electrical inner shutter**
Tight-closing with silent operation; maintenance-free. Automatic operation with the fan circuit.
- **Casing**
Casing made of high-quality, impact-resistant plastic. Fan casing and external grille in white.
- **Motor**
Enclosed motor in splash-proof casing. Maintenance-free and radio interference-free. Maximum air flow temp. +40 °C.
- **Installation**
The service-friendly and installation-friendly unit design allows quick installation with only a few steps.

Description HR 90 KE/FES

- Compact window fan for rooms of any kind. Upward facing blades prevent viewing of the fan clogging zone.
- Applicable in single and double glazed windowpanes with a thickness of 4–40 mm. The variable distance compensation is achieved by using or omitting the supplied spacer frames.
- External cover with flat rain-repellent grille.
- Operation via on-site On/Off switch or the built-in drawcord.
- Integrated operation indicator.

Description HVR 150/FES

- Powerful window fans for small to medium-sized private and commercial spaces.
- For installation in single and double glazed windows (composite window can be opened unhindered) as well as thin panels with a thickness of 4–40 mm. Variable distance compensation through installation or omission of the supplied spacer frames.
- External cover with flat rain-repellent grille.
- Operation via on-site On/Off switch or the built-in drawcord.
- Optical operation indicator.

Reference	Page
Speed controllers, controllers & turn-off delay switches	591 ff.

Product range			
Technical data	HR 90 KE/FES	HVR 150/2 E/FES	HVR 150/2 RE/FES
Ref. no.	00334 / 00462	00285 / 00463	00286 / 00463
Electrical inner shutter	Available	Available	Available
Reversible (supply and extract ventilation)	Extract ventilation	Extract ventilation	DSEL 2 ²⁾ Ref. no. 01306
Pane cutout Ø mm	103 mm	178 mm	178 mm
Flow rate free blowing m³/h	80	260	360
Impeller Ø mm	93 mm	140 mm	140 mm
Voltage 230 V, 50 Hz, power consumption W	17	35	50
Rated current A	0.12	0.15	0.25
Speed min ⁻¹	2550	1800	2600
Sound pressure ¹⁾ /power dB(A)	44/51	58/65	64/71
Weight approx. kg	1.0	1.9	2.0
Wiring diagram no.	483	283	284
Protection category	IP45	IP44	IP44
Accessories			
Double glazed window installation for hinged composite window	—	Available	Available
Ref. no.	—	—	—
Wall installation, Telescopic wall sleeve 260 – 500 mm	TWH 90	TWH 150	TWH 150
Ref. no.	06352	06354	06354
Speed controller flush/surface-mounted	—	ESU 1 / ESA 1	ESU 1 / ESA 1
Ref. no.	—	00236 / 00238	00236 / 00238
Speed controller with reversing switch for switching from supply to extract ventilation	—	—	BSX
Ref. no.	—	—	00240

¹⁾ Distance at 1 m free field conditions. ²⁾ NYM-O 3 x 1.5 mm² required for reverse operation.

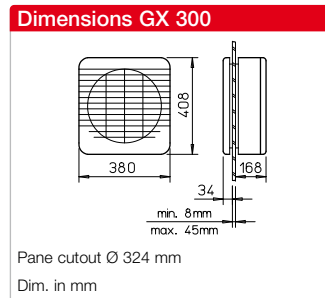
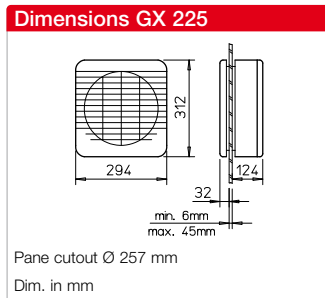
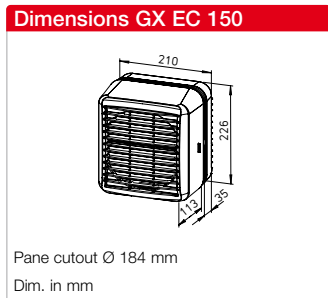

Low-noise window fans for use in private, commercial and industrial buildings. The series GX offers smooth running and functional reliability in continuous operation. The fan and external grille come in pleasant white. Attractive design, integrates unobtrusively in all rooms and any building facade.

Area of application

For the ventilation of medium and large rooms of any kind in the temperature range from -30 °C to +40 °C.

Special features

Universal application

Prepared for installation in single glazed windows, double glazed windows and panels as standard. Suitable accessories available for composite windows and wall installation.

Electrical connection

Concealed behind elegant inner facade. Tight-closing and silent function. The shutter has a lo-

cked position which allows permanent opening when the fan is deactivated (static ventilation in summer). The automatic shutter function is forced and time-delayed with the fan circuit.

Casing

Attractive design made of high-quality, impact-resistant plastic. Colour: white. Inner facade can be removed with one hand and without tools for cleaning in a water bath (power supply is then automatically interrupted).

Motor

Enclosed, splash-proof motor (IP44) with thermal overload protection. GX EC 150 with energy-saving EC motor. Maintenance-free and radio interference-free. Maximum air flow temperature +40 °C. Power can be controlled via speed controller (accessories) depending on type.

Installation

The service-friendly and installation-friendly unit design allows quick installation with only a few steps.

operating modes without changing the wiring:

- Extract ventilation
- Supply ventilation or
- Reversing operation by means of external operating switch/speed controller (accessories).
- Static ventilation possible (without fan operation) by locking the shutter.
- Control via on-site On/Off switch or operating switch/speed controller (accessories). Automatic shutter function with fan circuit.
- Flat rain grille does not obstruct venetian blinds or roller shutters.
- Installation-friendly design, all main parts can be removed for cleaning without tools.

Description GX 300

- Powerful fan in comfort class for the supply and extract ventilation of larger rooms in attractive softline design. Blends in harmoniously in all environments and building facades.
- Internal operating mode switch allows the following without changing the wiring:
 - Extract ventilation
 - Supply ventilation or
 - Reversing operation by means of external operating switch/speed controller (accessories).
- Control via on-site On/Off switch or operating switch/speed controller (accessories). Automatic shutter function with fan circuit.
- Static ventilation, installation and external cover see GX 225.
- Installation-friendly design, room-side casing parts can be removed for cleaning without tools.

Description GX EC 150

- Sophisticated fan in a lower performance class for extract ventilation.
- Installation in single glazed and double glazed windows as well as fixed and hinged composite windows using accessories.
- Flat, external rain-repellent grille does not obstruct venetian blinds or roller shutters.
- Service-friendly and installation-friendly. Room-side casing parts can be removed for cleaning without tools.
- Shutter function can be switched to static ventilation (without fan operation).
- Energy-saving EC-Motor in protection category IP54 with maximum efficiency level.

Description GX 225

- Fan in medium performance class offering high convenience and integrated function switch which enables the following

Reference

Page

Speed controllers, controllers & turn-off delay switches 591 ff.

Product range			
Technical data	GX EC 150	GX 225	GX 300
Ref. no.	09367	01484	01485
Electrical inner shutter	Available	Available	Available
Reversible (supply & extr. ventilation)	Not available	Available	Available
Pane cutout Ø mm	184 mm	257 mm	324 mm
Flow rate free blowing m ³ /h	230	670	1650
Impeller Ø mm	150	225	300
Power consumption Watts	10	45	125
Voltage, 50 Hz (GX EC 150 - 50/60 Hz)	230 V	230 V	230 V
Rated current A	0.06	0.3	0.7
Speed min ⁻¹	1480	1250	1250
Sound pressure ¹⁾ /power dB(A)	44/52	54/61	61/68
Weight approx. kg	1.4	4.0	7.0
Wiring diagram no.	1385	538	538

¹⁾ at 1 m free field conditions. ²⁾ with reversing switch. ³⁾ with two speeds and reversing switch.

Accessories Window fan			
Type	GX EC 150	GX 225	GX 300
Double glazed window mounting kit			
for closed panes	DR 150 ⁴⁾	DR 225 ⁴⁾	DR 300 ⁴⁾
Ref. no.	05114	05115	05116
Wall installation			
with screw fastening, 50 cm long	SB 50/2	SB 50/3	SB 50/4
Ref. no.	01385	01386	01387
with feed duct	KR 150 ⁵⁾	WER 225/250 ⁶⁾	WER 300 ⁷⁾
Ref. no.	05091	00369	00469
Elec. speed controller flush/surface	—	ESU 1/ESA 1	ESU 1/ESA 1
Ref. no.	—	00236/00238	00236/00238
Elec. speed controller ²⁾ surface-m.	—	BSX	BSX
Ref. no.	—	00240	00240
Operating switch ²⁾ flush-mounted	—	DSEL 2	DSEL 2
Ref. no.	—	01306	0130
Operating switch ³⁾ surface-mounted	—	FR 22/30	FR 22/30
Ref. no.	—	00998	00998

⁴⁾ Spacer rings for underpinning from 2–35 mm (1 set = 10 pcs).

⁵⁾ 330 mm long. ⁶⁾ 170 – 500 mm long. ⁷⁾ 170 – 450 mm long.

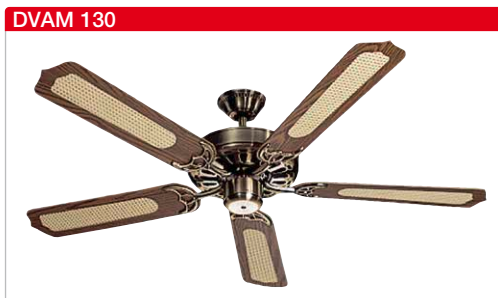

For cooling in summer and energy conservation during winter. For a wide range of applications, e.g. air circulation, cooling and energy conservation in medium and large rooms such as foyers and waiting halls, restaurants, clubs, boutiques and sales-rooms, production halls, warehouses, tennis halls and sports halls as well as the acceleration of drying processes in industrial buildings.

Ceiling fans are traditionally used for cooling air in the summer. They also solve acute room air problems in sales rooms, restaurants and many other communal areas with conditions such as windowless room areas or high heat from lighting. Decorative reproductions in the "Casablanca" design also make Helios ceiling fans an attractive design element for many rooms.

The energy-saving use of ceiling fans is recommended during heating periods. Draught-free and even room heat distribution is achieved by slowly rotating ceiling fans in rooms with

high ceilings such as sports halls, tennis halls, industrial halls and warehouses. This results in an approx. 25% temperature increase at floor level without additional heating costs. In this respect, the energy expenditure for the ceiling fans is negligibly small. Pilot installations which have been running over a number of years achieved an average temperature increase of 4 K at floor level.

Ceiling fans series DVW

- Robust metal version in classic design.
- Enclosed motor, maintenance-free and radio interference-free.
- Vibration-damping suspension for low-vibration running.
- Fall protection with arrester cable according to DIN EN 60335-2-80.
- Simple installation with pre-assembled delivery. Only the impeller blades need to be screwed on.
- Variable suspension height through delivery of a short and a long pendent tube.
- Speed-controllable with 5-step speed controller TSW 0.3 (accessories).

- Reversible air flow direction. The flow direction can be set to the floor or to the ceiling by fixed connection or using a reversing switch (accessories DSEL 2). Minimum starting voltage of 100 V required for reverse operation (upward air flow direction).

Ceiling fan series DVA

- Fan comes in typical "Casablanca" design for use for decorative purposes.
- Casing in antique brass or antique white finish. Five wooden blades with stained walnut or antique white cane work. Maintenance-free motor with covered cooling slots, ball bearing mounted, for continuous operation.
- Vibration-damping suspension for low-vibration running.
- Simple installation directly to the ceiling or short pendent tube (included in delivery).
- Pull switch for three performance levels and On/Off below the motor. A remote speed controller (accessories) can be connected.

Fan selection

The impeller diameter, positioning and suspension height of the ceiling fans are the parameters for even and extensive air flow in the room. The room height minus the pendent length provides the suspension height. Based on this height and the impeller Ø, the adjacent diagram shows the area affected by the air flow in m². The distance from the centre of the fan to the walls should be approx. 3 times the impeller Ø. The distance from the centre of a fan to the centre of another fan (when using multiple ceiling fans) should be approx. 6 times the impeller Ø. Operation at high speed is recommended in summer for cooling and operation at low speed is recommended in winter for energy conservation.

Important installation information

Accident prevention regulations (UVV) stipulate a minimum distance of 2.3 m from the floor to the lower wing edge.

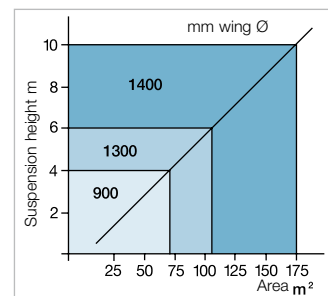

Accessories for DVW and DVA

Speed controller TSW 0.3 Ref. no. 03608
Five-step speed controller with On/Off switch for surface installation.

Energy-saving automatic control unit EDTW Ref. no. 01613
For fully automated differential temperature-dependent speed control, especially for the winter operation of ceiling fans.

Technical data – Order data				
Type	DVW 90	DVW 140	DVAW 130	DVAM 130
Ref. no.	08648	08649	08650	08651
Wing Ø mm	900	1400	1300	1300
Number of blades	3	3	5	5
Voltage / Frequency	1~, 230 V / 50 Hz	1~, 230 V / 50 Hz	1~, 230 V / 50 Hz	1~, 230 V / 50 Hz
Current consumption A	0.26	0.30	0.29	0.29
Power consumption W	50	75	66	66
Maximum speed min ⁻¹	340	270	220	220
Suspension height min./max. mm	440/565	460/585	220/360/510	220/360/510
Sound pressure dB(A) at 4 m	35	44	29	29
Weight approx. kg	4.8	6.8	6.7	6.7

STH

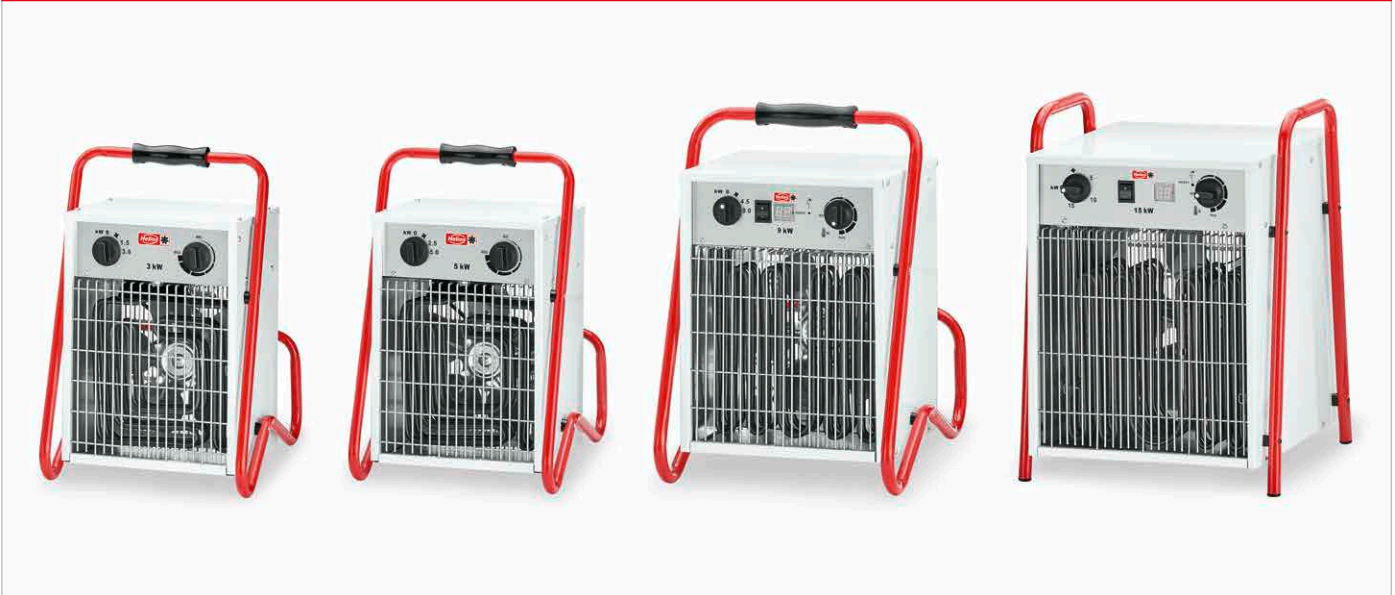

Dimensions STH 3

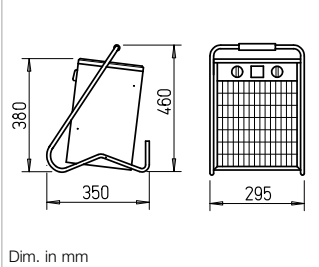

Dim. in mm

Dimensions STH 5

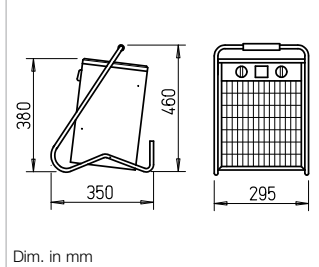

Dim. in mm

Dimensions STH 9 T

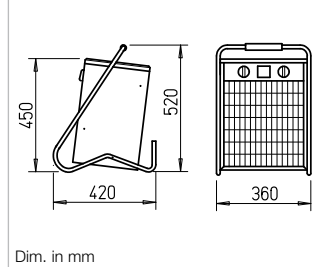

Dim. in mm

Dimensions STH 15 T

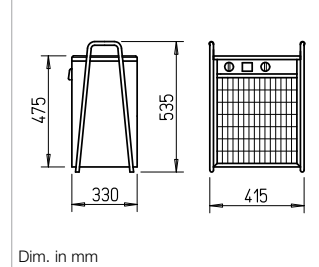

Dim. in mm

The compact, powerful STH heater fans are reliable, robust and convenient in terms of equipment. They are suitable for heating and drying. Use on construction sites, in production facilities, warehouses and workshops, churches, meeting rooms, etc.

- Series with heat output of 3 kW: 1~, 230 V as well as 5, 9 and 15 kW: 3~, 400 V.
- Practical operation due to compact dimensions.
- Attractive design.
- Easy to lift and transport due to ergonomically designed, solid transport hanger.

■ Quality in every detail

- Robust, hard-wearing and secure due to metal body. Suitable for use under hard conditions, even in wet rooms and for continuous operation.
- Corrosion-resistant casing, made entirely of galvanised steel sheet, powder-coated in pleasant white.
- Protective stand with powder coating in red.
- Robust front protection grille, powder-coated in hard-wearing grey.
- Clear control panel, protected against damage due to recessed mounting.
- Maintenance-free and radio

interference-free.

- All models in protection category IPX4. Applicable in wet rooms.
- Contact protection according to DIN EN 60335.
- Enclosed sheathed heating element made of stainless steel with low surface temperature.
- Easily accessible, externally resettable protection against overheating for types STH 9 T and STH 15 T. Automatically reactivating after cooling for STH 3 and STH 5.
- Individual time setting
All types from 9 kW are equipped with a timer for preprogrammed activation for

up to 24 hours under specification of the room temperature as standard.

■ Control

- Control via built-in operating switch.
- Heating for types with 3, 5 and 9 kW switchable in two levels; switchable in three levels for type with 15 kW.
- Heating operation can be controlled via built-in room air thermostat with setting range +5 °C to +35 °C. Fan remains in operation for better heat distribution in the room when the heating is deactivated.

Technical data

Type	STH 3	STH 5	STH 9 T	STH 15 T
Ref. no.	02520	02521	02522	02523
Heat output kW	3.0	5.0	9.0	15.0
Switchable heat output kW	0 – 1.5 – 3	0 – 2.5 – 5	0 – 4.5 – 9	0 – 5 – 10 – 15
Max. temperature increase K	25	37	38	35
Max. ambient temperature °C	40	40	40	40
Flow rate m ³ /h	400	400	700	1300
Speed min ⁻¹	1300	1300	1300	1300
Sound pressure dB(A) at 4 m (free field cond.)	40	40	43	58
Voltage V, 50 Hz	1~, 230	3~, 400	3~, 400	3~, 400
Rated current A	13.5	7.5	13.5	21.7
Req. socket / CEE coupling	¹⁾	16 A	16 A	32 A
Weight approx. kg	6.0	6.0	10.5	15.5
Timer function (pre-programming 24 h)	—	—	Yes	Yes

¹⁾ with approx. 1.5 m long cable and Schuko plug.

Helios: The system provider for controlled domestic ventilation.

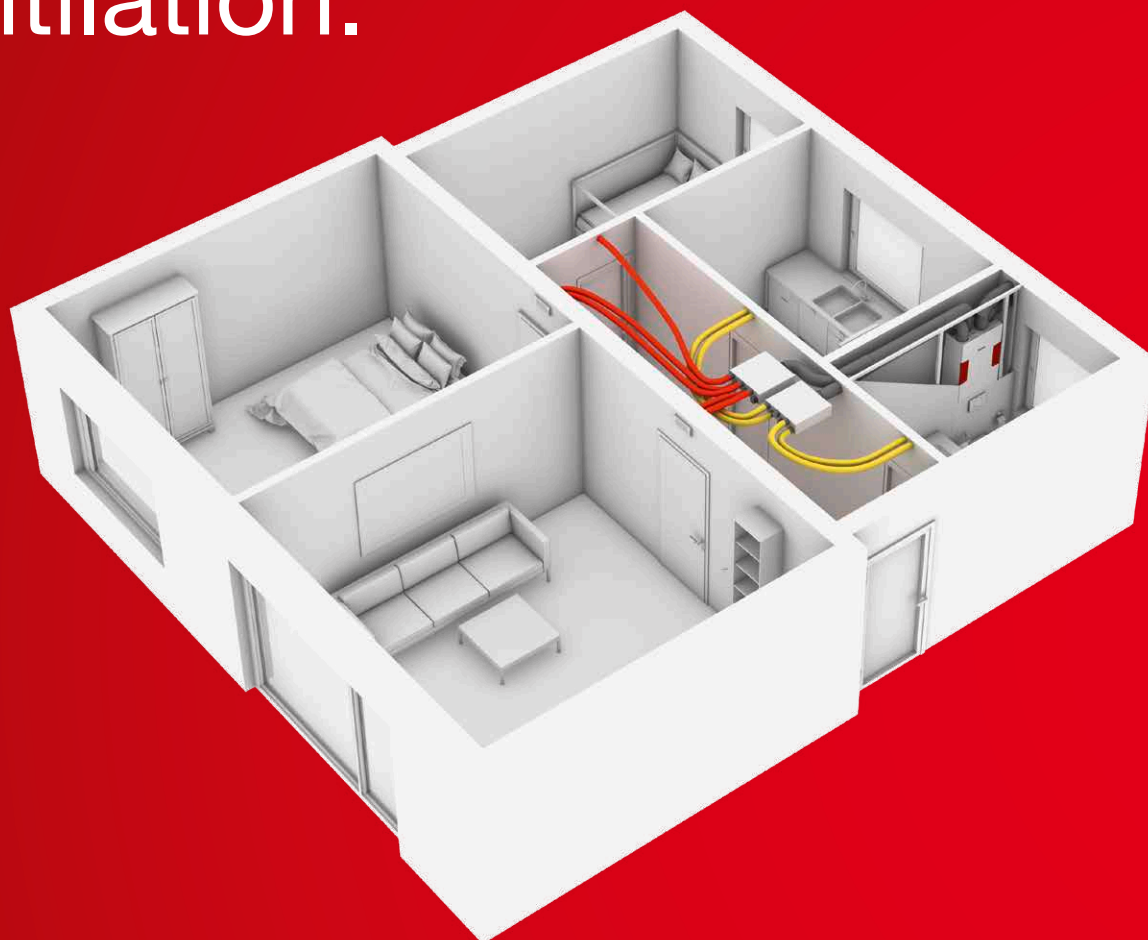

Humidity protection

The traditional ventilation of an apartment by opening the window is no longer an effective solution. Studies show that ventilation is insufficient and uncontrolled in 80 % of cases.

This cancels out the targeted energy savings made through expensive insulation measures. Cost-effectiveness, watertight building envelopes and the ventilation concept

for humidity protection increasingly require mechanical, controlled ventilation.

Feel-good atmosphere

Odours from kitchens, bathrooms and WCs as well as pollutants from cleaning agents, furniture, etc. should be removed for a comfortable, healthy room climate.

The humidity resulting from cooking, drying and showering (10–15 litres per day

in a 4 person household on average) should be transferred outside to prevent mould, mould stains and damp walls.

Healthy air

Helios provides optimal systems for all areas of application. Whether with or without heat recovery, for new buildings or renovations, in multi-floor construction or single-family houses, as a centralised or decentralised

solution. The corresponding ventilation units are completed with adapted and coordinated accessory parts.

The requirements of the German Energy Saving Ordinance (EnEV) are met in full and fire and sound insulation issues are also taken into account.

Planning info.

■ German standards

- DIN 1946-6
- DIN 18017-3

42^{ff}

Multi-floor construction.



■ Mono tube ventilation system ELS

- with individual units
- acc. to DIN 18017-3



44^{ff}

■ Central ventilation system ZLS

- with energy-saving EC roof fans
- acc. to DIN 18017-3



76^{ff}



Single-family houses, apartments.



■ Central extract ventilation box ZEB



82^{ff}

■ KWL ventilation systems

- with heat recovery



88^{ff}

■ KWL peripherals

- HygroBox
- Ground heat exchangers
- Air distribution systems
- Air inlets and outlets
- Wall / roof outlets etc.

144^{ff}

■ Ventilation concept

according to DIN 1946-6

- The residential building requirements in the German Energy Saving Ordinance (EnEV 2016) stipulate that a user-independent minimum air exchange level in residential units must be guaranteed for quality assurance and building protection. A ventilation concept must therefore be created according to DIN 1946-6 for each new building and energetic renovation. The ventilation concept answers the planning question as to whether a residential building is sufficiently ventilated by natural infiltration (building leakage) or whether a user-independent ventilation measure is required.

■ Procedure:

1. Calculation of volume flow for humidity protection according to DIN 1946-6

$$q_{v,ges,NE,FL} = f_{WS} \cdot (-0.001 \cdot A_{NE}^2 + 1.15 \cdot A_{NE} + 20)$$

$q_{v,ges,NE,FL}$ = Vol. flow for humidity protection m³/h
 A_{NE} = Area of utilisation unit in m²
 f_{WS} = Factor for taking the thermal protection of the building into account.
 0.3 for high thermal protection (building with insulation according to WSchV 95 or better).
 0.4 for low thermal protection (building with insulation worse than WSchV 95).

2. Calculation of volume flow through infiltration according to DIN 1946-6

$$q_{v,Inf,wirk} = f_{wirk,Komp} \cdot A_{NE} \cdot H_R \cdot n_{50} \cdot (f_{wirk,Lage} \cdot \frac{\Delta p}{50})^n$$

$q_{v,Inf,wirk}$ = Effective volume flow through infiltration in m³/h
 $f_{wirk,Komp}$ = Correction factor for allowable system and component-dependent infiltration according to DIN 1946-6 tab. 8, exact calculation based on calculation procedure in DIN 1946-6 appendix I. Standard value 0.5 (for purposes of simplification, the free ventilation in the form of cross ventilation is used as a basis to determine the ventilation measures in the ventilation concept).
 A_{NE} = Area of utilisation unit in m²
 H_R = Room height in m
 n_{50} = according to specifications in DIN 1946-6 or measured values. See table 1.
 $f_{wirk,Lage}$ = Correction factor for the effective infiltration air depending on the building location. Standard value 1.0, exact calculation based on calculation procedure in DIN 1946-6 appendix I.
 Δp = Design differential pressure
 For single-floor utilisation unit: 2 Pa for areas with low wind, 4 Pa for areas with high wind.
 For multi-floor utilisation unit: 5 Pa for areas with low wind, 7 Pa for areas with high wind.
 n = Pressure exponent, specified value $n = 2/3$ or measured value

3. Volume flow balancing

After calculating both volume flows $q_{v,Inf,wirk}$ and $q_{v,ges,NE,FL}$, both values are compared. If the volume flow through infiltration is lower than the volume flow for humidity protection, a ventilation

measure is required. The selected ventilation measure (e.g. Helios DV EC, ultraSilence® ELS, KWL®) must at least deliver the volume flows for humidity protection continuously and user-independently (24h/365 d).

Not only is the volume flow for humidity protection relevant for the further design of the residential ventilation system, but so too are the necessary volume flows for fulfilling and maintaining the minimum hygiene requirements. These must also be user-independently ensured for the most part.

■ Ventilation types / operating levels according to DIN 1946-6

□ **Ventilation for humidity protection (FL)**

Necessary ventilation to ensure building protection (humidity) under normal use conditions with partially reduced humidity loads. Example: Normal use conditions with partially reduced humidity loads include e.g. temporary absence of users and no drying of laundry in the utilisation unit.

Operating mode: Constant (24 h/365 d); user-independent

□ **Reduced ventilation (RL)**

Necessary ventilation to fulfil minimum hygiene requirements and to ensure building protection (humidity) under normal use conditions with partially reduced humidity loads and substance concentrations. Example: Following temporary absence of users.

Operating mode: Constant (24 h/365 d); user-independent

□ **Nominal ventilation (NL)**

Necessary ventilation to fulfil hygiene requirements and to ensure building protection in presence of users (normal operation). Operating mode: In presence of users; mostly user-independent; Guaranteed by suitable ventilation measures with temporary support from free ventilation (window ventilation).

□ **Intensive ventilation (IL)**

Temporarily necessary ventilation with increased air volume flow to reduce load peaks (load operation). Operating mode: Primarily in presence of users; time-limited for energy reasons; Guaranteed by suitable ventilation measures with temporary support from free ventilation (window ventilation).

Table 1: Specified values for design air exchange according to DIN 1946-6

House type	Standard	Ventilation system	n_{50} value
Single-floor utilisation unit (EFH)	New building	Fan-supported ventilation	1.0
Single-floor utilisation unit (EFH)	Renovation	Fan-supported ventilation	1.0
Multi-floor utilisation unit (MFH)	New building	Fan-supported ventilation	1.0
Multi-floor utilisation unit (MFH)	Renovation	Fan-supported ventilation	1.0
Single-floor utilisation unit (EFH)	New building	Free ventilation	1.5
Single-floor utilisation unit (EFH)	Renovation	Free ventilation	1.5
Multi-floor utilisation unit (MFH)	New building	Free ventilation	1.5
Multi-floor utilisation unit (MFH)	Renovation	Free ventilation	2.0

(EFH) = Single-family houses / (MFH) = Apartment buildings

■ Intake air inflow

A residential ventilation system according to DIN 1946-6 requires that the corresponding supply air volume flow equal to the extract air volume flow sum flows in using suitable intake air outlets (ALD) dimensioned according to DIN 1946-6.

Calculation of number of required intake air outlets (ALD) in building envelope:

$$n_{ALD} = (q_v - q_{v,Inf,wirk}) / q_{v,ALD}$$

n_{ALD} = No. required ALDs
 q_v = Extract air volume flow per residential unit
 $q_{v,Inf,wirk}$ = Volume flow through infiltration per residential unit
 $q_{v,ALD}$ = Volume flow per ALD

■ Sound insulation

DIN 4109 has been introduced under building law and it regulates the sound insulation requirements for buildings (public/private). For designs according to VOB (German Construction Contract Procedures) and two-family houses or terraced houses, it must be complied with as a minimum requirement. For single-family houses, it can be agreed.

The VDI Guideline 4100 has not been introduced under building law, but it is regarded as state-of-the-art by many. VDI 4100 is divided into two sound insulation levels (see table 2).

Framework conditions

The sound levels specified in DIN 4109 are technically achievable if targeted framework conditions are observed, e.g.:

- Shaft arrangement in floor plan
- Design of installation walls or shafts in 220 kg/m³
- Decoupling from structure
- Specification of sound insulation requirements
- Inclusion of an acoustician in sound insulation level (SSt) III according to VDI 4100
- Contractual safeguarding and specification of standard

Recommendation:

For private-law construction, determine in advance whether the design is based on DIN 4109 or VDI 4100.

■ Reference

Quick, secure and standard-compliant ventilation concept creation acc. to DIN 1946-6 at the click of a mouse and free of charge.

www.KWLeasyPlan.de

Table 2: Noise limit values (DIN 4109-1)

Noise sources	Type of rooms in need of protection		
	Living rooms, bedrooms	Classrooms, workspaces	
Sound pressure level dB (A)			
Water installations (water supply and wastewater systems together)	$L_{In,max} \leq 30^a$	$L_{In,max} \leq 35^a$	
Other domestic installations	$L_{AF,max} \leq 30^b$	$L_{AF,max} \leq 35^{b*}$	
Operation	during the day 6 to 22 hrs	$L_r,max \leq 35$	$L_r \leq 35$
	at night 22 to 6 hrs	$L_r,max \leq 30$	$L_r \leq 35$

^a Individual short-term peaks caused when operating the fittings and units according to appendix B, table B.1 (opening, closing, adjusting, interrupting) are not included at present.

^b Values that are 5 dB(A) higher are permissible for ventilation systems, provided this concerns continuous noises without noticeable individual tones.

* Unless higher levels are also acceptable due to higher inherent noise generation.

- **DIN 18017-3 is the generally accepted technical regulation for the planning and installation of ventilation systems in bathrooms and toilet rooms without external windows. Rooms of this kind are very common in existing multi-floor buildings and they are also regularly found in residential construction projects.**

DIN 18017-3 primarily refers to the extract ventilation of internal bathrooms and toilets and thus it exclusively refers to individual rooms. It contrasts to DIN 1946-6 which refers to the ventilation of apartments in general and thus considers the entire utilisation unit. When planning and implementing an extract air system, it needs first to be determined whether the building is residential and non-residential.

- **Procedure for residential buildings**

Regardless of whether it is a single-family house or apartment building, a new building or renovation building, the ventilation approach begins with the ventilation concept stipulated in DIN 1946-6. The assured user-independent and continuous ventilation for humidity protection has clear impacts on the extract air system concept.

- The extract air volume flow requirements according to DIN 18017 differ with regard to whether the extract ventilation will be continuous (40 m³/h) or demand-based (60 m³/h). With regard to demand-based systems, the volume flow can be reduced to 0 in periods of low air requirement. Continuous ventilation for humidity protection, as stipulated in DIN 1946-6, is not intended. As a consequence, two level ventilation units are used for extract air systems in residential buildings. The basic level (30 m³/h) is connected to the continuous current and cannot be switched off by the user. The requirement to implement ventilation for humidity protection is thus sufficiently met. The higher level (60 m³/h or 100 m³/h) is activated based on requirements. This takes place via activation by the user or with humidity control or presence control functions.
- In order to guarantee the functionality of an extract air system in modern and thus watertight building envelopes, the planning and installation of intake air outlets are essential. The extract air volume flow must be equalised with an equal volume flow of supply air through the building envelope using appropriate intake air outlets. The infiltration

through the building envelope (previously calculated in the ventilation concept) is deducted when dimensioning the intake air outlets (ALD).

- With regard to renovation properties, it should be clear to all project participants that the presence of an extract ventilation system according to DIN 18017-3 does not exempt them from creating and maintaining a ventilation concept according to DIN 1946-6. The volume flow for humidity protection must always be guaranteed. It is also necessary that a supply air volume flow corresponding to the sum of the extract air volume flows constantly flows through the building envelope. If the extract air volume flow sum is lower than the volume flow required for humidity protection, the extract ventilation system must at least be adjusted to this humidity protection volume flow.

- **Planning guideline for extract air systems**

Residential construction
New building:

- Creation of a ventilation concept according to DIN 1946-6.
- Design of controlled supply and extract ventilation according to DIN 1946-6.
- Installation of at least two-level individual room fans to guarantee the ventilation for humidity protection and the flow volumes stipulated in DIN 18017. Assured supply air flow by selecting suitable intake air outlets.

Residential construction
Renovation:

- Creation of a ventilation concept according to DIN 1946-6.
- Comparison of on-site extract air volume flows with the minimum volume flow for humidity protection.
- If necessary, retrofitting of suitable intake air outlets.
- If necessary, substitution of existing single-level individual room fans with multi-level units.

- **Procedure for non-residential buildings**

Beyond the usual area of application for DIN 18017-3, the standard is continuously applied in the ventilation of internal WC units and other extract air rooms in non-residential buildings. In contrast to residential buildings, there is no regulatory commitment to guarantee ventilation for humidity protection for non-residential buildings of any kind. The need for ventilation technology in WC units is regulated in the Workplace Ordinance and other building guidelines. The standard requirements can be carried over

unchanged for ventilation systems in non-residential buildings which are planned and building according to DIN 18017-3.

- **System types**

□ The individual extract ventilation systems are also divided into systems with their own extract air pipes and systems with shared extract air pipes. Due to their many advantages (e.g. space-saving with just one pipe), systems with shared extract air pipes are preferred in practice.

□ The central extract ventilation systems are divided into two subcategories. These are central extract ventilation systems with only jointly changeable volume flows and um central extract ventilation systems with apartment-changeable volume flows (e.g. DV EC in combination with extract air elements AE).

□ The pure extract ventilation of individual rooms is within the scope of application of DIN 18017-3. If there are no ventilation requirements for the project in terms of DIN 1946-6, the following planned volume flows shall apply:

40 m³/h for central extract ventilation systems.

– This volume flow must be removed continuously.
– The extract air volume flow may be reduced by half in periods of lower air requirement, mainly at night, but not for more than 12 hours per day.

60 m³/h for decentral extract ventilation systems.

– This extract air volume flow must be removed during use for demand-controlled systems.

– The ventilation unit may be reduced to 0 in periods of lower air requirement if the building complies with the thermal protection standard in the Heat Insulation Ordinance 1995 or better.

– The same volume flows apply for kitchens.

– These volume flows may be reduced by half for WC rooms.

- **Project planning information**

The main extract ventilation pipe should be straight and vertical with a constant cross-section, otherwise computational proof according to DIN 18017-3 will be necessary. The main extract ventilation pipe must have thermal insulation to protect it against condensate damage. Alternatively, condensate drains can be fitted.

□ Bathrooms and WCs may be extract ventilated using a fan. A branch connection kit can be used for this purpose.

□ Bathrooms and kitchens must be extract ventilated using separate fans. The connection of

extraction hoods to DIN 18017-3 systems is excluded. Separate pipes must be planned for this purpose.

- The extract air pipes must be permanently watertight and stable. A sufficient number of suitable cleaning openings must be provided. Screw-in cleaning openings are not permitted.

- **Special planning features for central extract ventilation systems**

□ With regard to central extract ventilation systems with only jointly changeable volume flows, only extract air valves with the same performance curve may be used. Valve adjustability after unit adjustment must be excluded. Systems of this kind are for continuous operation. Volume flow reductions in periods of lower air requirement must be automatic (e.g. via timer).

□ Central extract ventilation systems with apartment-changeable volume flows have adjustable extract air elements with variable performance curves. The extract air valves are operated by the apartment user or controlled automatically via room air sensors. The demand-controlled volume flow adjustment then only takes place in the respective apartment. Other apartments remain unaffected by the change due to volume flow stabilisers integrated in the extract air elements. The fan flow rate automatically adjusts to the total volume flow to be delivered.

- **Fire protection**

The fire protection for extract air systems according to DIN 18017-3 is regulated in the specimen guideline on fire protection requirements pertaining to ventilation systems (MLüAR) in section 7 "Special provisions for ventilation systems according to DIN 18017-3". All products approved for this purpose are provided with the identification code 18017-3 under building regulations and they may only be used in those systems. Any use of these fire protection products in other systems (e.g. residential ventilation systems with heat recovery) is not permitted.

ultraSilence® ELS.

The mono tube ventilation system acc. to the German standard DIN 18017-3.



ultraSilence® ELS offers the ideal solution for the extract ventilation of internal bathrooms and WCs in residential units, hotels and other buildings as stipulated in DIN 18017-3.

- **Space-saving:**
One central riser pipe over more than 20 floors with a minimal cross-section saves money and precious living space.
- **Cost-effective:**
Low material requirements and the quick and easy installation result in manageable time and cost expenditure.
- **Energy-saving:**
The ultraSilence ELS-units reduce the ventilation heat requirement and thus contribute to the saving of heating energy.
- **Simple planning:**
The DIBt approval certificate makes all other measurements unnecessary upon formal acceptance of the building. This offers you security and saves a great deal of aggravation.

The costs for planning, riser pipe dimensioning, tendering and specifications are reduced to a minimum.
- **Environmentally friendly:**
The EC motors make ultraSilence ELS a real wonder of efficiency and they reduce energy costs by up to 70%.
- **Compact:**
ultraSilence ELS benefits from an installation depth of just 89 mm.



ultraSilence
by Helios



■ Extract air

The wonderfully quiet ELS units are controlled as required and they extract stale air from kitchens, bathrooms and WCs via a central main pipeline to which more than 20 floors or more than 40 individual units can be connected.



58^f

■ Fire protection

Local fire protection requirements must be met when planning and installing ventilation systems. Helios hereby offers ideal solutions for various structural conditions.



64^f

■ Intake air

In order to ensure perfect operation of the extract air systems, even with watertight building envelopes, the installation of intake air outlets is essential. Helios offers elements for wall and window installation, manually or temperature-controlled, with automatic volume flow adjustment and sound insulation.



71^f

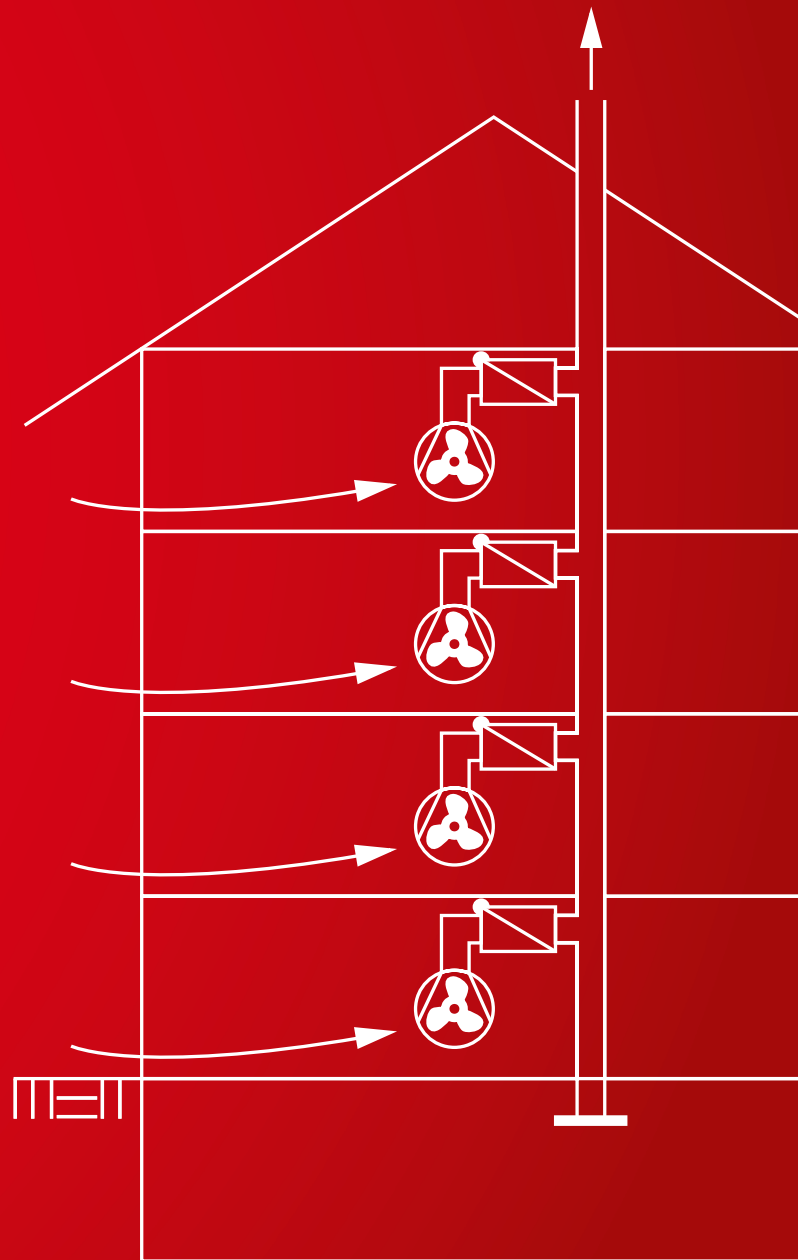

The Helios ELS dimension. Quiet. Powerful. Flat. Attractive.



Revolutionary and intelligent:
ELS-VF types with automatic humidity control for a pleasant room climate with optimal energy savings and without mould. More on page 58.



Barrier-free and automatic:
ELS-VP with presence detector for demand-controlled ventilation when presence is detected. Optimal for toilets and sanitary rooms in hotels, offices, homes, etc. More on page 59.



Unique: Filter cleaning indicator signals contamination. The large-surface permanent filter is dishwasher safe and saves the purchase of expensive throwaway filters.



Flexibility without limits: Casing types ELS-GU and ELS-GUBA for single room or two room ventilation with connection to the left, right, bottom or for WC connection. Outlet connectors to the top, left, right or back.



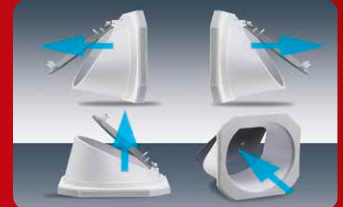

Smart: The airtight backdraught shutter in the outlet connector can be rotated 90°. This allows a casing position with an outlet to the left, right, top or back.



Intelligent electronics for a wide variety of operating modes: such as interval, turn-off delay, humidity, presence, etc. Circuit board with plug pins in jet-waterproof casing for electrical connection.



Economical energy-saving motor: Noise-tested long-life ball bearings for 40,000 operating hours in any position. Maintenance-free, in enclosed die-cast aluminium casing.



Optimal solution for every requirement: More than 20 different ELS fan units can be installed in the same surface or flush-mounted casing by hand, without tools.

- Only 26 dB(A)*. Fantastically quiet.

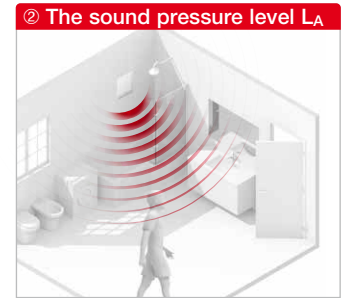
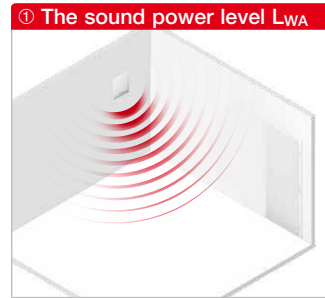

Ventilation must be almost silent, especially in multi-floor construction. This requirement is fully met with the individual ventilation units ultraSilence ELS. ultraSilence ELS is unbeatably quiet at 26 dB(A)* when operated at the basic ventilation level ($V=35 \text{ m}^3/\text{h}$) and 35 dB(A)* at $V=60 \text{ m}^3/\text{h}$ and $A_L = 10 \text{ m}^2$.

The noise levels shall be stated as follows according to DIN 18017-3 and guaranteed by Helios:

- Sound power level, A-weighted (L_{WA}) in dB(A) or
- Sound pressure level, A-weighted (L_A) in dB(A) referring to an absorption area $A_L = 10 \text{ m}^2$. If $A_L = 10 \text{ m}^2$ is referred to, the result is 4 dB(A) lower sound levels*.

① The sound power level L_{WA} indicates the actual sound power output, regardless of distance and room conditions. Objective and verifiable.

② The sound pressure level L_A is caused by the sound source and perceived by the ear. Depending on absorption, i.e. absorption capacity of the room, the perceived sound varies and it is therefore difficult to verify.

* Data according to DIN 18017-3, section 7.1.2 footnote 5

- Exclusive. With permanent filter and filter cleaning indicator.

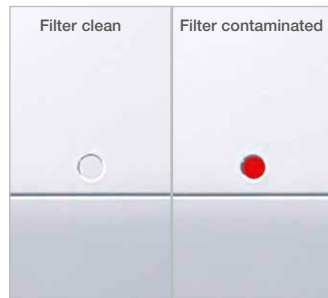

All ELS fan units are equipped with permanent filters as standard. This eliminates uncertainty and hassle in connection with the bothersome procurement of replacement filters. Satisfied tenants, landlords and owners are the result. The red signal point shows the contamination of the permanent filter and the associated drop in performance. Very practical!

User-friendly – the hinged folding facade. Conveniently opens upward by hand for filter removal. Simply drop to close.

Completely sealed. The surrounding, flexible seal prevents air intake and dirt accumulation along the wall/ceiling surface.

Unique – the permanent filter. Extremely large surface area, with high dirt holding capacity for long cleaning intervals. It can easily be cleaned in the dishwasher and thus saves the constant purchase of expensive throwaway filters.

- Outstanding design. Attractive. Flat. Clean.

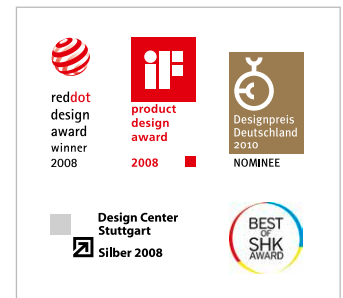
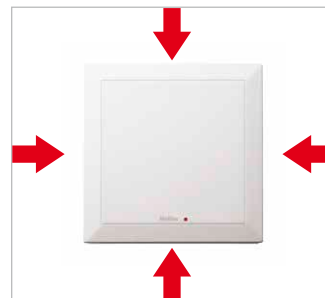

Perfectly designed and multiple award-winning. ultraSilence ELS can go everywhere: The inner facade fits to any tile, wallpaper or marble – it meets the highest standards. The facade in minimalist, ultra-flat design with high-quality appearance covers the fan unit. The air flows in from the side, thereby preventing unpleasant dirt accumulation.

The ultra-flat premium facade design stands out with subtle elegance in every room. The flush-mounted casing is extremely flat at an installation depth of just 89 mm. Thus, ELS also integrates in small rooms, on the wall or ceiling. It is the ideal solution, even in narrow installation shafts.

Rapid installation.

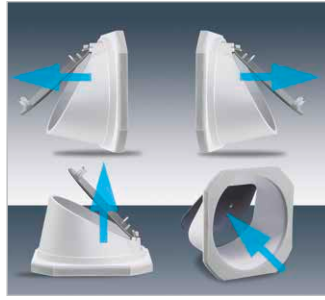

Smart. The airtight backdraught shutter integrated in the outlet connector can be rotated 90°. This allows a casing position with an outlet to the left, right, top or back.



Unlimited possibilities. ELS-GU and ELS-GUBA are universal casings for single room or two room ventilation with connection to the left, right, bottom or for WC connection via the flush pipe. The outlet connector can be positioned to the top, left, right or back. All with the same casing!



It couldn't be easier – the electrical plug connection. The unit can be removed from its bracket for convenient connection. The cable entry and connection of coupling takes place during casing installation. The fan unit with facade is inserted during equipment installation.

Approved and tested.

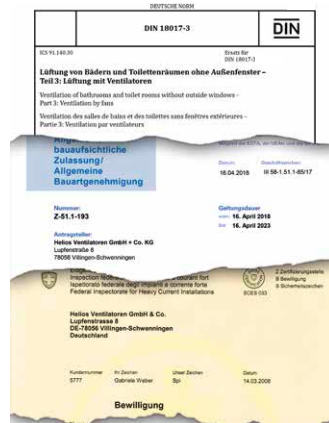

All casings and fan units are DIBt-approved (general technical approval), Z-51.1-193.

The ultraSilence ELS range is DIBt-approved (German Institute of Building Technology) and it has international approval marks. It complies with the relevant standards and regulations. The following test certificates are also available:

- TÜV-tested performance curve.
- Sound insulation in building construction (DIN 4109) tested by the Institute for Acoustics and Building Physics (IABP), Oberursel.
- TÜV-tested air leak rate of the extract air backdraught shutter.
- Third-party production monitoring by TÜV SÜD.
- Testing of fire protection shut-off valve and casing by the materials testing institute of the Institute for Building Materials, Concrete Construction and Fire Protection (IBMB), Brunswick, Swiss Fire Protection Register Z 5491.



ÖVE, SEV, ITB not valid for EC types.

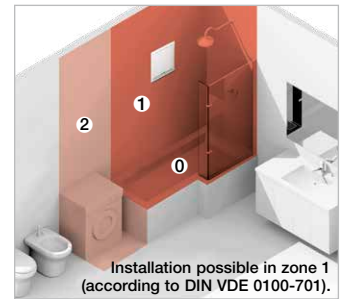

Various operating modes.

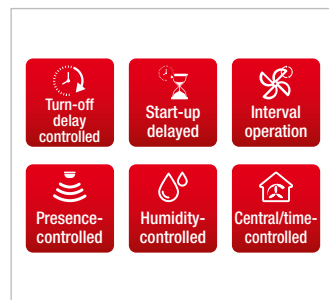

ELS ventilation units are available in more than 50 variants and three performance classes for the ventilation of kitchens, bathrooms and WCs in residential buildings. Also available with EC technology and thus up to 70 % energy savings upon request. Use-oriented controls with turn-off delay and interval functions as well as presence detector or humidity control functions (in the basic

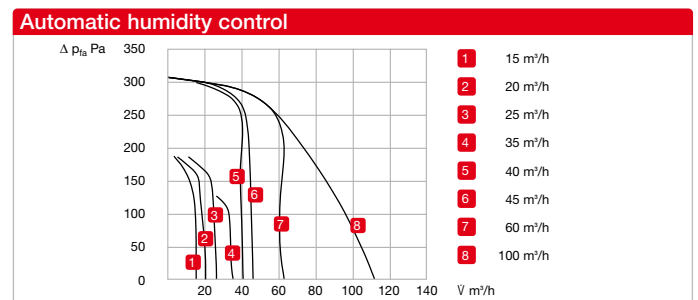

ventilation and demand-controlled ventilation levels) are integrated in the units for barrier-free automatic operation.

60 m³/h volume output at 260 Pa. This pressure figure puts Helios ELS at the forefront of high performance class. This permits the smallest pipe cross-sections, reduces investment costs and increases usable living space.

Reference Page

Further information on the ELS unit types for barrier-free automatic operation

- with humidity control function
- or presence detector

See page 51

■ **The Energy Saving Ordinance (EnEV 2016) requires the implementation of the low-energy building standard. The ventilation heat requirement is of particular importance due to the modified construction method and associated watertight building envelope.**

Based on previous construction methods, the percentage of ventilation technology in total heating energy consumption was only around 25%. This percentage is now at least 50% in a modern residential building due to watertight thermal building envelopes.

A building design according to EnEV 2016 allows for the comparison of a planned residential building with a reference building. A demand-controlled extract air system is standard in the reference building according to EnEV 2016. The minimum air exchange during window ventilation can be reduced from 0.7 h^{-1} or 0.6 h^{-1} (with/without leak test) to 0.4 h^{-1} in the EnEV verification procedure due to controlled domestic ventilation using a demand-controlled extract air system. The allowable air exchange can

even be minimised to 0.35 h^{-1} by using Helios VF-AL system technology. This reduction of the minimum air exchange normally results in a primary energy consumption reduction of approx. 10%. This makes it much easier to fulfil the requirements to receive KfW funding (KfW efficient houses).

■ **Helios VF-AL system technology with humidity-controlled ventilation control is an optimised solution for today's standard, also in terms of price.**

It is adapted to the entire apartment and operates in accordance with the principle of negative pressure ventilation. The rooms with contaminated air (bathrooms, WCs, kitchens) are extract ventilated. Fresh intake air flows into the living rooms and bedrooms via pressure-controlled intake air flow elements.

■ **The system components**

□ **ELS-VF**

Humidity-controlled extract air fan in the bathroom with intelligent humidity control function for eliminating unwanted high levels of humidity. The type of

■ **Energy-efficient, demand-optimised control functions are integrated in the ELS units.**

Sophisticated technology allows demand-controlled, efficient ventilation according to building-related and room-related tasks.

□ **Barrier-free automatic operation** controlled by integrated presence detector or humidity control functions. See adjacent and right page.

■ **What is optimal and when?**

□ **Demand-based ventilation with turn-off delay**

Typical use: For the ventilation of internal bathrooms and WCs (turn-off delay stipulated by DIN 18017) with normal frequency of use, e.g. in residential areas.

Applicable units: Types ELS-VN, ELS-VNC or standard units with separate turn-off delay switches.

Control: Manual, potentially parallel with light.

□ **Demand-based ventilation without turn-off delay**

Typical use: For the ventilation of kitchens and rooms with windows. High frequency of use in residential buildings, hotels, homes, etc.

Applicable units:

All standard types ELS-V

Control: Manually via commercial installation switches or automatically via timer.

□ **Demand-based ventilation with turn-off delay, presence or humidity control function**

Typical use: For barrier-free automatic operation in bathrooms, toilets and kitchens as well as rooms with windows.



humidity increase is continuously tested with microprocessor controls. The ventilation is demand-based, combined with a turn-off delay-controlled ELS in the WC or kitchen.

□ **Intake air flow elements**

Intake air flow elements for the reliable and efficient inflow of

supply air.

Types ALEF or ZL for installation in window frames or walls.

Extract air systems without suitable intake air flow elements are unusable and they are not consistent with good engineering practice.

Applicable units:

ELS types ELS-VF and ELS-VP.

Function/control:

Automatic, presence-controlled or humidity-controlled ventilation without switch operation. See right page for detailed description.

□ **Interval ventilation**

Use: For the ventilation of bathrooms and WCs (also internal) with periodically lower frequency of use, e.g. in hotel rooms, holiday apartments, student residences.

The adjustable interval and operating periods ensure periodic and economical room ventilation in the absence of people. Stuffy rooms and humidity damage are prevented.

Applicable units: ELS-VNC or standard types in combination with accessory ZNI.

Function: Automatic operation according to the specified settings in case of the non-utilisation of space.

Turn-off delay according to selected settings in case of manual operation (potentially via parallel switching with light).

□ **Time-controlled ventilation**

Use: Ventilation of toilets, showers, bathrooms and other rooms in offices and administrative buildings, in homes, hospitals, etc.

Control: In intervals or depending on use, i.e. at certain times of the day.

□ **Basic and demand-based ventilation**

Use: For the ventilation of showers, bathrooms, WCs with high air contamination (e.g. in restaurants, offices).

Continuous, low-noise basic ventilation operation prevents odour nuisance and excessive humidity. Manual switching to high output (demand-based ventilation level) when rooms are in use. This is also possible automatically during certain times of the day with a timer.

Applicable units: All types with 2 or 3 performance levels.

Switching: DSEL 2 or DSEL 3 required for manual operation. We recommend suitable components for automatic operation.

■ **The top solution for barrier-free automatic operation: Integrated presence detector**

Optimal fan control in toilets and sanitary rooms for commercial and private use, e.g. homes, hotels, offices, etc.

- Helios provides the perfect solution: ELS-VP is equipped with a presence detector; the fan comes on automatically when someone enters the room. The electrical connection is simply to the nearest socket, without switch operation.

- ELS-VP with presence detector automatically provides extract ventilation based on demand when someone enters the room.

- An integrated infrared sensor registers the presence of a person and activates the fan. The operating period is 15 minutes. If another movement is registered within this period, the operating period will extend accordingly.

- There is a turn-off delay of 15 minutes when people leave the room.

- Optimal detection is achieved when the prevailing direction of movement in the room is at right angles to the sensor. During installation, it must be ensured that the presence detector is not obstructed by obstacles.

Typical use: Barrier-free, automatic ventilation without switch operation.

Control: Presence-controlled.

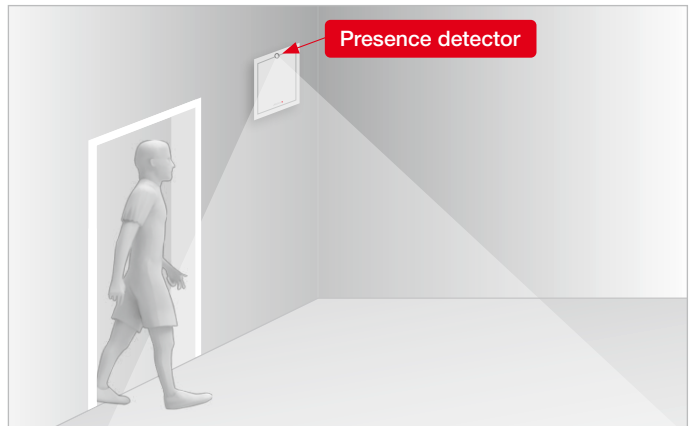
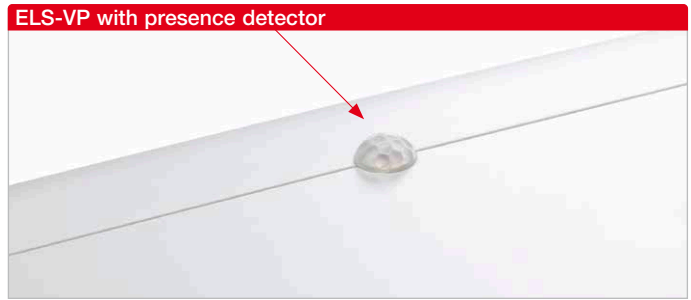

■ **The ELS-VF automatic humidity control function is far superior to conventional hygrostats and it effectively prevents moisture condensation on walls, ceilings and equipment. It guarantees a healthy environment without mould and unpleasant odours with minimal energy expenditure.**

- **Advanced electronics**
ELS-VF units are equipped with a fully automatic, humidity-dependent control system. The microprocessor-controlled electronic system recognises two different types of humidity increase:
 - In case of a normal humidity increase (e.g. due to washing, drying laundry, temperature reduction), the fan will activate when the selected setpoint is reached and it will run until the room humidity has fallen by approx. 10%, but at least for the duration of the set turn-off delay period.
 - In case of a rapid humidity increase (e.g. due to showering, bathing), the fan will activate before the selected setpoint is reached to eliminate the excessive humidity in the room as effectively and quickly as possible. This prevents foggy mirrors or walls; the comfort zone in the room (40-70% RH) is quickly restored.

The fan will deactivate as soon as the relative humidity has fallen by approx. 10%, but no earlier than the end of the set turn-off delay period.

- In case of a longer, excessive humidity increase (e.g. thunderstorms in summer, damp laundry in the room) or in case of insufficient air exchange due to under-sized or closed inlet openings, the fan will automatically deactivate after 2 hours of continuous operation. In these cases, the control system has recognised that further ventilation will not result in humidity reduction. Depending on the further humidity curve, the fan will automatically activate within the next 2 to 6 hours to reduce the humidity by approx. 10% again. This control behaviour is repeated until the humidity has fallen to the desired value. Thus, the automatic humidity control function ensures that optimal humidity reduction is achieved with minimal energy consumption.

- **Typical use:** For the ventilation of humid rooms (e.g. bathrooms and kitchens).
- **Control:** Barrier-free automatic operation according to the humidity curve.

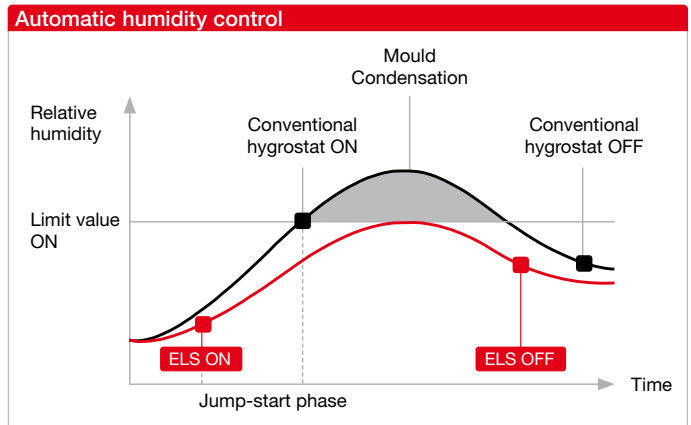

- An unobstructed supply air flow is required so that humid air can be extracted by the fan.

Now you can easily
determine **the diameter**
of the main line.

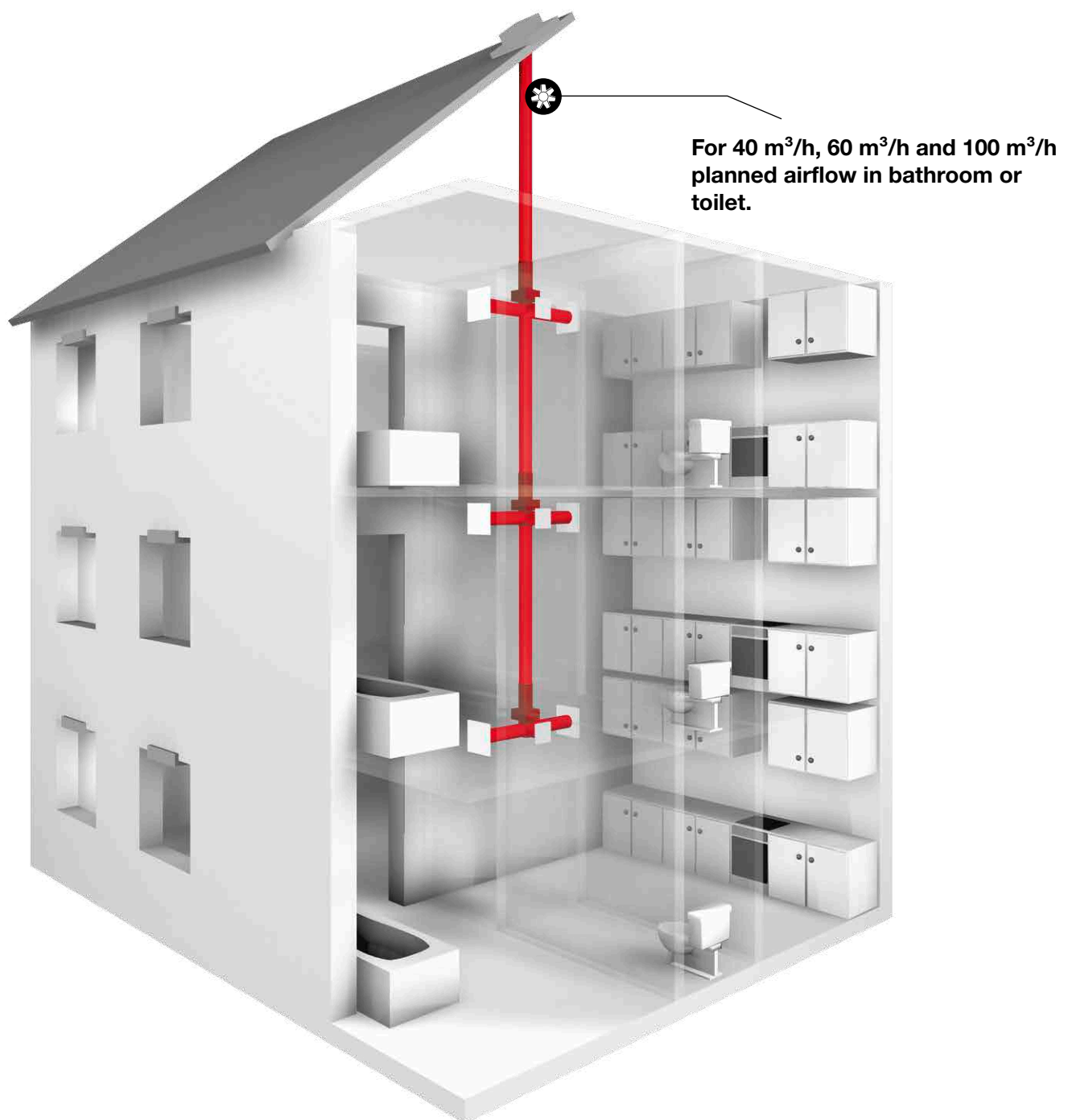

40 m³/h Bathroom or WC

With 40 m³/h planned flow rate and simultaneous operation of all units.

A up to 5 m/s

One unit per floor	Two units per floor
Number of floors	Number of floors
40	24
38	19
31	15
24	12
19	9
15	7
12	6
9	5
7	4
6	3
3	1

Riser pipe diameter

B up to 7 m/s

One unit per floor	Two units per floor
Number of floors	Number of floors
—	33
—	26
40	21
32	17
27	13
21	10
17	8
14	7
10	5
8	4
5	2

Riser pipe diameter

C up to 11 m/s

One unit per floor	Two units per floor
Number of floors	Number of floors
—	—
—	40
—	32
—	26
40	21
33	17
27	13
21	10
16	8
13	6
8	4

Riser pipe diameter

A Increased comfort zone up to 5 m/s in riser pipe

with simultaneous operation of all units. The increase in noise level due to the constant flow rate control is very low up to this operating point.

B Comfort zone up to 7 m/s in riser pipe

with simultaneous operation of all units. The increase in noise level due to the constant flow rate control is in the comfort zone up to this operating point.

C Max. permitted design pressure up to 11 m/s in riser pipe

with simultaneous operation of all units. The main line dimensioning pursuant to building approval is allowed up to this operating point.

Note: Building law examination and compliance with building law requirements required. If additional pipe components or roof penetrations are used, there may be deviations from the number of floors shown.

60 m³/h Bathroom or WC

With 60 m³/h planned flow rate and simultaneous operation of all units.

A up to 5 m/s

One unit per floor	Two units per floor	Number of floors	Number of floors
31	15	Ø 355	
25	12	Ø 315	
20	10	Ø 280	
16	8	Ø 250	
13	6	Ø 225	
10	5	Ø 200	
8	4	Ø 180	
6	3	Ø 160	
5	2	Ø 140	
4	2	Ø 125	
1	1	Ø 100	

Riser pipe diameter

B up to 7 m/s

One unit per floor	Two units per floor	Number of floors	Number of floors
40	21	Ø 355	
34	17	Ø 315	
27	14	Ø 280	
22	11	Ø 250	
18	9	Ø 225	
14	7	Ø 200	
11	5	Ø 180	
9	4	Ø 160	
7	3	Ø 140	
5	2	Ø 125	
3	1	Ø 100	

Riser pipe diameter

C up to 11 m/s

One unit per floor	Two units per floor	Number of floors	Number of floors
—	34	Ø 355	
—	27	Ø 315	
40	22	Ø 280	
35	17	Ø 250	
27	14	Ø 225	
21	11	Ø 200	
18	9	Ø 180	
14	7	Ø 160	
11	6	Ø 140	
9	4	Ø 125	
5	3	Ø 100	

Riser pipe diameter

A Increased comfort zone up to 5 m/s in riser pipe

with simultaneous operation of all units. The increase in noise level due to the constant flow rate control is very low up to this operating point.

B Comfort zone up to 7 m/s in riser pipe

with simultaneous operation of all units. The increase in noise level due to the constant flow rate control is in the comfort zone up to this operating point.

C Max. permitted design pressure up to 11 m/s in riser pipe

with simultaneous operation of all units. The main line dimensioning pursuant to building approval is allowed up to this operating point.

Note: Building law examination and compliance with building law requirements required. If additional pipe components or roof penetrations are used, there may be deviations from the number of floors shown.

100 m³/h Bathroom or WC

With 100 m³/h planned flow rate and simultaneous operation of all units.
(Volume e.g. kitchen = 100 m³/h. With two-room ventilation via 1 unit = Bathroom 60 m³/h, WC 40 m³/h)

A up to 5 m/s

One unit per floor	Two units per floor
Number of floors	Number of floors
18	9
15	7
11	6
9	4
7	3
6	3
5	2
3	2
3	2
2	1
1	1

Riser pipe diameter

B up to 7 m/s

One unit per floor	Two units per floor
Number of floors	Number of floors
25	12
20	10
16	8
13	6
10	5
8	4
6	3
5	2
4	2
3	1
2	1

Riser pipe diameter

C up to 11 m/s

One unit per floor	Two units per floor
Number of floors	Number of floors
29	17
24	14
20	11
16	9
13	8
10	6
8	5
6	4
5	3
4	2
2	1

Riser pipe diameter

A Increased comfort zone up to 5 m/s in riser pipe

with simultaneous operation of all units. The increase in noise level due to the constant flow rate control is very low up to this operating point.

B Comfort zone up to 7 m/s in riser pipe

with simultaneous operation of all units. The increase in noise level due to the constant flow rate control is in the comfort zone up to this operating point.

C Max. permitted design pressure up to 11 m/s in riser pipe

with simultaneous operation of all units. The main line dimensioning pursuant to building approval is allowed up to this operating point.

Note: Building law examination and compliance with building law requirements required.
If additional pipe components or roof penetrations are used, there may be deviations from the number of floors shown.

The types.

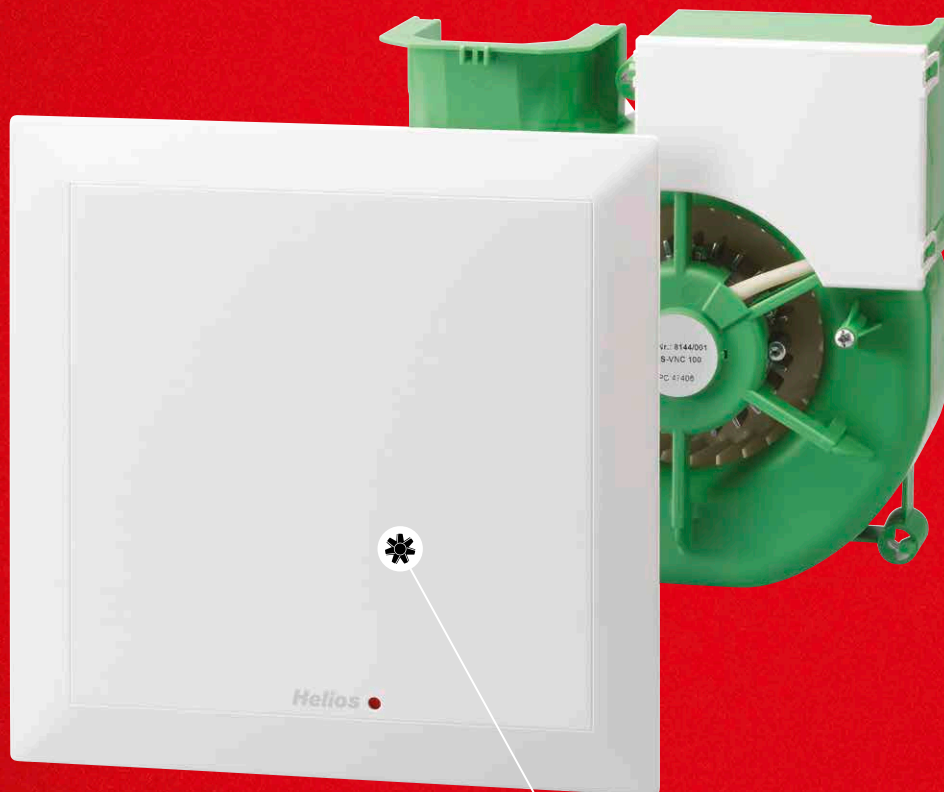

100 % Individual
and available to precisely
meet your requirements.

ELS ventilation units are available in more than 60 variants for the ventilation of bathrooms, WCs and domestic kitchens. All users will always find the ideal solution with certainty thanks to the variety of different types.



ELS standard.

ultraSilence® ELS is the perfect solution for the **extract ventilation of inset bathrooms and WCs** in residential units, hotels or other buildings stipulated by DIN 18017-3. The standard type is available in various flow rate designs – also available with energy-saving EC technology.



ELS with overrun (adjustable).

ELS with overrun (Type ..N) is the **ideal solution for bathrooms and WCs in residential units with normal frequency of use**. With regard to rooms with periodically low usage, ELS with adjustable overrun and interval operation (Type ..NC) offers **economical and yet safe room ventilation** – even in the absence of people. Musty rooms and moisture damage are thereby automatically and effectively prevented.



ELS with automatic humidity control.

ELS with automatic humidity control is equipped with a **particularly effective and sophisticated system for early moisture detection**. In this respect, intelligent algorithms also detect the intensity of the moisture increase and react quicker than conventional systems. The overrun time and any necessary interval operation is also controlled fully automatically.



ELS with presence detector.

ELS with presence detector is the comfortable option to set the ventilation mode depending on the frequentation of the room. Needs-based and standard-compliant ventilation is always ensured and fully automatic. **Ideal for barrier-free toilets and sanitary facilities** with private and commercial use, such as in hotels, restaurants, offices, residential homes, etc.

i The following applies for all types:

Delivered ready for use with flat inner facade (alpine white) and ultraSilence® technology. Comes with permanent filter and filter cleaning indicator as standard. Integrated plug connection for electrical connection. Protective insulation, class II, IPX5. For installation in zone 1 of wetrooms. Maintenance-free, ball bearing mounted energy-saving motor. Technical approval, Z-51.1-193.



ELS standard.

Type	Ref. no.	Area of application	Flow rate in m³/h	Power consumption in Watts	Sound pressure dB(A)*		Sound power level L _{WA} dB(A)		Electrical supply line in mm² (protection class II without PE 1))	Wiring diagram no.	Accessories: DSEL 2 No. 01306 Speed and operating switch, 2-speed	Accessories: DSEL 3 No. 01611 Speed and operating switch, 3-speed
					Flushmount.	Surfmount.	Flushmount.	Surfmount.				
■ ELS standard with AC technology Startup delay - Overrun - *** Interval - Electrical connection: 230 V~, 50 Hz, NYM-0												
ELS-V 60	08131	Bathroom or WC	60	18	35	39	39	43	2x1.5 (4x1.5)	869		
ELS-V 60/35	08133	Bathroom or WC	60/35	18/9	35/26	39/30	39/30	43/34	3x1.5 (5x1.5)	871	•	
ELS-V 100	08132	Bath and WC, kitchen	100	29	47	51	51	55	2x1.5 (4x1.5)	870		
ELS-V 100/60/35	08136	Bath and WC, kitchen	100/60/35	29/18/9	47/35/26	51/39/30	51/39/30	55/43/34	4 x 1.5	874	•	•
■ ELS standard with EC technology Startup delay - Overrun - *** Interval - Electrical connection: 230 V~, 50 Hz, NYM-0												
ELS EC 60	06427	Bathroom or WC	60	6	35	39	39	43	3 x 1.5	1159		
ELS EC 60/35	06428	Bathroom or WC	60/35	6/4	35/26	39/30	39/30	43/34	4 x 1.5	1161	•	
ELS EC 60/40/15	06359	Bathroom or WC	60/40/15	6/5,2/3,5	35/27/21	39/31/25	39/31/25	43/35/29	5 x 1.5	1200	•	•
ELS EC 60/45/25	06358	Bathroom or WC	60/45/25	6/5,4/3,7	35/28/24	39/32/28	39/32/28	43/36/32	5 x 1.5	1199	•	•
ELS EC 100	06417	Bath and WC, kitchen	100	15	47	51	51	55	3 x 1.5	1160		
ELS EC 100/35	06420	Bath and WC, kitchen	100/35	15/4	47/26	51/30	51/30	55/34	4 x 1.5	1162	•	
ELS EC 100/60	06418	Bath and WC, kitchen	100/60	15/6	47/35	51/39	51/39	55/43	4 x 1.5	1163	•	
ELS EC 100/60/35	06419	Bath and WC, kitchen	100/60/35	15/6/4	47/35/26	51/39/30	51/39/30	55/43/34	5 x 1.5	1164	•	•



ELS with automatic humidity control.

Type	Ref. no.	Area of application	Flow rate in m³/h	Power consumption in Watts	Sound pressure dB(A)*		Sound power level L _{WA} dB(A)		Electrical supply line in mm² (protection class II without PE 1))	Wiring diagram no.	Accessories: DSEL 2 No. 01306 Speed and operating switch, 2-speed	Accessories: DSEL 3 No. 01611 Speed and operating switch, 3-speed
					Flushmount.	Surfmount.	Flushmount.	Surfmount.				
■ ELS with automatic humidity control with AC technology Startup delay 0/45 sec.** Overrun 6/10/15/21 min.** Interval - Electrical connection: 230 V~, 50 Hz, NYM-0												
ELS-VF 60	08161	Bathroom or WC	60	18	35	39	39	43	3 x 1.5	881		
ELS-VF 60/35	08163	Bathroom or WC	60/35	18/9	35/26	39/30	39/30	43/34	4 x 1.5	883	•	
ELS-VF 100/60/35	08166	Bath and WC, kitchen	100/60/35	29/18/9	47/35/26	51/39/30	51/39/30	55/43/34	5 x 1.5	886	•	•
■ ELS with automatic humidity control with EC technology Startup delay 0/45 sec.** Overrun 6/10/15/21 min.** Interval - Electrical connection: 230 V~, 50 Hz, NYM-0												
ELS EC 40/15/60 F NEW	40170	Bathroom or WC	40/15/60	5,2/3,5/6	27/21/35	31/25/39	31/25/39	35/29/43	5 x 1.5	1463	•	•
ELS EC 40/20/60 F NEW	40171	Bathroom or WC	40/20/60	5,2/3,6/6	27/23/35	31/27/39	31/27/39	35/31/43	5 x 1.5	1464	•	•
ELS EC 45/25/60 F NEW	40172	Bathroom or WC	45/25/60	5,4/3,7/6	28/24/35	32/28/39	32/28/39	36/32/43	5 x 1.5	1465	•	•
ELS EC 60 F	06408	Bathroom or WC	60	6	35	39	39	43	3 x 1.5	1171		
ELS EC 60/15 F NEW	40173	Bathroom or WC	60/15	6/3,5	35/21	39/25	39/25	43/29	4 x 1.5	1466	•	
ELS EC 60/35 F	06409	Bathroom or WC	60/35	6/4	35/26	39/30	39/30	43/34	4 x 1.5	1173	•	
ELS EC 60/40/15 F	06374	Bathroom or WC	60/40/15	6/5,2/3,5	35/27/21	39/31/25	39/31/25	43/35/29	5 x 1.5	1213	•	•
ELS EC 60/45/25 F	06365	Bathroom or WC	60/45/25	6/5,4/3,7	35/28/24	39/32/28	39/32/28	43/36/32	5 x 1.5	1212	•	•
ELS EC 100 F	06404	Bath and WC, kitchen	100	15	47	51	51	55	3 x 1.5	1172		
ELS EC 100/35 F	06407	Bath and WC, kitchen	100/35	15/4	47/26	51/30	51/30	55/34	4 x 1.5	1174	•	
ELS EC 100/60 F	06405	Bath and WC, kitchen	100/60	15/6	47/35	51/39	51/39	55/43	4 x 1.5	1175	•	
ELS EC 100/60/35 F	06406	Bath and WC, kitchen	100/60/35	15/6/4	47/35/26	51/39/30	51/39/30	55/43/34	5 x 1.5	1176	•	•



* for AL = 10° equivalent absorption area, ** marked value corresponds to factory setting, *** optional overrun see Accessories, page 593, 1) For deactivation of automatic function.



ELS with overrun / ELS with adjustable overrun.

Type	Ref. no.	Area of application	Flow rate in m ³ /h	Power consumption in Watts	Sound pressure dB(A)*		Sound power level L _{WA} dB(A)		Electrical supply line in mm ² (protection class II without PE ¹⁾)	Wiring diagram no.	Accessories: DSEL 2 No. 01306 Speed and operating switch, 2-speed	Accessories: DSEL 3 No. 01611 Speed and operating switch, 3-speed
					Flushmount.	Surfmount.	Flushmount.	Surfmount.				
<p>■ ELS with overrun (VN) / with adjustable overrun (VNC) with AC technology</p> <p>Types VN: Startup delay 45 sec. Overrun 6/15/21 min.** Interval -</p> <p>Types VNC: Startup delay 0/45 sec.** Overrun 6/10/15/21 min.** Interval 4/8/12/24 hrs.**</p> <p>Electrical connection: 230 V~, 50 Hz, NYM-0</p>												
ELS-VN 60	08137	Bathroom or WC	60	18	35	39	39	43	3 x 1.5	875		
ELS-VN 60/35	08139	Bathroom or WC	60/35	18/9	35/26	39/30	39/30	43/34	4 x 1.5	877	•	
ELS-VN 100	08138	Bath and WC, kitchen	100	29	47	51	51	55	3 x 1.5	876		
ELS-VN 100/60	08141	Bath and WC, kitchen	100/60	29/18	47/35	51/39	51/39	55/43	4 x 1.5	879	•	
ELS-VNC 60	08143	Bathroom or WC	60	18	35	39	39	43	3x1.5 (4x1.5)	881		
ELS-VNC 100	08144	Bath and WC, kitchen	100	29	47	51	51	55	3 x 1.5	882		
<p>■ ELS with overrun (N) / with adjustable overrun (NC) with EC technology</p> <p>Types N: Startup delay 45 sec. Overrun 15 min. Interval -</p> <p>Types NC: Startup delay 0/45 sec.** Overrun 6/10/15/21 min.** Interval 0/8/12/24 hrs.**</p> <p>Electrical connection: 230 V~, 50 Hz, NYM-0</p>												
ELS EC 40/60 N	NEW 40098	Bathroom or WC	40/60	5,2/6	27/35	31/39	31/39	34/43	4 x 1.5	1398	•	
ELS EC 60 N	06429	Bathroom or WC	60	6	35	39	39	43	3 x 1.5	1186		
ELS EC 60/15 N	NEW 40099	Bathroom or WC	60/15	6/3,5	35/21	39/25	39/25	43/29	4 x 1.5	1459	•	
ELS EC 60/35 N	06504	Bathroom or WC	60/35	6/4	35/26	39/30	39/30	43/34	4 x 1.5	1188	•	
ELS EC 100 N	06421	Bath and WC, kitchen	100	15	47	51	51	55	3 x 1.5	1187		
ELS EC 100/35 N	06505	Bath and WC, kitchen	100/35	15/4	47/26	51/30	51/30	55/34	4 x 1.5	1189	•	
ELS EC 100/60 N	06498	Bath and WC, kitchen	100/60	15/6	47/35	51/39	51/39	55/43	4 x 1.5	1190	•	
ELS EC 100/60/35 N	06430	Bath and WC, kitchen	100/60/35	15/6/4	47/35/26	51/39/30	51/39/30	55/43/34	4 x 1.5	1191	•	•
ELS EC 40/15/60 NC	NEW 40102	Bathroom or WC	40/15/60	5,2/3,5/6	27/21/35	31/25/39	31/25/39	35/29/43	5 x 1.5	1460	•	•
ELS EC 45/25/60 NC	NEW 40114	Bathroom or WC	45/25/60	5,4/3,7/6	28/24/35	32/28/39	32/28/39	36/32/43	5 x 1.5	1461	•	•
ELS EC 60 NC	06402	Bathroom or WC	60	6	35	39	39	43	3 x 1.5	1165		
ELS EC 60/15 NC	NEW 40169	Bathroom or WC	60/15	6/3,5	35/21	39/25	39/25	43/29	4 x 1.5	1462	•	
ELS EC 60/35 NC	06403	Bathroom or WC	60/35	6/4	35/26	39/30	39/30	43/34	4 x 1.5	1167	•	
ELS EC 60/40/15 NC	06356	Bathroom or WC	60/40/15	6/5,2/3,5	35/27/21	39/31/25	39/31/25	43/35/29	5 x 1.5	1198	•	•
ELS EC 60/45/25 NC	06355	Bathroom or WC	60/45/25	6/5,4/3,7	35/28/24	39/32/28	39/32/28	43/36/32	5 x 1.5	1197	•	•
ELS EC 100 NC	06398	Bath and WC, kitchen	100	15	47	51	51	55	3 x 1.5	1166		
ELS EC 100/35 NC	06401	Bath and WC, kitchen	100/35	15/4	47/26	51/30	51/30	55/34	4 x 1.5	1168	•	
ELS EC 100/60 NC	06399	Bath and WC, kitchen	100/60	15/6	47/35	51/39	51/39	55/43	4 x 1.5	1169	•	
ELS EC 100/60/35 NC	06400	Bath and WC, kitchen	100/60/35	15/6/4	47/35/26	51/39/30	51/39/30	55/43/34	5 x 1.5	1170	•	•

Domestic ventilation acc. to DIN 18017-3



ELS with presence detector.

Type	Ref. no.	Area of application	Flow rate in m ³ /h	Power consumption in Watts	Sound pressure dB(A)*		Sound power level L _{WA} dB(A)		Electrical supply line in mm ² (protection class II without PE ¹⁾)	Wiring diagram no.	Accessories: DSEL 2 No. 01306 Speed and operating switch, 2-speed	Accessories: DSEL 3 No. 01611 Speed and operating switch, 3-speed
					Flushmount.	Surfmount.	Flushmount.	Surfmount.				
<p>■ ELS with presence detector with AC technology</p> <p>Startup delay - Overrun 15 min. Interval -</p> <p>Electrical connection: 230 V~, 50 Hz, NYM-0</p>												
ELS-VP 60	08149	Bathroom or WC	60	18	35	39	39	43	2 x 1.5	887		
ELS-VP 100	08150	Bath and WC, kitchen	100	29	47	51	51	55	2 x 1.5	887		
<p>■ ELS with presence detector with EC technology</p> <p>Startup delay 0/45 sec.** Overrun 6/10/15/21 min.** Interval 0/8/12/24 hrs.**</p> <p>Electrical connection: 230 V~, 50 Hz, NYM-0</p>												
ELS EC 40/15/60 P	NEW 40174	Bathroom or WC	40/15/60	5,2/3,5/6	27/21/35	31/25/39	31/25/39	35/29/43	5 x 1.5	1467	•	•
ELS EC 45/25/60 P	NEW 40175	Bathroom or WC	45/25/60	5,4/3,7/6	28/24/35	32/28/39	32/28/39	36/32/43	5 x 1.5	1468	•	•
ELS EC 60 P	06415	Bathroom or WC	60	6	35	39	39	43	3 x 1.5	1177		
ELS EC 60/35 P	06416	Bathroom or WC	60/35	6/4	35/26	39/30	39/30	43/34	4 x 1.5	1179	•	
ELS EC 100 P	06410	Bath and WC, kitchen	100	15	47	51	51	55	3 x 1.5	1178		
ELS EC 100/35 P	06414	Bath and WC, kitchen	100/35	15/4	47/26	51/30	51/30	55/34	4 x 1.5	1180	•	
ELS EC 100/60 P	06412	Bath and WC, kitchen	100/60	15/6	47/35	51/39	51/39	55/43	4 x 1.5	1181	•	
ELS EC 100/60/35 P	06413	Bath and WC, kitchen	100/60/35	15/6/4	47/35/26	51/39/30	51/39/30	55/43/34	5 x 1.5	1182	•	•



* for AL = 10° equivalent absorption area, ** marked value corresponds to factory setting ¹⁾ For deactivation of automatic function.

The casings.

One casing.
All possibilities.



The flush-mounted casing ELS-GU is not only delightfully compact, but also almost infinitely flexible in application. Whether it is used for single room and two room ventilation or WC connection via the flush pipe – ELS-GU fits optimally in all situations.

Installation is possible in walls, shafts, plasterboards or ceilings, whereby the discharge spigots can be optionally positioned to the back or top. Furthermore, the casing can be rotated by 90° to the left or right. Simple and without tools.

There is just one casing type for each type of installation and all ventilation requirements, which is not only practical on the construction site, but also extremely economical for storage.

ELS-GUBA, the clever flush-mounted casing with integrated fire protection damper, also offers the same advantages.

The flush-mounted casings from ultraSilence® ELS are just as smart. ELS-GAP and ELS-GAPB with the fire protection damper can be mounted by turning the discharge spigots by 360°, so that the air outlet can be positioned to the top left or right and bottom left or right.

1 Single room ventilation

Intake via front facade.

2 Two room ventilation

Two room ventilation with discharge to top or back.

3 WC connection

WC seat connection via flush pipe, discharge to top or back.

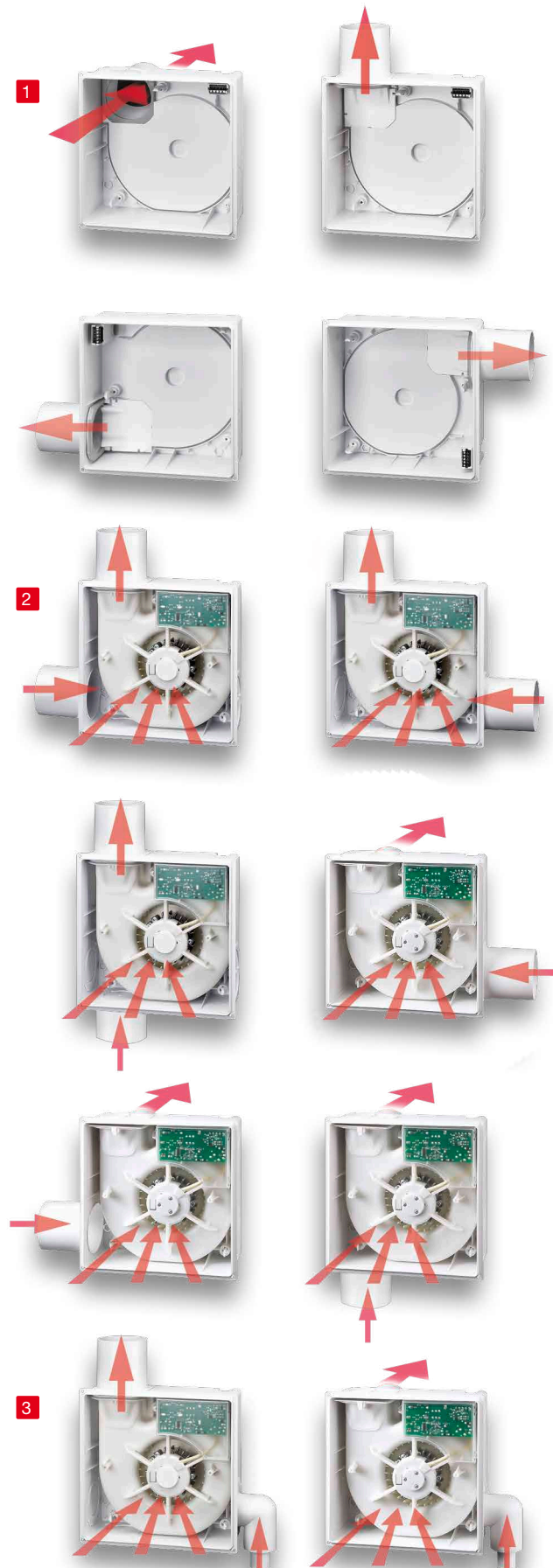

The perfect casing solution for all requirements.

Adapted to the installation location and fire protection requirements, the perfect casing solution is always at the ready. Determine the applicable installation situation using the illustrations and select the corresponding casing in the quick overview. All relevant casing details can be found on the following pages.

- A** Inside K90 shaft
- B** Outside K90 shaft
- C** On K90 shaft
- D** With fire damper
- E** Without fire protection

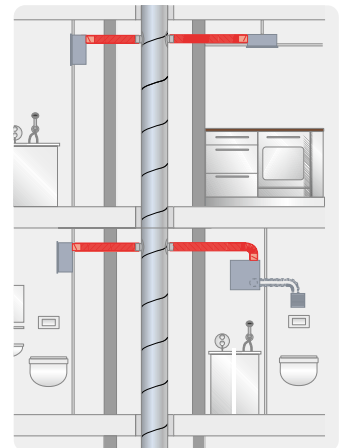
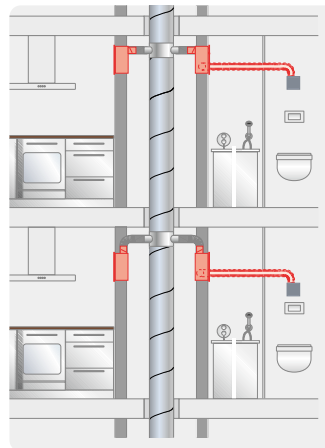
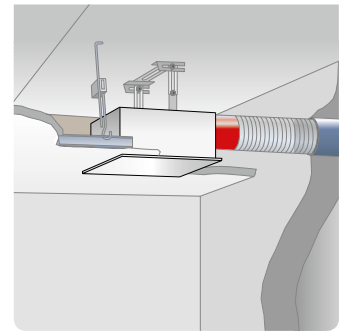
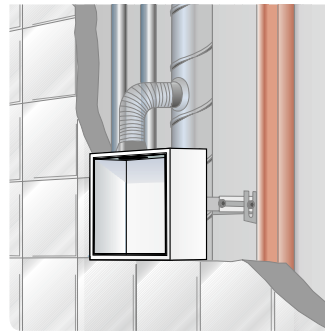

A Inside K90 shaft

Flexible or rigid steel tube only to second room connection.

B Outside K90 shaft

Flexible or rigid steel tube to main line.

Quick selection

Installation, discharge	Type	Ref. no.	Type	Ref. no.
Single room ventilation of bathroom, WC or domestic kitchen				
Flush-mounted, lateral discharge	ELS-GUB	08112	ELS-GUBA	08114
Flush-mounted, discharge to back	ELS-GUBR	08113	ELS-GUBA + access. ELS-ARS	08114 08185
Surface-mounted, discharge to back			ELS-GAPB	08128
Surface-mounted, lateral discharge			ELS-GUBA + access. ELS-APASA	08114 07328
Two room ventilation of bathroom and WC				
Flush-mounted, lateral discharge	ELS-GUBZL left	08115	ELS-GUBA	08114
	ELS-GUBZR right	08117	ELS-ZS	08186
Flush-mounted, discharge to back	ELS-GUBRZL left	08116	ELS-GUBA + access. ELS-ARS	08114 08185
	ELS-GUBRZR right	08118	+ access. ELS-ZS	08186

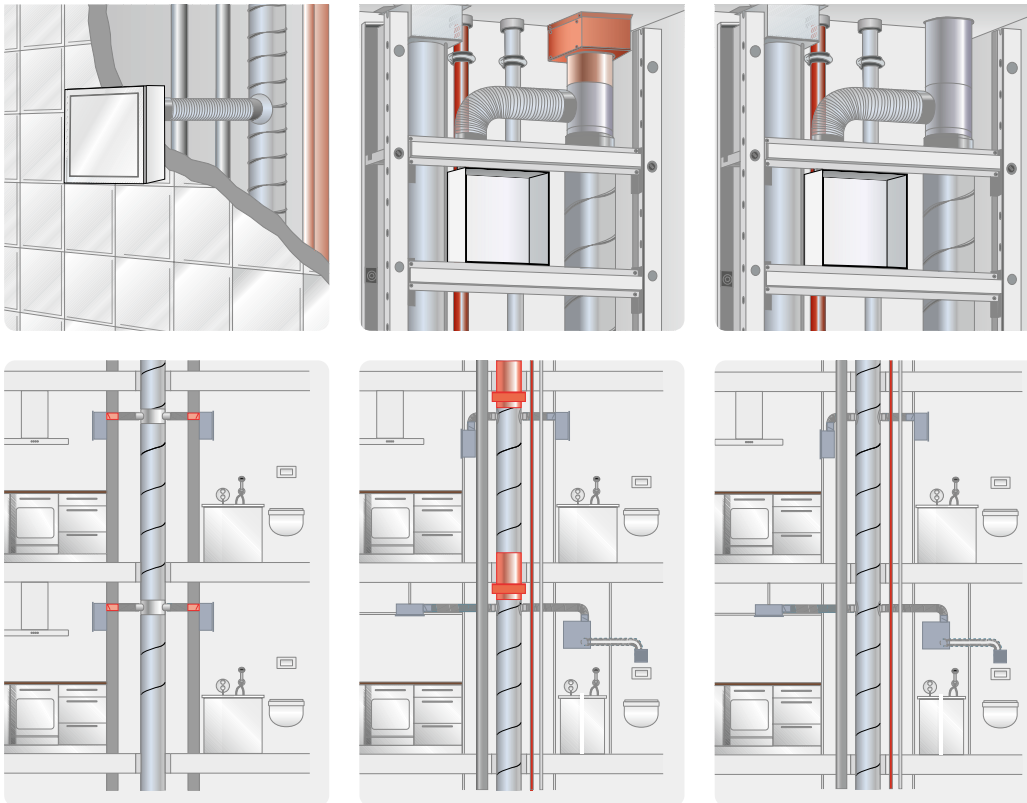

C On K90 shaft

D With fire damper

E Without fire protection

For up to 2 full floors.

Information on fire protection in multi-storey buildings

With regard to the planning and execution of ventilation systems, the State fire protection requirements must be complied with.

Buildings with more than two full floors are normally subject to such requirements.

In order to prevent the transmission of fire to other fire sections, the illustrated solutions are available according to the structural conditions for the installation of mono tube ventilation systems.

Type	Ref. no.	Type	Ref. no.	Type	Ref. no.	Installation, discharge
		ELS-GU	08111	ELS-GU	08111	Flush-mounted, lateral discharge
		ELS-GU + access. ELS-ARS	08111 08185	ELS-GU + access. ELS-ARS	08111 08185	Flush-mounted, discharge to back
ELS-GAPB	08128	ELS-GAP	08127	ELS-GAP	08127	Surface-mounted, discharge to back
ELS-GAPB	08128	ELS-GU + access. ELS-APASA	08111 07328	ELS-GU + access. ELS-APASA	08111 07328	Surface-mounted, lateral discharge
		ELS-GU + access. ELS-ZS	08111 08186	ELS-GU + access. ELS-ZS	08111 08186	Flush-mounted, lateral discharge
		ELS-GU + access. ELS-ARS + access. ELS-ZS	08111 08185 08186	ELS-GU + access. ELS-ARS + access. ELS-ZS	08111 08185 08186	Flush-mounted, discharge to back

A Flush-mounted installations in wall, ceiling and fire-resistant shaft (F90) or L90 ventilation ducts.

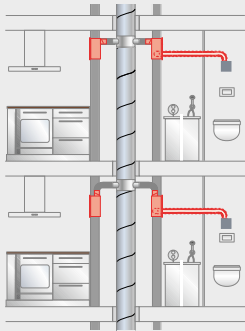

Connection of up to 3 casings per floor possible on more than 20 full floors. The second room connection must be carried out with steel flexpipe connection.

- Flush-mounted casing with fire protection encasement K90
- Metal discharge spigot with automatic backdraught shutter and shut-off upon triggering of fusible link

- Removable plug connector for electrical connection
- Replaceable hinged plaster cover
- Connection DN 80 mm
- General technical approval, Z-51.1-193

■ Single room ventilation of bathroom, WC or domestic kitchen

		Type	ELS-GUB
		Ref. no.	08112
		Installation	Flush-mounted
		Discharge	lateral, upward, can be turned to left or right
		Type	ELS-GUBR
		Ref. no.	08113
		Installation	Flush-mounted
		Discharge	to the back, rotatable by 90° in any direction

■ Ventilation of bathroom and WC

		Type	ELS-GUBZL
		Ref. no.	08115
		Installation	Flush-mounted
		Discharge	lateral, upward, can be rotated left or right
		Sec. room connection	Left
		Type	ELS-GUBZR
		Ref. no.	08117
		Installation	Flush-mounted
		Discharge	lateral, upward, can be rotated left or right
		Sec. room connection	Right
		Type	ELS-GUBRZL
		Ref. no.	08116
		Installation	Flush-mounted
		Discharge	to the back, rotatable by 90° in any direction
		Sec. room connection	Left

■ Two-room ventilation of bathroom and WC

		Type	ELS-GUBRZR
		Ref. no.	08118
		Installation	Flush-mounted
		Discharge	to the back, rotatable by 90° in any direction
		Sec. room connection	Right

B Flush or surface-mounted installations in wall or ceiling outside of fire-resistant shafts (F90) or L90 ventilation ducts.

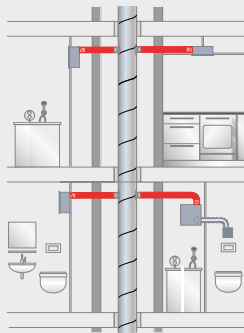

Connection of up to 3 casings per floor possible on more than 20 floors. Steel flexpipe connection to main line.

- Removable plug connector for electrical connection
- Connection DN 80 mm
- General technical approval, Z-51.1-193

- Plastic casing with fire protection element K90
- Metal discharge spigot with automatic backdraught shutter and shut-off upon triggering of fusible link
- Made of plastic (white), in fire class B 2

■ Single room ventilation of bathroom, WC or domestic kitchen

Also for second room ventilation of bathroom and WC by means of accessory set*

			Type	ELS-GUBA
			Ref. no.	08114
		Installation	Flush-mounted	
		Discharge	lateral, upward, can be turned to left or right	
		Optional discharge	to the back, rotatable by 90° in any direction ELS-ARS, Ref. no. 08185	
		*Sec. room ventilation optionally left or right	by means of ELS-ZS, Ref. no. 08186	
			Type	ELS-APASA (+ ELS-GUBA)**
			Ref. no.	07328
		Installation	Surface-mounted	
		Discharge	lateral, upward, can be turned to left or right	
		**ELS-GUBA (Ref. no. 08114) is not included in the scope of delivery.		
			Type	ELS-GAPB
			Ref. no.	08128
		Installation	Surface-mounted	
		Discharge	to the back, rotatable by 90° in any direction	
		ELS-surface-mounted unit		

C Surface-mounted installation in wall or ceiling on walls of fire-resistant shafts (F90) or ventilation ducts (L90).

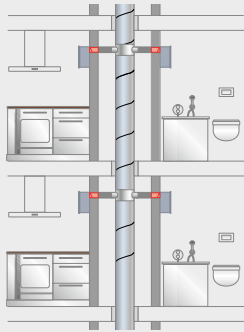

Connection of up to 3 casings per floor possible on more than 20 floors.

- Surface mounting casing with fire protection element K90
- Metal discharge spigot with automatic backdraught shutter and shut-off upon triggering of fusible link
- Removable plug connector for electrical connection

- Made of plastic (white), in fire class B 2
- Connection Ø air outlet DN 80 mm
- General technical approval, Z-51.1-193

■ Single room ventilation of bathroom, WC or domestic kitchen

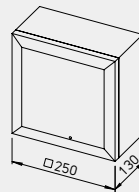
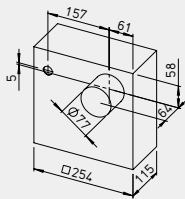

ELS-surface-mounted unit

Type	ELS-GAPB
Ref. no.	08128
Installation	Surface-mounted
Discharge	to the back, rotatable by 90° in any direction

D Flush or surface-mounted installation in wall, ceiling or in installation shaft with fire protection solution ELS-D fire damper.

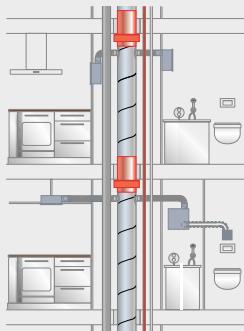

Connection of up to 3 casings per floor possible. For more than 20 floors when using fire protection damper in the main line

- Applicable casings: Universal casing without fire protection ELS-GU for flush-mounting, or ELS-GAP or ELS-APASA in connection with ELS-GU for surface-mounting

- Casing without fire protection, with airtight backdraught shutter
- Removable plug connector for electrical connection
- Made of plastic (white), in fire class B 2
- Connection DN 80 mm
- General technical approval, Z-51.1-193

■ Flush or surface-mounted installation. Single room ventilation of bathroom, WC or domestic kitchen.

Also for second room ventilation of bathroom and WC by means of accessory set*

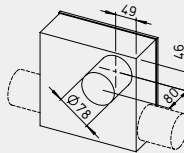
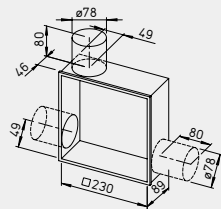

Type	ELS-GU
Ref. no.	08111
Installation	Flush-mounted
Discharge	lateral, upward, left or right
Optional discharge	to the back, rotatable by 90° in any direction using ELS-ARS Ref. no. 08185 by
*Sec. room ventilation optionally left or right	means of ELS-ZS, Ref. no. 08186

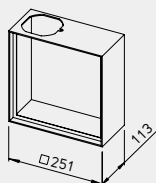

Type	ELS-APASA (+ ELS-GU)**
Ref. no.	07328
Installation	Surface-mounted
Discharge	lateral, upward, can be rotated left or right

**ELS-GU (Ref. no. 08111) is not included in scope of delivery.

■ Surface-mounting. Single room ventilation of bathroom, WC or domestic kitchen.

			Type	ELS-GAP
			Ref. no.	08127
			Installation	Surface-mounted
			Discharge	to the back, rotatable by 90° in any direction

ELS-surface-mounted unit

E Flush or surface-mounted installations in wall, ceiling or in installation shaft without fire protection.

Connection of up to 3 casings per floor possible. For connection to shared main line of up to two full floors.

- Applicable casings: Universal casing without fire protection ELS-GU for flush-mounting, or ELS-GAP or ELS-APASA in connection with ELS-GU for surface-mounting.
- Casing without fire protection, with airtight backdraught shutter
- Removable plug connector for electrical connection
- Made of plastic (white), in fire class B 2
- Connection DN 80 mm.
- General technical approval, Z-51.1-193

■ Flush-mounting. Single room ventilation of bathroom, WC or domestic kitchen.
Also for second room ventilation of bathroom and WC by means of accessory set*

			Type	ELS-GU
			Ref. no.	08111
			Installation	Flush-mounted
			Discharge	lateral, upward, left or right
			Optional discharge	to the back, rotatable by 90° in any direction ELS-ARS Ref. no. 08185
			*Sec. room ventilation optionally left or right	by means of ELS-ZS, Ref. no. 08186

■ Surface-mounting. Single room ventilation of bathroom, WC or domestic kitchen.

			Type	ELS-GAP
			Ref. no.	08127
			Installation	Surface-mounted
			Discharge	to the back, rotatable by 90° in any direction

ELS-surface-mounted unit

		Type	ELS-APASA (+ ELS-GU)**
		Ref. no.	07328
		Installation	Surface-mounted
		Discharge	lateral, upward, can be turned to left or right

**ELS-GU (Ref. no. 08111) is not included in scope of delivery.

■ ultraSilence® ELS-inner facia
Included in delivery set with fan insert.

As clever as the entire system: The installation.

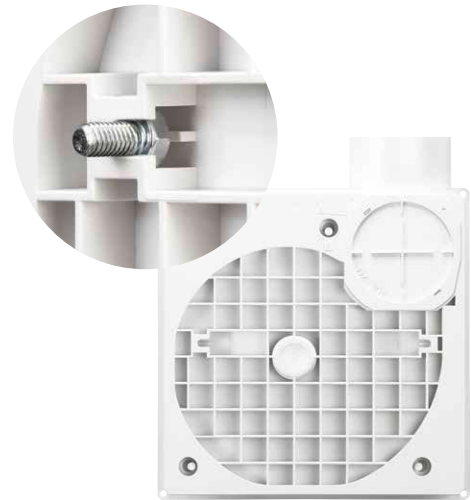
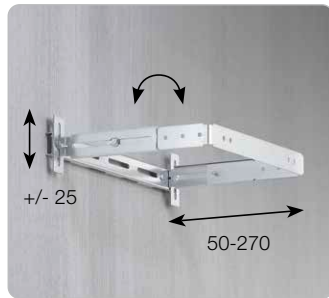

■ **ELS-MB**

The mounting bracket ELS-MB provides the ideal connection between ELS and the system elements from the plasterboard supplier for integration in plasterboard systems. ELS-MB is easily mounted to the back of the ELS casing using hexagon-head and square-head screws in the rotation-proof grooves.

■ **ELS-MHU**

With regard to installation in shafts and suspended ceilings, the universal mounting bracket ELS-MHU provides the necessary flexibility. Practical for flush-mounted casing installation in installation shafts, primarily for casings with fire protection encasement. For mounting the casing to the ceiling or wall.

■ **Clever plug-in fixing for mounting screws to ELS-MB and ELS-MHU.**

All flush-mounted casings can be correctly positioned in a few minutes as it is adjustable in height, depth and perpendicular. Rotation-proof grooves for hexagon-head or square-head screws are recessed on the back of casing types ELS-GU and -GUBA. They form the fixing points for the mounting bracket; alternatively, there are two predetermined breaking points for firm screwing to on-site elements.

Swiftly into the plasterboard.

Adapted to construction progress: Installation in common plasterboard systems becomes a real pleasure thanks to the refined installation features and the clever plasterboard adapter ELS-VA.

All in one step: The complete installation of ultraSilence® ELS can also take place as part of the final installation upon request. The entire installation is completed in a few simple steps.



- 1 Extract air duct and mains connection are placed at the subsequent ELS installation position.



- 1 Extract air duct and mains connection are placed at the subsequent ELS installation position.



- 2 Markings on the ELS casing make it easy to carry out the plasterboard cut-out quickly and with the highest precision.



- 2 The corresponding plasterboard cut-out is created for the installation preparation.



- 3 The practical plasterboard adapter ELS-VA is now mounted. Extract air duct and mains connection are connected to the ELS casing. The casing is then simply inserted. Practical: the supplied plaster cover protects against contamination.



- 3 The desired final wall covering is applied.



- 4 The desired final wall covering is applied.



- 4 The flush-mounted casing can now be very simply connected to the mains line with the pre-mounted plasterboard adapter and fan. It is then inserted into the finished wall.



- 5 The fan is simply inserted – and audibly clicks in as part of the final work in the room.



- 5 The plasterboard adapter is then directly screwed to the wall – and this ensures the highest stability.



- 6 The facade panel is mounted and the standard permanent filter is inserted in a few simple steps.



- 6 The facade panel is then mounted using the spacer frame ELS-AGR and the permanent filter is inserted.



- 7 ultraSilence® ELS is now operational.



- 7 ultraSilence® ELS is now operational.

Adaption kit for discharge to the back

ELS-ARS Ref. no. 08185
The air discharge spigot can be placed on the back of the unit for the flush-mounted casings ELS-GU and -GUBA without fire protection encasement. The ARS diverter must simply be mounted on the discharge side in the fan for the correct air flow.



Second room kit

ELS-ZS Ref. no. 08186
Extract air unit for flush-mounted installation for connection to all casings for second room connection ELS-GU. Award-winning design facade in alpine white, with closed front and all-round air inflow. Integrated, easily accessible air filter. Includes second room connection spigots for fan casings ELS-GU and -GUBA.

Second room connection spigots

ELS-ZAS Ref. no. 08184
Spigots for casing types ELS-GU and -GUBA. For the connection of second room extraction on site. NW 75/80 mm.



WC connection kit

ELS-WCS Ref. no. 08191
Kit for connecting WC extraction in combination with the room ventilation; for casing types ELS-GU, -GUBA. The fan casing and cistern pipe are connected with commercially available HT pipes. Scope of delivery: Connecting panel, 90° angle, 2 stepped spigots Ø 40 and 30 mm.

Universal mounting bracket

ELS-MHU Ref. no. 08187
Practical for flush-mounted casing installation in installation shafts, primarily for casings with fire protection encasement. For mounting the casing to the ceiling or wall. Adjustable in height, depth and perpendicular; fits with all flush-mounted casing types.

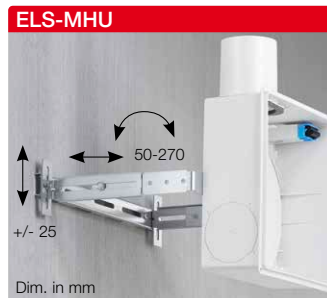

Mounting bracket

ELS-MB Ref. no. 08188
For mounting flush-mounted casings in plasterboard systems in connection with elements from the plasterboard supplier. The mounting bracket is easily mounted to the back of the ELS casing using hexagon-head and square-head screws in the rotation-proof grooves.

Plasterboard adapter

ELS-VA Ref. no. 08189
Allows the front-side insertion and mounting of flush-mounted ELS casings in plasterboard. The adapter is screwed to the casing and its frame with Spax screws or plasterboard screws.



Surface-mounted adapter with side discharge

ELS-APASA Ref. no. 07328
Made of steel sheet in alpine white. Insulated adapter with side discharge for surface-mounted installation. Suitable for casing types ELS-GU and ELS-GUBA.

Sunken frame

ELS-VSR Ref. no. 07322
Made of steel sheet in alpine white. Allows flush-mounted wall and ceiling installation of inner facade. Suitable for ELS-GU and ELS-GUBA.



Flush-mounted spacer frame

ELS-UPA Ref. no. 07332
Used when ELS-GU and ELS-GUBA are installed too deep. This closes the gap (max. 50 mm) between the casing and panelling.

Spacer frame

ELS-AGR Ref. no. 08193
Covers up to 15 mm of protruding flush-mounted casing, which has not been installed flush with the plaster or tiles. The spacer frame is simply fixed between the wall/ceiling and ELS inner facade.

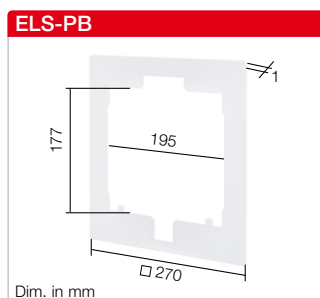

Plasterboard cover

ELS-PB Ref. no. 08194
For covering gaps in case of casing cut-outs which have been uncleanly plastered, tiled or if they are too large, which cannot be completely covered by the ELS inner facade. The plaster cover is simply fixed between the wall/ceiling and ELS inner facade.

■ Fire protection
The spreading of fire and smoke to other floors must be prevented for building heights over two full floors using certified fire protection elements, classification K 90-18017.
In this respect, the following options and options presented in detail on page 62 are available according to the structural conditions.

- Casing ELS-GUB, with fire protection cladding
In fire resistant shaft (F90) or L90 ventilation duct.
- Casings ELS-GUBA, ELS-GAPB with fire damper
With casing positioning outside of fire resistant shaft (F90) or L90 ventilation duct. Connection to main pipeline with flexible or rigid steel tube.

– Fire protection ceiling seal ELS-D
Installation in the main ventilation pipeline. Approved for use in ventilation ducts and mixed installation shafts (even with flammable pipes) with just 12.5 mm thick plasterboard.
All ELS fans connected with Aluflex pipe do not require fire resistance classification.



Fire damper ELS-D
When using this shut-off damper, all other components do not require any fire resistance classification. The universally applicable casing types ELS-GU (UP) and -GAP (AP) can be connected. The stub and

connection lines are cost-effective and installation-friendly in Aluflex pipe. For detailed description see page 588.

ND mm main pipe	100	125	140	160	180	200	
Type	ELS-D	100	125	140	160	180	200
Ref. no.		00270	00185	00186	00187	00188	00271

- Intake air elements
- Installation in wall openings



Universally applicable automatic supply air elements and thermostat supply valves for demand-based intake air volume control. See Intake air elements page for detailed description.

ø 80		ø 100		ø 160	
Type	Ref. no.	Type	Ref. no.	Type	Ref. no.
Automatic supply air element – Automatically temperature-controlled incl. thermostat supply valve, sound insulation and external grille					
ZLA 80	00214	ZLA 100	00215	ZLA 160	00216
Supply air element – Manually controllable in four levels incl. supply valve with drawcord, sound insulation and external grille					
		ZLE 100	00079		
Thermostat supply valve – For installation in existing ventilation openings					
ZTV 80	00078	ZTV 100	00073	ZTV 160	00074

Automatic supply air element ZLA 125 see page 72 f.

- Installation in window frames



Intake air element with volume flow control and limitation. See Intake air elements product page for detailed description. Ideal for retrofitting and new constructions.

V		ø 160				
m ³ /h	Type	Ref. no.	Type	Ref. no.	Type	Ref. no.
Intake air element for installation in window frames – with volume flow control and limitation						
30	ALEF 30	02100	Like ALEF, but also comes with sound insulation		ALEFS 30	02102
45	ALEF 45	02101			ALEFS 45	02103
Intake air element for installation in window frames – humidity-controlled, with volume flow control and limitation						
5/45	ALEF Hygro 5/45	02056	Like ALEF Hygro, but also comes with sound insulation		ALEFS Hygro 5/45	02057

- Overflow



Door ventilation grilles
Unobtrusive, sight screening ventilation grille made of break-resistant plastic for installation in door leaf. See ventilation grille product page for detailed description.

LTGW Ref. no. 00246
Made of plastic, white.

LTGB Ref. no. 00247
Made of plastic, brown.

- Replacement air filter



Replacement air filter
Filter mats made of regenerating synthetic fibres, ISO Coarse 30%.

ELF-ELS Ref. no. 08190
Permanent filter for fan inserts ELS-V and ELS EC, suitable for cleaning in dishwasher, unit = 2 pcs.

ELF-DLV 100 Ref. no. 03042
For second room extraction unit ELS-ZS, unit = 5 pcs.

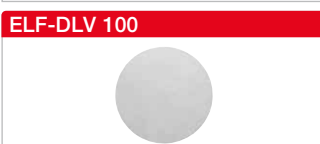

Reference	Page
Dimensions, further technical information and other sizes:	
Ventilation grilles	553 ff.
Intake air elements	578 ff.
Fire protection elements for use in multi-floor construction with more than 2 full floors	582 ff.
Control and regul. units	591 ff.

ZLA 125



ZLA 125 – External view



The new supply air units ZLA from Helios easily provide fresh air – fully automatically. With these universally usable automatic units, the supply air flowing inside is perfectly distributed, filtered (class ISO Coarse 30%) and optimally sound-insulated.

The ZLA 125 consists of an inner panel, installation kit and facade panel, it fits in all types of wall and comes without electrical connection. It is available with two constant volume inner panels (22 m³/h and 30 m³/h) as well as a humidity-controlled inner panel (6 – 45 m³/h).

Advantages

- High sound-insulation due to integrated sound-insulating element (up to 56 dB standard sound level difference)
- Humidity-controlled (with ZLA 125 IB HY) or constant supply air volume (with ZLA 125 IB 22 + 30)
- Universally useable in all wall types.
- Particularly installation-friendly due to removable plastic telescopic tube for wall thicknesses from 260 to 500 mm.
- Low maintenance costs.
- Easily replaceable filter.
- Completely operating cost-free.
- No electrical connection necessary.
- Insect screen included in standard scope of delivery.

Function

- The humidity-controlled inner panel ZLA 125 IB HY 6 – 45 automatically reacts to varying room humidity levels and then adjust the flow rate in the range from 6 to 45 m³/h (at 20 Pa pressure level). See performance curve (humidity-controlled).
- The inner panels ZLA 125 IB 22 and 30 are self-regulating and keep the flow rate constant, even in case of varying differential pressure levels. See performance curve (constant supply air volume).
- All inner panel types also include ISO Coarse 30% filters, which are easy to maintain.
- The additional components, such as the installation kit and facade panel, are easy to install and include sound-insulating elements for optimal sound insulation.
- A standard sound level difference of up to 59 dB can be achieved for a wall thickness of 500 mm using an additional sound-insulating element ZLA 125 SE.

Installation

- Installation in wall openings with a diameter of ≥ 130 mm.
- Insert telescopic tube, adjust to wall thickness, foam-seal at a slight angle and secure protective cover.
- Plaster tube into place and screw on the facade panel from outside.
- Optional: Insert insect screen in facade panel, insert ISO Coarse 30% filter in inner panel.

Technical data			
Set ZLA 125	ZLA 125 IB 22 + ZLA 125 RS + ZLA 125 FB	ZLA 125 IB 30 + ZLA 125 RS + ZLA 125 FB	ZLA 125 IB HY 6-45 + ZLA 125 RS + ZLA 125 FB
Airflow (at 4 Pa differential pressure) in m ³ /h	11.3	14.3	2.2 – 20.1
Airflow (at 8 Pa differential pressure) in m ³ /h	16.2	20.5	3.2 – 28.5
Airflow (at 20 Pa differential pressure) in m ³ /h	22	30	6 – 45
Standard sound level diff. D _{n,e,w} in dB	56	55	54
Standard sound level diff. D _{n,e,w} in dB incl. ZLA 125 SE	59	58	57
Pipe DN Ø in mm	125	125	125
Core drilling Ø in mm	≥ 130	≥ 130	≥ 130
Weight appr. kg	1.15	1.15	1.13

■ **Inner panel 22/30 m³/h**
ZLA 125 IB 22 Ref. no. 04393
ZLA 125 IB 30 Ref. no. 04394
 Inner panel constant volume
 22 m³/h or 30 m³/h (at 20 Pa dif-
 ferential pressure). Made of white
 plastic, ISO Coarse 30% filter.

ZLA 125 IB 22/30



Dimensions ZLA 125 IB 22/30

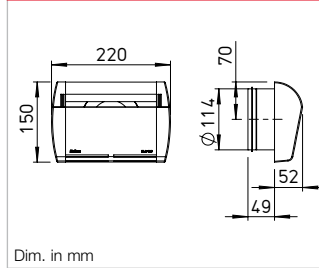

P-Curves ZLA 125 IB 22/30

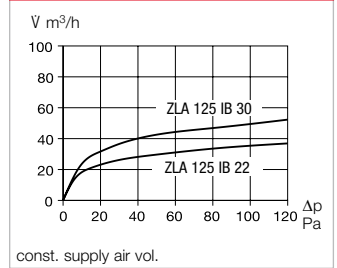

■ **Inner panel humidity-controlled**
ZLA 125 IB HY 6 - 45 No. 04395
 Inner panel humidity-controlled
 between 6 - 45 m³/h (at 20 Pa dif-
 ferential pressure). Made of
 white plastic, ISO Coarse 30%
 filter.

ZLA 125 IB HY 6-45



Dimensions ZLA 125 IB HY 6-45

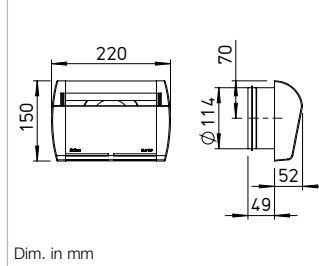

P-Curves ZLA 125 IB HY 6-45

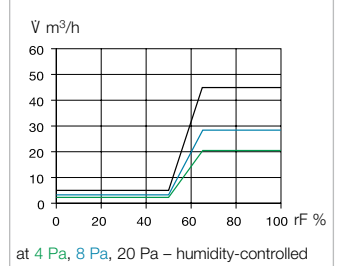

■ **Installation kit**
ZLA 125 RS Ref. no. 04396
 Telescopic tube 260 – 500 mm
 made of white plastic, incl. sound-
 insulating element 200 mm made
 of melamine resin foam,
 incl. 2x protective covers.

ZLA 125 RS



Dimensions ZLA 125 RS

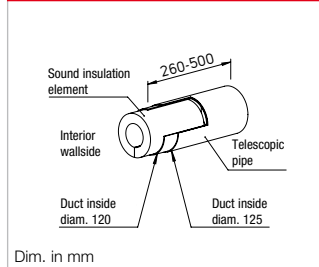

■ **Sound-insulating element**
ZLA 125 SE Ref. no. 04397
 Sound-insulating element 200 mm
 made of melamine resin foam.
 Can also be used for wall thick-
 nesses ≥ 300 mm.

ZLA 125 SE



Dimensions ZLA 125 SE

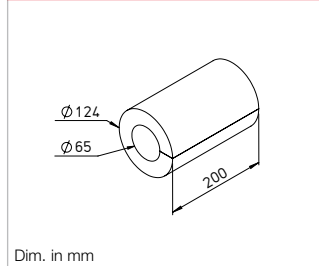

■ **Facade panel**
ZLA 125 FB Ref. no. 04398
 Facade panel made of white
 plastic for external use, insect
 screen made of stainless steel.

ZLA 125 FB



Dimensions ZLA 125 FB

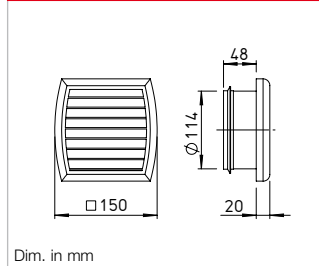

■ **Spare air filter**
ELF-DLV 125 Ref. no. 03058
 5 spare filters ISO Coarse 30% for
 inner panel.

ELF-DLV 125



■ **Order info:**

A complete supply air unit
 consists of an inner panel, an
 installation kit and a facade
 panel. Sound-insulating elements
 are used for wall thicknesses
 ≥ 300 mm.

ZLA LE – Installation example DN 100 mm

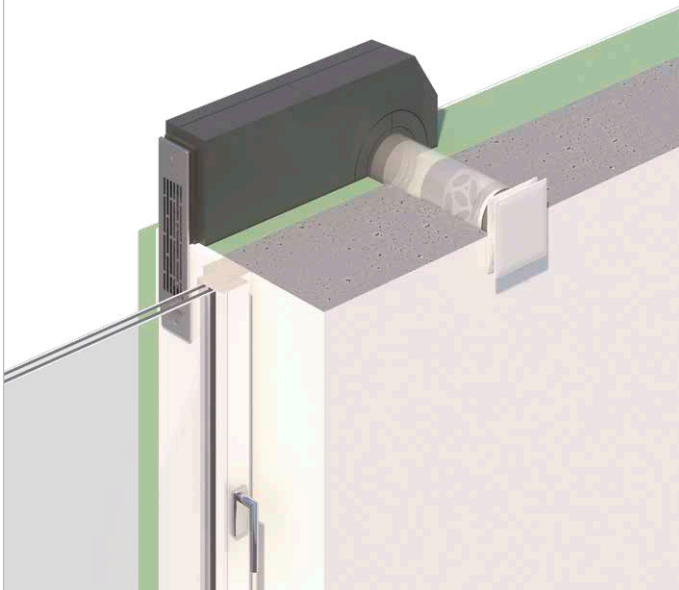

ZLA LE – Installation example DN 125 mm

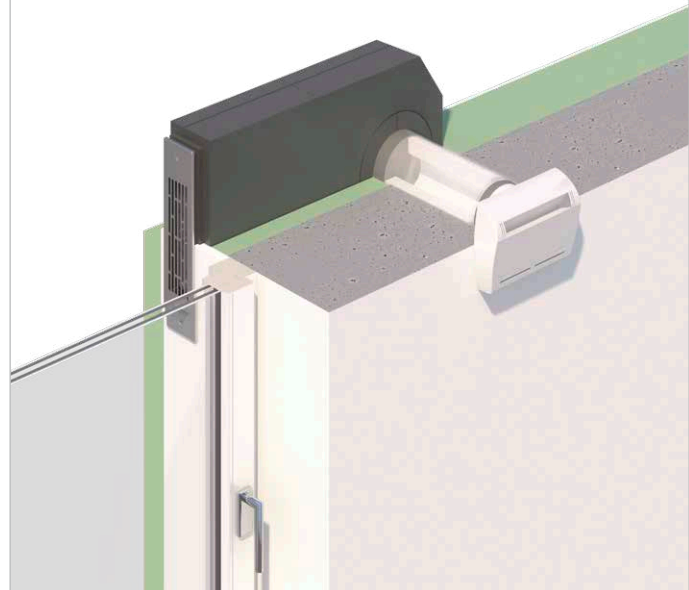

Invisible in the window soffit – ZLA LE.

The soffit element ZLA LE diverts the supply air inside the thermal insulation system by 90° in the window soffit. No components can be seen on the outer facade, apart from the grille in the window bar.

- **Vorteile**
 ZLA LE can be used for pipe diameters 100 and 125 mm and it can be individually configured:
 - Select the wall grille that meets your requirements and the desired inner panel in addition to the installation kit.
 - Optional components, such as sound-insulating elements, insect screens and volume stabiliser are available for further adaptation to the field of application.

■ **Description**
Install. example DN 100 mm

- Installation kit soffit ZRL 100 with design ventilation valve DLV 100 and optional sound-insulating volume element SVE 100.
- The flow rate can be manually adjusted using the design ventilation valve.

■ **Description**
Install. example DN 125 mm

- Installation kit soffit ZRL 125 with inner panel ZLA 125 IB and optional sound-insulating element ZLA 125 SE.
- The inner panels regulate the flow rate or keep it constant depending on the humidity and design.

Technical data: Basic components

Set: ZLA LE basic systems		ZRL 100 + KWL 45 LG + DLV 100	ZRL 125 + KWL 45 LG + DLV 125	ZRL 125 + KWL 45 LG + ZLA 125 IB 22	ZRL 125 + KWL 45 LG + ZLA 125 IB 30	ZRL 125 + KWL 45 LG + ZLA 125 IB HY 6-45
Flow rate at 20 Pa	m ³ /h	Adjustable 33–75	Adjustable 18-120	Constant volume 22	Constant volume 30	Humid.-control. 6–45
Standard sound level difference D _{n,e,w}	dB	41	40	49	48	47
Max. standard sound level diff. with optional sound-insulat. elements		54	63	65	64	63
Pipe DN	∅ in mm	100	125	125	125	125
Core drilling	∅ in mm	≥ 115	≥ 130	≥ 130	≥ 130	≥ 130

Technical data: Optional accessories

Add. components (optional)		VKH 100/15-50	KWL 45 SEL	SVE 100	SVE 125	ZLA 125 SE
Standard sound level difference D _{n,e,w}	dB	–	The exact values for each configuration can be found at heliosselect.de in the "Declaration of performance" document for reference numbers 07459 and 07462.			
Pipe DN	∅ in mm	100	–	100	125	125
Length	mm	70	94	50	50	200

■ Installation kit Soffit

ZRL 100 Ref. no. 07459
ZRL 125 Ref. no. 07462

Consisting of telescopic tube 260–500 mm (DN 100 / DN 125) and EPP soffit channel (fire protection class B1). Incl. 2 plaster covers for inside and outside, for protection against contamination in the shell construction phase. Flexible installation left or right of window possible without modification.

ZRL 100 / ZRL 125



KWL 45 LG



■ Wall grille Soffit element

KWL 45 LG Ref. no. 04167
Stainless steel wall grille with integrated condensate drainage. Includes bonded seal.

KWL 45 LG-B Ref. no. 04168
Wall grille with additional coating for use in environments with heavy air contamination or high salt concentration in the air (coastal areas).

KWL 45 LG-W Ref. no. 04169
Wall grille with additional white coating.

■ Sound-insulating elem. Soffit

KWL 45 SEL Ref. no. 04170

Sound-insulating element for reducing the through sound. For installation in the soffit channel. Up to 3 sound-insulating elements can be used one complete soffit channel.

KWL 45 SEL



KWL 45 ISL



■ Insect screen

KWL 45 ISL Ref. no. 03004

Stainless steel insect screen for soffit element. Also suitable for retrofitting.

■ Flow rate stabiliser

VKH 100/15-50 Ref. no. 00002

Automatic flow rate stabiliser VKH (DN 100) for insertion in the telescopic tube. The flow rate can be set between 15 – 50 m³/h by simply moving the adjustment unit.

VKH 100/15-50



only for DN 100

ZLA 125 IB 22/30



only for DN 125

■ Inner panel 22/30 m³/h

ZLA 125 IB 22 Ref. no. 04393

ZLA 125 IB 30 Ref. no. 04394

Inner panel constant volume 22 m³/h or 30 m³/h (at 20 Pa differential pressure). Made of white plastic, ISO Coarse 30% filter.

■ Sound insulation element

ZLA 125 SE Ref. no. 04397

Sound insulation element 200 mm made from melamine resin foam for installation in the telescopic tube. With the appropriate wall thickness, up to 2 sound insulation elements can be used.

ZLA 125 SE



only for DN 125

ZLA 125 IB HY 6-45



only for DN 125

■ Inner panel humidity-controlled

ZLA 125 IB HY 6 – 45 No. 04395

Inner panel humidity-controlled between 6 - 45 m³/h (at 20 Pa differential pressure). Made of white plastic, ISO Coarse 30% filter.

■ Sound-insulating element

SVE 100 Ref. no. 08310

SVE 125 Ref. no. 08311

For simple and cost-effective volume control, pressure control and sound insulation in ventilation systems through insertion in the ducting. Up to 9 sound-insulating volume elements can be used with the corresponding wall thickness.

SVE 100 / SVE 125



■ Design ventilation valve

DLV 100 Ref. no. 03039

DLV 125 Ref. no. 03049

Design ventilation valve for supply air operation, DN 100 / DN 125, adjustable. With closed front and integrated ISO Coarse 30% filter.

DLV 100 / DLV 125



Performance curves DLV 100

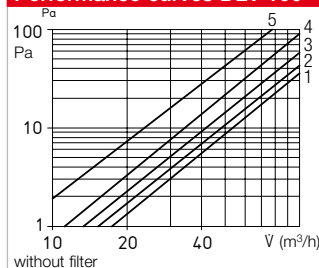

Performance curves DLV 125

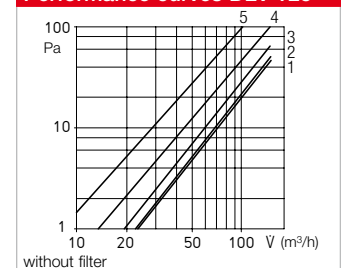

Central ventilation system ZLS-DV EC according to the German standard DIN 18017-3.

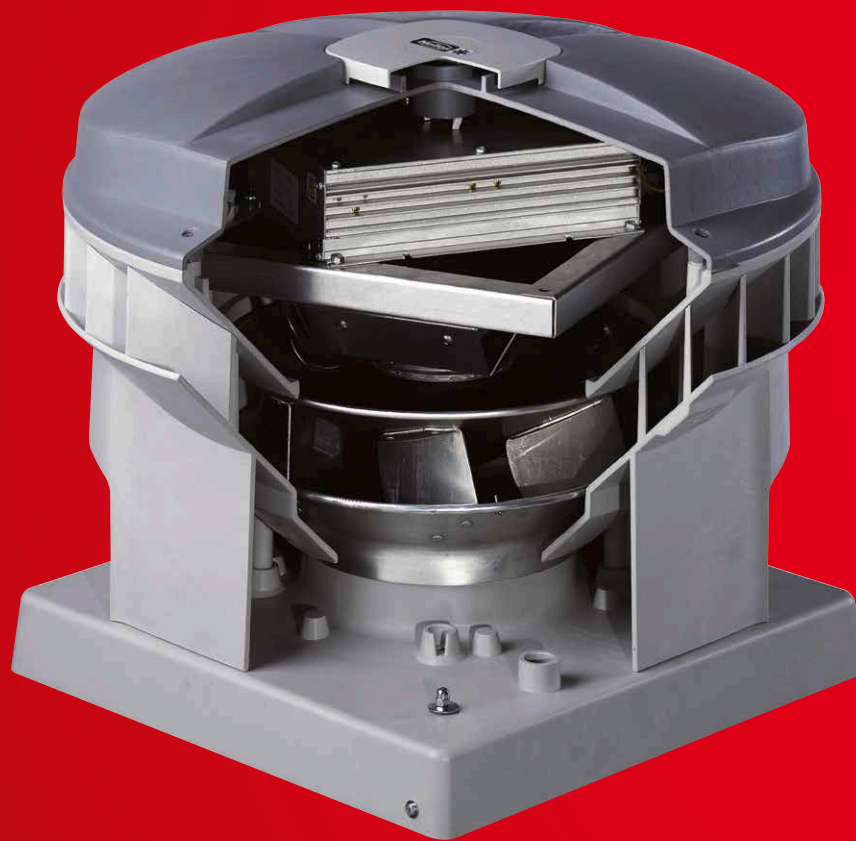

ZLS-DV EC is the ideal central ventilation system for multi-floor construction in accordance with DIN 18017-3.

Humid, contaminated air is extracted in line with requirements. The integrated pressure-regulated control system in the fan simultaneously ensures

that a predetermined under-pressure is maintained. The planned volume flow therefore always remains the same in all other rooms.

Energy-saving EC technology with the highest level of efficiency, even in control mode, and up to 45% energy savings over conventional motors.

■ **Extract air**

The roof fan is connected to the central extract air shaft. The stale air from wet rooms and kitchens flows out of the extract air elements with usage-oriented functionality. The automatic, continuously variable power adjustment takes place via the integrated pressure sensor.



78^f

■ **Intake air**

Draught-free intake air is supplied to the living rooms and bedrooms via automatic elements for window or wall installation.

80^f

■ **Fire protection**

The spread of fire to other floors is prevented according to the structural requirements in the classified or non-classified shaft.

81^f



DV EC



Dimensions DV EC

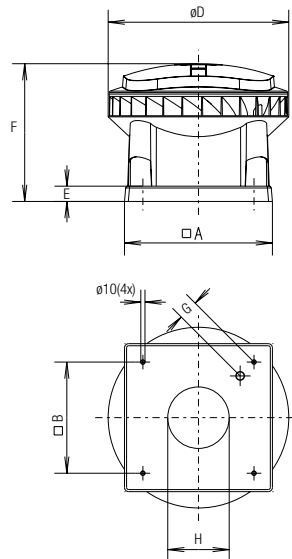

Dimensions in mm

Extremely weather-resistant EC roof fan in plastic design for an extensive range of applications, diagonal outlet.

Common features
DV EC Pro und DV EC Eco

- **Casing**
Aerodynamically designed plastic casing made of grey polypropylene with diagonal air outlet direction. Air flow temperatures from -30 to +60 °C.
- **Impeller**
Diagonal impeller made of aluminium, the motor impeller unit is dynamically balanced for low-noise operation.
- **Drive**
Energy-efficient EC external rotor motor in protection category IP54. Optimised efficiency even with speed control for low operating costs. Continuously variable speed control. Maintenance-free and radio interference-free, ball bearing mounted.

- **Motor protection**
Integrated electronic temperature monitoring system for EC motor and electronics.
- **Electrical connection**
Standard operating switch (protection category IP65) mounted on the outside of the casing. Connection voltage 1~, 230 V, 50 Hz.
- **Installation**
Horizontal alignment on the roof. In case of sloping roofs, a corresponding base formation must be used to prevent water ingress. A range of accessories facilitates the installation of the fan in the building duct system.
- **Noise**
The total level and range are specified above the performance diagram for:
 - Inlet side sound power
 - Outlet side sound power.
 The case-radiated noise as sound pressure at 4 m (free field conditions) is also specified in the type table and the table below the performance curve.

PRO

Description DV EC Pro

- **Power control**
 - Ideal as a central extract air fan for multi-floor residential construction in accordance with DIN 18017-3.
 - When combined with other components (accessories), a complete central ventilation system in accordance with DIN 18017-3 can be created with demand-driven ventilation.
 - Integrated pressure control for constant volume flow control in the connected rooms through automatic speed adjustment at almost constantly high efficiency.
 - Integrated pressure sensor 0–300 Pa.
 - Short amortisation period due to high energy saving.
 - Operating data setting at the 4 potentiometers integrated in the control system to set the desired operating point on site.
 - Integrated serial bus interface (RS 485) for connection to a PC/laptop in connection with the interface (accessories).

Dimensions in mm			
Type	DV EC 200	DV EC 250	DV EC 400
□ A	460	580	665
□ B	330	450	535
∅ D	575	708	863
E	60	60	60
F	473	540	601
G	44	48	64
H	196	241	302

ECO

Description DV EC Eco

- **Power control**
 - Continuously variable speed control with speed potentiometer PU/PA 10 (accessories, see type table).
 - When combined with the universal control system EUR EC or electronic pressure/temperature controllers EDR/ETR (accessories, see type table), the fan can be used for the continuously variable control of differential pressure, differential temperature or flow velocity. Performance levels are shown in the performance curve as an example.

Type	Ref. no.	Maximum speed approx.	Flow rate free blowing	Noise sound pressure	Power consumption at maximum speed		Wiring diagram	max. air flow temperature	Weight net approx.	Timer / Universal control system		Speed potentiometer			
					kW	A				Type	Ref. no.	Type	Ref. no.	Type	Ref. no.
PRO Type DV EC Pro, single phase alternating current, 230 V, 50/60 Hz, EC motor, IP54											Timer				
DV EC 200 Pro	08385	1810	2010	52	0.18	1.38	863.1	60	17.0	ZLS-ZU 31	08388	–	–	–	–
DV EC 250 Pro	08386	1640	3700	60	0.41	1.78	863.1	60	23.0	ZLS-ZU 31	08388	–	–	–	–
DV EC 400 A Pro	08387	1020	4070	51	0.30	1.33	863.1	60	33.0	ZLS-ZU 31	08388	–	–	–	–
DV EC 400 B Pro	08389	1425	5650	65	0.75	3.32	863.1	60	35.0	ZLS-ZU 31	08388	–	–	–	–
ECO Type DV EC Eco, single phase alternating current, 230 V, 50/60 Hz, EC motor, IP54											Control system				
DV EC 200 Eco	08320	1810	2010	52	0.18	1.38	991	60	17.0	EUR EC ¹⁾²⁾	01347	PU 10 ³⁾	01734	PA 10 ³⁾	01735
DV EC 250 Eco	08322	1640	3700	60	0.41	1.78	991	60	23.0	EUR EC ¹⁾²⁾	01347	PU 10 ³⁾	01734	PA 10 ³⁾	01735
DV EC 400 A Eco	08324	1020	4070	51	0.30	1.33	991	60	33.0	EUR EC ¹⁾²⁾	01347	PU 10 ³⁾	01734	PA 10 ³⁾	01735
DV EC 400 B Eco	08326	1425	5650	65	0.75	3.32	991	60	35.0	EUR EC ¹⁾²⁾	01347	PU 10 ³⁾	01734	PA 10 ³⁾	01735

¹⁾ Multiple EC fans can normally be connected. ²⁾ Alternative elec. pressure/temp. controller (EDR/ETR, no. 01437/01438) in combination with mains adapter NG 24, no. 01439, see accessories. ³⁾ Without LED power supply.

Performance curves DV EC 200

Frequency	Hz	Tot.	125	250	500	1k	2k	4k	8k
L _{WA} Inlet side	dB(A)	70	54	64	64	65	61	55	46
L _{WA} Outlet side	dB(A)	72	53	57	66	69	66	57	46

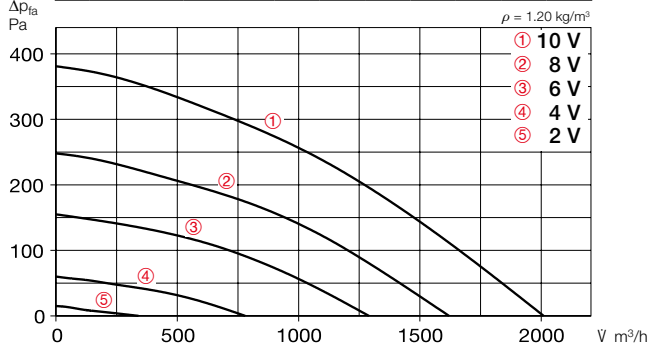

Free blowing						
Voltage V	n min ⁻¹	V m ³ /h	P W	I A	Lp dB(A)	SFP kW/m ³ /s
10	1810	2010	180	1.38	52	—
8	1480	1620	108	0.90	47	—
6	1200	1290	60	0.54	41	—
4	720	780	21	0.20	31	—

Performance curves DV EC 250

Frequency	Hz	Tot.	125	250	500	1k	2k	4k	8k
L _{WA} Inlet side	dB(A)	75	60	64	70	69	67	61	52
L _{WA} Outlet side	dB(A)	80	63	65	75	76	72	63	52

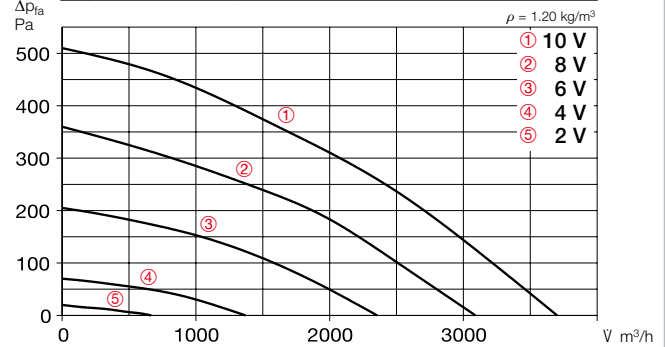

Free blowing						
Voltage V	n min ⁻¹	V m ³ /h	P W	I A	Lp dB(A)	SFP kW/m ³ /s
10	1640	3700	412	1.78	60	—
8	1380	3100	264	1.14	55	—
6	1100	2350	138	0.60	49	—
4	650	1370	40	0.20	36	—

Performance curves DV EC 400 A

Frequency	Hz	Tot.	125	250	500	1k	2k	4k	8k
L _{WA} Inlet side	dB(A)	68	55	62	63	63	58	51	44
L _{WA} Outlet side	dB(A)	72	56	61	68	67	60	52	43

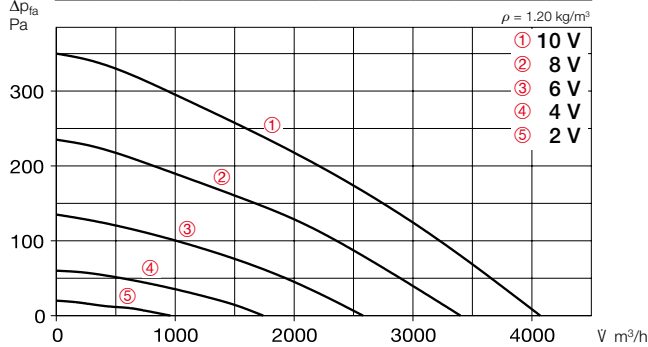

Free blowing						
Voltage V	n min ⁻¹	V m ³ /h	P W	I A	Lp dB(A)	SFP kW/m ³ /s
10	1020	4070	303	1.33	51	—
8	850	3400	176	0.77	46	—
6	650	2580	85	0.40	40	—
4	450	1740	33	0.20	31	—

Performance curves DV EC 400 B

Frequency	Hz	Tot.	125	250	500	1k	2k	4k	8k
L _{WA} Inlet side	dB(A)	80	64	69	75	74	74	65	58
L _{WA} Outlet side	dB(A)	85	66	72	82	81	76	66	56

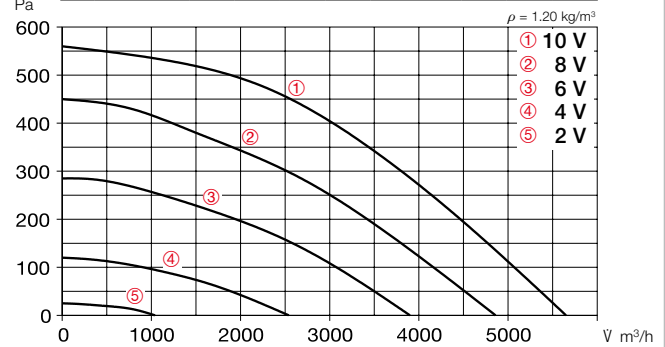

Free blowing						
Voltage V	n min ⁻¹	V m ³ /h	P W	I A	Lp dB(A)	SFP kW/m ³ /s
10	1425	5650	755	3.32	65	—
8	1225	4860	485	2.10	60	—
6	1000	3900	265	1.15	54	—
4	650	2540	90	0.40	43	—

■ Extract air elements



Ready-to-install extract air elements with mounting ring made of plastic.

For insertion in ducts with ND 125. With demand-controlled and basic ventilation level, electric, humidity, motion and time-controlled for use according to the adjacent table. Types AE and AE GB come with self-regulating constant volume flow control. Humidity-controlled types AE Hygro or type AE FV with filter and volume adjustment are preferable in kitchens and bathrooms.

Attachment filter element VFE

For installation in front of AE in case of greasy, contaminated room air. Details on product page.

Bathroom		WC		Kitchen	
Type	Ref. no.	Type	Ref. no.	Type	Ref. no.
Extract air element , with self-regulating constant volume flow control				*Volume flow in m ³ /h	
AE 45*	02031	AE 30*	02030	AE 75*	02033
Like above , but with two volume flows (demand-controlled and basic ventilation)					
AE GB 20/75*	02036	AE GB 15/30*	02035	AE GB 45/120*	02038
Like AE GB , with additional electr. time control (without constant volume flow control)					
AE GBE 30/60*	02047	AE GBE 15/30*	02044	AE GBE 45/120*	02048
Like AE GBE , but with presence detector					
		AE B 15/30*	02055		
Humidity-controlled extract air element with variable, limited volume flow					
AE Hygro 10/45*	02049				
Like AE Hygro , with additional electrically controlled demand-controlled ventilation level					
AE Hygro GBE 5/40/75*	02053			AE Hygro GBE 10/45/120*	02054
Extract air element AE FV , with filter and volume adjustment					
AE FV 125	09478			AE FV 125	09478
Attachment filter element VFE					
– for AE / AE GBE, AE Hygro, prevents contamination of the extract air element and duct system					
				VFE 70/VFE 90	02552/02553

□ In-duct fire dampers for extract air elements AE



□ Cold smoke shutters KAK



Fire and smoke damper.

For insertion in spiral duct without additional wall frame or for wall installation using mounting sleeve EH (accessories).

Cold smoke shutter with automatic magnetic catch. Prevents the backflow of cold smoke etc. in central ventilation systems in other fire sections.

Type	Ref. no.
In-duct fire damper K 90-18017	
BAE 125*	02626
In-duct fire damper K 90-4102	
BAK 125*	02621
Mounting sleeve (accessory for both types)	
EH 125*	02640
Cold smoke shutter	
KAK 125*	04098

* ND 125, compatible with above AE. See product pages for other ND and detailed descriptions.

□ Sound insulation elements SVE (also suitable for supply air)



Sound insulation elements for simple sound insulation and volume control in central ventilation systems through duct insertion. These elements can also be used for pressure control.

SVE 100	Ref. no. 08310
ND 100 mm	
SVE 125*	Ref. no. 08311
ND 125 mm	

■ Overflow



Door grilles

Unobtrusive, sight screening ventilation grille made of break-resistant plastic for installation in door leaf.

LTGW	Ref. no. 00246
Made of plastic, white.	
LTGB	Ref. no. 00247
Made of plastic, white.	

■ Intake air elements
□ Installation in wall openings



Universally applicable automatic supply air elements and thermostat disc valves for demand-based intake air volume control. See Intake air elements page for detailed description.

Ø 80		Ø 100		Ø 160	
Type	Ref. no.	Type	Ref. no.	Type	Ref. no.
Automatic supply air element – Automatically temperature-controlled incl. thermostat disc valve, sound insulation and external grille					
ZLA 80	00214	ZLA 100	00215	ZLA 160	00216
Supply air element – Manually controllable in four levels incl. disc valve with drawcord, sound insulation and external grille					
		ZLE 100	00079		
Thermostat disc valve – For installation in existing ventilation openings					
ZTV 80	00078	ZTV 100	00073	ZTV 160	00074

Automatic supply air element ZLA 125 see product pages.

□ Installation in window frames



Intake air element with volume flow control and limitation. See Intake air elements product page for detailed description. Ideal for retrofitting and new constructions.

V m ³ /h	Type	Ref. no.	Type	Ref. no.
Intake air element for installation in window frames – with volume flow control and limitation				
30	ALEF 30	02100	ALEFS 30	02102
45	ALEF 45	02101	ALEFS 45	02103
Intake air element for installation in window frames – humidity-controlled, with volume flow control and limitation				
5/45	ALEF Hygro 5/45	02056	ALEFS Hygro 5/45	02057

■ Flange connection plate

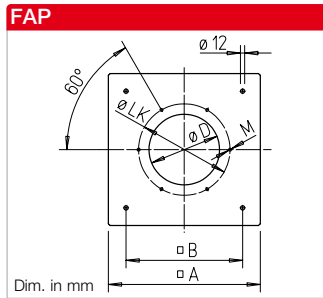

Flange connection plate FAP

Made of galvanised steel sheet. This allows the connection of the duct system and accessories to the roof fans DV EC if no base silencer SSD is used.

Type	FAP 200	FAP 250	FAP 400
Ref. no.	08382	08383	08384
□ A mm	430	550	635
□ B mm	330	450	535
∅ D mm	200	250	400
∅ LK mm	259	286	438
M	M 6	M 6	M 8
Gewicht kg	1.8	3.0	3.3

■ Flange, flanged flex. connector



Compatible with roof fan:

DV EC 200		DV EC 250		DV EC 400	
Type	Ref. no.	Type	Ref. no.	Type	Ref. no.
Flange connection plate – Required for duct-pipe connection					
FAP 200	08382	FAP 250	08383	FAP 400	08384
Counterflange					
DFR 200	01201	FR 250	01203	FR 400	01206
Flanged flexible connector					
DSTS 200	01218	STS 250	01220	STS 400	01223

See product pages for detailed description.

■ Flat roof base



Compatible with roof fan:

DV EC 200		DV EC 250		DV EC 400	
Type	Ref. no.	Type	Ref. no.	Type	Ref. no.
Flat roof base – With swing-action device for easy inspection					
FDS 200	01378	FDS 250	01379	FDS 400	01380
Base silencer – With swing-action device for easy inspection					
SSD 200	05290	SSD 250	05292	SSD 400	05291

See product pages for detailed description.

■ Base silencer

■ Fire protection

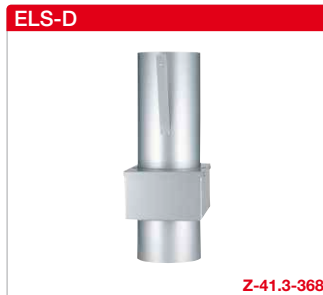

Fire protection ceiling seal ELS-D

to prevent spread of fire to other floors. Installation in main ventilation pipe according to DIN 18017 K90. Maintenance-free. For ventilation or mixed (even with combustible pipes) installation shafts which only require cladding with 12.5 mm

plasterboard. All other parts (disc valves etc.) without fire resistance classification. Branch and connection pipes also available in Aluflex pipe. Shutter elements KAK are available to prevent the backflow of cold smoke (see left page or page 589).

ND mm main pipe	100	125	140	160	180	200
Type	ELS-D 100	ELS-D 125	ELS-D 140	ELS-D 160	ELS-D 180	ELS-D 200
Ref. no.	00270	00185	00186	00187	00188	00271

■ Control system

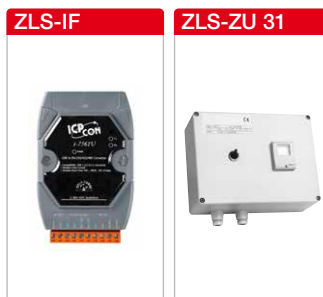

Interface

Interface for commissioning or controlling the fan in combination with a PC/laptop. Incl. mains adapter, adapter cable and software.

ZLS-IF Ref. no. 08391

Electronic timer module with day and night switchover

Allows the parallel operation of max. 31 DV EC roof fans. The rocker switch is used to enable the DV EC fans. The day and night switchover takes place via the settings in the display.

Incl. main switch. 230 V, 50 Hz.
ZLS-ZU 31 Ref. no. 08388

Accessory details	Page
Roof install. accessories	551 f.
Ventilation grilles	553 ff.
Extract air elements	566 ff.
Intake air elements	578 ff.
Fire protection systems	582 ff.
– Ceiling seal	588 ff.
Universal control systems, electronic controllers, speed potentiometer	605 ff.

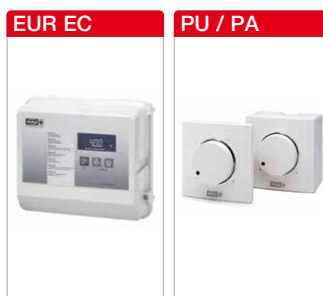

Universal control system

For the continuously variable control or regulation of single and three-phase EC fans with a setpoint of 0–10 V DC:

EUR EC Ref. no. 01347

Speed potentiometer

For the direct control/setpoint setting of EC fans with a potentiometer input.

PU 10 (UP) Ref. no. 01734

PA 10 (AP) Ref. no. 01735

Compact central extract ventilation systems.

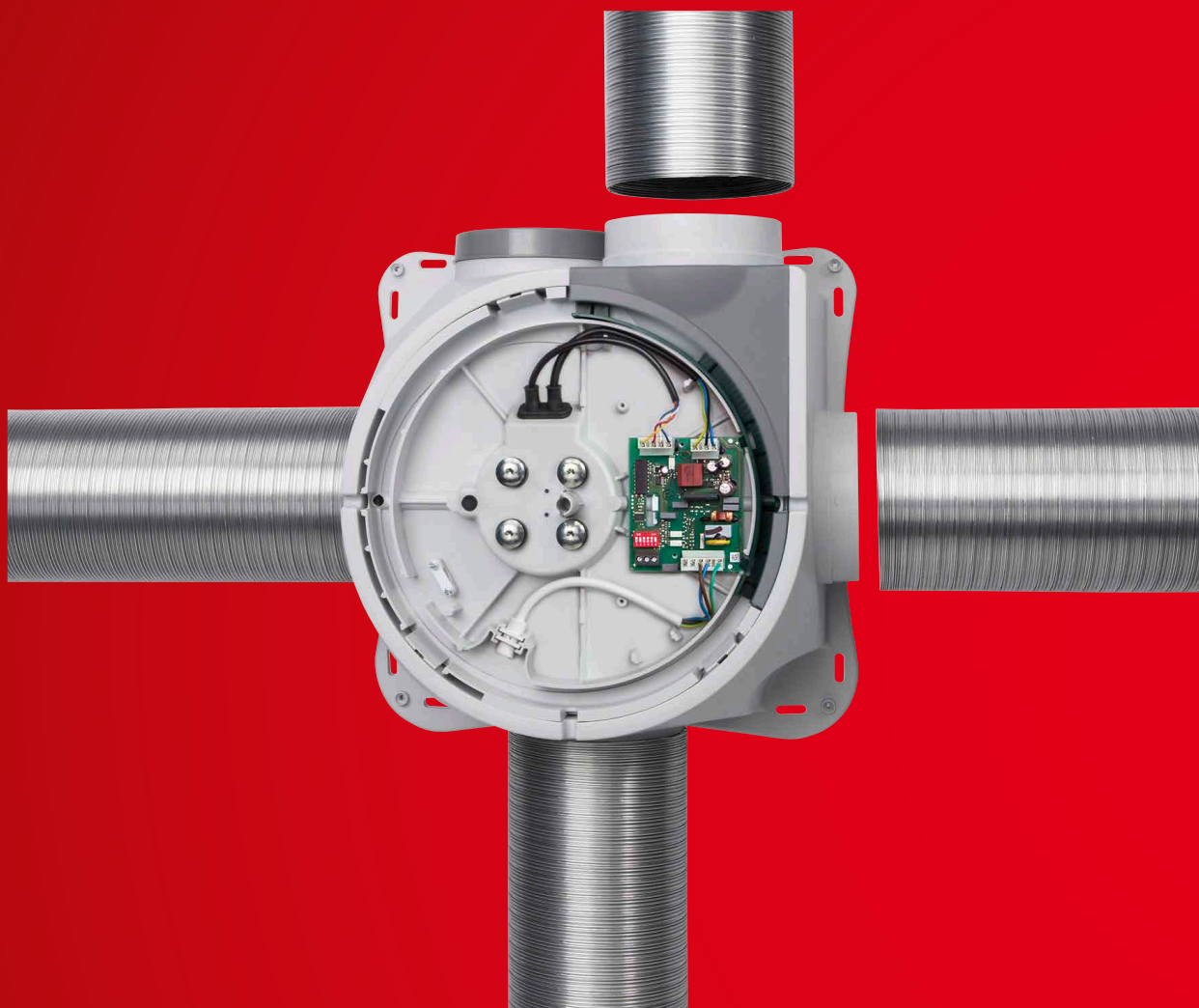

The energy-saving box with powerful performance. Ideal in low-energy houses or apartments.

Passive houses and low-energy houses set the standard for the watertightness and insulation of building envelopes. Compliance with requirements must be verified in a specific check upon formal acceptance of the building. In order to comply with the German Energy Saving Ordinance (EnEV), ventilation units must be used with maximum

efficiency in full-load mode and control mode. The removal of humidity, odours and pollutants as well as the draught-free, controlled introduction of fresh intake air are prerequisites for a pleasant indoor climate and maintaining a structurally-sound building.

The ZEB system achieves this perfectly, whether in a single-family house, in the floor-by-floor extract ventilation of residential units via a shared central shaft (DIN 18017-3) or in the commercial sector.

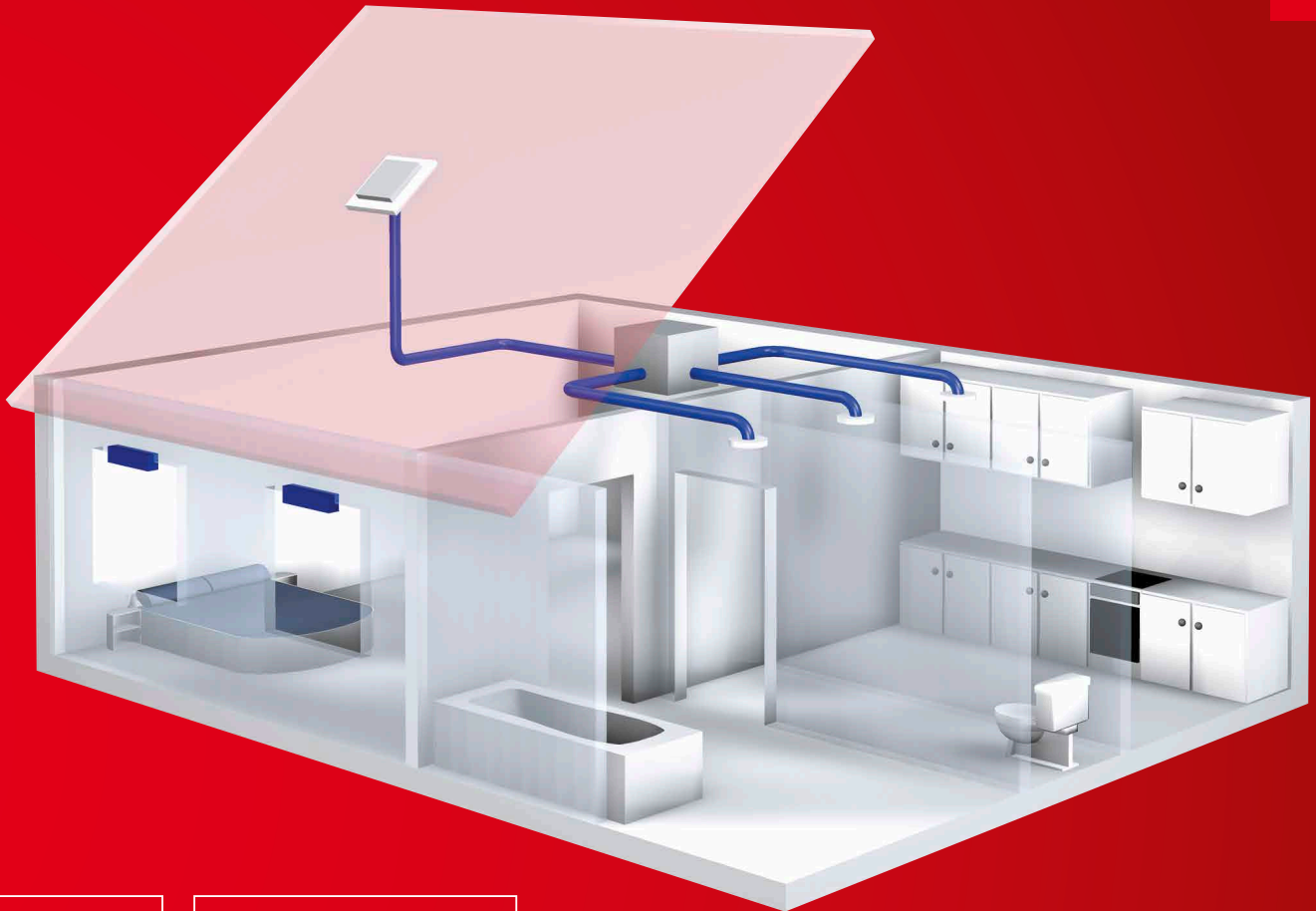

■ **Extract air**

ZEB positioned below the roof or in a secondary room as an extract air box. Operation is manual or automatic. The extract air is removed from rooms with contaminated air such as kitchens, bathrooms and WCs. Innovative extract air elements allow a constant or demand-oriented volume flow, adjusted to individual user requirements or room requirements.

84^f

■ **Intake air / Exhaust air**

Finely dosed quantities of intake air flow in via pressure differential-controlled intake air elements, which must be placed in the walls or windows of living rooms and bedrooms. Overflow elements ensure the air circulation within the room unit. The exhaust air is discharged to the outside via a roof outlet or wall outlet.

86^f

ZEB 380



Dimensions ZEB 380

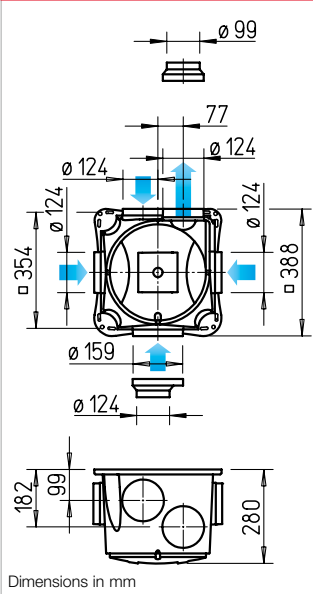

Performance curves ZEB 380

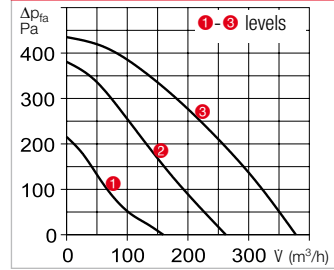

Compact ventilation box with four connectors for the attachment of extract air pipes. For versatile use in residential, commercial and industrial locations.

Application

- As a central extract air unit for multiple rooms or areas.
- For domestic ventilation according to DIN 18017. Ventilates e.g. kitchen, bathroom, WC in multiple residential units with a central main pipeline in platform-framed buildings. For the ventilation of multiple rooms (e.g. living room, kitchen, bathroom, WC) in one residential unit. Simple installation (in any position) in storage rooms or below the roof.
- For the commercial and industrial ventilation of wet rooms, toilet facilities, extraction of vapours in the workplace, etc.

Casing

- Robust casing made of impact-resistant plastic, light grey.
- The three inlet connectors and the outlet connector are designed for pipes NW 100 and 125 mm. One inlet connector is designed for pipes NW 100, 125 and 160 mm.

Impeller

Low-noise centrifugal impeller made of steel in an aerodynamically optimised spiral. Inlet via nozzle.

Motor

- Enclosed, ball bearing mounted external rotor motor in IP44, with humidity protection, insulation class B, for continuous operation, maintenance-free and radio interference-free.
- Motor/impeller unit can be removed with one hand for cleaning and servicing.

Motor protection

Motor protection through integrated thermal contacts, with the winding connected in series, automatic deactivation and re-activation after cooling.

Electrical connection

- Service-friendly and connection-friendly. Supplied ready for use with cable and wired terminal box.
- NYM-J 5 x 1,5 mm² required for three level operation.

Power control

Variable power adjustment with three speeds using operating switch (accessories).

Installation

No restrictions in any position. Preferably away from the room to be ventilated for less noise.

Duct system

For example, rigid spiral ducts, flexible aluminium ducts or even plastic ducts can be used. However, the fire protection regulations must be observed for crossing fire sections.

Accessories	Page
Overview	86 ff.
Accessory details	Page
Flexible ventilation ducts, roof outlets, shutters and ventilation grilles	553 ff.
Extract air elements	566 ff.
Intake air elements	578 ff.
Fire protection elements for use in multi-fl. const.	582 ff.
Control and regul. units	591 ff.

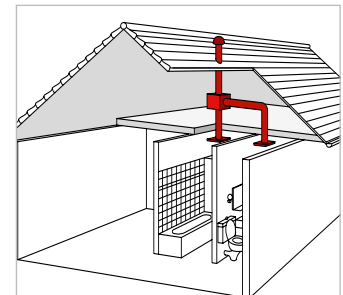

Accessories

Three level speed and operating switch with 0 position.

Convenient flush-mounted speed switch. Room light not switchable in parallel. Installation in flush-mounted switch box. Dim. mm (WxHxD) 80 x 80 x 23
DSEL 3 Ref. no. 01611



Weekly timer

Digital timer with LCD display for autom. control of operating mode, can be programmed for every day of the week. For surface and flush-mounted installation. Dim. mm (WxHxD) 84 x 84 x 40
WSUP Ref. no. 09990
For switch cabinet installation (2 space units required). Dim. mm (WxHxD) 36 x 90 x 63
WSUP-S Ref. no. 09577



Type	ZEB 380
Ref. no.	01456
Flow rate free blowing m ³ /h*	380 / 260 / 160
Speed min ⁻¹ approx.	max. 2730
Voltage / Frequency	230 V~, 50 Hz
Power consumption max. W*	67 / 38 / 20
Rated current max. A*	0.28 / 0.23 / 0.17
Sound pressure level, case-radiated noise at 4 m*	33 / 26 / 19
L _{WA} inlet side dB(A)*	62 / 57 / 45
L _{WA} outlet side dB(A)*	69 / 63 / 52
Wiring diagram no.	908
Max. permissible temperature °C	+ 40
Weight approx. kg	5.9

* Values refer to the three performance levels (see performance diagram).

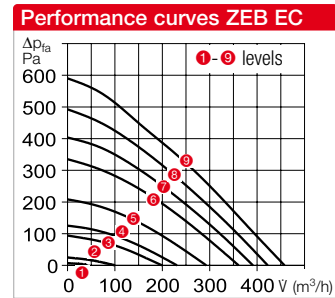
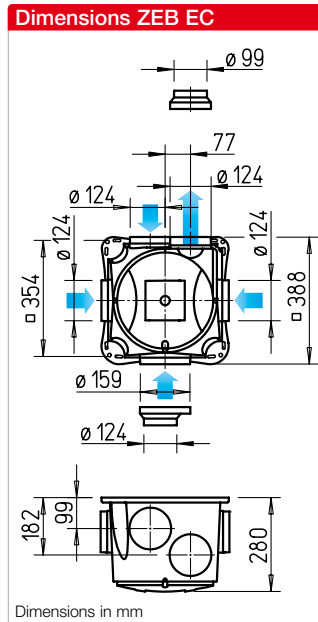
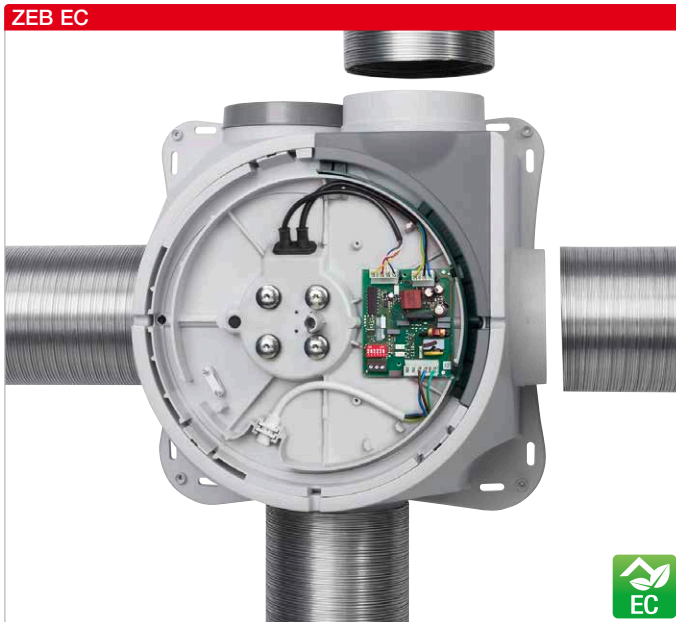

ZEB with EC technology – when equipped with a DC motor, the EC variant of the ZEB becomes the “energy-saving ventilation box”, which is ideal for use in low-energy houses. Brushless DC motors operate with extremely low losses and also with higher efficiency than conventional motors, even in control mode. This results in compelling advantages:

- Short amortisation period due to high energy saving.
- Simple and convenient speed control at nine possible power levels.

Application

- For controlled domestic ventilation according to DIN 18017-3 and DIN 1946-6.
- Ideal in low-energy houses.
- For ventilation via a shared main pipeline in single-family houses as well as apartments and multi-floor residential units.

Casing

- Robust casing made of impact-resistant plastic, light grey.
- The three inlet connectors and the outlet connector are designed for pipes NW 100 and 125 mm. One inlet connector is designed for pipes NW 100, 125 and 160 mm.

Type	ZEB EC
Ref. no.	01457
Flow rate free blowing m ³ /h*	460/430/400/360/300/230/200/100/40
Speed min ⁻¹ approx.	max. 3200
Voltage / Frequency	230 V~, 50 Hz
Power consumption max. W*	69/55/44/34/19/11/8/3/2
Rated current max. A*	0.58/0.47/0.38/0.30/0.18/0.10/0.08/0.04/0.04
Sound pressure level, case-radiated noise at 4 m*	37/36/34/32/27/21/< 20/< 20/< 20
L _{WA} inlet side dB(A)*	65/63/62/61/57/53/47/37/34
L _{WA} outlet side dB(A)*	74/72/70/68/62/57/54/39/26
Wiring diagram no.	1115
Max. permissible temperature °C	+ 40
Weight approx. kg	5.9

* Values refer to the three performance levels (see performance diagram).

Impeller

Low-noise centrifugal impeller made of steel in an aerodynamically optimised spiral. Inlet via nozzle.

Motor

- DC motor, electronically commutated, with high efficiency, even in control mode. Ball bearing mounted external rotor motor in IP44 continuous operation, maintenance-free and radio interference-free.
- Motor/impeller unit can be removed with one hand for cleaning and servicing.

Motor protection

Motor protection through integrated thermal element which monitors the winding temp. together with the electronics.

Electrical connection

- Service-friendly and connection-friendly. Supplied ready for use with wired terminal box.
- Direct connection to 230 V mains power.
- NYM-J 5 x 1,5 mm² required for three level operation.

Power control

Fan operation in three levels using operating switch (accessories).

9 speeds are available for individual power adjustment due to the DIP switch in the drive electronics.

Installation

No restrictions in any position. Preferably away from the room to be ventilated for less noise.

Accessories

Three level speed and operating switch with 0 position.

Convenient flush-mounted speed switch. Room light not switchable in parallel. Installation in flush-mounted switch box (depth min. 55 mm).
 Dim. mm (WxHxD) 80 x 80 x 23
DSZ Ref. no. 01598

Weekly timer

Digital timer with LCD display for autom. control of operating mode, can be programmed for every day of the week. For surface and flush-mounted installation.
 Dim. mm (WxHxD) 84 x 84 x 40
WSUP Ref. no. 09990
 For switch cabinet installation (2 space units required).
 Dim. mm (WxHxD) 36 x 90 x 63
WSUP-S Ref. no. 09577

Electronic control system

For continuously variable control or regulation of single phase and three-phase EC fans.
 Dim. mm (WxHxD) 223 x 200 x 131
EUR EC Ref. no. 01347

Three level switch 10 V / 0–10 V

For three level control of EC fans or frequency converters, with a 0–10 V DC control input. For surface and flush-mounted installation.
 Dim. mm (WxH) 80 x 80
SU-3 10/SA-3 10 no. 04266/04267

Duct system

For example, rigid spiral ducts, flexible aluminium ducts or even plastic ducts can be used. However, the fire protection regulations must be observed for crossing fire sections.

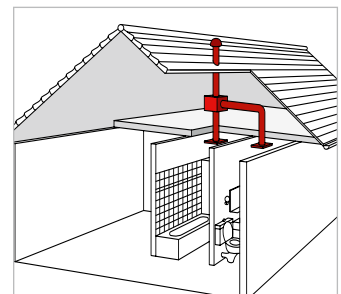

■ Extract air elements



Ready-to-install extract air elements with mounting ring made of plastic.

For insertion in ducts with ND 125. With demand-controlled and basic ventilation level, electric, humidity, motion and time-controlled for use according to the adjacent table. Types AE and AE GB come with self-regulating constant volume flow control. Humidity-controlled types AE Hygro or type AE FV with filter and volume adjustment are preferable in kitchens and bathrooms.

Attachment filter element VFE
For installation in front of AE in case of greasy, contaminated room air. Details on product page.

Bathroom		WC		Kitchen	
Type	Ref. no.	Type	Ref. no.	Type	Ref. no.
Extract air element , with self-regulating constant volume flow control				*Volume flow in m ³ /h	
AE 45*	02031	AE 30*	02030	AE 75*	02033
Like above, but with two volume flows (demand-controlled and basic ventilation)					
AE GB 20/75*	02036	AE GB 15/30*	02035	AE GB 45/120*	02038
Like AE GB, with additional electr. time control (without constant volume flow control)					
AE GBE 30/60*	02047	AE GBE 15/30*	02044	AE GBE 45/120*	02048
Like AE GBE, but with presence detector					
		AE B 15/30*	02055		
Humidity-controlled extract air element with variable, limited volume flow					
AE Hygro 10/45*	02049				
Like AE Hygro, with additional electrically controlled demand-controlled ventilation level					
AE Hygro GBE 5/40/75*	02053			AE Hygro GBE 10/45/120*	02054
Extract air element AE FV , with filter and volume adjustment					
AE FV 125	09478			AE FV 125	09478
Attachment filter element VFE					
– for AE / AE GBE, AE Hygro, prevents contamination of the extract air element and duct system					
				VFE 70/VFE 90	02552/02553

□ Extract air (alternative to AE)



Automatic volume flow stabiliser for insertion in ventilation ducts and pipe fittings. Realises the rated output in the differential pressure range from approx. 50–250 Pa.

V m ³ /h	Ø 80		Ø 100		Ø 125	
	Type	Ref. no.	Type	Ref. no.	Type	Ref. no.
15-50	VKH 80/15-50	00001	VKH 100/15-50	00002	VKH 125/15-50	00004
50-100			VKH 100/15-100	00003	VKH 125/50-100	00005
100-180					VKH 125/100-180	00006

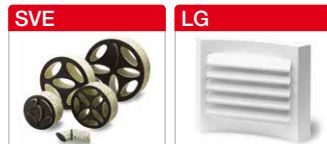

Sound insulation elements for simple sound insulation and volume control through duct insertion. Also for pressure control.
Ventilation grilles and disc valve, especially for living spaces.

Ø 80		Ø 100		Ø 125	
Type	Ref. no.	Type	Ref. no.	Type	Ref. no.
Sound insulation elements					
SVE 80	08309	SVE 100	08310	ZSVE 125	08311
Ventilation grille (for covering types VKH and SVE)					
LGK 80	00259	LGM 100	00254	LGM 125	00258
Plastic disc valves, for extract air					
KTVA 75/80	00940	KTVA 100	00941	KTVA 125	00942

■ Intake air elements

□ Installation in wall openings



Universally applicable automatic disc air elements and thermostat supply valves for demand-based intake air volume control. See Intake air elements page for detailed description.

Ø 80		Ø 100		Ø 160	
Type	Ref. no.	Type	Ref. no.	Type	Ref. no.
Automatic supply air element – Automatically temperature-controlled incl. thermostat disc valve, sound insulation and external grille					
ZLA 80	00214	ZLA 100	00215	ZLA 160	00216
Disc air element – Manually controllable in four levels incl. disc valve with drawcord, sound insulation and external grille					
		ZLE 100	00079		
Thermostat disc valve – For installation in existing ventilation openings					
ZTV 80	00078	ZTV 100	00073	ZTV 160	00074

Automatic supply air element ZLA 125 see product pages.

□ Installation in window frames



Intake air element with volume flow control and limitation. See Intake air elements product page for detailed description. Ideal for retrofitting and new constructions.

V m ³ /h	Type	Ref. no.	Type	Ref. no.
Intake air element for installation in window frames – with volume flow control and limitation				
30	ALEF 30	02100	ALEFS 30	02102
45	ALEF 45	02101	ALEFS 45	02103
Intake air element for installation in window frames – humidity-controlled, with volume flow control and limitation				
5/45	ALEF Hygro 5/45	02056	ALEFS Hygro 5/45	02057

■ Ducts, fittings



Ø 80		Ø 100		Ø 125	
Type	Ref. no.	Type	Ref. no.	Type	Ref. no.
Fully flexible ventilation duct					
ALF 80	05711	ALF 100	05712	ALF 125	05713
Duct connector – Made of steel sheet, galvanised					
RVB 80	05993	RVB 100	05994	RVB 125	05995
Hose clips – Metal band with turnbuckle, unit = 10 pcs.					
SCH 80	05722	SCH 100	05722	SCH 125	05723
T-pieces – Made of steel sheet, galvanised					
		TS 100	01479	TS 125	05720

■ Duct reduction



Ø 80		Ø 100		Ø 125	
Type	Ref. no.	Type	Ref. no.	Type	Ref. no.
Duct reductions – Made of plastic					
		RZ 100/80	05223	RZ 125/100	05222
Flexible cross talk silencer – Made of flexible aluminium pipe					
		FSD 100	00676	FSD 125	00677
Duct shutters – Automatic, made of plastic					
		RSKK 100	05106	RSKK 125	05107
Inline duct shutters – Airtight, for duct insertion					
RVE 80	02584	RVE 100	02587	RVE 125	02588

■ Silencers, shutters



■ Wall duct, roof duct

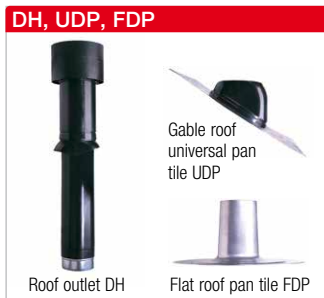

Ø 80		Ø 100		Ø 125	
Type	Ref. no.	Type	Ref. no.	Type	Ref. no.
Telescopic wall kit – For wall outlet from supply air pipes and extract air pipes					
		TMK 100	00844	TMK 125/150	00845
Universal roof outlet* DDF – Adjustable to all types of tile on gable and flat roofs					
				DDF 125	01964
Roof outlet, pan tiles for gable/flat roofs and pipe joints					
– Roof outlet*		DH 100 S	02015	DH 125 S	02017
– Gable roof universal pan tile*		UDP 100 S	02021	UDP 125 S	02021
– Flat roof pan tile		FDP 100	02024	FDP 125	02013
– Pipe joint		STV 100	02026	STV 125	02027

* See product page for other colour designs.

■ Overflow



Door grilles

Unobtrusive, sight screening ventilation grille made of break-resistant plastic for installation in door leaf. See Ventilation grilles product page for detailed description.

LTGW Ref. no. 00246
Made of plastic, white.

LTGB Ref. no. 00247
Made of plastic, brown.

■ Reference

Reference	Page
Dimensions, further technical information and other sizes:	
Ventilation grilles,	
Ducts, Fittings,	
Roof ducts	553 ff.
Extract air elements	566 ff.
Intake air elements	578 ff.
Fire protection elements for use in multi-fl. const.	582 ff.
Control and regul. units	591 ff.

Ventilation systems with heat recovery



The compact wall units KWL 170 W to KWL 500 W and the ultra-flat ceiling units KWL 220 D and KWL 340 D are equipped with Helios easyControls 3.0 as standard.

They are thereby setting a new standard for the operation of KWL units.

Thanks to the integrated web server and LAN connection, the ventilation units can be integrated into a PC network and conveniently controlled via a user interface in a web browser on a laptop or smartphone – even when on the move via the internet.

Building control system interfaces, optional control elements and air quality sensors provide additional possibilities. The smart, modular unit concept allows individual configuration according to the building requirements.

The KWL EC series “S” for standing, space-saving floor installation, is available with air flow rates from 800 to 2600 m³/h. Ideal for use as central units with heat recovery in residential, commercial and industrial applications.

Certified according to the passive house standard and including special control technology for constant volume control or constant pressure control. Optionally available with integrated pump warm water heating element.

Helios KWL added value. The universal, perfectly matched Helios KWL system solutions guarantee simple planning, secure installation and maximum efficiency.

Services such as KWL specialist seminars, practical workshops and the almost self-explanatory online software tool **KWLeasyPlan.de** also facilitate the design, planning and installation.

Central domestic ventilation with heat recovery

■ Wall installation

KWL EC 45-160, KWL EC 60 for flush-mounted wall installation in single rooms, ideal for renovations.



94ff

■ KWL Yoga

Compact wall units from 400 to 700 m³/h in two versions: KWL Yoga and KWL Yoga Style.



134ff

■ Selection matrix

90ff

■ Enthalpy heat exchangers

99ff

■ easyControls 3.0

100ff

Central ventilation units

■ Wall installation, wall mounting "W"

Series "W"
Compact wall units from 170 to 500 m³/h. KWL 170 W, 360 W with passive house certificates. All models come with easyControls 3.0 as standard and enthalpy heat exchangers as an option.



104ff

■ Ceiling installation "D"

Series "D"
Ultra-flat units from 220 to 2000 m³/h for space-saving ceiling installation. Units come with high-efficiency heat exchangers, EC technology and passive house certificates. KWL EC 220, 340 D come with easyControls 3.0 as standard.



116ff

■ Floor-standing installation "S"

Series "S"
With air flow rates from 800 to 2600 m³/h, for standing floor installation. Ideal as central units in residential, commercial and industrial applications. Units come with high-efficiency heat exchangers, EC technology and passive house certificates.









126ff

■ Peripherals

Ideally matched additional equipment, such as ground heat exchangers and the active humidifying unit HygroBox for the functional expansion of the entire KWL system.

Innovative air distribution systems for all installation types and areas of application. Design ventilation valves, etc.

144ff

Type	Installation			Decentralised / Central	Typical areas of application					Maximum energy efficiency class*	Moisture recovery	With passive house certificate
	Wall mounting / wall	Ceiling	Floor		Living room	Single family house	Apartment building – apartment central	Apartment building – building central	Commercial / municipal buildings			
	KWL EC 45-160	■		D	■	■	■			A+		
	KWL EC 60	■		D	■	■	■			A		
  	KWL 170 W	■		Z		■	■			A+		■
	KWL 170 W ET	■		Z		■	■			A	■	■
	KWL 200 W	■		Z		■	■			A		
	KWL 200 W ET	■		Z		■	■			A	■	
	KWL 250 W	■		Z		■	■			A+		
	KWL 250 W ET	■		Z		■	■			A	■	
	KWL 300 W	■		Z		■	■			A		
	KWL 300 W ET	■		Z		■	■			A	■	
	KWL 360 W	■		Z		■	■			A+		■
	KWL 360 W ET	■		Z		■	■			A	■	■
	KWL 500 W	■		Z		■	■		■	A		
	KWL 500 W ET	■		Z		■	■		■	A	■	
	KWL 220 D		■	Z		■	■			A+		■
	KWL 340 D		■	Z		■	■			A+		
	KWL EC 700 D		■	Z				■	■			■
	KWL EC 1400 D		■	Z				■	■			■
	KWL EC 2000 D		■	Z				■	■			■
	KWL EC 800 S			■	Z			■	■			■
	KWL EC 1200 S			■	Z			■	■			■
	KWL EC 1800 S			■	Z			■	■			■
	KWL EC 2600 S			■	Z			■	■			■
	KWL YOGA 400		■	D					■			
	KWL YOGA Style 400		■	D					■			
	KWL YOGA 700		■	D					■			
	KWL YOGA Style 700		■	D					■			
	KWL YOGA 1000		■	D					■			
	KWL YOGA Style 1000		■	D					■			
	flexipe^{plus}					■	■	■				
	IsoPipe					■	■					
	renopipe						■					
	Flat duct					■						
	KWL HygroBox					■	■					
	Ground heat exchanger					■	■					

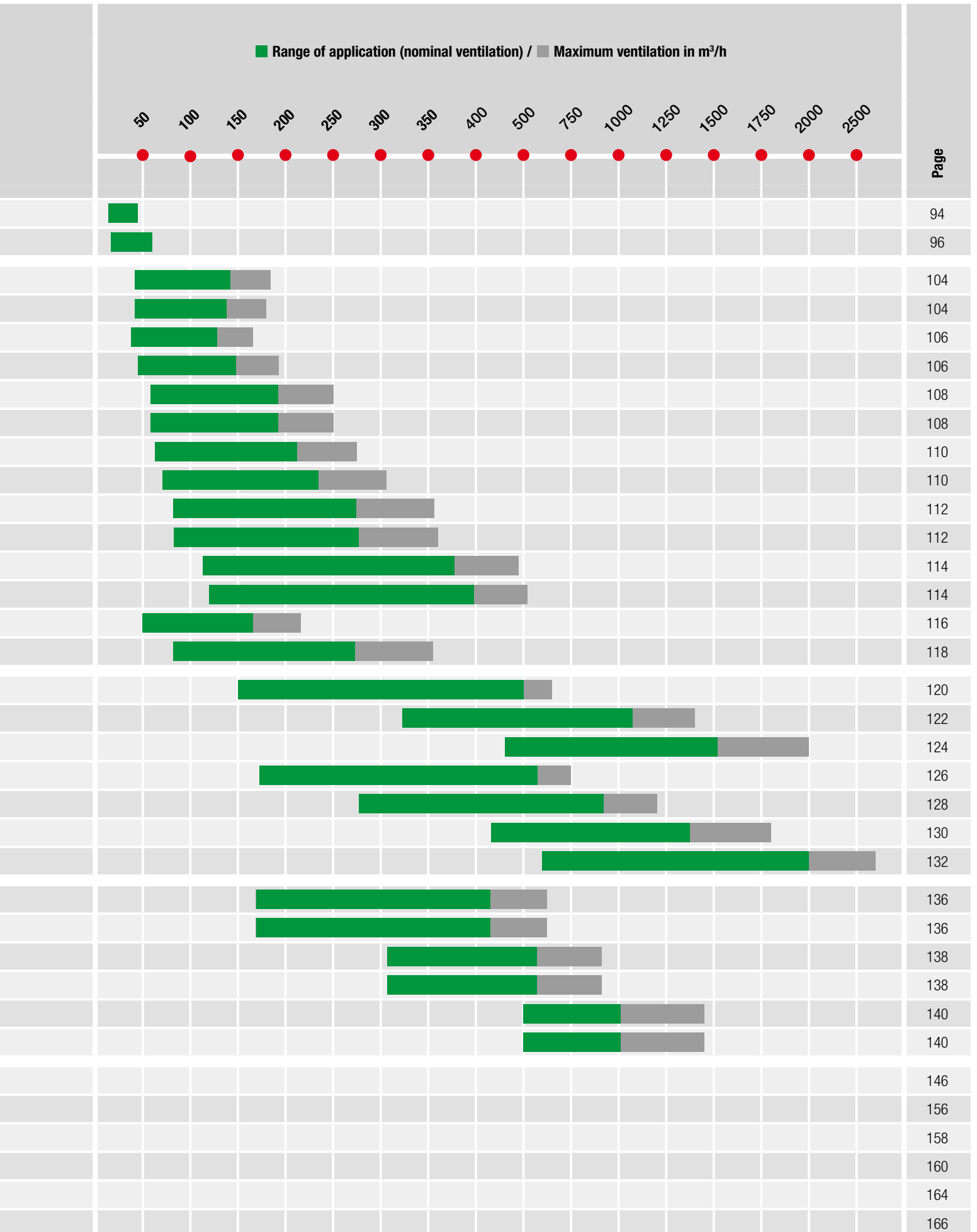

Decentralised domestic ventilation **with heat recovery.**



Controlled domestic ventilation with heat recovery (KWL) fully ensures ventilation pursuant to DIN 1946-6 and thus guarantees that not only the indoor environment, but also the energy balance sheet benefit from the ventilation technology measures.

In this respect, a decentralised ventilation system with heat recovery offers major advantages, especially in renovation, as it is an economical and simple solution for single rooms.

The focus is on two main points:

On the one hand, high efficiency is a prerequisite for the economical operation of the units and, on the other hand, the individual ventilation units must form a complete system in perfect coordination with each other.

The decentralised ventilation units with heat recovery from Helios are among the best in their class in both categories.

Thanks to the quick and simple installation, they provide an economical solution for the supply and extract ventilation of single rooms. Residents can sit back, relax and take a deep breath of fresh air!



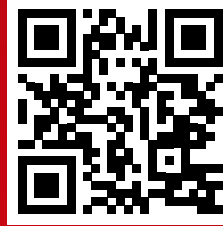

▶ PLAY

Learn about the many possibilities offered by EcoVent Verso KWL EC 45-160 now on our YouTube channel.

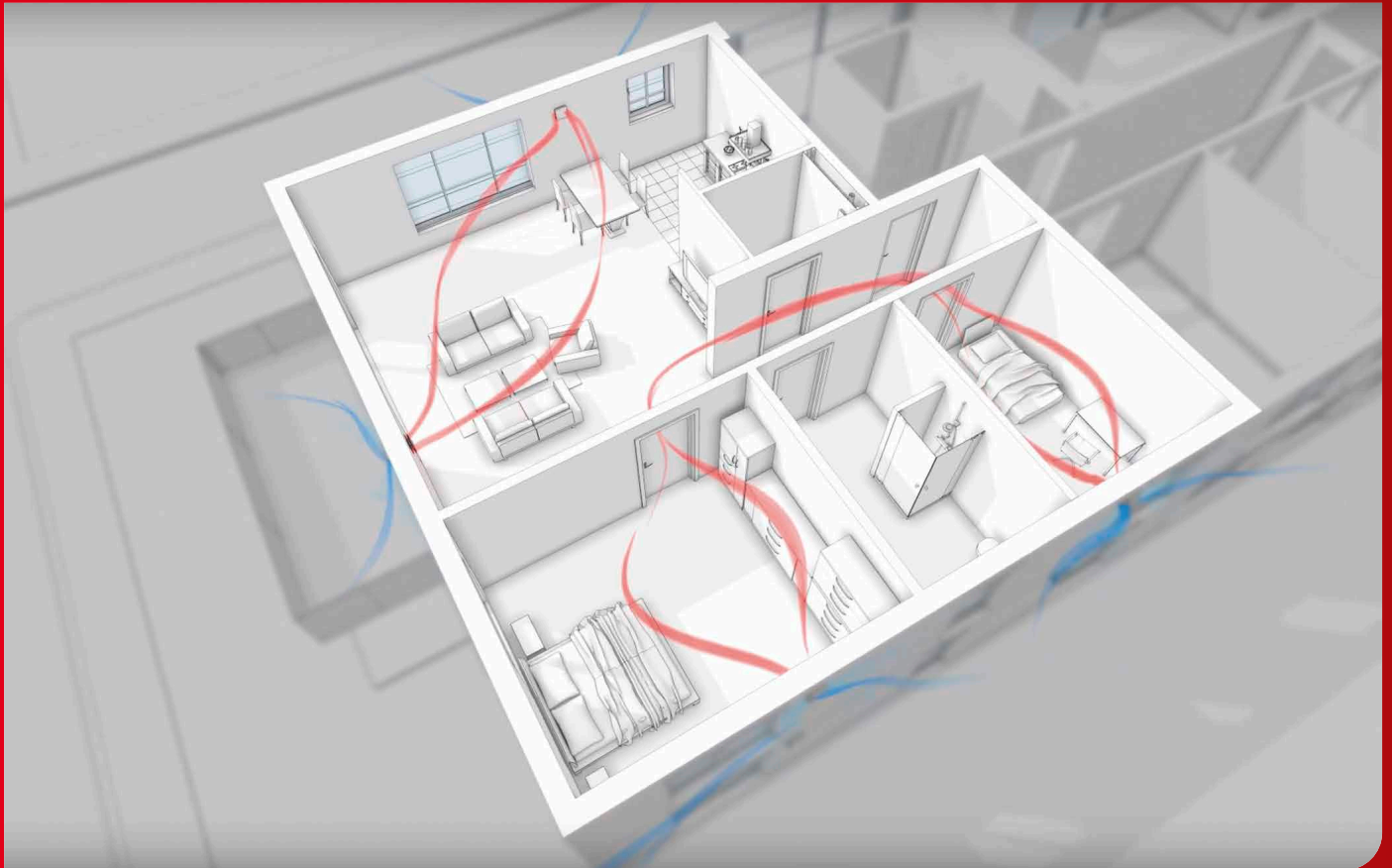

■ **EcoVent Verso
KWL EC 45-160**

With a ceramic heat exchanger, flow straightener and EC fan.
For flush wall mounting in single rooms, ideal if space is limited.



94^f

■ **EcoVent
KWL EC 60**

With a large-scale aluminium plate heat exchanger and two EC fans.
For flush wall mounting in single rooms - the optimal renovation solution.



96^f

■ **Selection matrix**

90^f

KWL EC 45-160



Efficiency class

- A+** KWL EC 45-160 with additional room sensor
- A** KWL EC 45-160



KWL EC 45-160 belongs to the category of switching ventilation units with heat recovery.

DIBt-approved (general technical approval), Z-51.3-417. It is intended for installation in the external building wall. The passage of air is from the outside of the wall through a stainless steel panel. A closable plastic panel on the inner side of the wall, which has integrated sound insulation and a fibre fleece air filter (class ISO Coarse 50% (G3)), is used for this purpose. The KWL EC 45-160 has an EC axial fan which operates in reversing cycles. In this respect, the supply air phases, where the intake air flows into the building, continuously alternate with the extract air phases, which are characterised by the extraction of indoor air from the building.

The heat recovery is regenerative using a ceramic heat exchanger. During extract air operation, this absorbs heat from the indoor air (storage charge) to transfer it to the incoming intake air (storage discharge) in the subsequent supply air cycle. Heat recovery efficiency up to 88% (according to current DIBt test procedure). There is an insect screen on the outside of the ceramic heat exchanger in order to protect against course dirt. In order to maintain balanced ventilation operation, at least 2 units are required for a residential unit, which operate out of phase in terms of operating phases (supply air/extract air). Depending on the total air requirement of the residential unit, more than 2 units are normally installed, whose individual volume flows are automatically coordinated using the central control unit.

Highlights KWL EC 45-160

- Economical, quiet EC axial fan.
- Elegant and timeless design.
- Tool-free, simple installation and dismantling of components.
- Integrated sound insulation.
- Integrated ISO Coarse 50% (G3) air filter, easily accessible and changeable without tools.
- Simple, intuitive operation via two keys.
- LED display for operating mode and current ventilation level.
- Up to 8 controllable units.
- 5 ventilation levels: 14, 24, 32, 37, 45 m³/h.
- 4 operating modes: Heat recovery (= reversing operation), cross ventilation and supply air/extract air mode.
- Possibility of external activation from standby, cross ventilation, supply air mode or party mode (maximum ventilation level) by evaluating an external, potential-free contact.
- Intelligent integration of e.g. demand-controlled extract air fans via an extension module (accessories).
- Filter change indicator.
- Programming via PC.

Control

The central control unit with control element enables the controlling of up to 8 units. 5 ventilation levels and 4 operating modes can be set on the control element: Heat recovery (= reversing operation), cross ventilation and supply air/extract air mode. The user is reminded to replace the filter by flashing LEDs on the control element after a preset time period.

Dimensions KWL EC 45-160

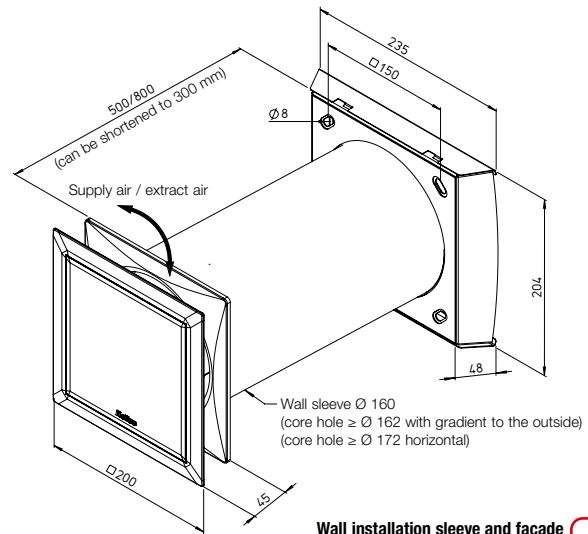

Dimensions in mm

Wall installation sleeve and facade panel essential for unit installation.

GUI user interface

- It is possible to connect the control element to a PC or laptop via the USB interface with Helios software. This makes it easy and convenient to access the control settings.
- Thus, the commissioning and entry of required values (e.g. filter replacement interval or minimum ventilation level) within a very short time. All specified setting options can be changed quickly via the programme interface with the user-friendly assistance of appropriate help texts.
- The configuration settings can be stored directly on the PC or laptop and reloaded into the control system, if required. The installation costs in a larger building can be reduced to a minimum. If several identical ventilation

systems are installed, the required configuration is carried out once for a ventilation system and it can then be transferred to any number of control elements. Controller and software can be secured with a PIN.

Replacement air filter

– 2 pcs. ISO Coarse 50% (G3) ELF-KWL 45-160/3/3 No. 09366

Sound insulation element

Sound insulation element for use in the soffit channel, fire protection class B1. KWL 45 SEL No. 04170

Sound insulation element for use in the wall sleeve, fire protection class B1. KWL 45-160 SE No. 09362

Technical data

Unit ¹⁾	KWL EC 45-160 ¹⁾					Ref. no. 09361
Flow rate at level	5	4	3	2	1	
supply air/extract air \dot{V} m ³ /h	45	37	32	24	14	
Sound pressure L _{PA} dB(A) at 3 m	34	29	27	21	14	
Sound power L _{WA}	52	47	45	39	32	
Standard sound level diff. D _{n,e,w} dB ²⁾	Facade panel 44 / Soffit					
Power consumption W	4.5	3.4	2.8	2.1	1.6	
Heat recovery efficiency ³⁾	up to 88 %					
Operating voltage mains adapter	Input 230 V~, 50/60 Hz / Output 12 V=					
Rated current mA	42	32	27	21	17	
El. supply line mains adapter ⁴⁾	NYM-0 2 x 1.5 mm ²					
El. supply line power supply control ⁴⁾	NYM-0 2 x 1.5 mm ²					
El. supply line to fan ⁵⁾	J-Y (ST) Y 3 x 0.8 mm					
Protection class III, protection cat.	IP20					
Wiring diagram no.	1091 / 1093					
Temperature operating range	– 12 °C to + 40 °C					
Weight (unit+inner panel) approx. kg	2.8					

¹⁾ The required wall installation sleeve and facade panel must be ordered separately.

²⁾ Test value.

³⁾ According to latest DIBt test procedure. ⁴⁾ Use of NYM-J 3 x 1.5 mm² is permitted.

⁵⁾ Use of J-Y (ST) Y 2 x 2 x 0.8 mm is permitted.

■ **Unit with inner panel**

KWL 45-160 No. 09361
Consists of design inner panel with filter, ceramic heat exchanger, flow straightener, insect screen, EC axial fan with protection grille, removal tool (cord) and EPP half shell base.



■ **Installation package soffit***

KWL 45-160 LE-RP No. 08160
With wall sleeve and plaster protective cover.
Made of EPP, fire protection class B1.

■ **Wall installation sleeve**

Length 500 mm
KWL 45-160 WH No. 09319

Length 800 mm
KWL 45-160 WH-L No. 09320
Ø 160 mm, plastic, incl. condensate wedge and 2 covers.



■ **Soffit grille**

Made of stainless steel
KWL 45 LG No. 04167
External grille with integrated condensate drain and seal.
Dim. mm (H x W) 324 x 74

With additional coating
KWL 45 LG-B No. 04168
For use in environments with severe air pollution or high salt concentration in the air (near the coast).

With white coating
KWL 45 LG-W No. 04169

■ **Facade panel**

Made of stainless steel
KWL 45-160 FB-E No. 09321

With additional coating
KWL 45-160 FB-B No. 09322
For use in environments with severe air pollution or high salt concentration in the air (near the coast).

With white coating
KWL 45-160 FB-W No. 09323



■ **Insect screen**
KWL 45 ISL No. 03004
Made of stainless steel.

For installation package soffit (KWL 45-160 LE-RP). Suitable for retrofitting.
Dim. mm (H x W) 203 x 48

■ **Facade panel DEEP**

Made of stainless steel
KWL 45-160 FBT-E No. 09324
For installation in external wall thicknesses from 250 – 300 mm.

With additional coating
KWL 45-160 FBT-B No. 09326
For use in environments with severe air pollution or high salt concentration in the air (near the coast).

With white coating
KWL 45-160 FBT-W No. 09340

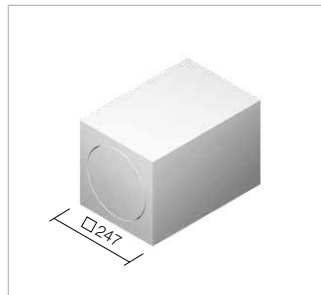

■ **Wall stone**
Length 365 mm
KWL 45-160 WS No. 09302

Length 490 mm
KWL 45-160 WS-L No. 09306
Installation aid for brickwork.
Made of EPS, fire protection class B1.
Replaces the otherwise necessary core hole drilling.

■ **Control set UP**

KWL 45 STS-UP No. 03006
Consists of control element KWL 45 BEU and switching power supply KWL 45 SNU for installation in flush-mounted box. Allows the connection of up to 6 units. In case of more than 6 units, an additional KWL 45 SNU is required. Max. 8 units per control element.



■ **Switching power supply UP**
KWL 45 SNU No. 03008

For extending the control set KWL 45 STS-UP from 6 to 8 units.
Input 230 V AC, 50/60 Hz. output 12 V DC / 1.9 A for flush-mounted installation in insulated wall.
Output voltage according to SELV protection class 3.

■ **Casing for surface installation**
KWL-APG No. 04270

■ **Extension module**
KWL 45 EM No. 03012
For the combined operation of an extract air system, e.g. according to DIN 18017, pt. 3 with KWL EC 45-160 (combined ventilation).

■ **Reference**

A flush-mounted box (depth 61 mm) is required for the control element KWL 45 BEU and for each installed switching power supply KWL 45 SNU.

Control element (w/o adapter)
KWL 45 BEU No. 03041

■ **Control set HS**

KWL 45 STS-HS No. 03007
Consists of control element KWL 45 BEU and switching power supply KWL 45 SNH for top-hat rail (2 pcs). Allows the connection of up to 4 units. In case of more than 4 units, an additional KWL 45 SNH is required. Max. 8 units per control element.

■ **Switching power supply HS**
KWL 45 SNH No. 03001

For extending the control set KWL 45 STS-HS from 4 to 8 units.
Input 230 V AC, 50/60 Hz. Output 12 V DC / 1.5 A for installation in distribution box (2 pcs). Output voltage according to SELV protection class 3.

■ **Room sensor**
HY 3 No. 01359

With internal scale
HY 3 SI No. 01360
Electromechanical humidity controller for connection to the external contact of the control element. For surface installation. Function type can be adjusted using Helios software or control element.
Attention: Parallel use with KWL-EM is not possible.

* The element must always be overinsulated. It is not suitable for insulation thicknesses ≤ 10 cm and must not be installed in this case.

KWL EC 60



Efficiency class

- A** KWL EC 60 Pro with additional room sensor
- B** KWL EC 60 Pro FF
- KWL EC 60 Eco / Pro



Installation example KWL EC 60

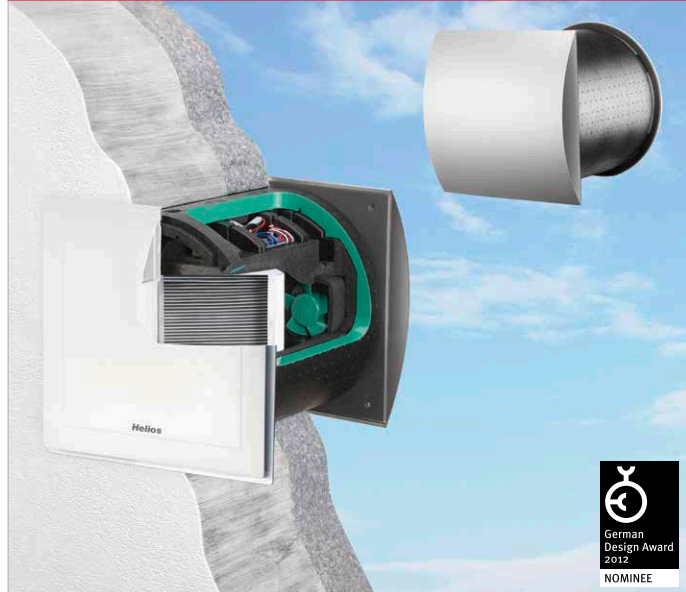

Compact wall installation unit with heat recovery for the supply and extract ventilation of individual rooms. KWL EC 60 is a convincing solution for a comfortable indoor climate and energy savings in individual rooms. Ideal for bringing existing building structures up to the legally required EnEV standard during renovation. KWL EC 60 ventilates small and large individual rooms. The installation of multiple units is recommended for a medium-sized residential unit.

Ideal for renovation due to simple installation

KWL EC 60 is the optimal renovation solution, even for retrofitted installations. The intake air connection is simply through a core hole in the external wall, in which the wall sleeve is inserted.

This simply takes place during the facade renovation. The openings are closed by two building protection covers. The elegant stainless steel outer facade is installed upon completion of plastering. The desired unit is inserted into the wall sleeve and electrically connected in the course of the interior work. Only the elegant facade can be seen on the room side, the front of which is completely closed. Thus, the KWL EC 60 blends discreetly into any room environment and bothersome dirt deposits on ventilation grilles are a thing of the past.

Aluminium plate heat exchanger with a heat recovery efficiency of over 70 %

The KWL EC 60 saves expensive heating energy due to the efficient and large-dimensioned aluminium plate heat exchanger with a heat recovery efficiency of over 70 %.

ECgreenVent by Helios

Particularly energy-saving ventilation units with EC technology, such as Helios KWL EC 60, are marked with the ECgreenVent label. KWL EC 60 allows the demand-dependent supply and extract ventilation of individual rooms with heat recovery; multiple units can be independently controlled. Adjustment is not necessary.

Functionality of the KWL EC 60 ventilation with heat recovery

Two highly efficient direct current EC fans ensure a uniform air exchange. Contaminants, odours and the stale room air is moved outside, and fresh, preheated air is supplied to the room.

The heat is transferred from the stale extract air to the fresh supply air in the large aluminium plate heat exchanger, whereby both airflows remain separate.

Delivery / scope of order

Designed for the installation steps, the following elements can be ordered separately:

- Installation kit**
KWL 60 RS No. 00708
KWL 60 RS-B No. 01961
Consists of wall sleeve (349 mm long), two building protection covers, outer facade and deflector plate made of stainless steel (type RS-B with additional coating*).
- Unit optionally available in Eco or Pro version.**

* The external components, such as facade panel, spacer frames and protection grille, are made of high-quality stainless steel. Alternatively available in coated version (types -B) for use in environments with severe air pollution or high salt concentration in the air (near the coast).

Common features Eco and Pro

- Heat exchanger**
 Large aluminium plate heat exchanger with a heat recovery efficiency of over 70 %.
- Air delivery**
Two highly efficient direct current EC fans ensure a uniform air exchange.
- Condensate drain**
Condensate is drained outside directly via the deflector plate on the external cover.

Air filters

- Two efficient air filters (class ISO coarse 60% (G4)) in the supply air and extract airflow guarantee the best air purity. An ISO ePM_{2.5} 65% (F7) pollen filter on the supply air side is optional.

ECO

KWL EC 60 Eco
The economical solution with a favourable price / performance ratio for all applications.

Unit Eco

KWL EC 60 Eco No. 09950
Consists of inner facade made of high-quality plastic with an integrated, three-step control element.

Power control

Three-step operation via the control element integrated in the inner facade (can be placed at the top or bottom by rotating the facade 180°).
0 position via on-site off-switch.

Electrical connection

Via screwless terminals.

Technical Data

Unit ¹⁾	KWL EC 60 Eco ¹⁾			Ref. no. 09950
	③	②	①	
Flow rate at level ²⁾				
supply air/extract air \dot{V} m ³ /h	60	30	17	
Noise dB(A)				
radiation L _{PA} at 3 m	30	22	18	
Power consumption Fans 2xW	4	2	1	
Standard sound level diff. D _{n,e,w} dB	39 – 41			
Voltage/Frequency	230 V~, 50 Hz			
Rated current A	0.05			
Protection category IP	X4			
Electrical supply line	NYM-J 3 x 1.5 mm ²			
Wiring diagram no.	949			
Temperature operating range	– 20 °C to + 40 °C			
Weight approx. kg	6.5			

¹⁾ The required installation kit (types KWL 60 RS) must be ordered separately (see above for details).

²⁾ Volume reduction of approx. 10 % when using pollen filters.

Dimensions EcoVent KWL EC 60

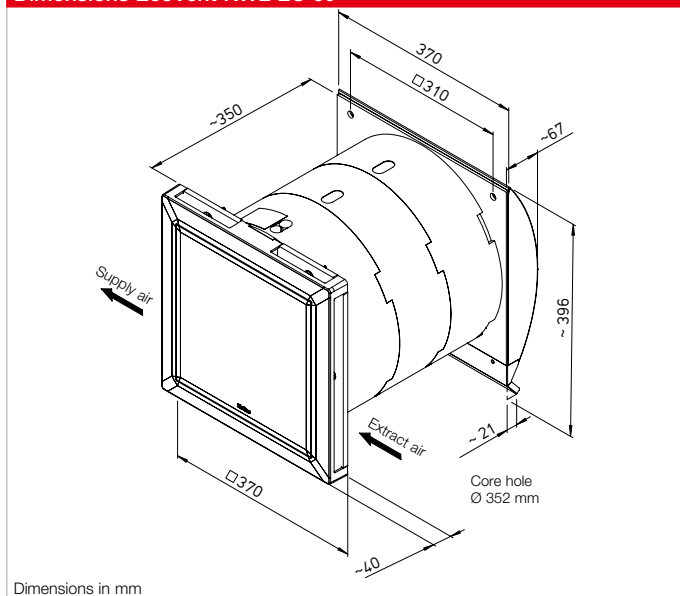

Dimensions in mm

PRO

KWL EC 60 Pro / Pro FF
Meets even the highest comfort requirements with many useful functions.

Unit Pro

KWL EC 60 Pro No. 09951
Consists of inner facade made of high-quality plastic and comfort control element (KWL-BCU, 1 pc. included in delivery). See right for details.

Unit Pro FF

KWL EC 60 Pro FF No. 09957
Like KWL EC 60 Pro, but with additional integrated humidity sensor for demand-dependent ventilation. The humidity values can be adjusted.

Leistungsregelung

The comfort control element with graphic display and user-friendly menu navigation, which is included in the delivery, enables the following functions:

- Four-step manual operation or with digital weekly timer.

- Control via intelligent CO₂ sensors (accessories, connection of up to 4 pcs. possible.)
- Supply air/extract air operation individually switchable.
- Party mode, intensive ventilation.
- Indication of necessary filter replacement, operating status, operating hours, error messages.
- Multiple units can be controlled via one control element.
- Multiple control elements can be connected to one unit.

Shutters

In case of absence (holiday) or standstill periods, two airtight shutters will close outwards or one airtight shutter will close in case of supply air or extract air operation.

Electrical connection

Via plug-in coupling (included in delivery.)

Technical data

Unit ¹⁾	KWL EC 60 Pro ¹⁾				Ref. no. 09951
– incl. humidity sensor	KWL EC 60 Pro FF ¹⁾				Ref. no. 09957
Flow rate at level²⁾	4	3	2	1	
Supply/extract air V m ³ /h	60	45	30	17	
Noise dB(A)					
Radiation L _{PA} at 3 m	30	29	22	18	
Power consumption Fans 2xW	4	3	2	1	
Standard sound level diff. D _{n,e,w} dB	39 – 41				
Voltage/Frequency	230 V–, 50 Hz				
Rated current A	0.06				
Protection category IP	X4				
Electrical supply line	NYM-J 3 x 1.5 mm ²				
Wiring diagram no.	950				
Temperature operating range	– 20 °C to + 40 °C				
Weight approx. kg	6.5				

¹⁾ The required installation kit (types KWL 60 RS) must be ordered separately (see above for details).

²⁾ Volume reduction of approx. 10% when using pollen filters.

Delivery / scope of order

Designed for the installation steps, the following elements can be ordered separately:

Installation kit

KWL 60 RS No. 00708
KWL 60 RS-B No. 01961
As described on the left.

Unit optionally available in Eco or Pro version.

Common accessories

Wall sleeve extension

KWL 60 WV No. 00884
For wall thicknesses from 349 to 571 mm. Can be optionally shortened or connected, 111 mm long, with separator.

Sound insulation set

KWL 60 SDS No. 03059
Consists of sound insulation frame and matting, white, 100 mm deep. Noise reduction up to 6 dB.

Spacer frame

KWL 60 DR No. 00888
KWL 60 DR-B No. 01962
External stainless steel frame, 100 mm deep, with separator. For wall thicknesses from 249 to 349 mm.

Protection grille

KWL 60 SG No. 09978
KWL 60 SG-B No. 09976
Made of stainless steel (2 pcs.), for side attachment to outer facade.



Installation kit essential for unit installation.

Replacement air filter

– 2 pcs. ISO coarse 60% filter
ELF-KWL 60/4/4 No. 09445
– 2 pcs. ISO ePM_{2.5} 65% filter
ELF-KWL 60/7/7 No. 09446



PRO

Accessories for KWL EC 60 Pro Control element (additional)

KWL-BCU (unterputz) No. 09955
Dim. mm (WxHxD) 80x80x37
Display and function as described on the left. 1 KWL-BCU included in delivery. Connection of up to 4 pcs. possible. Delivery incl. 3 m connection cable.

KWL-BCA (surface) No. 09956
Dim. mm (WxHxD) 83x83x51

Casing for surface installation
KWL-APG No. 04270
Dim. mm (WxHxD) 83x83x41

Room sensor

KWL EC-CO2 No. 09988

For detecting the CO₂ concentration in the room air. Controls the ventilation unit in all 4 levels so that the CO₂ content remains below the respective setpoint. Delivery incl. 3 m connection cable. Up to 4 pcs. can be connected. When using multiple sensors, control according to the highest measured value.
Dim. mm (WxHxD) 95 x 97 x 30

Connection cable

KWL-SL 6/5 (5 m) No. 09980
KWL-SL 6/10 (10 m) No. 09444
KWL-SL 6/20 (20 m) No. 09959
For distances > 3 m, with 2 RJ 12 plugs. For connection between control element and KWL EC 60 Pro or between multiple units.



A required for efficiency class A (KWL EC 60 Pro)

Connection cable branch

KWL-ALA No. 09960

For the connection of additional units or control elements and accessory components (1 pc. always required) which are not included in the delivery.

Central domestic ventilation with heat recovery.



A central KWL system with heat recovery from Helios fully ensures continuous ventilation for humidity protection pursuant to DIN 1946-6, regardless of user behaviour.

The required minimum air exchange is also automatically ensured around the clock.

How it works:

The KWL system heat exchanger continuously absorbs the heat from the stale room air and transfers it to the fresh intake air, which creates a healthy comfortable atmosphere in all rooms as preheated and filtered supply air. The heat recovery and particularly energy-saving EC fan technology reduces heating costs by up to a third.



Pollutants stay outside and contaminated room air is efficiently exchanged in a controlled manner.

Helios KWL added value.
The universal, perfectly matched Helios KWL system

solutions guarantee simple planning, secure installation and maximum efficiency.

Enthalpy heat exchanger – ideal room air humidity, optimal climate.

KWL units with combined heat and humidity recovery by enthalpy exchanger provide for a comfortable, healthy room climate.

The relative room humidity in living areas should lie between 35–60%. If the humidity is too low, mucous membranes will dry out, and

electrostatic charges and dust levels in the air will build up. If the used air with a high absolute moisture content is replaced by fresh but dry air

with a smaller absolute moisture content, the humidity in the room will decrease noticeably.

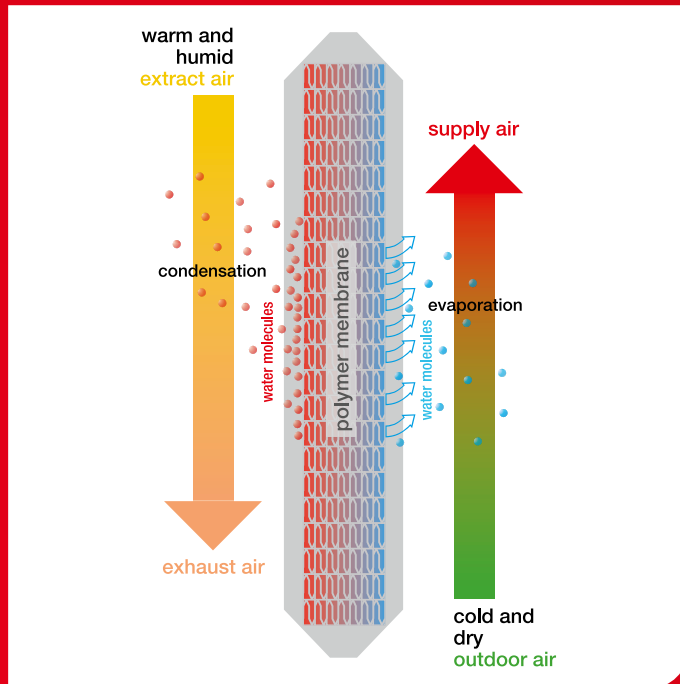

Ventilation units with enthalpy heat exchangers offer convincing advantages:

- Twofold benefit through energy-saving heat recovery and hygienic humidity recovery in the cold season.
- Humidity recovery from the extract air up to 70%, depending on the indoor air humidity.

How the enthalpy heat exchanger works:

The water molecules in the extracted room air condense on contact with the surfaces of the enthalpy heat exchanger.

They move through the membrane in a similar way to water movement in plants (osmosis).

The water molecules are absorbed by the dry outside air on the membrane surface on the supply air side. The coated polymer-membrane on the enthalpy heat exchanger guarantees hygiene and efficiency in the humidity transmission process.

It ensures that the water retains its molecular configuration and does not enter the supply air flow as droplets. The extract and supply air flows are hermetically separated from each other, so that the transfer of organic particles or odours is excluded.

■ Wall installation “W”

Series “W”

Compact wall units up to 500 m³/h.

All models equipped with easyControls 3.0 as standard and optional enthalpy exchanger.



104ff

■ Ceiling installation “D”

Series “D”

Ultra-flat units up to 2000 m³/h for space-saving ceiling installation.

With ultra-efficient heat exchanger, EC technology and passive house certificate: KWL EC 220 D and 340 D with easyControls 3.0 as standard.



116ff

■ Standing installation “S”

Series “S”

With air outputs up to 2600 m³/h, for floor-standing installation.

Ideal as central systems in residential, commercial and industrial applications. With ultra-efficient heat exchanger, EC technology and passive house certificate.



126ff

■ Selection matrix

90f

■ Peripherals

144ff

Smart, intuitive and individual.

Helios KWL[®] with *easy*Controls 3.0



 **OnAIR**

Find out more
on YouTube!

Your needs – our solution:

With Helios easyControls 3.0, you can not only expect a new control generation, but also a new range with optimal flow rate capacity for unlimited applications and maximum energy efficiency.

The **new, intuitive control concept easyControls 3.0** can be easily adapted to the individual needs of residents and it can be manually controlled via the control element, internal web server or from any location via the Cloud as required. It's that simple!

Highlights:

- Smart touch control element in black and white, compatible with almost every switch range.
- Customised ventilation: adjustable weekly programme or fully automatically via room air quality sensors.
- Unit access via PC or Smartphone – also on the move via the new easyControls 3.0 Cloud.

This sets a new standard for a smart, modern control system. Or simply put: Helios easyControls 3.0.

Modern and intuitive: The new touch control element:



The ventilation unit can be adapted to individual paces of life by creating a weekly programme and by selecting from four different ventilation profiles.



The dark mode always ensures the best readability – even at night thanks to its illuminated screen.



The control element can be integrated in common switch ranges and fits perfectly in any living environment.



The status of the selected ventilation profile, temperature and sensor values as well as filter replacement notifications can be viewed at any time.

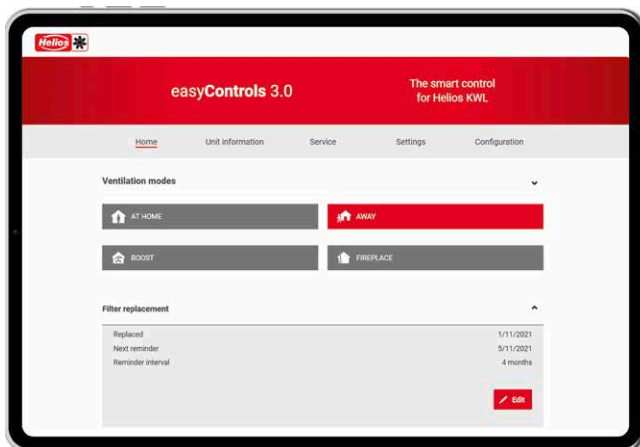

Smart ventilation, simple control system

- Location-independent control of the KWL system via the integrated web server or with the easy-Controls Cloud, as required.
- Individual access rights through selectable profiles.
- Assistant-supported, fast commissioning.
- Practical and cost-effective remote maintenance when servicing.
- Smart integration in the existing building control system (KNX).

Customised ventilation for individual comfort

- The establishment of a personal weekly programme is possible.
- Individual configuration of up to four ventilation programmes.
- Compact overview of current status.

Functional principle

The control system with unlimited possibilities: Helios easyControls 3.0.

Controllable anywhere and at any time, whether at home or on the move.

↓	↓	↓
<p>Building control system</p> <ul style="list-style-type: none"> ■ ModBus interface (integrated) ■ KNX-EIB module (optional) 	<p>Demand-controlled ventilation with sensors</p> <ul style="list-style-type: none"> ■ FTF rel. humidity (1x integrated) ■ CO₂ ■ VOC mixed gas 	<p>Manual control elements</p> <ul style="list-style-type: none"> ■ Modern touch control element ■ Discreet 3-level slide switch



Maximum flexibility in selecting the control elements

If no PC networks are available, or if manual access is preferred, easyControls 3.0 can be controlled via a modern touch control element or a discreet slide switch.

- Touch control element in white or black
- 3-level switch in white



Fully automated ventilation with comfort room sensors in 3 versions

- Relative humidity sensor
- VOC sensor
- CO₂ sensor

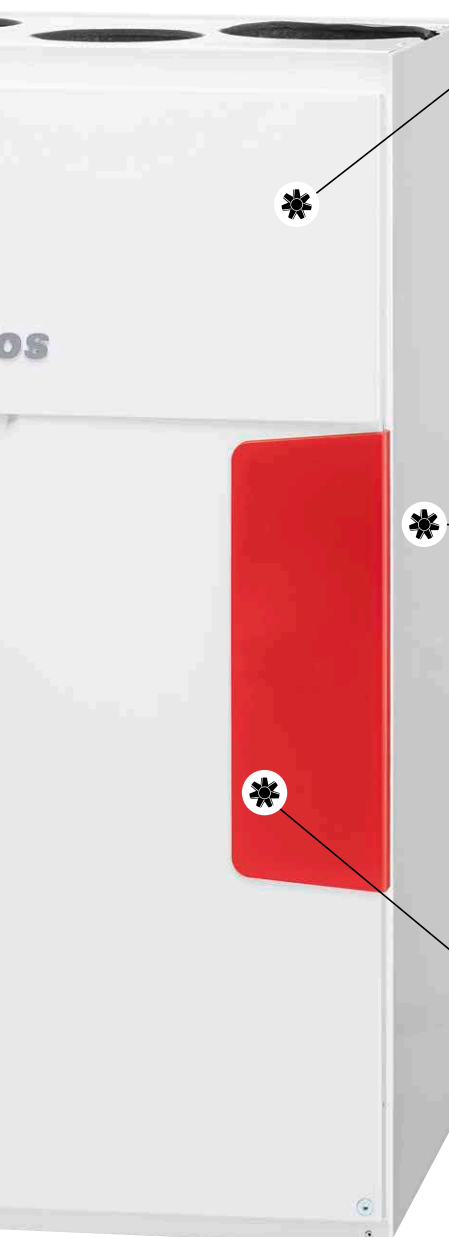

Easy integration in the building control system

The KWL units can be easily integrated in a building control system network via the standard Modbus interface (RTU) or an optional KNX module.

Extension module for further comfort options

To control post-heating (either hot water or electric heating register) for additional supply air heating, e.g. in a passive house.



KWL 170 W



Efficiency class

- A+** KWL 170 W with additional room sensor
- A** KWL 170 W



Dimensions KWL 170 W

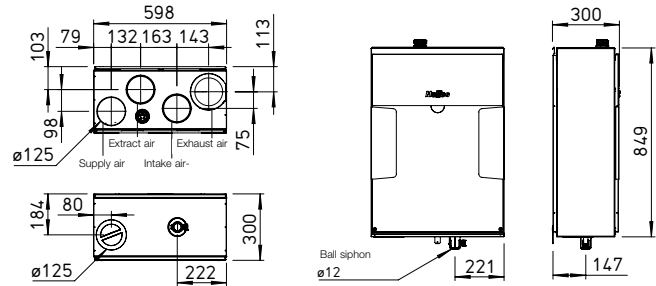

All dimensions in mm



Compact unit with heat recovery for the central supply and extract ventilation of residential units up to 110 m². Perfectly prepared for modern communication and operation with the new Helios easyControls 3.0 control system incl. integrated network connection.

Equipped with EC fans for low energy consumption and highly efficient plastic or enthalpy heat exchangers for additional moisture recovery.

Casing

Universal casing concept: Intake air left/right, supply air top or bottom, suitable for plasterboard installation.

Outside made of galvanised steel sheet in white, internal components made of highly thermal insulating EPP. The intake air connection can be installed on the left or right. Maintenance-friendly access to all unit components through removeable front panels. Delivery state: Intake air on the right.

- Suitable inspection solution for drywall construction upon request.

Heat exchanger

- Large cross counterflow heat exchanger made of plastic, heat recovery efficiency up to 90 %.
- Type "ET" is equipped with highly efficient enthalpy heat exchanger for additional moisture recovery.

Fans

Two low-noise high-performance centrifugal fans with energy-saving EC motors ensure the air supply and extraction.

Ducts

Installation-friendly connection of intake, exhaust, extract and supply air through ducts with NW 125 mm using duct connectors (RVBD 125 K, accessories).

Condensate connection

Condensate drain at the bottom; ball siphon included in delivery. On-site connection to drain pipe.

Air filter

Clean outdoor air supply via ISO Coarse 65 % (G4) filter and 2nd filter stage via optional ISO ePM₁ 50 % (F7) or activated carbon filter. Extract air side equipped with an ISO Coarse 65 % (G4) filter in front of the heat exchanger. Easy filter maintenance without opening the unit.

Summer operation

Equipped with automatic bypass function and heat exchanger cover as standard.

Heat exchanger anti-icing protection

The standard frost monitoring system automatically controls the supply air flow volume and the optionally installed electrical preheater (KWL-EVH 170 W, accessories).

Control system

EasyControls 3.0 is the new, modern control system for all KWL compact units from Helios. The standard LAN interface allows the simple integration of the KWL unit in a network and the integration in Helios Cloud. The unit is optionally controlled via an external control element, on PC/laptop, tablet and Smartphone via the integrated web browser or on the move via the Cloud. See page 100 for functionality. Helios easyControls

3.0 is prepared for:

- The control elements KWL-BE ECO and KWL-BE Touch (optional accessories).
- The humidity sensor integrated as standard and other optionally available external air quality sensors (KWL-CO₂, -FTF, -VOC, accessories) enable automatic, demand-controlled ventilation.
- Connection to building control system via integrated Modbus interface or optional KNX module (KWL-KNX Connect, accessories).
- Electrical connection**
Fixed connection via a mains connection cable 3 x 1.5 mm², approx. 2 m with wire end ferrules.
- Accessories – Functional description (see right for details)**
KWL 170 W can be individually expanded with the following accessories:
 - Control element ECO**
 - Three ventilation profiles selectable via slide switch.
 - Control voltage can be measured directly on the control element.
 - Weekly timer (WSUP / WSUP-S, no. 09990 / 09577, accessories) can also be added to implement a further operating level, e.g. night mode.
 - LED for visual indication of operating statuses, e.g. filter replacement and faults.
 - Control element Touch**
Touch control element with graphic display and user-friendly menu navigation:
 - Commissioning assistant.
 - Selection of four ventilation profiles.
 - Adjustment of an individual weekly programme.

- Adjustment of parameters for room sensors.
- Indication of e.g. filter replacement, operating statuses and error messages.
- Different access authorisations and child lock.
- Other functions (see operating instructions).

KNX/EIB module

For connecting the ventilation unit to the building control system via the KNX Connect module.

Room sensors

Room sensors, which measure the mixed gas, CO₂ concentration or relative room air humidity, are available for automatic operation and optimal air exchange.

Post-heating

Helios easyControls 3.0 can be used with an electric post-heating element (EHR with KWL-LTK, accessories). The autonomous operation of the warm water heating element can be controlled via an air temperature control (WHS HE, accessories) independently from Helios easyControls 3.0.

References	Page
Helios easyControls 3.0 The innovative KWL control concept	100 f.
Moisture recovery through enthalpy heat exchangers	99

Performance curves KWL 170 W

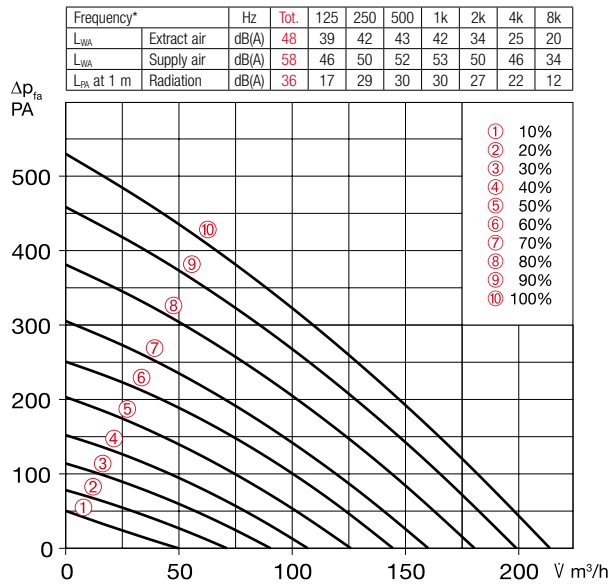

*Sound information relate to Vref. according to ERP data sheet.

Slide switch control element

KWL BE ECO Ref. no. 20246

Three-step slide switch including operation indicator, for flush-mounted installation. Function see left. Dim. mm (W x H x D) 80 x 80 x 37

Casing for surface installation

KWL APG Ref. no. 04270

Dim. mm (W x H x D) 83 x 83 x 41



Touch control element

KWL BE Touch bl

(black) Ref. no. 20244

KWL BE Touch wh

(white) Ref. no. 20245

With graphic display, for flush-mounted installation. Function see left. Connection of up to 6 pcs.

possible (additional power supply unit may be required). Can be integrated in common switch ranges with the dimensions mm (W x H x D) 55 x 55 x 35, Dim. with frame mm (W x H x D) 88 x 88 x 35

Casing for surface installation

KWL APG Touch bl No. 40178

KWL APG Touch wh No. 40177

Dim mm (W x H x D) 85 x 85 x 25



Control line cable

KWL-SL eC 5m Ref. no. 40179

KWL-SL eC 10m Ref. no. 40180

Control line cables in 5 or 10 meters, suitable for KWL-BE ECO / Touch as well as room sensor.

Technical data	With plastic heat exchanger				With enthalpy heat exchanger					
	Type	Ref. no.	Type	Ref. no.	Type	Ref. no.	Type	Ref. no.		
	KWL 170 W	40043	KWL 170 W ET	40044						
Flow rate at level ^{1) 2)}	⑩	⑨	⑥	④	②	⑩	⑨	⑥	④	②
Supply air/extract air V m³/h	214	180	145	107	71	211	179	142	107	69
Power consumption fans 2xW ¹⁾	37	25	15	9	6	37	24	15	9	6
Voltage/Frequency	1~, 230 V, 50 Hz									
Rated current A – ventilation	0.7									
– preheating	4.4									
– max. total	0.7 (5.1 incl. preheater, accessories)									
Electric preheater kW	1.0 kW (accessories)									
Summer bypass	automatic (adjustable), with heat exchanger cover									
Wiring diagram no.	1433									
Temperature operating range	–20 °C to +40 °C									
Installation temperature	+5 °C bis +40 °C (90% rel. humidity, non-condensin)									
Weight approx. kg	36					39				

¹⁾ At 0 Pa, performance levels adjustable. ²⁾ Volume reduction by approx. 10% when using pollen filter.

KNX/EIB module

KWL-KNX Connect No. 20253

For integrating the ventilation unit in a KNX system. For switch cabinet installation (1 space unit required).



Room sensors

KWL-CO2 eC Ref. no. 20248

KWL-FTF eC Ref. no. 20249

KWL-VOC eC Ref. no. 20247

For measuring the CO₂, mixed gas (VOC) concentration or relative room air humidity. Please note the maximum number of sensors, additional power supply unit may be required.

Dim. mm (W x H x D) 98 x 98 x 33



Electric preheater

KWL-EVH 170 W No. 00936

Electrical preheater for simple, plug-in unit installation. For preheating the intake air at very low outdoor temperatures (heat exchanger anti-icing protection). Mandatory for passive houses. Output: 1000 W.



A+ required for efficiency class A+

Extension module

KWL-EM eC Ref. no. 40155

For controlling external post-heating elements.

Dim. mm (WxHxD) 210x210x100



Motion detector

BWM Ref. no. 08323

Motion detector for detecting the presence of persons in the room. Surface-mounted wall installation (cable entry at top or bottom) or installation in flush-mounted box Ø 55 mm (cable entry at back).



Electric post-heating element

For additional supply air heating.

EHR-R 1.2/125 Ref. no. 09433

Rectangular duct temp. sensor

KWL-LTK eC (1 pc. req.) No. 40156

Warm water post-heating element

For additional supply air heating.

WHR 125 Ref. no. 09480

Rectangular duct temp. sensor

KWL-LTK eC (2 pc. req.) No. 40156

Hydraulic unit

WHSR HE 24 V (0-10V) No. 08318

Alternative:

Air temperature control

WHST 300 T38 Ref. no. 08817

■ Circular duct connector
Connector with seal for unit connection to circular duct system with Ø 125 mm.
RVBD 125 K No. 03414

■ Replacement air filters

– 2 pcs. **ISO Coarse 65% (G4)**

ELF-KWL 170/4/4 No. 00951

– 1 pc. **ISO ePM₁, 50% (F7)**

ELF-KWL 170/7 No. 00965

■ Other accessories

Accessory	Page
KWL peripherals	144 ff.
– Ground heat exchanger	166 ff.
– Insulated duct system	156 f.
– Air distribution systems	158 ff.
– Control lines, etc.	162 f.
Heating element, control	478 ff.
ventilation grilles, ducts, roof outlets	553 ff.
extract air elements, design	566 ff.
ventilation valves	566 ff.

■ Reference

Enthalpy heat exchanger

(accessories) for retrofitting:

KWL-ET 170 No. 00976

KWL 200 W



KWL 200 W R with accessories (pollen filter, KWL-EVH 200 W)

Efficiency class

A KWL 200 W R/L and 200 W ET R/L



Dimensions KWL 200 W R

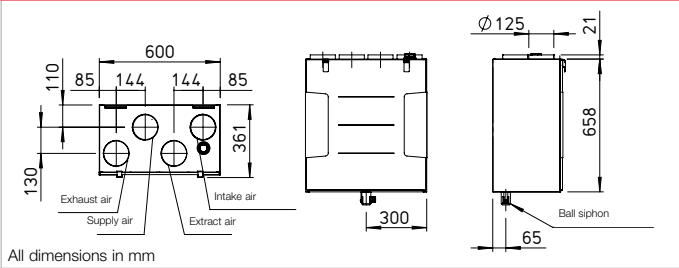

All dimensions in mm

Dimensions KWL 200 W L

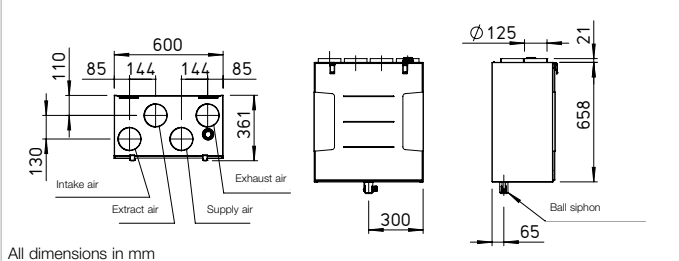

All dimensions in mm

Compact unit with heat recovery for the central supply and extract ventilation of residential buildings and apartments. Perfectly prepared for modern communication and operation with the new Helios easyControls 3.0 control system incl. integrated network connection. Equipped with EC fans for low energy consumption and highly efficient plastic or enthalpy heat exchangers for additional moisture recovery.

■ Casing

Made of galvanised steel sheet, powder-coated in white, double-walled, with 12 mm heat and sound insulation on all sides. Installation-friendly and maintenance-friendly. All elements are easily accessible through removable front panels.

■ Heat exchanger

- Large cross counterflow heat exchanger made of plastic, heat recovery efficiency up to 90 %.
- Types "ET" are equipped with highly efficient enthalpy heat exchanger for additional moisture recovery.

■ Fans

Two low-noise high-performance centrifugal fans with energy-saving EC motors ensure the air supply and extraction.

■ Ducts

Installation-friendly connection of intake, exhaust, extract and supply air through ducts with NW 125 mm using duct connectors (RVBD 125 K, accessories).

■ Condensate connection

Condensate drain at the bottom; ball siphon included in delivery. On-site connection to drain pipe.

■ Air filter

Clean outdoor air supply via ISO Coarse 75 % (G4) filter and 2nd filter stage via optional ISO ePM₁ 50 % (F7) or activated carbon filter. Extract air side equipped with an ISO Coarse 75 % (G4) filter in front of the heat exchanger.

■ Summer operation

Equipped with automatic bypass function and heat exchanger cover as standard.

■ Heat exchanger anti-icing protection

The standard frost monitoring system automatically controls the supply air flow volume and the optionally installed electrical preheater (KWL-EVH 200 W, accessories).

■ Control system

EasyControls 3.0 is the new, modern control system for all KWL compact units from Helios. The standard LAN interface allows the simple integration of the KWL unit in a network and the integration in Helios Cloud. The unit is optionally controlled via an external control element, on PC/laptop, tablet and Smartphone via the integrated web browser or on the move via the Cloud. See page 100 for functionality. Helios easyControls 3.0 is prepared for:

- The control elements KWL-BE ECO and KWL-BE Touch (optional accessories)
- The humidity sensor integrated as standard and other optionally available external air quality sensors (KWL-CO₂, -FTF,

-VOC, accessories) enable automatic, demand-controlled ventilation.

- Connection to building control system via integrated Modbus interface or optional KNX module (KWL-KNX Connect, accessories).

■ Electrical connection

Fixed connection via a mains connection cable 3 x 1.5 mm², approx. 2 m with wire end ferrules.

■ Accessories – Functional description (see right for details)

- Control element ECO**
 - Three ventilation profiles selectable via slide switch.
 - Control voltage can be measured directly on the control element.
 - Weekly timer (WSUP / WSUP-S, no. 09990 / 09577, accessories) can also be added to implement a further operating level, e.g. night mode.
 - LED for visual indication of operating statuses, e.g. filter replacement and faults.

Control element Touch

- Touch control element with graphic display and user-friendly menu navigation:
 - Commissioning assistant.
 - Selection of four ventilation profiles.
 - Adjustment of an individual weekly programme.
 - Adjustment of parameters for room sensors.
 - Indication of e.g. filter replacement, operating statuses and error messages.
 - Different access authorisations and child lock.

– Other functions (see operating instructions).

KNX/EIB module

For connecting the ventilation unit to the building control system via the KNX Connect module.

Room sensors

Room sensors, which measure the mixed gas, CO₂ concentration or relative room air humidity, are available for automatic operation and optimal air exchange.

Post-heating

Helios easyControls 3.0 can be used with an electric post-heating element (EHR with KWL-LTK, accessories). The autonomous operation of the warm water heating element can be controlled via an air temperature control (WHS HE, accessories) independently from Helios easyControls 3.0.

References	Page
Helios easyControls 3.0 The innovative KWL control concept	100 f.
Moisture recovery through enthalpy heat exchangers	99

Performance curves KWL 200 W

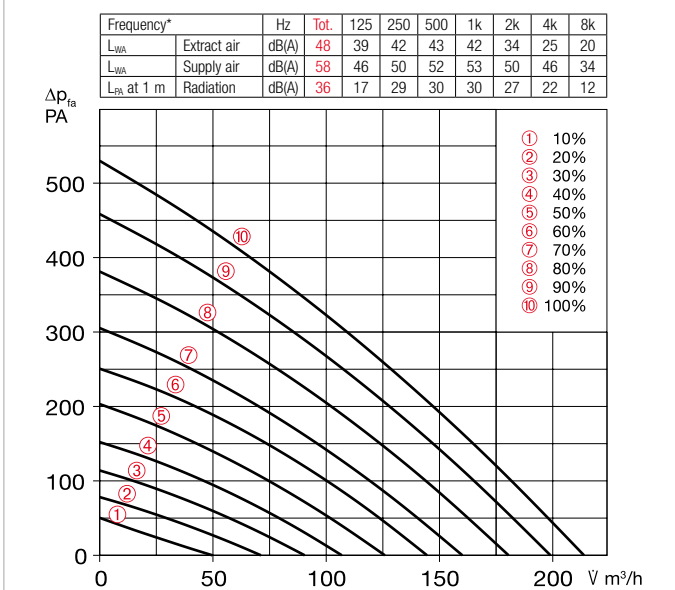

*Sound information relate to Vref. according to ERP data sheet.

Slide switch control element

KWL BE ECO Ref. no. 20246

Three-step slide switch including operation indicator, for flush-mounted installation. Function see left. Dim. mm (W x H x D) 80 x 80 x 37

Casing for surface installation

KWL APG Ref. no. 04270

Dim. mm (W x H x D) 83 x 83 x 41



Touch control element

KWL BE Touch bl

(black) Ref. no. 20244

KWL BE Touch wh

(white) Ref. no. 20245

With graphic display, for flush-mounted installation. Function see left. Connection of up to 6 pcs. possible (additional power supply unit may be required). Can be integrated in common switch ranges with the dim. mm (W x H x D) 55 x 55 x 35, Dim. with frame mm (W x H x D) 88 x 88 x 35

Casing for surface installation

KWL APG Touch bl No. 40178

KWL APG Touch wh No. 40177

Dim mm (W x H x D) 85 x 85 x 25



Control line cable

KWL-SL eC 5m Ref. no. 40179

KWL-SL eC 10m Ref. no. 40180

Control line cables in 5 or 10 meters, suitable for KWL-BE ECO / Touch as well as room sensor.

Technical data	With plastic heat exchanger		With enthalpy heat exchanger	
	Type	Ref. no.	Type	Ref. no.
Right-hand version	KWL 200 W R	40045	KWL 200 W ET R	40047
Left-hand version	KWL 200 W L	40046	KWL 200 W ET L	40048
Flow rate at level ^{1) 2)}				
Supply air/extract air V m ³ /h	215 175 129 71 46		190 151 111 73 39	
Power consumption fans 2xW ⁻¹	40 26 16 8 5		40 26 16 8 5	
Voltage/Frequency	1~, 230 V, 50 Hz			
Rated current A – ventilation	1.2			
– preheating	4.4			
– max. total	1.2 (5.6 incl. preheater, accessories)			
Electric preheater kW	1.0 kW (accessories)			
Summer bypass	automatic (adjustable), with heat exchanger cover			
Wiring diagram no.	1433			
Temperature operating range	–20 °C to +40 °C			
Installation temperature	+5 °C to +40 °C (90% rel. humidity, non-condensing)			
Weight approx. kg	37		41	

¹⁾ At 0 Pa, performance levels adjustable. ²⁾ Volume reduction by approx. 10% when using pollen filter.

³⁾ AK = Activated carbon filter

KNX/EIB module

KWL-KNX Connect No. 20253

For integrating the ventilation unit in a KNX system. For switch cabinet installation (1 space unit required).



Room sensors

KWL-CO2 eC Ref. no. 20248

KWL-FTF eC Ref. no. 20249

KWL-VOC eC Ref. no. 20247

For measuring the CO₂, mixed gas (VOC) concentration or relative room air humidity. Please note the maximum number of sensors, additional power supply unit may be required.



Dim. mm (W x H x D) 98 x 98 x 33

Electric preheater

KWL-EVH 200 W No. 04224

Electrical preheater for simple, plug-in unit installation. For preheating the intake air at very low outdoor temperatures (heat exchanger anti-icing protection). Mandatory for passive houses. Output: 1000 W.



Extension module

KWL-EM eC Ref. no. 40155

For controlling external post-heating elements.

Dim. mm (WxHxD) 210x210x100



Motion detector

BWM Ref. no. 08323

Motion detector for detecting the presence of persons in the room. Surface-mounted wall installation (cable entry at top or bottom) or installation in flush-mounted box Ø 55 mm (cable entry at back).

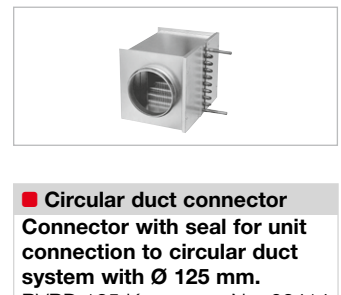

Electric post-heating element

For additional supply air heating.

EHR-R 1.2/125 Ref. no. 09433

Rectangular duct temp. sensor

KWL-LTK eC (1 pc. req.) No. 40156

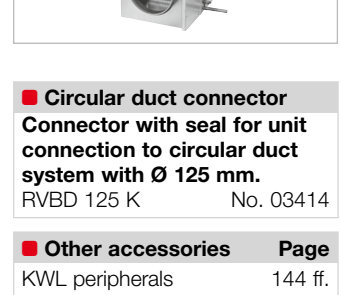

Warm water post-heating element

For additional supply air heating.

WHR 125 Ref. no. 09480

Rectangular duct temp. sensor

KWL-LTK eC (2 pc. req.) No. 40156

Hydraulic unit

WHSH HE 24 V (0-10V) No. 08318

Alternative:

Air temperature control

WHST 300 T38 Ref. no. 08817

■ Circular duct connector	
Connector with seal for unit connection to circular duct system with Ø 125 mm.	
RVBD 125 K	No. 03414
■ Other accessories Page	
KWL peripherals	144 ff.
– Ground heat exchanger	166 ff.
– Insulated duct system	156 f.
– Air distribution systems	158 ff.
– Control lines, etc.	162 f.
Heating element, control	478 ff.
ventilation grilles, ducts, roof outlets	553 ff.
extract air elements, design	
ventilation valves	566 ff.

■ **Replacement air filters**

– 2 pcs. **ISO Coarse 75% (G4)**

ELF-KWL 200/4/4 No. 00021

– 1 pc. **ISO ePM₁ 50% (F7)**

ELF-KWL 200/7 No. 00038

– 1 pc. **ISO ePM_{2.5} 60% (AK)³⁾**

ELF-KWL 200 AK No. 04198

■ **Reference**

Enthalpy heat exchanger

(accessories) for retrofitting:

KWL-ET 200 No. 00896

KWL 250 W



Efficiency class

- A+** KWL 250 W with additional room sensor
- A** KWL 250 W



Dimensions KWL 250 W

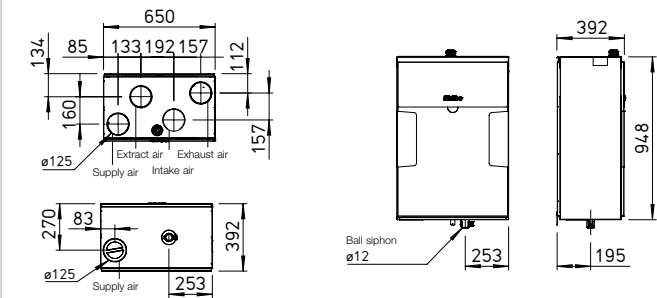

All dimensions in mm

Compact unit with heat recovery for the central supply and extract ventilation of residential units up to 190 m². Perfectly prepared for modern communication and operation with the new Helios easyControls 3.0 control system incl. integrated network connection. Equipped with EC fans for low energy consumption and highly efficient plastic or enthalpy heat exchangers for additional moisture recovery.

Casing

Universal casing concept: Intake air left/right, supply air top or bottom.

Outside made of galvanised steel sheet in white, internal components made of highly thermal insulating EPP. The intake air connection can be installed on the left or right. Maintenance-friendly access to all unit components through removable front panels. Delivery state: Intake air on the right.

Heat exchanger

- Large cross counterflow heat exchanger made of plastic, heat recovery efficiency up to 90 %.
- Type "ET" is equipped with highly efficient enthalpy heat exchanger for additional moisture recovery.

Fans

Two low-noise high-performance centrifugal fans with energy-saving EC motors ensure the air supply and extraction.

Ducts

Installation-friendly connection of intake, exhaust, extract and supply air through ducts with NW 125 mm using duct connectors (RVBD 125 K, accessories).

Condensate connection

Condensate drain at the bottom; ball siphon included in delivery. On-site connection to drain pipe.

Air filter

Clean outdoor air supply via ISO Coarse 65 % (G4) filter and 2nd filter stage via optional ISO ePM₁ 50 % (F7) or activated carbon filter. Extract air side equipped with an ISO Coarse 65 % (G4) filter in front of the heat exchanger. Easy filter maintenance without opening the unit.

Summer operation

Equipped with automatic bypass function and heat exchanger cover as standard.

Heat exchanger anti-icing protection

The standard frost monitoring system automatically controls the supply air flow volume and the optionally installed electrical preheater (KWL-EVH 250 W, accessories).

Control system

EasyControls 3.0 is the new, modern control system for all KWL compact units from Helios. The standard LAN interface allows the simple integration of the KWL unit in a network and the integration in Helios Cloud. The unit is optionally controlled via an external control element, on PC/laptop, tablet and Smartphone via the integrated web browser or on the move via the Cloud. See page 100 for functionality. Helios easyControls 3.0 is prepared for:

- The control elements KWL-BE ECO and KWL-BE Touch (optional accessories)
- The humidity sensor integrated as standard and other optionally available external air quality

sensors (KWL-CO₂, -FTF, -VOC, accessories) enable automatic, demand-controlled ventilation.

- Connection to building control system via integrated Modbus interface or optional KNX module (KWL-KNX Connect, accessories).

Electrical connection

Fixed connection via a mains connection cable 3 x 1.5 mm², approx. 2 m with wire end ferrules.

Accessories – Functional description (see right for details)

- Control element ECO**
 - Three ventilation profiles selectable via slide switch.
 - Control voltage can be measured directly on the control element.
 - Weekly timer (WSUP / WSUP-S, no. 09990 / 09577, accessories) can also be added to implement a further operating level, e.g. night mode.
 - LED for visual indication of operating statuses, e.g. filter replacement and faults.

Control element Touch

- Touch control element with graphic display and user-friendly menu navigation:
 - Commissioning assistant.
 - Selection of four ventilation profiles.
 - Adjustment of an individual weekly programme.
 - Adjustment of parameters for room sensors.
 - Indication of e.g. filter replacement, operating statuses and error messages.
 - Different access authorisations and child lock.

– Other functions (see operating instructions).

KNX/EIB module

For connecting the ventilation unit to the building control system via the KNX Connect module.

Room sensors

Room sensors, which measure the mixed gas, CO₂ concentration or relative room air humidity, are available for automatic operation and optimal air exchange.

Post-heating

Helios easyControls 3.0 can be used with an electric post-heating element (EHR with KWL-LTK, accessories). The autonomous operation of the warm water heating element can be controlled via an air temperature control (WHS HE, accessories) independently from Helios easyControls 3.0.

References	Page
Helios easyControls 3.0 The innovative KWL control concept	100 f.
Moisture recovery through enthalpy heat exchangers	99

Performance curves KWL 250 W

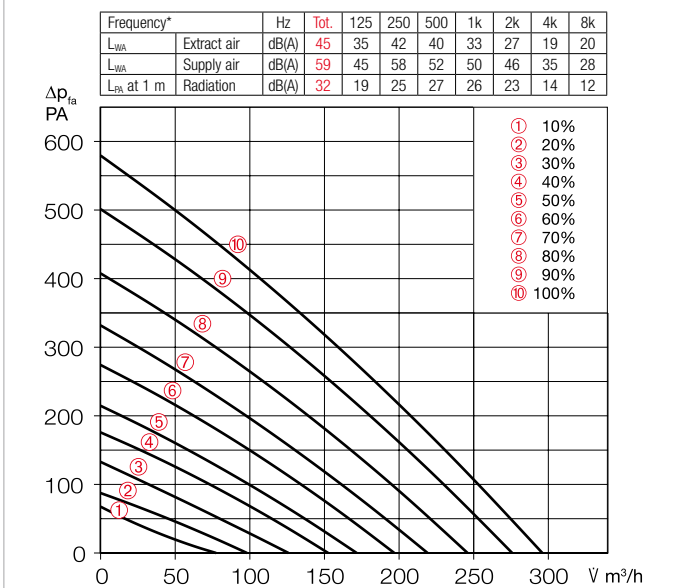

*Sound information relate to Vref. according to ERP data sheet.

Slide switch control element

KWL BE ECO Ref. no. 20246

Three-step slide switch including operation indicator, for flush-mounted installation. Function see left. Dim. mm (W x H x D) 80 x 80 x 37

Casing for surface installation

KWL APG Ref. no. 04270

Dim. mm (W x H x D) 83 x 83 x 41



Touch control element

KWL BE Touch bl

(black) Ref. no. 20244

KWL BE Touch wh

(white) Ref. no. 20245

With graphic display, for flush-mounted installation. Function see left. Connection of up to 6 pcs. possible (additional power supply unit may be required). Can be integrated in common switch ranges with the dimensions mm (W x H x D) 55 x 55 x 35, Dim. with frame mm (W x H x D) 88 x 88 x 35

Casing for surface installation

KWL APG Touch bl No. 40178

KWL APG Touch wh No. 40177

Dim mm (W x H x D) 85 x 85 x 25



Control line cable

KWL-SL eC 5m Ref. no. 40179

KWL-SL eC 10m Ref. no. 40180

Control line cables in 5 or 10 meters, suitable for KWL-BE ECO / Touch as well as room sensor.

Technical data	With plastic heat exchanger					With enthalpy heat exchanger				
	Type	Ref. no.	Type	Ref. no.	Type	Ref. no.	Type	Ref. no.	Type	Ref. no.
	KWL 250 W	40149	KWL 250 W ET	40150						
Flow rate at level 1) 2)	⑩	⑨	⑧	⑦	⑥	⑤	④	③	②	①
Supply air/extract air V m ³ /h	296	246	197	153	98	302	246	197	154	103
Power consumption fans 2xW ¹⁾	51	33	20	13	7	52	32	22	13	8
Voltage/Frequency	1~, 230 V, 50 Hz									
Rated current A – ventilation	1,5									
– preheating	4,4									
– max. total	1,5 (5,9 incl. preheater, accessories)									
Electric preheater kW	1.0 kW (accessories)									
Summer bypass	automatic (adjustable), with heat exchanger cover									
Wiring diagram no.	1433									
Temperature operating range	–20 °C to +40 °C									
Installation temperature	+5 °C to +40 °C (90% rel. humidity, non-condensing)									
Weight approx. kg	43					47				

1) At 0 Pa, performance levels adjustable. 2) Volume reduction by approx. 10% when using pollen filter.

KNX/EIB module

KWL-KNX Connect No. 20253

For integrating the ventilation unit in a KNX system. For switch cabinet installation (1 space unit required).



Room sensors

KWL-CO2 eC Ref. no. 20248

KWL-FTF eC Ref. no. 20249

KWL-VOC eC Ref. no. 20247

For measuring the CO₂, mixed gas (VOC) concentration or relative room air humidity. Please note the maximum number of sensors, additional power supply unit may be required.

Dim. mm (W x H x D) 98 x 98 x 33

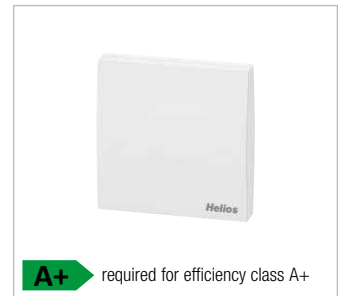

Electric preheater

KWL-EVH 250 W No. 40157

Electrical preheater for simple, plug-in unit installation. For preheating the intake air at very low outdoor temperatures (heat exchanger anti-icing protection). Mandatory for passive houses. Output: 1000 W.



A+ required for efficiency class A+

Extension module

KWL-EM eC Ref. no. 40155

For controlling external post-heating elements.

Dim. mm (WxHxD) 210x210x100



Motion detector

BWM Ref. no. 08323

Motion detector for detecting the presence of persons in the room. Surface-mounted wall installation (cable entry at top or bottom) or installation in flush-mounted box Ø 55 mm (cable entry at back).

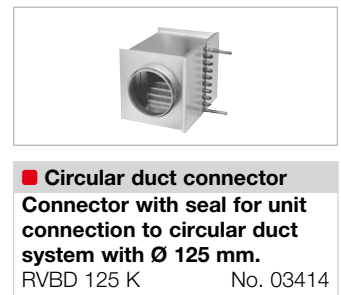

Electric post-heating element

For additional supply air heating.

EHR-R 1.2/125 Ref. no. 09433

Rectangular duct temp. sensor

KWL-LTK eC (1 pc. req.) No. 40156

Warm water post-heating element

For additional supply air heating.

WHR 125 Ref. no. 09480

Rectangular duct temp. sensor

KWL-LTK eC (2 pc. req.) No. 40156

Hydraulic unit

WHSH HE 24 V (0-10V) No. 08318

Alternative:

Air temperature control

WHST 300 T38 Ref. no. 08817

■ Circular duct connector
Connector with seal for unit connection to circular duct system with Ø 125 mm.
RVBD 125 K No. 03414

■ Replacement air filters

– 2 pcs. **ISO Coarse 65% (G4)**

ELF-KWL 250/2xCoarse65%

Ref. no. 40151

– 1 pc. **ISO ePM₁ 50% (F7)**

ELF-KWL 250/ePM1 50%

Ref. no. 40152

– 1 pc. **Activated carbon filter**

ELF-KWL 250 AK No. 40153

■ Reference

Enthalpy heat exchanger

(accessories) for retrofitting:

KWL-ET 250 Nr. 40159

Other accessories	Page
KWL peripherals	144 ff.
– Ground heat exchanger	166 ff.
– Insulated duct system	156 f.
– Air distribution systems	158 ff.
– Control lines, etc.	162 f.
Heating element, control	478 ff.
ventilation grilles, ducts,	
roof outlets	553 ff.
extract air elements, design	
ventilation valves	566 ff.

KWL 300 W



KWL 300 W R with accessories (pollen filter, KWL-EVH 300 W)

Efficiency class

A KWL 300 W R/L and 300 W ET R/L



Dimensions KWL 300 W R

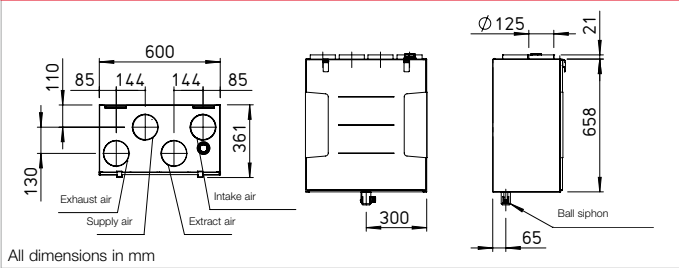

Dimensions KWL 300 W L

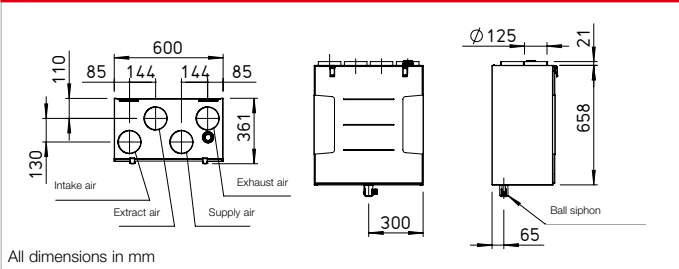

Compact units with heat recovery for the central supply and extract ventilation of residential buildings and apartments. Perfectly prepared for modern communication and operation with the new Helios easyControls 3.0 control system incl. integrated network connection. Equipped with EC fans for low energy consumption and highly efficient plastic or enthalpy heat exchangers for additional moisture recovery.

■ Casing

Made of galvanised steel sheet, powder-coated in white, double-walled, with 12 mm heat and sound insulation on all sides. Installation-friendly and maintenance-friendly. All elements are easily accessible through removable front panels.

■ Heat exchanger

- Large cross counterflow heat exchanger made of plastic, heat recovery efficiency up to 90 %.
- Types "ET" are equipped with highly efficient enthalpy heat exchanger for additional moisture recovery.

■ Fans

Two low-noise high-performance centrifugal fans with energy-saving EC motors ensure the air supply and extraction.

■ Ducts

Installation-friendly connection of intake, exhaust, extract and supply air through ducts with NW 125 mm using duct connectors (RVBD 125 K, accessories).

■ Condensate connection

Condensate drain at the bottom; ball siphon included in delivery. On-site connection to drain pipe.

■ Air filter

Clean outdoor air supply via ISO Coarse 75 % (G4) filter and 2nd filter stage via optional ISO ePM₁ 50 % (F7) or activated carbon filter. Extract air side equipped with an ISO Coarse 75 % (G4) filter in front of the heat exchanger.

■ Summer operation

Equipped with automatic bypass function and heat exchanger cover as standard.

■ Heat exchanger anti-icing protection

The standard frost monitoring system automatically controls the supply air flow volume and the optionally installed electrical preheater (KWL-EVH 300 W, accessories).

■ Control system

EasyControls 3.0 is the new, modern control system for all KWL compact units from Helios. The standard LAN interface allows the simple integration of the KWL unit in a network and the integration in Helios Cloud. The unit is optionally controlled via an external control element, on PC/laptop, tablet and Smartphone via the integrated web browser or on the move via the Cloud. See page 100 for functionality. Helios easyControls 3.0 is prepared for:

- The control elements KWL-BE ECO and KWL-BE Touch (optional accessories)
- The humidity sensor integrated as standard and other optionally available external air quality sensors (KWL-CO₂, -FTF,

-VOC, accessories) enable automatic, demand-controlled ventilation.

- Connection to building control system via integrated Modbus interface or optional KNX module (KWL-KNX Connect, accessories).

■ Electrical connection

Fixed connection via a mains connection cable 3 x 1.5 mm², approx. 2 m with wire end ferrules.

■ Accessories – Functional description (see right for details)

- Control element ECO**
 - Three ventilation profiles selectable via slide switch.
 - Control voltage can be measured directly on the control element.
 - Weekly timer (WSUP / WSUP-S, no. 09990 / 09577, accessories) can also be added to implement a further operating level, e.g. night mode.
 - LED for visual indication of operating statuses, e.g. filter replacement and faults.

Control element Touch

- Touch control element with graphic display and user-friendly menu navigation:
 - Commissioning assistant.
 - Selection of four ventilation profiles.
 - Adjustment of an individual weekly programme.
 - Adjustment of parameters for room sensors.
 - Indication of e.g. filter replacement, operating statuses and error messages.
 - Different access authorisations and child lock.

– Other functions (see operating instructions).

KNX/EIB module

For connecting the ventilation unit to the building control system via the KNX Connect module.

Room sensors

Room sensors, which measure the mixed gas, CO₂ concentration or relative room air humidity, are available for automatic operation and optimal air exchange.

Post-heating

Helios easyControls 3.0 can be used with an electric post-heating element (EHR with KWL-LTK, accessories). The autonomous operation of the warm water heating element can be controlled via an air temperature control (WHS HE, accessories) independently from Helios easyControls 3.0.

References	Page
Helios easyControls 3.0 The innovative KWL control concept	100 f.
Moisture recovery through enthalpy heat exchangers	99

Performance curves KWL 300 W

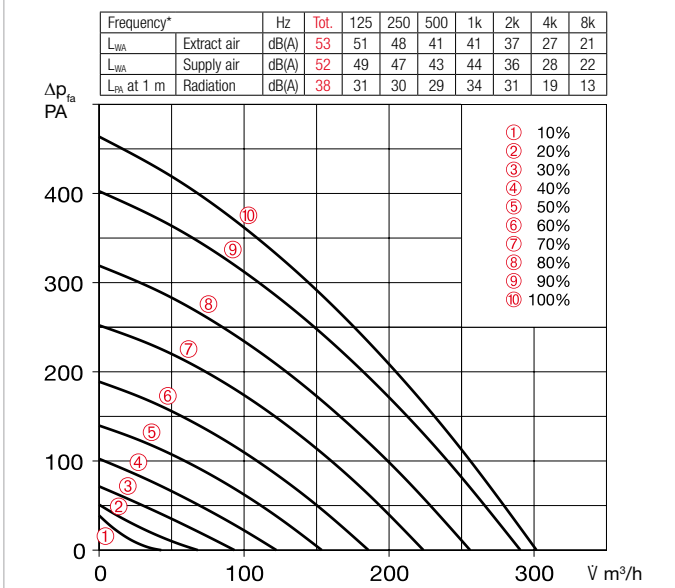

Slide switch control element

KWL BE ECO Ref. no. 20246

Three-step slide switch including operation indicator, for flush-mounted installation. Function see left. Dim. mm (W x H x D) 80 x 80 x 37

Casing for surface installation

KWL APG Ref. no. 04270

Dim. mm (W x H x D) 83 x 83 x 41



Touch control element

KWL BE Touch bl

(black) Ref. no. 20244

KWL BE Touch wh

(white) Ref. no. 20245

With graphic display, for flush-mounted installation. Function see left. Connection of up to 6 pcs. possible (additional power supply unit may be required). Can be integrated in common switch ranges with the dimensions mm (W x H x D) 55 x 55 x 35, Dim. with frame mm (W x H x D) 88 x 88 x 35

Dim. mm (W x H x D) 88 x 88 x 35

Casing for surface installation

KWL APG Touch bl No. 40178

KWL APG Touch wh No. 40177

Dim mm (W x H x D) 85 x 85 x 25



Control line cable

KWL-SL eC 5m Ref. no. 40179

KWL-SL eC 10m Ref. no. 40180

Control line cables in 5 or 10 meters, suitable for KWL-BE ECO / Touch as well as room sensor.

Technical data	With plastic heat exchanger				With enthalpy heat exchanger			
	Type	Ref. no.	Type	Ref. no.	Type	Ref. no.	Type	Ref. no.
Right-hand version	KWL 300 W R	40049	KWL 300 W ET R	40051				
Left-hand version	KWL 300 W L	40050	KWL 300 W ET L	40052				
Flow rate at level ^{1) 2)}	⑩ ⑨ ⑧ ⑦ ⑥ ⑤ ④ ③ ② ①		⑩ ⑨ ⑧ ⑦ ⑥ ⑤ ④ ③ ② ①					
Supply air/extract air V m ³ /h	302 255 186 122 68		271 216 161 107 56					
Power consumption fans 2xW ¹⁾	84 54 27 13 6		86 54 27 13 7					
Voltage/Frequency	1~, 230 V, 50 Hz							
Rated current A – ventilation	2.0							
– preheating	4.4							
– max. total	2.0 (6.4 incl. preheater, accessories)							
Electric preheater kW	1.0 kW (accessories)							
Summer bypass	automatic (adjustable), with heat exchanger cover							
Wiring diagram no.	1433							
Temperature operating range	–20 °C to +40 °C							
Installation temperature	+5 °C to +40 °C (90% rel. humidity, non-condensing)							
Weight approx. kg	37				41			

¹⁾ At 0 Pa, performance levels adjustable. ²⁾ Volume reduction by approx. 10% when using pollen filter.

³⁾ AK = Activated carbon filter

KNX/EIB module

KWL-KNX Connect No. 20253

For integrating the ventilation unit in a KNX system. For switch cabinet installation (1 space unit required).



Room sensors

KWL-CO2 eC Ref. no. 20248

KWL-FTF eC Ref. no. 20249

KWL-VOC eC Ref. no. 20247

For measuring the CO₂, mixed gas (VOC) concentration or relative room air humidity. Please note the maximum number of sensors, additional power supply unit may be required.

Dim. mm (W x H x D) 98 x 98 x 33



Electric preheater

KWL-EVH 300 W No. 04224

Electrical preheater for simple, plug-in unit installation. For preheating the intake air at very low outdoor temperatures (heat exchanger anti-icing protection). Mandatory for passive houses. Output: 1000 W.



Extension module

KWL-EM eC Ref. no. 40155

For controlling external post-heating elements.

Dim. mm (WxHxD) 210x210x100



Motion detector

BWM Ref. no. 08323

Motion detector for detecting the presence of persons in the room. Surface-mounted wall installation (cable entry at top or bottom) or installation in flush-mounted box Ø 55 mm (cable entry at back).

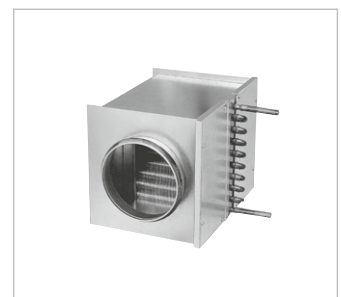

Electric post-heating element

For additional supply air heating.

EHR-R 1.2/125 Ref. no. 09433

Rectangular duct temp. sensor

KWL-LTK eC (1 pc. req.) No. 40156

Warm water post-heating element

For additional supply air heating.

WHR 125 Ref. no. 09480

Rectangular duct temp. sensor

KWL-LTK eC (2 pc. req.) No. 40156

Hydraulic unit

WHSH HE 24 V (0-10V) No. 08318

Alternative:

Air temperature control

WHST 300 T38 Ref. no. 08817

■ **Circular duct connector**
Connector with seal for unit connection to circular duct system with Ø 125 mm.

RVBD 125 K No. 03414

■ **Replacement air filters**

– 2 pcs. **ISO Coarse 75% (G4)**

ELF-KWL 300/4/4 No. 00021

– 1 pc. **ISO ePM₁, 50% (F7)**

ELF-KWL 300/7 No. 00038

– 1 pc. **ISO ePM_{2.5} 60% (AK)³⁾**

ELF-KWL 300 AK No. 04198

■ **Reference**
Enthalpy heat exchanger (accessories) for retrofitting:
KWL-ET 300 No. 00896

KWL 360 W



Efficiency class
A+ KWL 360 W



Dimensions KWL 360 W

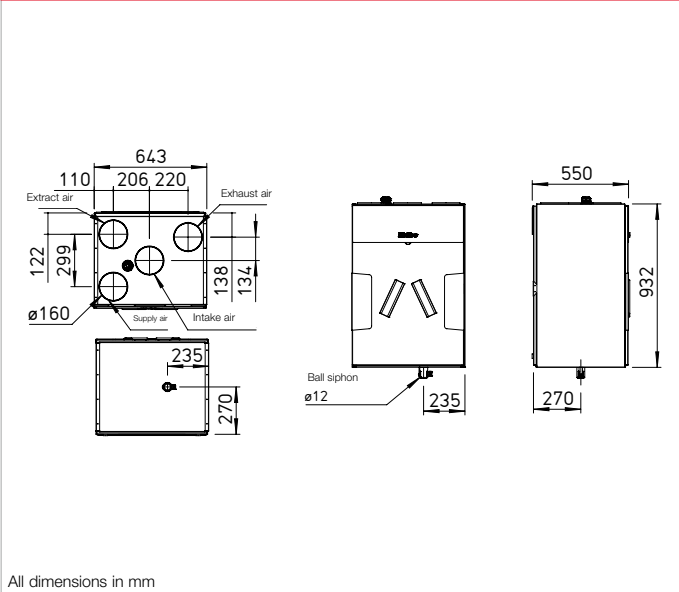

All dimensions in mm



Compact unit with heat recovery for the central supply and extract ventilation of residential buildings and apartments. Perfectly prepared for modern communication and operation with the new Helios easyControls 3.0 control system incl. integrated network connection. Equipped with EC fans for low energy consumption and highly efficient plastic or enthalpy heat exchangers for additional moisture recovery.

■ Casing

Universal casing concept: Intake air and exhaust air side left/right, with integrated sound insulation. Made of galvanised sheet steel with sound and heat insulation, powder-coated in white. The intake air and exhaust air connection can be on the left or right side. Maintenance-friendly access to all unit components through removable front panel. Delivery condition: Intake air and exhaust air side on the right.

■ Heat exchanger

- Large cross counterflow heat exchanger made of plastic, heat recovery efficiency up to 90 %.
- Type "ET" is equipped with highly efficient enthalpy heat exchanger for additional moisture recovery.

■ Fans

Two low-noise high-performance centrifugal fans with energy-saving EC motors ensure the air supply and extraction.

■ Ducts

Installation-friendly connection of intake, exhaust, extract and supply air through ducts with NW 160 mm using duct connectors (RVBD 160 K, accessories).

■ Condensate connection

Condensate drain at the bottom; ball siphon included in delivery. On-site connection to drain pipe.

■ Air filter

Clean outdoor air supply via ISO Coarse 65 % (G4) filter and 2nd filter stage via optional ISO ePM₁ 50 % (F7) or activated carbon filter. Extract air side equipped with an ISO Coarse 65 % (G4) filter in front of the heat exchanger. Easy filter maintenance without opening the unit.

■ Summer operation

Equipped with automatic bypass function and heat exchanger cover as standard.

■ Heat exchanger anti-icing protection

The standard frost monitoring system automatically controls the supply air flow volume and the optionally installed electrical preheater (KWL-EVH 360 W, accessories).

■ Control system

EasyControls 3.0 is the new, modern control system for all KWL compact units from Helios. The standard LAN interface allows the simple integration of the KWL unit in a network and the integration in Helios Cloud. The unit is optionally controlled via an external control element, on PC/laptop, tablet and Smartphone via the integrated web browser or on the move via the Cloud. See page 100 for func-

tionality. Helios easyControls 3.0 is prepared for:

- The control elements KWL-BE ECO and KWL-BE Touch (optional accessories)
- The humidity sensor integrated as standard and other optionally available external air quality sensors (KWL-CO₂, -FTF, -VOC, accessories) enable automatic, demand-controlled ventilation.
- Connection to building control system via integrated Modbus interface or optional KNX module (KWL-KNX Connect, accessories).

■ Electrical connection

Fixed connection via a mains connection cable 3 x 1.5 mm², approx. 2 m with wire end ferrules.

■ Accessories – Functional description (see right for details) KWL EC 360 W can be individually expanded with the following accessories:

- Control element ECO**
 - Three ventilation profiles selectable via slide switch.
 - Control voltage can be measured directly on the control element.
 - Weekly timer (WSUP / WSUP-S, no. 09990 / 09577, accessories) can also be added to implement a further operating level, e.g. night mode.
 - LED for visual indication of operating statuses, e.g. filter replacement and faults.

Control element Touch

- Touch control element with graphic display and user-friendly menu navigation:
 - Commissioning assistant.
 - Selection of four ventilation profiles.

- Adjustment of an individual weekly programme.
- Adjustment of parameters for room sensors.
- Indication of e.g. filter replacement, operating statuses and error messages.
- Different access authorisations and child lock.
- Other functions (see operating instructions).

KNX/EIB module

For connecting the ventilation unit to the building control system via the KNX Connect module.

Room sensors

Room sensors, which measure the mixed gas, CO₂ concentration or relative room air humidity, are available for automatic operation and optimal air exchange.

Post-heating

Helios easyControls 3.0 can be used with an electric post-heating element (EHR with KWL-LTK, accessories). The autonomous operation of the warm water heating element can be controlled via an air temperature control (WHS HE, accessories) independently from Helios easyControls 3.0.

References	Page
Helios easyControls 3.0 The innovative KWL control concept	100 f.
Moisture recovery through enthalpy heat exchangers	99

Performance curves KWL 360 W

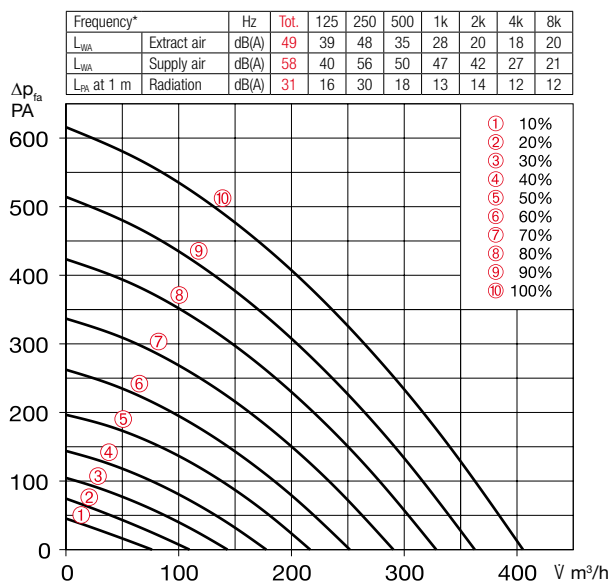

*Sound information relate to Vref. according to ERP data sheet.

Slide switch control element

KWL BE ECO Ref. no. 20246

Three-step slide switch including operation indicator, for flush-mounted installation. Function see left. Dim. mm (W x H x D) 80 x 80 x 37

Casing for surface installation

KWL APG Ref. no. 04270

Dim. mm (W x H x D) 83 x 83 x 41



Touch control element

KWL BE Touch bl

(black) Ref. no. 20244

KWL BE Touch wh

(white) Ref. no. 20245

With graphic display, for flush-mounted installation. Function see left. Connection of up to 6 pcs.

possible (additional power supply unit may be required). Can be integrated in common switch ranges with the dimensions mm (W x H x D) 55 x 55 x 35, Dim. with frame mm (W x H x D) 88 x 88 x 35

Casing for surface installation

KWL APG Touch bl No. 40178

KWL APG Touch wh No. 40177

Dim mm (W x H x D) 85 x 85 x 25



Control line cable

KWL-SL eC 5m Ref. no. 40179

KWL-SL eC 10m Ref. no. 40180

Control line cables in 5 or 10 meters, suitable for KWL-BE ECO / Touch as well as room sensor.

Technical data	With plastic heat exchanger				With enthalpy heat exchanger			
	Type	Ref. no.	Type	Ref. no.	Type	Ref. no.	Type	Ref. no.
	KWL 360 W	40061	KWL 360 W ET	40062				
Flow rate at level 1) 2)	⑩ ⑨ ⑧ ⑦ ⑥ ⑤ ④ ③ ② ①		⑩ ⑨ ⑧ ⑦ ⑥ ⑤ ④ ③ ② ①					
Supply air/extract air V m³/h	405 328 252 178 110		403 332 264 192 121					
Power consumption fans 2xW 1)	51 30 17 10 6		45 28 16 9 5					
Voltage/Frequency	1~, 230 V, 50 Hz							
Rated current A – ventilation	0.5							
– preheating	6.3							
– max. total	0.5 (6.8 incl. preheater, accessories)							
Electric preheater kW	1.5 kW (accessories)							
Summer bypass	automatic (adjustable), with heat exchanger cover							
Wiring diagram no.	1433							
Temperature operating range	–20 °C to +40 °C							
Installation temperature	+5 °C to +40 °C (90% rel. humidity, non-condensing)							
Weight approx. kg	72				70			

1) At 0 Pa, performance levels adjustable. 2) Volume reduction by approx. 10% when using pollen filter.

KNX/EIB module

KWL-KNX Connect No. 20253

For integrating the ventilation unit in a KNX system. For switch cabinet installation (1 space unit required).



Room sensors

KWL-CO2 eC Ref. no. 20248

KWL-FTF eC Ref. no. 20249

KWL-VOC eC Ref. no. 20247

For measuring the CO₂, mixed gas (VOC) concentration or relative room air humidity. Please note the maximum number of sensors, additional power supply unit may be required.

Dim. mm (W x H x D) 98 x 98 x 33

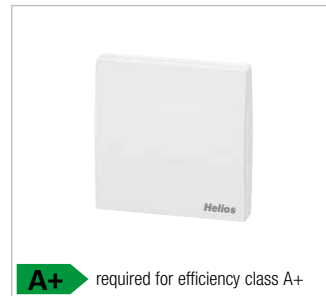

Electric preheater

KWL-EVH 360 W No. 07360

Electrical preheater for simple, plug-in unit installation. For preheating the intake air at very low outdoor temperatures (heat exchanger anti-icing protection). Mandatory for passive houses. Output: 1500 W.



A+ required for efficiency class A+

Extension module

KWL-EM eC Ref. no. 40155

For controlling external post-heating elements.

Dim. mm (WxHxD) 210x210x100



Motion detector

BWM Ref. no. 08323

Motion detector for detecting the presence of persons in the room. Surface-mounted wall installation (cable entry at top or bottom) or installation in flush-mounted box Ø 55 mm (cable entry at back).



Electric post-heating element

For additional supply air heating.

EHR-R 2.4/160 Ref. no. 09435

Rectangular duct temp. sensor

KWL-LTK eC (1 pc. req.) No. 40156



Warm water post-heating element

For additional supply air heating.

WHR 160 Ref. no. 09481

Rectangular duct temp. sensor

KWL-LTK eC (2 pc. req.) No. 40156

Hydraulic unit

WHSH HE 24 V (0-10V)No.08318

Alternative:

Air temperature control

WHST 300 T38 Ref. no. 08817

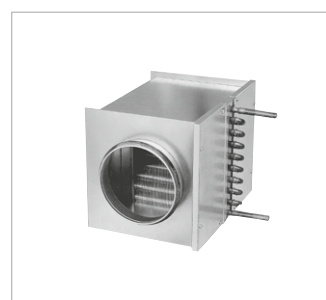

■ Circular duct connector
Connector with seal for unit connection to circular duct system with Ø 160 mm.
RVBD 160 K No. 03415

■ Replacement air filters
– 2 pcs. **ISO Coarse 65% (G4)**
ELF-KWL 360/4/4 No. 07371
– 1 pc. **ISO ePM, 50% (F7)**
ELF-KWL 360/7 No. 07375
– 1 pc. **Activated carbon filter**
ELF-KWL 360 AK No. 08129

■ Reference
Enthalpy heat exchanger (accessories) for retrofitting:
KWL-ET 360 No. 07354

KWL 500 W



KWL 500 W R with accessories (pollen filter, KWL-EVH 500 W)

Efficiency class

A KWL 500 W R/L and 500 W ET R/L



Dimensions KWL 500 W R

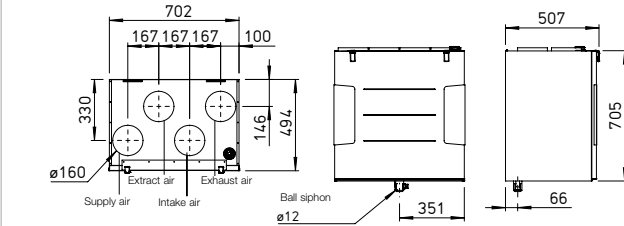

All dimensions in mm

Dimensions KWL 500 W L

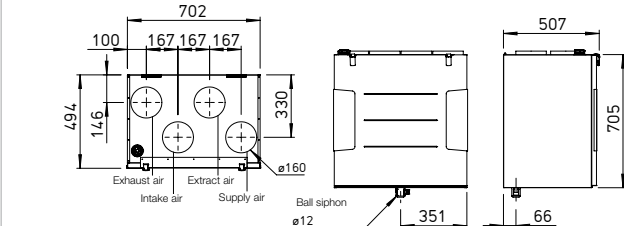

All dimensions in mm

Compact unit with heat recovery for the central supply and extract ventilation of residential buildings and apartments. Perfectly prepared for modern communication and operation with the new Helios easyControls 3.0 control system incl. integrated network connection. Equipped with EC fans for low energy consumption and highly efficient plastic or enthalpy heat exchangers for additional moisture recovery.

■ Casing

Made of galvanised steel sheet, powder-coated in white, double-walled, with 12 mm heat and sound insulation on all sides. Installation-friendly and maintenance-friendly. All elements are easily accessible through removable front panels.

■ Heat exchanger

- Large cross counterflow heat exchanger made of plastic, heat recovery efficiency up to 90 %.
- Types "ET" are equipped with highly efficient enthalpy heat exchanger for additional moisture recovery.

■ Fans

Two low-noise high-performance centrifugal fans with energy-saving EC motors ensure the air supply and extraction.

■ Ducts

Installation-friendly connection of intake, exhaust, extract and supply air through ducts with NW 160 mm using duct connectors (RVBD 160 K, accessories).

■ Condensate connection

Condensate drain at the bottom; ball siphon included in delivery. On-site connection to drain pipe.

■ Air filter

Clean outdoor air supply via ISO Coarse 75 % (G4) filter and 2nd filter stage via optional ISO ePM₁ 50 % (F7) or activated carbon filter. Extract air side equipped with an ISO Coarse 75 % (G4) filter in front of the heat exchanger.

■ Summer operation

Equipped with automatic bypass function and heat exchanger cover as standard.

■ Heat exchanger anti-icing protection

The standard frost monitoring system automatically controls the supply air flow volume and the optionally installed electrical preheater (KWL-EVH 500 W, accessories).

■ Control system

EasyControls 3.0 is the new, modern control system for all KWL compact units from Helios. The standard LAN interface allows the simple integration of the KWL unit in a network and the integration in Helios Cloud. The unit is optionally controlled via an external control element, on PC/laptop, tablet and Smartphone via the integrated web browser or on the move via the Cloud. See page 100 for functionality. Helios easyControls 3.0 is prepared for:

- The control elements KWL-BE ECO and KWL-BE Touch (optional accessories)
- The humidity sensor integrated as standard and other optionally available external air quality sensors (KWL-CO₂, -FTF,

-VOC, accessories) enable automatic, demand-controlled ventilation.

- Connection to building control system via integrated Modbus interface or optional KNX module (KWL-KNX Connect, accessories).

■ Electrical connection

Fixed connection via a mains connection cable 3 x 1.5 mm², approx. 2 m with wire end ferrules.

■ Accessories – Functional description (see right for details)

- Control element ECO**
 - Three ventilation profiles selectable via slide switch.
 - Control voltage can be measured directly on the control element.
 - Weekly timer (WSUP / WSUP-S, no. 09990 / 09577, accessories) can also be added to implement a further operating level, e.g. night mode.
 - LED for visual indication of operating statuses, e.g. filter replacement and faults.

Control element Touch

- Touch control element with graphic display and user-friendly menu navigation:
 - Commissioning assistant.
 - Selection of four ventilation profiles.
 - Adjustment of an individual weekly programme.
 - Adjustment of parameters for room sensors.
 - Indication of e.g. filter replacement, operating statuses and error messages.
 - Different access authorisations and child lock.

– Other functions (see operating instructions).

KNX/EIB module

For connecting the ventilation unit to the building control system via the KNX Connect module.

Room sensors

Room sensors, which measure the mixed gas, CO₂ concentration or relative room air humidity, are available for automatic operation and optimal air exchange.

Post-heating

Helios easyControls 3.0 can be used with an electric post-heating element (EHR with KWL-LTK, accessories). The autonomous operation of the warm water heating element can be controlled via an air temperature control (WHS HE, accessories) independently from Helios easyControls 3.0.

References	Page
Helios easyControls 3.0 The innovative KWL control concept	100 f.
Moisture recovery through enthalpy heat exchangers	99

Performance curves KWL 500 W

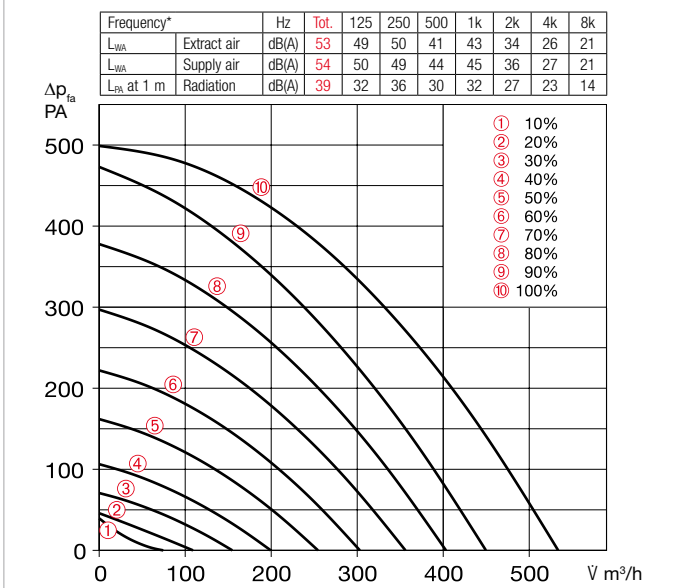

*Sound information relate to V_{ref.} according to ERP data sheet.

Slide switch control element

KWL BE ECO Ref. no. 20246

Three-step slide switch including operation indicator, for flush-mounted installation. Function see left. Dim. mm (W x H x D) 80 x 80 x 37

Casing for surface installation

KWL APG Ref. no. 04270

Dim. mm (W x H x D) 83 x 83 x 41



Touch control element

KWL BE Touch bl

(black) Ref. no. 20244

KWL BE Touch wh

(white) Ref. no. 20245

With graphic display, for flush-mounted installation. Function see left. Connection of up to 6 pcs. possible (additional power supply unit may be required). Can be integrated in common switch ranges with the dimensions mm (W x H x D) 55 x 55 x 35, Dim. with frame mm (W x H x D) 88 x 88 x 35

Casing for surface installation

KWL APG Touch bl No. 40178

KWL APG Touch wh No. 40177

Dim mm (W x H x D) 85 x 85 x 25



Control line cable

KWL-SL eC 5m Ref. no. 40179

KWL-SL eC 10m Ref. no. 40180

Control line cables in 5 or 10 meters, suitable for KWL-BE ECO / Touch as well as room sensor.

Technical data	With plastic heat exchanger		With enthalpy heat exchanger	
	Type	Ref. no.	Type	Ref. no.
Right-hand version	KWL 500 W R	40053	KWL 500 W ET R	40055
Left-hand version	KWL 500 W L	40054	KWL 500 W ET L	40056
Flow rate at level 1) 2)				
Supply air/extract air V m ³ /h	⑩ ⑧ ⑥ ④ ②	534 403 303 200 109	⑩ ⑧ ⑥ ④ ②	506 387 295 190 103
Power consumption fans 2xW ¹⁾		150 82 41 16 7		152 83 41 17 7
Voltage/Frequency	1~, 230 V, 50 Hz			
Rated current A – ventilation	2.5			
– preheating	4.4			
– max. total	2.5 (6.9 incl. preheater, accessories)			
Electric preheater kW	1.0 kW (accessories)			
Summer bypass	automatic (adjustable), with heat exchanger cover			
Wiring diagram no.	1433			
Temperature operating range	–20 °C to +40 °C			
Installation temperature	+5 °C to +40 °C (90% rel. humidity, non-condensing)			
Weight approx. kg	58		66	

1) At 0 Pa, performance levels adjustable. 2) Volume reduction by approx. 10% when using pollen filter.

3) AK = Activated carbon filter 4) For a duct diameter of 160 mm.

5) For a duct diameter of 180 mm.

KNX/EIB module

KWL-KNX Connect No. 20253

For integrating the ventilation unit in a KNX system. For switch cabinet installation (1 space unit required).



Room sensors

KWL-CO2 eC Ref. no. 20248

KWL-FTF eC Ref. no. 20249

KWL-VOC eC Ref. no. 20247

For measuring the CO₂, mixed gas (VOC) concentration or relative room air humidity. Please note the maximum number of sensors, additional power supply unit may be required.



Dim. mm (W x H x D) 98 x 98 x 33

Electric preheater

KWL-EVH 500 W No. 04262

Electrical preheater for simple, plug-in unit installation. For preheating the intake air at very low outdoor temperatures (heat exchanger anti-icing protection). Mandatory for passive houses. Output: 1000 W.



Extension module

KWL-EM eC Ref. no. 40155

For controlling external post-heating elements.

Dim. mm (WxHxD) 210x210x100



Motion detector

BWM Ref. no. 08323

Motion detector for detecting the presence of persons in the room. Surface-mounted wall installation (cable entry at top or bottom) or installation in flush-mounted box Ø 55 mm (cable entry at back).



Electric post-heating element

For additional supply air heating.

EHR-R 2.4/160 Ref. no. 09435

Rectangular duct temp. sensor

KWL-LTK eC (1 pc. req.) No. 40156

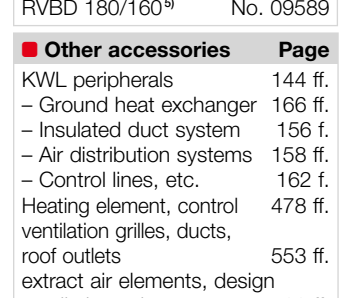

Warm water post-heating element

For additional supply air heating.

WHR 160 Ref. no. 09481

Rectangular duct temp. sensor

KWL-LTK eC (2 pc. req.) No. 40156

Hydraulic unit

WHSH HE 24 V (0-10V) No. 08318

Alternative:

Air temperature control

WHST 300 T38 Ref. no. 08817

■ Circular duct connector
Connector with seal for unit connection to circular duct system.
RVBD 160 K⁴⁾ No. 03415
RVBD 180/160⁵⁾ No. 09589

■ Replacement air filters

– 2 pcs. **ISO Coarse 75% (G4)**

ELF-KWL 500/4/4 No. 00039

– 1 pc. **ISO ePM₁ 50% (F7)**

ELF-KWL 500/7 No. 00042

– 1 pc. **ISO ePM_{2.5} 60% (AK)³⁾**

ELF-KWL 500 AK No. 04199

■ Reference

Enthalpy heat exchanger

(accessories) for retrofitting:

KWL-ET 500 No. 00897

Other accessories	Page
KWL peripherals	144 ff.
– Ground heat exchanger	166 ff.
– Insulated duct system	156 f.
– Air distribution systems	158 ff.
– Control lines, etc.	162 f.
Heating element, control	478 ff.
ventilation grilles, ducts,	
roof outlets	553 ff.
extract air elements, design	
ventilation valves	566 ff.

KWL 220 D



Efficiency class

- A+** KWL 220 D R/L with additional room sensor
- A** KWL 220 D R/L



Ultra-flat ceiling units with heat recovery for the central supply and extract ventilation of apartments and small single family houses. Certified according to the passive house standard. Equipped with Helios easyControls 3.0, the innovative control concept for simple network connection and web browser control. Units come with highly efficient plastic heat exchangers and energy-efficient EC motors.

Casing

Made of galvanised steel sheet, inner and front panels powder-coated in white, double-walled, with 20 mm heat and sound insulation on all sides. Installation-friendly and maintenance-friendly. All elements are easily accessible through removable side panels.

Heat exchanger

Large cross counterflow heat exchanger made of plastic, heat recovery efficiency of up to 90 %.

Fans

Two low-noise high-performance centrifugal fans with energy-saving EC motors ensure the air supply and extraction. Maintenance-free, easily removable for cleaning, if required.

Ducts

Installation-friendly connection of intake, exhaust, extract and supply air through ducts with NW 125 mm using duct connectors (RVBD 125 K, accessories).

Condensate connection

Condensate drain at the bottom; ball siphon included in delivery. On-site connection to drain pipe.

Air filter

Clean outdoor air supply via ISO Coarse 75 % (G4) filter and 2nd filter stage via optional ISO ePM₁ 50 % (F7) or activated carbon filter. Extract air side equipped with an ISO Coarse 75 % (G4) filter in front of the heat exchanger.

Summer operation

Equipped with automatic bypass function and heat exchanger cover as standard.

Heat exchanger anti-icing protection

The standard frost monitoring system automatically controls the supply air flow volume and the optionally installed electrical preheater (KWL-EVH 220 D, accessories).

Control system

EasyControls 3.0 is the new, modern control system for all KWL compact units from Helios. The standard LAN interface allows the simple integration of the KWL unit in a network and the integration in Helios Cloud. The unit is optionally controlled via an external control element, on PC/laptop, tablet and Smartphone via the integrated web browser or on the move via the Cloud. See page 100 f. Helios easyControls 3.0 is prepared for:

- The control elements KWL-BE ECO and KWL-BE Touch (optional accessories)
- The humidity sensor integrated as standard and other optio-

Dimensions KWL 220 D R

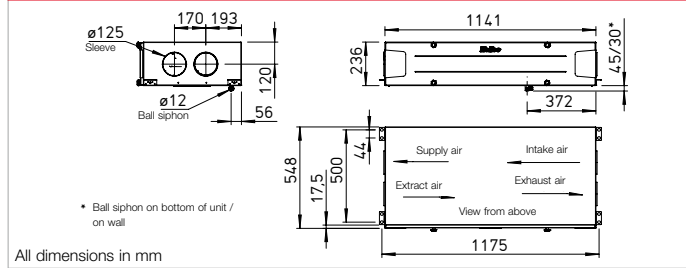

Dimensions KWL 220 D L

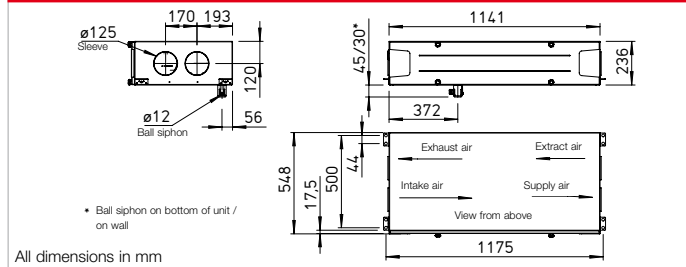

nally available external air quality sensors (KWL-CO₂, -FTF, -VOC, accessories) enable automatic, demand-controlled ventilation.

- Connection to building control system via integrated Modbus interface or optional KNX module (KWL-KNX Connect, accessories).

Electrical connection

Fixed connection via a mains connection cable 3 x 1.5 mm², approx. 2 m with wire end ferrules.

Accessories – Functional description (see right for details)

KWL EC 220 D can be individually expanded with the following accessories:

- Control element ECO**
 - Three ventilation profiles selectable via slide switch.
 - Control voltage can be measured directly on the control element.
 - Weekly timer (WSUP / WSUP-S, no. 09990 / 09577, accessories) can also be added to implement a further operating level, e.g. night mode.
 - LED for visual indication of operating statuses, e.g. filter replacement and faults.
- Control element Touch**
 - Touch control element with graphic display and user-friendly menu navigation:
 - Commissioning assistant.
 - Selection of four ventilation profiles.
 - Adjustment of an individual weekly programme.
 - Adjustment of parameters for room sensors.
 - Indication of e.g. filter replace-

ment, operating statuses and error messages.

- Different access authorisations and child lock.
- Other functions (see operating instructions).
- KNX/EIB module**
 - For connecting the ventilation unit to the building control system via the KNX Connect module.
- Room sensors**
 - Room sensors, which measure the mixed gas, CO₂ concentration or relative room air humidity, are available for automatic operation and optimal air exchange.
- Post-heating**
 - Helios easyControls 3.0 can be used with an electric post-heating element (EHR with KWL-LTK, accessories). The autonomous operation of the warm water heating element can be controlled via an air temperature control (WHS HE, accessories) independently from Helios easyControls 3.0.

References	Page
Helios easyControls 3.0	
The innovative KWL control concept	100 f.

Performance curves KWL 220 D

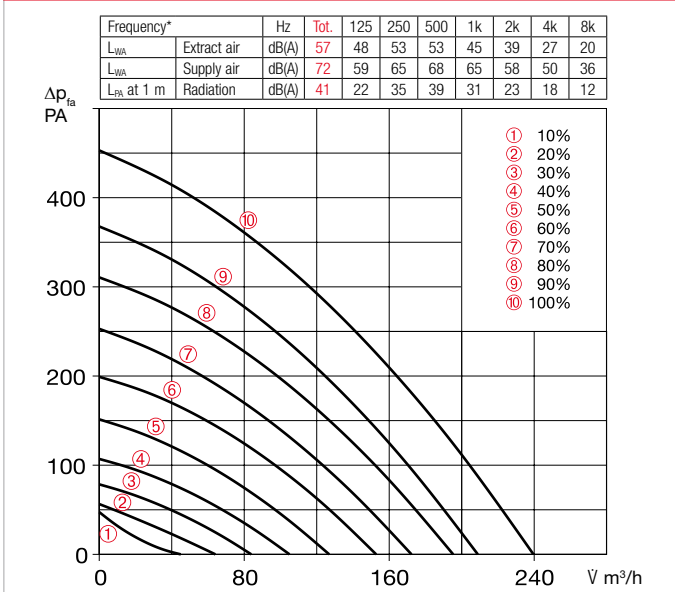

*Sound information relate to Vref. according to ERP data sheet.

Slide switch control element

KWL BE ECO Ref. no. 20246

Three-step slide switch including operation indicator, for flush-mounted installation. Function see left. Dim. mm (W x H x D) 80 x 80 x 37

Casing for surface installation

KWL APG Ref. no. 04270

Dim. mm (W x H x D) 83 x 83 x 41



Touch control element

KWL BE Touch bl

(black) Ref. no. 20244

KWL BE Touch wh

(white) Ref. no. 20245

With graphic display, for flush-mounted installation. Function see left. Connection of up to 6 pcs. possible (additional power supply unit may be required). Can be integrated in common switch ranges with the dimensions mm (W x H x D) 55 x 55 x 35, Dim. with frame mm (W x H x D) 88 x 88 x 35

Casing for surface installation

KWL APG Touch bl No. 40178

KWL APG Touch wh No. 40177

Dim mm (W x H x D) 85 x 85 x 25



Control line cable

KWL-SL eC 5m Ref. no. 40179

KWL-SL eC 10m Ref. no. 40180

Control line cables in 5 or 10 meters, suitable for KWL-BE ECO / Touch as well as room sensor.

Technical data	KWL 220 D R/L	For ceiling installation
Right-hand version	KWL 220 D R	Ref. no. 40057
Left-hand version	KWL 220 D L	Ref. no. 40058
Flow rate at level ^{1) 2)}	⑩ ⑨ ⑧ ⑦ ⑥	
Supply air/extract air V m ³ /h	240 195 153 105 64	
Power consumption fans 2xW ¹⁾	47 30 18 10 6	
Voltage/Frequency	1~, 230 V, 50 Hz	
Rated current A – ventilation	0.8	
– preheating	4.4	
– max. total	0.8 (5.2 incl. preheater, accessories)	
Electric preheater kW	1.0 kW (accessories)	
Summer bypass	automatic (adjustable), with heat exchanger cover	
Wiring diagram no.	1433	
Temperature operating range	–20 °C to +40 °C	
Installation temperature	+5 °C to +40 °C (90% rel. humidity, non-condensing)	
Weight approx. kg	47	

¹⁾ At 0 Pa, performance levels adjustable. ²⁾ Volume reduction by approx. 10% when using pollen filter.

³⁾ AK = Activated carbon filter

KNX/EIB module

KWL-KNX Connect No. 20253

For integrating the ventilation unit in a KNX system. For switch cabinet installation (1 space unit required).



Room sensors

KWL-CO2 eC Ref. no. 20248

KWL-FTF eC Ref. no. 20249

KWL-VOC eC Ref. no. 20247

For measuring the CO₂, mixed gas (VOC) concentration or relative room air humidity. Please note the maximum number of sensors, additional power supply unit may be required.

Dim. mm (W x H x D) 98 x 98 x 33



Electric preheater

KWL-EVH 220 D No. 09636

Electrical preheater for simple, plug-in unit installation. For preheating the intake air at very low outdoor temperatures (heat exchanger anti-icing protection). Mandatory for passive houses. Output: 1000 W.



A+ required for efficiency class A+

Extension module

KWL-EM eC Ref. no. 40155

For controlling external post-heating elements.

Dim. mm (WxHxD) 210x210x100



Motion detector

BWM Ref. no. 08323

Motion detector for detecting the presence of persons in the room. Surface-mounted wall installation (cable entry at top or bottom) or installation in flush-mounted box Ø 55 mm (cable entry at back).

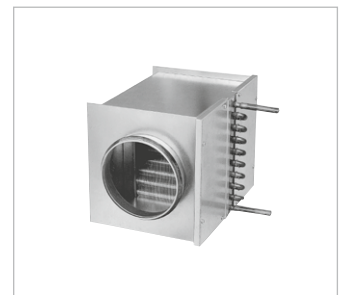

Electric post-heating element

For additional supply air heating.

EHR-R 1.2/125 Ref. no. 09433

Rectangular duct temp. sensor

KWL-LTK eC (1 pc. req.) No. 40156

Warm water post-heating element

For additional supply air heating.

WHR 125 Ref. no. 09480

Rectangular duct temp. sensor

KWL-LTK eC (2 pc. req.) No. 40156

Hydraulic unit

WHSH HE 24 V (0-10V) No. 08318

Alternative:

Air temperature control

WHST 300 T38 Ref. no. 08817

Other accessories	Page
KWL peripherals	144 ff.
– Ground heat exchanger	166 ff.
– Insulated duct system	156 f.
– Air distribution systems	158 ff.
– Control lines, etc.	162 f.
Heating element, control	478 ff.
ventilation grilles, ducts,	
roof outlets	553 ff.
extract air elements, design	
ventilation valves	566 ff.

Replacement air filters

– 2 pcs. **ISO Coarse 75% (G4)**

ELF-KWL 220 D/4/4 No. 09638

– 1 pc. **ISO ePM₁ 50% (F7)**

ELF-KWL 220 D/7 No. 09639

– 1 pc. **ISO ePM_{2.5} 60% (AK)³⁾**

ELF-KWL 220 AK No. 03050

Circular duct connector

Connector with seal for unit

connection to circular duct

system with Ø 125 mm.

RVBD 125 K No. 03414

KWL 340 D



Efficiency class

- A+** KWL 340 D R/L with additional room sensor
- A** KWL 340 D R/L



Ultra-flat ceiling units with heat recovery for the central supply and extract ventilation of apartments and small single family houses. Equipped with Helios easyControls 3.0, the innovative control concept for simple network connection and web browser control. Units come with highly efficient plastic heat exchangers and energy-efficient EC motors.

- Casing**
Made of galvanised steel sheet, inner and front panels powder-coated in white, double-walled, with 20 mm heat and sound insulation on all sides. Installation-friendly and maintenance-friendly. All elements are easily accessible through removable side panels.
- Heat exchanger**
Large cross counterflow heat exchanger made of plastic, heat recovery efficiency of up to 90 %.
- Fans**
Two low-noise high-performance centrifugal fans with energy-saving EC motors ensure the air supply and extraction. Maintenance-free, easily removable for cleaning, if required.
- Ducts**
Installation-friendly connection of intake, exhaust, extract and supply air through ducts with NW 160 mm using duct connectors (RVBD 160 K, accessories).
- Condensate connection**
Condensate drain at the bottom; ball siphon included in delivery. On-site connection to drain pipe.
- Air filter**
Clean outdoor air supply via ISO Coarse 75 % (G4) filter and 2nd filter stage via optional ISO ePM₁ 50 % (F7) or activated carbon filter. Extract air side equipped with an ISO Coarse 75 % (G4) filter in front of the heat exchanger.
- Summer operation**
Equipped with automatic bypass function and heat exchanger cover as standard.
- Heat exchanger anti-icing protection**
The standard frost monitoring system automatically controls the supply air flow volume and the optionally installed electrical preheater (KWL-EVH 340 D, accessories).
- Control system**
EasyControls 3.0 is the new, modern control system for all KWL compact units from Helios. The standard LAN interface allows the simple integration of the KWL unit in a network and the integration in Helios Cloud. The unit is optionally controlled via an external control element, on PC/laptop, tablet and Smartphone via the integrated web browser or on the move via the Cloud. See page 100 f. Helios easyControls 3.0 is prepared for:

 - The control elements KWL-BE ECO and KWL-BE Touch (optional accessories)
 - The humidity sensor integrated as standard and other optionally available external air quality sensors (KWL-CO₂, -FTF, -VOC, accessories) enable automatic, demand-controlled ventilation.

Dimensions KWL 340 D R

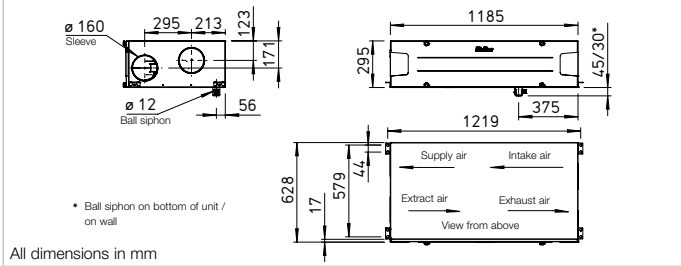

Dimensions KWL 340 D L

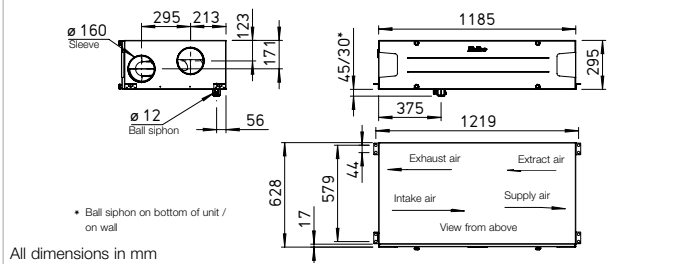

- Connection to building control system via integrated Modbus interface or optional KNX module (KWL-KNX Connect, accessories).
- Electrical connection**
Fixed connection via a mains connection cable 3 x 1.5 mm², approx. 2 m with wire end ferrules.
- Accessories – Functional description (see right for details)**
KWL EC 340 D can be individually expanded with the following accessories:
- Control element ECO**
 - Three ventilation profiles selectable via slide switch.
 - Control voltage can be measured directly on the control element.
 - Weekly timer (WSUP / WSUP-S, no. 09990 / 09577, accessories) can also be added to implement a further operating level, e.g. night mode.
 - LED for visual indication of operating statuses, e.g. filter replacement and faults.
- Control element Touch**
Touch control element with graphic display and user-friendly menu navigation:
 - Commissioning assistant.
 - Selection of four ventilation profiles.
 - Adjustment of an individual weekly programme.
 - Adjustment of parameters for room sensors.
 - Indication of e.g. filter replacement, operating statuses and error messages.
 - Different access authorisations and child lock.
 - Other functions (see operating instructions).
- KNX/EIB module**
For connecting the ventilation unit to the building control system via the KNX Connect module.
- Room sensors**
Room sensors, which measure the mixed gas, CO₂ concentration or relative room air humidity, are available for automatic operation and optimal air exchange.
- Post-heating**
Helios easyControls 3.0 can be used with an electric post-heating element (EHR with KWL-LTK, accessories). The autonomous operation of the warm water heating element can be controlled via an air temperature control (WHS HE, accessories) independently from Helios easyControls 3.0.

References	Page
Helios easyControls 3.0 The innovative KWL control concept	100 f.

Performance curves KWL 340 D

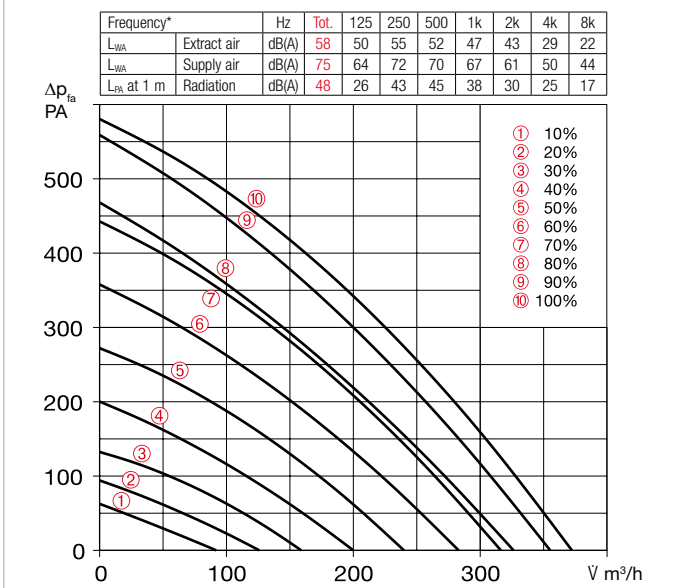

*Sound information relate to Vref. according to ERP data sheet.

Slide switch control element

KWL BE ECO Ref. no. 20246

Three-step slide switch including operation indicator, for flush-mounted installation. Function see left. Dim. mm (W x H x D) 80 x 80 x 37

Casing for surface installation

KWL APG Ref. no. 04270

Dim. mm (W x H x D) 83 x 83 x 41



Touch control element

KWL BE Touch bl

(black) Ref. no. 20244

KWL BE Touch wh

(white) Ref. no. 20245

With graphic display, for flush-mounted installation. Function see left. Connection of up to 6 pcs. possible (additional power supply unit may be required). Can be integrated in common switch ranges with the dimensions mm (W x H x D) 55 x 55 x 35, Dim. with frame mm (W x H x D) 88 x 88 x 35

Casing for surface installation

KWL APG Touch bl No. 40178

KWL APG Touch wh No. 40177

Dim mm (W x H x D) 85 x 85 x 25



Control line cable

KWL-SL eC 5m Ref. no. 40179

KWL-SL eC 10m Ref. no. 40180

Control line cables in 5 or 10 meters, suitable for KWL-BE ECO / Touch as well as room sensor.

Technical data	KWL 340 D R/L	For ceiling installation				
Right-hand version	KWL 340 D R	Ref. no. 40059				
Left-hand version	KWL 340 D L	Ref. no. 40060				
Flow rate at level ^{1) 2)}		⑩	⑥	③	④	②
Supply air/extract air V m ³ /h		372	326	283	200	126
Power consumption fans 2xW ¹⁾		79	56	40	20	10
Voltage/Frequency		1~, 230 V, 50 Hz				
Rated current A – ventilation		1.2				
– preheating		5.6				
– max. total		1.2 (6.8 incl. preheater, accessories)				
Electric preheater kW		1.3 kW (accessories)				
Summer bypass		automatic (adjustable), with heat exchanger cover				
Wiring diagram no.		1433				
Temperature operating range		–20 °C to +40 °C				
Installation temperature		+5 °C to +40 °C (90% rel. humidity, non-condensing)				
Weight approx. kg		77				

¹⁾ At 0 Pa, performance levels adjustable. ²⁾ Volume reduction by approx. 10% when using pollen filter.

³⁾ AK = Activated carbon filter

KNX/EIB module

KWL-KNX Connect No. 20253

For integrating the ventilation unit in a KNX system. For switch cabinet installation (1 space unit required).



Room sensors

KWL-CO2 eC Ref. no. 20248

KWL-FTF eC Ref. no. 20249

KWL-VOC eC Ref. no. 20247

For measuring the CO₂, mixed gas (VOC) concentration or relative room air humidity. Please note the maximum number of sensors, additional power supply unit may be required.

Dim. mm (W x H x D) 98 x 98 x 33



Electric preheater

KWL-EVH 340 D No. 04241

Electrical preheater for simple, plug-in unit installation. For preheating the intake air at very low outdoor temperatures (heat exchanger anti-icing protection). Mandatory for passive houses. Output: 1280 W.



A+ required for efficiency class A+

Extension module

KWL-EM eC Ref. no. 40155

For controlling external post-heating elements.

Dim. mm (WxHxD) 210x210x100



Motion detector

BWM Ref. no. 08323

Motion detector for detecting the presence of persons in the room. Surface-mounted wall installation (cable entry at top or bottom) or installation in flush-mounted box Ø 55 mm (cable entry at back).

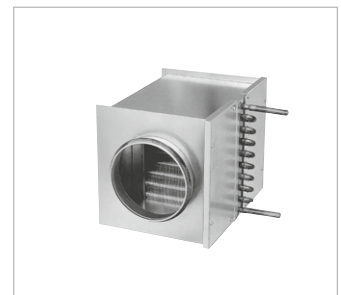

Electric post-heating element

For additional supply air heating.

EHR-R 2.4/160 Ref. no. 09435

Rectangular duct temp. sensor

KWL-LTK eC (1 pc. req.) No. 40156

Warm water post-heating element

For additional supply air heating.

WHR 160 Ref. no. 09481

Rectangular duct temp. sensor

KWL-LTK eC (2 pc. req.) No. 40156

Hydraulic unit

WHSH HE 24 V (0-10V) No. 08318

Alternative:

Air temperature control

WHST 300 T38 Ref. no. 08817

Other accessories	Page
KWL peripherals	144 ff.
– Ground heat exchanger	166 ff.
– Insulated duct system	156 f.
– Air distribution systems	158 ff.
– Control lines, etc.	162 f.
Heating element, control	478 ff.
ventilation grilles, ducts, roof outlets	553 ff.
extract air elements, design	
ventilation valves	566 ff.

Replacement air filters

– 2 pcs. **ISO Coarse 75% (G4)**

ELF-KWL 340 D/4/4 No. 04239

– 1 pc. **ISO ePM₁, 50% (F7)**

ELF-KWL 340 D/7 No. 04240

– 1 pc. **ISO ePM_{2.5} 60% (AK)³⁾**

ELF-KWL 340 AK No. 03051

Circular duct connector

Connector with seal for unit connection to circular duct system with Ø 160 mm.

RVBD 160 K No. 03415

KWL EC 700 D



Dimensions KWL EC 700 D

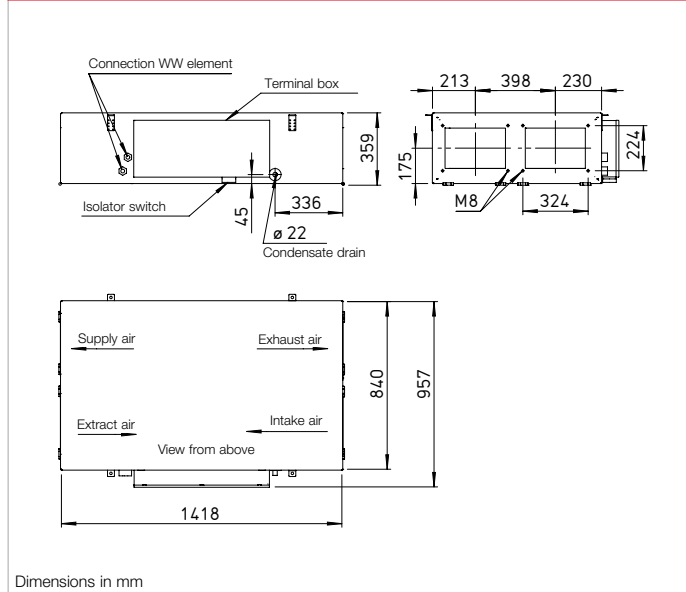

Ultra-flat ventilation units with heat recovery for compact and space-saving ceiling installation.

With a wide range of residential, commercial and industrial applications. Independently certified hygiene properties and energy efficiency according to VDI 6022 and the passive house standard. Unit construction and unit components fulfil the general hygiene requirements according to VDI 6022.

Available in various comfort and equipment variants.

■ Casing

Double-walled, made of galvanised steel sheet, with 30 mm heat and sound insulation on all sides. The inspection openings for filter replacement are accessible at the bottom of the unit without tools.

Ceiling installation via vibration-damping fastening elements included in the delivery.

■ Heat exchanger

Large cross counterflow heat exchanger made of aluminium with heat recovery efficiency of up to 90 %. Dismantling possible in just a few simple steps.

■ Fans

Two low-noise high-performance EC fans with backward-curved impellers guarantee maximum energy efficiency. The special control technology enables constant volume control or constant pressure control.

■ Ducts

Installation-friendly connection of intake, exhaust, extract and supply air through pipe or duct system NW 250 mm.

■ Condensate connection

A separate condensate tray below the heat exchanger facilitates maintenance work on the unit. Drain connectors on the side next to the terminal box. Ball siphon included in delivery. On-site connection to drain pipe.

■ Air filter

Standard equipment: Clean intake air supply via ISO ePM₁ 55% filter (F7). The heat exchanger requires a ISO ePM₁₀ 50% filter (M5) on the extract air side. All filters are pressure-controlled and exchangeable in just a few simple steps.

■ Summer operation

Standard equipment with automatic bypass function for maximum comfort.

■ Heat exchanger anti-icing protection

An electric preheating element heats the intake air at very low outdoor temperatures. Thus, it prevents the heat exchanger from icing up and guarantees its safe functioning and optimal heat recovery during the entire heating period.

■ Power control

The comfort control element with graphic display and user-friendly menu navigation, which is included in the delivery, enables the following functions:

- Control directly via touchscreen.
- Freely definable operating points within the entire range of the performance curve.
- Selection between constant volume control or constant pressure control.
- Demand-oriented ventilation using CO₂, VOC (mixed gas) or humidity sensor.
- Initial commissioning (automatic determination of the system performance curve).
- Control of external shutters.
- Connection of a fire alarm contact.
- Weekly or daily programme.
- Pressure monitoring of filter contamination.
- Indication of necessary filter replacement, operating status, error messages.
- Different access levels. The ventilation unit is alternatively controllable via ModBus (RS 485, TCP/IP).

■ Electrical connection

Easily accessible terminal box on the side of the casing. The isolator/main switch can be controlled from below the unit for maintenance work and it can be locked with a padlock to prevent unauthorised access.

■ Post-heating

Type KWL EC Pro WW

The integrated warm water heating element guarantees the convenient and energy-efficient post-heating of supply air. The setpoint temperature is simply set in the control element. The hydraulic unit (Type WHSH HE 24 V (0-10 V), accessories) is recommended for controlling the warm water heat exchanger.

■ Reference

The ventilation unit design according to VDI 6022 requires the use of VDI 6022-compliant air filters. The use of original replacement air filters is therefore mandatory.

■ Replacement air filter

- 1 pc. ISO ePM₁₀ 50% (M5) ELF-KWL 700 D/5 VDI No.04189
- 1 pc. ISO ePM₁ 55% (F7) ELF-KWL 700 D/7 VDI No.04191

■ Other accessories Page

KWL peripherals	144 ff.
– Air distribution systems	158 ff.
– Further overview, control lines	162 f.

Accessory details

Ventilation grilles, ducts, fittings	
roof outlets	553 ff.
extract air elements	566 ff.

Performance curve KWL EC 700 D

Frequency	Hz	Tot.	125	250	500	1k	2k	4k	8k
L _{WA} Extract air		dB(A) 53	46	49	47	41	40	34	23
L _{WA} Supply air		dB(A) 68	54	65	63	59	53	48	39
L _{PA} at 1 m		dB(A) 47	33	41	43	41	35	29	14

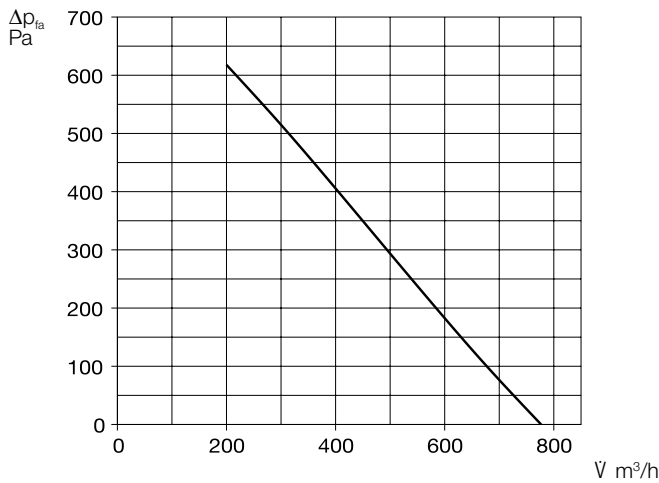

Included in delivery

Surface comfort control element

User-friendly control via self-explanatory graphic elements with clear text directly on the touchscreen. Control line (10 metres) included in delivery, other lengths available (ALB EC-SK, accessories).
Dim. mm (WxHxD) 115x80x25



Control element with connection cable (10 m) included in the scope of delivery. Dim. mm (WxHxD) 115 x 80 x 25

Accessories for Type Pro WW

Hydraulic unit

WHSH HE 24 V (0-10 V) No. 08318

Controls the water temperature of the PWW heating element using a three-way valve actuator 24 V (0-10 V) and thus the heat output transferred to the air. Delivered as a complete unit, incl. VL-/RL temperature display, circulating pump and flexible connection hoses.



Accessories for all types

Room sensor – Air quality

AIR1/KWL-VOC 0-10V No. 20250

AIR1/KWL-CO2 0-10V No. 20251

AIR1/KWL-FTF 0-10V No. 20252

For measuring the CO₂, mixed gas (VOC) concentration or relative room air humidity. A maximum of one sensor can be connected.
Dim. mm (W x H x D) 85 x 85 x 27



Room sensor – Temperature

TFR-ALB/KWL No. 07277

For measuring the room temperature and controlling the ventilation unit according to the set value. Incl. 20 m control line. Maximum total of one sensor can be connected.
Dim. mm (W x H x D) 80 x 80 x 25



Transition piece – Symmetrical

KWL-ÜS 700 D No. 04206

From unit flange to round duct systems.

Flexible connecting sleeve

FM 250 No. 01672

For acoustic decoupling, incl. 2 pcs. hose clamps.

Duct shutter, motorised

RVM 250 No. 02576

Prevents cold draughts when the unit is at a standstill. Automatic function through fan operation, with mounted spring return motor (outside of air flow). Installation in any position.

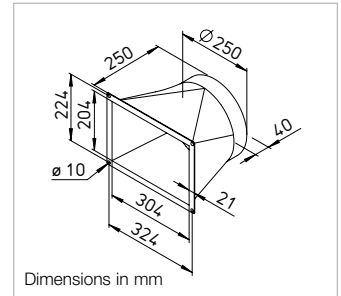

Dimensions in mm

Angle flange ring

FR 250 No. 01203

Made of galvanised steel sheet, for duct connection.



Technical data	KWL EC 700 D			KWL EC 700 D, With warm water post-heater		
	Type	Ref. no.	Type	Ref. no.	Type	Ref. no.
For ceiling installation	KWL EC 700 D Pro	04171	KWL EC 700 D Pro WW	04172		
Flow rate at level¹⁾ Supply air/extract air V m ³ /h approx.	③ 510	② 330	① 210	③ 510	② 330	① 210
Noise dB(A)²⁾						
Supply air L _{WA} (sound power)	68	64	55	68	64	55
Extract air L _{WA} (sound power)	53	47	37	53	47	37
Radiation L _{PA} at 1 m	47	n/a	n/a	47	n/a	n/a
Power consumption fans 2 x W	110	60	38	110	60	38
Voltage/Frequency	230 V~, 50 Hz			230 V~, 50 Hz		
Rated current A – Ventilation	2.3			2.3		
– Preheating	12.0			12.0		
– max. total	14.3			14.3		
Heat output/Postheater kW	–			2.3 (at 60/40 °C) / 2.1 (at 50/40 °C) / 1.3 (at 40/30 °C)		
Electric preheater kW	–			2.6		
Summer bypass	–			automatic		
Wiring diagram no.	1370			1370		
Temperature operating range	–20 °C to +40 °C			–20 °C to +40 °C		
Connection PWW heating element	–			IG 1/2"		
Weight approx. kg	110			115		

¹⁾ Values based on operating ranges defined according to PHI (Passive House Institute).

²⁾ At 100 Pa.

KWL EC 1400 D



Dimensions KWL EC 1400 D

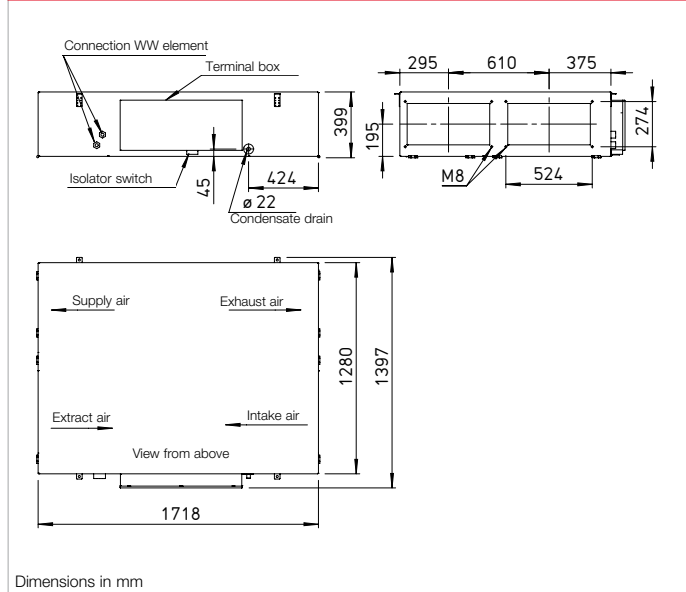

Ultra-flat ventilation units with heat recovery for compact and space-saving ceiling installation.

With a wide range of residential, commercial and industrial applications. Independently certified hygiene properties and energy efficiency according to VDI 6022 and the passive house standard. Unit construction and unit components fulfil the general hygiene requirements according to VDI 6022.

Available in various comfort and equipment variants.

■ Casing

Double-walled, made of galvanised steel sheet, with 30 mm heat and sound insulation on all sides. The inspection openings for filter replacement are accessible at the bottom of the unit without tools.

Ceiling installation via vibration-damping fastening elements included in the delivery.

■ Heat exchanger

Large cross counterflow heat exchanger made of aluminium with heat recovery efficiency of up to 90 %. Dismantling possible in just a few simple steps.

■ Fans

Two low-noise high-performance EC fans with backward-curved impellers guarantee maximum energy efficiency. The special control technology enables constant volume control or constant pressure control.

■ Ducts

Installation-friendly connection of intake, exhaust, extract and supply air through pipe or duct system NW 315 mm.

■ Condensate connection

A separate condensate tray below the heat exchanger facilitates maintenance work on the unit. Drain connectors on the side next to the terminal box. Ball siphon included in delivery. On-site connection to drain pipe.

■ Air filter

Standard equipment: Clean intake air supply via ISO ePM₁ 55% filter (F7). The heat exchanger requires a ISO ePM₁₀ 50% filter (M5) on the extract air side. All filters are pressure-controlled and exchangeable in just a few simple steps.

■ Summer operation

Standard equipment with automatic bypass function for maximum comfort.

■ Heat exchanger anti-icing protection

An electric preheating element heats the intake air at very low outdoor temperatures. Thus, it prevents the heat exchanger from icing up and guarantees its safe functioning and optimal heat recovery during the entire heating period.

■ Power control

The comfort control element with graphic display and user-friendly menu navigation, which is included in the delivery, enables the following functions:

- Control directly via touchscreen.
- Freely definable operating points within the entire range of the performance curve.
- Selection between constant volume control or constant pressure control.
- Demand-oriented ventilation using CO₂, VOC (mixed gas) or humidity sensor.
- Initial commissioning (automatic determination of the system performance curve).
- Control of external shutters.
- Connection of a fire alarm contact.
- Weekly or daily programme.
- Pressure monitoring of filter contamination.
- Indication of necessary filter replacement, operating status, error messages.
- Different access levels. The ventilation unit is alternatively controllable via ModBus (RS 485, TCP/IP).

■ Electrical connection

Easily accessible terminal box on the side of the casing. The isolator/main switch can be controlled from below the unit for maintenance work and it can be locked with a padlock to prevent unauthorised access.

■ Post-heating

Type KWL EC Pro WW

The integrated warm water heating element guarantees the convenient and energy-efficient post-heating of supply air. The setpoint temperature is simply set in the control element. The hydraulic unit (Type WHSH HE 24 V (0-10 V), accessories) is recommended for controlling the warm water heat exchanger.

■ Reference

The ventilation unit design according to VDI 6022 requires the use of VDI 6022-compliant air filters. The use of original replacement air filters is therefore mandatory.

■ Replacement air filter

- 1 pc. ISO ePM₁₀ 50% (M5) ELF-KWL 1400 D/5 VDI No.04193
- 1 pc. ISO ePM₁ 55% (F7) ELF-KWL 1400 D/7 VDI No.04195

■ Other accessories Page

KWL peripherals	144 ff.
– Air distribution systems	158 ff.
– Further overview, control lines	162 f.

Accessory details

Ventilation grilles, ducts, fittings	
roof outlets	553 ff.
extract air elements	566 ff.

Performance curve KWL EC 1400 D

Frequency	Hz	Tot.	125	250	500	1k	2k	4k	8k
L _{WA} Extract air		60	51	53	53	50	51	49	45
L _{WA} Supply air		80	63	68	71	71	75	71	70
L _{PA} at 1 m		53	42	48	48	47	43	33	21

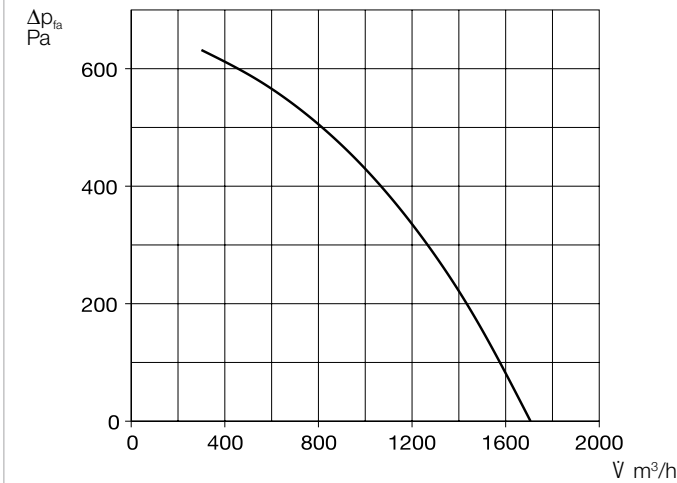

Included in delivery

Surface comfort control element

User-friendly control via self-explanatory graphic elements with clear text directly on the touchscreen. Control line (10 metres) included in delivery, other lengths available (ALB EC-SK, accessories).
Dim. mm (WxHxD) 115x80x25



Control element with connection cable (10 m) included in the scope of delivery. Dim. mm (WxHxD) 115 x 80 x 25

Accessories for Type Pro WW

Hydraulic unit

WHSH HE 24 V (0-10 V) No. 08318

Controls the water temperature of the PWW heating element using a three-way valve actuator 24 V (0-10 V) and thus the heat output transferred to the air. Delivered as a complete unit, incl. VL-/RL temperature display, circulating pump and flexible connection hoses.



Accessories for all types

Room sensor – Air quality

AIR1/KWL-VOC 0-10V No. 20250

AIR1/KWL-CO2 0-10V No. 20251

AIR1/KWL-FTF 0-10V No. 20252

For measuring the CO₂, mixed gas (VOC) concentration or relative room air humidity. A maximum of one sensor can be connected.
Dim. mm (W x H x D) 85 x 85 x 27



Room sensor – Temperature

TFR-ALB/KWL No. 07277

For measuring the room temperature and controlling the ventilation unit according to the set value. Incl. 20 m control line. Maximum total of one sensor can be connected.
Dim. mm (W x H x D) 80 x 80 x 25



Transition piece – Symmetrical

KWL-ÜS 1400 D No. 04207

For acoustic decoupling, incl. 2 pcs. hose clamps.

Flexible connecting sleeve

FM 315 No. 01674

For acoustic decoupling, incl. 2 pcs. hose clamps.

Duct shutter, motorised

RVM 315 No. 02578

Prevents cold draughts when the unit is at a standstill. Automatic function through fan operation, with mounted spring return motor (outside of air flow). Installation in any position.

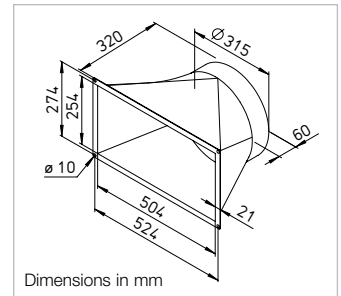

Dimensions in mm

Angle flange ring

FR 315 No. 01204

Made of galvanised steel sheet, for duct connection.



Technical data		KWL EC 1400 D			KWL EC 1400 D, With warm water post-heater		
	Type	Ref. no.		Type	Ref. no.		
For ceiling installation	KWL EC 1400 D Pro	04173		KWL EC 1400 D Pro WW	04174		
Flow rate at level¹⁾		③	②	①	③	②	
Supply air/extract air V m ³ /h approx.		1000	650	400	1000	650	
Noise dB(A)²⁾							
Supply air L _{WA} (sound power)		80	71	60	80	71	
Extract air L _{WA} (sound power)		60	51	39	60	51	
Radiation L _{PA} at 1 m		53	n/a	n/a	53	n/a	
Power consumption fans 2 x W		225	140	80	225	140	
Voltage/Frequency		3N~, 400 V, 50 Hz			3N~, 400 V, 50 Hz		
Rated current A – Ventilation		6.0 / – / –			6.0 / – / –		
– Preheating		– / 11.4 / 11.4			– / 11.4 / 11.4		
– max. total		6.0 / 11.4 / 11.4			6.0 / 11.4 / 11.4		
Heat output/Postheater kW		–			4.7 (at 60/40 °C) / 4.2 (at 50/40 °C) / 2.7 (at 40/30 °C)		
Electric preheater kW		–			4.1		
Summer bypass		automatic			automatic		
Wiring diagram no.		1370			1370		
Temperature operating range		–20 °C to +40 °C			–20 °C to +40 °C		
Connection PWW heating element		–			IG 1/2"		
Weight approx. kg		185			190		

¹⁾ Values based on operating ranges defined according to PHI (Passive House Institute).

²⁾ At 215 Pa.

KWL EC 2000 D



Dimensions KWL EC 2000 D

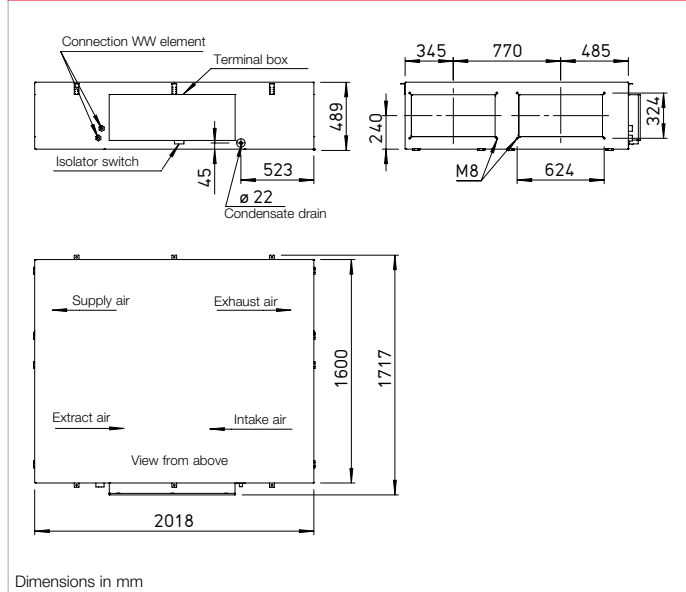

Ultra-flat ventilation units with heat recovery for compact and space-saving ceiling installation.

With a wide range of residential, commercial and industrial applications. Independently certified hygiene properties and energy efficiency according to VDI 6022 and the passive house standard. Unit construction and unit components fulfil the general hygiene requirements according to VDI 6022.

Available in various comfort and equipment variants.

■ Casing

Double-walled, made of galvanised steel sheet, with 30 mm heat and sound insulation on all sides. The inspection openings for filter replacement are accessible at the bottom of the unit without tools.

Ceiling installation via vibration-damping fastening elements included in the delivery.

■ Heat exchanger

Large cross counterflow heat exchanger made of aluminium with heat recovery efficiency of up to 90 %. Dismantling possible in just a few simple steps.

■ Fans

Two low-noise high-performance EC fans with backward-curved impellers guarantee maximum energy efficiency. The special control technology enables constant volume control or constant pressure control.

■ Ducts

Installation-friendly connection of intake, exhaust, extract and supply air through pipe or duct system NW 400 mm.

■ Condensate connection

A separate condensate tray below the heat exchanger facilitates maintenance work on the unit. Drain connectors on the side next to the terminal box. Ball siphon included in delivery. On-site connection to drain pipe.

■ Air filter

Standard equipment: Clean intake air supply via ISO ePM₁ 55% filter (F7). The heat exchanger requires a ISO ePM₁₀ 50% filter (M5) on the extract air side. All filters are pressure-controlled and exchangeable in just a few simple steps.

■ Summer operation

Standard equipment with automatic bypass function for maximum comfort.

■ Heat exchanger anti-icing protection

An electric preheating element heats the intake air at very low outdoor temperatures. Thus, it prevents the heat exchanger from icing up and guarantees its safe functioning and optimal heat recovery during the entire heating period.

■ Power control

The comfort control element with graphic display and user-friendly menu navigation, which is included in the delivery, enables the following functions:

- Control directly via touchscreen.
- Freely definable operating points within the entire range of the performance curve.
- Selection between constant volume control or constant pressure control.
- Demand-oriented ventilation using CO₂, VOC (mixed gas) or humidity sensor.
- Initial commissioning (automatic determination of the system performance curve).
- Control of external shutters.
- Connection of a fire alarm contact.
- Weekly or daily programme.
- Pressure monitoring of filter contamination.
- Indication of necessary filter replacement, operating status, error messages.
- Different access levels. The ventilation unit is alternatively controllable via ModBus (RS 485, TCP/IP).

■ Electrical connection

Easily accessible terminal box on the side of the casing. The isolator/main switch can be controlled from below the unit for maintenance work and it can be locked with a padlock to prevent unauthorised access.

■ Post-heating

Type KWL EC Pro WW

The integrated warm water heating element guarantees the convenient and energy-efficient post-heating of supply air. The setpoint temperature is simply set in the control element. The hydraulic unit (Type WSH HE 24 V (0-10 V), accessories) is recommended for controlling the warm water heat exchanger.

■ Reference

The ventilation unit design according to VDI 6022 requires the use of VDI 6022-compliant air filters. The use of original replacement air filters is therefore mandatory.

■ Replacement air filter

- 1 pc. ISO ePM₁₀ 50% (M5) ELF-KWL 2000 D/5 VDI No. 04197
- 1 pc. ISO ePM₁ 55% (F7) ELF-KWL 2000 D/7 VDI No. 04204

■ Other accessories Page

KWL peripherals	144 ff.
– Air distribution systems	158 ff.
– Further overview, control lines	162 f.

Accessory details

Ventilation grilles, ducts, fittings	
roof outlets	553 ff.
extract air elements	566 ff.

Performance curve KWL EC 2000 D

Frequency	Hz	Tot.	125	250	500	1k	2k	4k	8k
L _{WA} Extract air		dB(A) 59	56	52	48	49	47	45	40
L _{WA} Supply air		dB(A) 77	66	68	67	72	69	69	64
L _{PA} at 1 m		dB(A) 50	46	42	43	44	38	31	21

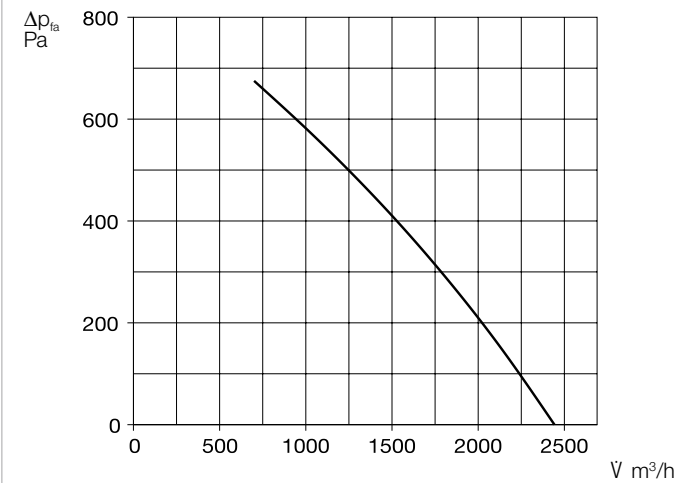

Included in delivery

Surface comfort control element
User-friendly control via self-explanatory graphic elements with clear text directly on the touchscreen. Control line (10 metres) included in delivery, other lengths available (ALB EC-SK, accessories).
Dim. mm (WxHxD) 115x80x25



Control element with connection cable (10 m) included in the scope of delivery. Dim. mm (WxHxD) 115 x 80 x 25

Accessories for Type Pro WW

Hydraulic unit
WHSH HE 24 V (0-10 V) No. 08318
Controls the water temperature of the PWW heating element using a three-way valve actuator 24 V (0-10 V) and thus the heat output transferred to the air. Delivered as a complete unit, incl. VL-/RL temperature display, circulating pump and flexible connection hoses.



Accessories for all types

Room sensor – Air quality

AIR1/KWL-VOC 0-10V No. 20250
AIR1/KWL-CO2 0-10V No. 20251
AIR1/KWL-FTF 0-10V No. 20252
For measuring the CO₂, mixed gas (VOC) concentration or relative room air humidity. A maximum of one sensor can be connected.
Dim. mm (W x H x D) 85 x 85 x 27



Room sensor – Temperature

TFR-ALB/KWL No. 07277
For measuring the room temperature and controlling the ventilation unit according to the set value. Incl. 20 m control line. Maximum total of one sensor can be connected.
Dim. mm (W x H x D) 80 x 80 x 25



Transition piece – Symmetrical

KWL-ÜS 2000 D No. 04208
From unit flange to round duct systems.

Flexible connecting sleeve

FM 400 No. 01676
For acoustic decoupling, incl. 2 pcs. hose clamps.

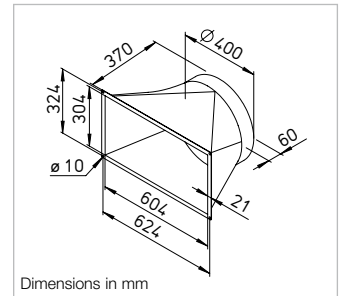

Dimensions in mm

Duct shutter, motorised

RVM 400 No. 02580
Prevents cold draughts when the unit is at a standstill. Automatic function through fan operation, with mounted spring return motor (outside of air flow). Installation in any position.



Angle flange ring

FR 400 No. 01206
Made of galvanised steel sheet, for duct connection.

Technical data	KWL EC 2000 D			KWL EC 2000 D, With warm water post-heater		
	Type	Ref. no.	Type	Ref. no.	Type	Ref. no.
For ceiling installation	KWL EC 2000 D Pro	04175	KWL EC 2000 D Pro WW	04176		
Flow rate at level¹⁾ Supply air/extract air V m ³ /h approx.	③ 1800	② 1150	① 720	③ 1800	② 1150	① 720
Noise dB(A)²⁾						
Supply air L _{WA} (sound power)	77	67	57	77	67	57
Extract air L _{WA} (sound power)	59	50	40	59	50	40
Radiation L _{PA} at 1 m	50	n/a	n/a	50	n/a	n/a
Power consumption fans 2 x W	395	245	150	395	245	150
Voltage/Frequency	3N~, 400 V, 50 Hz			3N~, 400 V, 50 Hz		
Rated current A – Ventilation	6.0 / – / –			6.0 / – / –		
– Preheating	10.0 / 11.0 / 11.0			10.0 / 11.0 / 11.0		
– max. total	16.0 / 11.0 / 11.0			16.0 / 11.0 / 11.0		
Heat output/Postheater kW	–			8.1 (at 60/40 °C) / 7.3 (at 50/40 °C) / 4.6 (at 40/30 °C)		
Electric preheater kW	–			6.6		
Summer bypass	–			automatic		
Wiring diagram no.	1370			1370		
Temperature operating range	–20 °C to +40 °C			–20 °C to +40 °C		
Connection PWW heating element	–			IG 1/2"		
Weight approx. kg	265			270		

¹⁾ Values based on operating ranges defined according to PHI (Passive House Institute).

²⁾ At 250 Pa.

KWL EC 800 S



KWL EC 800 S with base cover (accessories)



Dimensions KWL EC 800 S

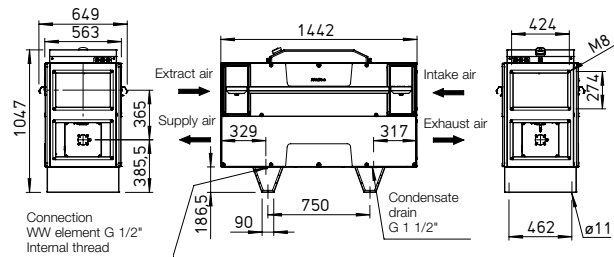

All Dimensions in mm



Central units with heat recovery for compact and space-saving floor installation (floor standing).

With a wide range of residential, commercial and industrial applications.

Independently certified hygiene properties and energy efficiency according to VDI 6022 and the passive house standard. Unit construction and unit components fulfil the general hygiene requirements according to VDI 6022. Optionally available with integrated warm water heating element.

■ Casing

Double-walled, made of galvanised steel sheet, with 30 mm heat and sound insulation on all sides. Inspection openings for filter replacement fastened to both side panels with screws. Both side walls can be completely dismantled for free access to all components. The unit is suitable for floor installation (standing) indoors. Vibration dampers can be underlaid (on-site) to prevent the direct transmission of vibrations and structure-borne noise to building parts.

■ Heat exchanger

Large cross counterflow heat exchanger made of aluminium with heat recovery efficiency of up to 90 %. Dismantling possible in just a few simple steps.

■ Fans

Two low-noise high-performance EC fans with backward-curved impellers guarantee maximum energy efficiency. The special control technology enables constant volume control or constant pressure control.

■ Ducts

Installation-friendly connection of intake, exhaust, extract and supply air through pipe or duct system NW 250 mm. The floor-standing unit can be rotated 180° for installation so that intake air and exhaust air as well as extract air and supply air connections can be on the left or right sides.

■ Condensate connection

The unit contains a stainless steel condensate tray with a condensate drain below. Ball siphon included in delivery. On-site connection to drain pipe.

■ Air filter

Standard equipment: Clean intake air supply via ISO ePM₁ 55% filter (F7). The heat exchanger requires a ISO ePM₁₀ 50% filter (M5) on the extract air side. All filters are pressure-controlled and exchangeable in just a few simple steps.

■ Summer operation

Standard equipment with automatic bypass function for maximum comfort.

■ Heat exchanger anti-icing protection

An electric preheating element heats the intake air at very low outdoor temperatures. Thus, it prevents the heat exchanger from icing up and guarantees its safe functioning and optimal heat recovery during the entire heating period.

■ Power control

- The comfort control element with graphic display and user-friendly menu navigation, which is included in the delivery, enables the following functions:
- Control directly via touchscreen.
 - Freely definable operating points within the entire range of the performance curve.
 - Selection between constant volume control or constant pressure control.
 - Demand-oriented ventilation using CO₂, VOC (mixed gas) or humidity sensor.
 - Building control system via ModBus (RS 485, TCP/IP).
 - Initial commissioning (automatic determination of the system performance curve).
 - Control of external shutters.
 - Connection of a fire alarm contact.
 - Weekly or daily programme.
 - Pressure monitoring of filter contamination.
 - Indication of necessary filter replacement, operating status, error messages.
 - Different access levels.

■ Electrical connection

Easily accessible terminal box on top of the casing. The isolator/main switch can be controlled from below the unit for maintenance work and it can be locked with a padlock to prevent unauthorised access.

■ Post-heating Type KWL EC Pro WW

The integrated warm water heating element guarantees the convenient and energy-efficient post-heating of supply air. The setpoint temperature is simply set in the control element. The hydraulic unit (Type WSH HE 24 V (0-10V), accessories) is recommended for controlling the warm water heat exchanger.

■ Reference

The ventilation unit design according to VDI 6022 requires the use of VDI 6022-compliant air filters. The use of original replacement air filters is therefore mandatory.

■ Replacement air filter

- 1 pc. ISO ePM₁₀ 50% filter ELF-KWL 800 S/5 VDI No. 08256
- 1 pc. ISO ePM₁ 55% filter ELF-KWL 800 S/7 VDI No. 08257

■ Other accessories Page

KWL peripherals	144 ff.
– Air distribution systems	158 ff.
– Further overview, control lines	162 f.

Accessory details

Ventilation grilles, ducts, fittings	
roof outlets	553 ff.
extract air elements	566 ff.

Performance curve KWL EC 800 S

Frequency	Hz	Tot.	125	250	500	1k	2k	4k	8k
L_{WA} Extract air	dB(A)	70	65	68	54	49	43	35	34
L_{WA} Supply air	dB(A)	78	76	73	67	63	63	55	55
L_{PA} at 1 m	dB(A)	54	50	50	42	42	41	31	25

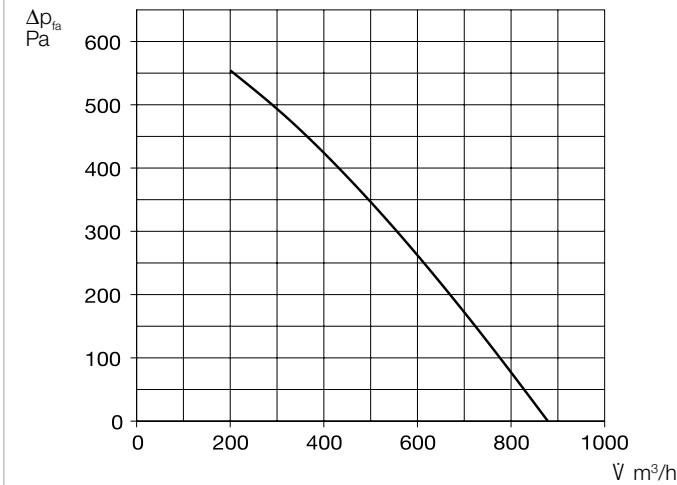

Included in delivery

Surface comfort control element
User-friendly control via self-explanatory graphic elements with clear text directly on the touchscreen. Control line (10 metres) included in delivery, other lengths available (ALB EC-SK, accessories).
Dim. mm (WxHxD) 115x80x25



Control element with connection cable (10 m) included in the scope of delivery. Dim. mm (WxHxD) 115 x 80 x 25

Accessories for Type Pro WW

Hydraulic unit
WHSH HE 24 V (0-10 V) No. 08318
Controls the water temperature of the PWW heating element using a three-way valve actuator 24 V (0-10 V) and thus the heat output transferred to the air. Delivered as a complete unit, incl. VL-/RL temperature display, circulating pump and flexible connection hoses.



Accessories for all types

Room sensor – Air quality

AIR1/KWL-VOC 0-10V No. 20250
AIR1/KWL-CO2 0-10V No. 20251
AIR1/KWL-FTF 0-10V No. 20252
For measuring the CO₂, mixed gas (VOC) concentration or relative room air humidity. A maximum of one sensor can be connected.
Dim. mm (W x H x D) 85 x 85 x 27



Room sensor – Temperature

TFR-ALB/KWL No. 07277
For measuring the room temperature and controlling the ventilation unit according to the set value. Incl. 20 m control line. Maximum total of one sensor can be connected.
Dim. mm (W x H x D) 80 x 80 x 25



Transition piece – Symmetrical

KWL-ÜS 800 S No. 08339
From unit flange to round duct systems.

Flexible connecting sleeve

FM 250 No. 01672
For acoustic decoupling, incl. 2 pcs. hose clamps.

Duct shutter, motorised

RVM 250 No. 02576
Prevents cold draughts when the unit is at a standstill. Automatic function through fan operation, with mounted spring return motor (outside of air flow). Installation in any position.

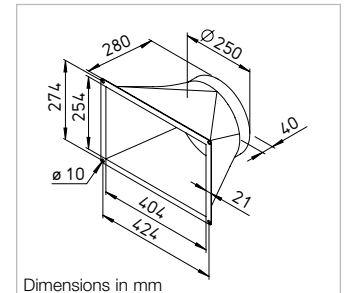

Dimensions in mm

Angle flange ring

FR 250 No. 01203
Made of galvanised steel sheet, for duct connection.

Base cover

KWL-SB 800 S No. 09315
Made of galvanised steel sheet.



Technical data	KWL EC 800 S KWL EC 800 S Pro			Ref. no. 08327	KWL EC 800 S KWL EC 800 S Pro WW			Ref. no. 08328
For floor-standing installation	③	②	①		③	②	①	
Flow rate at level¹⁾ Supply air/extract V m ³ /h approx.	600	490	325		600	490	325	
Noise dB(A) at 620 m³/h and 195 Pa								
Supply air L_{WA} (sound power)	78	n/a	n/a		78	n/a	n/a	
Extract air L_{WA} (sound power)	70	n/a	n/a		70	n/a	n/a	
Radiation L_{PA} at 1 m	54	n/a	n/a		54	n/a	n/a	
Power consumption fans 2xW	140	94	65		140	94	65	
Standby power consumption	< 1 W				< 1 W			
Voltage/Frequency	1~, 230 V, 50 Hz				1~, 230 V, 50 Hz			
Rated current A – Ventilation	3.0				3.0			
– Preheating	11.0				11.0			
– max. total	14.0				14.0			
Electric preheater kW	2.4				2.4			
Heat output/post-heating element kW	–				2.8 (at 60/40 °C) / 2.6 (at 50/40 °C) / 1.6 (at 40/30 °C)			
Summer bypass	automatic (adjustable), with heat exchanger cover				automatic (adjustable), with heat exchanger cover			
Wiring diagram no.	1370				1370			
Temperature operating range	–20 °C to +40 °C				–20 °C to +40 °C			
Installation temperature	+5 °C to +40 °C				+5 °C to +40 °C			
Connection PWW heating element	–				IG 1/2"			
Weight approx. kg	172				175			

¹⁾ Values based on operating ranges defined according to PHI (Passive House Institute).

KWL EC 1200 S



KWL EC 1200 S with base cover (accessories)



Dimensions KWL EC 1200 S

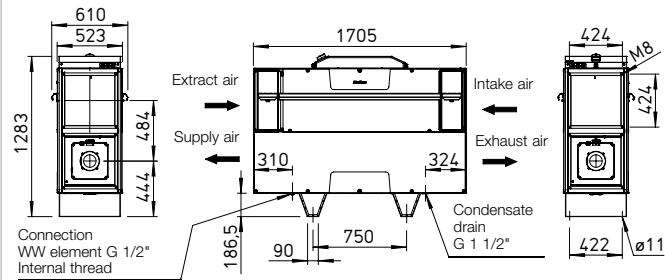

All Dimensions in mm



Central units with heat recovery for compact and space-saving floor installation (floor standing).

With a wide range of residential, commercial and industrial applications.

Independently certified hygiene properties and energy efficiency according to VDI 6022 and the passive house standard. Unit construction and unit components fulfil the general hygiene requirements according to VDI 6022. Optionally available with integrated warm water heating element.

■ Casing

Double-walled, made of galvanised steel sheet, with 30 mm heat and sound insulation on all sides. Inspection openings for filter replacement fastened to both side panels with screws. Both side walls can be completely dismantled for free access to all components. The unit is suitable for floor installation (standing) indoors. Vibration dampers can be underlaid (on-site) to prevent the direct transmission of vibrations and structure-borne noise to building parts.

■ Heat exchanger

Large cross counterflow heat exchanger made of aluminium with heat recovery efficiency of up to 90 %. Dismantling possible in just a few simple steps.

■ Fans

Two low-noise high-performance EC fans with backward-curved impellers guarantee maximum energy efficiency. The special control technology enables constant volume control or constant pressure control.

■ Ducts

Installation-friendly connection of intake, exhaust, extract and supply air through pipe or duct system NW 355 mm. The floor-standing unit can be rotated 180° for installation so that intake air and exhaust air as well as extract air and supply air connections can be on the left or right sides.

■ Condensate connection

The unit contains a stainless steel condensate tray with a condensate drain below. Ball siphon included in delivery. On-site connection to drain pipe.

■ Air filter

Standard equipment: Clean intake air supply via ISO ePM₁ 55% filter (F7). The heat exchanger requires a ISO ePM₁₀ 50% filter (M5) on the extract air side. All filters are pressure-controlled and exchangeable in just a few simple steps.

■ Summer operation

Standard equipment with automatic bypass function for maximum comfort.

■ Heat exchanger anti-icing protection

An electric preheating element heats the intake air at very low outdoor temperatures. Thus, it prevents the heat exchanger from icing up and guarantees its safe functioning and optimal heat recovery during the entire heating period.

■ Power control

- The comfort control element with graphic display and user-friendly menu navigation, which is included in the delivery, enables the following functions:
- Control directly via touchscreen.
 - Freely definable operating points within the entire range of the performance curve.
 - Selection between constant volume control or constant pressure control.
 - Demand-oriented ventilation using CO₂, VOC (mixed gas) or humidity sensor.
 - Building control system via ModBus (RS 485, TCP/IP).
 - Initial commissioning (automatic determination of the system performance curve).
 - Control of external shutters.
 - Connection of a fire alarm contact.
 - Weekly or daily programme.
 - Pressure monitoring of filter contamination.
 - Indication of necessary filter replacement, operating status, error messages.
 - Different access levels.

■ Electrical connection

Easily accessible terminal box on top of the casing. The isolator/main switch can be controlled from below the unit for maintenance work and it can be locked with a padlock to prevent unauthorised access.

■ Post-heating Type KWL EC Pro WW

The integrated warm water heating element guarantees the convenient and energy-efficient post-heating of supply air. The setpoint temperature is simply set in the control element. The hydraulic unit (Type WSH HE 24 V (0-10V), accessories) is recommended for controlling the warm water heat exchanger.

■ Reference

The ventilation unit design according to VDI 6022 requires the use of VDI 6022-compliant air filters. The use of original replacement air filters is therefore mandatory.

■ Replacement air filter

- 1 pc. ISO ePM₁₀ 50% (M5) ELF-KWL 1200 S/5 VDI No.08347
- 1 pc. ISO ePM₁ 55% (F7) ELF-KWL 1200 S/7 VDI No.08348

■ Other accessories Page

KWL peripherals	144 ff.
– Air distribution systems	158 ff.
– Further overview, control lines	162 f.

Accessory details

Ventilation grilles, ducts, fittings	
roof outlets	553 ff.
extract air elements	566 ff.

Performance curve KWL EC 1200 S

Frequency		Hz	Tot.	125	250	500	1k	2k	4k	8k
L_{WA}	Extract air	dB(A)	62	46	55	60	53	53	42	32
L_{WA}	Supply air	dB(A)	76	53	63	71	69	73	66	62
L_{PA}	Radiation	dB(A)	53	40	47	48	49	47	37	30

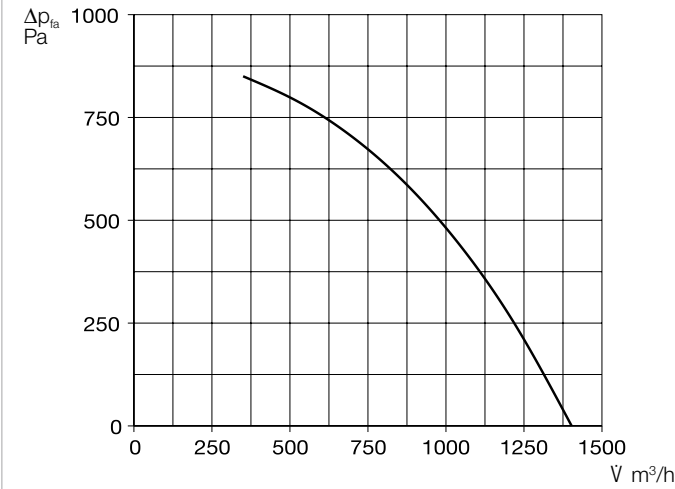

Included in delivery

Surface comfort control element
User-friendly control via self-explanatory graphic elements with clear text directly on the touchscreen. Control line (10 metres) included in delivery, other lengths available (ALB EC-SK, accessories).
Dim. mm (WxHxD) 115x80x25



Control element with connection cable (10 m) included in the scope of delivery. Dim. mm (WxHxD) 115 x 80 x 25

Accessories for Type Pro WW

Hydraulic unit
WHSH HE 24 V (0-10 V) No. 08318
Controls the water temperature of the PWW heating element using a three-way valve actuator 24 V (0-10 V) and thus the heat output transferred to the air. Delivered as a complete unit, incl. VL-/RL temperature display, circulating pump and flexible connection hoses.



Accessories for all types

Room sensor – Air quality

AIR1/KWL-VOC 0-10V No. 20250
AIR1/KWL-CO2 0-10V No. 20251
AIR1/KWL-FTF 0-10V No. 20252
For measuring the CO₂, mixed gas (VOC) concentration or relative room air humidity. A maximum of one sensor can be connected.
Dim. mm (W x H x D) 85 x 85 x 27



Room sensor – Temperature

TFR-ALB/KWL No. 07277
For measuring the room temperature and controlling the ventilation unit according to the set value. Incl. 20 m control line. Maximum total of one sensor can be connected.
Dim. mm (W x H x D) 80 x 80 x 25



Transition piece – Symmetrical

KWL-ÜS 1200 S No. 08349
From unit flange to round duct systems.

Flexible connecting sleeve

FM 355 No. 01675
For acoustic decoupling, incl. 2 pcs. hose clamps.

Duct shutter, motorised

RVM 355 No. 02579
Prevents cold draughts when the unit is at a standstill. Automatic function through fan operation, with mounted spring return motor (outside of air flow). Installation in any position.

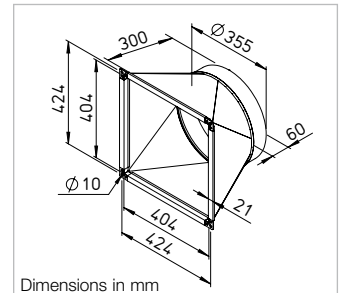

Dimensions in mm

Angle flange ring

FR 355 No. 01205
Made of galvanised steel sheet, for duct connection.

Base cover

KWL-SB 1200 S No. 09316
Made of galvanised steel sheet.



Technical data	KWL EC 1200 S KWL EC 1200 S Pro		Ref. no. 08345	KWL EC 1200 S KWL EC 1200 S Pro WW		Ref. no. 08346
For floor-standing installation						
Flow rate at level¹⁾						
Supply air/extract V m ³ /h approx.	2	1		2	1	
	1300	350		1300	350	
Noise dB(A) at 1300 m³/h and 75 Pa						
Supply air L_{WA} (sound power)	76	n/a		76	n/a	
Extract air L_{WA} (sound power)	62	n/a		62	n/a	
Radiation L_{PA} at 1 m	53	n/a		53	n/a	
Power consumption fans 2xW	375	80		375	80	
Standby power consumption	< 1 W			< 1 W		
Voltage/Frequency	3N~, 400 V, 50 Hz			3N~, 400 V, 50 Hz		
Rated current A – Ventilation	5.0 / – / –			5.0 / – / –		
– Preheating	– / 12.1 / 12.1			– / 12.1 / 12.1		
– max. total	5.0 / 12.1 / 12.1			5.0 / 12.1 / 12.1		
Electric preheater kW	4.2			4.2		
Heat output/post-heating element kW	–			2.8 (at 60/40 °C) / 2.6 (at 50/40 °C) / 1.6 (at 40/30 °C)		
Summer bypass	automatic (adjustable), with heat exchanger cover			automatic (adjustable), with heat exchanger cover		
Wiring diagram no.	1370			1370		
Temperature operating range	–20 °C to +40 °C			–20 °C to +40 °C		
Installation temperature	+5 °C to +40 °C			+5 °C to +40 °C		
Connection PWW heating element	–			IG 1/2"		
Weight approx. kg	250			256		

¹⁾ Values based on operating ranges defined according to PHI (Passive House Institute).

KWL EC 1800 S



KWL EC 1800 S with base cover (accessories)



Dimensions KWL EC 1800 S

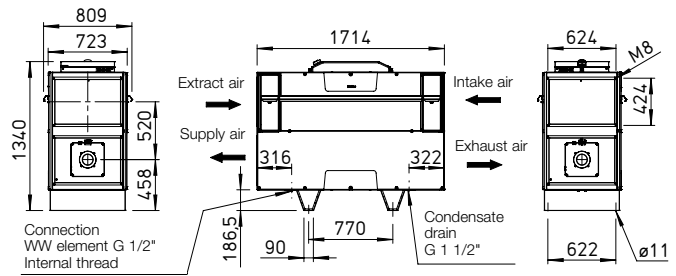

All Dimensions in mm



Central units with heat recovery for compact and space-saving floor installation (floor standing).

With a wide range of residential, commercial and industrial applications.

Independently certified hygiene properties and energy efficiency according to VDI 6022 and the passive house standard. Unit construction and unit components fulfil the general hygiene requirements according to VDI 6022. Optionally available with integrated warm water heating element.

■ Casing

Double-walled, made of galvanised steel sheet, with 30 mm heat and sound insulation on all sides. Inspection openings for filter replacement fastened to both side panels with screws. Both side walls can be completely dismantled for free access to all components. The unit is suitable for floor installation (standing) indoors. Vibration dampers can be underlaid (on-site) to prevent the direct transmission of vibrations and structure-borne noise to building parts.

■ Heat exchanger

Large cross counterflow heat exchanger made of aluminium with heat recovery efficiency of up to 90 %. Dismantling possible in just a few simple steps.

■ Fans

Two low-noise high-performance EC fans with backward-curved impellers guarantee maximum energy efficiency. The special control technology enables constant volume control or constant pressure control.

■ Ducts

Installation-friendly connection of intake, exhaust, extract and supply air through pipe or duct system NW 400 mm. The floor-standing unit can be rotated 180° for installation so that intake air and exhaust air as well as extract air and supply air connections can be on the left or right sides.

■ Condensate connection

The unit contains a stainless steel condensate tray with a condensate drain below. Ball siphon included in delivery. On-site connection to drain pipe.

■ Air filter

Standard equipment: Clean intake air supply via ISO ePM₁ 55% filter (F7). The heat exchanger requires a ISO ePM₁₀ 50% filter (M5) on the extract air side. All filters are pressure-controlled and exchangeable in just a few simple steps.

■ Summer operation

Standard equipment with automatic bypass function for maximum comfort.

■ Heat exchanger anti-icing protection

An electric preheating element heats the intake air at very low outdoor temperatures. Thus, it prevents the heat exchanger from icing up and guarantees its safe functioning and optimal heat recovery during the entire heating period.

■ Power control

- The comfort control element with graphic display and user-friendly menu navigation, which is included in the delivery, enables the following functions:
- Control directly via touchscreen.
 - Freely definable operating points within the entire range of the performance curve.
 - Selection between constant volume control or constant pressure control.
 - Demand-oriented ventilation using CO₂, VOC (mixed gas) or humidity sensor.
 - Building control system via ModBus (RS 485, TCP/IP).
 - Initial commissioning (automatic determination of the system performance curve).
 - Control of external shutters.
 - Connection of a fire alarm contact.
 - Weekly or daily programme.
 - Pressure monitoring of filter contamination.
 - Indication of necessary filter replacement, operating status, error messages.
 - Different access levels.

■ Electrical connection

Easily accessible terminal box on top of the casing. The isolator/main switch can be controlled from below the unit for maintenance work and it can be locked with a padlock to prevent unauthorised access.

■ Post-heating Type KWL EC Pro WW

The integrated warm water heating element guarantees the convenient and energy-efficient post-heating of supply air. The setpoint temperature is simply set in the control element. The hydraulic unit (Type WHSH HE 24 V (0-10V), accessories) is recommended for controlling the warm water heat exchanger.

■ Reference

The ventilation unit design according to VDI 6022 requires the use of VDI 6022-compliant air filters. The use of original replacement air filters is therefore mandatory.

■ Replacement air filter

- 1 pc. ISO ePM₁₀ 50% (M5) ELF-KWL 1800 S/5 VDI No.08258
- 1 pc. ISO ePM₁ 55% (F7) ELF-KWL 1800 S/7 VDI No.08259

■ Other accessories Page

KWL peripherals	144 ff.
– Air distribution systems	158 ff.
– Further overview, control lines	162 f.

Accessory details

Ventilation grilles, ducts, fittings	
roof outlets	553 ff.
extract air elements	566 ff.

Performance curve KWL EC 1800 S

Frequency		Hz	Tot.	125	250	500	1k	2k	4k	8k
L _{WA}	Extract air	dB(A)	61	54	58	51	52	49	38	14
L _{WA}	Supply air	dB(A)	72	61	66	63	65	64	56	56
L _{PA} at 1 m	Radiation	dB(A)	52	35	47	43	47	47	37	28

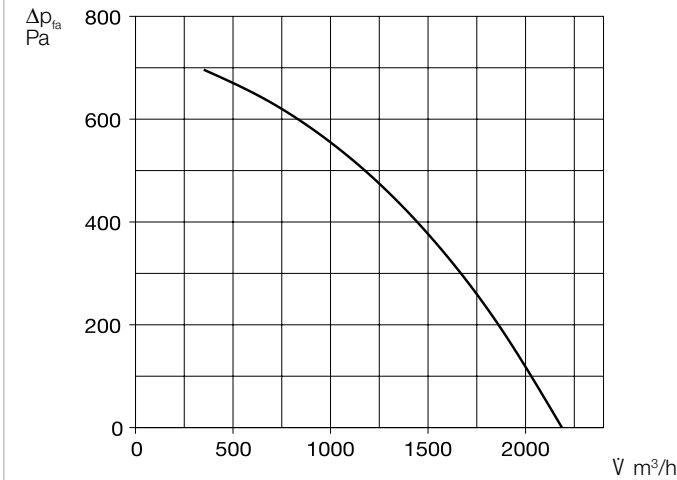

Included in delivery

Surface comfort control element
User-friendly control via self-explanatory graphic elements with clear text directly on the touchscreen. Control line (10 metres) included in delivery, other lengths available (ALB EC-SK, accessories).
Dim. mm (WxHxD) 115x80x25



Control element with connection cable (10 m) included in the scope of delivery. Dim. mm (WxHxD) 115 x 80 x 25

Accessories for Type Pro WW

Hydraulic unit
WHSH HE 24 V (0-10 V) No. 08318
Controls the water temperature of the PWW heating element using a three-way valve actuator 24 V (0-10 V) and thus the heat output transferred to the air. Delivered as a complete unit, incl. VL-/RL temperature display, circulating pump and flexible connection hoses.



Accessories for all types

Room sensor – Air quality

AIR1/KWL-VOC 0-10V No. 20250
AIR1/KWL-CO2 0-10V No. 20251
AIR1/KWL-FTF 0-10V No. 20252
For measuring the CO₂, mixed gas (VOC) concentration or relative room air humidity. A maximum of one sensor can be connected.
Dim. mm (W x H x D) 85 x 85 x 27



Room sensor – Temperature

TFR-ALB/KWL No. 07277
For measuring the room temperature and controlling the ventilation unit according to the set value. Incl. 20 m control line. Maximum total of one sensor can be connected.
Dim. mm (W x H x D) 80 x 80 x 25



Transition piece – Symmetrical

KWL-ÜS 1800 S No. 08340
From unit flange to round duct systems.

Flexible connecting sleeve

FM 400 No. 01676
For acoustic decoupling, incl. 2 pcs. hose clamps.

Duct shutter, motorised

RVM 400 No. 02580
Prevents cold draughts when the unit is at a standstill. Automatic function through fan operation, with mounted spring return motor (outside of air flow). Installation in any position.

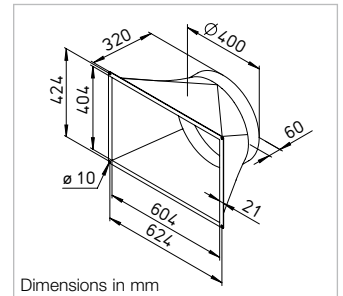

Dimensions in mm

Angle flange ring

FR 400 No. 01206
Made of galvanised steel sheet, for duct connection.

Base cover

KWL-SB 1800 S No. 09317
Made of galvanised steel sheet.



Technical data	KWL EC 1800 S KWL EC 1800 S Pro			Ref. no. 08329	KWL EC 1800 S KWL EC 1800 S Pro WW			Ref. no. 08330
For floor-standing installation								
Flow rate at level¹⁾	③	②	①		③	②	①	
Supply air/extract V m ³ /h approx.	1400	1070	810		1400	1070	810	
Noise dB(A) at 1400 m³/h and 245 Pa								
Supply air L _{WA} (sound power)	72	n/a	n/a		72	n/a	n/a	
Extract air L _{WA} (sound power)	61	n/a	n/a		61	n/a	n/a	
Radiation L _{PA} at 1 m	52	n/a	n/a		52	n/a	n/a	
Power consumption fans 2xW	315	225	165		315	225	165	
Standby power consumption	< 1 W				< 1 W			
Voltage/Frequency	3N~, 400 V, 50 Hz				3N~, 400 V, 50 Hz			
Rated current A – Ventilation	3.9 / – / –				3.9 / – / –			
– Preheating	6.6 / 6.6 / 6.6				6.6 / 6.6 / 6.6			
– max. total	10.5 / 6.6 / 6.6				10.5 / 6.6 / 6.6			
Electric preheater kW	4.5				4.5			
Heat output/post-heating element kW	–				5.2 (at 60/40 °C) / 4.9 (at 50/40 °C) / 3.0 (at 40/30 °C)			
Summer bypass	automatic (adjustable), with heat exchanger cover				automatic (adjustable), with heat exchanger cover			
Wiring diagram no.	1370				1370			
Temperature operating range	–20 °C to +40 °C				–20 °C to +40 °C			
Installation temperature	+5 °C to +40 °C				+5 °C to +40 °C			
Connection PWW heating element	–				IG 1/2"			
Weight approx. kg	290				295			

¹⁾ Values based on operating ranges defined according to PHI (Passive House Institute).

KWL EC 2600 S



KWL EC 2600 S with base cover (accessories)



Dimensions KWL EC 2600 S

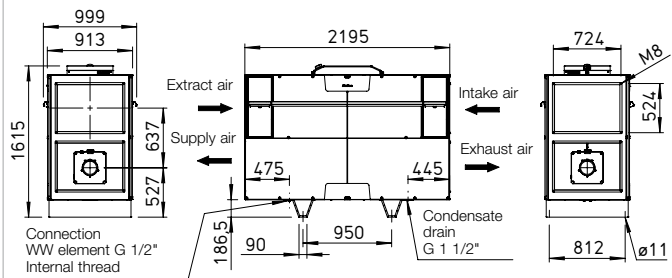

All Dimensions in mm



Central units with heat recovery for compact and space-saving floor installation (floor standing).

With a wide range of residential, commercial and industrial applications.

Independently certified hygiene properties and energy efficiency according to VDI 6022 and the passive house standard. Unit construction and unit components fulfil the general hygiene requirements according to VDI 6022. Optionally available with integrated warm water heating element.

■ Casing

Double-walled, made of galvanised steel sheet, with 30 mm heat and sound insulation on all sides. Inspection openings for filter replacement fastened to both side panels with screws. Both side walls can be completely dismantled for free access to all components. The unit is suitable for floor installation (standing) indoors. Vibration dampers can be underlaid (on-site) to prevent the direct transmission of vibrations and structure-borne noise to building parts.

■ Heat exchanger

Large cross counterflow heat exchanger made of aluminium with heat recovery efficiency of up to 90 %. Dismantling possible in just a few simple steps.

■ Fans

Two low-noise high-performance EC fans with backward-curved impellers guarantee maximum energy efficiency. The special control technology enables constant volume control or constant pressure control.

■ Ducts

Installation-friendly connection of intake, exhaust, extract and supply air through pipe or duct system NW 560 mm. The floor-standing unit can be rotated 180° for installation so that intake air and exhaust air as well as extract air and supply air connections can be on the left or right sides.

■ Condensate connection

The unit contains a stainless steel condensate tray with a condensate drain below. Ball siphon included in delivery. On-site connection to drain pipe.

■ Air filter

Standard equipment: Clean intake air supply via ISO ePM₁ 55% filter (F7). The heat exchanger requires a ISO ePM₁₀ 50% filter (M5) on the extract air side. All filters are pressure-controlled and exchangeable in just a few simple steps.

■ Summer operation

Standard equipment with automatic bypass function for maximum comfort.

■ Heat exchanger anti-icing protection

An electric preheating element heats the intake air at very low outdoor temperatures. Thus, it prevents the heat exchanger from icing up and guarantees its safe functioning and optimal heat recovery during the entire heating period.

■ Power control

- The comfort control element with graphic display and user-friendly menu navigation, which is included in the delivery, enables the following functions:
- Control directly via touchscreen.
 - Freely definable operating points within the entire range of the performance curve.
 - Selection between constant volume control or constant pressure control.
 - Demand-oriented ventilation using CO₂, VOC (mixed gas) or humidity sensor.
 - Building control system via ModBus (RS 485, TCP/IP).
 - Initial commissioning (automatic determination of the system performance curve).
 - Control of external shutters.
 - Connection of a fire alarm contact.
 - Weekly or daily programme.
 - Pressure monitoring of filter contamination.
 - Indication of necessary filter replacement, operating status, error messages.
 - Different access levels.

■ Electrical connection

Easily accessible terminal box on top of the casing. The isolator/main switch can be controlled from below the unit for maintenance work and it can be locked with a padlock to prevent unauthorised access.

■ Post-heating Type KWL EC Pro WW

The integrated warm water heating element guarantees the convenient and energy-efficient post-heating of supply air. The setpoint temperature is simply set in the control element. The hydraulic unit (Type WHSH HE 24 V (0-10V), accessories) is recommended for controlling the warm water heat exchanger.

■ Reference

The ventilation unit design according to VDI 6022 requires the use of VDI 6022-compliant air filters. The use of original replacement air filters is therefore mandatory.

■ Replacement air filter

- 1 pc. ISO ePM₁₀ 50% (M5) ELF-KWL 2600 S/5 VDI No.08308
- 1 pc. ISO ePM₁ 55% (F7) ELF-KWL 2600 S/7 VDI No.08325

■ Other accessories Page

KWL peripherals	144 ff.
– Air distribution systems	158 ff.
– Further overview, control lines	162 f.

Accessory details

Ventilation grilles, ducts, fittings	
roof outlets	553 ff.
extract air elements	566 ff.

Performance curve KWL EC 2600 S

Frequency		Hz	Tot.	125	250	500	1k	2k	4k	8k
L _{WA}	Extract air	dB(A)	62	52	58	56	54	49	43	27
L _{WA}	Supply air	dB(A)	77	67	69	69	72	67	60	51
L _{PA} at 1 m	Radiation	dB(A)	52	37	48	46	46	43	36	23

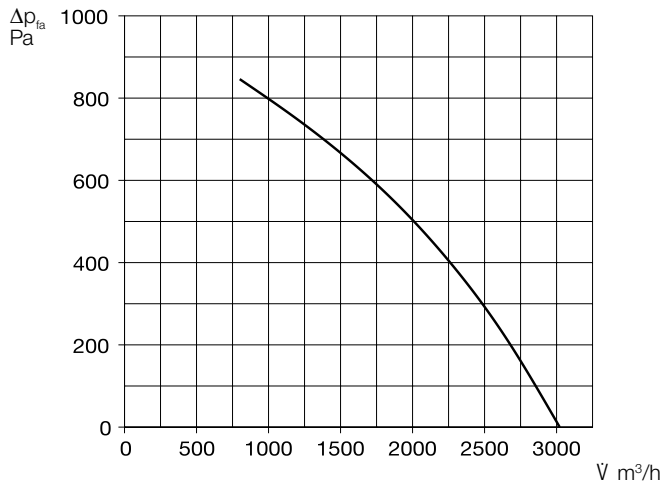

Included in delivery

Surface comfort control element
User-friendly control via self-explanatory graphic elements with clear text directly on the touchscreen. Control line (10 metres) included in delivery, other lengths available (ALB EC-SK, accessories).
Dim. mm (WxHxD) 115x80x25



Control element with connection cable (10 m) included in the scope of delivery. Dim. mm (WxHxD) 115 x 80 x 25

Accessories for Type Pro WW

Hydraulic unit
WHSH HE 24 V (0-10 V) No. 08318
Controls the water temperature of the PWW heating element using a three-way valve actuator 24 V (0-10 V) and thus the heat output transferred to the air. Delivered as a complete unit, incl. VL-/RL temperature display, circulating pump and flexible connection hoses.



Accessories for all types

Room sensor – Air quality

AIR1/KWL-VOC 0-10V No. 20250
AIR1/KWL-CO2 0-10V No. 20251
AIR1/KWL-FTF 0-10V No. 20252
For measuring the CO₂, mixed gas (VOC) concentration or relative room air humidity. A maximum of one sensor can be connected.
Dim. mm (W x H x D) 85 x 85 x 27



Room sensor – Temperature

TFR-ALB/KWL No. 07277
For measuring the room temperature and controlling the ventilation unit according to the set value. Incl. 20 m control line. Maximum total of one sensor can be connected.
Dim. mm (W x H x D) 80 x 80 x 25



Transition piece – Symmetrical

KWL-ÜS 2600 S No. 08341
From unit flange to round duct systems.

Flexible connecting sleeve

FM 560 No. 01679
For acoustic decoupling, incl. 2 pcs. hose clamps.

Duct shutter, motorised

RVM 560 No. 02583
Prevents cold draughts when the unit is at a standstill. Automatic function through fan operation, with mounted spring return motor (outside of air flow). Installation in any position.

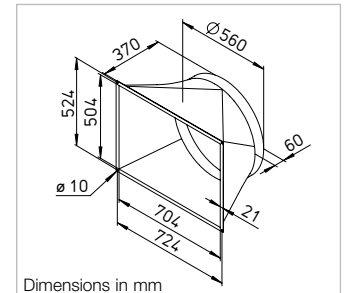

Dimensions in mm

Angle flange ring

FR 560 No. 01209
Made of galvanised steel sheet, for duct connection.

Base cover

KWL-SB 2600 S No. 09318
Made of galvanised steel sheet.



Technical data	KWL EC 2600 S KWL EC 2600 S Pro			Ref. no. 08331	KWL EC 2600 S KWL EC 2600 S Pro WW			Ref. no. 08332
	③	②	①		③	②	①	
For floor-standing installation								
Flow rate at level¹⁾ Supply air/extract V m ³ /h approx.	2065	1450	840		2065	1450	840	
Noise dB(A) at 2100 m³/h and 275 Pa								
Supply air L _{WA} (sound power)	77	n/a	n/a		77	n/a	n/a	
Extract air L _{WA} (sound power)	62	n/a	n/a		62	n/a	n/a	
Radiation L _{PA} at 1 m	52	n/a	n/a		52	n/a	n/a	
Power consumption fans 2xW	450	295	175		450	295	175	
Standby power consumption	< 1 W				< 1 W			
Voltage/Frequency	3N~, 400 V, 50 Hz				3N~, 400 V, 50 Hz			
Rated current A – Ventilation	2.3 / 2.3 / 2.3				2.3 / 2.3 / 2.3			
– Preheating	10.05 / 10.05 / 10.05				10.05 / 10.05 / 10.05			
– max. total	12.35 / 12.35 / 12.35				12.35 / 12.35 / 12.35			
Electric preheater kW	6.8				6.8			
Heat output/post-heating element kW	–				9.3 (at 60/40 °C) / 8.5 (at 50/40 °C) / 5.3 (at 40/30 °C)			
Summer bypass	automatic (adjustable), with heat exchanger cover				automatic (adjustable), with heat exchanger cover			
Wiring diagram no.	1370				1370			
Temperature operating range	–20 °C to +40 °C				–20 °C to +40 °C			
Installation temperature	+5 °C to +40 °C				+5 °C to +40 °C			
Connection PWW heating element	–				IG 1/2"			
Weight approx. kg	490				500			

¹⁾ Values based on operating ranges defined according to PHI (Passive House Institute).

Relaxed ventilation with KWL® YOGA.



Are your buildings fit for the future? Whether at school or in public buildings, at work or in leisure time – our new, decentralised ventilation units with heat recovery KWL Yoga make it easy to achieve the best indoor air quality.

The extremely compact design and simple installation without an air distribution system also make KWL Yoga perfect for renovation projects. Three available unit sizes for flow rates up to 400, 700 and 1000 m³/h, various equipment versions and the

exclusive Style design variant are only some of the highlights of KWL Yoga.

All advantages at a glance:



- Practical: Simple **maintenance** through freely accessible inspection flaps on the underside of the unit.
- Flexible: Three available unit sizes for flow rates up to **400, 700 and 1000 m³/h**.
- Diverse: Ideal for use in **schools, offices and public facilities**.
- Guaranteed: **Best air quality** with low CO₂ concentration promotes receptiveness and performance.
- Customised: 2 casing variants with 6 different **equipment options**: KWL Yoga and KWL Yoga Style.

■ KWL Yoga

Compact wall units from 400 to 1000 m³/h in two versions: KWL Yoga and KWL Yoga Style.



136ff

KWL YOGA / KWL YOGA Style 400



Performance curve KWL YOGA / KWL YOGA Style 400

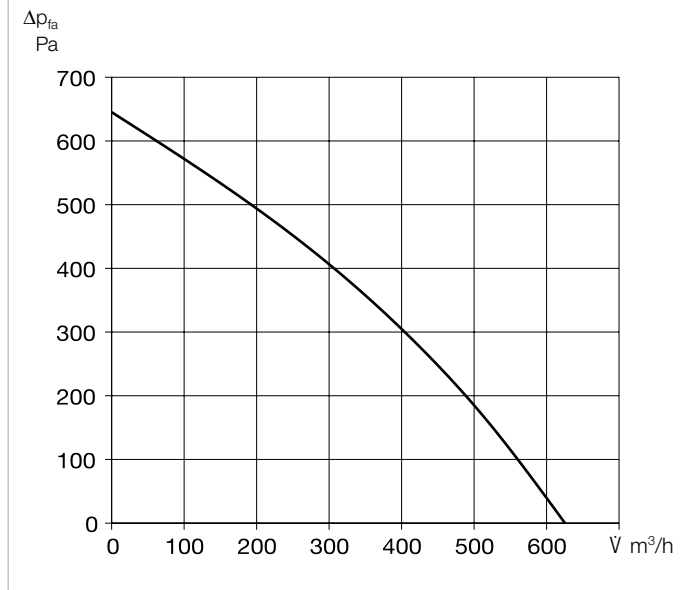

Decentralised compact ventilation units with heat recovery for the supply and extract ventilation of individual rooms, such as classrooms, recreation rooms, offices, commercial units, medical practices and many more. Equipped with highly-efficient aluminium heat exchangers and energy-saving EC motors. Automatic shutters for intake and exhaust prevent cold draughts when the fans are deactivated. The flow-optimised supply air grille allows draught-free ventilation, even in large rooms, through the optimal use of the Coanda effect. Includes a touch control element for easy operation and configuration of unit functions.

■ **Casing**

Made of galvanised steel sheet, all casing parts are painted white/powder-coated inside and outside. The double-walled unit casing is equipped with 40 mm thermal and sound insulation on all sides. Easy installation and maintenance due to large inspection panel.

■ **Installation**

Ceiling installation is carried out using the vibration-damping fastening elements included in the scope of delivery. Alternatively, combined wall-ceiling installation is possible with the wall bracket set (Ref. no. 40067).

■ **Heat exchanger**

Large aluminium cross counterflow heat exchanger with up to 90% heat

recovery efficiency. Dismantling is possible in a few steps.

■ **Fans**

Two low-noise, high-performance EC fans with backward curved impellers for maximum energy efficiency.

■ **Sensor system**

Integrated CO₂ sensor system. Alternatively, this can be replaced by an external sensor (VOC, CO₂ or humidity) positioned in the room. KWL Yoga can also be controlled with a motion sensor (combination not possible!) instead of the sensors.

■ **Air flow**

Supply air on front side, two extract

air openings on the underside of the unit. Intake and exhaust air connectors are equipped with spring-loaded shutters.

■ **Condensate connection**

Condensate drain at the bottom (wall side), optionally via ball siphon in surface-mounted or flush-mounted design or via condensate pump.

■ **Air filter**

Clean intake air flow via ISO ePM₁ 60% filter (F7). Two bag filters for extract air: ISO Coarse 60% (G4); optionally available: ISO ePM₁₀ 60% (M5).

■ **Summer operation**

Equipped with automatic bypass function (bypassing the heat ex-

	Without electrical preheater/ without electrical after-heater	Without electrical preheater/ with electrical after-heater	Without electrical preheater/ with warm water after-heater	With electrical preheater/ without after-heater	With electrical preheater/ with electrical after-heater
	KWL YOGA 400 Ref. no. 40007	KWL YOGA 400 EN Ref. no. 40009	KWL YOGA 400 WW Ref. no. 40011	KWL YOGA 400 EV Ref. no. 40013	KWL YOGA 400 EV/EN Ref. no. 40015
	KWL YOGA Style 400 Ref. no. 40008	KWL YOGA Style 400 EN Ref. no. 40010	KWL YOGA Style 400 WW Ref. no. 40012	KWL YOGA Style 400 EV Ref. no. 40014	KWL YOGA Style 400 EV/EN Ref. no. 40016
Intake/exhaust air connector diameter	250	250	250	250	250
Air volume V m³/h (Min. - Max.)	169 - 625	169 - 625	169 - 625	169 - 625	169 - 625
Radiation L _{PA} dB(A) in 1 m / 3 m (at 0 Pa)					
- 169 m³/h	27 / 20	27 / 20	27 / 20	27 / 20	27 / 20
- 316 m³/h	31 / 24	31 / 24	31 / 24	31 / 24	31 / 24
- 415 m³/h	35 / 29	35 / 29	35 / 29	35 / 29	35 / 29
- 625 m³/h	45 / 38	45 / 38	45 / 38	45 / 38	45 / 38
Maximum power consumption W					
- fans	2 x 170	2 x 170	2 x 170	2 x 170	2 x 170
- el. preheater / after-heater	--- / ---	--- / 1500	--- / ---	1500 / ---	1500 / 1500
- total	350	1850	350	1850	3350
Rated current A					
- fans	2 x 1.20	2 x 1.20	2 x 1.20	2 x 1.20	2 x 1.20
- el. preheater / after-heater	--- / ---	--- / 6.53	--- / ---	6.53 / ---	6.53 / 6.53
- total	2.45	8.98	2.45	8.98	15.51
Voltage / frequency	1~, 230 V, 50 Hz	1~, 230 V, 50 Hz	1~, 230 V, 50 Hz	1~, 230 V, 50 Hz	1~, 230 V, 50 Hz
Protection category IP	20	20	20	20	20
Temperature operating range °C	-10 to +40	-10 to +40	-10 to +40	-20 to +40	-20 to +40
Installation temperature °C	+5 to +40	+5 to +40	+5 to +40	+5 to +40	+5 to +40
Weight approx. kg	82 (KWL YOGA Style: 92)	83 (KWL YOGA Style: 93)	85 (KWL YOGA Style: 95)	83 (KWL YOGA Style: 93)	84 (KWL YOGA Style: 94)
Wiring diagram no.	1384	1384	1384	1384	1384

Dimensions KWL YOGA 400

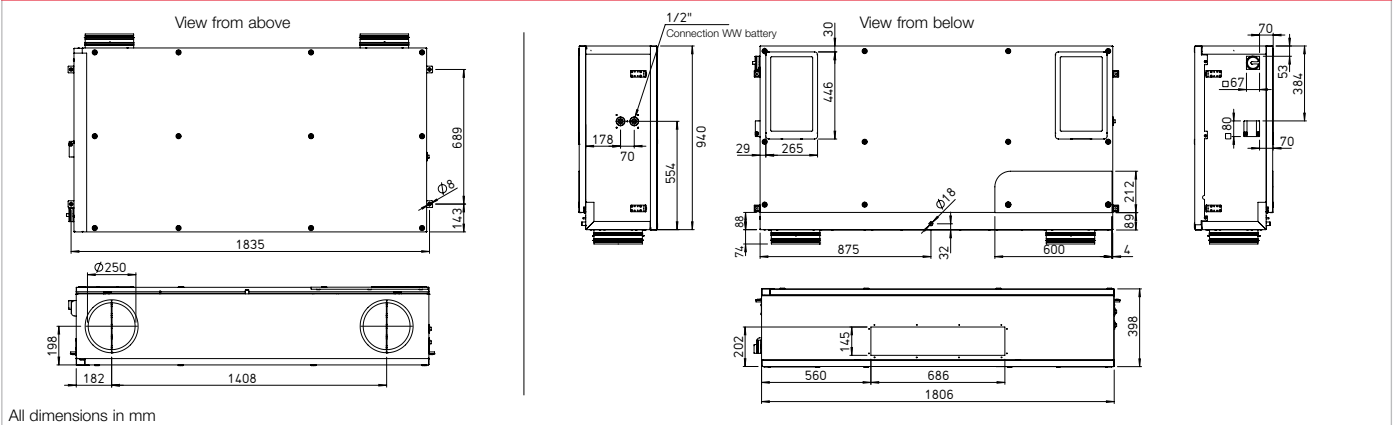

All dimensions in mm

Dimensions KWL YOGA Style 400

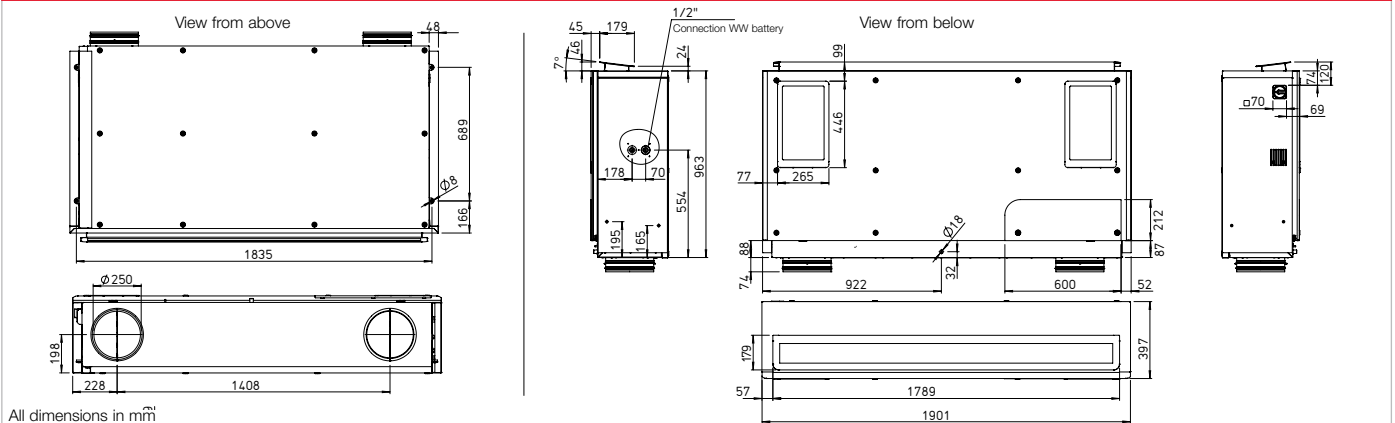

All dimensions in mm

changer to use the cool night air for controlling the room temperature) as standard.

Heat exchanger frost protection

The standard frost monitoring automatically regulates the supply air flow and the built-in electrical preheater, depending on the selected equipment.

After-heater

Unit variants with integrated post-heating (warm water or electrical after-heater) ensure the comfortable and energy-efficient post-heating of supply air. The target supply air temperature is set on the control element. The use of hydraulic unit type WSH HE 24 V (0-10V), (accessories) is recommended for controlling the warm water heating element.

Power control

The included comfort control element with touch functionality and easy menu navigation provide the following functions:

- Demand-oriented ventilation, optionally with CO₂, VOC, or humidity sensor (1 sensor can be connected).
- Initial commissioning (automatic determination of system characteristic curve).
- Fire alarm contact connection.
- Weekly or daily programme.
- Automatic bypass (summer operation: use of cool night air).
- Pressure monitoring of filter contamination.
- Displays required filter replacement.
- 5 password-protected function levels can be configured.
- Control via central building control system possible (ModBus RTU and ModBus TCP, BACnet)
- Including control line cable (10 m)

Electrical connection

After opening the inspection cover, the easily accessible terminal box is located in the side of the casing. The isolator/main switch is located on the outside of the unit for easy maintenance. It can be locked using a padlock to prevent unauthorised access.

Sensors

Infrared motion sensor for detecting the presence of people in the room.

BWM Ref. no. 08323

CO₂ sensor for measuring the CO₂ concentration.

AIR1/KWL-VOC 0-10V No. 20250

VOC sensor for measuring the mixed gas concentration (VOC).

AIR1/KWL-CO₂ 0-10V No. 20251

Humidity-temperature sensor for measuring the relative air humidity.

AIR1/KWL-FTF 0-10V No. 20252

Installation accessories

Flush-mounted/wall-mounted siphon

KWL-KS WE Ref. no. 40064

Ball-tube siphon

KWL-KS Ref. no. 40065

Condensate pump

KWL-KP Ref. no. 40066

Wall bracket console set for combined wall-/ceiling installation.

KWL YOGA-WH Ref. no. 40067

Hydraulic unit

WSH HE 24V (0-10V) No. 08318

Facade grille, circular

FGR 250 Ref. no. 40181

FGR 315 Ref. no. 40182

Filter

Spare air filter (extract air)

ISO Coarse 60% (G4). Unit = 1 pc.

ELF-KWL YOGA 400/Coarse 60%

Ref. no. 40068

Spare air filter (extract air)

ISO ePM₁₀ 60% (M5). Unit = 1 pc.

ELF-KWL YOGA 400/ePM 10 60%

Ref. no. 40071

Note: 2 extract air filters are required per unit.

Spare air filter (intake air)

ISO ePM₁ 60% (F7). Unit = 1 pc.

ELF-KWL YOGA 400/ePM1 60%

Ref. no. 40074

Important note

Further information on accessories can be found on page 142.

KWL YOGA / KWL YOGA Style 700



Performance curve KWL YOGA / KWL YOGA Style 700

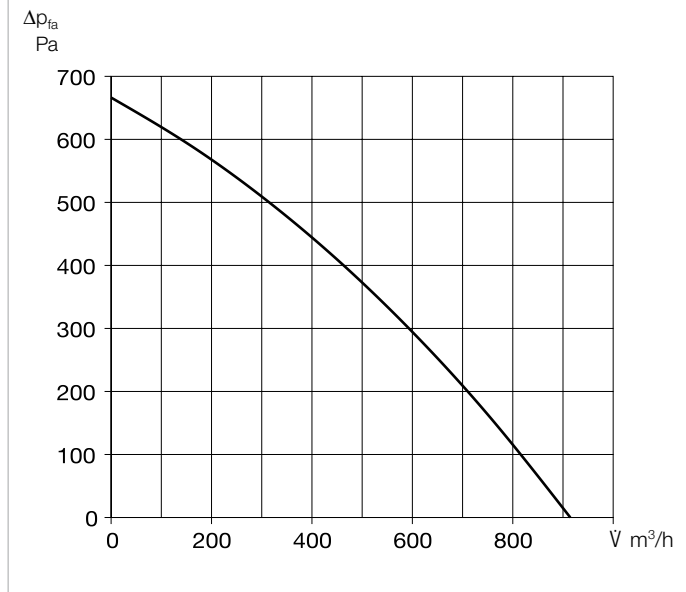

Decentralised compact ventilation units with heat recovery for the supply and extract ventilation of individual rooms, such as classrooms, recreation rooms, offices, commercial units, medical practices and many more. Equipped with highly-efficient aluminium heat exchangers and energy-saving EC motors. Automatic shutters for intake and exhaust prevent cold draughts when the fans are deactivated. The flow-optimised supply air grille allows draught-free ventilation, even in large rooms, through the optimal use of the Coanda effect. Includes a touch control element for easy operation and configuration of unit functions.

- Casing**
 Made of galvanised steel sheet, all casing parts are painted white/powder-coated inside and outside. The double-walled unit casing is equipped with 40 mm thermal and sound insulation on all sides. Easy installation and maintenance due to large inspection panel.
- Installation**
 Ceiling installation is carried out using the vibration-damping fastening elements included in the scope of delivery. Alternatively, combined wall-ceiling installation is possible with the wall bracket set (Ref. no. 40067).
- Heat exchanger**
 Large aluminium cross counterflow heat exchanger with up to 90% heat

recovery efficiency. Dismantling is possible in a few steps.

- Fans**
 Two low-noise, high-performance EC fans with backward curved impellers for maximum energy efficiency.
- Sensor system**
 Integrated CO₂ sensor system. Alternatively, this can be replaced by an external sensor (VOC, CO₂ or humidity) positioned in the room. KWL Yoga can also be controlled with a motion sensor (combination not possible!) instead of the sensors.
- Air flow**
 Supply air on front side, two extract

air openings on the underside of the unit. Intake and exhaust air connectors are equipped with spring-loaded shutters.

- Condensate connection**
 Condensate drain at the bottom (wall side), optionally via ball siphon in surface-mounted or flush-mounted design or via condensate pump.
- Air filter**
 Clean intake air flow via ISO ePM₁ 60% filter (F7). Two bag filters for extract air: ISO Coarse 60% (G4); optionally available: ISO ePM₁₀ 60% (M5).
- Summer operation**
 Equipped with automatic bypass function (bypassing the heat ex-

	Without electrical preheater/ without electrical after-heater	Without electrical preheater/ with electrical after-heater	Without electrical preheater/ with warm water after-heater	With electrical preheater/ without after-heater	With electrical preheater/ with electrical after-heater
	KWL YOGA 700 Ref. no. 40019	KWL YOGA 700 EN Ref. no. 40021	KWL YOGA 700 WW Ref. no. 40023	KWL YOGA 700 EV Ref. no. 40025	KWL YOGA 700 EV/EN Ref. no. 40027
	KWL YOGA Style 700 Ref. no. 40020	KWL YOGA Style 700 EN Ref. no. 40022	KWL YOGA Style 700 WW Ref. no. 40024	KWL YOGA Style 700 EV Ref. no. 40026	KWL YOGA Style 700 EV/EN Ref. no. 40028
Intake/exhaust air connector diameter	315	315	315	315	315
Air volume V m ³ /h (Min. - Max.)	307 - 917	307 - 917	307 - 917	307 - 917	307 - 917
Radiation L _{PA} dB(A) in 1 m / 3 m (at 0 Pa)					
- 307 m ³ /h	26 / 20	26 / 20	26 / 20	26 / 20	26 / 20
- 449 m ³ /h	27 / 21	27 / 21	27 / 21	27 / 21	27 / 21
- 589 m ³ /h	31 / 24	31 / 24	31 / 24	31 / 24	31 / 24
- 917 m ³ /h	42 / 35	42 / 35	42 / 35	42 / 35	42 / 35
Maximum power consumption W					
- fans	2 x 170	2 x 170	2 x 170	2 x 170	2 x 170
- el. preheater / after-heater	--- / ---	--- / 2250	--- / ---	2000 / ---	2000 / 2250
- total	350	2600	350	2350	4600
Rated current A					
- fans	2 x 1.20	2 x 1.20	2 x 1.20	2 x 1.20	2 x 1.20
- el. preheater / after-heater	--- / ---	--- / 9.79	--- / ---	8.7 / ---	8.7 / 9.79
- total	2.45	12.24	2.45	11.15	9.79
Voltage / frequency	1~, 230 V, 50 Hz	1~, 230 V, 50 Hz	1~, 230 V, 50 Hz	1~, 230 V, 50 Hz	3~, 400 V, 50 Hz
Protection category IP	20	20	20	20	20
Temperature operating range °C	-10 to +40	-10 to +40	-10 to +40	-20 to +40	-20 to +40
Installation temperature °C	+5 to +40	+5 to +40	+5 to +40	+5 to +40	+5 to +40
Weight approx. kg	116 (KWL YOGA Style: 126)	117 (KWL YOGA Style: 127)	119 (KWL YOGA Style: 129)	117 (KWL YOGA Style: 127)	118 (KWL YOGA Style: 128)
Wiring diagram no.	1384	1384	1384	1384	1384

KWL YOGA / KWL YOGA Style 1000



Performance curve KWL YOGA / KWL YOGA Style 1000

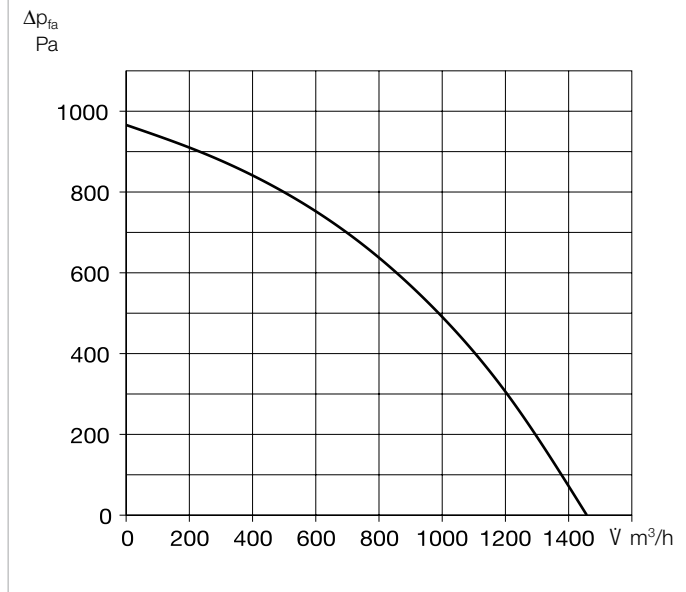

Decentralised compact ventilation units with heat recovery for the supply and extract ventilation of individual rooms, such as classrooms, recreation rooms, offices, commercial units, medical practices and many more. Equipped with highly-efficient aluminium heat exchangers and energy-saving EC motors. Automatic shutters for intake and exhaust prevent cold draughts when the fans are deactivated. The flow-optimised supply air grille allows draught-free ventilation, even in large rooms, through the optimal use of the Coanda effect. Includes a touch control element for easy operation and configuration of unit functions.

■ **Casing**

Made of galvanised steel sheet, all casing parts are painted white/powder-coated inside and outside. The double-walled unit casing is equipped with 40 mm thermal and sound insulation on all sides. Easy installation and maintenance due to large inspection panel.

■ **Installation**

Ceiling installation is carried out using the vibration-damping fastening elements included in the scope of delivery. Alternatively, combined wall-ceiling installation is possible with the wall bracket set (Ref. no. 40067).

■ **Heat exchanger**

Large aluminium cross counterflow heat exchanger with up to 90% heat

recovery efficiency. Dismantling is possible in a few steps.

■ **Fans**

Two low-noise, high-performance EC fans with backward curved impellers for maximum energy efficiency.

■ **Sensor system**

Integrated CO₂ sensor system. Alternatively, this can be replaced by an external sensor (VOC, CO₂ or humidity) positioned in the room. KWL Yoga can also be controlled with a motion sensor (combination not possible!) instead of the sensors.

■ **Air flow**

Supply air on front side, two extract

air openings on the underside of the unit. Intake and exhaust air connectors are equipped with spring-loaded shutters.

■ **Condensate connection**

Condensate drain at the bottom (wall side), optionally via ball siphon in surface-mounted or flush-mounted design or via condensate pump.

■ **Air filter**

Clean intake air flow via ISO ePM₁ 60% filter (F7). Two bag filters for extract air: ISO Coarse 60% (G4); optionally available: ISO ePM₁₀ 60% (M5).

■ **Summer operation**

Equipped with automatic bypass function (bypassing the heat ex-

	Without electrical preheater/ without electrical after-heater	Without electrical preheater/ with electrical after-heater	Without electrical preheater/ with warm water after-heater	With electrical preheater/ without after-heater	With electrical preheater/ with electrical after-heater
	KWL YOGA 1000 Ref. no. 40031	KWL YOGA 1000 EN Ref. no. 40033	KWL YOGA 1000 WW Ref. no. 40035	KWL YOGA 1000 EV Ref. no. 40202	KWL YOGA 1000 EV/EN Ref. no. 40039
	KWL YOGA Style 1000 Ref. no. 40032	KWL YOGA Style 1000 EN Ref. no. 40034	KWL YOGA Style 1000 WW Ref. no. 40036	KWL YOGA Style 1000 EV Ref. no. 40203	KWL YOGA Style 1000 EV/EN Ref. no. 40040
Intake/exhaust air connector diameter	315	315	315	315	315
Air volume V̇ m ³ /h (Min. - Max.)	499 - 1456	499 - 1456	499 - 1456	499 - 1456	499 - 1456
Radiation L _{pa} dB(A) in 1 m / 3 m (at 0 Pa)					
- 499 m ³ /h	24 / 18	24 / 18	24 / 18	24 / 18	24 / 18
- 772 m ³ /h	30 / 24	30 / 24	30 / 24	30 / 24	30 / 24
- 1018 m ³ /h	35 / 29	35 / 29	35 / 29	35 / 29	35 / 29
- 1456 m ³ /h	47 / 41	47 / 41	47 / 41	47 / 41	47 / 41
Maximum power consumption W					
- fans	2 x 395	2 x 395	2 x 385	2 x 395	2 x 395
- el. preheater / after-heater	--- / ---	--- / 3000	--- / ---	2000 / ---	3000 / 3000
- total	800	3800	800	2800	6800
Rated current A					
- fans	2 x 2.4	2 x 2.4	2 x 2.4	2 x 2.4	2 x 2.4
- el. preheater / after-heater	--- / ---	--- / 4.33	--- / ---	8.85 / ---	7.5 / 4.33
- total	4.85	9.18	4.85	13,7	11.83
Voltage / frequency	1~, 230 V, 50 Hz	3~, 400 V, 50 Hz	1~, 230 V, 50 Hz	1~, 230 V, 50 Hz	3~, 400 V, 50 Hz
Protection category IP	20	20	20	20	20
Temperature operating range °C	-10 to +40	-10 to +40	-10 to +40	-17 to +40	-20 to +40
Installation temperature °C	+5 to +40	+5 to +40	+5 to +40	+5 to +40	+5 to +40
Weight approx. kg	139 (KWL YOGA Style: 149)	140 (KWL YOGA Style: 150)	142 (KWL YOGA Style: 152)	140 (KWL YOGA Style: 150)	141 (KWL YOGA Style: 151)
Wiring diagram no.	1384	1384	1384	1384	1384

Dimensions KWL YOGA 1000

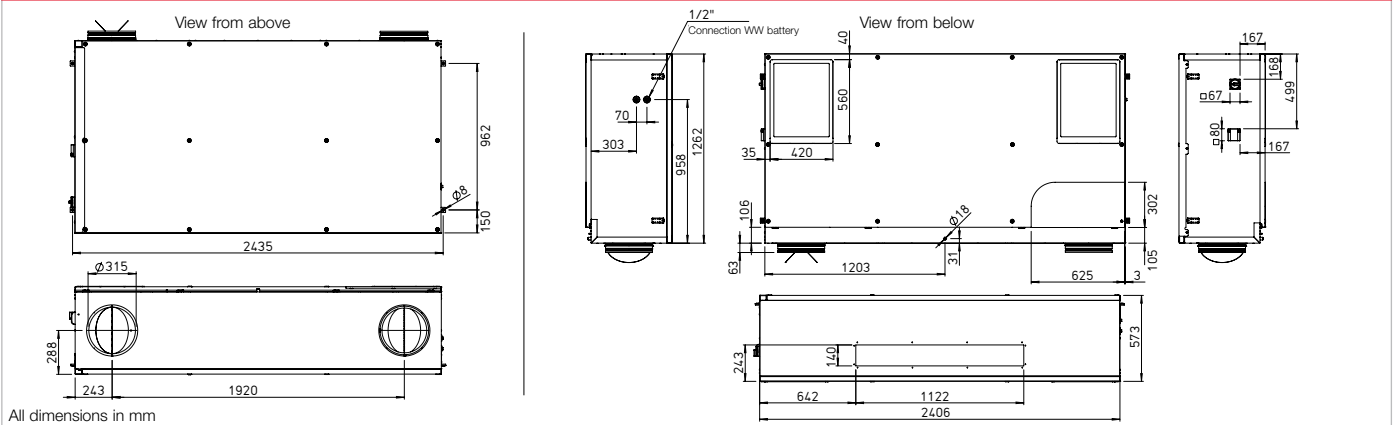

Dimensions WL YOGA Style 1000

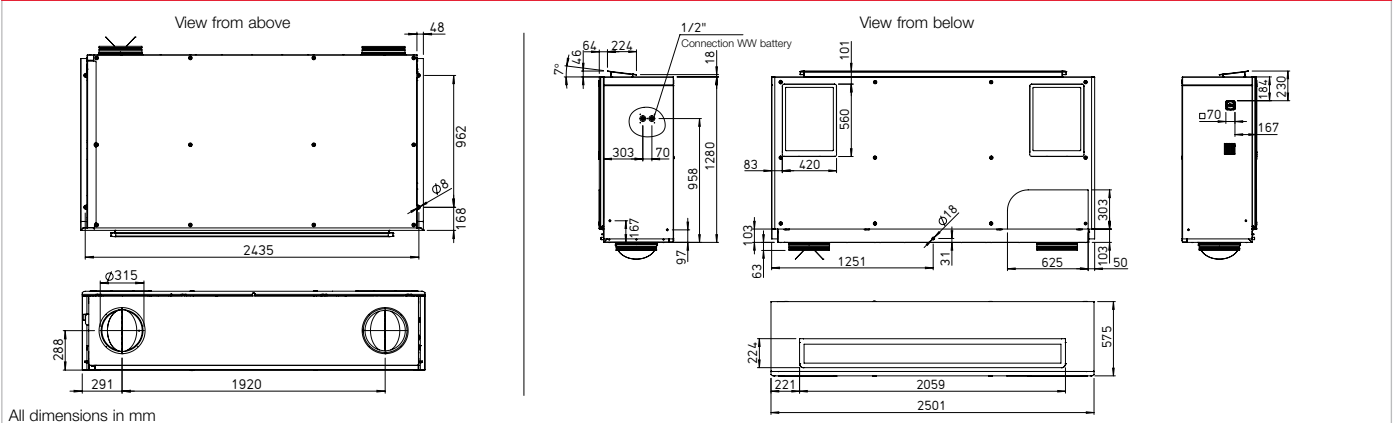

changer to use the cool night air for controlling the room temperature) as standard.

Heat exchanger frost protection

The standard frost monitoring automatically regulates the supply air flow and the built-in electrical preheater, depending on the selected equipment.

After-heater

Unit variants with integrated post-heating (warm water or electrical after-heater) ensure the comfortable and energy-efficient post-heating of supply air. The target supply air temperature is set on the control element. The use of hydraulic unit type WSH HE 24 V (0-10V), (accessories) is recommended for controlling the warm water heating element.

Power control

The included comfort control element with touch functionality and easy menu navigation provide the following functions:

- Demand-oriented ventilation, optionally with CO₂, VOC, or humidity sensor (1 sensor can be connected).
- Initial commissioning (automatic determination of system characteristic curve).
- Fire alarm contact connection.
- Weekly or daily programme.
- Automatic bypass (summer operation: use of cool night air).
- Pressure monitoring of filter contamination.
- Displays required filter replacement.
- 5 password-protected function levels can be configured.
- Control via central building control system possible (ModBus RTU and ModBus TCP, BACnet)
- Including control line cable (10 m)

Electrical connection

After opening the inspection cover, the easily accessible terminal box is located in the side of the casing. The isolator/main switch is located on the outside of the unit for easy maintenance. It can be locked using a padlock to prevent unauthorised access.

Sensors

Infrared motion sensor for detecting the presence of people in the room.

BWM Ref. no. 08323

CO₂ sensor for measuring the CO₂ concentration.

AIR1/KWL-VOC 0-10V No. 20250

VOC sensor for measuring the mixed gas concentration (VOC).

AIR1/KWL-CO2 0-10V No. 20251

Humidity-temperature sensor for measuring the relative air humidity.

AIR1/KWL-FTF 0-10V No. 20252

Installation accessories

Flush-mounted/wall-mounted siphon

KWL-KS WE Ref. no. 40064

Ball-tube siphon

KWL-KS Ref. no. 40065

Condensate pump

KWL-KP Ref. no. 40066

Wall bracket console set for combined wall-ceiling installation.

KWL YOGA-WH Ref. no. 40067

Hydraulic unit

WSH HE 24V (0-10V) No. 08318

Facade grille, circular

FGR 250 Ref. no. 40181

FGR 315 Ref. no. 40182

Filter

Spare air filter (extract air)

ISO Coarse 60% (G4). Unit = 1 pc.

ELF-KWL YOGA 700/Coarse 60% Ref. no. 40069

Spare air filter (extract air)

ISO ePM₁₀ 60% (M5). Unit = 1 pc.

ELF-KWL YOGA 700/ePM 10 60% Ref. no. 40072

Note: 2 extract air filters are required per unit.

Spare air filter (intake air)

ISO ePM₁ 60% (F7). Unit = 1 pc.

ELF-KWL YOGA 700/ePM1 60% Ref. no. 40075

Important note

Further information on accessories can be found on page 142.

KWL-KS WE



■ **Flush-mounted/wall-mounted siphon**

Flush-mounted condensate siphon for ventilation units, for odourless discharge of condensate in the sewage system. Desiccation-safe and cleanable by removing siphon cartridge. Incl. plug-in seal (rubber) for \varnothing 20 – 32 mm. Vertical outlet connector DN32. Structural protection can be cut to installation depth. Incl. odour barrier, pursuant to EN 681, DIN 19541.

Technical data	KWL-KS WE Ref. no. 40064
Material	Polypropylene (PP) and ABS
Drainage capacity l/s	0.15
Min. - max. duct length (feed) in m	0.2 – 3.5
Minimum installation depth in mm	60
Condensate line connection	External \varnothing 20 – 32 mm / Internal \varnothing 18 mm
Dimensions (L x W x H) in mm	110 x 110 x 60
Weight approx. kg	0.25

KWL-KS



■ **Ball-tube siphon**

Ball-tube siphon for ventilation units, for odourless discharge of condensate in the sewage system. Desiccation-safe. Incl. plug-in seal (rubber) for \varnothing 9 – 29 mm. Horizontal outlet connector DN40.

Technical data	KWL-KS Ref. no. 40065
Material	Polypropylene (PP)
Drainage capacity l/s	0.6
Drain connection	DN40

KWL-KP



■ **Condensate pump**

Technical data	KWL-KP Ref. no. 40066
Maximum pumping capacity	35 l/h at 0 m discharge head
Maximum recommended discharge head	15 m
Maximum suction head	2 m (self-priming)
Noise level	35 dB(A) at 1 m
Supply voltage	230 V, 0.1 A, 16 W, 50/60 Hz
Maximum water temperature	40 °C
Pressure line (inside)	6 mm
Protection category	IP21
Safety switch	Break contact 3.0 A
Weight approx. kg	0.45

KWL Yoga-WH



■ **Wall bracket**

Console set for combined wall-ceiling installation of KWL Yoga units. Set consists of 2 pcs. Material: steel sheet, powder-coated. Colour: white, RAL 9016.

KWL YOGA-WH	Ref. no. 40067
--------------------	----------------

WHSH HE 24 V (0-10V)



■ Hydraulic unit

Controls the water temperature of the PWW heater element by means of three point valve actuator 24 V (0-10 V) and thus the thermal output which is conveyed to the air. Delivered as complete unit, incl. flow/return temperature display, circulation pump and flexible connecting pipes.

WHSH HE 24V (0-10V)

Ref. no. 08318

AIR1/KWL-VOC 0-10V / -CO₂ 0-10V / -FTF 0-10V



■ Room sensor

For measuring the CO₂, mixed gas (VOC) concentration or relative humidity. Dim. mm (W x H x D) 85 x 85 x 27

VOC sensor for measuring the mixed gas concentration (VOC).

AIR1/KWL-VOC 0-10V

Ref. no. 20250

CO₂ sensor for measuring the CO₂ concentration.

AIR1/KWL-CO₂ 0-10V

Ref. no. 20251

Humidity-temperature sensor for measuring the relative air humidity.

AIR1/KWL-FTF 0-10V

Ref. no. 20252

BWM



■ Infrared motion sensor

Motion sensor for detecting the presence of people in the room. Wall installation (surface mounted) (cable entry at top or bottom) or installation in flush-mounted box Ø 55 mm (cable entry at back).

Technical data	BWM
	Ref. no. 08323
Material casing	ABS plastic, white (similar RAL 9010)
Protection class	III
Protection category	IP30
Electrical connection	0.14 – 1.5 mm ² (screw terminals)
Dimensions in mm (W x H x D)	85 x 85 x 27

FGR



■ Facade grille, circular

For flush covering of ventilation openings on the facade. Can be used for circular outdoor and exhaust air ducts. Two holes in the pipe spigot allow secure fastening with screws, to be provided by customer.

Solid aluminium construction. Fixed blades with stainless steel wire mesh behind, mesh size 10 x 10 mm.

FGR 250

Ref. no. 40181

FGR 315

Ref. no. 40182

ELF-KWL YOGA



■ Filter

Spare air filter (extract air) ISO Coarse 60% (G4). Unit = 1 pc.

ELF-KWL YOGA 400/Coarse 60%

Ref. no. 40068

ELF-KWL YOGA 700/Coarse 60%

Ref. no. 40069

ELF-KWL YOGA 1000/Coarse 60%

Ref. no. 40070

Note: 2 extract air filters are required per unit.

Spare air filter (extract air) ISO ePM₁₀ 60% (M5). Unit = 1 pc.

ELF-KWL YOGA 400/ePM 10 60%

Ref. no. 40071

ELF-KWL YOGA 700/ePM 10 60%

Ref. no. 40072

ELF-KWL YOGA 1000/ePM 10 60%

Ref. no. 40073

Spare air filter (intake air) ISO ePM₁ 60% (F7). Unit = 1 pc.

ELF-KWL YOGA 400/ePM1 60%

Ref. no. 40074

ELF-KWL YOGA 700/ePM1 60%

Ref. no. 40075

ELF-KWL YOGA 1000/ePM1 60%

Ref. no. 40076

Everything from one source. For the perfect functioning of the KWL® system.

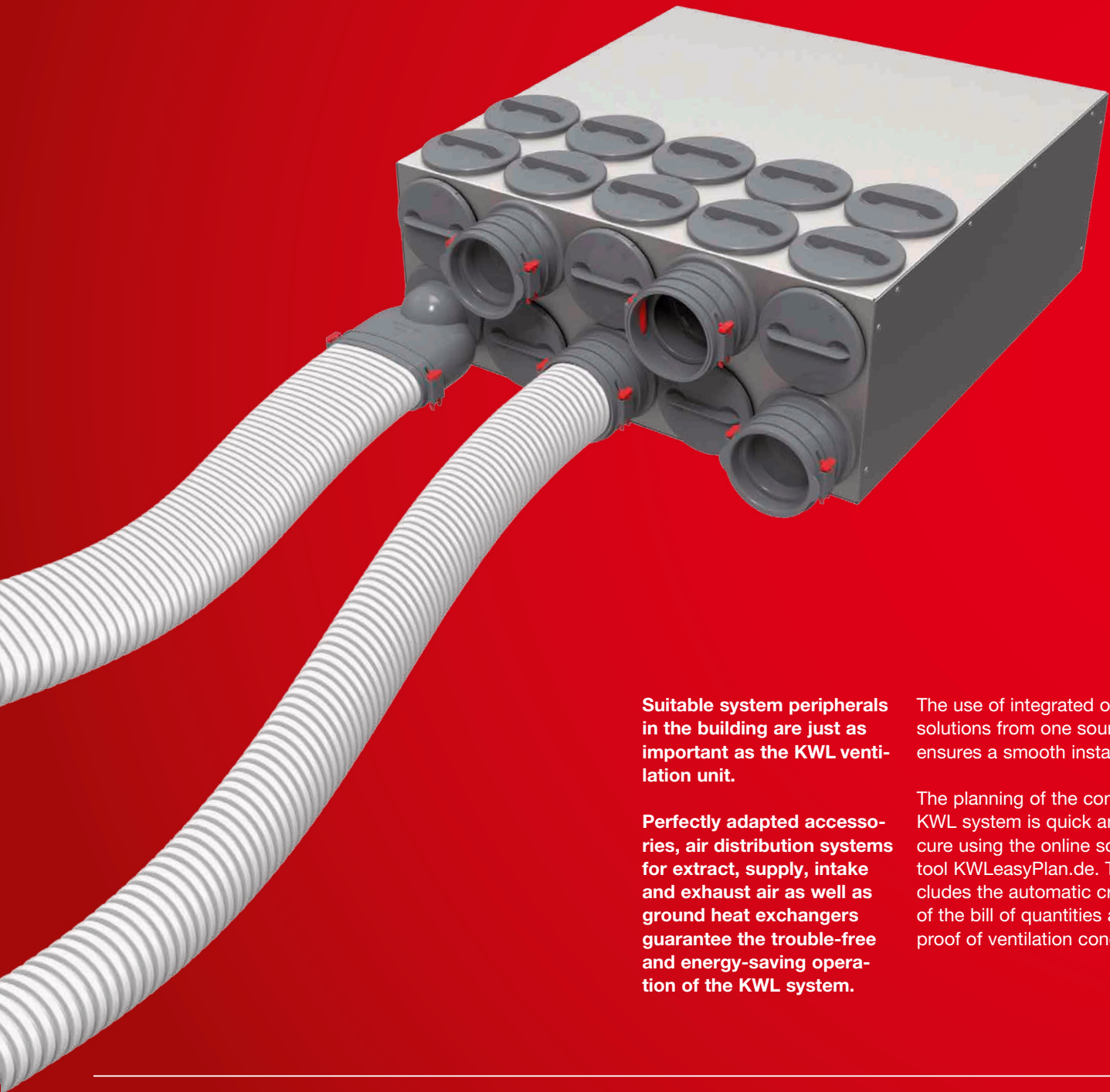

Suitable system peripherals in the building are just as important as the KWL ventilation unit.

Perfectly adapted accessories, air distribution systems for extract, supply, intake and exhaust air as well as ground heat exchangers guarantee the trouble-free and energy-saving operation of the KWL system.

The use of integrated overall solutions from one source ensures a smooth installation.

The planning of the complete KWL system is quick and secure using the online software tool KWLeasyPlan.de. This includes the automatic creation of the bill of quantities and proof of ventilation concept.

■ Flexible duct system *flexpipe*

The right solution for every type of installation. *flexpipe^{plus}* combines the proven round duct concept with oval components.

This makes the planning and installation of complete ventilation systems with heat recovery much easier and DIN-compliant.

flexpipe^{plus} provides the greatest possible flexibility with low parts diversity.

146^{ff}

■ Duct system IsoPipe and air distribution system *renopipe*

IsoPipe is the practical alternative to spiral duct installation with subsequent thermal insulation. Since it is already fully insulated, IsoPipe is ideally suitable for intake air and exhaust air ducting as well as supply air and extract air ducting in basements or low-temperature zones.

renopipe is the perfect solution for energy-saving renovations and it is simply surface-mounted to the ceiling or wall.

156^{ff}

■ KWL MultiZoneBox

When combined with a central building KWL unit from Helios, the MultiZoneBox ensures demand-oriented ventilation in multi-floor buildings.

Supply/extract air-side volume flow control, sound insulation, air distribution and intelligent system control – the KWL MultiZoneBox combines all seven components in one unit.

152^f

■ Accessories

162^f

■ KWL HygroBox and ground heat exchanger

As an active humidification unit, the **HygroBox** ensures a health room air humidity throughout the year and prevents expensive damage to furniture, floor coverings, etc.

Optional **ground-to-brine or ground-to-air heat exchangers** guarantee that the intake air is always energy-optimised when it flows into the ventilation unit. This saves even more energy in winter and results in intake air temperature reduction in summer.

164^{ff}

flexpipe®plus round and oval ducting system. Arbitrarily combinable.



flexpipe®plus is the further development of the successful flexpipe air distribution system and it combines round and oval ducts in one smart system package with all conceivable round-oval combinations.

The oval duct has the identical hydraulic cross-section and pressure loss as the round duct as well as a point-symmetric design. This results in unique advantages:

- No matter if it's planning and layout or installation and adjustment or maintenance, round and oval pipe behave completely identical.
- Depending on the structural circumstances, the optional change between round and oval ducts is possible using adapters, both in line and away from the distribution box. This provides the greatest possible planning and installation freedom.

- The ideal, economical option can be selected at any time. The space-saving oval duct is mainly used if low installation heights are required.
- The round-oval compatibility results in low parts diversity. The stocking and consultation processes are greatly simplified. The installation is almost intuitive.
- The point-symmetric oval design allows installation from horizontal to vertical without the use of adapters for position correction.

■ **Reference**
 flexpipe round duct system with ext. Ø 63 mm, int. 52 mm for volume flows up to 20 m³/h see page154

■ flexpipe®plus is available in two designs which can be combined as required:

- FRS 75, round:
 External Ø: 75 mm, internal: 63 mm for volume flows up to 30 m³/h. For installation in concrete ceilings. High ring strength (STIS ≥ 10 kN/m² according to DIN EN 9969). Bending radius horizontal and vertical 150 mm.
- FRS 51, oval:
 51 x 114 mm, for volume flows up to 30 m³/h, ideal for space-saving installation e.g. on unfinished floors or in walls. Bending radius horizontal 300 mm, vertical 200 mm.

■ **Installation, handling, commissioning**

- Ultra-simple planning thanks to identical duct cross-sections and pressure losses.
- Quick installation due to radial, flexible endless installation from the roll.
- Construction site-compliant handling due to its low weight.
- Quick commissioning due to minimal adjustment effort.
- Uniform air distribution.
- Hygienically optimal and easy to clean.

■ **Duct properties and advantages**

- Special round and oval ventilation duct made of hygienically safe PE-HD new material.
- Two-layer design – externally corrugated and internally

smooth and antistatic. This minimises the pressure losses and prevents flow noises and dirt deposits.

- The extreme horizontal and vertical bending elasticity of both duct geometries minimises the number of necessary moulded parts.
- The point-symmetric design allows the installation of the oval duct from horizontal to vertical, upwards or downwards, without the use of adapters.

■ **Duct concept, installation**

- Mounting clips on all moulded parts for secure fixation to floors, walls or ceilings.
- Detachable mounting brackets guarantee quick, tear-proof duct fixation to all connection points.
- No additional cross talk silencer due to sound-insulating distribution box.
- Precision-fit seal system on all moulded parts for leak-free air transportation.
- Aerodynamically optimised ceiling and floor boxes as well as wall outlets are available for the use of room-side inlet and outlet elements at the duct ends. These have two parallel duct connections for delivering the volume flows required according to DIN 1946-6 with low pressure loss.

flexpipe®plus round duct in concrete ceiling

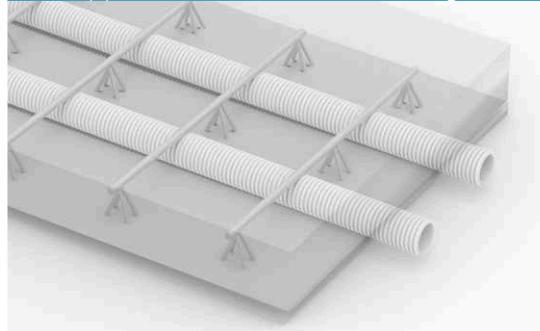

flexpipe®plus oval duct on unfinished floor

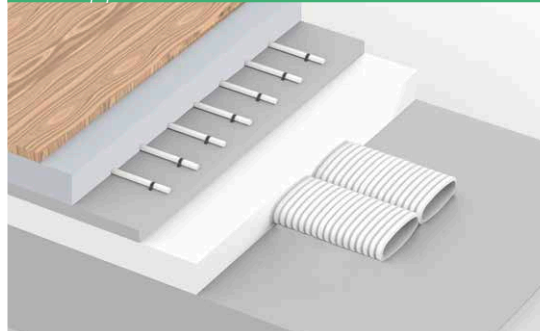

flexpipe®plus allows any round-oval combination



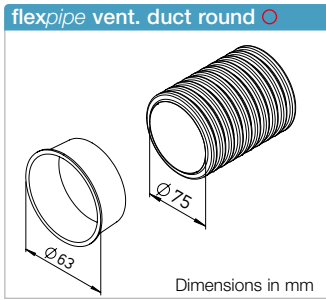

flexpipe vent. duct (bundle = 50 lin. m)

Type	Ref. no.	Dim. in mm	Ext. Ø	Int. Ø
FRS-R 75 ○	02913	75	63	
Hygiene duct shutter cover Unit				
FRS-VD 75 ○	02915	10	pcs.	

Flexible round duct made of PE-HD, ideal for installation in concrete ceiling.
Includes two hygiene duct shutter covers, can also be ordered separately.

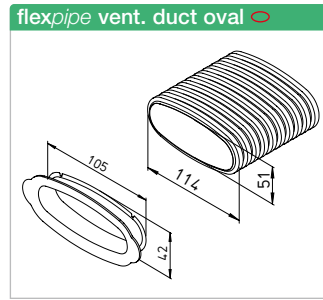

flexpipe vent. duct (bundle = 20 lin. m)

Type	Ref. no.	Dim. in mm	Width	Height
FRS-R 51 ○	03850	114	51	
Hygiene duct shutter cover Unit				
FRS-VD 51 ○	03866	10	pcs.	

Flexible oval duct made of PE-HD, for space-saving installation on unfinished floors, installation in walls or suspended ceilings. Includes two hygiene duct shutter covers, can also be ordered separately.

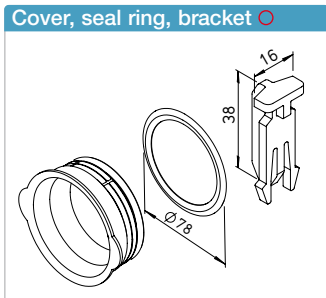

Connector cover / seal ring / bracket

Type	Ref. no.	Unit
FRS-VDS 75 ○	03855	1 pc.
Connector shutter cover with seal ring		
Seal ring		
FRS-DR 75 ○	02916	10 pcs.
Bracket, detachable		
FRS-FK ○ ○	03854	10 pcs.

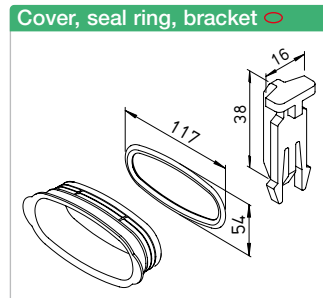

Connector cover / seal ring / bracket

Type	Ref. no.	Unit
FRS-VDS 51 ○	03856	1 pc.
Connector shutter cover with seal ring		
Seal ring		
FRS-DR 51 ○	03864	10 pcs.
Bracket, detachable		
FRS-FK ○ ○	03854	10 pcs.

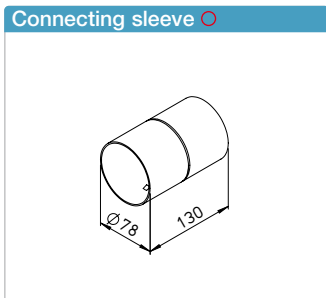

Connecting sleeve

Type	Ref. no.
FRS-VM 75 ○	02914

Connecting sleeve for round duct FRS-R 75 with tear-off protection on both sides, made of polyethylene.

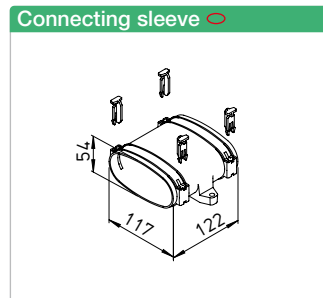

Connecting sleeve

Type	Ref. no.
FRS-VM 51 ○	03862

Connecting sleeve for oval duct FRS-R 51. With integrated fastening tabs, includes duct mounting brackets (4 pcs.). Made of impact-resistant polypropylene.

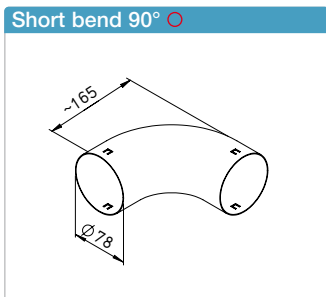

Short bend 90°

Type	Ref. no.
FRS-B 75 ○	02994

Short bend 90° for bending radii < 2 x round duct external diameter. Horizontal and vertical application with tear-off protection on both sides. Made of galvanised steel sheet.

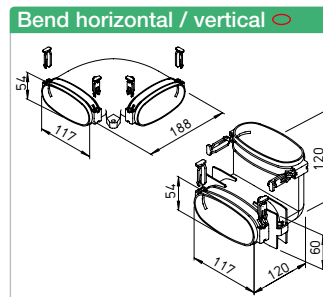

Bend horizontal / vertical

Type	Ref. no.
FRS-BH 51 ○	03863
FRS-BV 51 ○	03859

Horizontal or vertical bend 90°. With integrated fastening tabs, includes duct mounting brackets (4 pcs.). Made of impact-resistant polypropylene.

■ **Optional possibility to combine round and oval ducts**

- With flexpipe® plus from Helios, you rely on one system and you have the ideal solution at your fingertips at all times, depending on building requirements.
- The ultra-flat (only 51 mm) oval duct is used if low installation heights are required. The proven duct lends itself for direct embedding in concrete ceilings.
- Thanks to the identical hydraulic cross-sections and pressure losses of the two ducts and due to well-conceived system components, round and oval ducts can be combined in any way – both in line and away from the distribution box.



Vertical and horizontal adapters allow any round/oval, oval/oval and round/round combination.

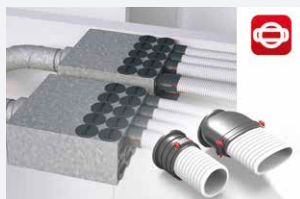

The distribution boxes can be equipped with round and oval single connectors and mixed connectors.

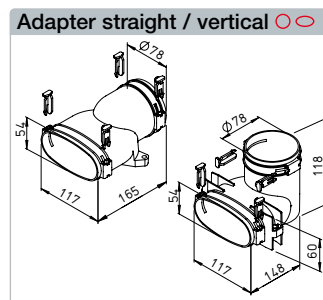

Adapter straight / vertical

Type	Ref. no.
FRS-ÜG 51-75 ○ ○	03861
Adapter vertical	
FRS-ÜV 51-75 ○ ○	03860

Horizontal and vertical adapter from round duct FRS-R 75 to oval duct FRS-R 51. With integrated fastening tabs, includes duct mounting brackets (4 pcs.). Made of impact-resistant polypropylene.

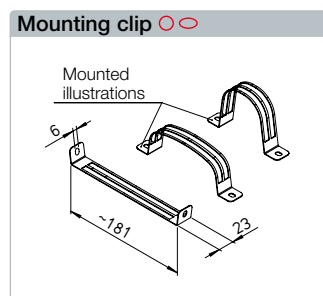

Mounting clip

Type	Ref. no.	Unit
FRS-BS ○ ○	03869	10 pcs.

Mounting clip for round duct FRS-R 75 and oval duct FRS-R 51. For non-slip duct fixation. Made of galvanised steel sheet.

Ceiling/wall box ○

FRS-VDS 75¹
 Core hole Ø 140 mm
 FRS-VD 125¹
 Dim. in mm

Ceiling / wall box

Type	Ø 75 mm	Ref. no.
FRS-DWK 2-75/125	○	03857
Extension for ceilings > 240 mm		
FRS-VV 125	○	03906

Ceiling / wall box for max. 2 round ducts FRS-R 75. For connection of supply / extract air valves DN 125. Height marks can be shortened to fit. Per 1 pc. connector blind cover DN 75, DN 125.
 ¹) Integr. mounting clips, duct mounting brackets (4 pcs.), made of impact-resistant polypropylene.

Ceiling/wall box ○

FRS-VDS 51²
 Core hole Ø 140 mm
 FRS-VD 125²

Ceiling / wall box

Type	114 x 51 mm	Ref. no.
FRS-DWK 2-51/125	○	03858
Extension for ceilings > 240 mm		
FRS-VV 125	○	03906

Ceiling / wall box for max. 2 oval ducts FRS-R 51. For connection of supply / extract air valves DN 125. Height marks can be shortened to fit. Per 1 pc. connector blind cover 51 mm, DN 125.
 ²) Integr. mounting clips, duct mounting brackets (4 pcs.), made of impact-resistant polypropylene.

Multi-floor box ○

Multi-floor box

Type	Ø 75 mm	Ref. no.
FRS-MBK 2-75	○	03872

Multi-floor box for connection of max. 2 round ducts FRS-R 75. Suitable for embedding in concrete ceiling, consists of:
 – Floor box with air volume control insert in robust sheet metal design
 – 2 pcs. connectors (round) and 1 pc. connector cover with seal (round)

Wall/floor box ○

Wall / floor box

Type	114 x 51 mm	Ref. no.
FRS-WBK 2-51	○	03877

Wall / floor box for connection of max. 2 oval ducts FRS-R 51. Installation in walls or on unfinished floor, consists of:
 – Plastic box made of impact-resistant polypropylene with air volume control insert. For use with FRS-WGS or FRS-BGS. 1 pc. connector cover with seal (oval).

Floor grille set ○

Floor grille set

Type	FRS-BGS 1	Ref. no.	03878
------	-----------	----------	-------

Floor grille set made of stainless steel for multi-floor box FRS-MBK 2-75 and wall / floor box FRS-WBK 2-51, consists of:
 – Grille frame with height adjustment for barrier-free installation in the floor covering
 – Anti-puncture design floor grille
 – Insert filter (replacement filter mats ELF-BGS, Ref. no. 03914, unit = 2 pcs.)

Wall grille set ○

* Design 1: FRS-WGS 1/1 E

Wall grille set

Type	Ref. no.	
FRS-WGS 1	○	03881 white
FRS-WGS 2	○	03882 white
FRS-WGS 3	○	03883 white
FRS-WGS 1 E	○	03886 Stainl. steel
FRS-WGS 2 E	○	03892 Stainl. steel
FRS-WGS 3 E	○	03904 Stainl. steel

Wall grille set with installation frame and insert filter for FRS-WBK 2-51. See p. 106 for grille designs.

Floor box set ○

Floor box set

Type	Ø 75 mm	Ref. no.
FRS-BKGS 2-75	○	09992

Floor box set consists of:
 – 1 pc. floor box for grille connection DN 160
 – 1 pc. floor grille made of brushed stainless steel with adjustable volume flow
 – 1 pc. cover

Wall outlet ○

* FRS-WDV 2-75/100

Wall outlet for valve connection

Type	Ref. no.	Ø D
FRS-WDV 2-75/100	○	09621 100
FRS-WDV 2-75/125	○	09622 125

Wall outlet incl. plaster / formwork lid and cover (1 pc.). For connection of supply air or extract air valves DN 100 or DN 125.

Wall outlet set ○

Wall outlet set, straight

Type	Ø 75 mm	Ref. no.
FRS-WDS 2-75	○	09994

Wall outlet set consists of:
 – Wall outlet with sliding connector
 – Wall outlet white (FK-WA 200 W), 250 x 103 mm
 – 1 pc. cover

Basic set package ○

Basic set package

Type	Ref. no.	Ø D
FRS-RP 75	○	09397 75

flexpipe basic set package consists of:
 – 3 pcs. FRS-R 75 (Ref. no. 02913)
 – 2 pcs. FRS-VK 10-75/160 (Ref. no. 03847)
 – 8 pcs. FRS-DWK 2-75/125 (Ref. no. 03857)
 – 7 pcs. FRS-B 75 (Ref. no. 02994)
 – 7 pcs. FRS-VM 75 (Ref. no. 02914)
 – 4 units FRS-DR 75 (Ref. no. 02916)
 – 1 units FRS-VD 75 (Ref. no. 02915)
 – 1 pcs. cold shrink tape KSB (Ref. no. 09343)

By choosing the Helios basic set package, you can save
 – money due to the discounted package price.
 – time, because everything is included to get started right away. There is no need for time consuming, annoying additional trips because little things are missing.

¹) Cover with integrated seal FRS-VDS 75, Ref. no. 03855 and -VD 125, Ref. no. 03865. Cover can be used for the connector or duct connection opening on distribution box.

²) Cover with integrated seal FRS-VDS 51, Ref. no. 03856 and -VD 125, Ref. no. 03865. Can also be used as cover for the connector or duct connection opening on distribution box.

Multi-distribution box 4+1x ○

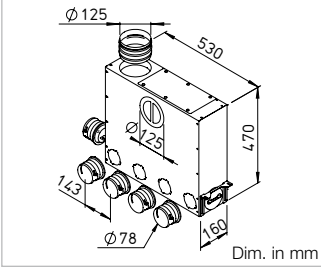

Dim. in mm

Multi-distribution box ¹⁾

Type	Ref. no.	Ø NW mm
Type Ø 75 mm		
FRS-MVK 4+1-75/125 ○	03843	125

For universal installation in/on unfinished concrete flooring. With height-adjustable mounting brackets. Duct connection DN 125 optionally horizontal or vertical. 10 connection options for up to 5 ventilation ducts FRS-R 75. With sound-absorbing cladding and large inspection opening.

Multi-distribution box 4+1x ○

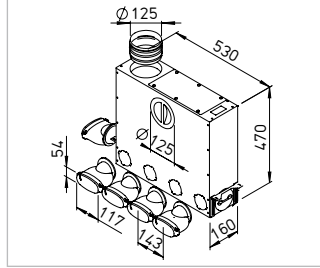

Multi-distribution box 4+1x ¹⁾

Type	Ref. no.	Ø NW mm
Type 114 x 51 mm		
FRS-MVK 4+1-51/125 ○	03841	125

For universal installation on unfinished concrete flooring. With height-adjustable mounting brackets. Duct connection DN 125 optionally horizontal or vertical. 10 connection options for up to 5 oval ventilation ducts FRS-R 51. With sound-absorbing cladding and large inspection opening.

Multi-distribution box 5+2x ○

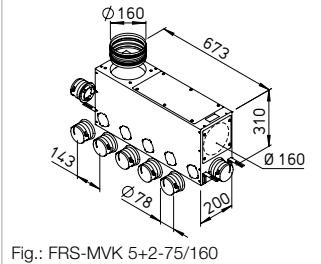

Fig.: FRS-MVK 5+2-75/160

Multi-distribution box 5+2x ¹⁾

Type	No.	Ø NW mm
Type Ø 75 mm		
FRS-MVK 5+2-75/160 ○	03836	160
FRS-MVK 5+2-75/160 H ○	03835	160

For universal installation in/on unfinished concrete flooring. With height-adjustable mounting brackets. Duct connection DN 160 optionally horizontal or vertical. Type FRS-MVK 5+2-75/160 H with 380 mm casing height and 3 x duct connection DN 160. 12 connection options for up to 7 ventilation ducts FRS-R 75.

Multi-distribution box 5+2x ○

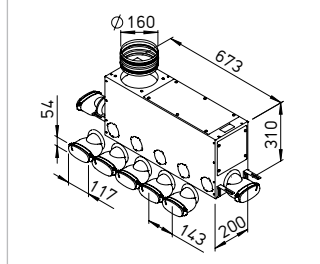

Multi-distribution box 5+2x ¹⁾

Type	Ref. no.	Ø NW mm
Type 114 x 51 mm		
FRS-MVK 5+2-51/160 ○	03838	160

For universal installation on unfinished concrete flooring or as floor distributor. With height-adjustable mounting brackets. Duct connection DN 160 optionally horizontal or vertical. 12 connection options for up to 7 oval ventilation ducts FRS-R 51. With sound-absorbing cladding and large inspection opening.

Distribution box 10x ○

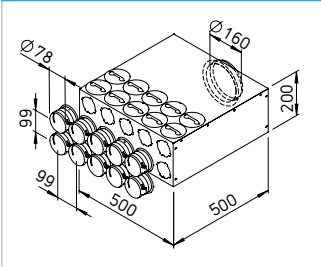

Distribution box 10-75 ²⁾

Type	Ref. no.	Ø NW mm
Type Ø 75 mm		
FRS-VK 10-75/160 ○	03847	160

20 connection options for up to 10 ventilation ducts FRS-R 75. Can be installed as straight distributor, 90° distributor or combined. Mixed setup with oval connectors possible (Type FRS-ES 51, Ref. no. 03851). With sound-absorbing cladding and large inspection opening.

Distribution box 10x ○

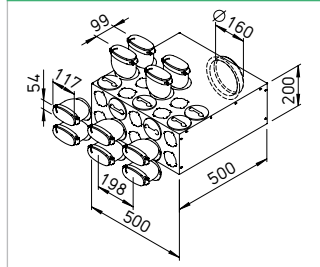

Distribution box 10-51 ²⁾

Type	Ref. no.	Ø NW mm
Type 114 x 51 mm		
FRS-VK 10-51/160 ○	03849	160

20 connection options for up to 10 oval ventilation ducts FRS-R 51. Can be installed as straight distributor, 90° distributor or combined. Mixed setup with round connectors possible (Type FRS-ES 75, Ref. no. 03852). With sound-absorbing cladding and large inspection opening.

Flat distribution box 6x ○

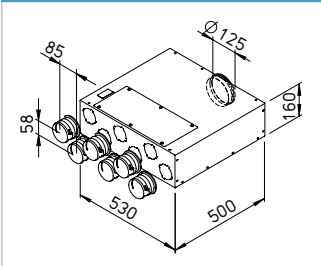

Distribution box 6-75, flat design ¹⁾

Type	Ref. no.	Ø NW mm
Type Ø 75 mm		
FRS-FVK 6-75/125 ○	03845	125

For connection of up to 6 ventilation ducts FRS-R 75. Installation as straight distributor. Mixed setup with oval connectors possible (Type FRS-ES 51, Ref. no. 03851). With sound-absorbing cladding and large inspection opening.

Distribution box 6x ○

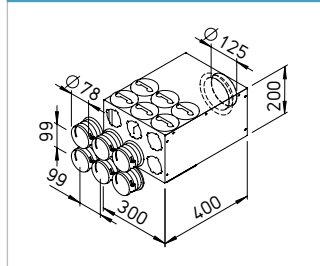

Distribution box 6-75 ¹⁾

Type	Ref. no.	Ø NW mm
Type Ø 75 mm		
FRS-VK 6-75/125 ○	03846	125

12 connection options for up to 6 ventilation ducts FRS-R 75. Can be installed as straight distributor, 90° distributor or combined. Mixed setup with oval connectors possible (Type FRS-ES 51, Ref. no. 03851). With sound-absorbing cladding and large inspection opening.

Distribution box 15x ○

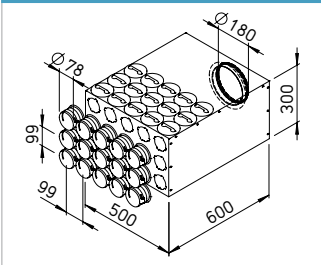

Distribution box 15-75 ²⁾

Type	Ref. no.	Ø NW mm
Type Ø 75 mm		
FRS-VK 15-75/180 ○	03848	180

30 connection options for up to 15 ventilation ducts FRS-R 75. Can be installed as straight distributor, 90° distributor or combined. Mixed setup with oval connectors possible (Type FRS-ES 51, Ref. no. 03851). With sound-absorbing cladding and large inspection opening.

Combination distribution box ○

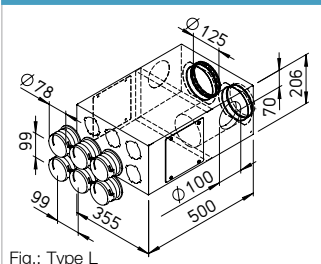

Fig.: Type L

Combination distribution box ¹⁾

Type	Ref. no.	Ø NW mm
Type Ø 75 mm		
FRS-KVK 6-75/125 L* ○	03873	125
FRS-KVK 6-75/125 R* ○	03874	125

* Supply air connection on left or right. Compact distribution box, ideal for adjoining extract air rooms. 2 x DN 100 for direct insertion of extract air valves DLV (see accessories). Supply air distribution via connection of up to 6 ventilation ducts FRS-R 75.

Connector, cover ○○

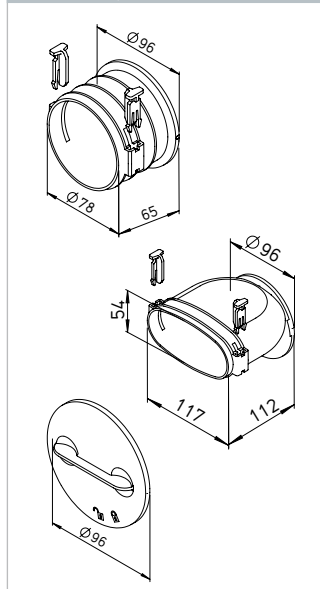

Connector, bayonet cap

Type	Ref. no.	Unit
Connector, Ø 75 mm		
FRS-ES 75 ○	03852	1 pc.
Connector, 114 x 51 mm		
FRS-ES 51 ○	03851	1 pc.
Bayonet cap		
FRS-VDB ○○	03853	1 pc.

Additional connectors for connection of round ventilation duct FRS-R 75 or oval ventilation duct FRS-R 51 to distribution box. Easy and variable positioning using bayonet closure. Tight-closing, includes duct mounting brackets (2 pcs.), made of impact-resistant polypropylene. Bayonet cap for the connector openings on the distribution box.

¹⁾ incl. 2 pcs. connector cover.

²⁾ incl. 4 pcs. connector cover.

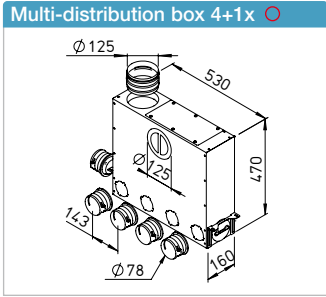

Multi-distribution box 4+1x ○
Type Ø 75 mm No. Ø NW mm
FRS-MVK 4+1-75/125 ○ 03843 125

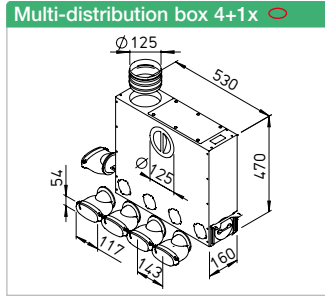

Multi-distribution box 4+1x ○
Type 114 x 51 mm No. Ø NW mm
FRS-MVK 4+1-51/125 ○ 03841 125

Frequency	Insertion loss	Cross-talk loss
Hz	dB	dB
125	23.5	30.6
250	24.2	25.3
500	19.3	18.3
1000	28.7	25.3
2000	30.8	39.0
4000	36.6	42.9
8000	38.3	40.8

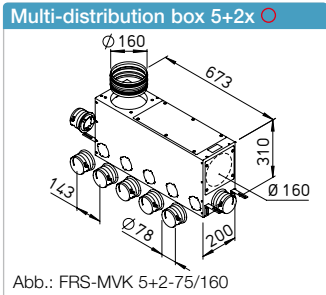

Multi-distribution box 5+2x ○
Type Ø 75 mm No. Ø NW mm
FRS-MVK 5+2-75/160 ○ 03836 160
FRS-MVK 5+2-75/160 H ○ 03835 160

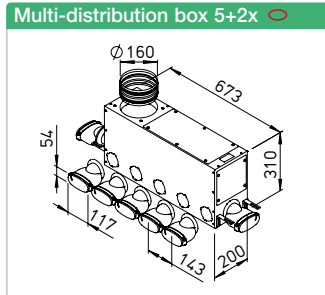

Multi-distribution box 5+2x ○
Type 114 x 51 mm No. Ø NW mm
FRS-MVK 5+2-51/160 ○ 03838 160

Frequency	Insertion loss	Cross-talk loss
Hz	dB	dB
125	21.0	28.8
250	16.5	24.7
500	24.6	28.0
1000	36.3	34.4
2000	35.2	40.2
4000	43.8	45.0
8000	46.1	41.1

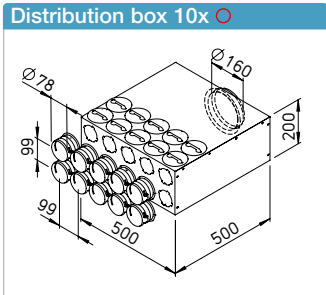

Distribution box 10x ○
Type Ø 75 mm No. Ø NW mm
FRS-VK 10-75/160 ○ 03847 160

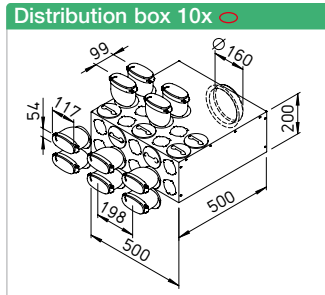

Distribution box 10x ○
Type 114 x 51 mm No. Ø NW mm
FRS-VK 10-51/160 ○ 03849 160

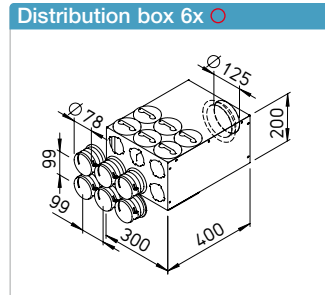

Distribution box 6x ○
Type Ø 75 mm No. Ø NW mm
FRS-VK 6-75/125 ○ 03846 125

Frequency	Insertion loss	Cross-talk loss
Hz	dB	dB
125	23.0	34.4
250	21.8	33.1
500	36.2	27.4
1000	29.4	26.9
2000	28.9	38.7
4000	34.4	44.2
8000	36.1	44.0

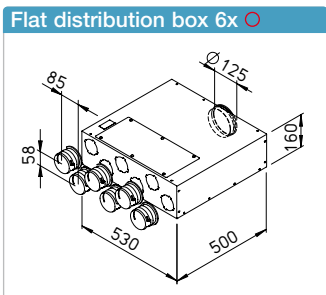

Flat distribution box 6x ○
Type Ø 75 mm No. Ø NW mm
FRS-FVK 6-75/125 ○ 03845 125

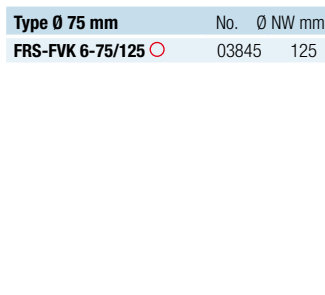

Flat distribution box 6x ○
Type 114 x 51 mm No. Ø NW mm
FRS-FVK 6-51/180 ○ 03848 180

Frequency	Insertion loss	Cross-talk loss
Hz	dB	dB
125	22.6	27.4
250	21.3	21.4
500	27.7	20.4
1000	28.8	20.2
2000	30.6	33.6
4000	42.6	40.1
8000	43.2	40.2

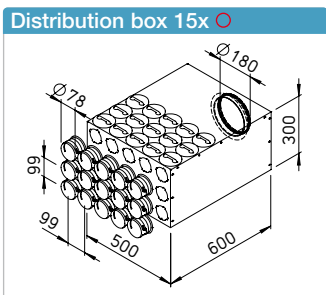

Distribution box 15x ○
Type Ø 75 mm No. Ø NW mm
FRS-VK 15-75/180 ○ 03848 180

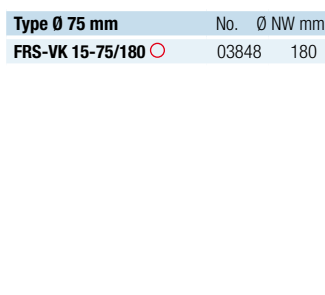

Distribution box 15x ○
Type 114 x 51 mm No. Ø NW mm
FRS-VK 15-51/180 ○ 03848 180

Frequency	Insertion loss	Cross-talk loss
Hz	dB	dB
125	26.8	30.9
250	19.4	30.2
500	28.4	25.3
1000	25.4	29.0
2000	30.8	39.8
4000	34.7	49.1
8000	34.9	53.0

Measured in accordance with DIN EN ISO 7235 and DIN EN ISO 11820.

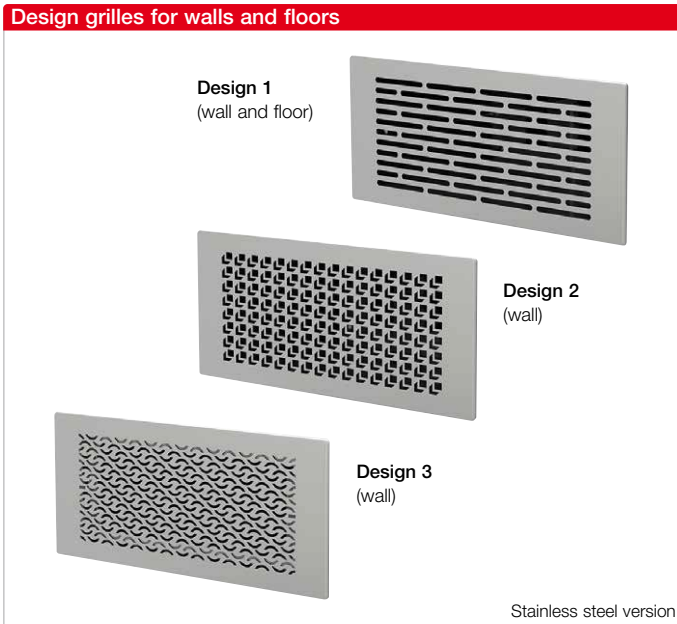

The elegant wall grilles in three high-quality designs (stainless steel or signal white coating) blend perfectly into any room atmosphere and guarantee the pleasant draught-free flow of supply air.

Floor grille set for floor level installation. Three-dimensional adjustable compensation mechanism for adapting the grille to different floor covering heights or for alignment to a wall or window.

- **Description Wall grille set**
Grille for wall/ floor box FRS-WBK 2-51.
- Set consists of:
Metal wall grille with installation frame and insert filter.
- **Surfaces/ Colours**
- Powder coating in white:
FRS-WGS 1, FRS-WGS 2 and FRS-WGS 3.
- High-quality stainless steel: FRS-WGS 1 E, FRS-WGS 2 E and FRS-WGS 3 E.

- **Description Floor grille set**
Grille for multi-floor box FRS-MBK 2-75 and wall/ floor box FRS-WBK 2-51.
- Set consists of:
Grille frame, design floor grille and insert filter.
- **Surfaces/ Colours**
- High-quality stainless steel: FRS-BGS 1.

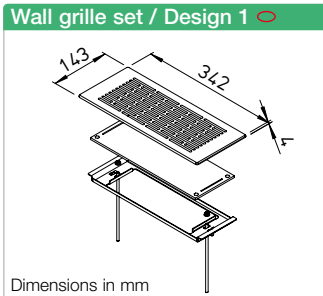

Wall grille set		
Type	Ref. no.	
FRS-WGS 1	03881	White
FRS-WGS 1 E	03886	Stainl. steel

Replacement filter mat for insert filter:
Type ELF-WGS, Ref. no. 03915, unit = 2 pcs.



- **Wall grille set FRS-WGS 1 E** with additional wall/ floor box FRS-WBK 2-51.

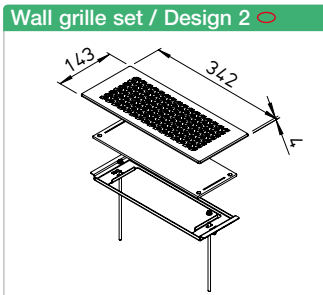

Wall grille set		
Type	Ref. no.	
FRS-WGS 2	03882	White
FRS-WGS 2 E	03892	Stainl. steel

Replacement filter mat for insert filter:
Type ELF-WGS, Ref. no. 03915, unit = 2 pcs.



- **Wall grille set FRS-WGS 2 E** with additional wall/ floor box FRS-WBK 2-51.

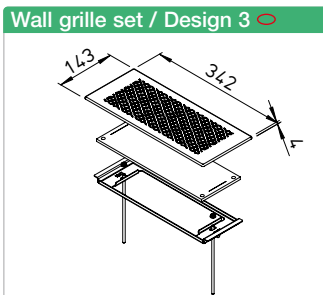

Wall grille set		
Type	Ref. no.	
FRS-WGS 3	03883	White
FRS-WGS 3 E	03904	Stainl. steel

Replacement filter mat for insert filter:
Type ELF-WGS, Ref. no. 03915, unit = 2 pcs.



- **Wall grille set FRS-WGS 3 E** with additional wall/ floor box FRS-WBK 2-51.

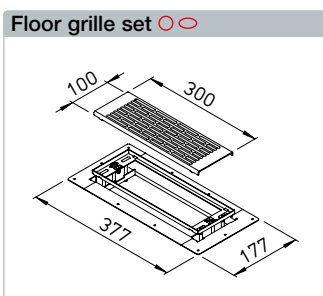

Floor grille set		
Type	Ref. no.	
FRS-BGS 1	03878	Stainl. steel

Replacement filter mat for insert filter:
Type ELF-BGS, Ref. no. 03914, unit = 2 pcs.



- **Floor grille set FRS-BGS 1** with additional wall/ floor box FRS-WBK 2-51. Also suitable for multi-floor box FRS-MBK 2-75.

KWL-MZB 6+1-75/125 R90 and KWL-MZB 6+1-75/125 L90



Compact unit for connection of supply and extract air DN 125 and 2 x 7 connectors DN 75 with supply air on right or left side.

KWL-MZB 6+1-75/125 R90

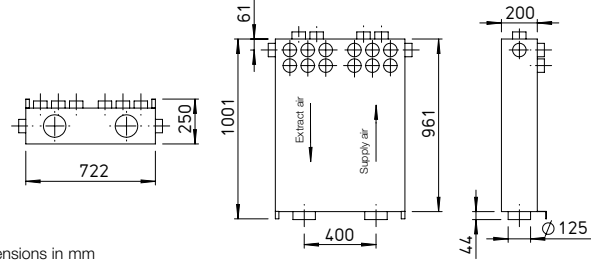

Dimensions in mm

KWL-MZB 6+1-75/125 L90

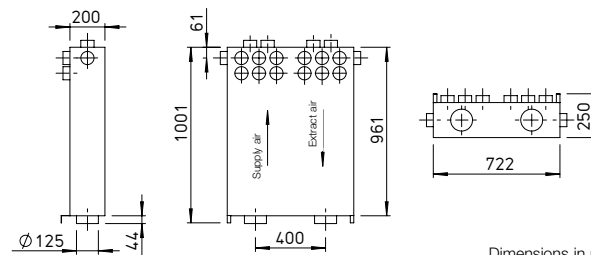

Dimensions in mm

KWL-MZB 6+1-75/125 and KWL-MZB 125/125



Compact unit for the connection of supply and extract air DN 125 and 2 x 7 connectors DN 75.

Box with one connection each for supply and extract air on each side DN 125.

KWL-MZB 6+1-75/125

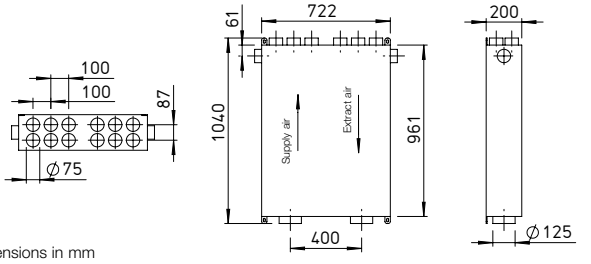

Dimensions in mm

KWL-MZB 125/125

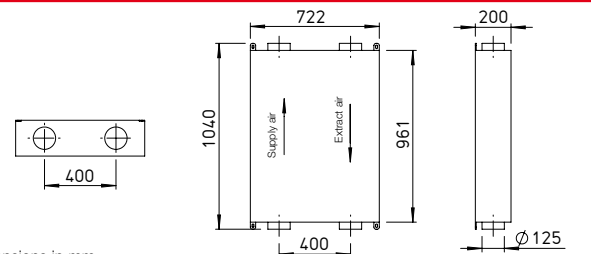

Dimensions in mm

Volume flow control, sound insulation, air distribution and system control – solve seven problems at once with the new KWL MultiZoneBox.
 When combined with a central building KWL unit, the MultiZoneBox ensures the silent, demand-oriented supply and extract ventilation of residential and commercial units.

Advantages

- The installation and commissioning are particularly simple and safe.
- Spiral ducts can also be connected just as easily as the flexible plastic duct system flexpipe^{plus}.
- Reliable air distribution for almost all areas of application.
- Practical advantages include freedom from maintenance,

maximum functional reliability and whisper-quiet operation.

- When multiple KWL MultiZoneBoxes are used to ventilate a large unit, e.g. a doctor's surgery, different zones can be supplied with varying air volumes independently and according to demand.
- Whether the ventilation system is installed in the basement or on the roof, indoors or outdoors.
- The KWL MultiZoneBox always ensures an ideal air distribution.
- Special features**
 - Large sound insulation elements guarantee silent operation.
 - The optional room air sensor makes the MultiZoneBox a complete demand-controlled ventilation unit.
 - Only one single, compact box is installed.

- Expendable parts and wear parts were dispensed with completely in the design of the KWL MultiZoneBox.
- Revolutionary technology safely guarantees the predefined volume flow.
- Functional principle**
 Thanks to the intuitive PC software, the commissioning of the KWL MultiZoneBox is convenient and fast:
 - Start software > enter air volumes > done!
 There is no need for elaborate, time-consuming pressure differential measurements.
 - A variety of other configuration options are available, if required.
 - Once set, the defined parameters can be stored on a computer and transferred to other boxes.

The box in the network

All boxes can be combined to form a network and operated centrally (using a central controller, KWL-ZR, accessories):
 The KWL MultiZoneBox software allows the central commissioning of all boxes in the network. Optionally on-site or via the internet.

The ultimate solution

This technology is used to constantly coordinate the performance of the central ventilation unit with the changing conditions for each KWL MultiZoneBox. The unit supplies the exact air volume individually required for every moment. This reduces energy consumption without comprising on comfort.

Control element Touch

KWL-MZB-BET Ref. no. 04214

- **Description**
- Touch display made of glass for controlling the boxes.
- Dimensions (WxHxD) 110x93x19 mm.
- 3.9 inch display including temperature sensor, flush-mounted version.



Central controller

KWL-MZB-ZR Ref. no. 04215

- **Description**
- Central control, configuration and management of all connected boxes.
- Networking of up to 256 boxes.
- Fan optimiser function.
- Suitable switching power supply: KWL 45 SNH, No. 03001.

Control element ECO

KWL-MZB-BE Ref. no. 04213

- **Description**
- Manual 4-step operation or automatic mode. For flush-mounted installation.
- Dimensions (WxHxD) 80x80x10 mm.
- 4-step with LED, flush-mounted version.



Connection plate

KWL-MZB-AP Ref. no. 04217

- **Description**
- For installation in concrete ceilings.
- Dimensions (WxHxD) 776x50x255 mm.
- 2 x 6 connectors DN 75.
- For direct box connection to the duct system in the ceiling.

Pipe support

KWL-MZB-RH13 Ref. no. 04249

- **Description**
- Pipe supports for one-sided connection of *flexpipeplus*.
- Consists of 1 connection plate with 13 supports.

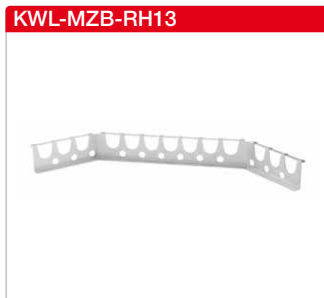

Combi-sensor

KWL-MZB-VOC-F No. 04216

- **Description**
- Combi-sensor (air humidity and VOC) for installation in MZB.
- VOC-humidity sensor.
- Installation in KWL MultiZone-Box.

Pipe support

KWL-MZB-RH7 Ref. no. 04236

- **Description**
- Pipe supports for two-sided connection of *flexpipeplus*.
- Set consists of 2 connection plates each with 7 supports.

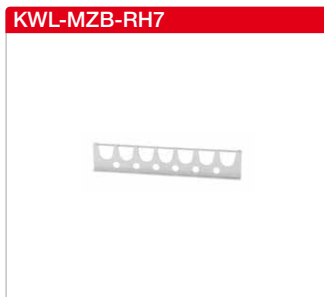

Humidity sensor

KWL-MZB-F Ref. no. 04250

- **Description**
- Air humidity sensor for installation in KWL MultiZoneBox.

Connection set

KWL-MZB-VSAP Ref. no. 04219

- **Description**
- For ceiling installation with connection plate. Set with 12 connectors and mounting bracket.
- Includes 12 connectors for connection plate.



Plastic connectors DN 75

KWL-MZB-KSS Ref. no. 04253

- **Description**
- Set consists of 2 pcs., for the optional, side connection of a ventilation duct DN 75 to KWL-MZB 125/125 (Ref. no. 04053), included in delivery for boxes 04050, 04051, 04052.

Technical data MultiZoneBox			
Type	Ref. no.	Type	Ref. no.
KWL-MZB 6+1-75/125 R90	04050	KWL-MZB 6+1-75/125*	04052
KWL-MZB 6+1-75/125 L90	04051	KWL-MZB 125/125*	04053
Range of application			40–220 m³/h
Measurement accuracy			+/-10 m³/h
Voltage / Frequency			1~, 230 V, 50 Hz
Max. power consumption			6 Watt
Protection category			IP40
Weight			25 kg

* Supply air and extract air flow directions freely selectable. Individual type details at www.HeliosSelect.de.

■ **Reference**
Suitable revision solution for drywall construction on request.

flexpipe is embedded directly in concrete or on/under ceilings,

- Simple planning and quick installation due to star-shaped, flexible continuous installation from the roll.
- Construction site-compliant handling due to low weight.
- Quick commissioning, uniform air distribution.
- Easy to clean.

- Available in two sizes and designs
 - flexpipe FRS 63
External Ø: 63 mm, internal: 52 mm for vol. flows up to 20 m³/h.
 - flexpipe^{plus}
External Ø: 75 mm, internal: 63 mm for vol. flows up to 30 m³/h. Can be combined with oval duct FRS-R 51 and oval components, see page 146 ff.

- Properties and advantages
 - Special ventilation duct made of hygienically safe PE-HD new material, odourless.
 - The two-layer design (externally corrugated and internally smooth and antistatically treated) guarantees:
 - Low flow resistances and high sound insulation.
 - Minimal dirt deposits.
 - Easy to clean.

- Installation
 - The flexpipe plastic corrugated pipe has high ring strength ($S_{R24} > 8 \text{ kN/m}^2$) and it can be installed directly in, on or under concrete ceilings due to its high flexibility in the desired system.
 - Airtight and watertight connection simply through the use of FRS seal rings.

flexpipe vent. duct round



flexpipe vent. duct (bundle = 50 lin. m)

Type	Ref. no.	Dim. in mm	Ext. Ø	Int. Ø
Ø 63 mm				
FRS-R 63	09327	63	52	

Ceiling box

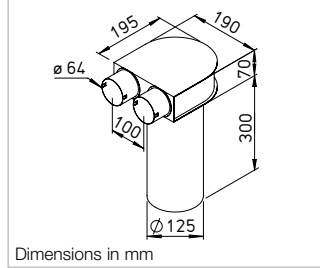

Ceiling box²⁾ for valve connection DN 125

Type	Ref. no.
Ø 63 mm	
FRS-DKV 2-63/125	09430

Ceiling box incl. plaster/formwork lid. For connection of supply or extract air valves DN 125 (accessories, see page 162).

Distribution box 6-63, 12-63

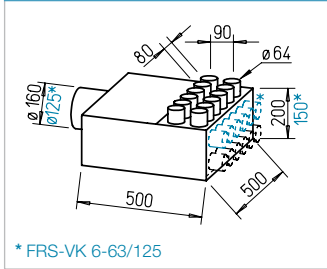

Distribution box 6-63, 12-63¹⁾

Type	Ref. no.	Ø NW mm
Ø 63 mm		
FRS-VK 6-63/125	09355	125
FRS-VK 12-63/160	09336	160

For connection of up to 6 or 12 ventilation ducts FRS-R 63, with sound-absorbing cladding. The connector plate can be replaced with the inspection opening and rotated 90° for type 12-63.

Floor box set

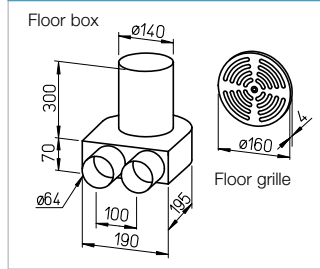

Floor box set²⁾

Type	Ref. no.
Ø 63 mm	
FRS-BKGS 2-63	09991

Floor box set consists of:
- 1 pc. floor box for grille connection DN 160
- 1 pc. floor grille made of brushed stainless steel with adjustable volume flow.

Distribution box 18-63

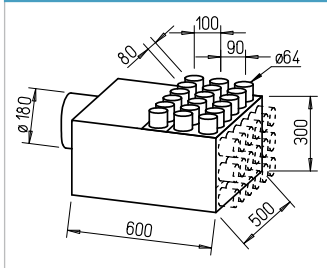

Distribution box 18-63¹⁾

Type	Ref. no.	Ø NW mm
Ø 63 mm		
FRS-VK 18-63/180	09364	180

For connection of up to 18 ventilation ducts FRS-R 63, with sound-absorbing cladding. The connector plate with the connectors can be replaced with the inspection opening and rotated 90°. This allows installation as a straight or 90° distributor.

Wall outlet set

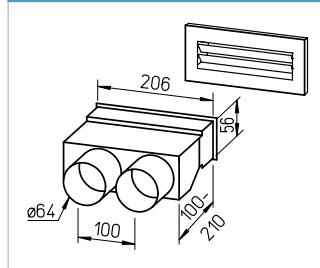

Wall outlet set, straight²⁾

Type	Ref. no.
Ø 63 mm	
FRS-WDS 2-63	09993

Wall outlet set consists of:
- Wall outlet with sliding connector
- Wall outlet white (FK-WA 200 W), 250 x 103 mm

Short bend 90°

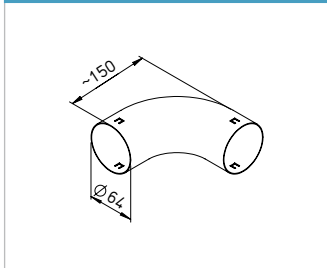

Short bend 90°

Type	Ref. no.
Ø 63 mm	
FRS-B 63	09348

Short bend 90° for bending radius < 2 x external duct diameter.

Angle bend set

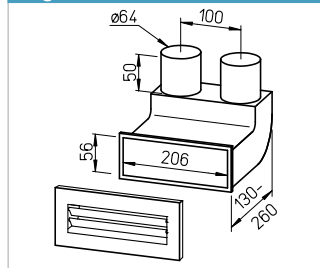

Angle bend set, 90°²⁾

Type	Ref. no.
Ø 63 mm	
FRS-WBS 2-63	09995

Angle bend set consists of:
- Angle bend with sliding connector
- Wall outlet white (FK-WA 200 W), 250 x 103 mm

Short bend 90°

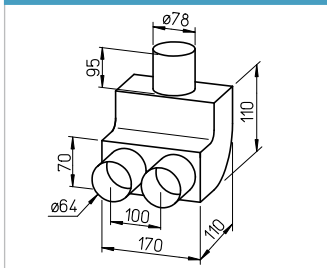

Short bend 90°

Type	Ref. no.
Ø 63 mm	
FRS-B 75/2-63	09341

Short bend 90° as transition from 1 x 75 mm to 2 hoses with 63 mm.

Sleeve, cover, seal ring

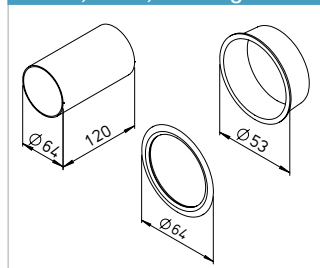

Sleeve, cover, seal ring

Type	Ref. no.	Unit
Ø 63 mm		
FRS-VM 63 Sleeve	09329	
FRS-VD 63 Cover	09330	10 pcs.
FRS-DR 63 Seal ring	09331	10 pcs.

Note: A seal ring (for IP66) must be used at every connection point (duct / duct, duct / moulded part). Please order corresponding number separately. Coating with lubricant is recommended for installation.

¹⁾ incl. 6 pcs. cover.

²⁾ incl. 1 pcs. cover.

IsoPipe facade panels



IsoPipe facade panels made of stainless steel for connection to intake air and exhaust air ducts.

■ Properties

All IsoPipe facade panels are made of high-quality stainless steel.

Also available in coated version (types B) for use in environments with severe air pollution or high salt concentration in the air (near the coast).

■ Application and installation

□ Facade combination panel IP-FKB

Designed for the compact installation of IsoPipe intake air and exhaust air ducts with just one facade panel. Universally applicable for horizontal or vertical installation.

Exhaust connectors can be positioned on the right, left or top.

□ Exhaust air facade panel IP-FBF

For the IsoPipe duct system. Horizontal installation position. The exhaust air is discharged directly and horizontally through the duct connectors.

□ Intake air facade panel IP-FBA

For the IsoPipe duct system. Horizontal installation position. The intake air is taken in through the side on both sides.

IP-FKB

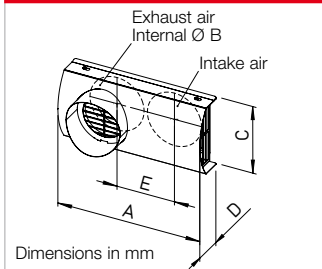

IsoPipe Ø 125 mm					IsoPipe Ø 160 mm					IsoPipe Ø 180 mm				
Type	Ref. no.				Type	Ref. no.				Type	Ref. no.			
Facade combination panel – Stainless steel														
IP-FKB 125	02689				IP-FKB 160	02694				IP-FKB 180	02695			
Dim. in mm	A	ØB	C	D E	Dim. in mm	A	ØB	C	D E	Dim. in mm	A	ØB	C	D E
	420	157	200	100 170		480	192	240	118 210		520	212	290	150 230
Facade combination panel – Stainless steel with additional coating														
IP-FKB 125 B	02661				IP-FKB 160 B	02662				IP-FKB 180 B	02663			
Dim. in mm	A	ØB	C	D E	Dim. in mm	A	ØB	C	D E	Dim. in mm	A	ØB	C	D E
	420	157	200	100 170		480	192	240	118 210		520	212	290	150 230

Exhaust air outlet on the right, left or top.

IP-FBF

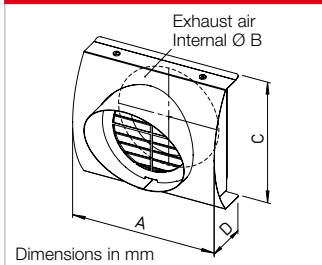

IsoPipe Ø 125 mm					IsoPipe Ø 160 mm					IsoPipe Ø 180 mm				
Type	Ref. no.				Type	Ref. no.				Type	Ref. no.			
Facade panel – Stainl. steel, for exh. air														
IP-FBF 125	03126				IP-FBF 160	03128				IP-FBF 180	03131			
Dim. in mm	A	ØB	C	D	Dim. in mm	A	ØB	C	D	Dim. in mm	A	ØB	C	D
	230	157	200	78		265	192	240	97		285	212	260	126
Facade panel – Stainl. steel, for exh. air with additional coating														
IP-FBF 125 B	02901				IP-FBF 160 B	02902				IP-FBF 180 B	02903			
Dim. in mm	A	ØB	C	D	Dim. in mm	A	ØB	C	D	Dim. in mm	A	ØB	C	D
	230	157	200	78		265	192	240	97		285	212	260	126

IP-FBA

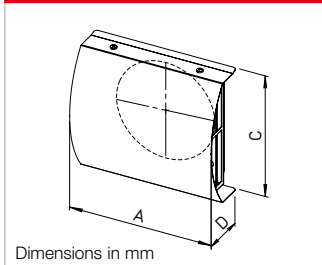

IsoPipe Ø 125 mm					IsoPipe Ø 160 mm					IsoPipe Ø 180 mm				
Type	Ref. no.				Type	Ref. no.				Type	Ref. no.			
Facade panel – Stainl. steel, for intake air														
IP-FBA 125	03125				IP-FBA 160	03127				IP-FBA 180	03130			
Dim. in mm	A	B	C		Dim. in mm	A	B	C		Dim. in mm	A	B	C	
	230	200	78			265	240	97			285	260	126	
Facade panel – Stainl. steel, for intake air with additional coating														
IP-FBA 125 B	02664				IP-FBA 160 B	02665				IP-FBA 180 B	02666			
Dim. in mm	A	B	C		Dim. in mm	A	B	C		Dim. in mm	A	B	C	
	230	200	78			265	240	97			285	260	126	

■ Installation

□ Types IP-FKB are universally applicable for horizontal or vertical installation. Exhaust air outlet on the right, left or top.

The adjacent figure shows horizontal installation in an external wall.

□ Types IP-FBF and IP-FBA for horizontal installation.



Insulated duct system IsoPipe



The innovative alternative to spiral duct installation with subsequent thermal insulation.

- The insulated round duct system IsoPipe
- prevents condensation,
- has a smooth, sound-absorbing inner surface and is easy to clean,
- saves an enormous amount of installation time,
- is the ideal solution for intake air and exhaust air ducting.

Installation

- All IsoPipe moulded parts, bends, wall outlets and roof outlets are precisely matched to each other and simply plugged into each other.
- IsoPipe is quick to install: Compared to the use of insulated spiral duct, the result is work time savings of up to 70 %.

Properties

All pipe parts are fully insulated and consist of vapour-tight, anti-static EPE. Flame retardant according to fire class B1. Air flow temperature from -25 to +80 °C. $\lambda = 0.04 \text{ W/mK}$, $d = 16 \text{ mm}$.

Duct concept and installation

- IsoPipe is especially suitable for intake air and exhaust air ducting or supply air and extract air ducting in the basement or low-temperature zone of a KWL system.
- Can be used for volume flows up to 500 m³/h.
- IsoPipe is shock-proof, particularly lightweight and it can easily be shortened to the desired length with a knife.

IsoPipe duct

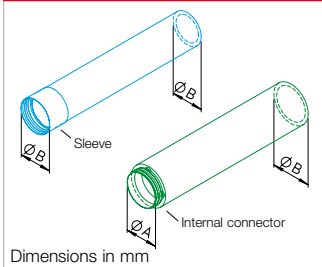

IsoPipe Ø 125 mm				IsoPipe Ø 160 mm				IsoPipe Ø 180 mm				IsoPipe Ø 200 mm							
Type	Ref. no.	Ø A	Ø B	Type	Ref. no.	Ø A	Ø B	Type	Ref. no.	Ø A	Ø B	Type	Ref. no.	Ø A	Ø B				
Duct with sleeve																			
IP 125/2000 ¹⁾	09406	—	157	—	—	—	—	—	—	—	—	—	—	—	—				
Duct with internal connector																			
—	—	—	—	IP 160/2000 ²⁾	09447	160	192	IP 180/2000 ³⁾	09448	180	212	IP 200/2000 ⁴⁾	03810	200	232				
				¹⁾ Unit = 8 x 2 m				²⁾ Unit = 6 x 2 m				³⁾ Unit = 4 x 2 m				⁴⁾ Unit = 3 x 2 m			

Sleeve / Internal connector

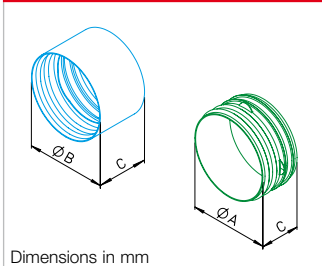

IsoPipe Ø 125 mm				IsoPipe Ø 160 mm				IsoPipe Ø 180 mm				IsoPipe Ø 200 mm							
Type	Ref. no.	Ø A	Ø B	C	Type	Ref. no.	Ø A	Ø B	C	Type	Ref. no.	Ø A	Ø B	C	Type	Ref. no.	Ø A	Ø B	C
Connecting sleeve																			
IP-MU 125	09394	—	157	104	—	—	—	—	—	—	—	—	—	—	—	—	—	—	—
Internal connector																			
—	—	—	—	—	IP-IV 160	09453	160	—	80	IP-IV 180	09454	180	—	80	IP-IV 200	03811	200	—	80

Made of plastic.

Bend 45°

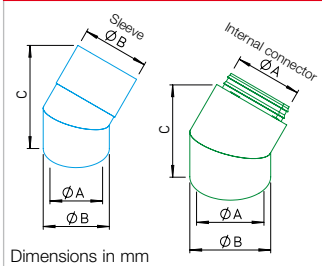

IsoPipe Ø 125 mm				IsoPipe Ø 160 mm				IsoPipe Ø 180 mm				IsoPipe Ø 200 mm							
Type	Ref. no.	Ø A	Ø B	C	Type	Ref. no.	Ø A	Ø B	C	Type	Ref. no.	Ø A	Ø B	C	Type	Ref. no.	Ø A	Ø B	C
Bend 45° with sleeve																			
IP-B 125/45	09399	125	157	255	—	—	—	—	—	—	—	—	—	—	—	—	—	—	—
Bend 45° with int. connector																			
—	—	—	—	—	IP-B 160/45	09449	160	192	242	IP-B 180/45	09450	180	212	256	IP-B 200/45	03809	200	232	270

Bend 90°

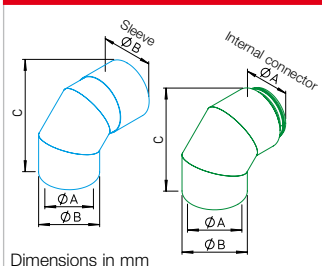

IsoPipe Ø 125 mm				IsoPipe Ø 160 mm				IsoPipe Ø 180 mm				IsoPipe Ø 200 mm							
Type	Ref. no.	Ø A	Ø B	C	Type	Ref. no.	Ø A	Ø B	C	Type	Ref. no.	Ø A	Ø B	C	Type	Ref. no.	Ø A	Ø B	C
Bend 90° with sleeve																			
IP-B 125/90	09398	125	157	239	—	—	—	—	—	—	—	—	—	—	—	—	—	—	—
Bend 90° with int. connector																			
—	—	—	—	—	IP-B 160/90	09451	160	192	272	IP-B 180/90	09452	180	212	292	IP-B 200/90	03808	200	232	312

Tape / Pipe clamp

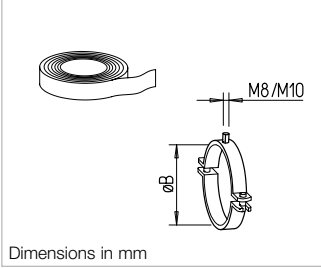

IsoPipe Ø 125 mm			IsoPipe Ø 160 mm			IsoPipe Ø 180 mm			IsoPipe Ø 200 mm		
Type	Ref. no.	Ø B	Type	Ref. no.	Ø B	Type	Ref. no.	Ø B	Type	Ref. no.	Ø B
Tape, insulated, 50x3 mm, 15 lin. m											
IP-KLB	09643		IP-KLB	09643		IP-KLB	09643		IP-KLB	09643	
Pipe clamp											
IP-S 125	09395	157	IP-S 160	09392	192	IP-S 180	09421	212	IP-S 200	03812	232

Fittings for unit connection

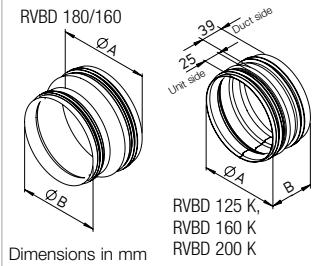

IsoPipe Ø 125 mm			IsoPipe Ø 160 mm			IsoPipe Ø 180 mm			IsoPipe Ø 200 mm		
Type	Ref. no.	Ø A B	Type	Ref. no.	Ø A B	Type	Ref. no.	Ø A B	Type	Ref. no.	Ø A B
Connector with seal for connection to KWL units – with sleeve DN 125											
RVBD 125 K ¹	03414	125 70	—	—	—	—	—	—	—	—	—
Connector with seal for connection to KWL units – with sleeve DN 160											
—	—	—	RVBD 160 K ²	03415	160 70	RVBD 180/160 ²	09589	180 160	—	—	—
Connector with seal for											
—	—	—	—	—	—	—	—	—	RVBD 200 K	03813	200 70

All fittings made of galvanised steel sheet.
¹ Compatible with KWL EC 170 W, KWL EC 200 W, KWL EC 300 W and KWL EC 220 D.
² Compatible with KWL EC 500 W and KWL EC 340 D.

Fittings for distribution box

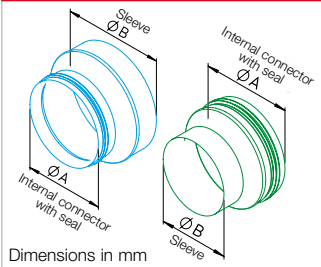

IsoPipe Ø 125 mm			IsoPipe Ø 160 mm			IsoPipe Ø 180 mm			IsoPipe Ø 200 mm		
Type	Ref. no.	Ø A Ø B	Type	Ref. no.	Ø A Ø B	Type	Ref. no.	Ø A Ø B	Type	Ref. no.	Ø A Ø B
Fitting for connection to distribution boxes – with connector DN 125											
Direct duct connection			IP-ARZ 125/160	09458	160 125	—	—	—	—	—	—
Fitting for connection to distribution boxes – with connector DN 160											
IP-ARZ 160/125	09358	125 160	Direct duct connection			IP-ARZ 160/180	09459	180 160	IP-ARZ 160/200	03816	200 160
Fitting for connection to distribution boxes – with connector DN 180											
IP-ARZ 180/125	09360	125 180	IP-ARZ 180/160	09455	160 180	Direct duct connection			IP-ARZ 180/200	03814	200 180

All fittings made of galvanised steel sheet.

Fittings for KWL HygroBox and ground heat exchange

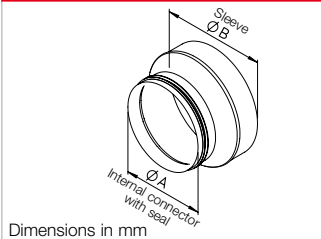

IsoPipe Ø 125 mm			IsoPipe Ø 160 mm			IsoPipe Ø 180 mm			IsoPipe Ø 200 mm		
Type	Ref. no.	Ø A Ø B	Type	Ref. no.	Ø A Ø B	Type	Ref. no.	Ø A Ø B	Type	Ref. no.	Ø A Ø B
Fitting for connection to KWL HygroBox – KWL HB 250, connec. DN 160											
IP-ARZ 160/125	09358	125 160	Direct duct connection			—	—	—	IP-ARZ160/200	03816	200 160
Fitting for connection to KWL HygroBox – KWL HB 500, connec. DN 250											
—	—	—	IP-ARZ 250/160	09590	160 250	IP-ARZ 250/180	09591	180 250	IP-ARZ 250/200	03815	200 250
Fitting for connection to ground heat exchanger – LEWT, connector DN 200											
IP-ARZ 200/125	09359	125 200	IP-ARZ 200/160	09456	160 200	IP-ARZ 200/180	09457	180 200	Direct duct connection		
Fitting for connection to ground heat exchanger – SEWT, connector DN 180											
IP-ARZ 180/125	09360	125 180	IP-ARZ 180/160	09455	160 180	Direct duct connection			IP-ARZ 180/200	03814	200 180

All fittings made of galvanised steel sheet.

Roof outlets

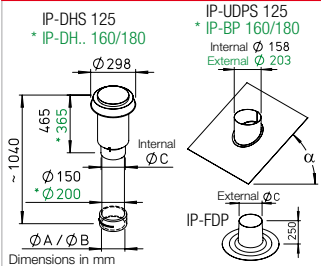

IsoPipe Ø 125 mm			IsoPipe Ø 160 mm			IsoPipe Ø 180 mm		
Type	Ref. no.	Ø B Ø C	Type	Ref. no.	Ø B Ø C	Type	Ref. no.	Ø A Ø C
Roof outlet, consisting of hood and pan tile* – Roof hood black								
IP-DHS 125	03541	157 160	IP-DHS 160	03542	192 250	IP-DHS 180	03542	180 210
Roof outlet, consisting of hood and pan tile* – Roof hood including duct red								
—	—	—	IP-DHR 160	03543	192 250	IP-DHR 180	03543	180 210
Roof outlet, consisting of hood and pan tile* – Roof pan tile for pitched roofs, with lead edge								
IP-UDPS 125	03546	α 25°–45°	IP-BP 160/25	09384	α 20°–30°	IP-BP 180/25	09384	α 20°–30°
—	—	—	IP-BP 160/35	09385	α 30°–40°	IP-BP 180/35	09385	α 30°–40°
—	—	—	IP-BP 160/45	09386	α 40°–50°	IP-BP 180/45	09386	α 40°–50°
Roof outlet, consisting of hood and pan tile* – Roof pan tile for flat roof								
IP-FDP 125	03544	— 158	IP-FDP 160	03545	— 203	IP-FDP 180	03545	— 203

* Please order roof hoods and pan tiles separately.

Silencer



IsoPipe Ø 125 mm		IsoPipe Ø 160 mm		IsoPipe Ø 180 mm				
Type	Ref. no.	Type	Ref. no.	Type	Ref. no.			
Flexible duct silencer, made of aluminium duct, Length approx. 1 m, elastic								
SDE 125	00789	SDE 160	00790	SDE 180	00499			
Type	Insulation mm	Insertion loss dB at Hz						
		125	250	500	1000	2000	4000	8000
SDE 125	50	32	42	45	46	50	42	41
SDE 160	50	23	40	43	46	46	31	29
SDE 180	50	20	39	43	47	46	28	29

Air distribution system renopipe

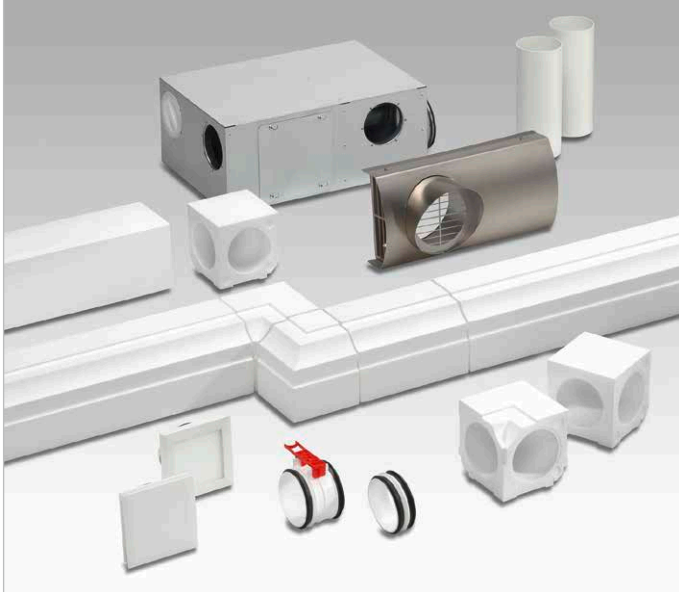

The smart solution, specifically developed for energy-saving renovation: renopipe combines ducting and ventilation duct cladding in one component.

- Quick, easy installation, even in occupied buildings.
- Installation without rework possible in drywall construction.
- Minimisation of material usage and costs.
- Cost-effective due to few components and elimination of exhaust air piping.

Installation

- The RP moulded parts can be easily shortened to the desired length with a fine-toothed saw.
- Visible installation in ceilings or walls by clicking the long connector into the mounting brackets included in the delivery.
- Free cuts in the duct compensate for unevenness, miter cuts are unnecessary due to precision-fit moulded parts.

Fastening elements with longitudinal, lateral and height compensation guarantee a precise fit.

Properties and advantages

- Coatable components made of smooth, high-density EPS in white.
- Quick visible installation, without elaborate ceiling suspensions and drywall construction work.

Duct concept, installation

- The extract air from the adjoining extract air rooms is collected directly in the sound-insulated combination distributor. There is no extract air piping or separate silencers.
- Asymmetric lip seals ensure the leak tightness of the entire renopipe system.

Combination distribution box, supply air right

Compact distributor made of galvanised steel sheet with sound-absorbing lining of inner sides. Properties: Extract air collector, supply air distributor with sound insulation function. Unit connection 2 x DN 125, 2 x DN 100 for extract air, 2 x DN 100 for supply air. Incl. inspection opening and cover. **RP-KVK 3-100/125 R** No. 03048

Combination distributor

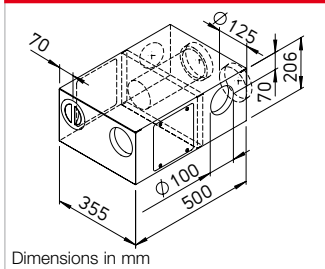

Duct piece

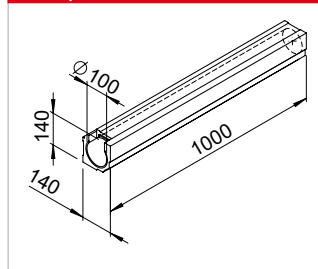

Duct Unit = 4 pcs.*
 Duct with smooth, square profile. Internal diameter DN 100, length 1 m.
RP-K Ref. no. 03061

Duct with stucco profile Unit = 4 pcs.*
 Like above but with visually appealing stucco profile.
RP-SK Ref. no. 03065

Combination distribution box, supply air left

Compact distributor made of galvanised steel sheet with sound-absorbing lining of inner sides. Properties: Extract air collector, supply air distributor with sound insulation function. Unit connection 2 x DN 125, 2 x DN 100 for extract air, 2 x DN 100 for supply air. Incl. inspection opening and cover. **RP-KVK 3-100/125 L** No. 03038

Combination distributor

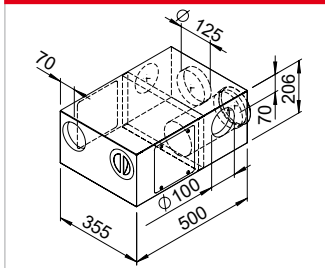

T-piece

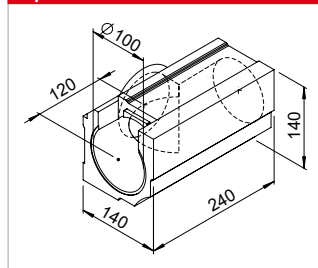

T-piece Unit = 4 pcs.*
 Compact T-piece with smooth, square profile. Internal diameter DN 100/100/100.
RP-T Ref. no. 03062

T-piece with stucco Unit = 4 pcs.*
 Like above but with visually appealing stucco profile.
RP-ST Ref. no. 03066

Long connector set

Consists of a connecting sleeve DN 100 made of impact-resistant polypropylene and two lip seals for airtight connection of the duct. Includes mounting bracket for simple click installation of the duct. **RP-LV** Ref. no. 03029

Long connector set

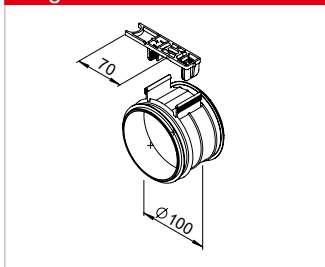

Inner angle

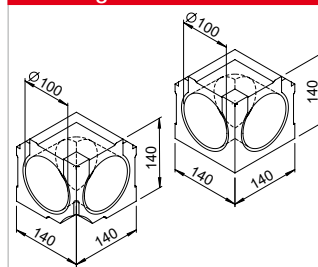

Inner angle Unit = 2 pcs.*
 90° inner angle with smooth, square profile. Internal diameter DN 100.
RP-IW Ref. no. 03075

Inner angle with stucco Unit = 2 pcs.*
 Like above but with visually appealing stucco profile.
RP-SIW Ref. no. 03077

Long connector set

Consists of a connecting sleeve DN 100 made of impact-resistant polypropylene and two lip seals for airtight connection of the duct. Includes mounting bracket for simple click installation of the duct. **RP-KV** Ref. no. 03030

Short connector

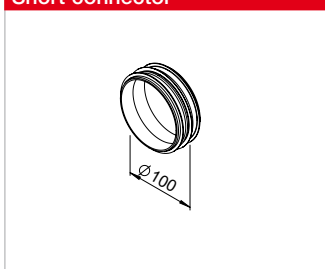

Outer angle

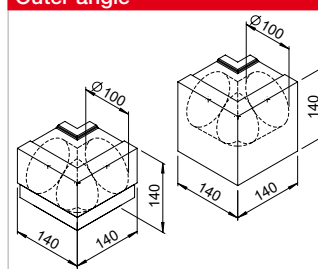

Outer angle Unit = 2 pcs.*
 90° outer angle with smooth, square profile. Internal diameter DN 100.
RP-AW Ref. no. 03076

Outer angle with stucco Unit = 2 pcs.*
 Like above but with visually appealing stucco profile.
RP-SAW Ref. no. 03078

* Delivered in packaging units.

Design ventilation valve

Design ventilation valve for extract air operation, DN 100, adjustable. With closed front and integrated filter.

DLV 100 Ref. no. 03039

Replacement

air filter Unit = 5 pcs.*

ELF-DLV 100 Ref. no. 03042

Ventilation valve

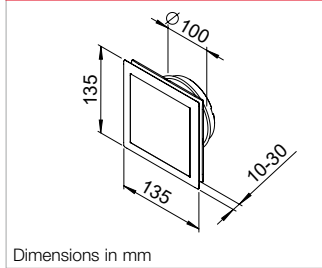

Dimensions in mm

Cutting aid

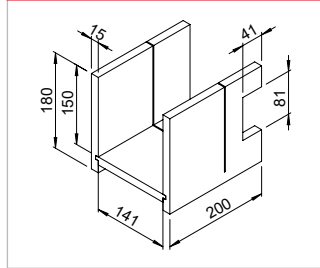

Cutting aid

Stable cutting aid, beech multiplex 15 mm, for easy cutting of duct to length.

RP-SH Ref. no. 03036

Design ventilation valve, for supply air

Design ventilation valve for supply air operation, DN 100.

DLVZ 100 Ref. no. 03040

Ventilation valve

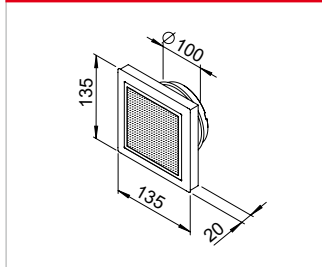

Fine-toothed saw

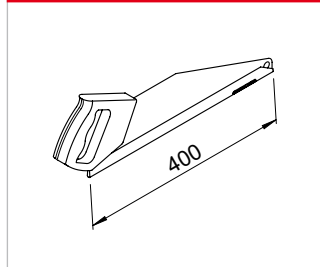

Fine-toothed saw

Special fine-toothed handsaw for precise cuts.

RP-FS Ref. no. 03044

Facade combination panel

For intake air and exhaust air ducts. Universally applicable. Elegant, made of high-quality stainless steel. Connection DN 125.

IP-FKB 125 Ref. no. 02689

With additional coating for use in environments with severe air pollution or high salt concentration in the air.

IP-FKB 125 B Ref. no. 02661

Facade combination panel

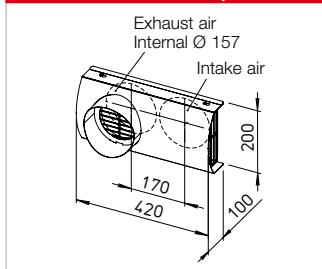

Bracket

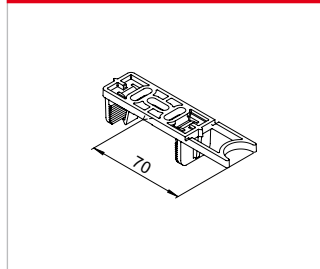

Mounting bracket

Unit = 5 pcs.*
Made of high-quality, impact-resistant plastic.

RP-BK Ref. no. 03031

Exhaust air panel

Elegant, made of high-quality stainless steel. Connection DN 125.

IP-FBF 125 Ref. no. 03126

With additional coating for use in environments with severe air pollution or high salt concentration in the air.

IP-FBF 125 B Ref. no. 02901

Exhaust air panel

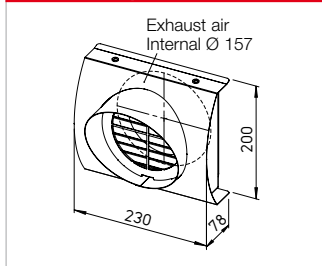

Seal

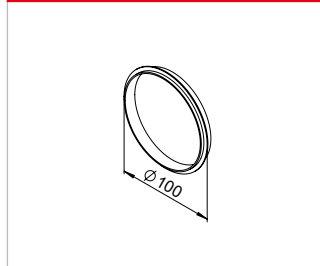

Lip seal

Unit = 10 pcs.*

DN 100 made of EPDM.
RP-LD Ref. no. 03033

Intake air panel

Elegant, made of high-quality stainless steel. Connection DN 125.

IP-FBA 125 Ref. no. 03125

With additional coating for use in environments with severe air pollution or high salt concentration in the air.

IP-FBA 125 B Ref. no. 02664

Intake air panel

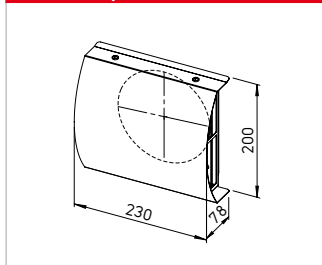

End/inspection cover



End/inspection cover

DN 100 made of high-quality plastic, with lip seal. For attachment to an duct end piece.

RP-RD Ref. no. 03037

Wall sleeve

DN 100 made of PVC, incl. mounting template for simple wall outlet.

RP-WH Ref. no. 03035

Wall sleeve

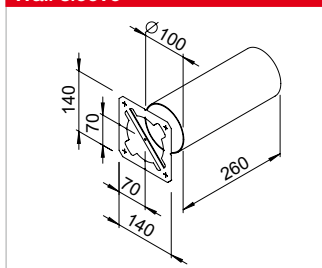

Reducer

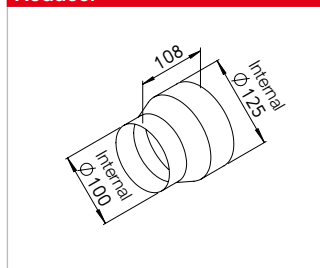

Reducer

Made of galvanised steel sheet.

RP-RZ 125/100 Ref. no. 03017

* Delivered in packaging units.

Flat duct system FK

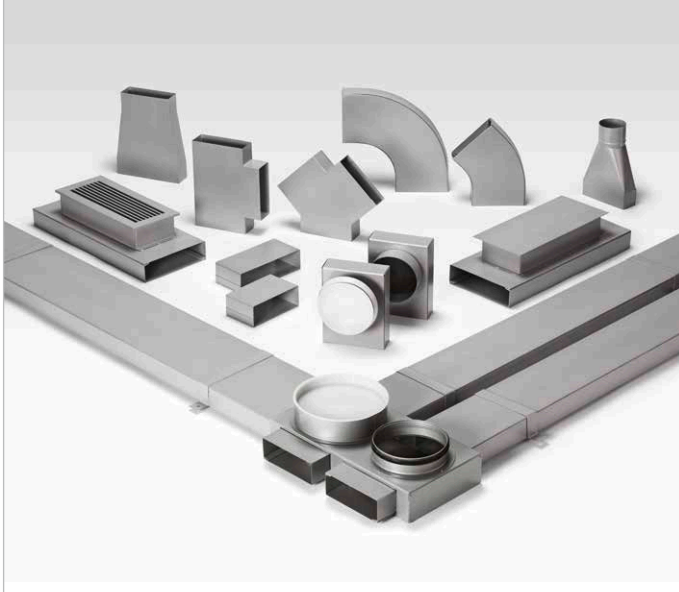

Underfloor duct system made of galvanised steel sheet, specifically developed for domestic ventilation. The optimal solution for concealed air ducts; ideal for air distribution in new buildings.

■ Properties

- All components made of galvanised steel sheet, corrosion-resistant and non-flammable.

■ Available in two sizes

- FK 150 x 50 mm for volume flows up to 90 m³/h.
- FK 200 x 50 mm for volume flows up to 140 m³/h.

■ Duct concept and installation

- Flat design and rigid construction allow easy installation in unfinished flooring.
- Connection using external connector. Moulded parts with integrated sleeve (insertion depth approx. 35 mm). The smooth internal walls result in low flow resistances and do not create obstacles for dirt deposits. Cleaning (disinfection) is still possible.
- The distribution box, which must be installed per floor for extract and supply air delivery, simplifies the duct layout.
- Flat silencers (FK-SD) can be installed in the duct system to protect noise-sensitive rooms, e.g. bedrooms.

Flat duct

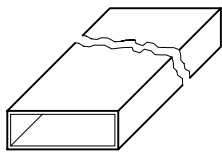

Dimensions in mm

Flat duct

Type	Ref. no.	Width	Height	Length
150 x 50 m				
FK 150	02905	150	50	1500
200 x 50 mm				
FK 200	02906	200	50	1500

Bend, horizontal 45°

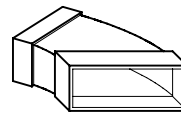

Bend, horizontal 45°

Type	Ref. no.	Width	Height	Radius
150 x 50 m				
FK-BH 150/45	02910	153	53	45°
200 x 50 mm				
FK-BH 200/45	02912	203	53	45°

Connector



Connector

Type	Ref. no.	Width	Height	Length
150 x 50 m				
FK-V 150	02941	153	53	200
200 x 50 mm				
FK-V 200	02942	203	53	200

Bend, vertical 90°

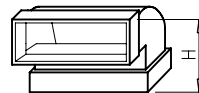

Bend, vertical 90°

Type	Ref. no.	Width	Height	Radius
150 x 50 m				
FK-BV 150/90	02919	153	103	90°
200 x 50 mm				
FK-BV 200/90	02920	203	103	90°

Mounting bracket

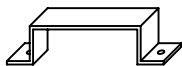

Mounting bracket

Type	Ref. no.	Width	Height	Length
150 x 50 m				
FK-B 150	02907	151	52	30
200 x 50 mm				
FK-B 200	02908	201	52	30

Bend, vertical 45°

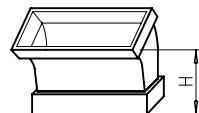

Bend, vertical 45°

Type	Ref. no.	Width	Height	Radius
150 x 50 m				
FK-BV 150/45	02917	153	73	45°
200 x 50 mm				
FK-BV 200/45	02918	203	73	45°

Bend, horizontal 90°



Bend, horizontal 90°

Type	Ref. no.	Width	Height	Radius
150 x 50 m				
FK-BH 150/90	02909	153	53	90°
200 x 50 mm				
FK-BH 200/90	02911	203	53	90°

Y-branch

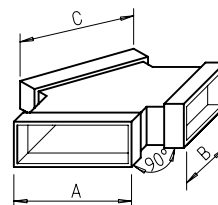

Y-branch

Type	Ref. no.	Dim. in mm	A	B	C
150 x 50 m					
FK-Y 150/150/150	02927	153	153	153	
200 x 50 mm					
FK-Y 200/150/150	02929	153	153	203	

T-piece

Dimensions in mm

T-piece					
Type	Ref. no.	Dim. in mm			
		A	B	C	E
FK-T 150/150/150	02921	153	153	153	250
FK-T 150/150/200	02923	153	153	203	390
FK-T 150/200/150	02926	153	203	153	300
FK-T 200/150/200	02925	203	153	203	250
FK-T 150/200/200	02924	153	203	203	440
FK-T 200/200/200	02922	203	203	203	300

Transition piece

Transition piece				
Type	Ref. no.	Dim. in mm		
		A	Ø B	C
150 x 50 mm				
FK-Ü 75/150	02948	153	78	260
FK-Ü 100/150	02996	153	103	260
200 x 50 mm				
FK-Ü 100/200	02997	203	103	260
FK-Ü 125/200	02998	203	128	260

Reducers

Reducers			
Type	Ref. no.	Dim. in mm	
		Length	Height
Reducer symmetrical			
FK-RS 200/150	02932	260	53
Reducer asymmetrical			
FK-RA 200/150	02933	260	53

Outlet

Ceiling/wall outlet				
Type	Ref. no.	Colour	Dim. in mm	
			A	B
200 x 50 mm				
FK-WA 200 W	09350	White	250	103
FK-WA 200 AL	09351	Alum.	250	103

End piece – Spiral duct

End piece with connection for spiral duct			
Type	Ref. no.	Dim. in mm	
		Ø D	L
150 x 50 mm			
FK-ER 150/100	02934	99	200
FK-ER 150/125	02935	124	200
200 x 50 mm			
FK-ER 200/160	02936	159	220

Silencer

Silencer			
Type	Ref. no.	Dim. in mm	
		A	B
150 x 50 mm			
FK-SD 150	02945	153	53
200 x 50 mm			
FK-SD 200	02946	203	53

End piece – Valve

End piece with connection for spiral duct			
Type	Ref. no.	Dim. in mm	
		Ø D	L
150 x 50 mm			
FK-EV 150/100	02937	102	200
FK-EV 150/125	02938	127	200
200 x 50 mm			
FK-EV 200/100	02939	102	200
FK-EV 200/125	02940	127	200

Distribution box

Add. connector

Distribution box	
Type	Ref. no.
FK-VK	02987
Delivery FK-VK	
4 connectors 150 x 50 (2 enclosed loose),	
1 connectors 200 x 50 and 1 inspection panel.	
Add. connectors for straight distributor	
FK-ZS	02947

Inspection piece

Inspection piece					
Type	Ref. no.	Dim. in mm			
		A	B	C	D L
150 x 50 mm					
FK-RZ 150	02930	153	53	347	137 500
200 x 50 mm					
FK-RZ 200	02931	203	53	347	137 500

Dim. E can vary from 105-130 mm.

End cover

End cover	
Type	Ref. no.
150 x 50 mm	
FK-ED 150	02943
200 x 50 mm	
FK-ED 200	02944

Floor grille

Aluminium floor grille with inst. casing				
Type	Ref. no.	Dim. in mm		
		A	B	C D L
150 x 50 mm				
FK-BA 150	02986	153	53	348 152 500

Dim. E can vary from 112-152 mm.

Sealing tape

Sealing tape/Tape	
Type	Ref. no.
Cold shrink tape	
KSB	09343 50 mm wide, 15 lin. m
Aluminium cold shrink tape	
KSB ALU	09344 50 mm wide, 15 lin. m
Tape	
KLB	00619 50 mm wide, 20 lin. m

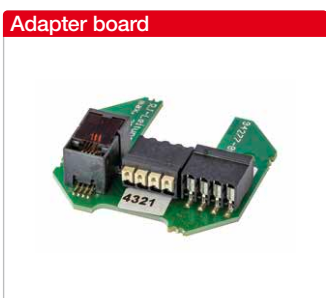

Design ventilation valves and disc valves
For extract air delivery at high and low flow rates or resistances. DLV with visually closed front design and integrated filter.

Design ventilation valves and disc valves
For supply air delivery at high and low flow rates or resistances. DLV 125 with visually closed front design and integrated filter.

Supply air-extract air valve ZAV
Elegant plastic valve for wall and ceiling installation. Can be used as a wall element with open front grille. Ceiling installation with closed front grille. Flexible application as supply air valve or extract air valve.

Attachment filter element VFE
For installation in front of disc valves for greasy, contaminated room air. Prevents grease and dirt deposits. Casing made of galvanised steel sheet, white, plastic powder-coated. Filter made of dimensionally stable aluminium filter fabric with 324 cm² free filter surface and aluminium frame.

Control lines
8-pin AWG24 twisted pair cable for the control element for types KWL EC 700 D to KWL EC 2600 S and KWL YOGA from 400 to 1000.

Adapter board
Adapter from flat ribbon cable to stranded wire or cable. For connection of KNX module and RJ10 control line. See KWL unit product pages for description of KNX module.

Type KWL-RJ10 KL No. 04277

Ø 80		Ø 100		Ø 125		Ø 160	
Type	Ref. no.	Type	Ref. no.	Type	Ref. no.	Type	Ref. no.
Design ventilation valve DLV¹⁾ for extract air							
		DLV 100	03039	DLV 125	03049		
		ELF-DLV 100 ²⁾	03042	ELF-DLV 125 ²⁾	03058		
Plastic disc valve KTVA							
KTVA 75/80	00940	KTVA 100	00941	KTVA 125	00942	KTVA 160	00943
Metal disc valve for extract air (for areas where non-flammable components are compulsory)							
MTVA 75/80	08868	MTVA 100	08869	MTVA 125	08870	MTVA 160	08871

¹⁾ With integrated filter. ²⁾ Replacement air filter for DLV, unit = 5 pcs.

Ø 80		Ø 100		Ø 125		Ø 160	
Type	Ref. no.	Type	Ref. no.	Type	Ref. no.	Type	Ref. no.
Ventilation grille LGK, Design ventilation valve DLV for supply air							
LGK 80	00259	DLVZ 100	03040	DLV 125	03049		
				ELF-DLV 125 ¹⁾	03058		
Plastic disc valve KTVZ							
KTVZ 80	02762	KTVZ 100	02736	KTVZ 125	02737	KTVZ 160	02738
Metal disc valve for supply air (for areas where non-flammable components are compulsory)							
MTVZ 75/80	09603	MTVZ 100	09604	MTVZ 125	09605	MTVZ 160	09606

¹⁾ Replacement air filter for DLV 125, unit = 5 pcs.

Ø 80		Ø 100		Ø 125		Ø 160	
Type	Ref. no.	Type	Ref. no.	Type	Ref. no.	Type	Ref. no.
Plastic valve for supply and extract air ZAV							
ZAV 80	03079			ZAV 125	03080		

VFE 70 Ref. no. 02552

VFE 90 Ref. no. 02553

ELF/VFE Ref. no. 02554

Replacement air filter, unit = 2 pcs.

For control element KWL EC 700 D - 2600 S and KWL YOGA 400 - 1000 (8-pin AWG24 twisted pair cable)		
Cable length	Type	Ref. no.
20 metres	ALB EC-SK 20	06816
40 metres	ALB EC-SK 40	06817

Other accessories	Page
– Enthalpy heat exchanger	99
– Flexible duct system	146
– Insulated duct system	156 ff.
– Air distrib. systems	158 ff.
– HygroBox	164 ff.
– Ground heat exchang.	166 ff.
– Fire prot. elements	582 ff.

Accessory details	
Dimensions, further technical information and other sizes:	
Warm water heating elements and temp. control systems	482 ff.
Ventilation grilles, ducts, moulded parts, roof outlets	553 ff.
Extract air elements, attachment filter elements	566 ff.
Disc valves	574 ff.

Shutters



Silencer



Warm water heating element



Door ventilation grilles



Cleaning set



Air temperature control



Hydraulic unit



	Ø 100	Ø 125	Ø 160	Ø 200	Ø 250	Ø 315	Ø 355	Ø 400							
Flexible connecting sleeve – For acoustic decoupling, incl. 2 pcs. hose clamps															
FM 100	01681	FM 125	01682	FM 160	01684	FM 200	01670	FM 250	01672	FM 315	01674	FM 355	01675	FM 400	01676
Duct shutters – Self-actuating or **motorised, installed in pipeline, casing made of galvanised steel sheet or *plastic															
RSKK* 100	05106	RSKK* 125	05107	RSK 160	05669	RSK 200	05074	RSK 250	05673	RSK 315	05674	RSK 355	05650	RSK 400	05651
						RVM** 250	02576	RVM** 315	02578	RVM** 355	02579	RVM** 400	02580		
KAK 100	04097	KAK 125	04098	KAK 160	04099	KAK 200	04100	Cold smoke shutter							
Flexible cross talk silencer FSD¹⁾, duct silencer RSD¹⁾ – Galvanised steel sheet									Duct silencer SDE see page 157						
FSD 100	00676	FSD 125	00677	FSD 160	00678	FSD 200	00679	FSD 250	00680	FSD 315	00681	FSD 355	00682	FSD 400	00683
								RSD 250	08739	RSD 315	08745	RSD 355	08748	RSD 400	08751

¹⁾ See product page for average insulation dimension.

Type	Ref. no.	Compatible with duct Ø mm	Air-side data					Water-side data ¹⁾			Compatible temperature control system	
			Heat output kW ¹⁾ kW ²⁾	Δ T air K ¹⁾ K ²⁾	at V m ³ /h	Pressure loss Δp _w kPa	with water volume l/h	Weight approx. kg	Type	Ref. no.		
WHR 100	09479	100	1.9 0.9	35 17	150	1	84	3.2	WHST 300 T50	08820		
WHR 125	09480	125	2.6 1.1	29 13	250	2	115	3.2	WHST 300 T50	08820		
WHR 160	09481	160	5.5 3.1	38 22	400	11	245	4.9	WHST 300 T50	08820		
WHR 200	09482	200	7.2 4.1	33 19	600	17	317	4.9	WHST 300 T50	08820		
WHR 250	09483	250	10.7 6.0	37 21	800	8	470	6.9	WHS H HE 24 V	08318		
WHR 315	09484	351	18.3 10.4	36,2 21	1400	9	810	9.0	WHS H HE 24 V	08318		
WHR 400	09524	400	26.2 15.0	36 21	2000	11	1060	12.5	WHS H HE 24 V	08318		

Door ventilation grilles

Unobtrusive, sight screening ventilation grille made of break-resistant plastic for installation in door leaf.

See product page for detailed description.

LTGW Ref. no. 00246

Made of plastic, white.

LTGB Ref. no. 00247

Made of plastic, brown.

Cleaning set for air distribution systems flexpipe and renopipe.

The universal cleaning set KWL-RS is ideally suitable for cleaning the **flexpipe** duct systems (DN 75, DN 63) and the **renopipe** air distribution system (DN 100).

Application is possible either by pushing (for short distances) or pulling. In case of longer duct sections or narrow bends, the round nylon brush is simply pulled in the

direction of the distribution box, where the 90° bend is used for the intake connection. This is used to easily remove the dust loosened by the round nylon brush with a commercially available vacuum cleaner.

Delivered in a practical transport bag.

Delivery: Per 1 pc.

- Reel with flexible GFK wire (20 linear m.)
- Round brushes DN 63, 75, 100
- 90° bend and seal for intake connection DN 56
- Adapter DN 56/40, DN 56/32.

KWL-RS Ref. no. 02797

Air temperature control for KWL units with PWW post-heater.

For air heating control of the PWW post-heater integrated in KWL WW types. Consists of thermostat with remote adjustment and remote sensor. Simple, cost-effective and quick-to-install solution.

Temperature range 8 – 38 °C.

WHST 300 T38 Ref. no. 08817

Air temperature control



Air temperature control for warm water heating element WHR.

Ideal for use as supply air heater. Consists of thermostat incl. duct temperature sensor (with 2 m capillary tube) and valve. Provides a constant supply air temperature. Simple, cost-effective and quick-to-install solution.

Temperature range 20 – 50 °C.

WHST 300 T50 Ref. no. 08820

Hydraulic unit

Controls the water temperature of the PWW heating element using a three-way valve actuator 24 V (0-10 V) and thus the heat output transferred to the air. Delivered as a complete unit, incl. VL-/RL temperature display, circulating pump and flexible connection hoses.

WHS H HE 24 V (0-10V) No. 08318

Weekly timer



Weekly timer

Digital timer with LCD display for autom. control of op. mode, programmable for every weekday. Surface and flush-mounted install. Dim. mm (WxHxD) 84 x 84 x 40

WSUP Ref. no. 09990

For switch cabinet installation (2 space units required).

Dim. mm (WxHxD) 36 x 90 x 63

WSUP-S Ref. no. 09577

WHR: The values apply for supply air temp. 0 °C and flow/return temperatures: ¹⁾ 90/70 °C, ²⁾ 60/40 °C.

KWL HBX



Dimensions KWL HBX 250.. L

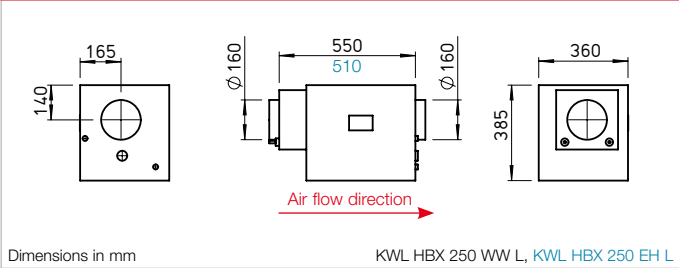

Dimensions KWL HBX 500.. L

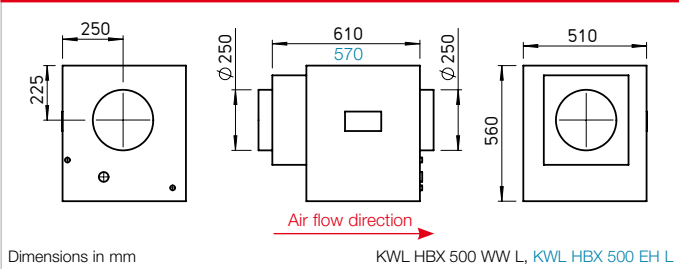

Designed specifically for ventilation systems in residential buildings and offices, the Helios HygroBox automatically guarantees a healthy feel-good atmosphere with ideal air humidity throughout the year.

Advantages

- Constant indoor climate with ideal moisture content.
- Prevention of expensive damage to furniture, wooden floor coverings and antiques.
- Alleviation of allergy symptoms and health impacts. Strengthening of the immune system by reducing the lifetime of bacteria and viruses.
- Reduction of fine dust and electrostatic charges.

Special HygroBox features

- Constant supply air humidity and temperature in all rooms.
- The principle of natural evaporation prevents excessive humidification.
- Hygienically safe due to UVC disinfection.
- Fully automated operation with automatic summer deactivation.
- Low-maintenance and easy to install.
- Low operating costs through the use of evaporation energy from the existing heating system.

Functional principle

The HygroBox is an active humidification unit for integration in new or existing KWL ventilation units with heat recovery. The fresh intake air flows through the KWL unit heat exchanger and absorbs the thermal energy from the extract air. This pre-heated air is then delivered to the HygroBox, where active and automatic humidification takes place according to the principle

of natural evaporation. A bladed rotor rotates continuously in a water bath inside the unit and releases water molecules into the preheated supply air via the wetted blade surface. Regardless of the KWL unit operating level and external weather influences, the HygroBox constantly maintains the preselected relative air humidity and thus guarantees a healthy feel-good atmosphere with ideal moisture content.

Delivery

Delivered as a plug-in compact unit including water supply hoses and water filter.

Heating element

- The HygroBox is equipped with a warm water (WW types) or electric heating element (EH types). This heats the supply air before humidification and thereby guarantees the required evaporation energy and pleasant supply air temperature.
- With regard to heating systems with low flow temperature (e.g. heat pumps), a low-temperature heating element (type KWL-NHR, accessories, see right page) must be connected downstream of the HygroBox.

Summer operation

- The HygroBox automatically switches to standby mode when the moisture content of the intake air is sufficiently high (e.g. in summer). In this state, there is no water in the unit and the remains at a standstill.

Pressure loss KWL HBX

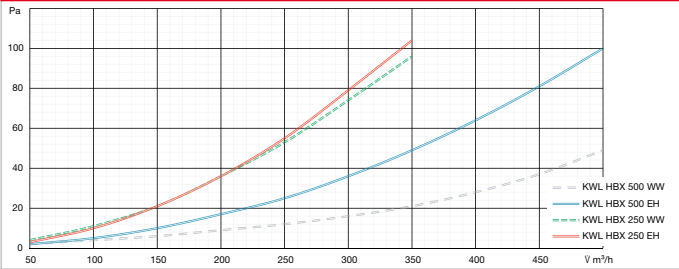

Schematic diagram KWL HBX.. WW R

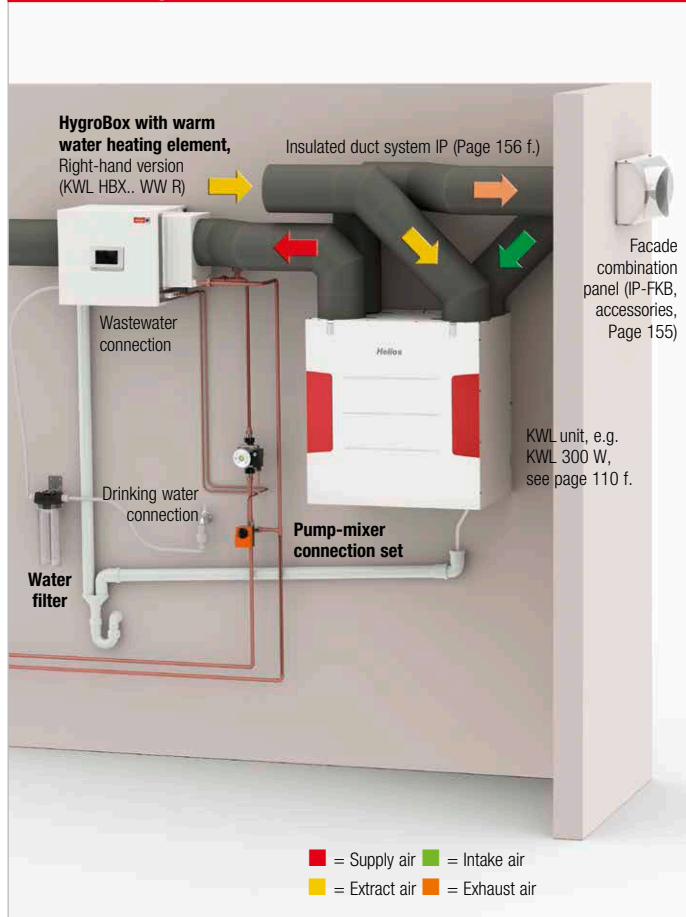



Low-temperature heating element (for KWL HBX.. WW)

Description

- The additional installation of a post-heating element on the HygroBox air outlet is recommended in combination with low-temperature heaters to compensate for the evaporative cooling.
- The external temperature sensor, which is included in the delivery of the post-heating element, must be installed in the supply air duct at a distance of approx. 50 cm behind the post-heating element.

Accessories

Low-temperature post-heating element

- for KWL HBX 250 WW
KWL-NHR 250 Ref. no. 05628
- for KWL HBX 500 WW
KWL-NHR 500 Ref. no. 05633



Pump-mixer connection set (for KWL HBX.. WW)

Description

- For connection of the HygroBox to existing heating circuits.
- Consists of:
 - 1 pc. circulating pump 230 V
 - 2 pc. screw fittings, R 1/2a/15 mm MS (brass)
 - 1 pc. 3-way mixer valve with actuator 230 V, Rp1/2", DN 15.

Accessories

Pump-mixer connection set

- for KWL HBX 250 WW
KWL-PMAS 250 Ref. no. 40193
- for KWL HBX 500 WW
KWL-PMAS 500 Ref. no. 40194



Replacement UVC ducts and osmosis membrane (for all types)

Description

- Helios HygroBoxes are equipped with a constant, automatically monitored UVC disinfection system which effectively kills all germs and bacteria.
- In addition, the water in the evaporator tray is automatically changed depending on the water hardness and evaporation performance.
- A reverse osmosis unit protects the unit against limescale deposits.
- The hygienic safety of the HygroBox is documented and certified by experts.

Accessories

Replacement UVC ducts

KWL-UVR Ref. no. 05631

Replacement osmosis membrane

KWL-OME Ref. no. 05632



Replacement water filter (for all types)

- As a general rule, the water filter in the water supply pipe must be replaced every 6 months. The filter replacement is indicated on the HygroBox display.

Accessories

Replacement water filter
Unit = 1 pc. filter cartridge
(without casing, without hoses)

KWL-WF Ref. no. 05630

Technical data	With electric heating element		With warm water heating element	
	For KWL units up to 250 m³/h flow rate	For KWL units up to 500 m³/h flow rate	For KWL units up to 250 m³/h flow rate	For KWL units up to 500 m³/h flow rate
	NEW	NEW	NEW	NEW
	Type	Ref. no.	Type	Ref. no.
Right-hand version (air outlet right)	KWL HBX 250 EH R	40188	KWL HBX 500 EH R	40192
Left-hand version (air outlet left)	KWL HBX 250 EH L	40187	KWL HBX 500 EH L	40191
Adjustable relative supply air humidity in %	40-60		40-60	
Adjustable supply air temperature °C	15-25		15-25	
Air volume flow m³/h	350		500	
Power consumption max. W	1450		2850	
Heat output W	1400		2800	
Voltage/Frequency	230 V~, 50 Hz		230 V~, 50 Hz	
Water connection	3/4"		3/4"	
Water drain Ø mm	40-50		40-50	
Weight (empty weight/operating weight) approx. kg	25		47	
Accessories				
Pump-mixer connection set	—	—	KWL-PMAS 250	KWL-PMAS 500
Ref. no.	—	—	40193	40194
Low-temperature post-heating element	—	—	KWL-NHR 250	KWL-NHR 500
Ref. no.	—	—	05628	05633
UVC ducts	KWL-UVR	KWL-UVR	KWL-UVR	KWL-UVR
Ref. no.	05631	05631	05631	05631
Water filter	KWL-WF	KWL-WF	KWL-WF	KWL-WF
Ref. no.	05630	05630	05630	05630
Osmosis membrane	KWL-OME	KWL-OME	KWL-OME	KWL-OME
Ref. no.	05632	05632	05632	05632

SEWT kit



The ground-to-brine heat exchanger SEWT significantly increases the efficiency of ventilation units with heat recovery! SEWT saves even more energy and minimises heating costs. The optimal addition for ventilation units with heat recovery.

Advantages

- Additional preheating and prevention of icing during the cold season.
- Pleasant "natural cooling" on hot days.
- Complete kit with coordinated components.

Functional principle

The ground-to-brine heat exchanger SEWT utilises the ground temperature which is relatively constant throughout the year. The ground collector pipe is installed and laid in the ground at a depth of approx. 1.2 m. The hydraulic unit ensures the circulation of the brine depending on the outdoor temperature. The brine serves as a heat transfer medium and releases the heat to the supply air through the heat exchanger module.

This results in the following:

- During the cold season**
The preheating of cold intake air of up to 14 K. Thus, the intake air is normally at a temperature above 0 °C when it reaches the ventilation unit with heat recovery (anti-icing operation). This results in a higher supply air temperature and a positive effect on the total energy balance. Post-heating is only necessary in case of very low outdoor temperatures.

- On hot summer days**
The ground-to-brine heat exchanger reduces the intake air temperature.
- During the transitional period**
The brine is circulated depending on the outdoor temperature measured via the thermostats. The intake air is always energetically optimised when it reaches the ventilation unit, which additionally saves energy – the indoor climate is always comfortable.

Planning information

- In order to maximise the heat transfer, the ground collector pipe should be laid at a depth of at least 1.2 m, since the temperature there is constantly approx. 8–12 °C throughout the year. The ground temperature increases and stabilises with installation depth.
- In order to increase the heat transfer, the pipe should be laid directly in the ground in a sand bed. Furthermore, if ground collector pipes are laid in parallel, the distance should not be less than 0.5 m (from pipe to pipe).
- There is also the option of probe drilling as an alternative to surface laying.

Delivery

- The ground-to-brine heat exchanger SEWT is delivered as a kit corresponding to the course of processing on-site and for optimised transportation. The complete set guarantees the absolute precision fit and functional reliability, because all individual components are matched to each other. The kit consists of three sets, which are described on the adjacent page.

Schematic diagram

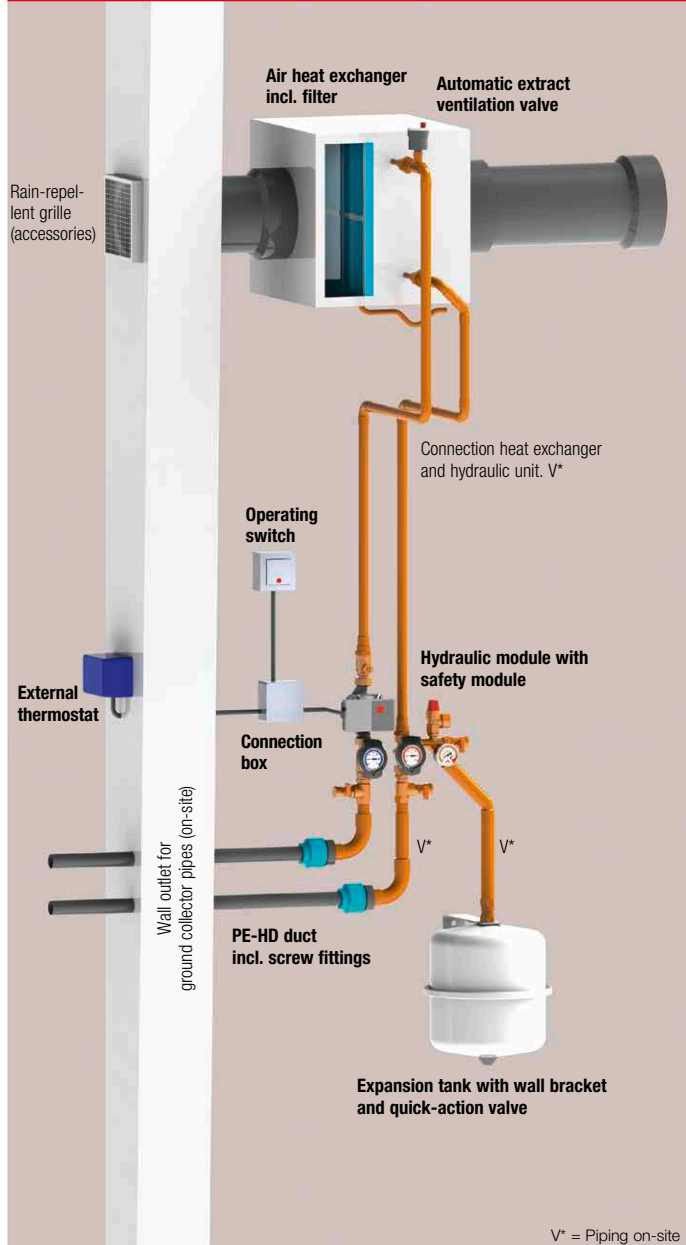

SEWT kit Ref. no. 02564

Pictorial schematic

The pre-insulated duct system IsoPipe should be used to prevent condensation. Alternative: Spiral duct with additional insulation.

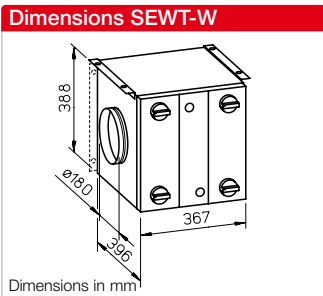

Heat exchanger module

Description

- Highly efficient ground-to-brine heat exchanger unit with aluminium blades for optimal heat transfer to the intake air. Connection duct \varnothing 12 mm made of copper.
- Double-walled, fully insulated casing made of steel sheet (20 mm insulation, white powder-coated). With mounting bracket for wall or ceiling mounting.
- Connector \varnothing 180 mm with double lip seal.
- Variable air flow direction through convertible air filter.
- With integrated air filter, class ISO Coarse 75% (G4). Prevents the ingress of dirt, insects, etc.
- Inspection panels are easy to open without tools for quick and easy access to the filter.
- Condensate drain connector incl. siphon, \varnothing 1/2".

Accessories

Replacement air filter class ISO Coarse 75% (G4)

Unit = 3 pcs.

ELF-SEWT-F No. 02568

Technical data SEWT-W

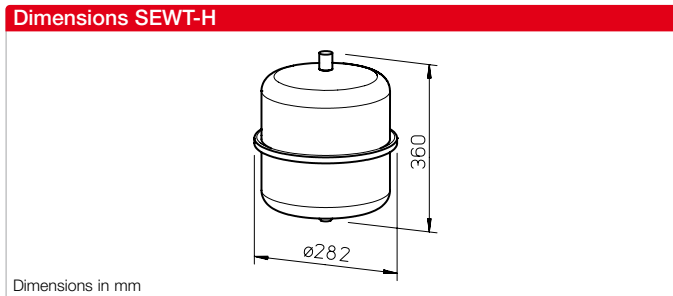
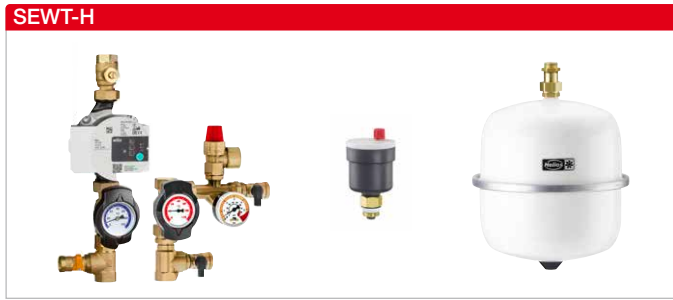
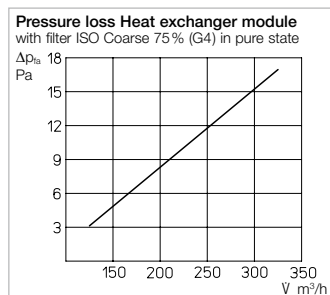

Hydraulic module and control

Description

- Complete hydraulic kit with all components necessary for the connection of the ground-to-brine heat exchanger system and the corresponding control unit for automatic or manual system operation.

Delivery

- Brine pump unit (230 V) incl. safety module.
- Flow and return temperature display.
- Automatic quick-vent valve with non-return valve.
- Membrane pressure expansion tank – 12 litre, connection 3/4", incl. wall bracket and quick-action valve.

Thermostat module with 2 setpoints for automatic control of the brine circuit in summer / winter operation.

- Switch unit for switching between automatic (thermostatic operation) and manual control of the brine circuit (incl. separate connection box – no Fig.)



Technical data Thermostat

Load capacity	16 A (4 A ind.)
Voltage	230V, 50/60Hz
Protection category	IP54
Wiring diagram no.	906
Temperature range (adjust.)	2 x 0 – 40 °C

Technical data Hydraulic module

Current consumption max.	0.44 A
Voltage	230 V, 50 Hz
Power consumption	3 – 45 W
Protection category	IP44

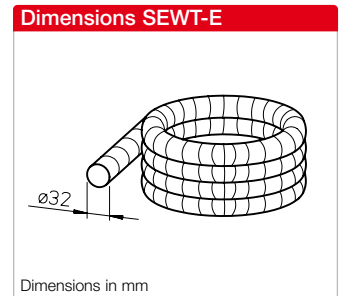

Ground installation set with screw fittings and 20 l ethylene glycol.

Description

- Flexible PE-HD ground collector pipe (PE-HD = polyethylene high-pressure pipe), wall thickness 2.9 mm, external \varnothing 32 mm. Delivered in 100 metre bundle.
- Specifically designed for ground installation.
- Screw fitting set made of high-quality polypropylene (PP) for connection of the ground collector pipe to the hydraulic unit.
- The screw fitting set (32-1") has an active seal system.
- 20 l canister of ethylene glycol, free from amines and nitrites. Sufficient for completely filling the duct system with a 25% glycol-water mixture.

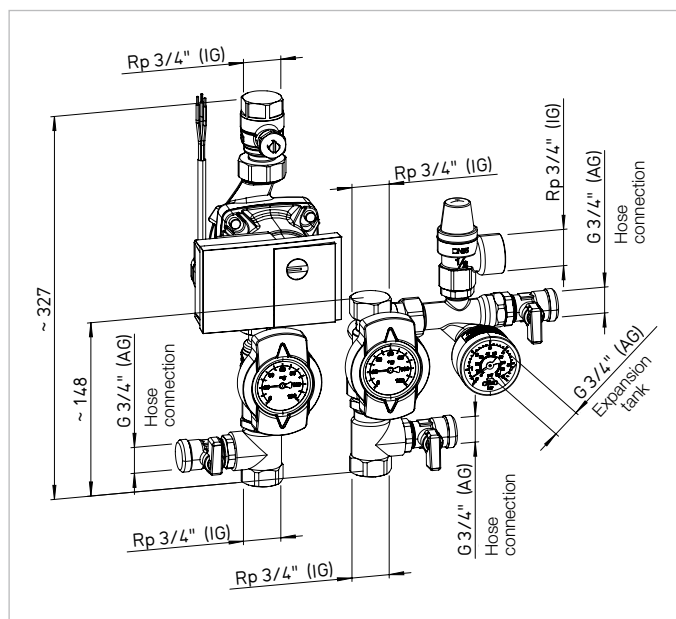

Reference

The SEWT kit offers functional reliability and accuracy of fit in addition to the package price saving:

Type	Ref. no.
SEWT kit	02564
The individual components of the SEWT kit are to be ordered separately:	
Type	Ref. no.
SEWT-W	02565
SEWT-H	02566
SEWT-E	02567

LEWT kit



Planning information

- In order to maximise the heat transfer, the ground collector pipe should be laid at a depth of at least 1.2 m, since the temperature there is constantly approx. 8 °C throughout the year. The ground temperature increases and stabilises with installation depth.
- During installation, it should be ensured that there is a gradient of at least 2% for the condensate drain.
- In order to increase the heat transfer, the pipe should be laid directly in the ground in a sand bed. Furthermore, if ground collector pipes are laid in parallel, the distance should not be less than 1 m (from pipe to pipe).
- A minimum bend radius of 1 m is recommended to minimise the air-side pressure loss.

The ground-to-air heat exchanger LEWT further optimises the efficiency of ventilation units with heat recovery.

Advantages

- Additional preheating during the cold season without any additional energy requirements.
- Prevention of icing of the heat exchanger.
- Pleasant cooling on hot days.
- Additional post-heating of supply air is only necessary in case of very low outdoor temperatures.
- Complete kit with coordinated components.

Functional principle

The ground-to-air heat exchanger LEWT utilises the fact that the ground temperature remains relatively constant throughout the year. The intake air is drawn through an upstream ground collector pipe. This can be instal-

led in an existing construction pit at a depth of approx. 1.2 to 1.5 m; the total pipe length should be at least 40 m.

This results in the following:

- **During the cold season**
The preheating of cold intake air of up to 14 K. Thus, the intake air is normally at a temperature above 0 °C when it reaches the ventilation unit with heat recovery (anti-icing operation). This results in an increased heat recovery rate and a higher supply air temperature. Post-heating is only necessary in case of very low outdoor temperatures.
- **On hot summer days**
The ground-to-air heat exchanger reduces the intake air temperature.
- **During the transitional period**
Intake either through the ground collector or direct intake opening. This is dependent on the outdoor

temperature measured via the thermostats. The electric bypass shutter automatically controls the ideal intake volume. The intake air is always energetically optimised when it reaches the ventilation unit, which additionally saves energy – the indoor climate is always comfortable.

Delivery

- The ground-to-air heat exchanger LEWT is delivered as a kit corresponding to the course of processing on-site and for optimised transportation. It consists of three sets, which are described on the adjacent page.
- The individual components are perfectly matched to each other and form a system. This guarantees simple, quick and precise installation as well as high functional reliability.

Complete kit

consisting of ground collector pipe, outlet wall bushing, air intake column, control and pipe fittings.

LEWT kit Ref. no. 02977

Pictorial schematic for installation in buildings with basements

The ground collector pipe enters the building via an underground wall outlet.

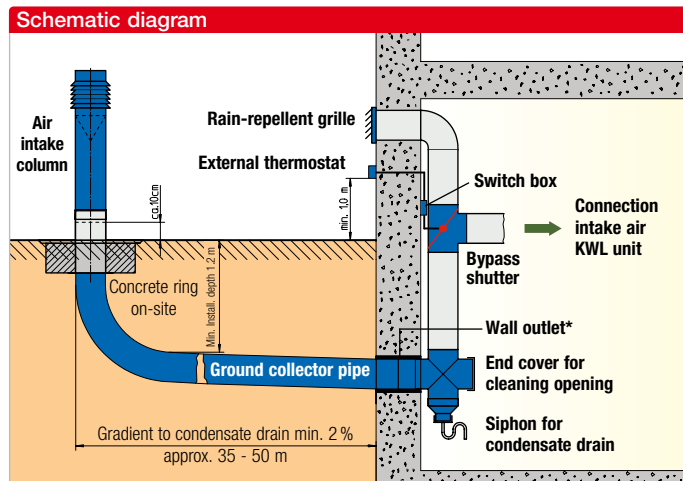

*not suitable for pressing water.

Pictorial schematic for installation in buildings without basements

The ground collector pipe is placed in the building via the floor panel. A shaft must be provided on-site for inspection purposes.

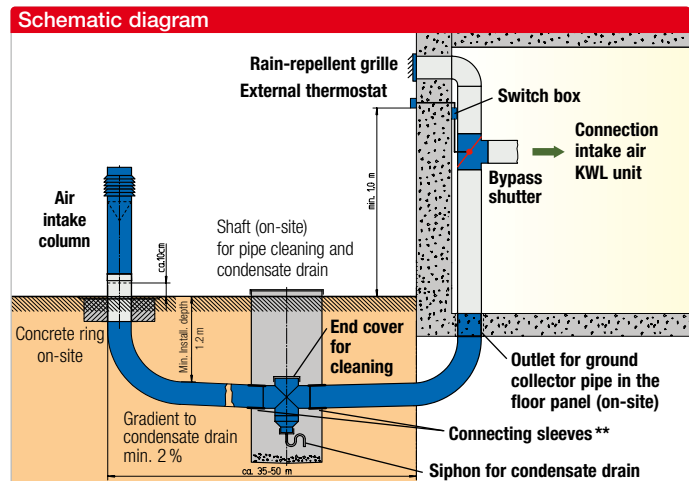

**in case of assembly with shaft please order additionally 1 pc. connecting sleeve LEWT-MU No. 02971.

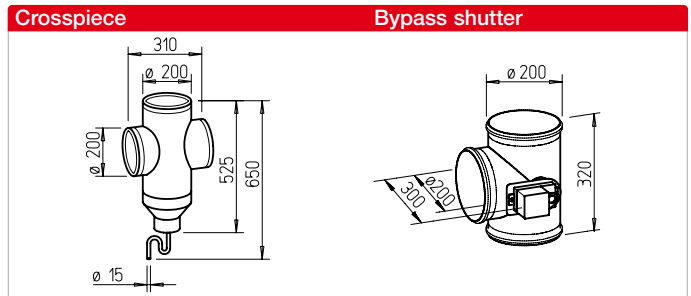
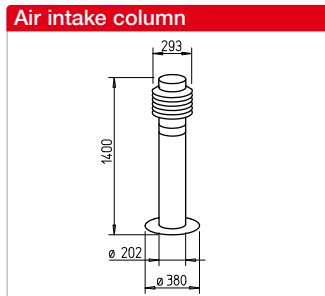
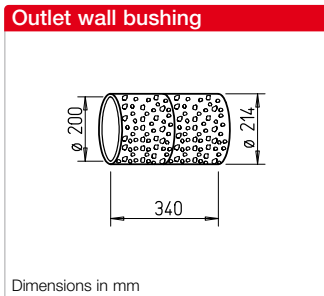

Ground collector pipe and wall outlet LEWT-E+M

- Description**
- Flexible, externally corrugated and internally smooth ground collector pipe with low air resistance; external \varnothing 200 mm.
- Coextruded composite pipe made of physiologically and toxicologically safe polyethylene (PE-HD). Antibacterial, antistatic inner wall. Specifically developed as a ventilation duct for ground installation.
- Easy to clean, fulfils DIN 1946-6 (VDI 6022).
- 100% odourless, assured top quality level excludes the transmission of harmful substances and vapours.
- The PE-HD material achieves double the conductivity of PP with comparable wall thicknesses / pipe cross-sections. In comparison to PVC, the heat conductivity is two and a half times better.
- Delivered in bundle with 2 x 25 liner metres. Includes wall outlet DN 200 made of polypropylene (sanded), profile seal rings, connecting sleeve and seals.
- Ground collector pipe, wall outlet and profile seal rings comply with protection category IP 67 when processed according to instructions.

Air intake column LEWT-A with filter

- Description**
- Air intake column in modern design and aesthetic stainless steel look for supply air intake.
- Simple plug-in connection between the intake column and ground collector pipe.
- Fixation with support plate or bordering plate (on-site) in drywall construction or set in concrete.
- All parts made of stainless steel.
- With integrated cone air filter, class ISO Coarse 60% (G4). Prevents the ingress of dirt, insects and contaminants.
- Cone filter must be removed by hand for cleaning and replacement after removing the blade head.

Control and moulded duct parts LEWT-S+F

- Description**
- Automatic control of air intake via the ground collector pipe or directly from the outdoor area depending on the outdoor temperature measured by the thermostat.
- Temperature range for direct intake individually adjustable at thermostat.
- The desired operating mode can be manually selected.
- Delivery**
- Bypass shutter NW 200 with actuator 230 V; for vertical installation using the crosspiece.
- Crosspiece for connection to the wall outlet. Includes cleaning opening, condensate collector, siphon and end cover.
- Rain-repellent grille (no Fig.) as wall cover for direct intake opening. Prevents the ingress of rain, small animals and insects into the intake air duct.

- Setpoint adjuster and thermostat for automatic and manual bypass shutter control. For attachment in weatherproof location in the outdoor area on the north side of the building at a height of approx. 1 m. Dim. in mm B 200 x H 90 x T 70
- Switch box with double toggle switch for following operating modes:
 - Thermostatic operation, automatic
 - Ground heat, manual
 - Intake air, manual
 Dim. in mm W 110 x H 180 x D 100

Accessories

- Replacement air filter class ISO Coarse 60% (G4)**
Unit = 3 pcs.
ELF-LEWT-A Ref. no. 02975
- Additional connecting sleeve**
Includes 2 pcs. seal rings.
LEWT-MU Ref. no. 02971

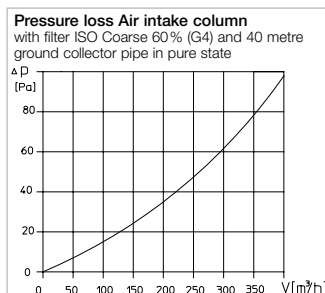

Technical data Thermostat	
Load capacity	16 A (4 A ind.)
Voltage	230V, 50/60 Hz
Protection category	IP54
Wiring diagram no.	798.1
Temperature range (adjust.)	2 x 0 – 40 °C
Technical data Actuator	
Voltage	230V, 50/60 Hz
Power consumption	1.5 W
Protection category	IP54

Reference	
The individual components of the LEWT kit are to be ordered separately:	
Type	Ref. no.
LEWT-E+M	02991
LEWT-S+F	02990
LEWT-A	02992
LEWT crosspiece	02967

Competence in aerodynamics. Axial fans without limits.



As a leading European fan manufacturer, Helios offers an exceptional, finely tuned series range of high performance and medium pressure axial fans and RADAX® VAR high pressure round duct fans in all performance ranges.

The series range of high performance axial fans with aerodynamically and acoustically optimised impellers and innovative motor concepts (Ø 250 to 500 mm) is presented on the following pages.

The especially **energy-saving EC models** with speed control achieve energy savings of more than 55% in comparison to conventional AC types.

Voltage controllable high performance axial AC fans in Ø 250 to 500 mm are characterised by their proven robust design and a 25% increase in efficiency with 50% noise reduction.

The series range with Ø up to 1000 mm is complemented by technical building equipment (TGA) solutions.

- Fire gas and smoke extraction types according to DIN 12101-3 in temperature classes F300 (60 min.), F400 (120 min.) and F600 (120 min.).
See TGA catalogue, Ref. no. 86979.
- Special technical building equipment (TGA) solutions and large axial fans from Ø 1000 to 7100 mm, V up to 2.2 million m³/h, are manufactured according to customer-specific requirements.

Renowned users rely on the application of Helios axial fans in ventilation, heating, cooling, air conditioning and drying systems around the world.

The large fans have been used successfully for decades, e.g. in cooling towers and air coolers.

■ High performance axial fans

Energy-efficient EC version.

Ø 250 – 710 mm
 V = 1970 – 19 400 m³/h

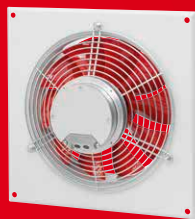

174^f

■ High performance axial fans

Standard AC version.

Ø 200 – 1000 mm
 V = 520 – 63 420 m³/h



Also available in version:



192^f

■ High performance axial fans

Product-specific information, selection table.

172^f

■ Medium pressure axial fans

Product-specific information, selection table.

Ø 225 – 630 mm
 V = 950 – 32 000 m³/h



218^f

■ RADAX® VAR high pressure fans

Product-specific information, selection table.

Ø 225 – 630 mm
 V = 900 – 22 310 m³/h



Also available in version:



244^f

■ Installation accessories

For axial fans and VAR fans.

268^f

This information supplements the "General technical information".

■ Designs

- Standard and high performance fans in industrial design are manufactured in series with more than 20 nominal sizes and more than 1000 types.
- A closely graduated range up to impeller Ø 7100 mm in various designs is available for higher volume and pressure rates. Four different versions are available as standard.
- Types HQ, HW and HRF up to nominal size 500 mm with highly efficient EC drive technology are optionally available for especially energy-efficient applications and minimal operating costs.

■ Versions in this catalogue

1. Wall fan HQ

Square plate with intake nozzle

Casing made of galvanised steel sheet. Motor with terminal box and protection grille on inlet side.

2. Built-in fans

HW, AVD DK

Wall ring with intake nozzle

Casing made of galvanised steel sheet. Motor with terminal box and protection grille on inlet side.

3. Built-in wall fan HS

Pipe sleeve, cylindrical with smooth ends

For flush-mounted wall or duct installation. Casing made of galvanised steel sheet with circumferential reinforcing beads.

4. Round duct fans

HRF, AVD RK

Pipe sleeve, with double-sided flanges

For direct intermediate flanges in pipeline. Flange in accordance with DIN 24155, p. 3. Casing made of galvanised steel sheet, with additional terminal box (IP55) on outside of duct.

■ Drive

AC types

Robust 1~ or 3~ internal rotor motors with thermal contacts in the winding. Ball bearings with lifetime lubrication.

EC types

Highly efficient, speed-controllable external rotor motors in protection category IP44 or 54. Ball bearings with lifetime lubrication.

■ Impellers

- Depending on requirements, the impellers are made of different materials; see information on the product pages. The standard versions are made of plastic, but other materials e.g. aluminium or steel are possible according to requirements.

Common features:

- Low operating noise level.
- High level of efficiency.
- Vibration-free running due to dynamic balancing in accordance with DIN ISO 21940-11 – quality grade 6.3.
- Impellers made of other materials are possible upon request.
- Impellers made of metal are available at an extra charge for higher temperatures. The information on the product pages is decisive.

■ Angle of attack

- The series products up to 630 mm Ø are equipped with fixed impellers.
- The blades can be delivered with order-based angles of attack from nominal size 710 mm upwards (except for type HQW 710/6).
- The sizes Ø 800/4, 900/4 and/6 as well as Ø 1000 mm have blades which can be adjusted at standstill. This allows optimal coverage of the operating point. The angle of attack is adjusted (according to the order) and fixed in the factory. The motor is assigned using the maximum power (see table). The specified angle of attack must not be exceeded, otherwise the motor can be overloaded.

■ Contact protection

With regard to installation and operation, The applicable occupational safety and accident protection guidelines as well as contact protection according to VDE 0700 or DIN EN ISO 13857 must be observed. Contact with rotating parts must be prevented. It must be ensured that there are no loose substances in the intake area. Fans which are protected by their installation type (e.g. installation in ventilation duct or closed aggregates) do not require a protection grille if the system provides sufficient safety. Please note that the installer can be held liable for accidents as the result of the lack of protection devices. Suitable protection grilles are available as accessories. The installer and operator shall be responsible for observing safety regulations.

Air flow direction

All fans (except for HRF and AVD RK) are designed with air flow direction
A = inlet over motor
B = outlet over motor
 can be delivered for most types upon request (at an extra charge).
 HRF and AVD RK are delivered with air flow direction B as standard.

- The subsequent conversion of air flow direction is possible for most high performance axial AC fans. This requires the following:
 1. Change of direction of motor rotation by reversing the polarity on the terminal board.
 2. Removal of the impeller and reattachment the other way round (possible up to Ø 500). A performance reduction of approx. 1/3 should be expected for series HQ and HW.
- EC types can only be operated in the standard direction of rotation.

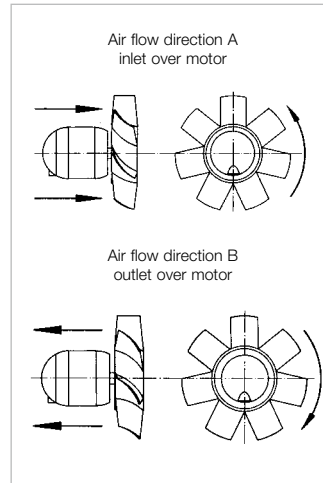

■ Installation position, installation, condensate outlets

- Axial fans can be installed and operated in any position in compliance with the permissible protection category (see product page). In case of equipment with condensate drain holes, please be aware of their position.
- In case of outdoor installation, installation in permanently humid or wet environments or in case of installation with a vertical shaft, this must be indicated when placing the order, because a special design may be required. The installation site and mounting should be such that the fan can be mounted securely and without warping.

■ Reverse operation

Most high performance axial AC fans (see product pages) are reversible. Either supply or extract ventilation can take place using a suitable reverser switch. There is a performance reduction of approx. 1/3 in an abnormal flow direction.

- The EC types are non-reversible as standard.

■ Air flow temperatures

Temporarily higher air flow temperatures are also possible with the exception of explosion-proof versions. Versions designed for higher continuous temperatures

are possible in the area of custom production.

■ Motor protection

- Through built-in thermal contacts in the winding for AC types
 - standard for 1~ motors,
 - mostly standard for 3~ motors (see product page).
- Integrated electronic temperature monitoring system for EC types.
- The regulations DIN EN 60079-10 shall apply for explosion-proof types. According to this, overload protection must be provided for each fan by a motor protection circuit breaker, which must be triggered within the heating time specified in the test certificate in case of a short circuit. Fans must be protected by a protection grille or shutter against foreign bodies larger than 12 mm getting sucked in or falling in. Approved operating mode according to DIN EN 60034-1/VDE 0530 = S1 (continuous operation). Speed control is not permitted.

■ Explosion protection

The explosion-proof types correspond to unit group II, category 2G for operation in zone 1 and 2. Larger air gaps which result in a performance reduction of approx. 10% are stipulated in accordance with Directive 2014/34/EU (ATEX).

■ Special equipment, Additional costs upon request

- Impeller made of die-cast aluminium**
- Deviating voltage**
- Deviating frequency**
- Two-component lacquer coating** to protect the external unit parts against weak acids and alkaline solutions
- Deviating air flow direction**
- Special equipment for higher air flow temperatures**
- Pressure-resistant encapsulated motors (standard for 1~ explosion-proof types)**

■ Vibration insulation

The use of vibration dampers (accessories SDD, SDZ) is recommended to prevent vibration transmission. Larger motors may protrude from the back and cause uneven distribution due to their high weight. An extension duct VR (accessories) should be provided to adjust the centre of gravity.

By combining the parameters of static pressure increase Δp_{ia} , flow rate V , speed min^{-1} , sound pressure level dB(A) and impeller diameter DN mm, the following table facilitates the selection of high performance

axial EC fans \varnothing 250 to 710 mm and high performance axial fans \varnothing 200 to 1000 mm.

	Speed	Sound pressure inlet side L_{PA} dB(A) at 4 m distance	Flow rate V m ³ /h depending on static pressure																
			(Δp_{ia}) in Pa																
			0	10	20	30	40	50	60	80	100	120	140	160	200	250	300	350	400
EC 250 A	2710	58	1970	1940	1900	1820	1790	1750	1680	1540	1330	1120	760						
EC 315 A	1920	52	2780	2740	2690	2600	2510	2420	2330	2160	1800								
EC 355 A	1460	49	2990	2910	2660	2490	2410	2240	2070										
EC 355 B	1975	59	4200	4150	4090	4020	3960	3890	3820	3690	3540	3360	3100	2790					
EC 400 A	1800	59	4790	4690	4610	4540	4460	4390	4310	4140	3920	3640	3240						
EC 400 B	2150	65	5850	5800	5760	5700	5640	5560	5490	5360	5210	5080	4870	4730	4030				
EC 450 A	1325	55	5460	5350	5250	5140	5030	4910	4790	4520	4200	3730							
EC 450 B	1835	64	7640	7580	7510	7450	7390	7330	7260	7070	6880	6680	6490	6200	5530				
EC 500 A	1025	54	6320	6190	6050	5900	5750	5590	5420	5010	4460								
EC 500 B	1450	62	8300	8230	8150	8070	7970	7880	7790	7490	7300	6910	6530	6140					
EC 560	1200	55	9740	9550	9360	9160	8780	8590	8400	8020	7440	6480							
EC 630	960	54	10330	10100	9860	9630	9400	8930	8700	7770	6370								
EC 710	1100	61	19400	18920	18440	18210	17970	17490	17240	16530	15570	14610	13650	11260					

\varnothing in mm	Speed	Sound pressure inlet side L_{PA} dB(A) at 4 m distance	Flow rate V m ³ /h depending on static pressure																
			(Δp_{ia}) in Pa																
			0	10	20	30	40	50	60	80	100	120	140	160	200	250	300	350	400
200	2300	55	910	860	810	760	710	490	420	330	220								
200	1360	42	520	410	210	170													
250	2800	53	2070	2040	2010	1970	1940	1910	1870	1800	1710	1610	1480						
250	1450	44	930	840	730														
250	950	31	660	570															
315	2800	69	4090	4050	4020	3990	3950	3920	3880	3790	3700	3610	3500	3380	3090				
315	1450	51	2090	2010	1930	1840	1740	1620	1410										
315	950	38	1330	1220	1070														
315	725	30	980	780															
355	2800	71	5710	5670	5620	5580	5530	5480	5430	5330	5220	5110	4990	4860	4550	4020			
355	1450	51	2850	2770	2670	2570	2450	2320	2160										
355	950	42	1940	1830	1690	1500	1060												
355	725	34	1430	1240	880														
400	2800	71	8410	8360	8310	8270	8220	8170	8130	8030	7940	7840	7750	7650	7440	7160	6840	6440	5820
400	1450	56	4010	3920	3810	3700	3580	3440	3300	2970									
400	950	45	2570	2410	2230	2020													
400	725	37	2010	1810	1530														
450	2800	78	11050	10960	10870	10770	10680	10590	10500	10310	10130	9950	9770	9580	9210	8690	8050	6930	4520
450	1450	58	5770	5680	5590	5500	5390	5280	5160	4870	4510	4010							
450	950	47	3890	3720	3550	3360	3150	2890											
450	725	51	2860	2680	2450	2120													
500	2800	81	13150	13040	12930	12820	12720	12610	12500	12290	12070	11860	11660	11440	11010	10380	9600	8620	5390
500	1450	65	8320	8220	8110	8000	7880	7760	7630	7370	7080	6760	6400	5970					
500	950	51	5500	5330	5140	4950	4740	4510	4240	3450									
500	725	44	3890	3690	3440	3150	2750												
560	1450	62	12910	12680	12550	12360	12140	11950	11770	11320	10900	10550	10000	9500	8270				
560	950	52	8100	7680	7370	7080	6680	6280	5830	4570									
560	725	46	6450	6070	5640	5230	4750	4140											
630	1450	65	17870	17650	17420	17200	16970	16750	16520	16010	15500	15000	14500	14000	13000	11300			
630	950	55	10520	10150	9780	9410	9040	8670	8220	7260									
630	725	49	8000	7580	7010	6530	5910	5300											
710	1450	71	23740	23490	23240	22980	22730	22470	22200	21660	21090	20500	19900	19290	18010	16240	14000	11060	
710	935	61	15250	14860	14450	14040	13590	13140	12600	11690	10610	9280	7440						
710	700	54	11350	10810	10250	9630	8990	8300	7500	5340									
800	1435	73	32350	32040	31720	31400	31090	30770	30490	29860	29230	28610	27990	27330	25940	24020	22080		
800	945	62	20720	20280	19830	19350	18850	18290	17710	16530	15330	13840	10740						
800	705	55	15380	14780	14120	13380	12580	11790	10900										
900	1435	76	46060	45700	45390	45030	44670	44310	44000	43280	42600	41880	41170	40800	39060	37110	34940	32800	30340
900	950	66	30500	30100	29500	29100	28500	27900	27400	26300	25100	23910	22710	21310					
900	725	59	21160	20410	19640	18850	18010	17120	16130	15000									
1000	1440	80	63420	63030	62650	62260	61870	61490	61110	60330	59560	58790	58010	57240	55700	53710	51590	49260	46830
1000	950	69	41740	41150	40570	39990	39400	38810	38230	37060	35870	34610	33260	31810	28880				
1000	725	62	31760	30990	30220	29460	28690	27930	27130	25410	23500	21540							

Axial and VAR fans

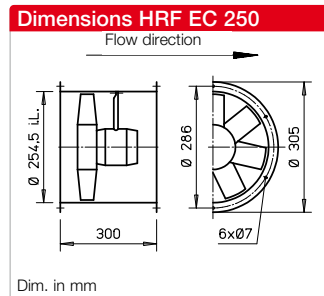
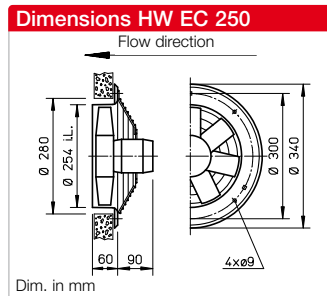
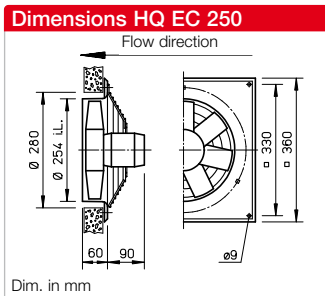

Description for all types

■ **Casing**
 Made of galvanised steel sheet, types HQ and HW have additional two layer lacquer coating in papyrus white.

■ **Impeller**
 High performance characteristics with profiled blades made of plastic, aerodynamically optimised for application, dynamically balanced.

■ **Drive**
 Energy-saving, speed-control-able external rotor EC motor in protection category IP54 with the highest level of efficiency. Maintenance-free and radio interference-free, excellent electromagnetic compatibility (EMC), ball bearing mounted.

■ **Motor protection**
 Integrated electronic temperature monitoring system for EC motor and electronics.

■ **Electrical connection**
 Standard terminal box (protection category IP54) mounted to external cable, or on outside of duct for HRF.

■ **Protection grille**
 Made of powder-coated steel for HQ and HW in accordance with DIN EN ISO 13857.

■ **Power control**
 All types have continuously variable speed control via speed potentiometer. Control is also possible via three level switch or continuously variable via universal control system or electronic differential pressure/temperature controller. See type table. Performance levels are shown on the performance curve as examples.

■ **Installation**
 Installation possible in any position.

■ **Noise levels**
 The total level and range for the sound power level and sound pressure level at 4 m free field conditions are specified above the performance diagram for the average operating point on the inlet/outlet side. The total sound pressure level at 4 m (free field conditions) is also specified in the table below the performance diagram for various voltages. See page 10 f for noise emissions and room acoustics.

Speed	Flow rate-free-blowing	Power consump.	Current consump.	Sound pressure	Wiring diagram	Max. air flow temperature	Wgt net	Design type						
								HQ EC incl. protection grille	Ref. no.	HW EC incl. protection grille	Ref. no.	HRF EC	Ref. no.	
min ⁻¹	V m ³ /h	kW	A	dB(A) at 4m	No.	+°C	ca. kg							
Alternating current, 1~, 230 Volt, 50/60 Hz, EC motor, protection category IP54														
2710	1970	0.13	0.97	58	1252	40	6.0	HQW EC 250 A	04822	HWW EC 250 A	04823	HRFW EC 250 A	04824	

Performance curves HQ EC / HW EC / HRF EC 250 A

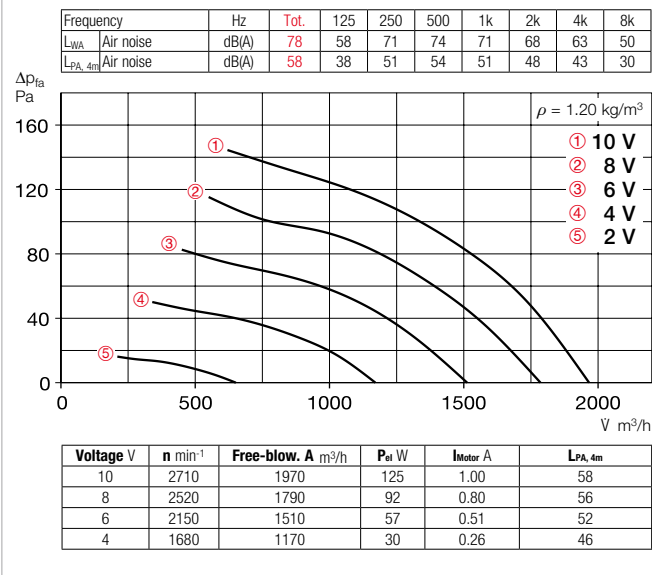

Accessories for HRF EC 250 Description see page 268 ff.

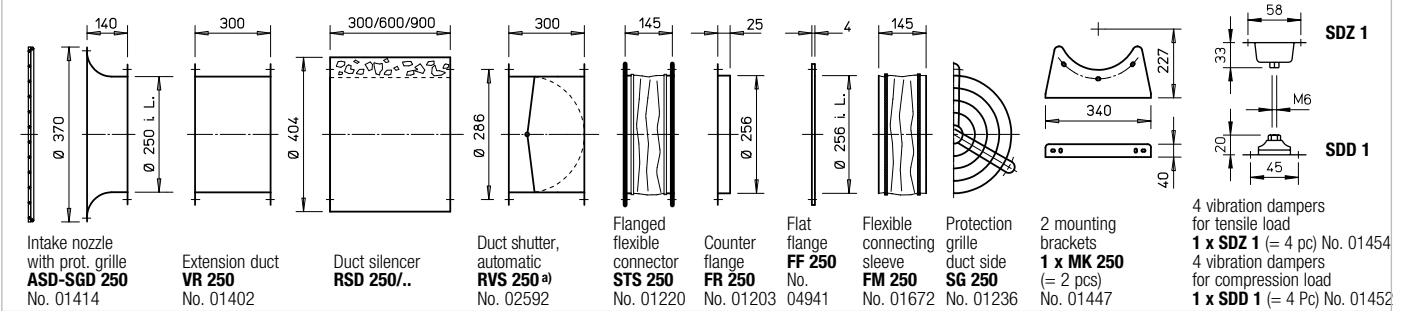

^{a)} Shutter, motorised see Accessories product pages.

References	Page
Techn. description	172
Selection table	173
Planning information	10 ff.

Special design
Different voltage, air flow direction, higher air flow temperature, acid protection upon request.

The technical information on p.15 ff. must be observed.

Other accessories	Page
Filters and silencers	473 ff.
Shutters and ventilation grilles	553 ff.
Universal control system, electronic controller, Speed potentiometer	605 ff.

Universal control system		Speed potentiometer		Three level speed switch		Electronic pressure difference controller/ actuator		Electronic temperature controller/actuator					
Type	Ref. no.	Type	Ref. no.	Type	Ref. no.	Type	Ref. no.	Type	Ref. no.				
EUR EC ¹⁾	01347	PU 10 ¹⁾	01734	PA 10 ¹⁾	01735	SU-3 10 ¹⁾	04266	SA-3 10 ¹⁾	04267	EDR ¹⁾	01437	ETR ¹⁾	01438

¹⁾ Multiple EC fans can normally be connected, see Accessories.

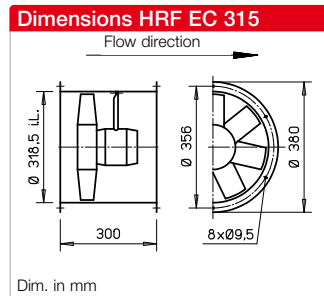
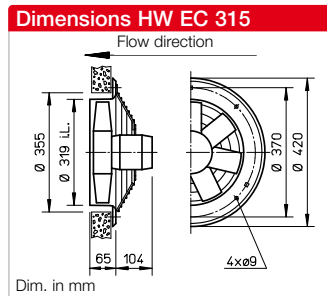
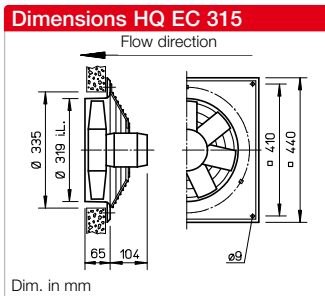

Description for all types

- **Casing**
 Made of galvanised steel sheet, types HQ and HW have additional two layer lacquer coating in papyrus white.
- **Impeller**
 High performance characteristics with profiled blades made of plastic, aerodynamically optimised for application, dynamically balanced.
- **Drive**
 Energy-saving, speed-controlable external rotor EC motor in protection category IP54 with the highest level of efficiency. Maintenance-free and radio interference-free, excellent electromagnetic compatibility (EMC), ball bearing mounted.
- **Motor protection**
 Integrated electronic temperature monitoring system for EC motor and electronics.

- **Electrical connection**
 Standard terminal box (protection category IP54) mounted to external cable, or on outside of duct for HRF.
- **Protection grille**
 Made of powder-coated steel for HQ and HW in accordance with DIN EN ISO 13857.
- **Power control**
 All types have continuously variable speed control via speed potentiometer. Control is also possible via three level switch or continuously variable via universal control system or electronic differential pressure/temperature controller. See type table. Performance levels are shown on the performance curve as examples.

- **Installation**
 Installation possible in any position.
- **Noise levels**
 The total level and range for the sound power level and sound pressure level at 4 m free field conditions are specified above the performance diagram for the average operating point on the inlet/outlet side. The total sound pressure level at 4 m (free field conditions) is also specified in the table below the performance diagram for various voltages. See page 10 f for noise emissions and room acoustics.

Speed	Flow rate-free-blowing	Power consump.	Current consum.	Sound pressure	Wiring diagram	Max. air flow temperature	Wgt net	Design type					
								HQ EC incl. protection grille	Ref. no.	HW EC incl. protection grille	Ref. no.	HRF EC	Ref. no.
min ⁻¹	V m ³ /h	kW	A	dB(A) at 4m	No.	+°C	ca. kg						
Alternating current, 1~, 230 Volt, 50/60 Hz, EC motor, protection category IP54													
1920	2780	0.15	1.20	52	1252	40	7.5	HQW EC 315 A	04880	HWW EC 315 A	04881	HRFW EC 315 A	04882

Performance curves HQ EC / HW EC / HRF EC 315 A

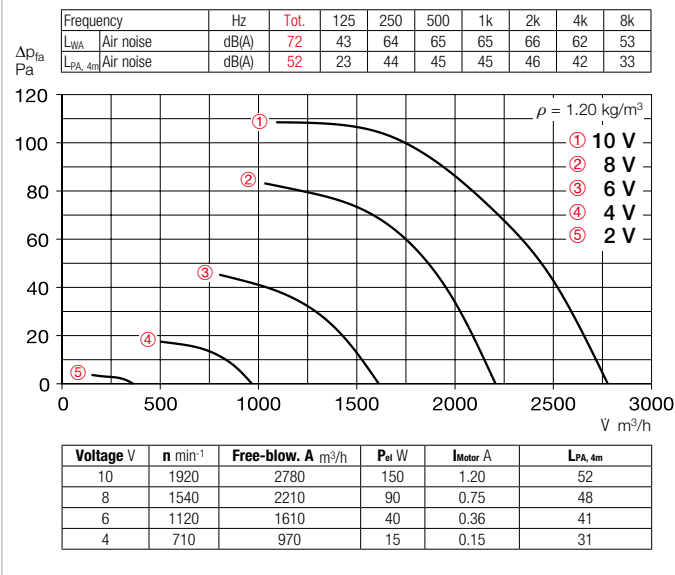

Accessories for HRF EC 315 Description see page 268 ff.

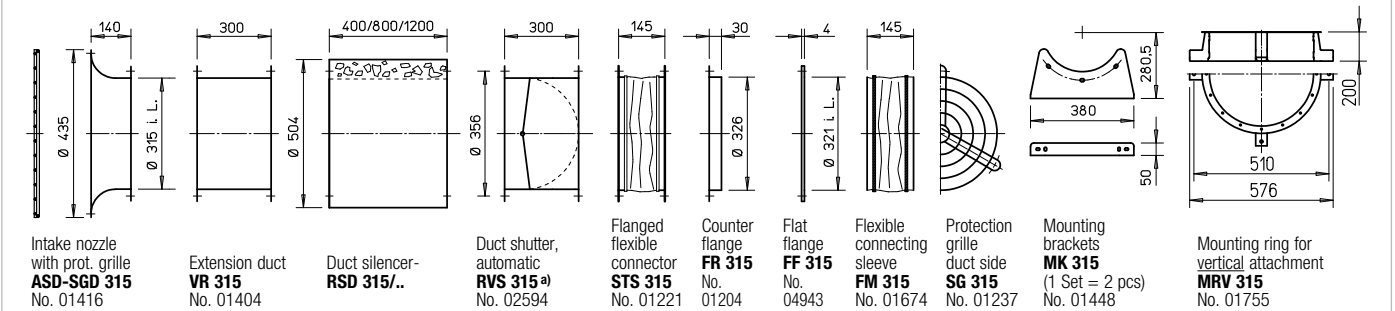

^{a)} Shutter, motorised see Accessories product pages.

■ References	Page	■ Other accessories	Page
Techn. description	172	Filters and silencers	473 ff.
Selection table	173	Shutters and ventilation grilles	553 ff.
Planning information	10 ff.	Universal control system, electronic controller, Speed potentiometer	605 ff.
Special design			
Different voltage, air flow direction, higher air flow temperature, acid protection upon request.			
The technical information on p.15 ff. must be observed.			

Universal control system		Speed potentiometer		Three level speed switch		Electronic pressure difference controller/ actuator		Electronic temperature controller/actuator					
Type	Ref. no.	Type	Ref. no.	Type	Ref. no.	Type	Ref. no.	Type	Ref. no.				
EUR EC ¹⁾	01347	PU 10 ¹⁾	01734	PA 10 ¹⁾	01735	SU-3 10 ¹⁾	04266	SA-3 10 ¹⁾	04267	EDR ¹⁾	01437	ETR ¹⁾	01438

¹⁾ Multiple EC fans can normally be connected, see Accessories.

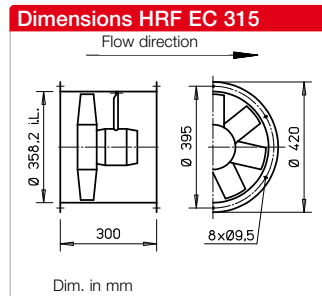
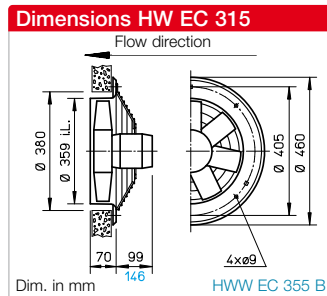
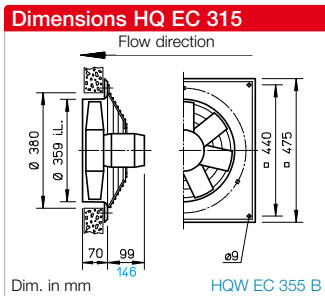

Description for all types

- **Casing**
 Made of galvanised steel sheet, types HQ and HW have additional two layer lacquer coating in papyrus white.
- **Impeller**
 High performance characteristics with profiled blades made of plastic, aerodynamically optimised for application, dynamically balanced.
- **Drive**
 Energy-saving, speed-control-lable external rotor EC motor in protection category IP54 with the highest level of efficiency. Maintenance-free and radio interference-free, excellent electromagnetic compatibility (EMC), ball bearing mounted.
- **Motor protection**
 Integrated electronic temperature monitoring system for EC motor and electronics.

- **Electrical connection**
 Standard terminal box (protection category IP54). Mounted to external cable for HQ and HW types (version "A") or on back of motor (version "B"). Mounted on outside of duct for HRF types.
- **Protection grille**
 Made of powder-coated steel for HQ and HW in accordance with DIN EN ISO 13857.
- **Power control**
 All types have continuously variable speed control via speed potentiometer. Control is also possible via three level switch or continuously variable via universal control system or electronic differential pressure/temperature controller. See type table. Performance levels are shown on the performance curve as examples.

- **Installation**
 Installation possible in any position.
- **Noise levels**
 The total level and range for the sound power level and sound pressure level at 4 m free field conditions are specified above the performance diagram for the average operating point on the inlet/outlet side. The total sound pressure level at 4 m (free field conditions) is also specified in the type table, as well as the table below the performance diagram for various voltages. See page 10 f for noise emissions and room acoustics.

Speed	Flow rate-free-blowing	Power consump.	Current consump.	Sound pressure	Wiring diagram	Max. air flow temperature	Wgt net	Design type					
								HQ EC incl. protection grille	Ref. no.	HW EC incl. protection grille	Ref. no.	HRF EC	Ref. no.
min ⁻¹	V m ³ /h	kW	A	dB(A) at 4m	No.	+°C	ca. kg						
Alternating current, 1~, 230 Volt, 50/60 Hz, EC motor, protection category IP54													
1460	3000	0.12	1.10	49	1252	40	8.5	HQW EC 355 A	04916	HWW EC 355 A	04917	HRFW EC 355 A	04918
1980	4200	0.32	1.40	59	1047	40	12.0	HQW EC 355 B	04919	HWW EC 355 B	04920	HRFW EC 355 B	04921

Performance curves HQ EC / HW EC / HRF EC 355 A

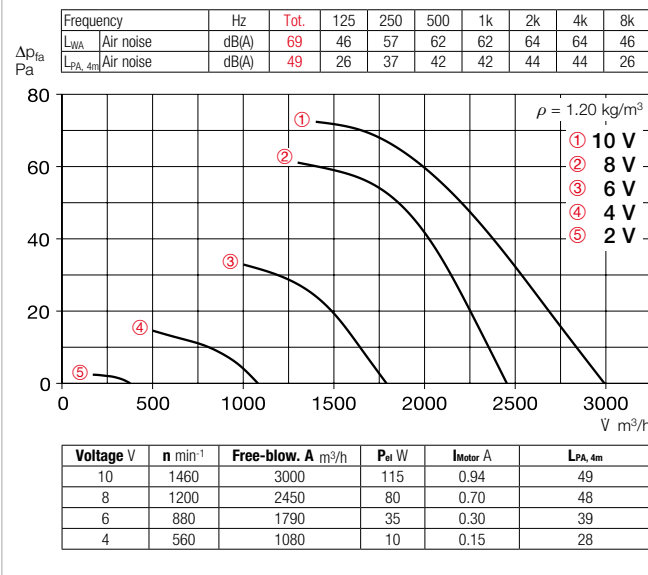

Performance curves HQ EC / HW EC / HRF EC 355 B

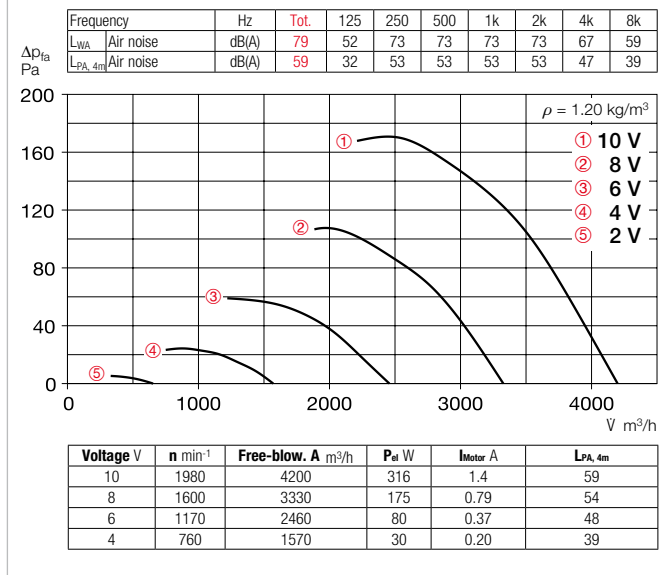

Accessories for HRF EC 355 Description see page 268 ff.

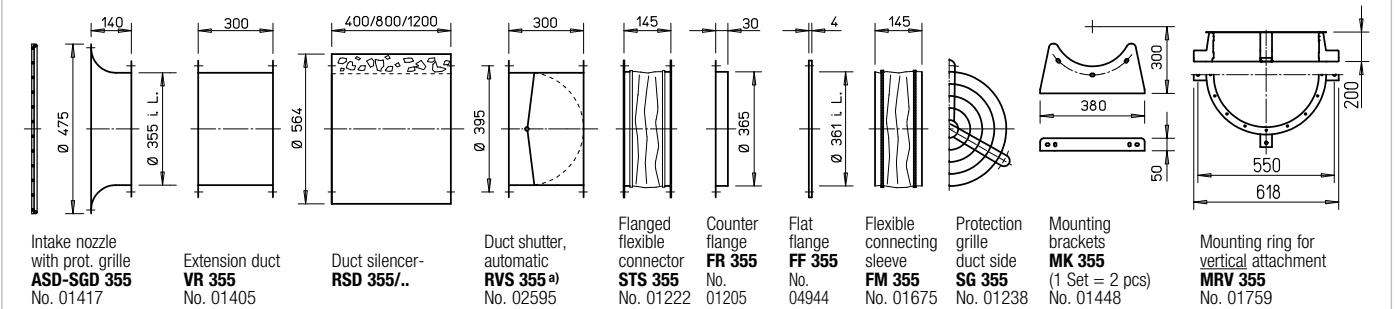

a) Shutter, motorised see Accessories product pages.

References	Page	Other accessories	Page
Techn. description	172	Filters and silencers	473 ff.
Selection table	173	Shutters and ventilation grilles	553 ff.
Planning information	10 ff.	Universal control system, electronic controller, Speed potentiometer	605 ff.

Special design
Different voltage, air flow direction, higher air flow temperature, acid protection upon request.

The technical information on p.15 ff. must be observed.

Universal control system		Speed potentiometer		Three level speed switch		Electronic pressure difference controller/ actuator		Electronic temperature controller/actuator					
Type	Ref. no.	Type	Ref. no.	Type	Ref. no.	Type	Ref. no.	Type	Ref. no.				
EUR EC ¹⁾	01347	PU 10 ¹⁾	01734	PA 10 ¹⁾	01735	SU-3 10 ¹⁾	04266	SA-3 10 ¹⁾	04267	EDR ¹⁾	01437	ETR ¹⁾	01438
EUR EC ¹⁾	01347	PU 10 ¹⁾	01734	PA 10 ¹⁾	01735	SU-3 10 ¹⁾	04266	SA-3 10 ¹⁾	04267	EDR ¹⁾	01437	ETR ¹⁾	01438

1) Multiple EC fans can normally be connected, see Accessories.

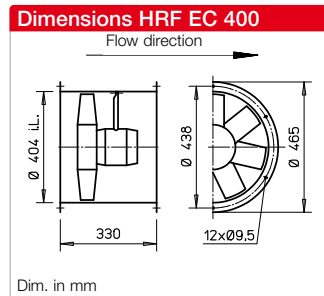
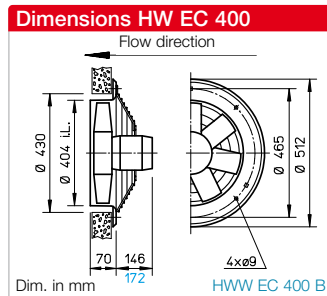
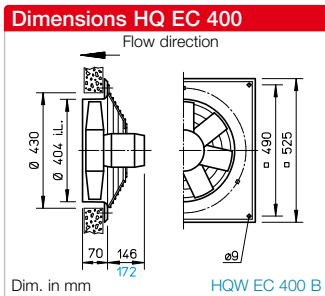

Description for all types

■ **Casing**

Made of galvanised steel sheet, types HQ and HW have additional two layer lacquer coating in papyrus white.

■ **Impeller**

High performance characteristics with profiled blades made of plastic, aerodynamically optimised for application, dynamically balanced.

■ **Drive**

Energy-saving, speed-control-lable external rotor EC motor in protection category IP54 with the highest level of efficiency. Maintenance-free and radio interference-free, excellent electromagnetic compatibility (EMC), ball bearing mounted.

■ **Motor protection**

Integrated electronic temperature monitoring system for EC motor and electronics.

■ **Electrical connection**

Standard terminal box (protection category IP54). Mounted to external cable for HQ and HW types (version "A") or on back of motor (version "B"). Mounted on outside of duct for HRF types.

■ **Protection grille**

Made of powder-coated steel for HQ and HW in accordance with DIN EN ISO 13857.

■ **Power control**

All types have continuously variable speed control via speed potentiometer. Control is also possible via three level switch or continuously variable via universal control system or electronic differential pressure/temperature controller. See type table. Performance levels are shown on the performance curve as examples.

■ **Installation**

Installation possible in any position.

■ **Noise levels**

The total level and range for the sound power level and sound pressure level at 4 m free field conditions are specified above the performance diagram for the average operating point on the inlet/outlet side. The total sound pressure level at 4 m (free field conditions) is also specified in the type table, as well as the table below the performance diagram for various voltages. See page 10 f for noise emissions and room acoustics.

Speed	Flow rate-free-blowing	Power consump.	Current consump.	Sound pressure	Wiring diagram	Max. air flow temperature	Wgt net	Design type					
								HQ EC incl. protection grille	Ref. no.	HW EC incl. protection grille	Ref. no.	HRF EC	Ref. no.
min ⁻¹	V m ³ /h	kW	A	dB(A) in 4m	No.	+°C	ca. kg						
Alternating current, 1~, 230 Volt, 50/60 Hz, EC motor, protection category IP54													
1700	4790	0.32	1.40	59	1047	40	13.4	HQW EC 400 A	04922	HWW EC 400 A	04923	HRFW EC 400 A	04924
2150	5850	0.65	3.10	65	1048	40	15.4	HQW EC 400 B	04925	HWW EC 400 B	04926	HRFW EC 400 B	04927

Performance curves HQ EC / HW EC / HRF EC 400 A

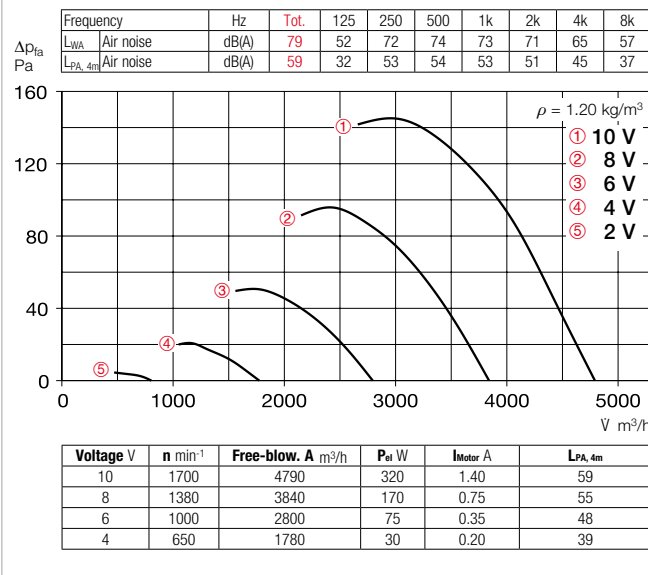

Performance curves HQ EC / HW EC / HRF EC 400 B

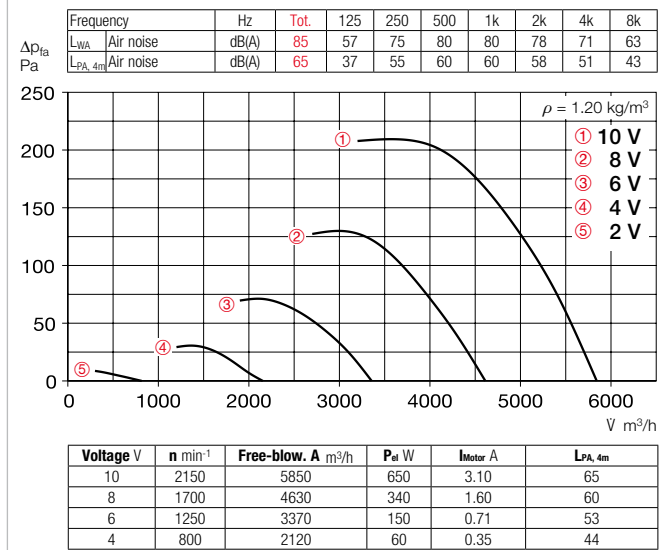

Accessories for HRF EC 400 Description see page 268 ff.

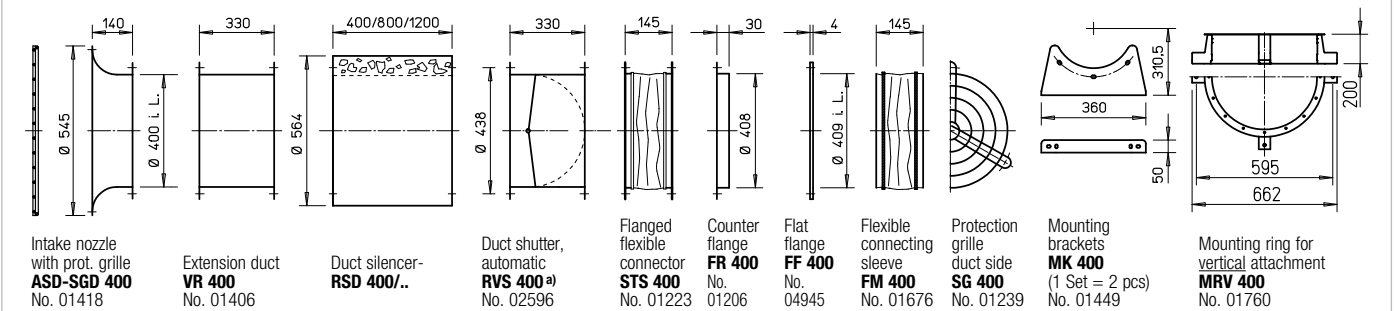

a) Shutter, motorised see Accessories product pages.

References	Page
Techn. description	172
Selection table	173
Planning information	10 ff.

Special design
Different voltage, air flow direction, higher air flow temperature, acid protection upon request.

The technical information on p.15 ff. must be observed.

Other accessories	Page
Filters and silencers	473 ff.
Shutters and ventilation grilles	553 ff.
Universal control system, electronic controller, Speed potentiometer	605 ff.

Universal control system		Speed potentiometer		Three level speed switch		Electronic pressure difference controller/ actuator		Electronic temperature controller/actuator					
Type	Ref. no.	Type	Ref. no.	Type	Ref. no.	Type	Ref. no.	Type	Ref. no.				
EUR EC ¹⁾	01347	PU 10 ¹⁾	01734	PA 10 ¹⁾	01735	SU-3 10 ¹⁾	04266	SA-3 10 ¹⁾	04267	EDR ¹⁾	01437	ETR ¹⁾	01438
EUR EC ¹⁾	01347	PU 10 ¹⁾	01734	PA 10 ¹⁾	01735	SU-3 10 ¹⁾	04266	SA-3 10 ¹⁾	04267	EDR ¹⁾	01437	ETR ¹⁾	01438

1) Multiple EC fans can normally be connected, see Accessories.

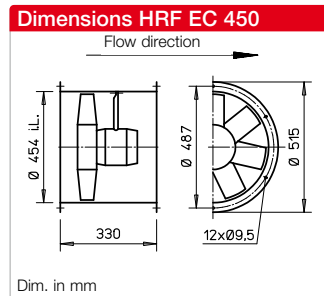
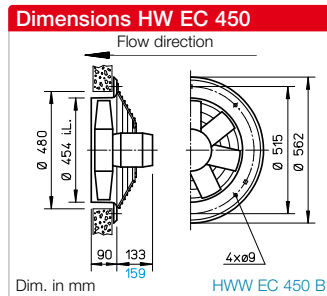
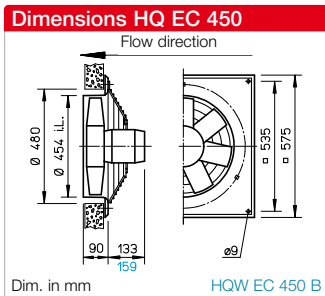

Description for all types

- **Casing**
 Made of galvanised steel sheet, types HQ and HW have additional two layer lacquer coating in papyrus white.
- **Impeller**
 High performance characteristics with profiled blades made of plastic, aerodynamically optimised for application, dynamically balanced.
- **Drive**
 Energy-saving, speed-control-lable external rotor EC motor in protection category IP54 with the highest level of efficiency. Maintenance-free and radio interference-free, excellent electromagnetic compatibility (EMC), ball bearing mounted.
- **Motor protection**
 Integrated electronic temperature monitoring system for EC motor and electronics.

- **Electrical connection**
 Standard terminal box (protection category IP54). Mounted to external cable for HQ and HW types (version "A") or on back of motor (version "B"). Mounted on outside of duct for HRF types.
- **Protection grille**
 Made of powder-coated steel for HQ and HW in accordance with DIN EN ISO 13857.
- **Power control**
 All types have continuously variable speed control via speed potentiometer. Control is also possible via three level switch or continuously variable via universal control system or electronic differential pressure/temperature controller. See type table. Performance levels are shown on the performance curve as examples.

- **Installation**
 Installation possible in any position.
- **Noise levels**
 The total level and range for the sound power level and sound pressure level at 4 m free field conditions are specified above the performance diagram for the average operating point on the inlet/outlet side. The total sound pressure level at 4 m (free field conditions) is also specified in the type table, as well as the table below the performance diagram for various voltages. See page 10 f for noise emissions and room acoustics.

Speed	Flow rate-free-blowing	Power consump.	Current consump.	Sound pressure	Wiring diagram	Max. air flow temperature	Wgt net	Design type					
								HQ EC incl. protection grille	Ref. no.	HW EC incl. protection grille	Ref. no.	HRF EC	Ref. no.
min ⁻¹	V m ³ /h	kW	A	dB(A) at 4m	No.	+°C	ca. kg						
Alternating current, 1~, 230 Volt, 50/60 Hz, EC motor, protection category IP54													
1320	5460	0.29	1.30	55	1047	40	14.5	HQW EC 450 A	04928	HWW EC 450 A	04929	HRFW EC 450 A	04930
1835	7640	0.82	3.80	64	1048	40	16.5	HQW EC 450 B	04931	HWW EC 450 B	04932	HRFW EC 450 B	04933

Performance curves HQ EC / HW EC / HRF EC 450 A

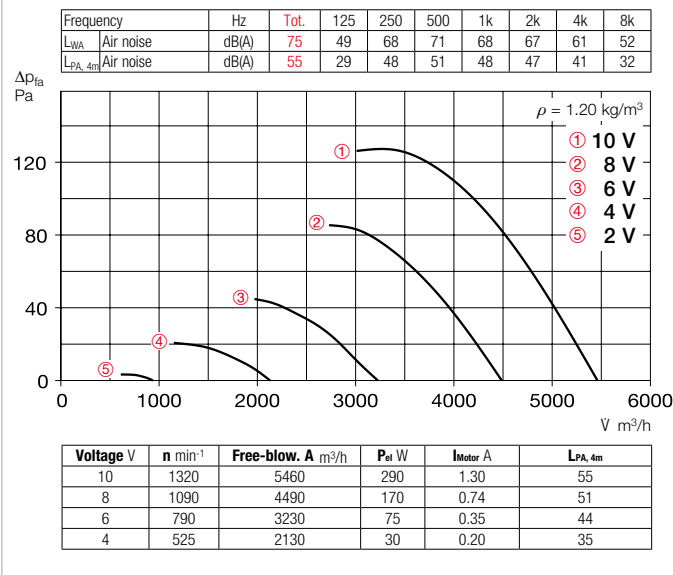

Performance curves HQ EC / HW EC / HRF EC 450 B

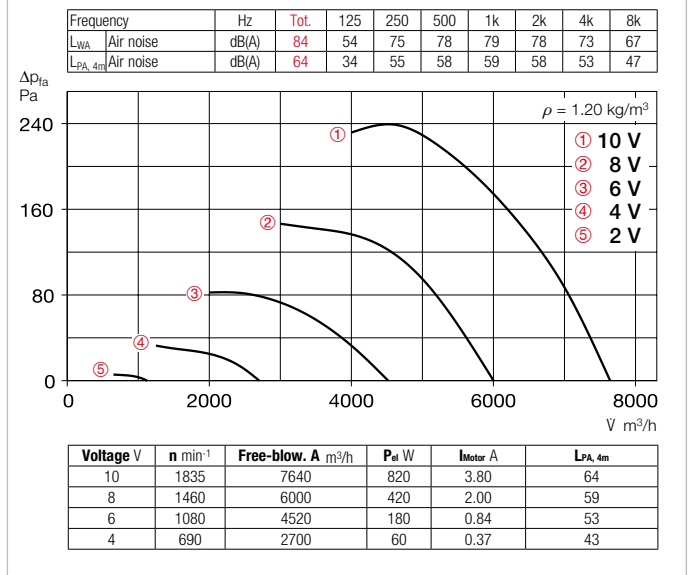

Accessories for HRF EC 450 Description see page 268 ff.

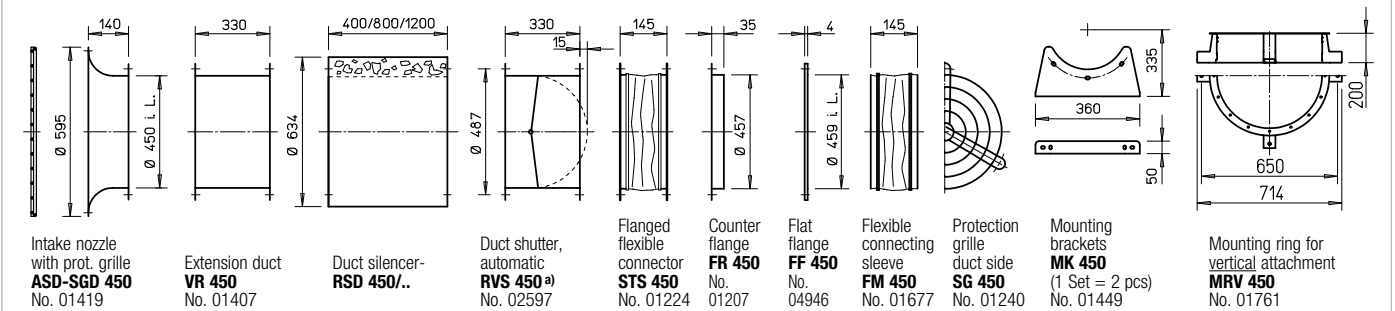

a) Shutter, motorised see Accessories product pages.

References	Page	Other accessories	Page
Techn. description	172	Filters and silencers	473 ff.
Selection table	173	Shutters and ventilation grilles	553 ff.
Planning information	10 ff.	Universal control system, electronic controller, Speed potentiometer	605 ff.

Special design
Different voltage, air flow direction, higher air flow temperature, acid protection upon request.

The technical information on p.15 ff. must be observed.

Universal control system		Speed potentiometer		Three level speed switch		Electronic pressure difference controller/ actuator		Electronic temperature controller/actuator					
Type	Ref. no.	Type	Ref. no.	Type	Ref. no.	Type	Ref. no.	Type	Ref. no.				
EUR EC ¹⁾	01347	PU 10 ¹⁾	01734	PA 10 ¹⁾	01735	SU-3 10 ¹⁾	04266	SA-3 10 ¹⁾	04267	EDR ¹⁾	01437	ETR ¹⁾	01438
EUR EC ¹⁾	01347	PU 10 ¹⁾	01734	PA 10 ¹⁾	01735	SU-3 10 ¹⁾	04266	SA-3 10 ¹⁾	04267	EDR ¹⁾	01437	ETR ¹⁾	01438

1) Multiple EC fans can normally be connected, see Accessories.

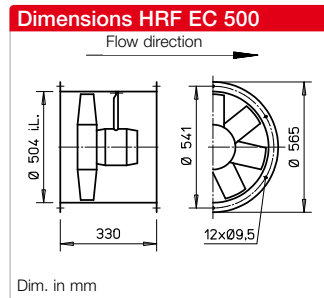
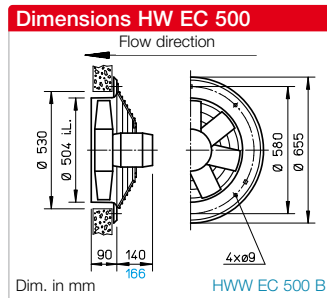
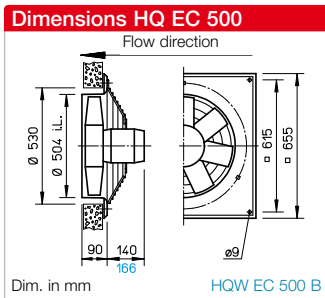

Description for all types

■ **Casing**

Made of galvanised steel sheet, types HQ and HW have additional two layer lacquer coating in papyrus white.

■ **Impeller**

High performance characteristics with profiled blades made of plastic, aerodynamically optimised for application, dynamically balanced.

■ **Drive**

Energy-saving, speed-controlable external rotor EC motor in protection category IP54 with the highest level of efficiency. Maintenance-free and radio interference-free, excellent electromagnetic compatibility (EMC), ball bearing mounted.

■ **Motor protection**

Integrated electronic temperature monitoring system for EC motor and electronics.

■ **Electrical connection**

Standard terminal box (protection category IP54). Mounted to external cable for HQ and HW types (version "A") or on back of motor (version "B"). Mounted on outside of duct for HRF types.

■ **Protection grille**

Made of powder-coated steel for HQ and HW in accordance with DIN EN ISO 13857.

■ **Power control**

All types have continuously variable speed control via speed potentiometer. Control is also possible via three level switch or continuously variable via universal control system or electronic differential pressure/temperature controller. See type table. Performance levels are shown on the performance curve as examples.

■ **Installation**

Installation possible in any position.

■ **Noise levels**

The total level and range for the sound power level and sound pressure level at 4 m free field conditions are specified above the performance diagram for the average operating point on the inlet/outlet side. The total sound pressure level at 4 m (free field conditions) is also specified in the type table, as well as the table below the performance diagram for various voltages. See page 10 f for noise emissions and room acoustics.

Speed	Flow rate-free-blowing	Power consump.	Current consump.	Sound pressure	Wiring diagram	Max. air flow temperature	Wgt net	Design type					
								HQ EC incl. protection grille	Ref. no.	HW EC incl. protection grille	Ref. no.	HRF EC	Ref. no.
min ⁻¹	V m ³ /h	kW	A	dB(A) at 4m	No.	+°C	ca. kg						
Alternating current, 1~, 230 Volt, 50/60 Hz, EC motor, protection category IP54													
1090	6320	0.29	1.30	54	1047	40	15.7	HQW EC 500 A	04934	HWW EC 500 A	04935	HRFW EC 500 A	04936
1450	8300	0.67	3.00	62	1048	40	17.7	HQW EC 500 B	04937	HWW EC 500 B	04938	HRFW EC 500 B	04939

Performance curves HQ EC / HW EC / HRF EC 500 A

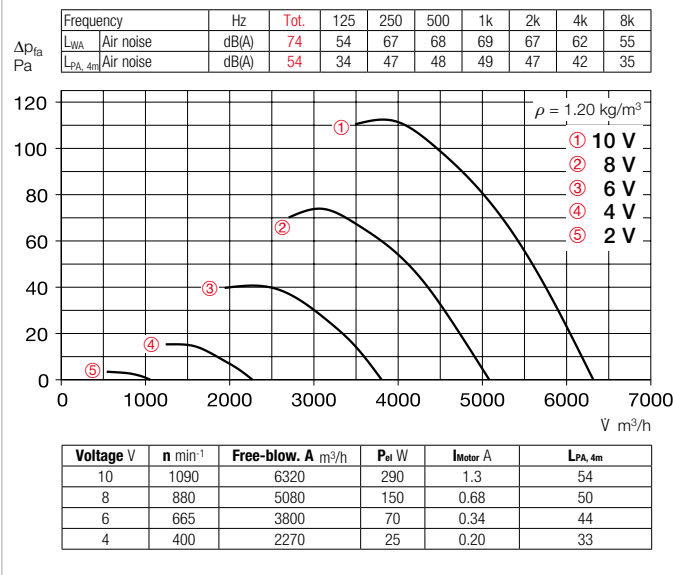

Performance curves HQ EC / HW EC / HRF EC 500 B

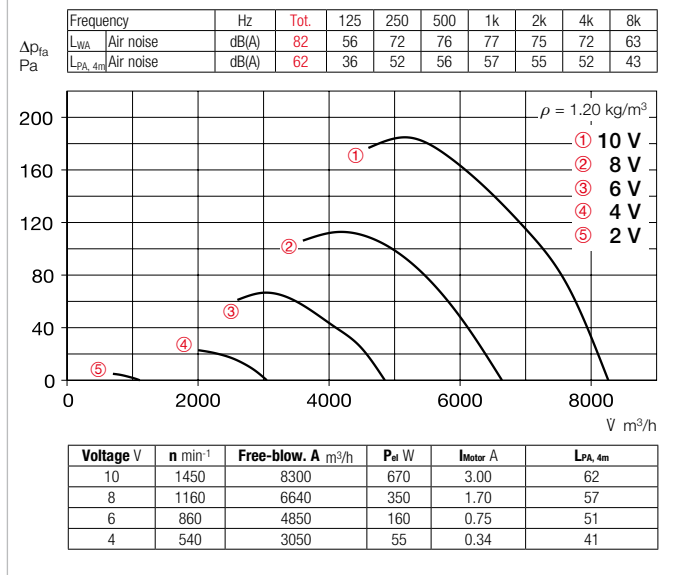

Accessories for HRF EC 500 Description see page 268 ff.

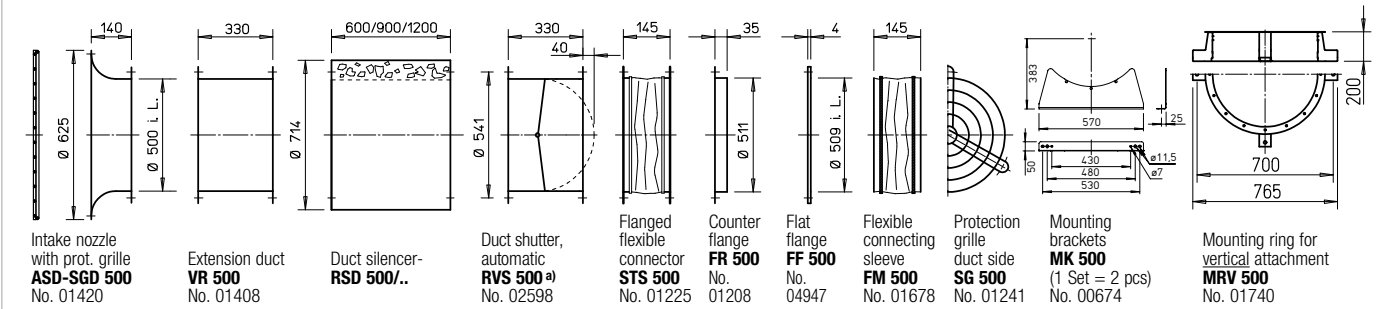

^{a)} Shutter, motorised see Accessories product pages.

References	Page	Other accessories	Page
Techn. description	172	Filters and silencers	473 ff.
Selection table	173	Shutters and ventilation grilles	553 ff.
Planning information	10 ff.	Universal control system, electronic controller, Speed potentiometer	605 ff.

Special design
Different voltage, air flow direction, higher air flow temperature, acid protection upon request.

The technical information on p.15 ff. must be observed.

Universal control system		Speed potentiometer		Three level speed switch		Electronic pressure difference controller/ actuator		Electronic temperature controller/actuator					
Type	Ref. no.	Type	Ref. no.	Type	Ref. no.	Type	Ref. no.	Type	Ref. no.				
EUR EC ¹⁾	01347	PU 10 ¹⁾	01734	PA 10 ¹⁾	01735	SU-3 10 ¹⁾	04266	SA-3 10 ¹⁾	04267	EDR ¹⁾	01437	ETR ¹⁾	01438
EUR EC ¹⁾	01347	PU 10 ¹⁾	01734	PA 10 ¹⁾	01735	SU-3 10 ¹⁾	04266	SA-3 10 ¹⁾	04267	EDR ¹⁾	01437	ETR ¹⁾	01438

¹⁾ Multiple EC fans can normally be connected, see Accessories.

HRF EC 560

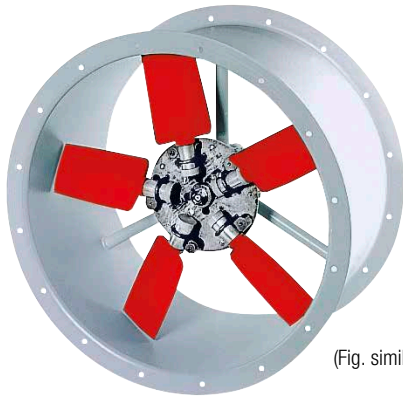

(Fig. similar)



Dimensions HRF EC 560

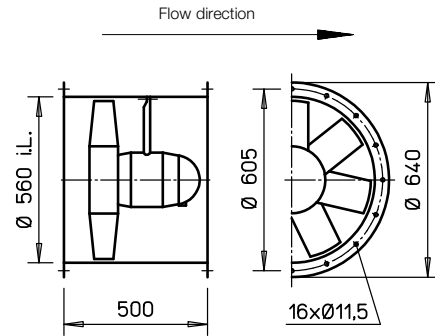

Dim. in mm

■ Description

High performance axial EC fan in pipe sleeve, with double-sided flanges for direct intermediate setting in pipelines. Flange in accordance with DIN 24155, p. 3.

■ Casing

Made of galvanised steel sheet, additional terminal box (IP54) on outside of duct.

■ Impeller

High performance characteristics with profiled blades made of plastic, aerodynamically optimised for application, dynamically balanced.

■ Drive

Energy-saving, speed-controllable external rotor EC motor in protection category IP54 with the highest level of efficiency. Maintenance-free and radio interference-free, excellent electromagnetic compatibility (EMC), ball bearing mounted.

■ Motor protection

Integrated electronic temperature monitoring system for EC motor and electronics.

■ Electrical connection

Standard terminal box (protection category IP54) on back of motor, additional terminal box on outside of duct.

■ Power control

All types have continuously variable speed control via speed potentiometer. Control is also possible via three level switch or continuously variable via universal control system or electronic differential pressure/temperature controller. See type table.

■ Installation

Installation possible in any position.

■ Noise levels

The total level and range for the sound power level and sound pressure level at 4 m free field conditions are specified above the performance diagram for the average operating point on the inlet/outlet side. The total sound pressure level at 4 m (free field conditions) is also specified in the table below the performance diagram for various voltages. See page 10 f for noise emissions and room acoustics.

Speed	Flow rate-free-blowing	Power consump.	Current consum.	Sound pressure	Wiring diagram	Max. air flow temperature	Wgt net	Design type	
								HRF EC	Ref. no.
min ⁻¹	V m ³ /h	kW	A	dB(A) at 4m	No.	+°C	ca. kg		
Alternating current, 1~, 230 Volt, 50/60 Hz, EC motor, protection category IP54									
1200	9740	0.56	2.45	55	1201	40	35	HRFW EC 560	04874

Performance curves HRF EC 560 A

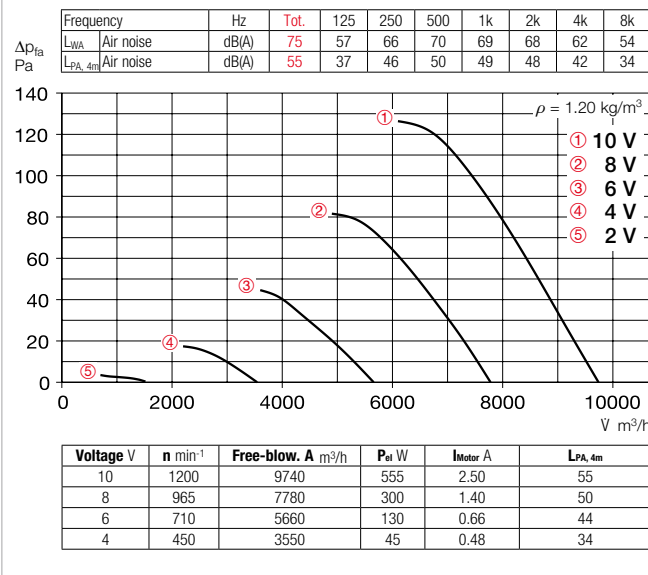

Accessories for HRF EC 560 Description see page 268 ff.

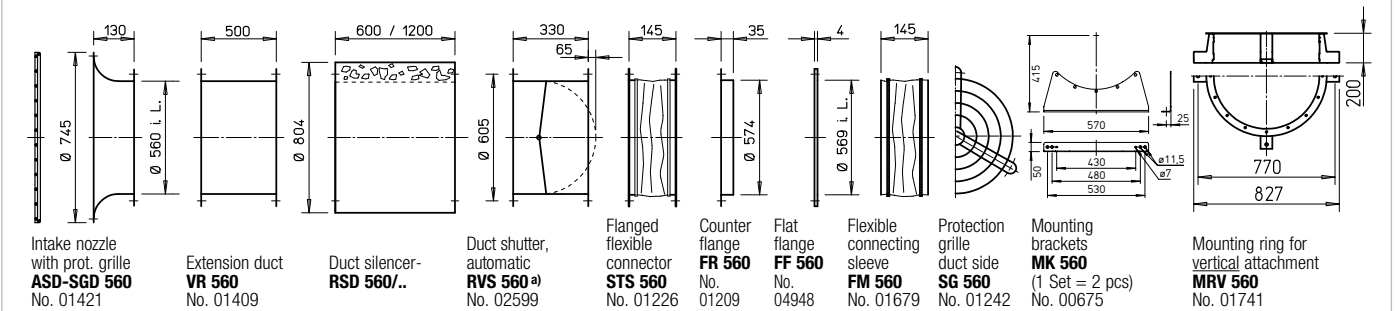

^{a)} Shutter, motorised see Accessories product pages.

References	Page	Other accessories	Page
Techn. description	172	Filters and silencers	473 ff.
Selection table	173	Shutters and ventilation grilles	553 ff.
Planning information	10 ff.	Universal control system, electronic controller, Speed potentiometer	605 ff.

Special design
 Different voltage, air flow direction, higher air flow temperature, acid protection upon request.

The technical information on p.15 ff. must be observed.

Universal control system		Speed potentiometer		Three level speed switch		Electronic pressure difference controller/ actuator		Electronic temperature controller/actuator					
Type	Ref. no.	Type	Ref. no.	Type	Ref. no.	Type	Ref. no.	Type	Ref. no.				
EUR EC ¹⁾	01347	PU 10 ¹⁾	01734	PA 10 ¹⁾	01735	SU-3 10 ¹⁾	04266	SA-3 10 ¹⁾	04267	EDR ¹⁾	01437	ETR ¹⁾	01438

¹⁾ Multiple EC fans can normally be connected, see Accessories.

HRF EC 630

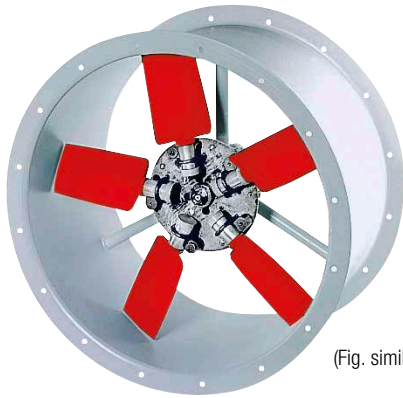

(Fig. similar)



Dimensions HRF EC 630

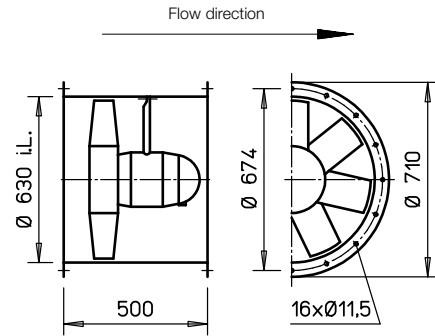

Dim. in mm

■ Description

High performance axial EC fan in pipe sleeve, with double-sided flanges for direct intermediate setting in pipelines. Flange in accordance with DIN 24155, p. 3.

■ Casing

Made of galvanised steel sheet, additional terminal box (IP54) on outside of duct.

■ Impeller

High performance characteristics with profiled blades made of plastic, aerodynamically optimised for application, dynamically balanced.

■ Drive

Energy-saving, speed-control-able external rotor EC motor in protection category IP54 with the highest level of efficiency. Maintenance-free and radio interference-free, excellent electromagnetic compatibility (EMC), ball bearing mounted.

■ Motor protection

Integrated electronic temperature monitoring system for EC motor and electronics.

■ Electrical connection

Standard terminal box (protection category IP54) on back of motor, additional terminal box on outside of duct.

■ Power control

All types have continuously variable speed control via speed potentiometer. Control is also possible via three level switch or continuously variable via universal control system or electronic differential pressure/temperature controller. See type table.

■ Installation

Installation possible in any position.

■ Noise levels

The total level and range for the sound power level and sound pressure level at 4 m free field conditions are specified above the performance diagram for the average operating point on the inlet/outlet side. The total sound pressure level at 4 m (free field conditions) is also specified in the table below the performance diagram for various voltages. See page 10 f for noise emissions and room acoustics.

Speed	Flow rate-free-blowing	Power consump.	Current consum.	Sound pressure	Wiring diagram	Max. air flow temperature	Wgt net	Design type	
								HRF EC	Ref. no.
min ⁻¹	V m ³ /h	kW	A	dB(A) at 4m	No.	+°C	ca. kg		
Alternating current, 1~, 230 Volt, 50/60 Hz, EC motor, protection category IP54									
960	10330	0.45	2.20	54	1201	40	37	HRFW EC 630	04875

Performance curves HRF EC 630 A

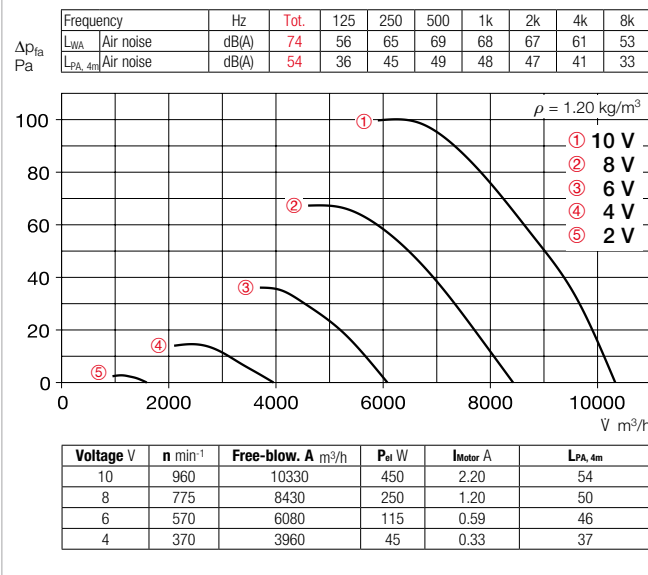

Accessories for HRF EC 630 Description see page 268 ff.

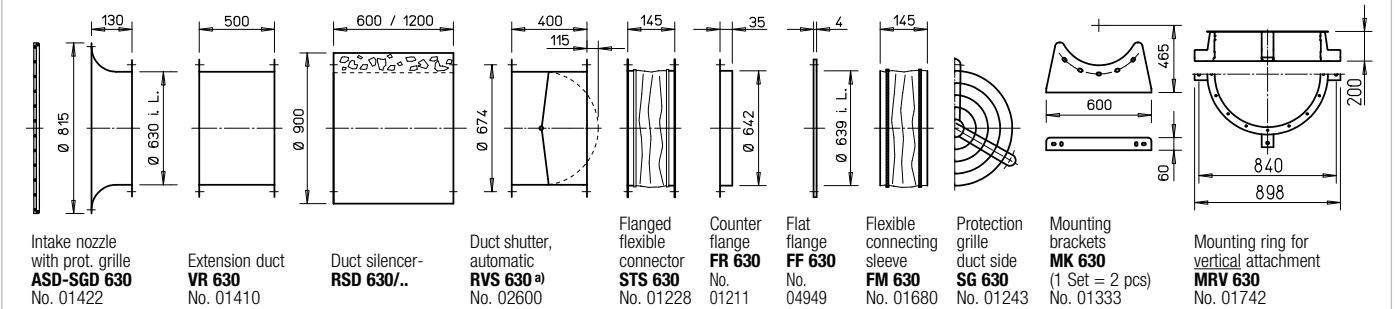

^{a)} Shutter, motorised see Accessories product pages.

References	Page	Other accessories	Page
Techn. description	172	Filters and silencers	473 ff.
Selection table	173	Shutters and ventilation grilles	553 ff.
Planning information	10 ff.	Universal control system, electronic controller, Speed potentiometer	605 ff.
Special design Different voltage, air flow direction, higher air flow temperature, acid protection upon request.			
The technical information on p.15 ff. must be observed.			

Universal control system		Speed potentiometer		Three level speed switch		Electronic pressure difference controller/actuator		Electronic temperature controller/actuator					
Type	Ref. no.	Type	Ref. no.	Type	Ref. no.	Type	Ref. no.	Type	Ref. no.				
EUR EC ¹⁾	01347	PU 10 ¹⁾	01734	PA 10 ¹⁾	01735	SU-3 10 ¹⁾	04266	SA-3 10 ¹⁾	04267	EDR ¹⁾	01437	ETR ¹⁾	01438

¹⁾ Multiple EC fans can normally be connected, see Accessories.

HRF EC 710

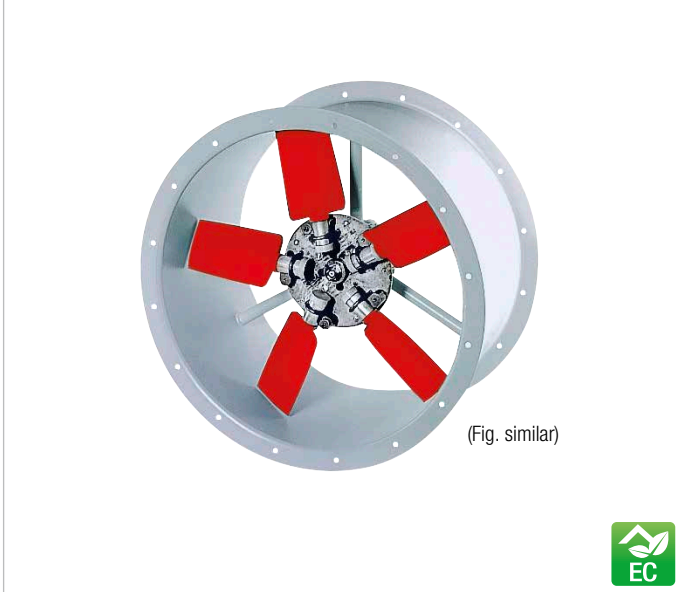

Dimensions HRF EC 710

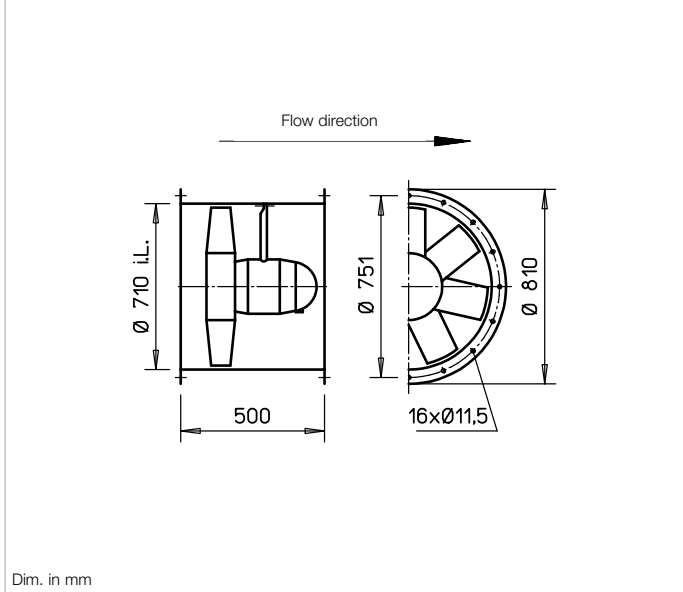

■ Description

High performance axial EC fan in pipe sleeve, with double-sided flanges for direct intermediate setting in pipelines. Flange in accordance with DIN 24155, p. 3.

■ Casing

Made of galvanised steel sheet, additional terminal box (IP54) on outside of duct.

■ Impeller

High performance characteristics with profiled blades made of plastic, aerodynamically optimised for application, dynamically balanced.

■ Drive

Energy-saving, speed-controllable external rotor EC motor in protection category IP54 with the highest level of efficiency. Maintenance-free and radio interference-free, excellent electromagnetic compatibility (EMC), ball bearing mounted.

■ Motor protection

Integrated electronic temperature monitoring system for EC motor and electronics.

■ Electrical connection

Standard terminal box (protection category IP54) on back of motor, additional terminal box on outside of duct.

■ Power control

All types have continuously variable speed control via speed potentiometer. Control is also possible via three level switch or continuously variable via universal control system or electronic differential pressure/temperature controller. See type table.

■ Installation

Installation possible in any position.

■ Noise levels

The total level and range for the sound power level and sound pressure level at 4 m free field conditions are specified above the performance diagram for the average operating point on the inlet/outlet side. The total sound pressure level at 4 m (free field conditions) is also specified in the type table, as well as the table below the performance diagram for various voltages. See page 10 f for noise emissions and room acoustics.

Speed	Flow rate-free-blowing	Power consump.	Current consum.	Sound pressure	Wiring diagram	Max. air flow temperature	Wgt net	Design type	
								HRF EC	Ref. no.
min ⁻¹	V m ³ /h	kW	A	dB(A) at 4m	No.	+°C	ca. kg		
Three-phase current, 3~, 400 Volt, 50/60 Hz, EC motor, protection category IP54									
1100	19400	1.32	2.10	61	1201	40	40	HRFD EC 710	04876

Performance curves HRF EC 710 A

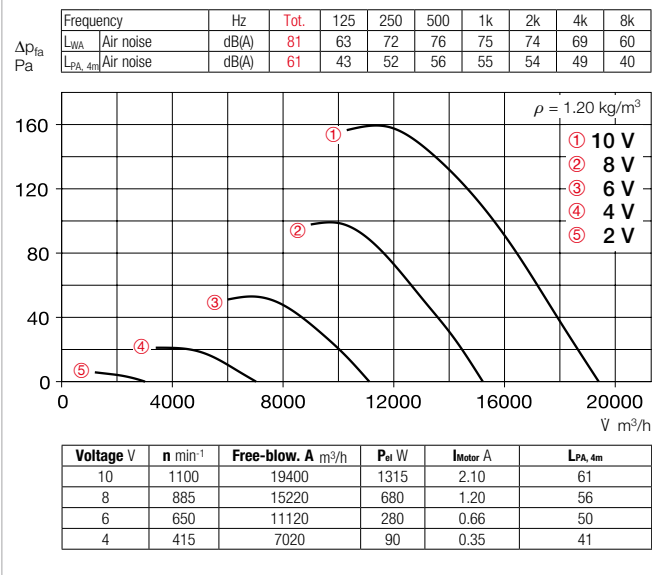

Accessories for HRF EC 710 Description see page 268 ff.

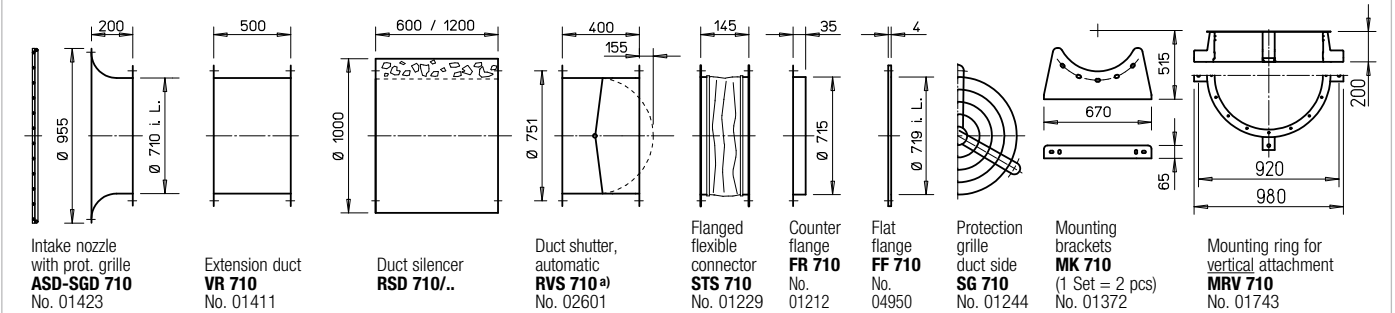

^{a)} Shutter, motorised see Accessories product pages.

References	Page	Other accessories	Page
Techn. description	172	Filters and silencers	473 ff.
Selection table	173	Shutters and ventilation grilles	553 ff.
Planning information	10 ff.	Universal control system, electronic controller, Speed potentiometer	605 ff.

Special design
Different voltage, air flow direction, higher air flow temperature, acid protection upon request.

The technical information on p.15 ff. must be observed.

Universal control system		Speed potentiometer		Three level speed switch		Electronic pressure difference controller/actuator		Electronic temperature controller/actuator					
Type	Ref. no.	Type	Ref. no.	Type	Ref. no.	Type	Ref. no.	Type	Ref. no.				
EUR EC ¹⁾	01347	PU 10 ¹⁾	01734	PA 10 ¹⁾	01735	SU-3 10 ¹⁾	04266	SA-3 10 ¹⁾	04267	EDR ¹⁾	01437	ETR ¹⁾	01438

¹⁾ Multiple EC fans can normally be connected, see Accessories.

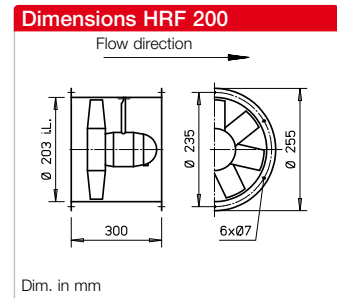
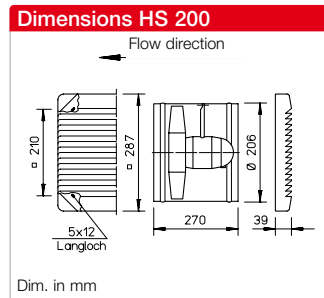
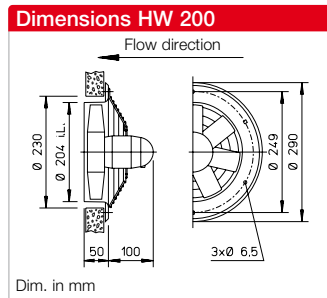
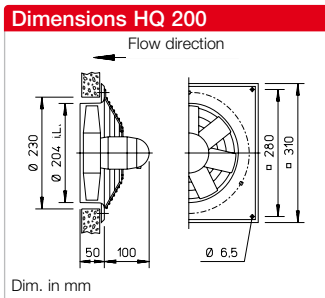

Description for all types

- **Casing**
 Made of galvanised steel sheet, types HQ and HW have additional two layer lacquer coating in papyrus white.
- **Impeller**
 High performance characteristics with profiled blades made of plastic, dynamically balanced.
- **Drive**
 Closed casing made of die-cast aluminium. Protection category IP54, ball bearing mounted. Maintenance-free and radio interference-free. Winding with moisture proof coating. See type table for max. air flow temperature.

- **Motor protection**
 Through built-in thermal contacts wired in series with the winding, automatic deactivation and reactivation after cool down.
- **Electrical connection**
 Standard terminal box (IP54) on back of motor. Additionally on outside of duct for HRF types.
- **Protection grille**
 Made of powder-coated steel for HQ and HW, and plastic for HS. In accordance with DIN EN ISO 13857.
- **Power control**
 All types can be controlled through voltage reduction (electronic or via transformer). The flow rates are shown in the performance diagram.

- **Reverse operation**
 All types are reversible using a DSEL switch. Performance reduction of approx. 1/3 in abnormal flow direction.
- **Installation**
 Installation possible in any position, but be aware of any condensate drain holes depending on usage.
- **Noise levels**
 See performance diagram. The sound power and sound pressure at 1 m distance under free field conditions are specified for the average operating point on the inlet/outlet side. See page 10 f for noise emissions and room acoustics.

Reference	Page
Techn. description	172
Selection table	173
Planning information	10 ff.

Special design
 Different voltage, protection category, air flow direction, higher air flow temperature, acid protection and impeller in other materials upon request.

The technical information on p. 15 ff. must be observed.

Speed	Flow rate free-blowing	Power consump.	Current consump.		Wiring diagram	Max. air flow temp.		Weight net aprx.	Design type							
			at rated voltage	max. with control		at rated voltage	with control		HQ incl. protection grille	Ref. no.	HW incl. protection grille	Ref. no.	HS incl. protection grille	Ref. no.	HRF	Ref. no.
min ⁻¹	V m ³ /h	W	A	A	No.	+ °C	+ °C	kg								
Single-phase alternating current. 230 Volt, 50 Hz, Capacitor motor, protection category IP54																
1360	520	25	0.11	0.11	439 ¹⁾	60	40	3.8	HQW 200/4	07537	HW 200/4	07538	HS 200/4	07502	HRFW 200/4¹⁾	07540
2250	930	66	0.26	0.31	439 ¹⁾	40	40	2.7	HQW 200/2	00960	–	–	HS 200/2	07503	HRFW 200/2¹⁾	00199

¹⁾ Type HRFW: Connection according to wiring diagram no. 962.

Performance curves 200/2

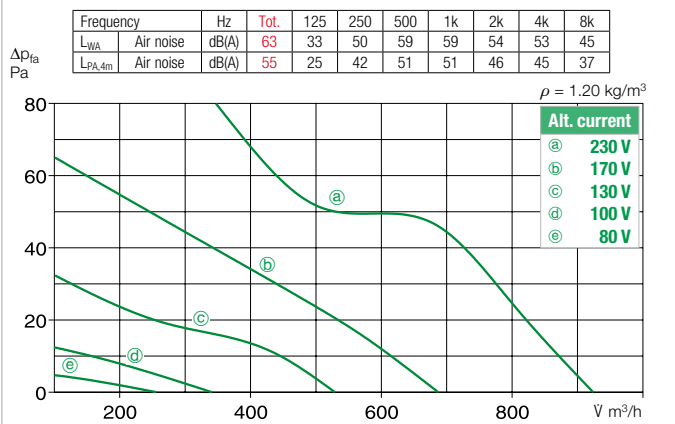

Performance curves 200/4

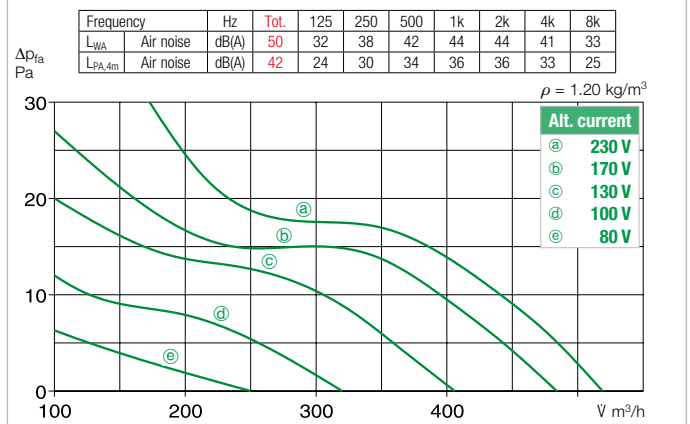

Accessories for HRF 200 Description see page 268 ff.

Intake nozzle
ASD 200
No. 01388

Flanged flexible connector
STS 200
No. 01219

Counter flange
FR 200
No. 01202

Flexible connecting sleeve
FM 200
No. 01670

Protection grille duct side
SG 200
No. 01216

2 mounting brackets
1 x MK 200
(= 2 pcs)
No. 01446

4 vibration dampers for tensile load
1 x SDZ 1 (= 4 Pc) No.01454
4 vibration dampers for compression load
1 x SDD 1 (= 4 Pc) No.01452

Type	Ref. no.	Type	Ref. no.	Type	Ref. no.	Type	Ref. no.
Transformer speed controller 5-step		Electronic speed controller, continuously variable flush-m./surface-m.		Reverser switch		Electronic speed controller with reverser switch	
TSW 0.3	03608	ESU 1/ESA 1	00236/00238	DSEL 2	01306	BSX	00240
TSW 0.3	03608	ESU 1/ESA 1	00236/00238	DSEL 2	01306	BSX	00240

Other accessories Page

Extension sleeve for HS VH 200 Ref. no. 01349
Cylindrical pipe section, galvanised steel, 15 cm long.

Filters and silencers 473 ff.
shutters and ventilation grilles 553 ff.
Speed controllers, controllers and switches 591 ff.

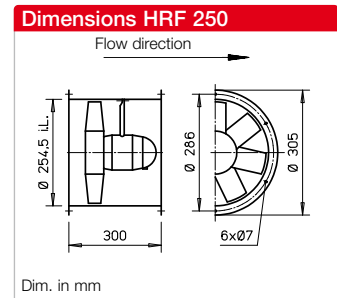
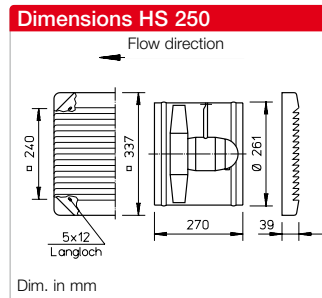
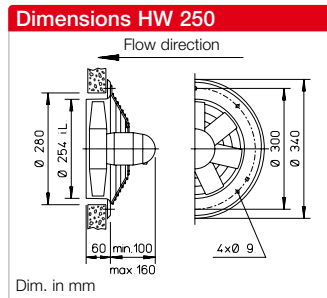
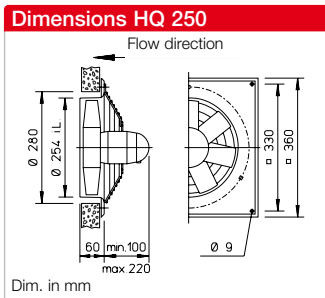

Description for all types

- **Casing**
 Made of galvanised steel sheet, types HQ and HW have additional two layer lacquer coating in papyrus white. Explosion-proof types have no lacquer coating.
- **Impeller**
 High performance characteristics with profiled blades made of plastic, dynamically balanced. Different for explosion-proof types.
- **Drive**
 Closed die-cast aluminium casing. Protection category IP55 or IP54. Ball bearing mounted. Maintenance-free and radio interference-free. Winding with moisture proof coating. See type table for max. air flow temperature. Different for explosion-proof types.

- **Motor protection**
 All types (except for 3~ explosion-proof) are equipped 172th thermal contacts. These should be wired with the motor protection circuit breaker (see type table) for effective motor protection. For types H..W 250/6, H..W 250/4 and all 1~ explosion-proof fans, the thermal contacts are wired in series with the winding, automatic deactivation and reactivation after cool down.
- **Electrical connection**
 Standard terminal box (IP54/55) on back of motor. Additionally on outside of duct for HRF types. Different for explosion-proof types.
- **Protection grille**
 Made of powder-coated steel for HQ/HW (HQ Ex galvanised), and plastic for HS. In accordance with DIN EN ISO 13857.

- **Power control**
 The voltage-controllable types are identified in the "Current consumption max. with control" column with a value which must be observed when determining the controller (see speed controller column). Possible assignments of frequency inverters to fans are shown in the performance diagram. The flow rates are shown in the performance diagram.
- **Reverse operation**
 All types are reversible using a reverser switch. Performance reduction of approx. 1/3 in abnormal flow direction.
- **Installation**
 Installation possible in any position, but be aware of any condensate drain holes depending on usage.

- **Dimensions**
 Pole-changeable and explosion-proof types may differ from the above information.
- **Noise levels**
 See performance diagram. The sound power and sound pressure at 4 m distance under free field conditions are specified for the average operating point on the inlet/outlet side. See page 10 f for noise emissions and room acoustics. Different for explosion-proof types.

Reference	Page
Techn. description	172
Selection table	173
Planning information	10 ff.

Speed	Flow rate free-blowing	Power consump.	Current consump.		Wiring diagram	Max. air flow temp.		Weight net appr.	Design type							
			at rated voltage	max. with control		at rated voltage	with control		HQ incl. protection grille	Ref. no.	HW incl. protection grille	Ref. no.	HS incl. protection grille	Ref. no.	HRF	Ref. no.
min ⁻¹	V m ³ /h	W	A	A	No.	+ °C	+ °C	kg								
Single-phase alternating current, 230 Volt, 50 Hz, Capacitor motor, protection category IP54/55																
930	660	35	0.20	0.22	317	60	40	6.5	HQW 250/6	01102	—	HSW 250/6	00139	—		
1300	930	36	0.15	0.15	439 ¹⁾	60	40	7.5	HQW 250/4 ¹⁾	01103	HWW 250/4 ¹⁾	01001	HSW 250/4 ¹⁾	00140	HRFW 250/4 ¹⁾²⁾	00200
2710	2070	187	0.81	0.9	317 ¹⁾	60	40	6.5	HQW 250/2	01104	HWW 250/2	01002	HSW 250/2	00141	HRFW 250/2 ³⁾	00201
Three-phase current, 400 Volt, 50 Hz, Squirrel-cage rotor, protection category IP55																
980	700	61	0.27	0.33	469	60	40	6.5	HQD 250/6	01114	—	—	—	—	—	—
1390	950	55	0.15	0.15	469	60	40	6.5	HQD 250/4 ¹⁾	01115	HWD 250/4 ¹⁾	01016	HSD 250/4 ¹⁾	00155	HRFD 250/4 ¹⁾	00220
2550	2000	169	0.31	0.33	469	60	40	6.5	HQD 250/2	01116	HWD 250/2	01017	—	—	HRFD 250/2	00221
Pole-changeable, 2 speeds, three-phase current, Dahlander winding, 400 Volt, 50 Hz, protection category IP55																
1430/2770	1030/2110	58/212	0.16/0.43	—	472	60	—	8.5	HQD 250/4/2	01128	—	—	—	—	HRFD 250/4/2	00390
Ex Ex Explosion-proof, II 2G Ex h IIB T3 Gb, Motor Ex d, alternating current 230 Volt, 50 Hz, protection category IP55																
1400	1030	60*	0.70*	—	757	40	—	12	HQW 250/4 Ex	00438	—	—	—	—	HRFW 250/4 Ex	00437
2690	1950	180*	1.23*	—	757	40	—	13	HQW 250/2 Ex	01094	—	—	—	—	HRFW 250/2 Ex	01095
Ex Ex Explosion-proof, II 2G Ex h IIB + H₂ T3 Gb, Motor Ex e, three-phase current 400 Volt, 50 Hz, protection category IP55																
1350	1070	120*	0.37*	—	470	40	—	12	HQD 250/4 Ex	01144	—	—	—	—	HRFD 250/4 Ex	00470
2800	2070	250*	0.75*	—	470	40	—	11	HQD 250/2 Ex	01145	—	—	—	—	HRFD 250/2 Ex	00471

* Motor ratings, Ex see information on page 16. ¹⁾ Special design not possible. ²⁾ Type HRFW..4: Connection according to wiring diagram no. 962. ³⁾ Type HRFW..2: Connection according to wiring diagram no. 963.

Performance curves 250/2

Frequency		Hz	Tot.	125	250	500	1k	2k	4k	8k
L _{WA}	Air noise	dB(A)	75	38	53	66	68	70	69	62
L _{PA,4m}	Air noise	dB(A)	55	18	33	46	48	49	48	42

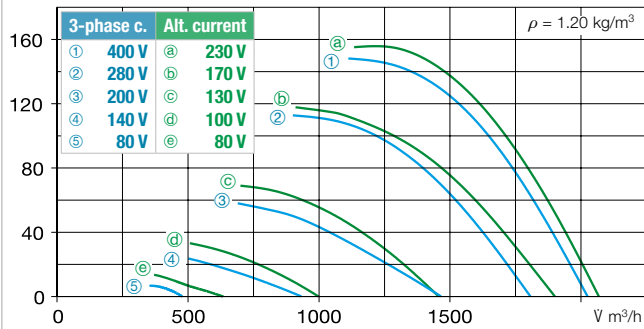

Performance curves 250/4 Alternating current

Frequency		Hz	Tot.	125	250	500	1k	2k	4k	8k
L _{WA}	Air noise	dB(A)	58	41	52	53	51	49	43	29
L _{PA,4m}	Air noise	dB(A)	38	21	32	33	31	29	23	9

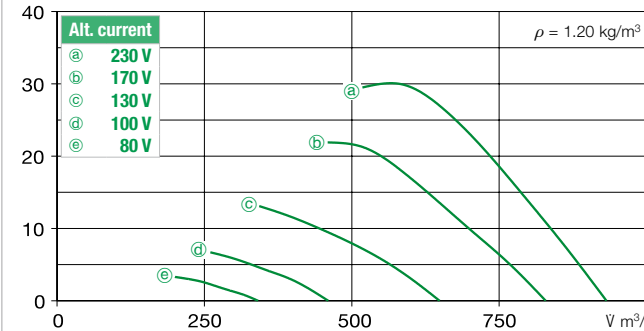

Performance curves 250/4 Three-phase current

Frequency		Hz	Tot.	125	250	500	1k	2k	4k	8k
L _{WA}	Air noise	dB(A)	60	34	49	53	53	54	50	38
L _{PA,4m}	Air noise	dB(A)	40	14	29	33	33	34	30	18

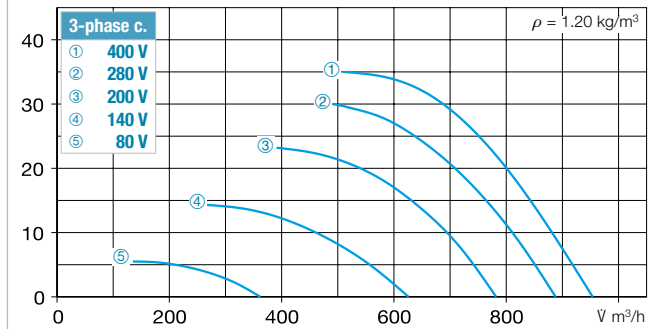

Performance curves 250/6

Frequency		Hz	Tot.	125	250	500	1k	2k	4k	8k
L _{WA}	Air noise	dB(A)	53	40	47	47	46	43	37	30
L _{PA,4m}	Air noise	dB(A)	33	20	27	27	26	23	17	10

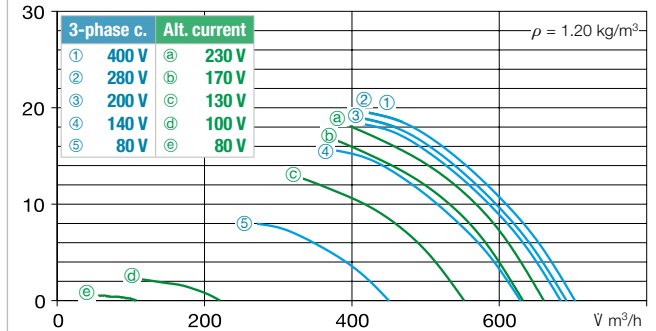

Accessories for HRF 250 Description see page 268 ff.

Intake nozzle with prot. grille ASD-SGD 250 No. 01414	Extension duct VR 250 No. 01402	Duct silencer RSD 250/..	Duct shutter, automatic RVS 250 a) No. 02592	Flanged flexible connector STS 250 b) No. 01220	Counter flange FR 250 No. 01203	Flat flange FF 250 No. 04941	Flexible connecting sleeve FM 250 b) No. 01672	Protection grille duct side SG 250 No. 01236	2 mounting brackets 1 x MK 250 (= 2 pcs) No. 01447	4 vibration dampers for tensile load 1 x SDZ 1 (= 4 Pcs) No. 01454 4 vibration dampers for compression load 1 x SDD 1 (= 4 Pcs) No. 01452
--	--	------------------------------------	---	--	--	---	---	---	--	--

a) Shutter, motorised see Accessories product pages.

b) See below for types for explosion-proof fans.

Frequency inverter with integrated sine filter		Transformer speed controller 5-step, pole changing switch		Electronic speed controller, continuously variable flush-m./surface-m.		Motor protection circuit breaker for connecting built-in thermal contacts		Reverser switch	
Type	Ref. no.	Type	Ref. no.	Type	Ref. no.	Type	Ref. no.	Type	Ref. no.
—	—	TSW 0.3	03608	ESU 1/ESA 1	00236/00238	—	—	WS	01271
—	—	TSW 0.3	03608	ESU 1/ESA 1	00236/00238	—	—	DSEL 2	01306
—	—	MWS 1.5⁴⁾	01947	ESU 3/ESA 3	00237/00239	MW	01579	WS	01271
FU-BS 2.5⁴⁾	05459	RDS 1⁴⁾	01314	—	—	MD	05849	WS	01271
FU-BS 2.5⁴⁾	05459	RDS 1⁴⁾	01314	—	—	MD	05849	WS	01271
FU-BS 2.5⁴⁾	05459	RDS 1⁴⁾	01314	—	—	MD	05849	WS	01271
—	—	Pole changing switch		—	—	—	—	—	—
—	—	PDA 12⁵⁾	05081	—	—	M 3⁶⁾	01293	PWDA	01282
—	—	not permitted	not permitted	not permitted	not permitted	—	—	—	—
—	—	not permitted	not permitted	not permitted	not permitted	—	—	—	—
—	—	not permitted	not permitted	not permitted	not permitted	—	—	—	—
—	—	not permitted	not permitted	not permitted	not permitted	—	—	—	—

⁴⁾ Incl. motor protection circuit breaker. ⁵⁾ Incl. speed pole changing switch. ⁶⁾ Flush-m. version see Switch product page.

Other accessories Page

- ^{b)} Access. for expl.-proof fans
- Flanged flexible connector**
STS 250 Ex Ref. no. 02501
 - Flexible connecting sleeve**
FM 250 Ex Ref. no. 01688
 - Extension sleeve for HS**
VH 250 Ref. no. 01343
 - Cylindrical pipe section, galvanised steel, 15 cm long.
 - Filter and silencers 473 ff.
 - Shutters and ventilation grilles 553 ff.
 - Speed controllers, controllers and switches 591 ff.

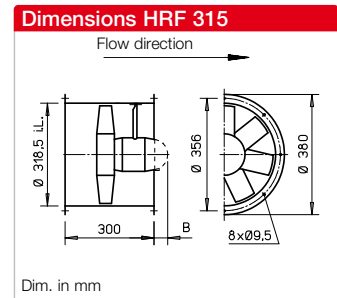
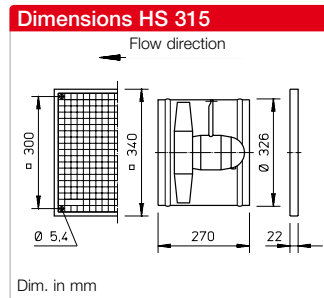
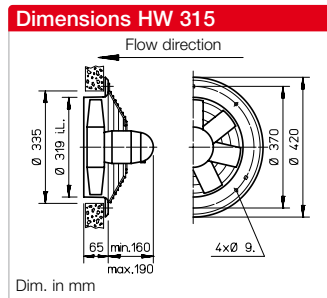
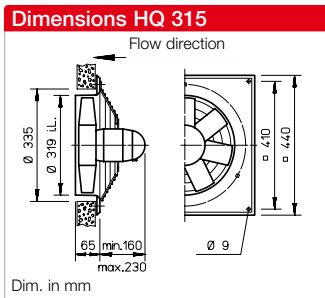

Description for all types

Casing

Made of galvanised steel sheet, types HQ and HW have additional two layer lacquer coating in papyrus white. Explosion-proof types have no lacquer coating.

Impeller

High performance characteristics with profiled blades made of plastic, dynamically balanced. Different for explosion-proof types.

Drive

Closed die-cast aluminium casing. Prot. cat. IP55. Ball bearing mounted. Maintenance-free and radio interference-free. Winding with moisture proof coating. See type table for max. air flow temperature. Different for explosion-proof types.

Motor protection

All types (except for 3~ explosion-proof, see page 172) are equipped with thermal contacts. These should be wired with the motor protection circuit breaker (see type table) for effective motor protection.

For types H.W 315/6 and all 1~ explosion-proof fans, the thermal contacts are wired in series with the winding, automatic deactivation and reactivation after cool down.

Electrical connection

Standard terminal box (IP55) on back of motor. Additionally on outside of duct for HRF types. Different for explosion-proof types.

Protection grille

Made of powder-coated steel for HQ/HW (HQ Ex galvanised), and plastic for HS. In accordance with DIN EN ISO 13857.

Power control

The voltage-controllable types are identified in the "Current consumption max. with control" column with a value which must be observed when determining the controller (see speed controller column). Possible assignments of frequency inverters to fans are shown in the type table. The flow rates are shown in the performance diagram.

Reverse operation

All types are reversible using a reverser switch. Performance reduction of approx. 1/3 in abnormal flow direction.

Installation

Installation possible in any position, but be aware of any condensate drain holes depending on usage.

Dimensions

Pole-changeable and explosion-proof types may differ from the above information.

Noise levels

See performance diagram. The sound power and sound pressure at 4 m distance under free field conditions are specified for the average operating point on the inlet/outlet side. See page 10 f for noise emissions and room acoustics. Different for explosion-proof types.

Speed	Flow rate free-blowing	Power consump.	Current consump.		Wiring diagram	Max. air flow temp.		Weight net aprx.	Design type							
			at rated voltage	max. with control		at rated voltage	with control		HQ incl. protection grille	Ref. no.	HW incl. protection grille	Ref. no.	HS incl. protection grille	Ref. no.	HRF	Ref. no.
min ⁻¹	V m ³ /h	W	A	A	No.	+ °C	+ °C	kg								
Single-phase alternating current, 230 Volt, 50 Hz, Capacitor motor, protection category IP55																
920	1330	33	0.25	0.35	317 ¹⁾	60	40	9.0	HQW 315/6	01105	—	HSW 315/6	00142	HRFW 315/6¹⁾	00202	
1390	2080	104	0.45	0.47	475 ¹⁾	60	40	8.0	HQW 315/4	01106	HWW 315/4	01004	HSW 315/4	00143	HRFW 315/4²⁾	00203
Three-phase current, 400 Volt, 50 Hz, Squirrel-cage rotor, protection category IP55																
950	1370	68	0.27	0.32	469	60	40	9.0	HQD 315/6	01117	—	—	—	—	—	
1330	1960	84	0.24	0.26	469	60	40	9.0	HQD 315/4	01118	HWD 315/4	01019	HSD 315/4	00158	HRFD 315/4	00223
2760	4080	527	1.10	1.23	469	50	40	11.0	HQD 315/2	01119	HWD 315/2	01020	—	HRFD 315/2	00224	
Two-speed, three-phase current, 400 V, 50 Hz, √3 connection, protection category IP55																
1040/1280	1530/1980	56/87	0.11/0.22	—	520	60	—	10.5	HQD 315/4/4	01460	—	—	—	HRFD 315/4/4	01462	
Pole-changeable, 2 speeds, three-phase current, Dahlander winding, 400 Volt, 50 Hz, protection category IP55																
720/1445	980/2060	49/115	0.20/0.43	—	472	60	—	12.0	HQD 315/8/4	01129	—	HSD 315/8/4	00346	HRFD 315/8/4	00391	
1445/2845	2100/4190	106/558	0.45/1.32	—	472	50	—	12.5	HQD 315/4/2	01131	—	HSD 315/4/2	00348	HRFD 315/4/2	00393	
		Explosion-proof, II 2G Ex h IIB T3 Gb, Motor Ex d, alternating current 230 Volt, 50 Hz, protection category IP55														
1370	2070	180*	1.25*	—	757	40	—	13.0	HQW 315/4 Ex	00442	—	—	—	HRFW 315/4 Ex	00439	
		Explosion-proof, II 2G Ex h IIB + H₂ T3 Gb, Motor Ex e, three-phase current 400 Volt, 50 Hz, protection category IP55														
920	1400	250*	0.97*	—	470	40	—	23.0	HQD 315/6 Ex	01098	—	—	—	—	—	
1350	2140	120*	0.37*	—	470	40	—	14.0	HQD 315/4 Ex	01147	—	—	—	HRFD 315/4 Ex	00473	
2770	4130	550*	1.43*	—	470	40	—	16.5	HQD 315/2 Ex	01148	—	—	—	HRFD 315/2 Ex	00474	

* Motor ratings, Ex see information on page 16. protection circuit breaker.

¹⁾ Type HRFW../6: Connection according to wiring diagram no. 963. ²⁾ Type HRFW../4: Connection according to wiring diagram no. 965.

³⁾ Incl. motor

Performance curves 315/2

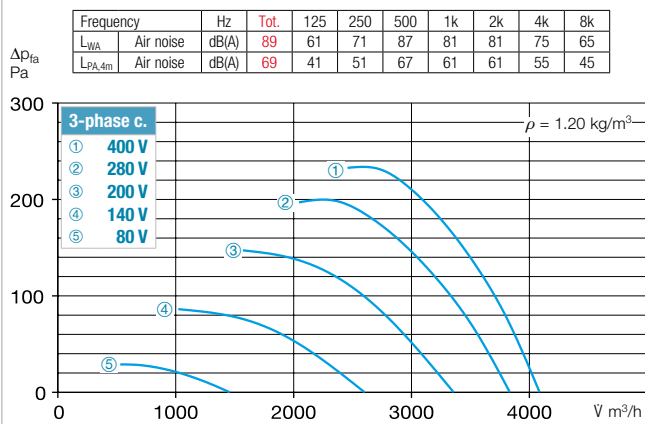

Performance curves 315/4

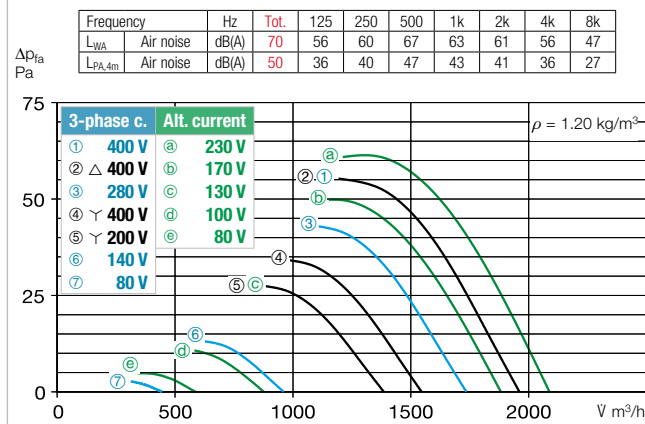

Performance curves 315/6

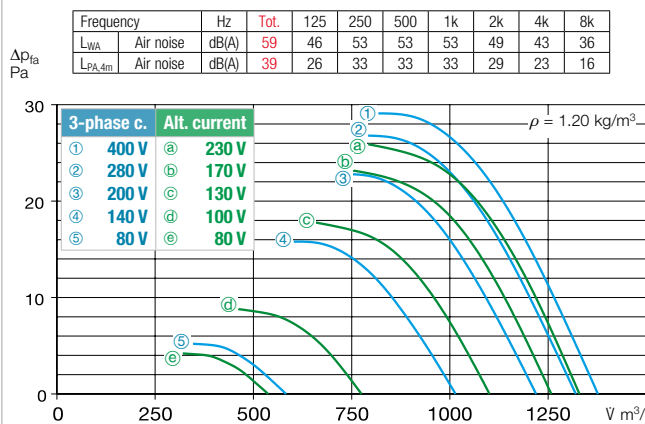

Performance curve 315/8

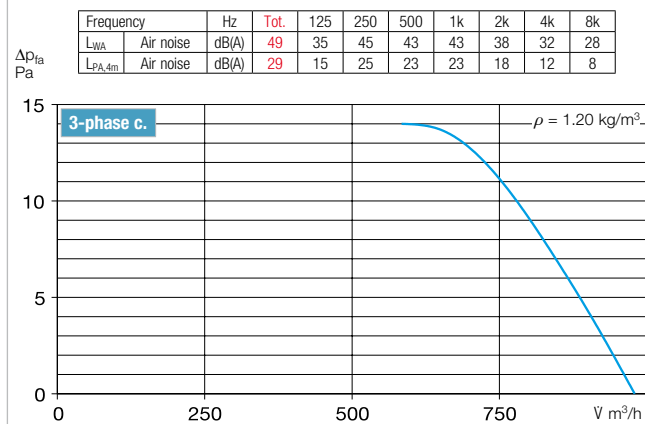

Accessories for HRF 315 Description see page 268 ff.

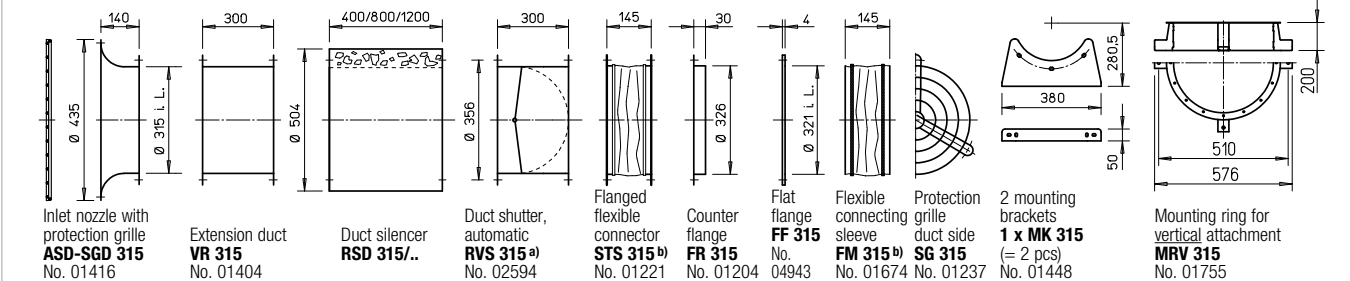

^{a)} Shutter, motorised see Accessories product pages.

^{b)} See below for types for explosion-proof fans.

Frequency inverter with integrated sine filter		Transformer speed controller 5-step, pole changing switch		Electronic speed controller, continuously variable flush-m./surface-m.		Motor protection circuit breaker for connecting built-in thermal contacts		Reverser switch	
Type	Ref. no.	Type	Ref. no.	Type	Ref. no.	Type	Ref. no.	Type	Ref. no.
—	—	TSW 0.3	03608	ESU 1/ESA 1	00236/00238	—	—	WS	01271
—	—	MWS 1.5³⁾	01947	ESU 1/ESA 1	00236/00238	MW	01579	WS	01271
FU-BS 2.5³⁾	05459	RDS 1³⁾	01314	—	—	MD	05849	WS	01271
FU-BS 2.5³⁾	05459	RDS 1³⁾	01314	—	—	MD	05849	WS	01271
FU-BS 2.5³⁾	05459	RDS 2³⁾	01315	EDS 5	00501	MD	05849	WS	01271
Speed changeover switch									
FU-BS 2.5³⁾	05459	DS2	01351	—	—	M 4⁴⁾ / MD	01571/05849	WS	01271
Pole changing switch									
—	—	PDA 12⁵⁾	05081	—	—	M 3⁴⁾	01293	PWDA	01282
—	—	PDA 12⁵⁾	05081	—	—	M 3⁴⁾	01293	PWDA	01282
—	—	not permitted	not permitted	not permitted	not permitted	—	—	—	—
—	—	not permitted	not permitted	not permitted	not permitted	—	—	—	—
—	—	not permitted	not permitted	not permitted	not permitted	—	—	—	—
—	—	not permitted	not permitted	not permitted	not permitted	—	—	—	—

⁴⁾ Incl. speed pole changing switch. ⁵⁾ Flush-m. version see Switch product page.

Other accessories Page

- ^{b)} Access. for expl.-proof fans
- Flanged flexible connector**
STS 315 Ex Ref. no. 02503
- Flexible connecting sleeve**
FM 315 Ex Ref. no. 01690
- Extension sleeve for HS**
VH 315 Ref. no. 01344
 Cylindrical pipe section, galvanised steel, 15 cm long.
- Filter and silencers 473 ff.
 Shutters and ventilation grilles 553 ff.
 Speed controllers, controllers and switches 591 ff.

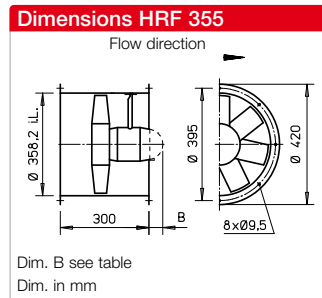
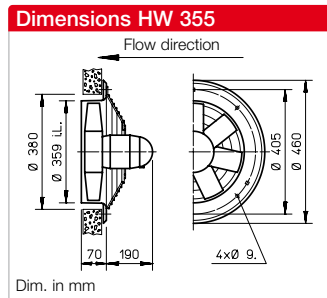
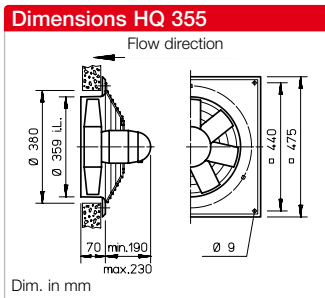

Description for all types

- **Casing**
 Made of galvanised steel sheet, types HQ and HW have additional two layer lacquer coating in papyrus white. Explosion-proof types have no lacquer coating.
- **Impeller**
 High performance characteristics with profiled blades made of plastic, dynamically balanced. Different for explosion-proof types.
- **Drive**
 Closed die-cast aluminium casing. Prot. cat. IP55. Ball bearing mounted. Maintenance-free and radio interference-free. Winding with moisture proof coating. See type table for max. air flow temperature. Different for explosion-proof types.

- **Motor protection**
 All types (except for 3~ explosion-proof, see page 172) are equipped with thermal contacts. These should be wired with the motor protection circuit breaker (see type table) for effective motor protection. For 1~ explosion-proof fans, the thermal contacts are wired in series with the winding, automatic deactivation and reactivation after cool down.
- **Electrical connection**
 Standard terminal box (IP55) on back of motor. Additionally on outside of duct for HRF types. Different for explosion-proof types.

- **Protection grille**
 Made of powder-coated steel for HQ and HW (HQ Ex galvanised). In accordance with DIN EN ISO 13857.
- **Power control**
 The voltage-controllable types are identified in the "Current consumption max. with control" column with a value which must be observed when determining the controller (see speed controller column). Possible assignments of frequency inverters to fans are shown in the performance diagram. The flow rates are shown in the performance diagram.
- **Reverse operation**
 All types are reversible using a reverser switch. Performance reduction of approx. 1/3 in abnormal flow direction.

- **Installation**
 Installation possible in any position, but be aware of any condensate drain holes depending on usage.
- **Dimensions**
 Pole-changeable and explosion-proof types may differ from the above information.
- **Noise levels**
 See performance diagram. The sound power and sound pressure at 4 m distance under free field conditions are specified for the average operating point on the inlet/outlet side. See page 10 f for noise emissions and room acoustics. Different for explosion-proof types.

Speed min ⁻¹	Flow rate free-blowing V m ³ /h	Power consump. W	Current consump.		Wiring diagram No.	Max. air flow temp.		Weight net appr. kg	Design type							
			at rated voltage A	max. with control A		at rated voltage + °C	with control + °C		HQ incl. protection grille	Ref. no.	HW incl. protection grille	Ref. no.	HRF	Ref. no.	Dim. B Motor protrusion in mm	
Single-phase alternating current, 230 Volt, 50 Hz, Capacitor motor, protection category IP55																
960	1940	75	0.47	0.47	475 ¹⁾	60	40	12	HQW 355/6	01107	—	—	HRFW 355/6 ¹⁾	00204	—	
1345	2850	130	0.60	0.65	475 ¹⁾	60	40	11	HQW 355/4	01108	HWW 355/4	01106	HRFW 355/4 ¹⁾	00205	10	
Three-phase current, 400 Volt, 50 Hz, Squirrel-cage rotor, protection category IP55																
960	1970	70	0.27	0.29	469	60	40	9.5	HQD 355/6	01120	—	—	—	—	—	
1375	2900	130	0.35	0.35	469	60	40	11.0	HQD 355/4	01121	HWD 355/4	01022	HRFD 355/4	00226	—	
2670	5710	825	1.60	1.60	469	60	40	15.0	HQD 355/2	01122	HWD 355/2	01023	HRFD 355/2	00227	—	
Two-speed, three-phase current, 400 V, 50 Hz, Δ/Y connection, protection category IP55																
1120/1350	2460/2860	90/132	0.17/0.32	—	520	60	—	11.0	HQD 355/4/4	01463	—	—	HRFD 355/4/4	01464	—	
Pole-changeable, 2 speeds, three-phase current, Dahlander winding, 400 Volt, 50 Hz, protection category IP55																
700/1395	1430/2920	45/145	0.14/0.35	—	472	60	—	11.0	HQD 355/8/4	01132	—	—	HRFD 355/8/4	00394	10	
1430/2840	3050/6150	250/950*	0.63/2.30*	—	472	40	—	16.0	HQD 355/4/2	01134	—	—	HRFD 355/4/2	00396	35	
Ex	Explosion-proof, II 2G Ex h IIB T3 Gb, Motor Ex d, alternating current 230 Volt, 50 Hz, protection category IP55															
1370	2940	180*	1.25*	—	757	40	—	18.0	HQW 355/4 Ex	00444	—	—	HRFW 355/4 Ex	00443	30	
Ex	Explosion-proof, II 2G Ex h IIB + H₂ T3 Gb, Motor Ex e, three-phase current 400 Volt, 50 Hz, protection category IP55															
920	2010	250*	0.97*	—	470	40	—	25.0	HQD 355/6 Ex	01101	—	—	—	—	—	
1350	3060	120*	0.37*	—	470	40	—	18.0	HQD 355/4 Ex	01150	—	—	HRFD 355/4 Ex	00476	—	
2830	5910	1100*	2.60*	—	470	40	—	12.5	HQD 355/2 Ex	01151	—	—	HRFD 355/2 Ex	00477	—	

* Motor ratings, Ex see information on page 16. ¹⁾ Type HRFW: Connection according to wiring diagram no. 965. ²⁾ Incl. motor protection circuit breaker. ³⁾ Incl. speed pole changing switch.

Performance curves 355/2

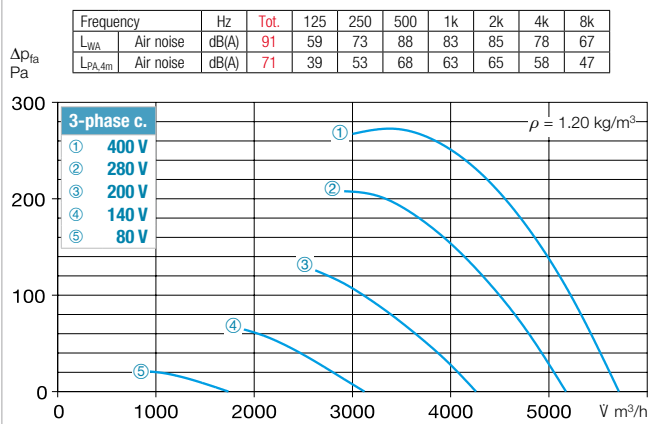

Performance curves 355/4

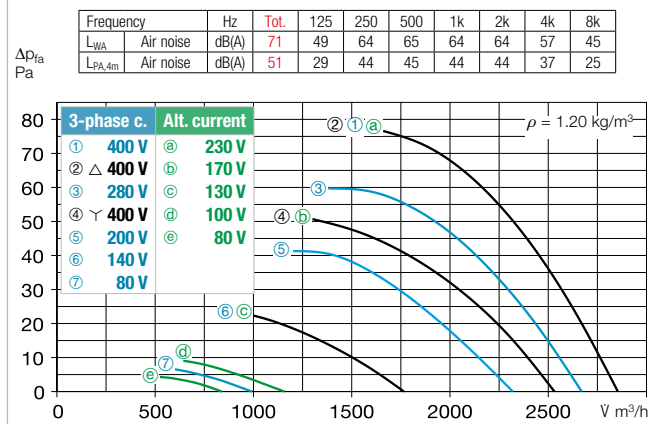

Performance curves 355/6

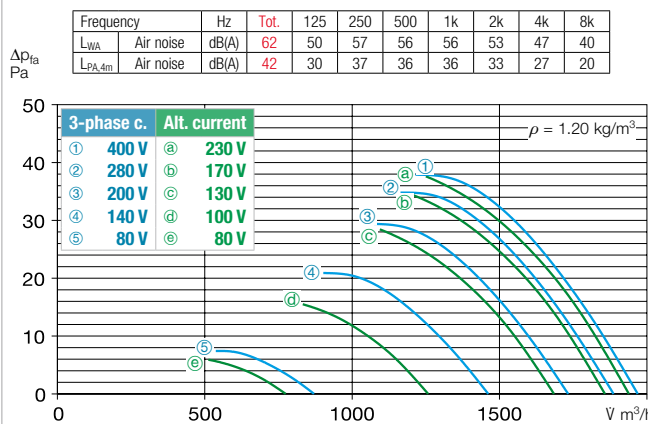

Performance curve 355/8

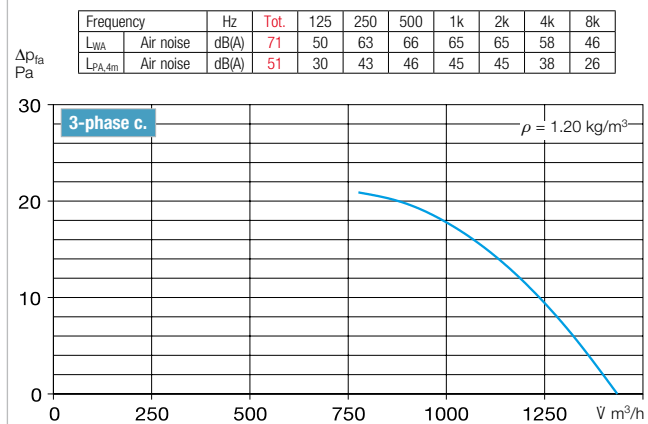

Accessories for HRF 355 Description see page 268 ff.

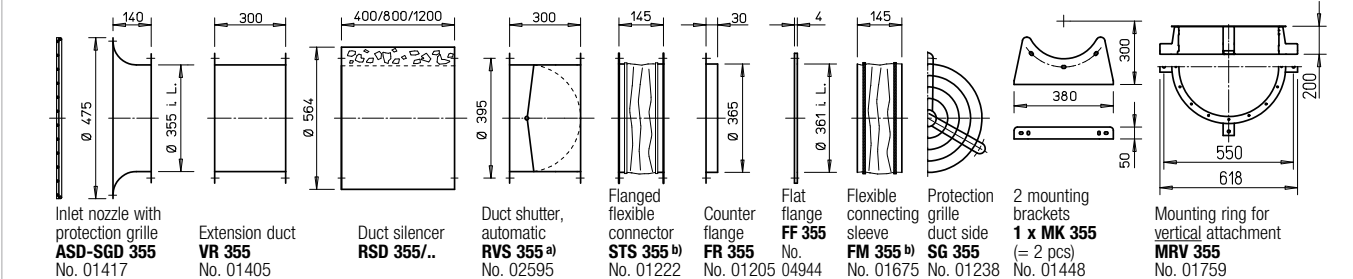

a) Shutter, motorised see Accessories product pages.

b) See below for types for explosion-proof fans.

Frequency inverter with integrated sine filter	Transformer speed controller 5-step, pole changing switch	Electronic speed controller, continuously variable flush-m./surface-m.	Motor protection circuit breaker for connecting built-in thermal contacts	Reverser switch	
Type	Ref. no.	Type	Ref. no.	Type	Ref. no.
—	MWS 1.5 ²⁾ 01947	ESU 1/ESA 1 00236/00238	MW 01579	WS 01271	
—	MWS 1.5 ²⁾ 01947	ESU 1/ESA 1 00236/00238	MW 01579	WS 01271	
FU-BS 2.5 ²⁾ 05459	RDS 1 ²⁾ 01314	—	MD 05849	WS 01271	
FU-BS 2.5 ²⁾ 05459	RDS 1 ²⁾ 01314	—	MD 05849	WS 01271	
FU-BS 2.5 ²⁾ 05459	RDS 2 ²⁾ 01315	ESD 5 00501	MD 05849	WS 01271	
—	Speed changeover switch DS 2 01351	—	M 4 ³⁾ /MD 01571/05849	WS 01271	
—	Pole changing switch PDA 12 ⁴⁾ 05081	—	M 3 ³⁾ 01293	PWDA 01282	
—	PDA 12 ⁴⁾ 05081	—	MSA 01289	PWDA 01282	
—	not permitted	not permitted	—	—	
—	not permitted	not permitted	—	—	
—	not permitted	not permitted	—	—	
—	not permitted	not permitted	—	—	

⁴⁾ Flush-m. version see Switch product page.

Other accessories Page

- ^{b)} Access. for expl.-proof fans
- Flanged flexible connector STS 355 Ex Ref. no. 02504
- Flexible connecting sleeve FM 355 Ex Ref. no. 01691
- Extension sleeve for HS VH 355 Ref. no. 01345
- Cylindrical pipe section, galvanised steel, 15 cm long.
- Filter and silencers 473 ff.
- Shutters and ventilation grilles 553 ff.
- Speed controllers, controllers and switches 591 ff.

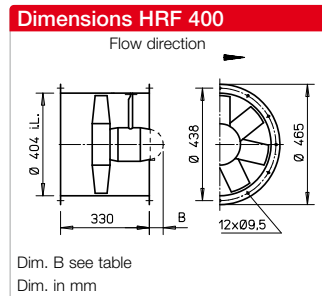
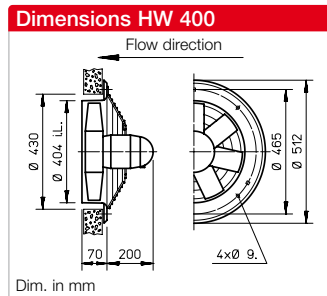
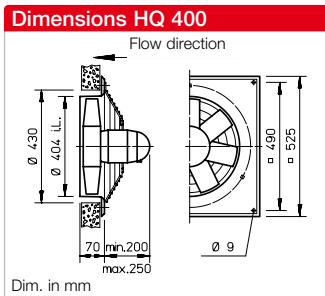

Description for all types

Casing

Made of galvanised steel sheet, types HQ and HW have additional two layer lacquer coating in papyrus white. Explosion-proof types have no lacquer coating

Impeller

High performance characteristics with profiled blades made of plastic, dynamically balanced. Different for explosion-proof types.

Drive

Closed die-cast aluminium casing. Prot. cat. IP55. Ball bearing mounted. Maintenance-free and radio interference-free. Winding with moisture proof coating. See type table for max. air flow temperature. Different for explosion-proof types.

Motor protection

All types (except for explosion-proof, see page 172) are equipped with thermal contacts. These should be wired with the motor protection circuit breaker (see type table) for effective motor protection.

Electrical connection

Standard terminal box (IP55) on back of motor. Additionally on outside of duct for HRF types. Different for explosion-proof types.

Protection grille

Made of powder-coated steel for HQ and HW (HQ Ex galvanised). In accordance with DIN EN ISO 13857.

Power control

The voltage-controllable types are identified in the "Current consumption max. with control" column with a value which must be observed when determining

the controller (see speed controller column). Possible assignments of frequency inverters to fans are shown in the type table. The planned use of a frequency inverter without a sine filter should be indicated when placing the order. This requires a change of fan version and additional costs, if necessary. The flow rates are shown in the perform. diagram.

Noise levels

See performance diagram. The sound power and sound pressure at 4 m distance under free field conditions are specified for the average operating point on the inlet/outlet side. See page 10 f for noise emissions and room acoustics. Different for explosion-proof types.

Reverse operation

All types are reversible using a reverser switch. Performance reduction of approx. 1/3 in abnormal flow direction.

Installation

Installation possible in any position, but be aware of any condensate drain holes depending on usage.

Dimensions

Pole-changeable and explosion-proof types may differ from the above information.

Reference	Page
Techn. description	172
Selection table	173
Planning information	10 ff.
Special design	
Different voltage, protection category, air flow direction, higher air flow temperature, acid protection and impeller in other materials upon request.	
The technical information on p. 15 ff. must be observed.	

Speed min ⁻¹	Flow rate free-blowing V m ³ /h	Power consump. W	Current consump.		Wiring diagram No.	Max. air flow temp.		Weight net aprx. kg	Design type						
			at rated voltage A	max. with control A		at rated voltage + °C	with control + °C		HQ incl. protection grille	Ref. no.	HW incl. protection grille	Ref. no.	HRF	Ref. no.	Dim. B Motor protrusion in mm
Single-phase alternating current, 230 Volt, 50 Hz, Capacitor motor, protection category IP55															
930	2570	77	0.52	0.54	475 ¹⁾	60	40	13.0	HQW 400/6	01110	—	—	HRFW 400/6 ²⁾	00206	—
1350	4010	235	1.00	1.10	475 ¹⁾	60	40	14.0	HQW 400/4	01111	HWW 400/4	01008	HRFW 400/4 ²⁾	00207	10
Three-phase current, 400 Volt, 50 Hz, Squirrel-cage rotor, protection category IP55															
950	2620	89	0.28	0.30	469	60	40	13.0	HQD 400/6	01123	—	—	—	—	—
1330	3960	200	0.40	0.40	469	60	40	14.0	HQD 400/4	01124	HWD 400/4	01025	HRFD 400/4	00229	—
Two-speed, three-phase current, 400 V, 50 Hz, γ/Δ connection, protection category IP55															
1325/1085	3170/3920	135/205	0.25/0.45	0.45	520	60	40	20.0	HQD 400/4/4	01465	—	—	HRFD 400/4/4	01466	—
2890/2600	7890/8400	1300/2310*	3.00/5.60*	4.70	520	60	40	25.0	HQD 400/2/2	01475	—	—	HRFD 400/2/2	01474	120
Pole-changeable, 2 speeds, three-phase current, Dahlander winding, 400 Volt, 50 Hz, protection category IP55															
690/1390	2010/4100	70/250	0.25/0.60	—	472	60	—	13.0	HQD 400/8/4	01137	—	—	HRFD 400/8/4	00399	10
1480/2940	4180/8540	300/2310*	1.00/5.20*	—	472	40	—	24.0	HQD 400/4/2	01139	—	—	HRFD 400/4/2	00401	120
Ex Explosion-proof, II 2G Ex h IIB + H₂ T3 Gb, Motor Ex e, three-phase current 400 Volt, 50 Hz, protection category IP55															
920	2870	250*	0.97*	—	470	40	—	13.0	HQD 400/6 Ex	01109	—	—	—	—	—
1370	4380	370*	1.08*	—	470	40	—	16.0	HQD 400/4 Ex	01153	—	—	HRFD 400/4 Ex	00479	—

* Motor ratings, Ex see information on page 16. ¹⁾ Type HRFW: Connection according to wiring diagram no. 965 ²⁾ Incl. motor protection circuit breaker. ³⁾ Incl. speed pole changing switch.

Performance curves 400/2

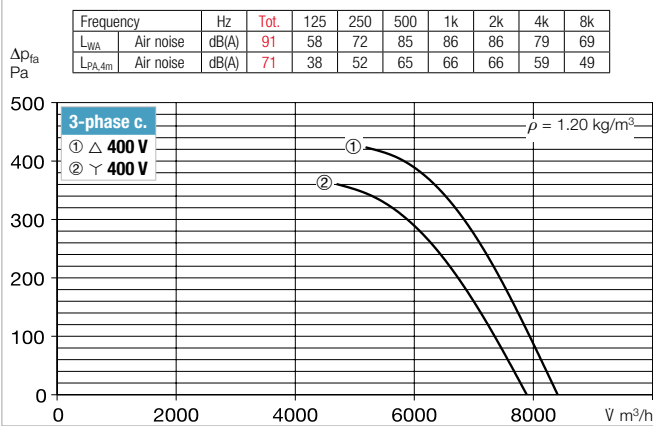

Performance curves 400/4

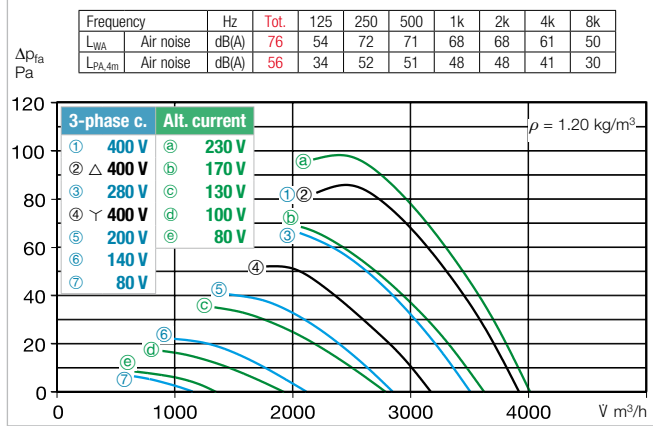

Performance curves 400/6

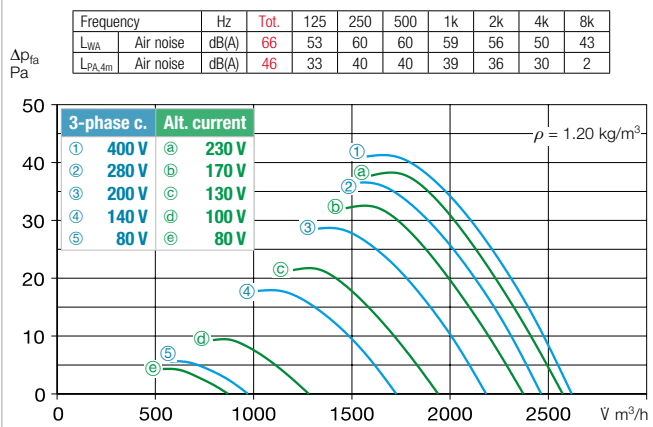

Performance curve 400/8

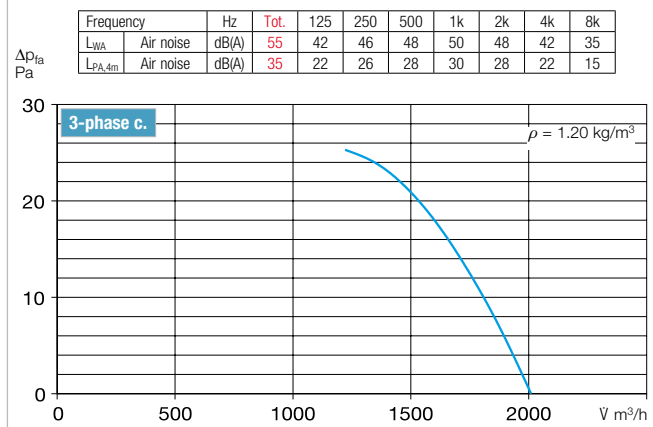

Accessories for HRF 400 Description see page 268 ff.

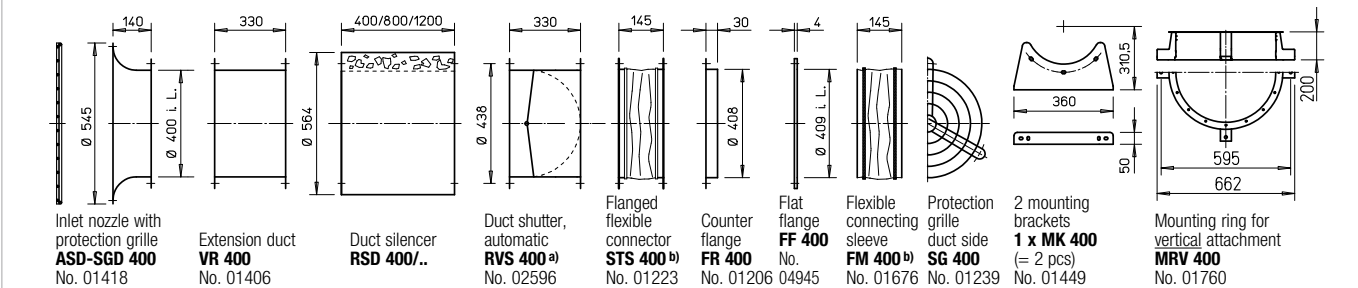

^{a)} Shutter, motorised see Accessories product pages.

^{b)} See below for types for explosion-proof fans.

Frequency inverter with integrated sine filter		Transformer speed controller 5-step, pole changing switch		Electronic speed controller, continuously variable flush-m./surface-m.		Motor protection circuit breaker for connecting built-in thermal contacts		Reverser switch	
Type	Ref. no.	Type	Ref. no.	Type	Ref. no.	Type	Ref. no.	Type	Ref. no.
—	—	MWS 1.5 ²⁾	01947	ESU 1/ESA 1	00236/00238	MW	01579	WS	01271
—	—	MWS 1.5 ²⁾	01947	ESU 1/ESA 1	00236/00238	MW	01579	WS	01271
FU-BS 2.5 ²⁾	05459	RDS 1 ²⁾	01314	—	—	MD	05849	WS	01271
FU-BS 2.5 ²⁾	05459	RDS 1 ²⁾	01314	—	—	MD	05849	WS	01271
Speed changeover switch									
FU-BS 2.5 ²⁾	05459	RDS 1 ²⁾	01314	—	—	M 4 ³⁾ /MD	01571/05849	WS	01271
FU-BS 5 ²⁾	05460	DS 2	01351	ESD 5 ²⁾	00501	M 4 ³⁾ /MD	01571/05849	WS	01271
Pole changing switch									
—	—	PDA 12 ⁴⁾	05081	—	—	M 3 ³⁾	01293	PWDA	01282
—	—	PDA 12 ⁴⁾	05081	—	—	M 3 ³⁾	01293	PWDA	01282
—	—	not permitted	—	not permitted	—	—	—	—	—
—	—	not permitted	—	not permitted	—	—	—	—	—

⁴⁾ Flush-m. version see Switch product page.

Other accessories Page

- ^{b)} Access. for expl.-proof fans
- Flanged flexible connector STS 400 Ex Ref. no. 02505
- Flexible connecting sleeve FM 400 Ex Ref. no. 01692
- Extension sleeve for HS VH 400 Ref. no. 01346
- Cylindrical pipe section, galvanised steel, 15 cm long.
- Filter and silencers 473 ff.
- Shutters and ventilation grilles 553 ff.
- Speed controllers, controllers and switches 591 ff.

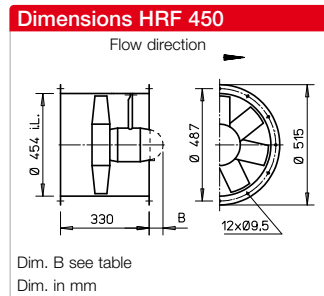
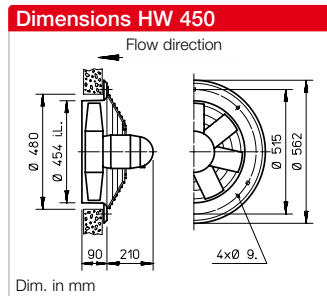
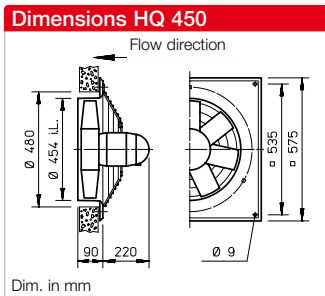

Description for all types

- Casing**
 Made of galvanised steel sheet, types HQ and HW have additional two layer lacquer coating in papyrus white. Explosion-proof types have no lacquer coating
- Impeller**
 High performance characteristics with profiled blades made of plastic, dynamically balanced. Different for explosion-proof types.
- Drive**
 Closed die-cast aluminium casing. Prot. cat. IP55. Ball bearing mounted. Maintenance-free and radio interference-free. Winding with moisture proof coating. See type table for max. air flow temperature. Different for explosion-proof types.

- Motor protection**
 All types (except for explosion-proof, see page 172) are equipped with thermal contacts. These should be wired with the motor protection circuit breaker (see type table) for effective motor protection.
- Electrical connection**
 Standard terminal box (IP55) on back of motor. Additionally on outside of duct for HRF types. Different for explosion-proof types.
- Protection grille**
 Made of powder-coated steel for HQ and HW (HQ Ex galvanised). In accordance with DIN EN ISO 13857.

- Power control**
 The voltage-controllable types are identified in the "Current consumption max. with control" column with a value which must be observed when determining the controller (see speed controller column). Possible assignments of frequency inverters to fans are shown in the type table. The planned use of a frequency inverter without a sine filter should be indicated when placing the order. This requires a change of fan version and additional costs, if necessary. The flow rates are shown in the performance diagram.
- Reverse operation**
 All types are reversible using a reverser switch. Performance reduction of approx. 1/3 in abnormal flow direction.

- Installation**
 Installation possible in any position, but be aware of any condensate drain holes depending on usage.
- Dimensions**
 Pole-changeable and explosion-proof types may differ from the above information.
- Noise levels**
 See performance diagram. The sound power and sound pressure at 4 m distance under free field conditions are specified for the average operating point on the inlet/outlet side. See page 10 f for noise emissions and room acoustics. Different for explosion-proof types.

Speed min ⁻¹	Flow rate free-blowing V m ³ /h	Power consump. W	Current consump.		Wiring diagram No.	Max. air flow temp.		Weight net aprx. kg	Design type															
			at rated voltage A	max. with control A		at rated voltage + °C	with control + °C		HQ incl. protection grille	Ref. no.	HW incl. protection grille	Ref. no.	HRF	Ref. no.	Dim. B Motor protrusion in mm									
Single-phase alternating current, 230 Volt, 50 Hz, Capacitor motor, protection category IP55																								
915	3890	136	0.63	0.63	475 ¹⁾	60	40	19.0	HQW 450/6	00991	—	—	HRFW 450/6 ¹⁾	00208	—									
1380	5770	405	1.76	2.02	475 ¹⁾	60	40	18.0	HQW 450/4	00992	HWW 450/4	01010	HRFW 450/4 ¹⁾	00209	—									
Three-phase current, 400 Volt, 50 Hz, Squirrel-cage rotor, protection category IP55																								
960	3920	137	0.38	0.42	469	60	40	18.0	HQD 450/6	00993	—	—	HRFD 450/6	00230	—									
1390	5810	384	0.81	0.92	469	50	40	17.0	HQD 450/4	00994	HWD 450/4	01028	HRFD 450/4	00231	—									
Two-speed, three-phase current, 400 V, 50 Hz, ∇/Δ connection, protection category IP55																								
1130/1390	5090/5780	280/378	0.51/0.82	—	520	60	—	22.0	HQD 450/4/4	01467	—	—	HRFD 450/4/4	01468	—									
2775/2200	10190/9335	1300/2310*	5.40/3.0*	5.10	520	40	40	32.0	—	—	—	—	HRFD 450/2/2	00484	150									
Pole-changeable, 2 speeds, three-phase current, Dahlander winding, 400 Volt, 50 Hz, protection category IP55																								
480/970	1930/3950	62/163	0.22/0.47	—	472	60	—	18.0	HQD 450/12/6	00995	—	—	—	—	—									
705/1410	2860/5810	91/404	0.36/0.92	—	472	50	—	20.0	HQD 450/8/4	00996	—	—	HRFD 450/8/4	00403	—									
Ex Ex Explosion-proof, II 2G Ex h IIB + H₂ T3 Gb, Motor Ex e, three-phase current 400 Volt, 50 Hz, protection category IP55																								
920	4090	250*	0.97*	—	470	40	—	15.5	HQD 450/6 Ex	01473	—	—	—	—	—									
1370	6240	370*	1.08*	—	470	40	—	15.5	HQD 450/4 Ex	01154	—	—	HRFD 450/4 Ex	00481	—									

* Motor ratings, Ex see information on page 16. ¹⁾ Type HRFW: Connection according to wiring diagram no. 965. ²⁾ Incl. motor protection circuit breaker. ³⁾ Flush-m. version see Switch product page.

Performance curves 450/2

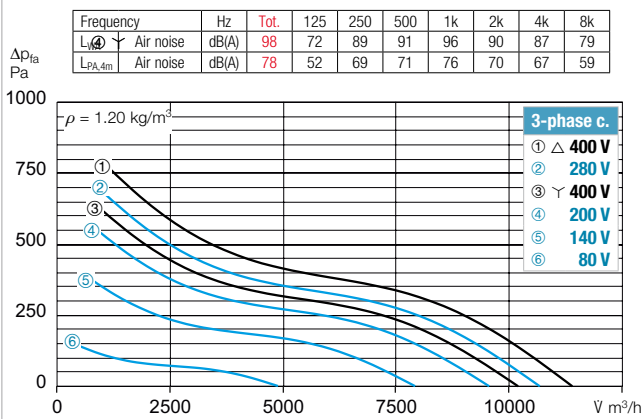

Performance curves 450/4

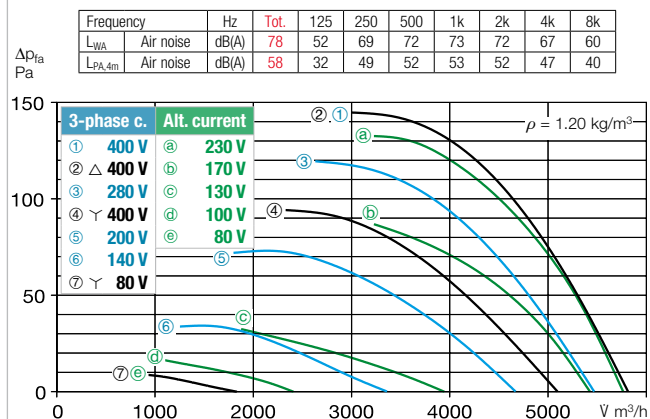

Performance curves 450/6

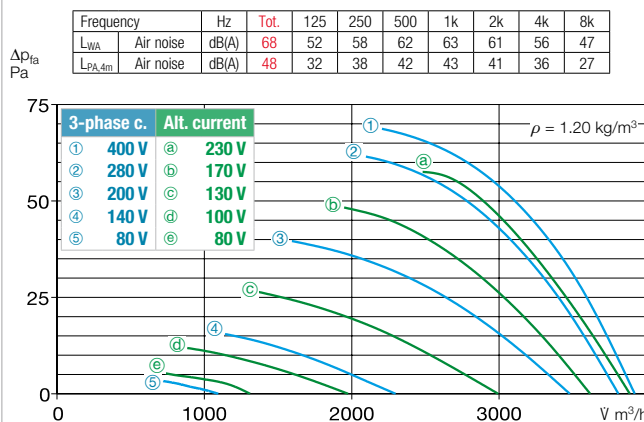

Performance curves 450/8

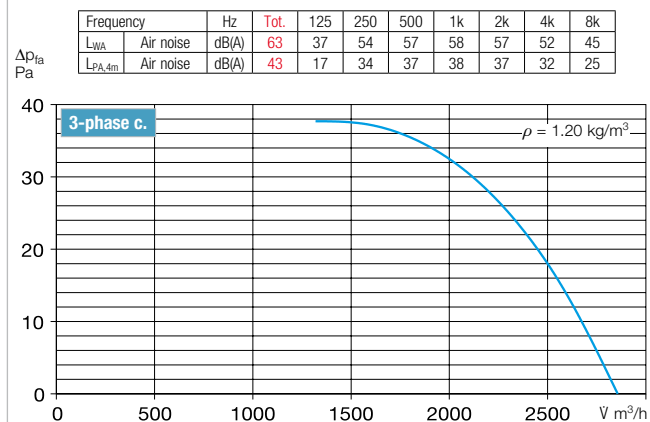

Accessories for HRF 450 Description see page 268 ff.

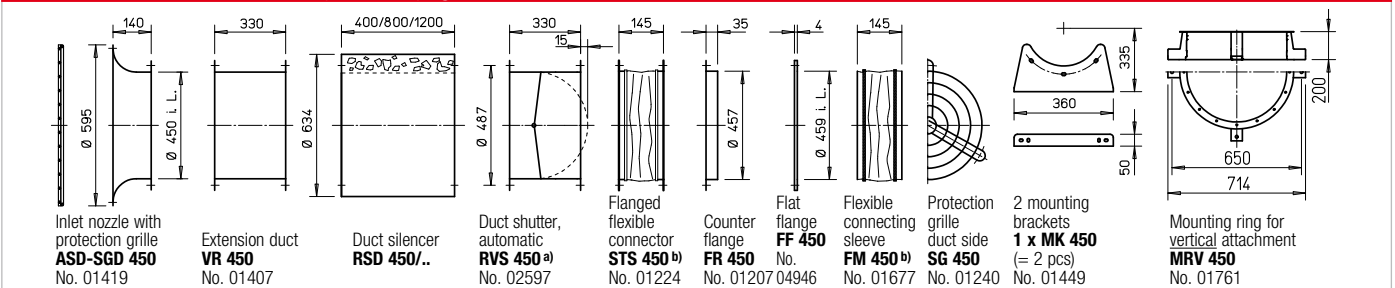

^{a)} Shutter, motorised see Accessories product pages.

^{b)} See below for types for explosion-proof fans.

Frequency inverter with integrated sine filter		Transformer speed controller 5-step, pole changing switch		Electronic speed controller, continuously variable flush-m./surface-m.		Motor protection circuit breaker for connecting built-in thermal contacts		Reverser switch	
Type	Ref. no.	Type	Ref. no.	Type	Ref. no.	Type	Ref. no.	Type	Ref. no.
—	—	MWS 1.5 ²⁾	01947	ESU 3/ESA 3	00237/00239	MW	01579	WS	01271
—	—	MWS 3 ²⁾	01948	ESU 3/ESA 3	00237/00239	MW	01579	WS	01271
FU-BS 2.5 ²⁾	05459	RDS 1 ²⁾	01314	—	—	MD	05849	WS	01271
FU-BS 2.5 ²⁾	05459	RDS 2 ²⁾	01315	EDS 5 ²⁾	00501	MD	05849	WS	01271
Speed changeover switch									
FU-BS 2.5 ²⁾	05459	DS 2 ⁵⁾	01351	—	—	M 4 ³⁾ /MD	01571/05849	WS	01271
FU-BS 8.0 ²⁾	05461	RDS 7 ²⁾	01578	ESD 11.5 ²⁾	00502	M 4 ³⁾ /MD	01571/05849	WS	01271
Pole changing switch									
—	—	PDA 12 ³⁾	05081	—	—	M 3 ⁴⁾	01293	PWDA	01282
—	—	PDA 12 ³⁾	05081	—	—	M 3 ⁴⁾	01293	PWDA	01282
—	—	not permitted	—	not permitted	—	—	—	—	—
—	—	not permitted	—	not permitted	—	—	—	—	—

⁴⁾ Incl. speed pole changing switch.

⁵⁾ Speed changeover switch.

Other accessories Page

^{b)} Access. for expl.-proof fans	
Flanged flexible connector STS 450 Ex	Ref. no. 02506
Flexible connecting sleeve FM 450 Ex	Ref. no. 01693
Filter and silencers	473 ff.
Shutters and ventilation grilles	553 ff.
Speed controllers, controllers and switches	591 ff.

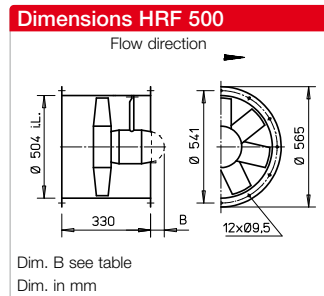
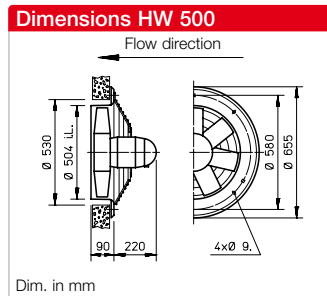
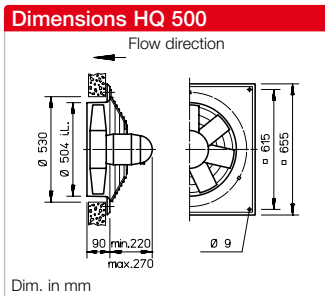

Description for all types

Casing

Made of galvanised steel sheet, types HQ and HW have additional two layer lacquer coating in papyrus white. Explosion-proof types have no lacquer coating

Impeller

High performance characteristics with profiled blades made of plastic, dynamically balanced. Different for explosion-proof types.

Drive

Closed die-cast aluminium casing. Prot. cat. IP55. Ball bearing mounted. Maintenance-free and radio interference-free. Winding with moisture proof coating. See type table for max. air flow temperature. Different for explosion-proof types.

Motor protection

All types (except for explosion-proof, see page 172) are equipped with thermal contacts. These should be wired with the motor protection circuit breaker (see type table) for effective motor protection.

Electrical connection

Standard terminal box (IP55) on back of motor. Additionally on outside of duct for HRF types. Different for explosion-proof types.

Protection grille

Made of powder-coated steel for HQ and HW (HQ Ex galvanised). In accordance with DIN EN ISO 13857.

Power control

The voltage-controllable types are identified in the "Current consumption max. with control"

column with a value which must be observed when determining the controller (see speed controller column). Possible assignments of frequency inverters to fans are shown in the type table. The planned use of a frequency inverter without a sine filter should be indicated when placing the order. This requires a change of fan version and additional costs, if necessary. The flow rates are shown in the performance diagram.

Reverse operation

All types are reversible using a reverser switch. Performance reduction of approx. 1/3 in abnormal flow direction.

Installation

Installation possible in any position, but be aware of any condensate drain holes depending on usage.

Dimensions

Pole-changeable and explosion-proof types may differ from the above information.

Noise levels

See performance diagram. The sound power and sound pressure at 4 m distance under free field conditions are specified for the average operating point on the inlet/outlet side. See page 10 f for noise emissions and room acoustics.

Different for expl.-proof types.

Reference Page

Techn. description	172
Selection table	173
Planning information	10 ff.

Special design

Different voltage, protection category, air flow direction, higher air flow temperature, acid protection and impeller made of cast aluminium upon request.

Speed min ⁻¹	Flow rate free-blowing V m ³ /h	Power consump. W	Current consump.		Wiring diagram No.	Max. air flow temp.		Weight net aprx. kg	Design type								
			at rated voltage A	max. with control A		at rated voltage + °C	with control + °C		HQ incl. protection grille	Ref. no.	HW incl. protection grille	Ref. no.	HRF	Ref. no.	Dim. B Motor protrusion in mm		
Single-phase alternating current, 230 Volt, 50 Hz, Capacitor motor, protection category IP55																	
935	5500	233	1.05	1.25	475 ¹⁾	60	40	19.0	HQW 500/6	01112	—	—	HRFW 500/6 ¹⁾	00210	—		
1375	8320	1100*	5.90*	4.94	475 ¹⁾	40	40	25.0	HQW 500/4	01113	—	—	HRFW 500/4 ¹⁾	00211	60		
Three-phase current, 400 Volt, 50 Hz, Squirrel-cage rotor, protection category IP55																	
920	5480	218	0.48	0.55	469	60	40	19.0	HQD 500/6	01126	—	—	HRFD 500/6	00232	—		
1345	8200	620	1.22	1.32	469	40	40	19.5	HQD 500/4	01127	HWD 500/4	01030	HRFD 500/4	00233	—		
Two-speed, three-phase current, 400 V, 50 Hz, Y/Δ connection, protection category IP55																	
615/920	4330/5450	133/214	0.29/0.46	—	520	60	—	18.0	HQD 500/6/6	01471	—	—	—	—	—		
1030/1350	6720/8150	416/617	0.76/1.19	—	520	60	—	24.0	HQD 500/4/4	01469	—	—	HRFD 500/4/4	01470	120		
2450/2830	13615/12050	1960/2470*	3.14/4.73*	—	520	40	—	30.0	—	—	—	—	HRFD 500/2/2	00485	150		
Pole-changeable, 2 speeds, three-phase current, Dahlander winding, 400 Volt, 50 Hz, protection category IP55																	
465/940	2680/5490	71/248	0.23/0.56	—	472	60	—	18.0	HQD 500/12/6	01140	—	—	—	—	—		
700/1385	3890/8280	137/688	0.52/1.48	—	472	40	—	22.0	HQD 500/8/4	01142	—	—	HRFD 500/8/4	00407	—		
Ex Ex Explosion-proof, II 2G Ex h IIB + H₂ T3 Gb, Motor Ex e, three-phase current 400 Volt, 50 Hz, protection category IP55																	
920	5610	250*	0.97*	—	470	40	—	18.0	HQD 500/6 Ex	01050	—	—	HRFD 500/6 Ex	00489	10		
1390	8560	750*	2.00*	—	470	40	—	18.0	HQD 500/4 Ex	01157	—	—	HRFD 500/4 Ex	00483	45		

* Motor ratings, Ex see information on page 16. ¹⁾ Type HRFW: Connection according to wiring diagram no. 965. ²⁾ Incl. motor protection circuit breaker. ³⁾ Incl. speed pole changing switch.

Performance curves 500/2

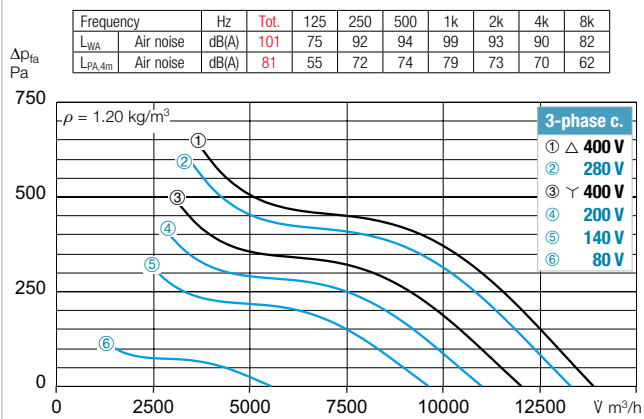

Performance curves 500/4

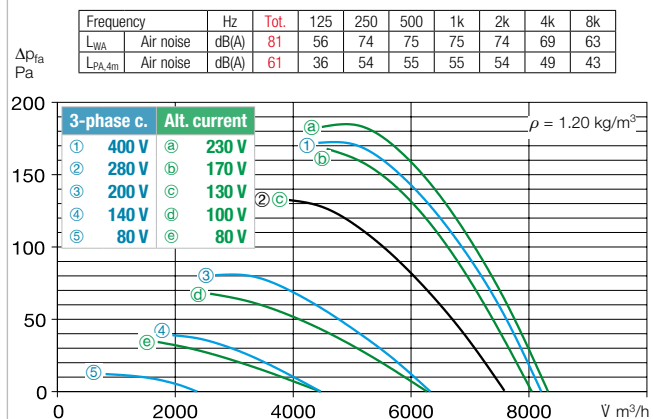

Performance curves 500/6

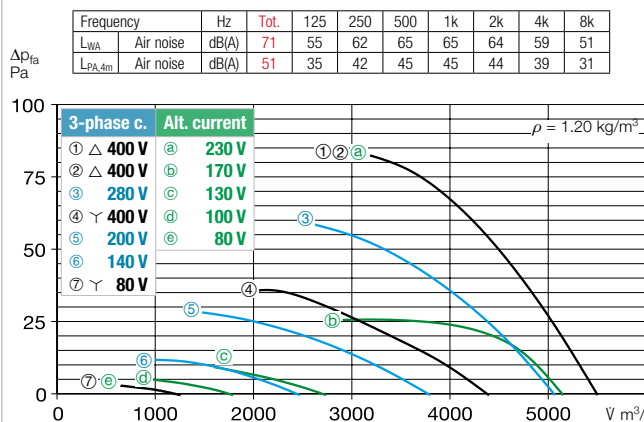

Performance curve 500/8

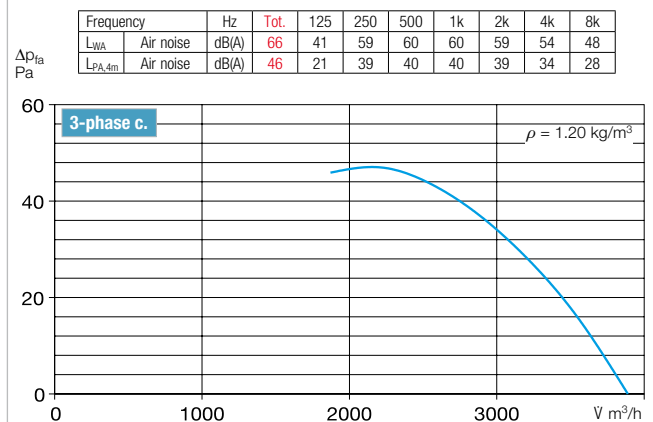

Accessories for HRF 500 Description see page 268 ff.

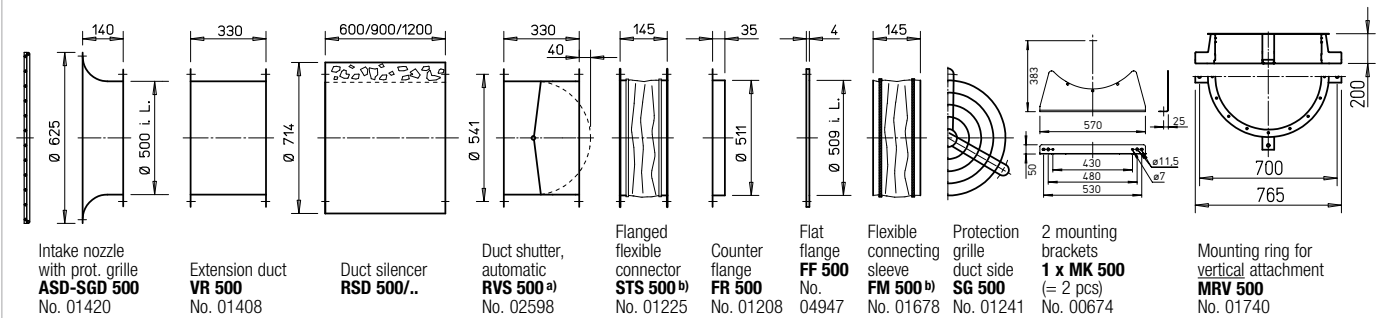

^{a)} Shutter, motorised see Accessories product pages.

^{b)} See below for types for explosion-proof fans.

Frequency inverter with integrated sine filter	Transformer speed controller 5-step, pole changing switch	Electronic speed controller, continuously variable flush-m./surface-m.	Motor protection circuit breaker for connecting built-in thermal contacts	Reverser switch					
Type	Ref. no.	Type	Ref. no.	Type	Ref. no.				
—	MWS 1.5 ²⁾	01947	ESU 3/ESA 3	00237/00239	MW	01579	WS	01271	
—	MWS 5 ²⁾	01949	ESU 5/ESA 5	01296/01299	MW	01579	WS	01271	
FU-BS 2.5 ²⁾	05459	RDS 1 ²⁾	01314	EDS 5 ²⁾	00501	MD	05849	WS	01271
FU-BS 2.5 ²⁾	05459	RDS 2 ²⁾	01315	EDS 5 ²⁾	00501	MD	05849	WS	01271
Speed changeover switch									
FU-BS 2.5 ²⁾	05459	DS 2 ⁵⁾	01351	—	—	M 4 ⁴⁾ /MD	01571/05849	WS	01271
FU-BS 2.5 ²⁾	05459	DS 2 ⁵⁾	01351	ESD 5 ²⁾	00501	M 4 ⁴⁾ /MD	01571/05849	WS	01271
FU-BS 5.0 ²⁾	05460	RDS 7 ²⁾	01578	ESD 11.5 ²⁾	00502	M 4 ⁴⁾ /MD	01571/05849	WS	01271
Pole changing switch									
—	PDA 12 ⁴⁾	05081	—	—	—	M 3 ³⁾	01293	PWDA	01282
—	PDA 12 ⁴⁾	05081	—	—	—	M 3 ³⁾	01293	PWDA	01282
—	not permitted	—	not permitted	—	—	—	—	—	—
—	not permitted	—	not permitted	—	—	—	—	—	—

⁴⁾ Flush-m. version see Switch product page. ⁵⁾ Speed changeover switch.

Other accessories Page

- ^{b)} Access. for expl.-proof fans
- Flanged flexible connector**
STS 500 Ex Ref. no. 02507
- Flexible connecting sleeve**
FM 500 Ex Ref. no. 01694
- Extension sleeve for HS**
VH 500 Ref. no. 01348
- Cylindrical pipe section, galvanised steel, 15 cm long.
- Filter and silencers 473 ff.
- Shutters and ventilation grilles 553 ff.
- Speed controllers, controllers and switches 591 ff.

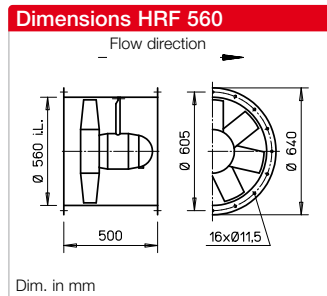
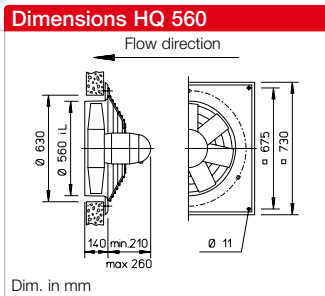

Description for all types

- **Casing**
 Made of galvanised steel sheet. Type HQ has additional two layer lacquer coating in papyrus white. Explosion-proof types have no lacquer coating.
- **Impeller**
 High performance characteristics with profiled blades made of plastic, dynamically balanced. Different for explosion-proof types.
- **Drive**
 Closed die-cast aluminium casing. Protection category IP55. Ball bearing mounted. Maintenance-free and radio interference-free. Winding with moisture proof coating. See type table for max. air flow temperature. Different for explosion-proof types.

- **Motor protection**
 All types (except for explosion-proof, see page 172) are equipped with thermal contacts. These should be wired with the motor protection circuit breaker (see type table) for effective motor protection.
- **Electrical connection**
 Standard terminal box (IP55) on back of motor. Additionally on outside of duct for HRF types. Different for explosion-proof types.
- **Protection grille**
 Made of powder-coated steel wire for HQ (Ex types galvanised). In accordance with DIN EN ISO 13857.

- **Power control**
 The voltage-controllable types are identified in the "Current consumption max. with control" column with a value which must be observed when determining the controller (see speed controller column). Possible assignments of frequency inverters to fans are shown in the type table. The planned use of a frequency inverter without a sine filter should be indicated when placing the order. This requires a change of fan version and additional costs, if necessary. The flow rates are shown in the performance diagram.
- **Reverse operation**
 All types are reversible using a reverser switch. Performance reduction of approx. 1/3 in abnormal flow direction.

- **Installation**
 Installation possible in any position, but be aware of any condensate drain holes depending on usage.
- **Dimensions**
 Pole-changeable and explosion-proof types may differ from the above information.
- **Noise levels**
 See performance diagram. The sound power and sound pressure at 4 m distance under free field conditions are specified for the average operating point on the inlet/outlet side. See page 10 f for noise emissions and room acoustics. Different for explosion-proof types.

Speed min ⁻¹	Flow rate free-blowing V m ³ /h	Power consp. W	Current consump.		Wiring dia- gram No.	Max. air flow temp.		Weight net aprx. kg	Design type				Frequency inverter with integrated sine filter		Transformer speed cont- roller 5-step, pole chan- ging switch, speed ch., pole changing switch		
			at rated voltage A	max. with control A		at rated voltage + °C	with control + °C		HQ incl. prot. grille Ref. no.	HRF Ref. no.	Type	Ref. no.	Type	Ref. no.			
Single-phase alternating current, 230 Volt, 50 Hz, Capacitor motor, protection category IP55																	
935	8130	0.27	1.40	2.00	475 ¹⁾	60	40	24.0	HQW 560/6	00385	HRFW 560/6¹⁾	00380	—	—	MWS 3²⁾	01948	
1370	12180	0.89	4.15	5.00	965	60	40	31.0	HQW 560/4	05054	HRFW 560/4	05055	—	—	MWS 7.5²⁾	01950	
Three-phase current, 400 Volt, 50 Hz, Squirrel-cage rotor, protection category IP55																	
965	8180	0.28	0.79	1.00	469	60	40	26.0	HQD 560/6	00386	HRFD 560/6	00381	FU-BS 2.5²⁾	05459	RDS 2²⁾	01315	
1365	12250	0.88	1.71	1.80	469	40	40	29.0	HQD 560/4	00387	HRFD 560/4	00382	FU-BS 2.5²⁾	05459	RDS 2²⁾	01315	
Pole-changeable, 2 speeds, three-phase current, Dahlander winding, 400 Volt, 50 Hz, protection category IP55																	
470/955	4000/8130	0.089/0.298	0.55/0.74	—	472	60	—	24.0	HQD 560/12/6	00389	HRFD 560/12/6	00384	—	—	PDA 12²⁾	05081	
720/1365	6400/12130	0.20/0.92	0.80/1.77	—	472	40	—	26.0	HQD 560/8/4	00388	HRFD 560/8/4	00383	—	—	PDA 12²⁾	05081	
Ex Explosion-proof, II 2G Ex h IIB + H₂ T3 Gb, Motor Ex e, three-phase current 400 Volt, 50 Hz, protection category IP55																	
920	8090	0.25*	0.97*	—	470	40	—	23.0	HQD 560/6 Ex	00378	HRFD 560/6 Ex	00376	—	—	Not permitted		
1390	12890	0.75*	2.00*	—	470	40	—	24.0	HQD 560/4 Ex	00379	HRFD 560/4 Ex	00377	—	—	Not permitted		

* For Ex types: Motor ratings see information on page 16. ¹⁾ Type HRFW: Connection according to wiring diagram no. 965. ²⁾ Incl. motor protection circuit breaker. ³⁾ Flush-m. version see Switch product page.

Performance curves 560/4

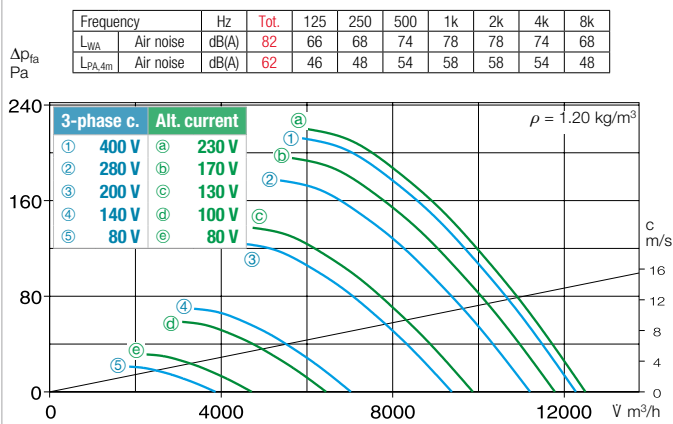

Performance curves 560/6

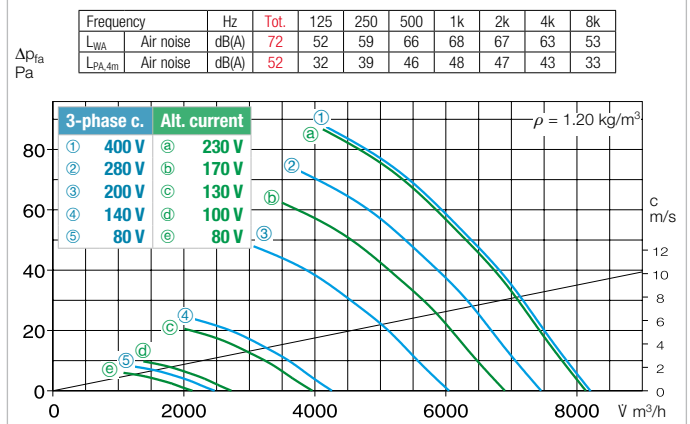

Performance curve 560/8

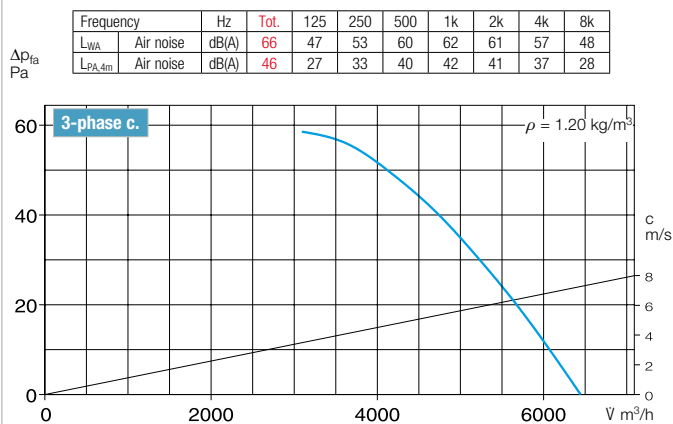

Performance curve 560/12

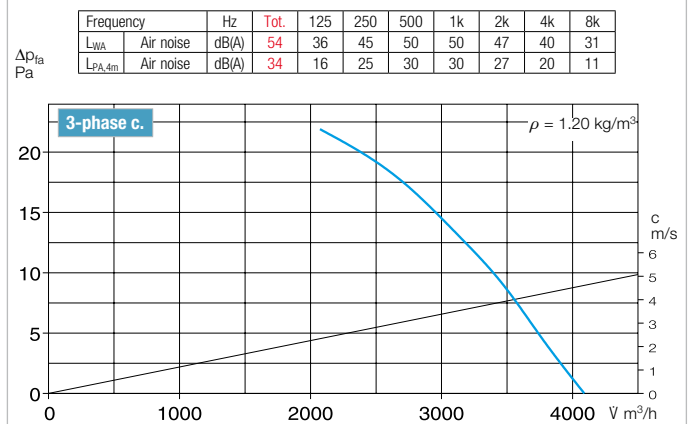

Accessories for HRF 560 Description see page 268 ff.

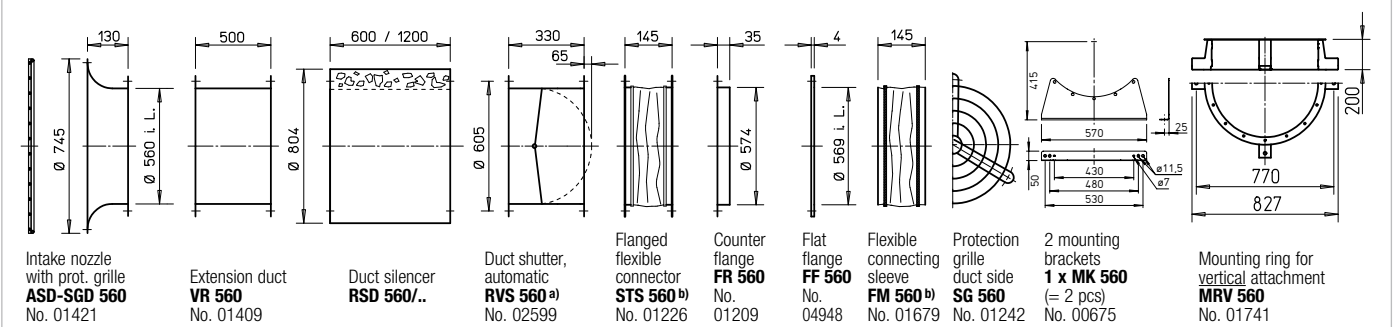

a) Shutter, motorised see Accessories product pages.

b) See below for types for explosion-proof fans.

Type	Ref. no.	Type	Ref. no.	Type	Ref. no.
Electronic speed controller, continuously variable flush-m./surface-m.		Motor protection circuit breaker for connecting built-in thermal contacts		Reverser switch	
ESU 3/ESA 3	00237/00239	MW	01579	WS	01271
ESU 5/ESA 5	01296/01299	MW	01579	WS	01271
EDS 5 a)	00501	MD	05849	WS	01271
EDS 5 a)	00501	MD	05849	WS	01271
—	—	M 3 a)	01293	PWDA	01282
—	—	M 3 a)	01293	PWDA	01282
not permitted	—	—	—	—	—
not permitted	—	—	—	—	—

a) Incl. speed pole changing switch.

Reference	Page
Techn. description	172
Selection table	173
Planning information	10 ff.
Special design	
Different voltage, protection category, air flow direction, higher air flow temperature, acid protection and impeller made of cast aluminium upon request.	
The technical information on p. 15 ff. must be observed.	

Other accessories	Page
b) Access. for expl.-proof fans	
Flanged flexible connector STS 560 Ex	Ref. no. 02508
Silencers	486 ff.
Shutters and ventilation grilles	553 ff.
Speed controllers, controllers and switches	591 ff.
Flexible connecting sleeve FM 560 Ex	Ref. no. 01695

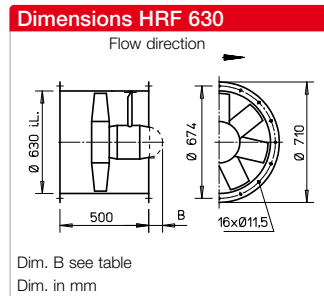
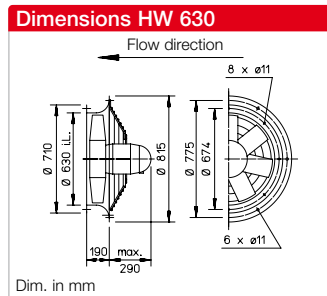
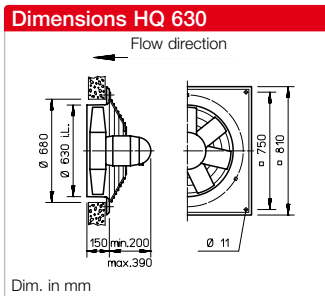

Description for all types

■ **Casing**
 Made of galvanised steel sheet.

■ **Impeller**
 High performance characteristics with profiled blades made of plastic, dynamically balanced. Different for explosion-proof types.

■ **Drive**
 Closed die-cast aluminium casing. Protection category IP55. Ball bearing mounted. Maintenance-free and radio interference-free. Winding with moisture proof coating. See type table for max. air flow temperature. Different for explosion-proof types.

■ **Motor protection**
 All types (except for ..8/4 and explosion-proof types, see page 172) are equipped with thermal contacts. These should be wired with the motor protection circuit breaker (see type table) for

effective motor protection. Motors without thermal contacts must be protected by means of on-site a motor protection circuit breaker.

■ **Electrical connection**
 Standard terminal box (IP55) on back of motor. Additionally on outside of duct for HRF types. Different for explosion-proof types.

■ **Protection grille**
 Made of powder-coated steel for HQ and HW (HQ.. Ex galvanised). In accordance with DIN EN ISO 13857.

■ **Power control**
 The voltage-controllable types are identified in the "Current consumption max. with control" column with a value which must be observed when determining the controller (see speed controller column). Possible assignments of frequency inverters to fans are shown in the type

table. The planned use of a frequency inverter without a sine filter should be indicated when placing the order. This requires a change of fan version and additional costs, if necessary. The flow rates are shown in the performance diagram.

■ **Reverse operation**
 All types are reversible using a reverser switch. Performance reduction of approx. 1/3 in abnormal flow direction.

■ **Installation**
 Installation possible in any position, but be aware of any condensate drain holes depending on usage.

■ **Dimensions**
 Pole-changeable and explosion-proof types may differ from the above information.

■ **Noise levels**
 See performance diagram. The sound power and sound pressure at 4 m distance under free field conditions are specified for the average operating point on the inlet/outlet side. See page 10 f for noise emissions and room acoustics. Different for explosion-proof types.

Reference	Page
Techn. description	172
Selection table	173
Planning information	10 ff.
Special design	
Different voltage, protection category, air flow direction, higher air flow temperature, acid protection and impeller in other materials upon request.	
The technical information on p. 15 ff. must be observed.	

Speed	Flow rate free-blowing	Power consump.	Current consump.		Wiring diagram	Max. air flow temp.		Weight net appr.	Design type						
			at rated voltage	max. with control		at rated voltage	with control		HQ incl. protection grille	Ref. no.	HW incl. protection grille	Ref. no.	HRF	Ref. no.	Dim. B Motor protrusion in mm
min ⁻¹	V m ³ /h	W	A	A	No.	+ °C	+ °C	kg							
Single-phase alternating current, 230 Volt, 50 Hz, Capacitor motor, protection category IP55															
950	10530	0.44	2.16	3.20	475	60	40	28.0	HQW 630/6	05037	—	—	—	—	—
1325	16210	1.50*	8.40*	7.00	964	40	—	40.0	HQW 630/4	05056	—	—	HRFW 630/4	05057	30
Three-phase current, 400 Volt, 50 Hz, Squirrel-cage rotor, protection category IP55															
710	7810	0.20	0.66	0.70	469	40	40	27.0	HQD 630/8	05029	—	—	—	—	—
960	10560	0.44	1.22	—	469	60	40	30.5	HQD 630/6	05027	HWD 630/6	01032	HRFD 630/6	00244	—
Two-speed, three-phase current, 400 V, 50 Hz, ∇/Δ connection, protection category IP55															
1170/1390	14310/17000	0.90/1.57	2.3/3.8	—	520	40	—	37.5	HQD 630/4/4	05030	HWD 630/4/4	01033	HRFD 630/4/4	00245	—
Pole-changeable, 2 speeds, three-phase current, Dahlander winding, 400 Volt, 50 Hz, protection category IP55															
440/935	5290/10470	0.14/0.43	0.60/1.13	—	472	60	—	41.0	HQD 630/12/6	05031	—	—	HRFD 630/12/6	00410	—
690/1400	7990/15990	0.37/1.50*	1.33/3.70*	—	471	40	—	40.5	HQD 630/8/4	05032	—	—	HRFD 630/8/4	00411	—
 Ex Explosion-proof, II 2G Ex h IIB + H₂ T3 Gb, Motor Ex e, three-phase current 400 Volt, 50 Hz, protection category IP55															
910	10480	0.55*	1.75*	—	470	40	—	30.0	HQD 630/6 Ex	05035	—	—	HRFD 630/6 Ex	00494	—
1410	17730	1.35*	3.10*	—	470	40	—	35.0	HQD 630/4 Ex	05036	—	—	HRFD 630/4 Ex	00495	—

* For Ex types: Motor ratings see information on page 16. ¹⁾ Incl. motor protection circuit breaker. ²⁾ Flush-m. version see Switch product page.

Performance curves 630/4

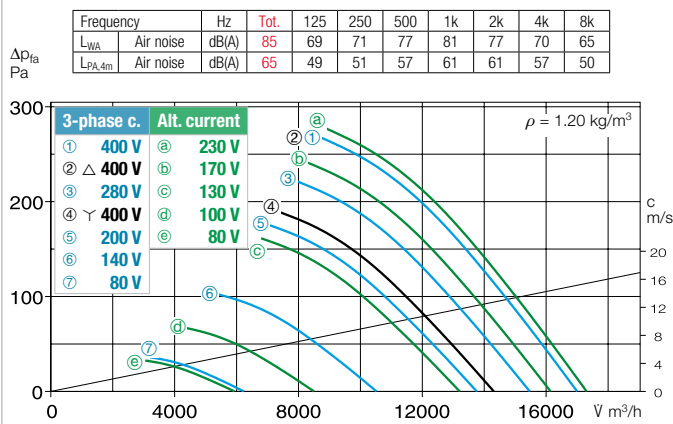

Performance curves 630/6

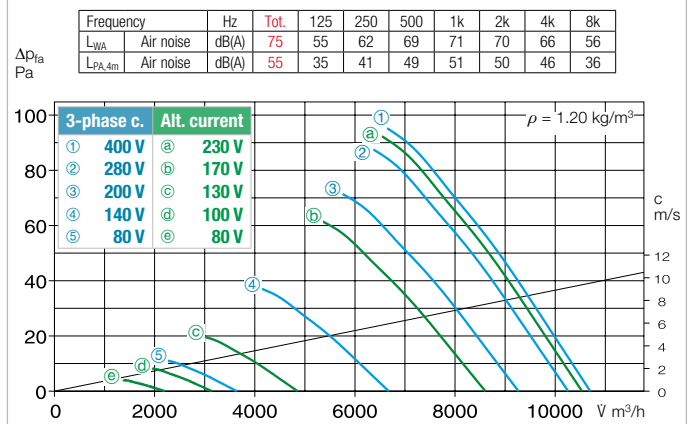

Performance curves 630/8

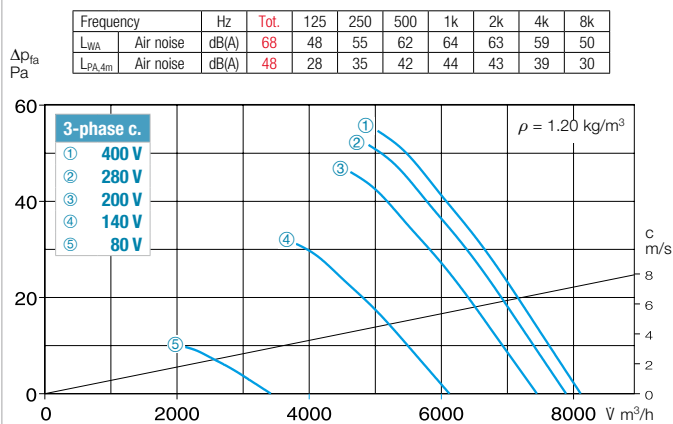

Performance curve 630/12

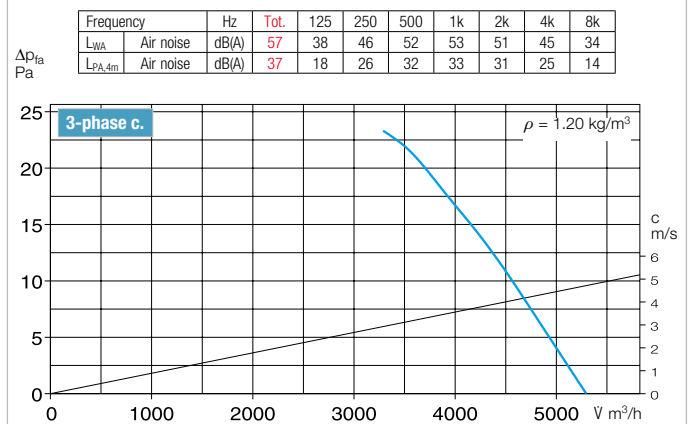

Accessories for HRF 630 Description see page 268 ff.

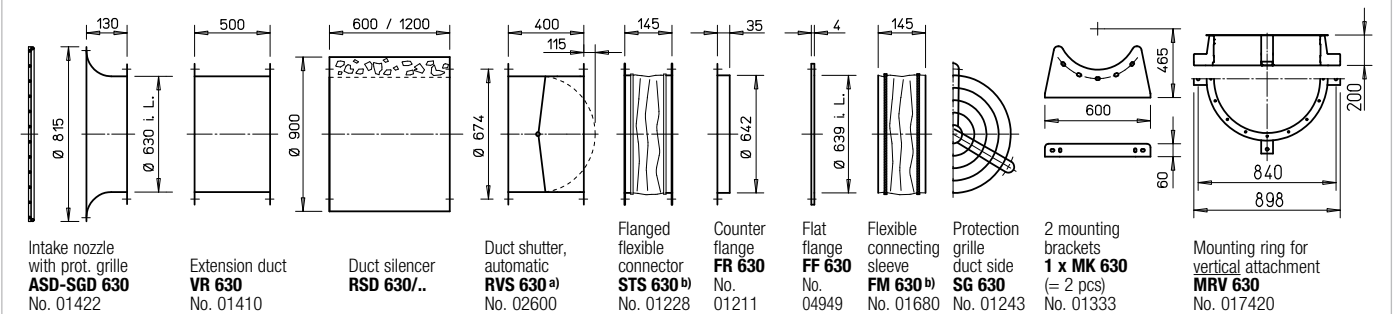

a) Shutter, motorised see Accessories product pages.

b) See below for types for explosion-proof fans.

Frequency inverter with integrated sine filter		Transformer speed controller 5-step, pole changing switch		Electronic speed controller, continuously variable flush-m./surface-m.		Motor protection circuit breaker for connecting built-in thermal contacts		Reverser switch	
Type	Ref. no.	Type	Ref. no.	Type	Ref. no.	Type	Ref. no.	Type	Ref. no.
—	—	MWS 3 ¹⁾	01948	ESU 5/ESA 5	01296/01299	MW	01579	WS	01271
—	—	MWS 7.5 ¹⁾	01950	—	—	MW	01579	WS	01271
FU-BS 2.5 ¹⁾	05459	RDS 2 ¹⁾	01315	EDS 5 ¹⁾	00501	MD	05849	WS	01271
FU-BS 2.5 ¹⁾	05459	RDS 2 ¹⁾	01315	EDS 5 ¹⁾	00501	MD	05849	WS	01271
FU-BS 5.0 ¹⁾	05460	RDS 4 ¹⁾	01316	EDS 5 ¹⁾	00501	M 4 ³⁾	01571	WS	01271
—	—	Pole changing switch		—	—	M 3 ³⁾	01293	PWDA	01282
—	—	PDA 12 ²⁾	05081	—	—	M 3 ³⁾	01293	PWDA	01282
—	—	PDA 12 ²⁾	05081	—	—	—	—	—	—
—	—	not permitted	—	not permitted	—	—	—	—	—
—	—	not permitted	—	not permitted	—	—	—	—	—

³⁾ Incl. speed pole changing switch.

Other accessories Page

^{b)} Access. for expl.-proof fans	
Flanged flexible connector STS 630 Ex	Ref. no. 02509
Silencers	486 ff.
Shutters and ventilation grilles	553 ff.
Speed controllers, controllers and switches	591 ff.
Flexible connecting sleeve FM 630 Ex	Ref. no. 01696

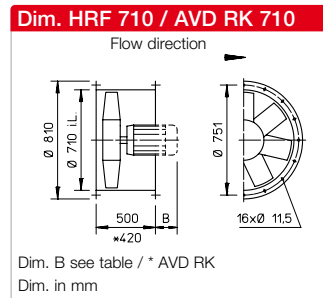
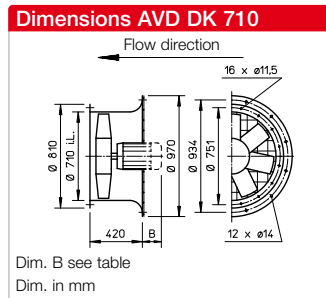
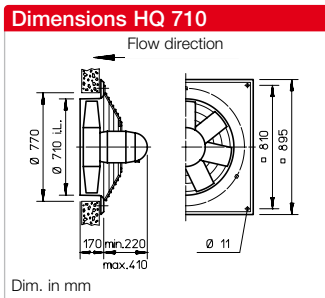

Description for all types

- Casing**
With motor mount made of galvanised steel sheet.
- Impeller**
High performance characteristics with profiled blades made of plastic, dynamically balanced. Different for explosion-proof types.
- Angle of attack**
The impeller blades can be adjusted for optimal operating point coverage (except for explosion-proof types and type HQW 710/6). The angle of attack is adjusted (according to the order) and fixed at the factory.

- The motor is assigned using the maximum power according to the information in the table below. The specified angle of attack must not be exceeded.
- Drive**
Closed design type IP55 or IP54. Maintenance-free and radio interference-free. Tropicalised winding with moisture proof coating. Different for explosion-proof types.
- Motor protection**
All types (except for pole-changeable and explosion-proof types, see page 172) are equipped with thermal contacts or PTC thermistors and must be protected by means of the following

- motor protection devices according to the footnotes the table:
¹MW/MD, Ref. no. 01579/05849
²MSA, Ref. no. 01289 (for PTC thermistor temperature sensor)
³M4, Ref. no. 01571
 All other types must be protected by means of on-site a motor protection circuit breaker.
- Protection grille**
Hot-dip galvanised or powder-coated for HQ and AVD DK as standard in accordance with DIN EN ISO 13857.
- Electrical connection**
Terminal box in protection category IP54 mounted on motor. Additionally on outside of duct

for HRF types. Different for explosion-proof types.

- Power control**
Partly through voltage reduction, see "Transformer speed controller" column. Regulated performance curve upon request.
Frequency inverter possible for all types (except for pole-changeable and explosion-proof types). The planned use of a frequency inverter without a sine filter should be indicated when placing the order. This requires a change of fan version and additional costs, if necessary.
- Reverse operation**
All types are reversible using a reverser switch. Performance reduction of approx. 1/3 in abnormal flow direction.

- Installation**
Installation possible in any position, but be aware of any condensate drain holes depending on usage.
- Dimensions**
Pole-changeable and explosion-proof types may differ from the above information. Motor lengths may vary. Take note of dim. B protrusion.
- Noise levels**
The sound power values over the frequency and as total levels are indicated above the performance diagrams. Different for explosion-proof types.

Speed min ⁻¹	Flow rate free blowing V m ³ /h	Rated motor power (output)* kW	Voltage V	Current consump. Rat. volt./ (control)* A	Max. position ° deg.	Wiring dia- gram No.	Max. air flow temp. + °C	Wgt net appr.** kg	Design type				Transformer speed controller 5-step, pole changing switch					
									HQ incl. protection grille	Ref. no.	AVD DK incl. protection grille	Ref. no. Dim. B Motor protr. in mm	HRFD AVD RK	Ref. no. Dim. B Motor protr. in mm	Type	Ref. no.		
Single-phase alternating current, 230 Volt, 50 Hz, Capacitor motor, protection category IP55																		
910	14200	0.60	230	2.6	25	965	40	40.0	HQW 710/6 ¹⁾	05047	—	—	—	MWS 5 ⁴⁾	01949			
Three-phase current, 400 Volt, 50 Hz, Squirrel-cage rotor, protection category IP45																		
690	13330	0.29	400	0.9	20	469	40	57.0	HQD 710/8 ¹⁾	05599	AVD DK 710/8 ¹⁾	05251	—	HRFD 710/8 ¹⁾	06930	RDS 2 ⁴⁾	01315	
940	15660/19170	1.1*	230/400	5.1*	35	776	40	60.0	HQD 710/6 ¹⁾	05603	AVD DK 710/6 ¹⁾	05255	145	HRFD 710/6 ¹⁾	06934	10	TSD 7	01504
1445	26420	3.00*	400/690	6.2*	30	776	40	88.0	HQD 710/4 ²⁾	05606	AVD DK 710/4 ²⁾	05258	175	HRFD 710/4 ²⁾	06937	35	—	—
Two-speed, three-phase current, 400 V, 50 Hz, protection category IP55																		
730/890	13550/16090	0.4/0.75*	400/400	1.1/2.3*	25	520	40	55.0	HQD 710/6/6 ³⁾	05602	AVD DK 710/6/6 ³⁾	05254	120	HRFD 710/6/6 ³⁾	06933	5	RDS 4 ⁴⁾	01316
1120/1360	16140/19670	0.95/1.55*	400/400	2.4/4.2*	20	520	40	60.0	HQD 710/4/4 ³⁾	05604	AVD DK 710/4/4 ³⁾	05256	145	HRFD 710/4/4 ³⁾	06935	—	RDS 7 ⁴⁾	01578
1030/1340	19370/23280	1.5/2.2*	400/400	3.0/5.2*	26	520	40	75.0	HQD 710/4/4 ³⁾	05605	AVD DK 710/4/4 ³⁾	05257	170	HRFD 710/4/4 ³⁾	06936	35	RDS 7 ⁴⁾	01578
Pole-changeable, 2 speeds, three-phase current, Dahlander winding, 400 Volt, 50 Hz, protection category IP45																		
685/1430	10810/22090	0.5/2.0*	400/400	2.0/4.7	23	471	40	82.0	HQD 710/8/4/..	05611	AVD DK 710/8/4/..	05263	160	HRFD 710/8/4/..	06942	20	PDA 12 ⁵⁾	05081
720/1440	14155/26200	0.9/3.6*	400/400	2.9/8.3	30	471	40	108.0	HQD 710/8/4/..	05612	AVD DK 710/8/4/..	05264	175	AVD RK 710/8/4/..	06943	90	PDA 12 ⁵⁾	05081
Explosion-proof, II 2G Ex h IIB + H₂ T3 Gb, Motor Ex e, three-phase current 400 Volt, 50 Hz, protection category IP55																		
700	13270	0.55*	400	2.2*	35	470	40	68.0	HQD 710/8 Ex	05618	AVD DK 710/8 Ex	05270	105	HRFD 710/8 Ex	06948	—	not permitted	—
930	13480	0.55*	400	1.8*	25	470	40	67.0	HQD 710/6 Ex	05620	AVD DK 710/6 Ex	05272	105	HRFD 710/6 Ex	06949	—	not permitted	—
930	16770	0.95*	400	2.7*	35	470	40	77.0	HQD 710/6 Ex	05621	AVD DK 710/6 Ex	05273	105	HRFD 710/6 Ex	06950	—	not permitted	—
1420	20540	2.00*	400	4.7*	25	470	40	82.0	HQD 710/4 Ex	05623	AVD DK 710/4 Ex	05275	130	AVD RK 710/4 Ex	06951	45	not permitted	—
1420	26160	3.60*	400/690	8.1*	35	498	40	102.0	HQD 710/4 Ex	05624	AVD DK 710/4 Ex	05276	190	AVD RK 710/4 Ex	06952	105	not permitted	—

* Motor ratings, Ex see information p. 16. ¹⁾ up to ³⁾ Motor protection devices, see description "Motor protection". ** Weights apply for type ..DK and ..RK, HRF and HQ minus approx. 15 kg. ⁴⁾ Incl. motor protection circuit breaker 1.2/2.2 kW.

Performance curves 710/4

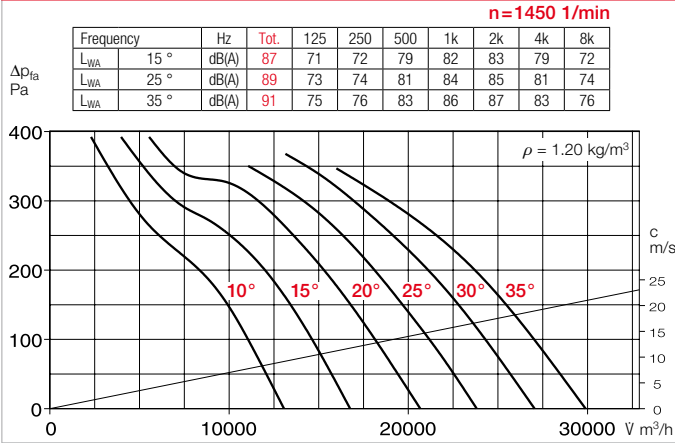

Performance curves 710/6 – Alternating current

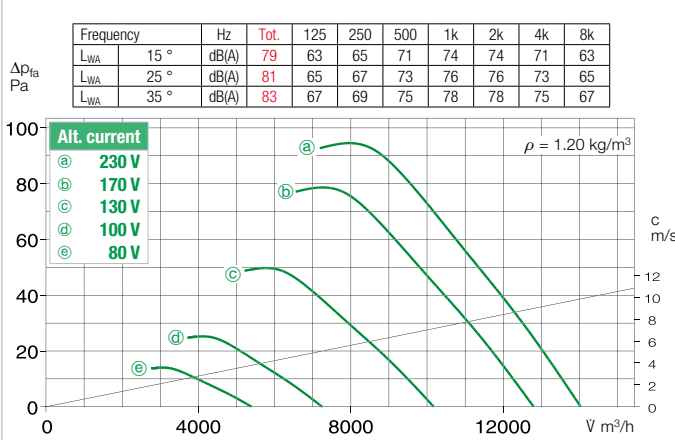

Performance curves 710/6 – Three-phase current

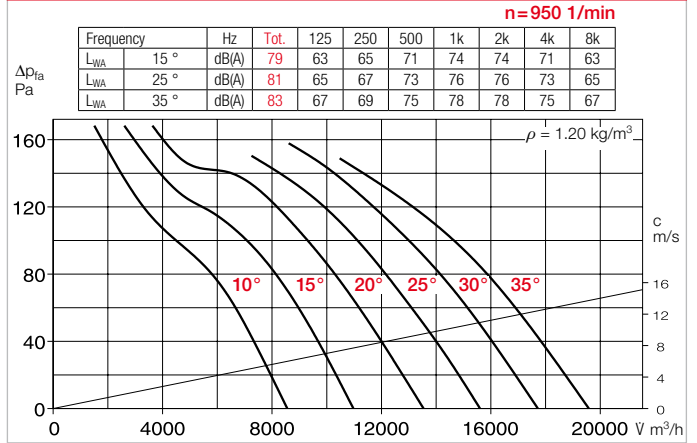

Performance curves 710/8

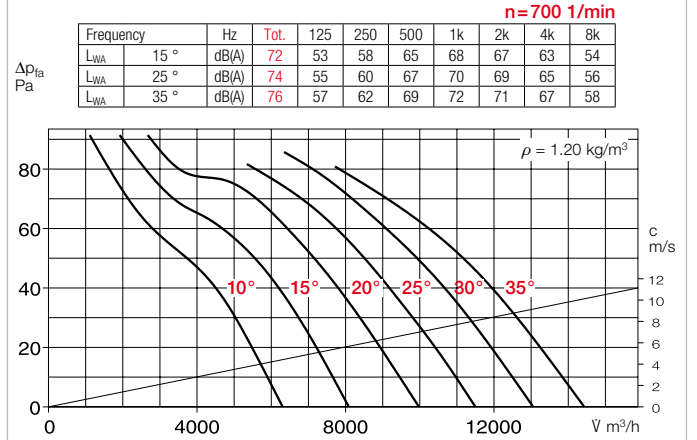

Accessories for HRF 710 / AVD RK 710 Description see page 268 ff.

Elec. speed controller, continuously variable Frequency inverter with sine filter		Vibration damper Nominal size	
Type	Ref. no.	Type	Ref. no.
—	—	..1/.1	01452/01454
EDS 5 ⁴⁾	00501	..1/.1	01452/01454
FU-BS 8.0 ⁴⁾	05461	..1/.1	01452/01454
FU-BS 8.0 ⁴⁾	05461	..2/.2	01453/01455
EDS 5 ⁴⁾	00501	..1/.1	01452/01454
EDS 5 ⁴⁾	00501	..1/.1	01452/01454
EDS 11.5 ⁴⁾	00502	..2/.2	01453/01455
—	—	..2/.2	01453/01455
—	—	..2/.2	01453/01455
not permitted	—	..1/.2	01452/01455
not permitted	—	..1/.2	01452/01455
not permitted	—	..1/.2	01452/01455
not permitted	—	..2/.2	01453/01455
not permitted	—	..2/.2	01453/01455

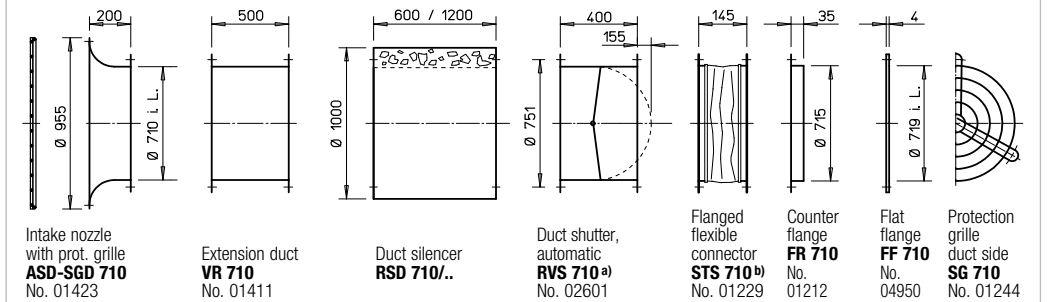

^{a)} Shutter, motorised see Accessories product pages.

^{b)} See below for types for explosion-proof fans.

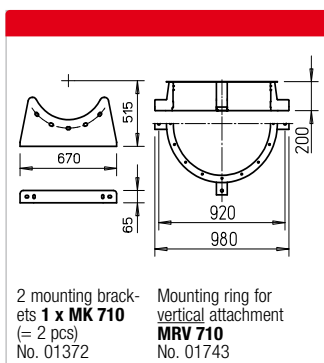

Reference	Page
Techn. description	172
Selection table	173
Planning information	10 ff.

Special design

Different voltage, protection category, air flow temperature, acid protection and impeller made of cast aluminium upon request.

Other accessories	Page
^{b)} Access. for expl.-proof fans	
Flanged flexible connector STS 710 Ex	Ref. no. 02510
Silencers	486 ff.
Shutters and ventilation grilles	553 ff.
Speed controllers, controllers and switches	591 ff.

⁴⁾ Flush-m. version see Switch product page.

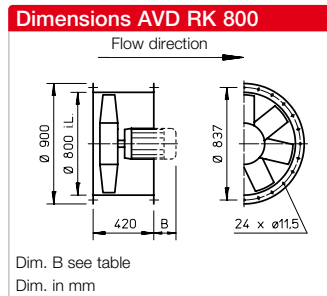
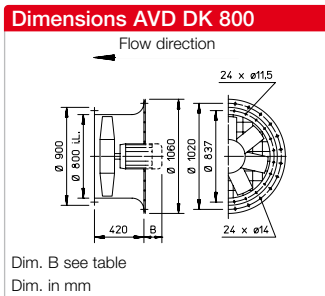

Description for all types

- **Casing**
 With motor mount made of galvanized steel sheet.
- **Impeller**
 High performance characteristics with profiled blades made of plastic, dynamically balanced. Different for explosion-proof types.
- **Angle of attack**
 The impeller blades can be adjusted for optimal operating point coverage (except for explosion-proof types). The angle of attack is adjusted (according to the order) and fixed at the factory. The motor is assigned using the maximum power according to the information in the table below. The specified angle of attack must not be exceeded.

- **Drive**
 Closed design type IP55 or IP54. Maintenance-free and radio interference-free. Tropicalised winding with moisture proof coating. Different for explosion-proof types.
- **Motor protection**
 All types (except for pole-changeable and explosion-proof types, see page 172) are equipped with thermal contacts or PTC thermistors and must be protected by means of the following motor protection devices according to the footnotes the table:
⁴⁾MSA, Ref. no. 01289 (for PTC thermistor temperature sensor)
⁵⁾M4, Ref. no. 01571
 All other types must be protected by means of on-site a motor protection circuit breaker.

- **Electrical connection**
 Terminal box in protection category IP54 mounted on motor.
- **Protection grille**
 Hot-dip galvanised for AVD DK as standard in accordance with DIN EN ISO 13857.
- **Power control**
 Partly through voltage reduction, see "Transformer speed controller" column. Regulated performance performance curve upon request. Frequency inverter possible for all types (except for pole-changeable and explosion-proof types). The planned use of a frequency inverter without a sine filter should be indicated when placing the order. This requires a change of fan version and additional costs, if necessary.

- **Reverse operation**
 All types are reversible using a reverser switch. Performance reduction of approx. 1/3 in abnormal flow direction.
- **Installation**
 Installation possible in any position, but be aware of any condensate drain holes depending on usage.
- **Dimensions**
 Pole-changeable and explosion-proof types may differ from the above information. Motor lengths may vary. Take note of dim. B protrusion.
- **Noise levels**
 The sound power values over the frequency and as total levels are indicated above the performance diagrams. Different for explosion-proof types.

Speed min ⁻¹	Flow rate free blowing V m ³ /h	Rated motor power (output)* kW	Voltage V	Current consump. Rat. volt./ (control)* A	Max. position ° deg.	Wiring dia- gram No.	Max. air flow temp. + °C	Wgt net aprx.** kg	Design type						Transformer speed controller 5-step, pole changing switch	
									AVD DK incl. protection grille	Ref. no.	Dim. B Motor protr. in mm	AVD RK	Ref. no.	Dim. B Motor protr. in mm	Type	Ref. no.
Three-phase current, 50 Hz, Squirrel-cage rotor, protection category IP54																
1445	33450	4.00*	400/690	8.3*	26	776	40	101	AVD DK 800/4/.. ⁴⁾	05311	210	AVD RK 800/4/.. ⁴⁾	06960	210	—	—
1450	39130	5.5*	400/690	11*	33	776	40	115	AVD DK 800/4/.. ⁴⁾	05312	290	AVD RK 800/4/.. ⁴⁾	06961	290	—	—
Two-speed, three-phase current, 400 V, 50 Hz, protection category IP55																
775/920	15720/18670	0.40/0.75*	400/400	1.1/2.3*	22	520	40	70	AVD DK 800/6/6.. ⁵⁾	05307	125	AVD RK 800/6/6.. ⁵⁾	06956	125	RDS 4 ²⁾	01316
Pole-changeable, 2 speeds, three-phase current, 50 Hz, protection category IP54																
695/1400	10020/20180	0.37/1.50*	400/400	1.3/3.7*	12	471	40	95	AVD DK 800/8/4.. ¹⁾	05319	135	AVD RK 800/8/4/.. ¹⁾	06968	135	PDA 12 ³⁾	05081
Explosion-proof, II 2G Ex h IIB + H₂ T3 Gb, Motor Ex e, three-phase current 400 Volt, 50 Hz, protection category IP55																
700	17190	0.55*	400	2.2*	32	470	40	81	AVD DK 800/8 Ex/..	05326	135	AVD RK 800/8 Ex/..	06974	135	not permitted	—
930	20340	0.95*	400	2.7*	23	470	40	90	AVD DK 800/6 Ex/..	05329	135	AVD RK 800/6 Ex/..	06976	135	not permitted	—
950	26710	1.9*	400	4.7*	35	470	40	118	AVD DK 800/6 Ex/..	05330	210	AVD RK 800/6 Ex/..	06977	210	not permitted	—
1420	31900	3.60*	400/690	8.1*	24	498	40	115	AVD DK 800/4 Ex/..	05332	210	AVD RK 800/4 Ex/..	06978	210	not permitted	—
1450	36820	5.00*	400/690	10.1*	30	498	40	143	AVD DK 800/4 Ex/..	05333	290	AVD RK 800/4 Ex/..	06979	290	not permitted	—

* Motor ratings, Ex see information p. 16. ¹⁾ Dahlander winding. ²⁾ Incl motor protection circuit breaker. ³⁾ Flush-m. version see Switch product page.
⁴⁾ and ⁵⁾ Motor protection devices, see description "Motor protection".

Performance curves 800/4

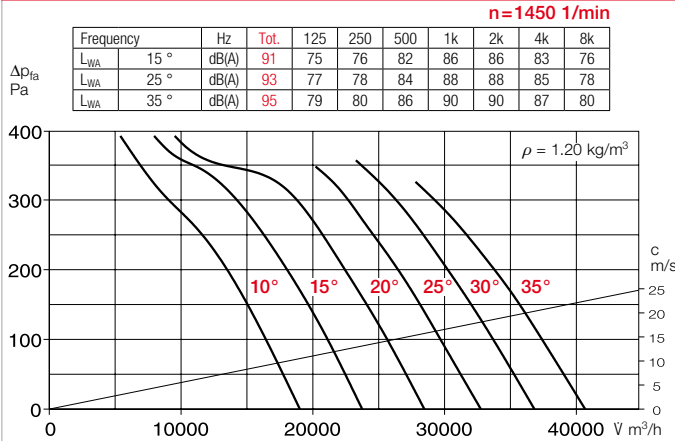

Performance curves 800/6

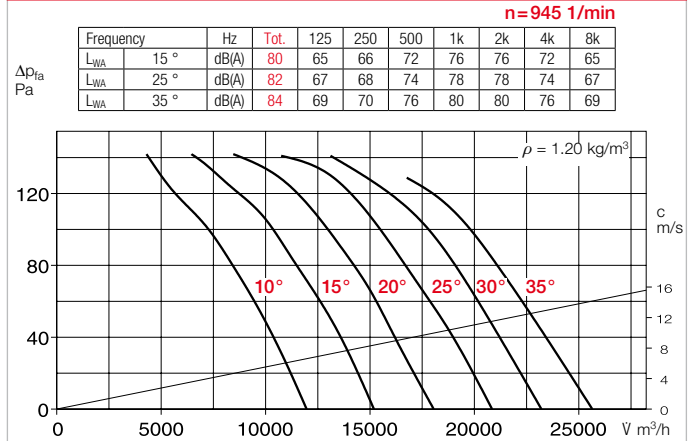

Performance curves 800/8

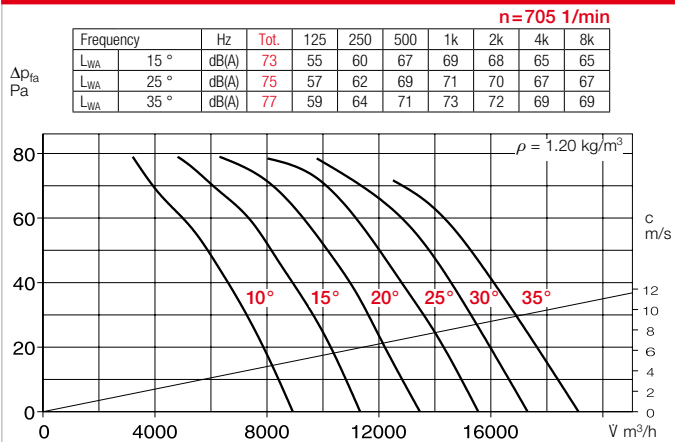

Accessories for AVD RK 800 Description see page 268 ff.

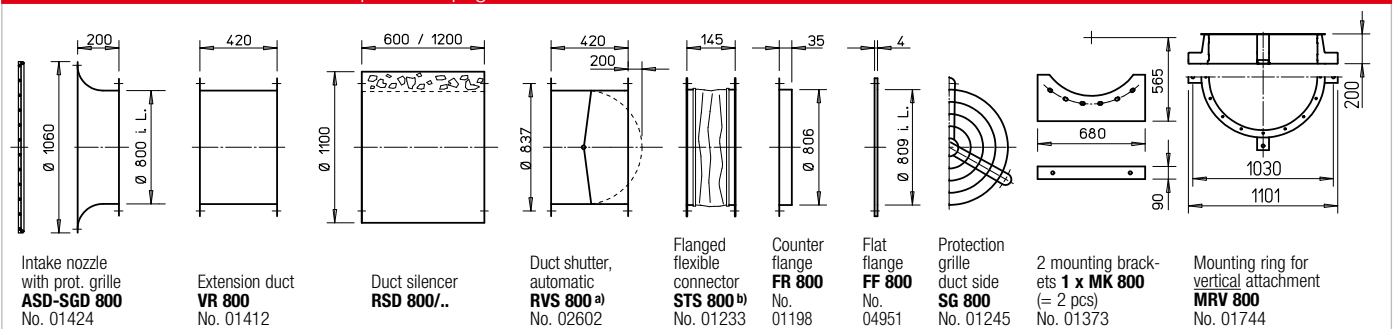

^{a)} Shutter, motorised see Accessories product pages.

^{b)} See below for types for explosion-proof fans.

Elec. speed controller, continuously variable Frequency inverter with sine filter		Vibration damper Nominal size SDD/SDZ	
Type	Ref. no.	Type	Ref. no.
FU-BS 10^{a)}	05462	..2/..2	01453/01455
FU-BS 14^{a)}	05463	—	—
EDS 5^{a)}	00501	..2/..2	01453/01455
—	—	..2/..2	01453/01455
not permitted	—	..2/..2	01453/01455
not permitted	—	..2/..2	01453/01455
not permitted	—	..2/..2	01453/01455
not permitted	—	..2/..2	01453/01455
not permitted	—	..2/..2	01453/01455

Reference	Page
Techn. description	172
Selection table	173
Planning information	10 ff.
Special design	
Different voltage, protection category, air flow direction, higher air flow temperature, acid protection and impeller made of cast aluminium upon request.	
The technical information on p. 15 ff. must be observed.	

Other accessories	Page
^{b)} Access. for expl.-proof fans	
Flanged flexible connector STS 800 Ex	Ref. no. 02511
Silencers	486 ff.
Shutters and ventilation grilles	553 ff.
Speed controllers, controllers and switches	591 ff.

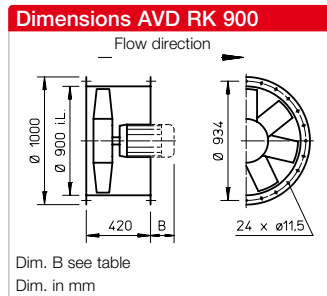
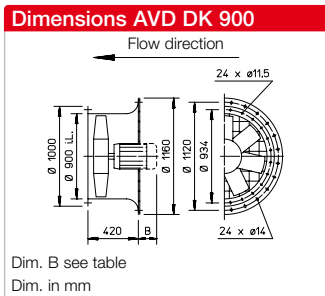

Description for all types

- Casing**
With motor mount made of galvanized steel sheet.
- Impeller**
High performance characteristics with profiled blades made of plastic, dynamically balanced. Different for explosion-proof types.
- Angle of attack**
The impeller blades can be adjusted for optimal operating point coverage (except for explosion-proof types). The angle of attack is adjusted (according to the order) and fixed at the factory. The motor is assigned using the maximum power according to the information in the table below. The specified angle of attack must not be exceeded.

- Drive**
Closed design type IP55 or IP54. Maintenance-free and radio interference-free. Tropicalised winding with moisture proof coating. Different for explosion-proof types.
- Motor protection**
All types (Ref. no. 05380 Ref. no. 06996 and explosion-proof, see page 172) are equipped with thermal contacts or PTC thermistors and must be protected by means of the following motor protection devices according to the footnotes the table:
⁴⁾MSA, Ref. no. 01289 (for PTC thermistor temperature sensor)
⁵⁾M4, Ref. no. 01571
 All other types must be protected by means of on-site a motor protection circuit breaker.

- Electrical connection**
Terminal box in protection category IP54 mounted on motor.
- Protection grille**
Hot-dip galvanised for AVD DK as standard in accordance with DIN EN ISO 13857.
- Power control**
Partly through voltage reduction, see "Transformer speed controller" column. Regulated performance performance curve upon request. Frequency inverter possible for all types (except for pole-changeable and explosion-proof types). The planned use of a frequency inverter without a sine filter should be indicated when placing the order. This requires a change of fan version and additional costs, if necessary.

- Reverse operation**
All types are reversible using a reverser switch. Performance reduction of approx. 1/3 in abnormal flow direction.
- Installation**
Installation possible in any position, but be aware of any condensate drain holes depending on usage.
- Dimensions**
Pole-changeable and explosion-proof types may differ from the above information. Motor lengths may vary. Take note of dim. B protrusion.
- Noise levels**
The sound power values over the frequency and as total levels are indicated above the performance diagrams. Different for explosion-proof types.

Speed	Flow rate free blowing	Rated motor power (output)*	Voltage	Current consump. Rat. volt./ (control)*	Max. position	Wiring dia-gram	Max. air flow temp.	Wgt net appr.**	Design type						
									AVD DK incl. protection grille			AVD RK			Transformer speed controller 5-step, pole changing switch
min ⁻¹	V m ³ /h	kW	V	A	° deg.	No.	+ °C	kg	Ref. no.	Dim. B Motor protr. in mm	Ref. no.	Dim. B Motor protr. in mm	Type	Ref. no.	
Three-phase current, 50 Hz, Squirrel-cage rotor, protection category IP54															
950	37300	3.00*	400/690	6.2*	34	776	40	130	AVD DK 900/6/.. ⁴⁾	05369	290	AVD RK 900/6/.. ⁴⁾	06985	290	—
1445	35030	4.00*	400/690	8.3*	16	776	40	118	AVD DK 900/4/.. ⁴⁾	05370	210	AVD RK 900/4/.. ⁴⁾	06986	210	—
1450	48995	7.50*	400/690	14.5*	27	776	40	142	AVD DK 900/4/.. ⁴⁾	05371	325	AVD RK 900/4/.. ⁴⁾	06987	325	—
1470	57720	11.00*	400/690	20.0*	34	776	40	186	AVD DK 900/4/.. ⁴⁾	05372	385	AVD RK 900/4/.. ⁴⁾	06988	385	—
Two-speed, three-phase current, 400 V, 50 Hz, √3 connection, protection category IP55															
775/930	18390/22660	0.71/1.32*	400/400	2.1/4.0*	19	520	40	90	AVD DK 900/6/6.. ⁵⁾	05367	180	AVD RK 900/6/6.. ⁵⁾	06983	180	RDS 7 ²⁾ 01578
770/920	25990/31060	1.38/2.37*	400/400	3.9/7.1*	27	520	40	115	AVD DK 900/6/6.. ⁵⁾	05368	210	AVD RK 900/6/6.. ⁵⁾	06984	210	RDS 11 ²⁾ 01332
Pole-changeable, 2 speeds, three-phase current, 50 Hz, protection category IP54															
700/1435	18270/37450	1.10/4.50*	400/400	2.9/9.6*	18	471	40	120	AVD DK 900/8/4.. ¹⁾	05379	290	AVD RK 900/8/4.. ¹⁾	06995	290	PDA 12 ³⁾ 05081
715/1450	22390/45410	1.80/6.50*	400/400	5.7/14.5*	24	471	40	148	AVD DK 900/8/4.. ¹⁾	05380	325	AVD RK 900/8/4.. ¹⁾	06996	325	PDA 25 ³⁾ 05060
Explosion-proof, II 2G Ex h IIB + H₂ T₃ Gb, Motor Ex e, three-phase current 400 Volt, 50 Hz, protection category IP55															
700	24470	0.95*	400	2.8*	27	470	40	110	AVD DK 900/8 Ex/..	05386	180	AVD RK 900/8 Ex/..	06899	180	not permitted
725	28470	1.3*	400	3.9*	34	470	40	130	AVD DK 900/8 Ex/..	05387	210	AVD RK 900/8 Ex/..	06900	210	not permitted
950	30550	1.90*	400	4.7*	25	470	40	135	AVD DK 900/6 Ex/..	05389	210	AVD RK 900/6 Ex/..	06901	210	not permitted
960	38040	3.50*	400/690	7.4*	35	498	40	160	AVD DK 900/6 Ex/..	05390	290	AVD RK 900/6 Ex/..	06902	290	not permitted
1450	46630	6.80*	400/690	13.6*	25	498	40	175	AVD DK 900/4 Ex/..	05392	325	AVD RK 900/4 Ex/..	06903	325	not permitted
1465	55240	10.00*	400/690	19.8*	32	498	40	235	AVD DK 900/4 Ex/..	05393	385	AVD RK 900/4 Ex/..	06904	385	not permitted

* Motor ratings, see information p. 16. ¹⁾ Dahlander winding. ²⁾ Incl motor protection circuit breaker. ³⁾ Flush-m. version see Switch product page.
⁴⁾ and ⁵⁾ Motor protection devices, see description "Motor protection".

Performance curves 900/4

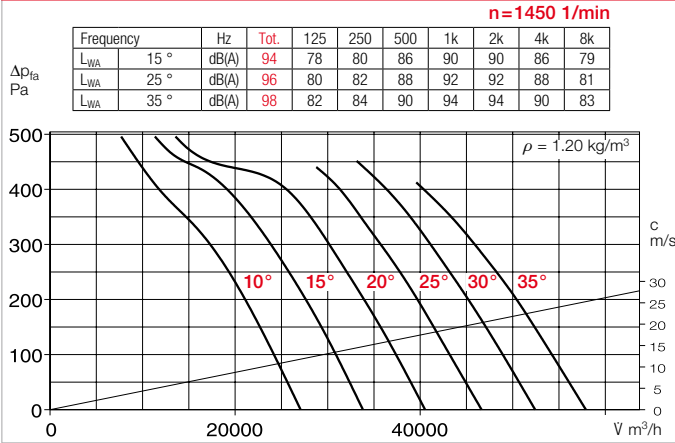

Performance curves 900/6

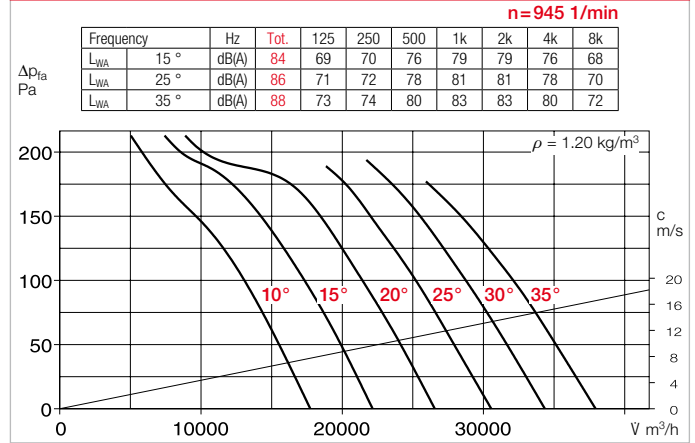

Performance curves 900/8

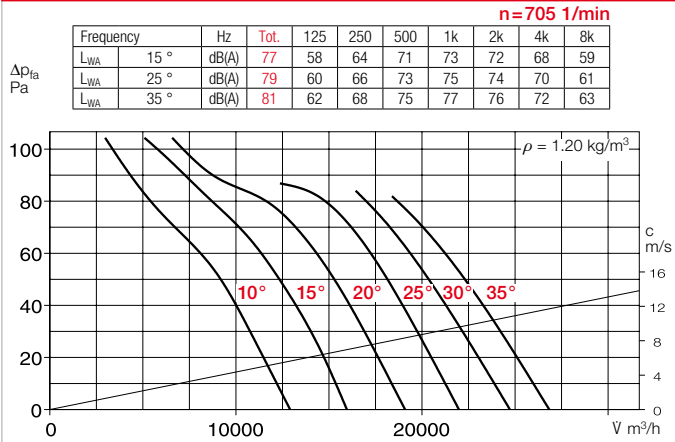

Axial and VAR fans

Accessories for AVD RK 900 Description see page 268 ff.

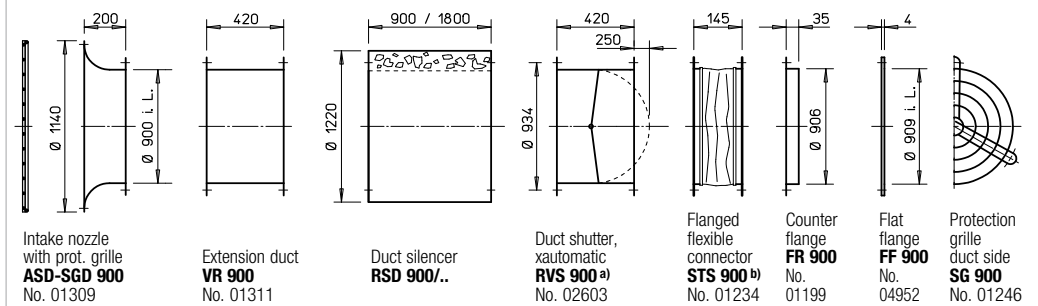

a) Shutter, motorised see Accessories product pages.

b) See below for types for explosion-proof fans.

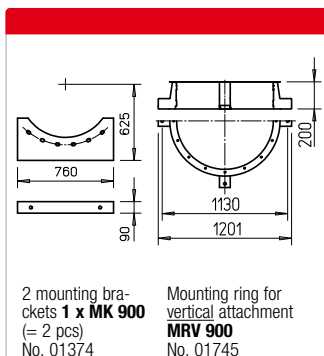

Reference	Page
Techn. description	172
Selection table	173
Planning information	10 ff.

Special design
Different voltage, protection category, air flow direction, higher air flow temperature, acid protection and impeller made of cast aluminium upon request.

Other accessories	Page
-------------------	------

b) **Access. for expl.-proof fans**

Flanged flexible connector STS 900 Ex Ref. no. 02512

Silencers 486 ff.
Shutters and ventilation grilles 553 ff.
Speed controllers, controllers and switches 591 ff.

Elec. speed controller, continuously variable Frequency inverter with sine filter		Vibration damper Nominal size SDD/SDZ	
Type	Ref. no.	Type	Ref. no.
FU-BS 8.0 ^{a)}	05461	..2/..2	01453/01455
FU-BS 10 ^{a)}	05462	..3/..3	01367/01366
FU-CS 18 ^{a)}	05469	..3/..3	01367/01366
FU-CS 22 ^{a)}	05470	..3/..3	01367/01366
EDS 5 ^{a)}	00501	..2/..2	01453/01455
EDS 11 ^{a)}	00502	..2/..2	01453/01455
—	—	..2/..2	01453/01455
—	—	..2/..2	01453/01455
not permitted	—	..2/..2	01453/01455
not permitted	—	..2/..2	01453/01455
not permitted	—	..2/..2	01453/01455
not permitted	—	..2/..2	01453/01455
not permitted	—	..3/..3	01367/01366
not permitted	—	..3/..3	01367/01366

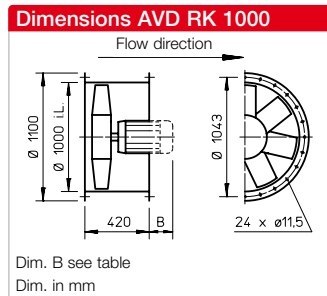
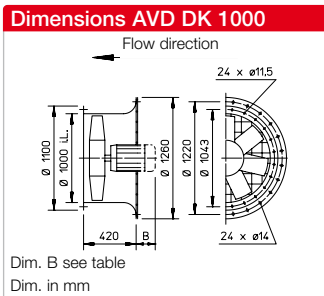

Description for all types

■ **Casing**

With motor mount made of galvanized steel sheet.

■ **Impeller**

High performance characteristics with profiled blades made of plastic, dynamically balanced. Different for explosion-proof types.

■ **Angle of attack**

The impeller blades can be adjusted for optimal operating point coverage (except for explosion-proof types). The angle of attack is adjusted (according to the order) and fixed at the factory. The motor is assigned using the maximum power according to the information in the table below. The specified angle of attack must not be exceeded.

■ **Drive**

Closed design type IP55 or IP54. Maintenance-free and radio interference-free. Tropicalised winding with moisture proof coating. Different for explosion-proof types.

■ **Motor protection**

All types (except for pole-changeable and explosion-proof types, see page 172) are equipped with thermal contacts or PTC thermistors and must be protected by means of the following motor protection devices according to the footnotes the table:

⁴⁾MSA, Ref. no. 01289

(for PTC thermistor temperature sensor)

⁵⁾M4, Ref. no. 01571

All other types must be protected by means of on-site a motor protection circuit breaker.

■ **Electrical connection**

Terminal box in protection category IP54 mounted on motor.

■ **Protection grille**

Hot-dip galvanised for AVD DK as standard in accordance with DIN EN ISO 13857.

■ **Power control**

Partly through voltage reduction, see "Transformer speed controller" column. Regulated performance curve upon request.

Frequency inverter possible for all types (except for pole-changeable and explosion-proof types).

The planned use of a frequency inverter without a sine filter should be indicated when placing the order. This requires a change of fan version and additional costs, if necessary.

■ **Reverse operation**

All types are reversible using a reverser switch. Performance reduction of approx. 1/3 in abnormal flow direction.

■ **Installation**

Installation possible in any position, but be aware of any condensate drain holes depending on usage.

■ **Dimensions**

Pole-changeable and explosion-proof types may differ from the above information. Motor lengths may vary. Take note of dim. B protrusion.

■ **Noise levels**

The sound power values over the frequency and as total levels are indicated above the performance diagrams. Different for explosion-proof types.

Speed	Flow rate free blowing	Rated motor power (output)*	Voltage	Current consump. Rat. volt./ (control)*	Max. position	Wiring diagram	Max. air flow temp.	Wgt net aprx.**	Design type				Transformer speed controller 5-step, pole changing switch			
									AVD DK incl. protection grille	Ref. no.	Dim. B Motor protr. in mm	AVD RK	Ref. no.	Dim. B Motor protr. in mm	Type	Ref. no.
min ⁻¹	V m ³ /h	kW	V	A	° deg.	No.	+ °C	kg								
Three-phase current, 50 Hz, Squirrel-cage rotor, protection category IP54																
950	39720	3.0*	400/690	6.2*	23	776	40	120	AVD DK 1000/6/.. ⁴⁾	05398	290	AVD RK 1000/6/.. ⁴⁾	05573	290	—	—
955	46320	4.0*	400/690	9.2*	29	776	40	127	AVD DK 1000/6/.. ⁴⁾	05399	325	AVD RK 1000/6/.. ⁴⁾	05574	325	—	—
955	52450	5.5*	400/690	12.4*	35	776	40	145	AVD DK 1000/6/.. ⁴⁾	05400	325	AVD RK 1000/6/.. ⁴⁾	05575	325	—	—
1470	61460	11.0*	400/690	20.0*	23	776	40	160	AVD DK 1000/4/.. ⁴⁾	05401	385	AVD RK 1000/4/.. ⁴⁾	05576	385	—	—
1470	71290	15.0*	400/690	26.0*	29	776	40	195	AVD DK 1000/4/.. ⁴⁾	05402	430	AVD RK 1000/4/.. ⁴⁾	05577	430	—	—
1475	79440	18.5*	400/690	35.0*	34	776	40	210	AVD DK 1000/4/.. ⁴⁾	05403	465	AVD RK 1000/4/.. ⁴⁾	05578	465	—	—
Pole-changeable, 2 speeds, three-phase current, 50 Hz, protection category IP54																
715/1440	27410/55210	2.2/9.0*	400/400	7.2/19.0*	20	471	40	165	AVD DK 1000/8/4/.. ¹⁾	05407	385	AVD RK 1000/8/4/.. ¹⁾	05582	385	PDA 25 ³⁾	05060
715/1445	32325/65330	3.0/12.0*	400/400	9.4/25.0*	26	471	40	190	AVD DK 1000/8/4/.. ¹⁾	05408	415	AVD RK 1000/8/4/.. ¹⁾	05583	415	PDA 63 ³⁾	01283
Explosion-proof, II 2G Ex h IIB + H₂ T₃ Gb, Motor Ex e, three-phase current 400 Volt, 50 Hz, protection category IP55																
955	43180	3.5*	400/690	7.4*	26	498	40	130	AVD DK 1000/6 Ex/..	05415	325	AVD RK 1000/6 Ex/..	05590	325	not permitted	not permitted
960	52730	6.6*	400/690	13.4*	35	498	40	155	AVD DK 1000/6 Ex/..	05416	400	AVD RK 1000/6 Ex/..	05591	400	not permitted	not permitted
1480	70160	15.0*	400/690	27.5*	28	498	40	200	AVD DK 1000/4 Ex/..	05417	430	AVD RK 1000/4 Ex/..	05592	430	not permitted	not permitted
1470	77600	17.5*	400/690	33.0*	33	498	40	225	AVD DK 1000/4 Ex/..	05418	470	AVD RK 1000/4 Ex/..	05593	470	not permitted	not permitted

* Motor ratings, see information p. 16.

¹⁾ Dahlander winding.

²⁾ Incl motor protection circuit breaker.

³⁾ Flush-m. version see Switch product page.

⁴⁾ and ⁵⁾ Motor protection devices, see description "Motor protection".

Performance curves 1000/4

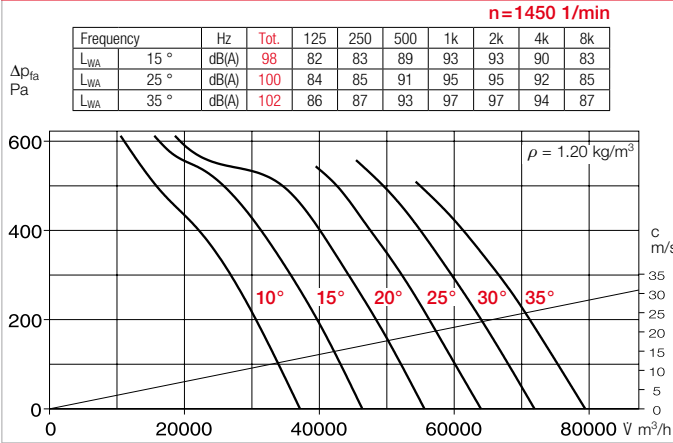

Performance curves 1000/6

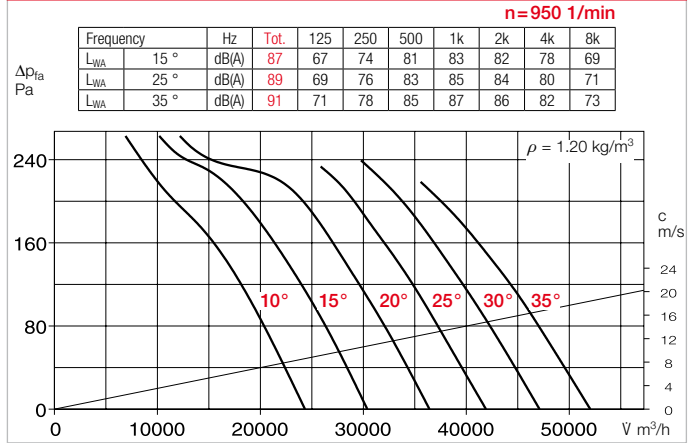

Performance curves 1000/8

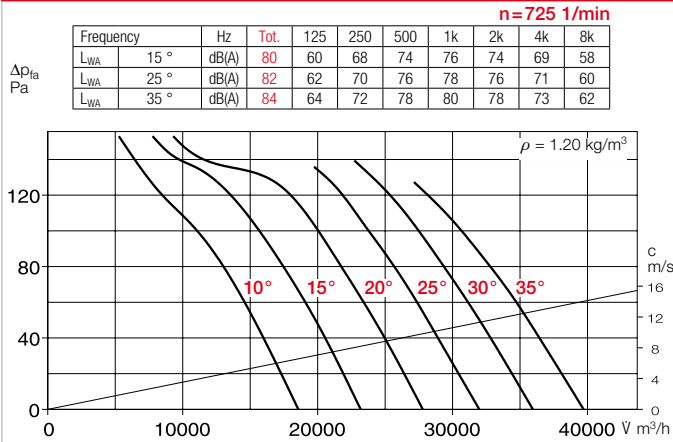

Axial and VAR fans

Accessories for AVD RK 1000 Description see page 268 ff.

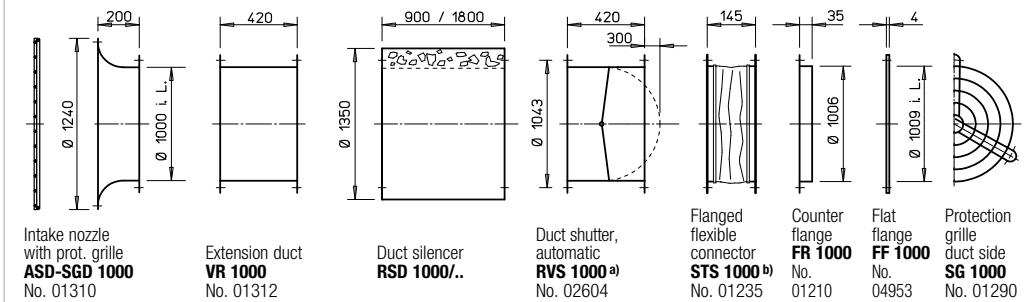

^{a)} Shutter, motorised see Accessories product pages.

^{b)} See below for types for explosion-proof fans.

Elec. speed controller, continuously variable Frequency inverter with sine filter		Vibration damper Nominal size SDD/SDZ	
Type	Ref. no.	Type	Ref. no.
FU-BS 8.0 ²⁾	05461	..2/..2	01453/01455
FU-BS 10.1 ²⁾	05462	..2/..2	01453/01455
FU-BS 10.1 ²⁾	05462	..2/..2	01453/01455
FU-CS 22 ²⁾	05470	..3/..3	01367/01366
FU-CS 32 ²⁾	05471	..3/..3	01367/01366
FU-CS 40 ²⁾	05472	..3/..3	01367/01366
—	—	..3/..3	01367/01366
—	—	..3/..3	01367/01366
not permitted	—	..2/..2	01453/01455
not permitted	—	..2/..2	01453/01455
not permitted	—	..3/..3	01367/01366
not permitted	—	..3/..3	01367/01366

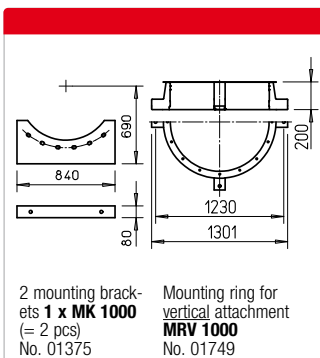

Reference	Page
Techn. description	172
Selection table	173
Planning information	10 ff.

Special design
Different voltage, protection category, air flow direction, higher air flow temperature, acid protection and impeller made of cast aluminium upon request.

Other accessories	Page
^{b)} Access. for expl.-proof fans	
Flanged flexible connector STS 1000 Ex	Ref. no. 02513
Silencers	486 ff.
Shutters and ventilation grilles	553 ff.
Speed controllers, controllers and switches	591 ff.

Medium pressure axial fans. Maximum performance for a range of applications.

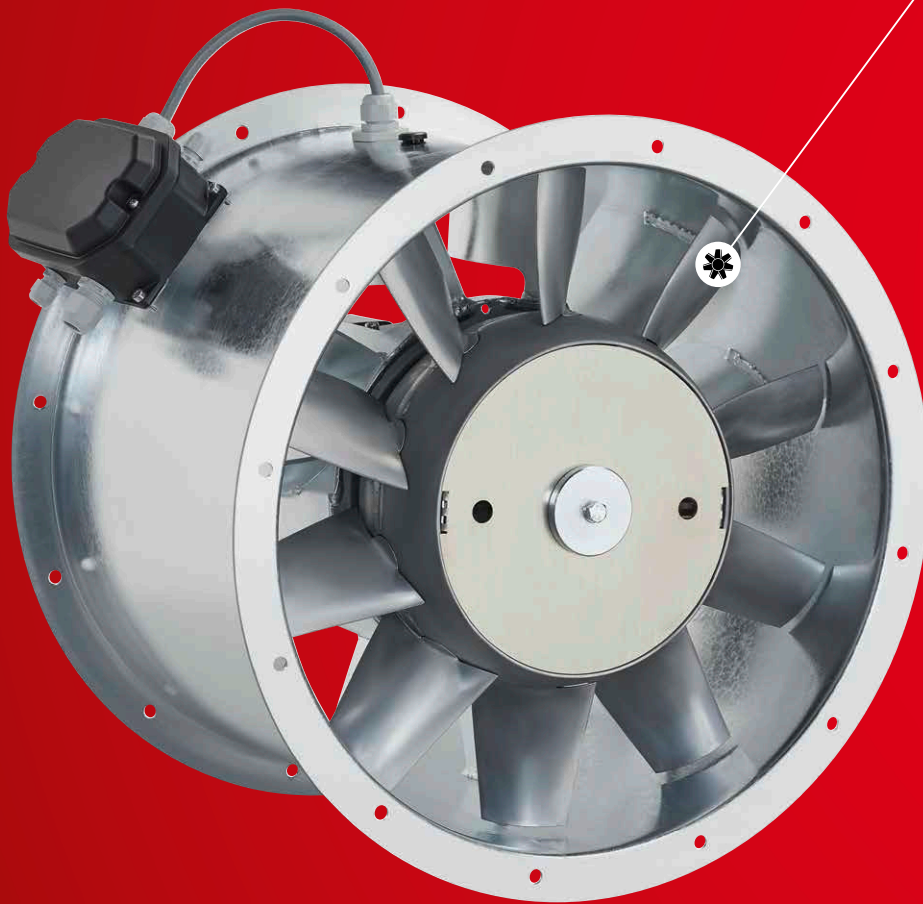

With diameter sizes from 225 to 400 mm, flow rates up to 32000 m³/h and very high pressure rates up to 1400 Pa, the Helios medium pressure axial fans provide for maximum volume flows in the smallest of spaces.

Universal installation options in horizontal and vertical positions allow flexible use in a variety of applications.



■ Innovative

Maximum efficiency is ensured by the new optimally tuned system consisting of a plastic impeller with perfectly integrated flow geometry, an innovative guide wheel with maximum pressure recovery and specially tuned motors. With AMD / AMW, we have created a product which meets the highest physical requirements.

■ Energy-efficient

- High pressure and volume rates with very small dimensions.
- Minimal noise levels.
- Minimal energy costs at maximum performance.
- Maximum pressure recovery due to innovative guide wheel.
- Very low residual torque.
- Low impact and outlet losses.

■ Universal

The complete AMD range with more than 300 types in 12 sizes (NS 315 – 1120) and $V. > 113000 \text{ m}^3/\text{h}$ is included in the Helios TGA Catalogue. Includes B AMD types for mechanical smoke extraction systems (MRA) in temperature classes F300 and F400 as well as installation kits for two level serial Z or parallel P designs.

See TGA-catalogue
Ref. no. 86979



This information supplements the “General technical information”.

Features

AMD/AMW is a series of medium pressure fans in compact design with excellent power density in relation to its size. The new axial impeller, which has been optimised for pressure and efficiency, achieves the best levels of efficiency, high pressure levels and large flow rates in combination with the fixed guide wheel.

Casing

Tubular casing with flanges on both sides in accordance with DIN 24155 p. 3 with integrated guide wheel and motor mount made of galvanised steel. Terminal box on outside of duct.

Impeller

Axial impeller made of plastic with 14 spatially curved blades as well as perfectly integrated flow geometry in the impeller. Maximum pressure recovery in combination with the innovative guide wheel, high level of efficiency, low operating noise level, high corrosion resistance, low-vibration operation through dynamic balancing in accordance with DIN ISO 21940-11 – quality grade 6.3.

Air flow temperatures

The standard version can be used in the range from –30 up to at least +60 °C. See information on product page. Approval for higher continuous temperatures is possible upon request.

Air flow direction

The air flow direction cannot be changed, but it can be set by the installation method. The correct motor rotation direction and air flow direction is marked by arrows on the fan.

Installation position, installation, condensate outlets

A duct section with length = 2.5 x pipe diameter for free discharge and a corresponding straight duct section for intermediate positioning in a pipeline are required (Figure 1) to achieve the specified performance values. The ideal flow through the fan is only ensured if there is an upstream intake nozzle with sufficient intake space or a 2.5 x Ø long straight duct section in the duct installation with the same diameter.

The installation site and mounting should be such that the fan can be mounted securely and without warping. AMD/AMW can be installed and operated in any position. In case of equipment with condensate drain holes, please be aware of their position.

The fans must not be operated in contact with water and effective weather protection must be provided in case of outdoor installation.

In case of operation under more difficult conditions, such as high humidity, excessive strain due to climatic, technical, electronic influences, consultation and approval are required because the standard version is not suitable for this.

Positioning

The use of vibration dampers is recommended (accessories SDD, SDZ) to prevent vibration transmission. Larger motors may protrude from the back and cause uneven distribution due to their high weight. An extension duct VR (accessories) should be provided to adjust the centre of gravity!

Installation examples

Horizontal

– **Figure 2**
Free intake, outlet-side operation with silencer provided with intermediate flanges. Duct silencers can be provided with intermediate flanges to reduce the inlet-side or outlet-side sound power.

– **Figure 3**
Ceiling suspension

Figure 3 shows a typical installation in a ventilation application. The installation of AMD/AMW systems is possible through direct ceiling suspension via mounting bracket (MK) and vibration damper (accessories SDD, SDZ). The tubular casing with double-sided flanges (according to DIN 24155 p. 3) is designed for direct installation in the pipeline.

Figure 1

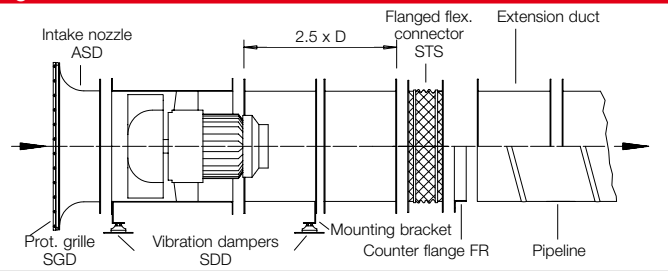

Figure 2

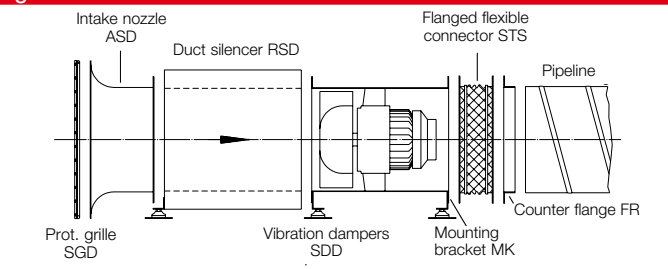
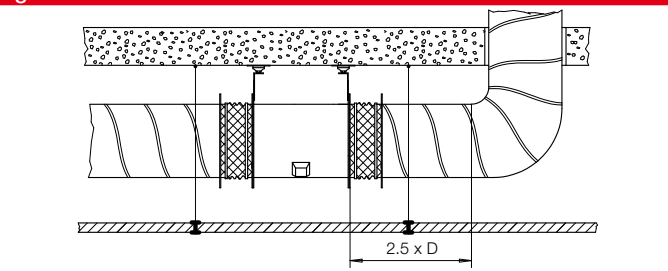

Figure 3



Vertical

– **Figure 4**

Integrated in the pipeline with inlet-side silencer. Wall mounted with brackets or through the ceiling. The elements must be suspended separately according to weight. Do not mount the fan with combined loads for inspection. Mounting rings MRV are available for the vertical attachment of the fan for size 315 and above. The fan weight including the attached accessories must not exceed the load-bearing capacity of the MRV.

Figure 4

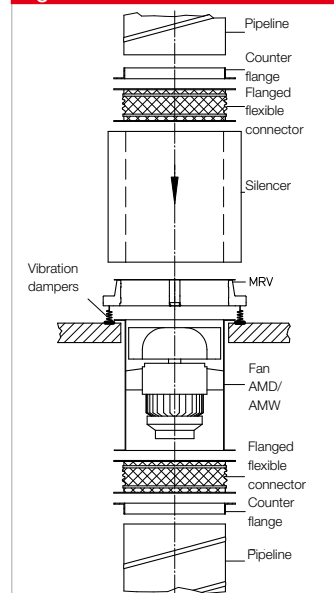

Reference	Page
Planning information, Acoustics	10 ff.
General techn. information, power control	15 ff.

By combining the parameters of static pressure increase Δp_{fa} , flow rate V , speed min^{-1} , sound pressure level dB(A) and impeller diameter DN mm, the following table facilitates the selection of AMD/AMW medium pressure fans.

Diameter mm	Speed min^{-1}	Sound press. inlet side L_{PA} dB(A) at 4 m dist.	Flow rate V m^3/h depending on static pressure = N / m^2 = freely available pressure (ΔP_{fa}) in Pa												
			0	25	50	75	100	150	200	300	400	500	600	700	800
225	2800	53	1950	1900	1860	1780	1720	1590	1400						
225	1400	38	950	840	710										
250	2800	56	2620	2550	2480	2410	2340	2180	1980						
250	1400	42	1360	1250	1080										
280	2800	59	3970	3910	3850	3760	3690	3540	3360	3020					
280	1400	44	1930	1810	1650	1450									
315	2800	63	5440	5360	5300	5240	5160	4970	4810	4450	4020				
315	1400	48	2870	2730	2590	2390	2210								
355	2800	68	8610	8540	8470	8390	8310	8140	7970	7600	7180	6760	6260	5490	
355	1400	52	4170	4040	3860	3660	3470	3070							
400	2800	73	12420	12330	12250	12160	12060	11870	11700	11310	10870	10420	9890	9260	8450
400	1400	56	6000	5810	5600	5400	5200	4740	3940						

AMD and AMW 225



Dimensions AMD and AMW 225

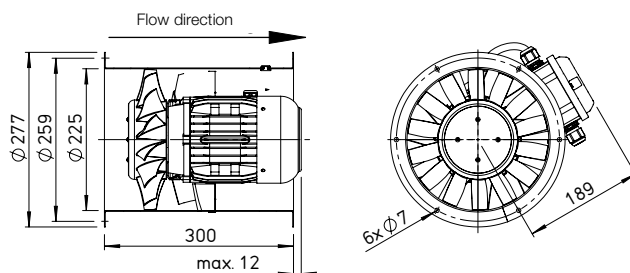

Dim. in mm

Casing

Duct with double-sided flange DIN 24155 p. 3. Made of galvanised steel sheet, fixed guide wheel with inner hub for mounting the flange motor.

Impeller / guide wheel

Impeller with 3D profiled blades and integrated flow geometry made of high-quality plastic. An optimised guide wheel made of galvanised steel is connected to the impeller. The impeller and guide wheel are efficiency-optimised and pressure-optimised for high volume flows by means of CFD. Dynamically balanced in accordance with ISO 21940-11. Operating range -30 to +60 °C.

Drive

Directly through maintenance-free flange motor. Closed design type IP54. Aluminium casing with cooling fins. Radio interference-free, sealed ball bearings. With condensate drain holes upon request and the installation method must be indicated when placing the order. Tropicalised winding with moisture proof coating upon request.

Power control

The voltage-controllable types are identified in the "Current consumption with control mode" column with a value which must be observed when determining the controller (see "speed controller" column). The flow rates are shown in the performance diagram. The planned use of a frequency inverter without a sine filter should be indicated when placing the order. This requires a change of fan version and additional costs, if necessary.

Electrical connection

Standard terminal box (protection category IP55) on outside of duct.

Installation

Installation possible in any position. Condensate drain holes in the motor depending on usage are possible upon request.

Motor protection

All types are equipped with thermal contacts. These should be wired with the motor protection circuit breaker (see type table) for effective motor protection.

Noise levels

See performance diagram. The sound power and sound pressure at 4 m distance under free field conditions are specified for the average operating point on the inlet/outlet side. See page 10 f for noise emissions and room acoustics.

Reference	Page
Selection table	221
Planning information	10 ff.

Special design

Different voltage, frequency, protection category, higher air flow temperature and acid protection upon request.

Other accessories	Page
Installation accessories	268 ff.
Silencers	486 ff.
Switching and control technology	591 ff.

Type	Ref. no.	Speed min ⁻¹	Flow rate free blowing V m ³ /h	Power consump. kW	Voltage V	Current consumption		Wiring diagram No.	Max. air flow temp.		Weight net aprx. kg	Speed controller 5-step		Frequency inverter with integrated sine filter	
						at rated voltage A	with control A		at rated voltage + °C	with control + °C		Type	Ref. no.	Type	Ref. no.
Single-phase alternating current, 50 Hz, protection category IP54															
AMW 225/4	02242	1425	965	0.6	230	0.3	0.3	966.1	60	40	8.7	MWS 1.5 ¹⁾	01947	—	—
AMW 225/2	02243	2750	1955	0.26	230	1.2	1.4	966.1	60	40	9.0	MWS 1.5 ¹⁾	01947	—	—
Three-phase current, 50 Hz, protection category IP54															
AMD 225/4	02244	1430	960	0.06	400	0.2	0.25	469	60	40	8.3	RDS 1 ¹⁾	01314	—	—
AMD 225/2	02245	2760	1950	0.25	400	0.6	0.65	469	60	40	8.8	RDS 1 ¹⁾	01314	—	—

¹⁾ incl. motor protection circuit breaker.

Performance curves AMD and AMW 225/2

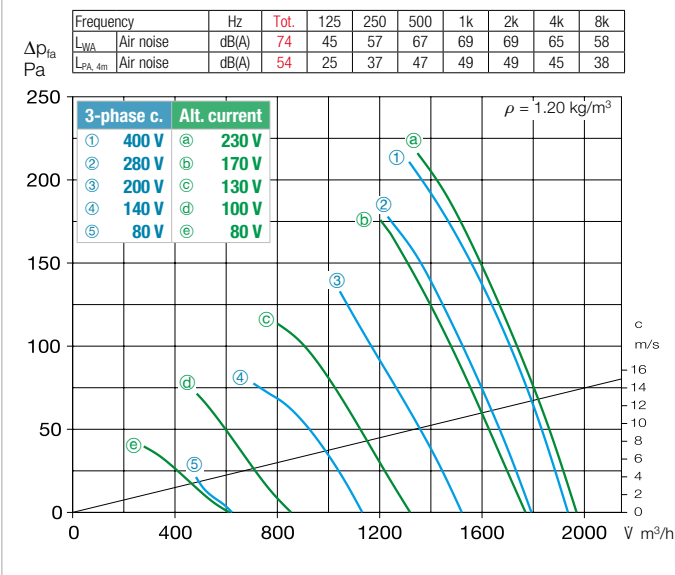

Performance curves AMD and AMW 225/4

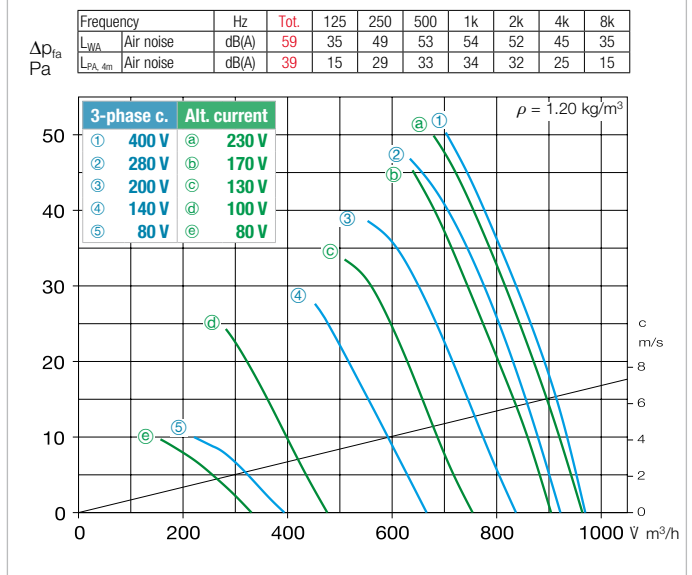

* Three-phase current noise data. Alternating current noise data see www.HeliosSelect.de.

Accessories AMD and AMW 225

Intake nozzle with prot. grille **ASD-SGD 225** No. 01413

Extension duct **VR 225** No. 01401

Duct silencer **RSD 225/..**

Duct shutter, automatic **RVS 225** No. 02591

Flanged flexible connector **STS 225** No. 01218

Counter flange **FR 225** No. 01201

Flexible connecting sleeve **FM 225** No. 01671

Protection grille duct side **SG 225** No. 01215

Mounting brackets **MK 225** (1 Set = 2 pcs) No. 01446

Vibration dampers for tensile load **SDZ 1** (1 set = 4 Pc) No. 01454

Vibration dampers for compression load **SDD 1** (1 set = 4 Pc) No. 01452

^{a)} Shutter, motorised see Accessories product pages. * Type assignment see table, last column.

Motor protection circuit breaker for connecting built-in thermal contacts		Vibration dampers			
		Compression		Tension	
Type	Ref. no.	Type	Ref. no.	Type	Ref. no.
MW	01579	SDD 1	01452	SDZ 1	01454
MW	01579	SDD 1	01452	SDZ 1	01454
MD	05849	SDD 1	01452	SDZ 1	01454
MD	05849	SDD 1	01452	SDZ 1	01454

AMD and AMW 250



Dimensions AMD and AMW 250

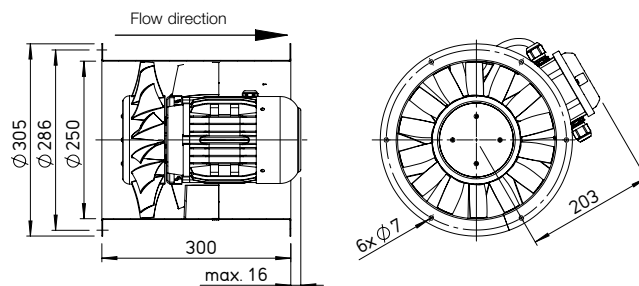

Dim. in mm

Casing

Duct with double-sided flange DIN 24155 p. 3. Made of galvanised steel sheet, fixed guide wheel with inner hub for mounting the flange motor.

Impeller / guide wheel

Impeller with 3D profiled blades and integrated flow geometry made of high-quality plastic. An optimised guide wheel made of galvanised steel is connected to the impeller. The impeller and guide wheel are efficiency-optimised and pressure-optimised for high volume flows by means of CFD. Dynamically balanced in accordance with ISO 21940-11. Operating range -30 to +60 °C.

Drive

Directly through maintenance-free flange motor. Closed design type IP54. Aluminium casing with cooling fins. Radio interference-free, sealed ball bearings. With condensate drain holes upon request and the installation method must be indicated when placing the order. Tropicalised winding with moisture proof coating upon request.

Power control

The voltage-controllable types are identified in the "Current consumption with control mode" column with a value which must be observed when determining the controller (see "speed controller" column). The flow rates are shown in the performance diagram. The planned use of a frequency inverter without a sine filter should be indicated when placing the order. This requires a change of fan version and additional costs, if necessary.

Electrical connection

Standard terminal box (protection category IP55) on outside of duct.

Installation

Installation possible in any position. Condensate drain holes in the motor depending on usage are possible upon request.

Motor protection

All types are equipped with thermal contacts. These should be wired with the motor protection circuit breaker (see type table) for effective motor protection.

Noise levels

See performance diagram. The sound power and sound pressure at 4 m distance under free field conditions are specified for the average operating point on the inlet/outlet side. See page 10 f for noise emissions and room acoustics.

Reference **Page**

Selection table	221
Planning information	10 ff.

Special design

Different voltage, frequency, protection category, higher air flow temperature and acid protection upon request.

Other accessories **Page**

Installation accessories	268 ff.
Silencers	486 ff.
Switching and control technology	591 ff.

Type	Ref. no.	Speed min ⁻¹	Flow rate free blowing V m ³ /h	Power consump. kW	Voltage V	Current consumption		Wiring diagram No.	Max. air flow temp.		Weight net aprx. kg	Speed controller 5-step		Frequency inverter with integrated sine filter		
						at rated voltage A	with control A		at rated voltage + °C	with control + °C		Type	Ref. no.	Type	Ref. no.	
Single-phase alternating current.50 Hz, protection category IP54																
AMW 250/4	02248	1435	1360	0.1	230	0.6	0.6	966.1	60	40	9.0	MWS 1.5 ¹⁾	01947	—	—	—
AMW 250/2	02249	2630	2620	0.4	230	1.9	1.9	966.1	60	40	9.5	MWS 3 ¹⁾	01948	—	—	—
Three-phase current, 50 Hz, protection category IP54																
AMD 250/4	02250	1430	1380	0.08	400	0.3	0.3	469	60	40	9.2	RDS 1 ¹⁾	01314	—	—	—
AMD 250/2	02251	2830	2790	0.43	400	1	1	469	60	40	11.0	RDS 2 ¹⁾	01315	FU-BS 2.5	05459	—

¹⁾ incl. motor protection circuit breaker.

Performance curves AMD and AMW 250/2

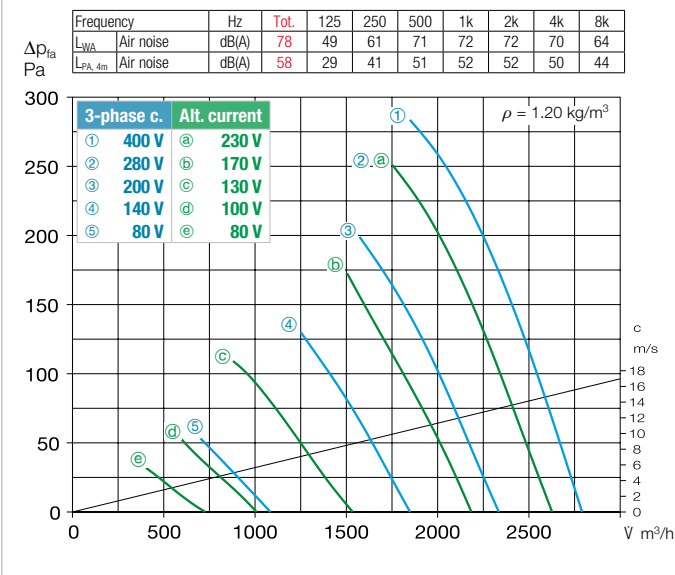

Performance curves AMD and AMW 250/4

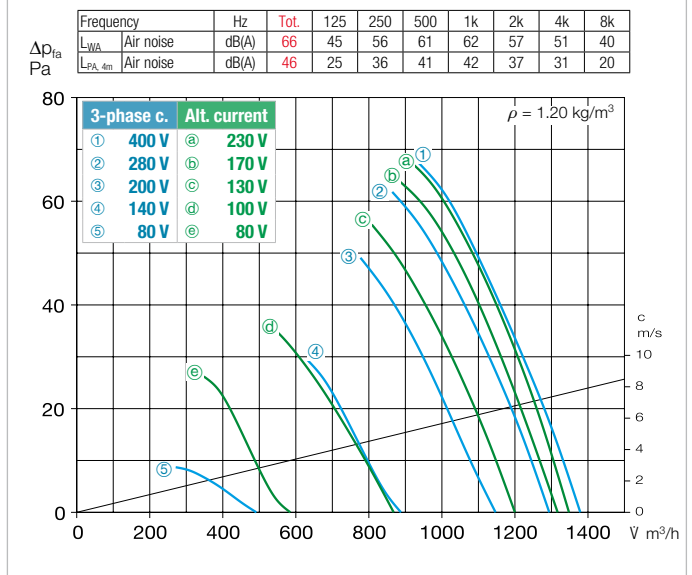

* Three-phase current noise data. Alternating current noise data see www.HeliosSelect.de.

Accessories AMD and AMW 250

Intake nozzle with prot. grille
ASD-SGD 250
No. 01414

Extension duct
VR 250
No. 01402

Duct silencer
RSD 250/..

Duct shutter, automatic
RVS 250^{a)}
No. 02592

Flanged flexible connector
STS 250
No. 01220

Counter flange
FR 250
No. 01203

Flat flange
FF 250
No. 04941

Flexible connecting sleeve
FM 250
No. 01672

Protection grille duct side
SG 250
No. 01236

Mounting brackets
MK 250
(1 Set = 2 pcs)
No. 01447

Vibration dampers for tensile load
SDZ 1* (1 set = 4 Pc) No. 01454

Vibration dampers for compression load
SDD 1* (1 set = 4 Pc) No. 01452

^{a)} Shutter, motorised see Accessories product pages. * Type assignment see table, last column.

Motor protection circuit breaker for connecting built-in thermal contacts		Vibration dampers			
		Compression		Tension	
Type	Ref. no.	Type	Ref. no.	Type	Ref. no.
MW	01579	SDD 1	01452	SDZ 1	01454
MW	01579	SDD 1	01452	SDZ 1	01454
MD	05849	SDD 1	01452	SDZ 1	01454
MD	05849	SDD 1	01452	SDZ 1	01454

AMD and AMW 280



Dimensions AMD and AMW 280

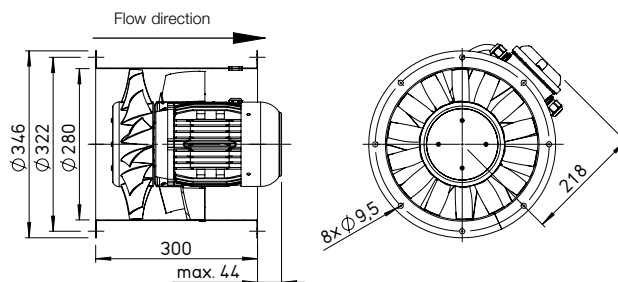

Dim. in mm

■ **Casing**

Duct with double-sided flange DIN 24155 p. 3. Made of galvanised steel sheet, fixed guide wheel with inner hub for mounting the flange motor.

■ **Impeller / guide wheel**

Impeller with 3D profiled blades and integrated flow geometry made of high-quality plastic. An optimised guide wheel made of galvanised steel is connected to the impeller. The impeller and guide wheel are efficiency-optimised and pressure-optimised for high volume flows by means of CFD. Dynamically balanced in accordance with ISO 21940-11. Operating range -30 to +60 °C.

■ **Drive**

Directly through maintenance-free flange motor. Closed design type IP54. Aluminium casing with cooling fins. Radio interference-free, sealed ball bearings. With condensate drain holes upon request and the installation method must be indicated when placing the order. Tropicalised winding with moisture proof coating upon request.

■ **Power control**

The voltage-controllable types are identified in the "Current consumption with control mode" column with a value which must be observed when determining the controller (see "speed controller" column). The flow rates are shown in the performance diagram. The planned use of a frequency inverter without a sine filter should be indicated when placing the order. This requires a change of fan version and additional costs, if necessary.

■ **Electrical connection**

Standard terminal box (protection category IP55) on outside of duct.

■ **Installation**

Installation possible in any position. Condensate drain holes in the motor depending on usage are possible upon request.

■ **Motor protection**

All types are equipped with thermal contacts. These should be wired with the motor protection circuit breaker (see type table) for effective motor protection.

■ **Noise levels**

See performance diagram. The sound power and sound pressure at 4 m distance under free field conditions are specified for the average operating point on the inlet/outlet side. See page 10 f for noise emissions and room acoustics.

Reference	Page
Selection table	221
Planning information	10 ff.

■ **Special design**

Different voltage, frequency, protection category, higher air flow temperature and acid protection upon request.

Other accessories	Page
Installation accessories	268 ff.
Silencers	486 ff.
Switching and control technology	591 ff.

Type	Ref. no.	Speed min ⁻¹	Flow rate free blowing V m ³ /h	Power consump. kW	Voltage V	Current consumption		Wiring diagram No.	Max. air flow temp.		Weight net aprx. kg	Speed controller 5-step		Frequency inverter with integrated sine filter		
						at rated voltage A	with control A		at rated voltage + °C	with control + °C		Type	Ref. no.	Type	Ref. no.	
Single-phase alternating current, 50 Hz, protection category IP54																
AMW 280/4	02254	1345	1930	0.1	230	0.5	0.5	966.1	60	40	11.5	MWS 1.5 ¹⁾	01947	—	—	—
AMW 280/2	02255	2755	3970	0.7	230	3.2	4.3	976.1	60	40	15.5	MWS 5 ¹⁾	01949	—	—	—
Three-phase current, 50 Hz, protection category IP54																
AMD 280/4	02256	1385	2000	0.1	400	0.3	0.3	469	60	40	10.5	RDS 1 ¹⁾	01314	—	—	—
AMD 280/2	02257	2745	3960	0.7	400	1.4	1.5	469	60	40	13.8	RDS 2 ¹⁾	01315	FU-BS 2.5	05459	—

¹⁾ incl. motor protection circuit breaker.

Performance curves AMD and AMW 280/2

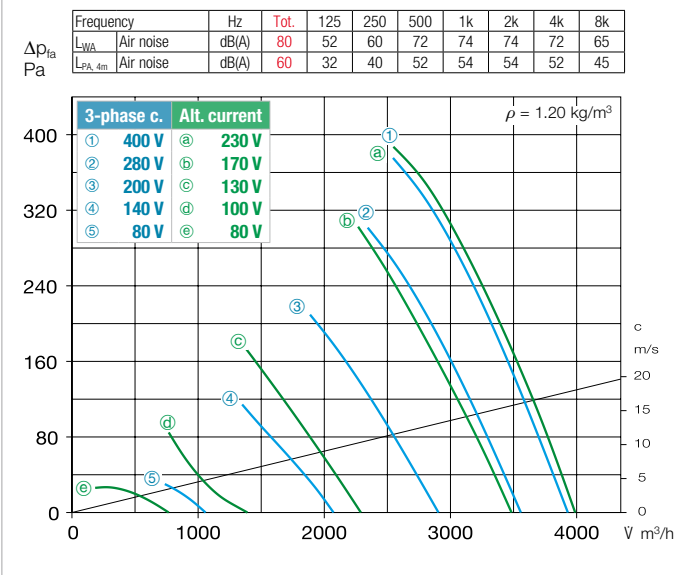

Performance curves AMD and AMW 280/4

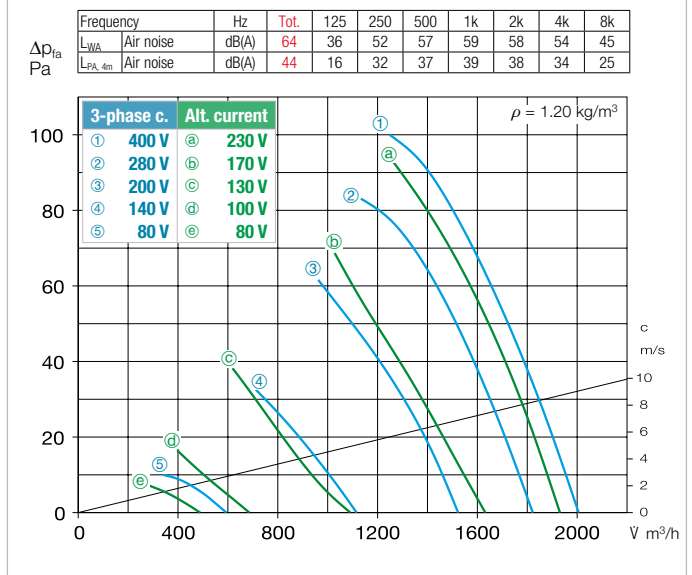

* Three-phase current noise data. Alternating current noise data see www.HeliosSelect.de.

Accessories AMD and AMW 280

Intake nozzle with prot. grille ASD-SGD 280 No. 01415	Extension duct VR 280 No. 01403	Duct silencer RSD 280/..	Duct shutter, automatic RVS 280^{a)} No. 02593	Flanged flexible connector STS 280 No. 01231	Counter flange FR 280 No. 01214	Flat flange FF 280 No. 04942	Flexible connecting sleeve FM 280 No. 01673	Protection grille duct side SG 280 No. 01428	Mounting brackets MK 280 (1 Set = 2 pcs) No. 01447	Vibration dampers for tensile load SDZ 1* (1 set = 4 Pc) No. 01454 Vibration dampers for compression load SDD 1* (1 set = 4 Pc) No. 01452
--	--	------------------------------------	---	---	--	---	--	---	--	--

^{a)} Shutter, motorised see Accessories product pages. * Type assignment see table, last column.

Motor protection circuit breaker for connecting built-in thermal contacts		Vibration dampers			
		Compression		Tension	
Type	Ref. no.	Type	Ref. no.	Type	Ref. no.
MW	01579	SDD 1	01452	SDZ 1	01454
MW	01579	SDD 1	01452	SDZ 1	01454
MD	05849	SDD 1	01452	SDZ 1	01454
MD	05849	SDD 1	01452	SDZ 1	01454

AMD and AMW 315



Dimensions AMD and AMW 315

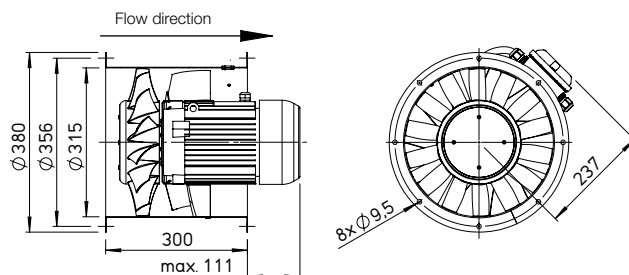

Dim. in mm

■ **Casing**

Duct with double-sided flange DIN 24155 p. 3. Made of galvanised steel sheet, fixed guide wheel with inner hub for mounting the flange motor.

■ **Impeller / guide wheel**

Impeller with 3D profiled blades and integrated flow geometry made of high-quality plastic. An optimised guide wheel made of galvanised steel is connected to the impeller. The impeller and guide wheel are efficiency-optimised and pressure-optimised for high volume flows by means of CFD. Dynamically balanced in accordance with ISO 21940-11. Operating range -30 to +60 °C.

■ **Drive**

Directly through maintenance-free flange motor. Closed design type IP54. Aluminium casing with cooling fins. Radio interference-free, sealed ball bearings. With condensate drain holes upon request and the installation method must be indicated when placing the order. Tropicalised winding with moisture proof coating upon request.

■ **Power control**

The voltage-controllable types are identified in the "Current consumption with control mode" column with a value which must be observed when determining the controller (see "speed controller" column). The flow rates are shown in the performance diagram. The planned use of a frequency inverter without a sine filter should be indicated when placing the order. This requires a change of fan version and additional costs, if necessary.

■ **Electrical connection**

Standard terminal box (protection category IP55) on outside of duct.

■ **Installation**

Installation possible in any position. Condensate drain holes in the motor depending on usage are possible upon request.

■ **Motor protection**

All types are equipped with thermal contacts. These should be wired with the motor protection circuit breaker (see type table) for effective motor protection.

■ **Noise levels**

See performance diagram. The sound power and sound pressure at 4 m distance under free field conditions are specified for the average operating point on the inlet/outlet side. See page 10 f for noise emissions and room acoustics.

Reference	Page
Selection table	221
Planning information	10 ff.

■ **Special design**

Different voltage, frequency, protection category, higher air flow temperature and acid protection upon request.

Other accessories	Page
Installation accessories	268 ff.
Silencers	486 ff.
Switching and control technology	591 ff.

Type	Ref. no.	Speed min ⁻¹	Flow rate free blowing V m ³ /h	Power consump. kW	Voltage V	Current consumption		Wiring diagram No.	Max. air flow temp.		Weight net aprx. kg	Speed controller 5-step		Frequency inverter with integrated sine filter	
						at rated voltage A	with control A		at rated voltage + °C	with control + °C		Type	Ref. no.	Type	Ref. no.
Single-phase alternating current, 50 Hz, protection category IP54															
AMW 315/4	02265	1395	2860	0.2	230	1	1.1	966.1	60	40	13.1	MWS 1.5 ¹⁾	01947	—	—
Three-phase current, 50 Hz, protection category IP54															
AMD 315/4	02266	1455	2950	0.2	400	0.6	0.6	469	60	40	12.2	RDS 1 ¹⁾	01314	—	—
Two-speed, three-phase current, 50 Hz, Y/Δ connection, protection category IP54															
AMD 315/2/2	02267	2200/2650	4450/5450	0.7/1.1	400/400	1.6/2.5	2.3	520	60	40	18.5	RDS 4 ¹⁾	01316	FU-BS 5.0	05460

¹⁾ incl. motor protection circuit breaker.

Performance curves AMD 315/2

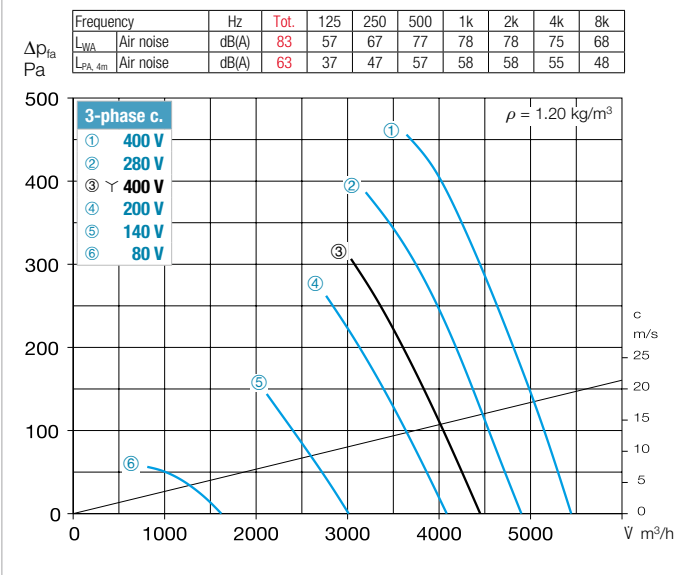

Performance curves AMD and AMW 315/4

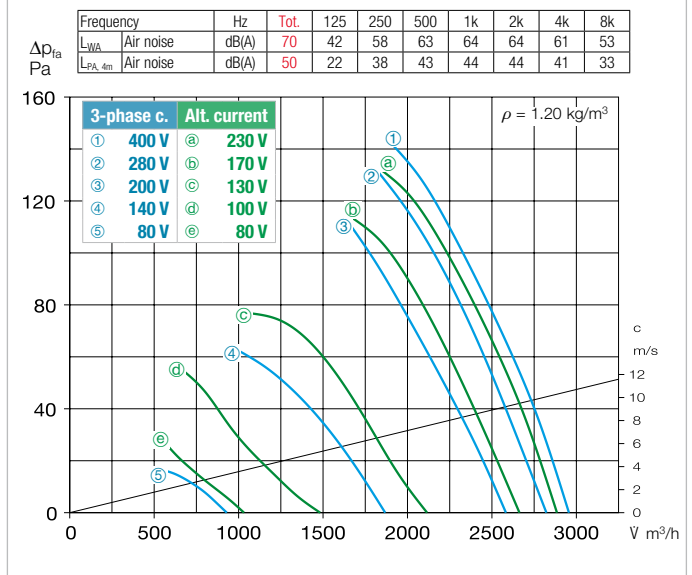

* Three-phase current noise data. Alternating current noise data see www.HeliosSelect.de.

Accessories AMD and AMW 315

Intake nozzle with prot. grille ASD-SGD 315 No. 01416	Extension duct VR 315 No. 01404	Duct silencer RSD 315/..	Duct shutter, automatic RVS 315^{a)} No. 02594	Flanged flexible connector STS 315 No. 01221	Counter flange FR 315 No. 01204	Flat flange FF 315 No. 04943	Flexible connecting sleeve FM 315 No. 01674	Protection grille duct side SG 315 No. 01237	Mounting brackets MK 315 (1 Set = 2 pcs) No. 01448	Mounting ring for vertical attachment MRV 315 No. 01755
--	--	------------------------------------	---	---	--	---	--	---	--	--

^{a)} Shutter, motorised see Accessories product pages. * Type assignment see table, last column.

		Vibration dampers			
		Compression		Tension	
Motor protection circuit breaker for connecting built-in thermal contacts	Ref. no.	Type	Ref. no.	Type	Ref. no.
MW	01579	SDD 1	01452	SDZ 1	01454
MD	05849	SDD 1	01452	SDZ 1	01454
M 4	01571	SDD 1	01452	SDZ 1	01454

AMD and AMW 355



Dimensions AMD and AMW 355

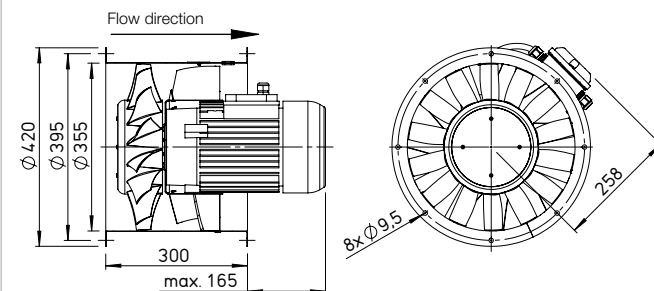

Dim. in mm

■ Casing

Duct with double-sided flange DIN 24155 p. 3. Made of galvanized steel sheet, fixed guide wheel with inner hub for mounting the flange motor.

■ Impeller / guide wheel

Impeller with 3D profiled blades and integrated flow geometry made of high-quality plastic. An optimised guide wheel made of galvanised steel is connected to the impeller. The impeller and guide wheel are efficiency-optimised and pressure-optimised for high volume flows by means of CFD. Dynamically balanced in accordance with ISO 21940-11. Operating range -30 to +60 °C.

■ Drive

Directly through maintenance-free flange motor. Closed design type IP54. Aluminium casing with cooling fins. Radio interference-free, sealed ball bearings. With condensate drain holes upon request and the installation method must be indicated when placing the order. Tropicalised winding with moisture proof coating upon request.

■ Power control

The voltage-controllable types are identified in the "Current consumption with control mode" column with a value which must be observed when determining the controller (see "speed controller" column). The flow rates are shown in the performance diagram. The planned use of a frequency inverter without a sine filter should be indicated when placing the order. This requires a change of fan version and additional costs, if necessary.

■ Electrical connection

Standard terminal box (protection category IP55) on outside of duct.

■ Installation

Installation possible in any position. Condensate drain holes in the motor depending on usage are possible upon request.

■ Motor protection

All types are equipped with thermal contacts. These should be wired with the motor protection circuit breaker (see type table) for effective motor protection.

■ Noise levels

See performance diagram. The sound power and sound pressure at 4 m distance under free field conditions are specified for the average operating point on the inlet/outlet side. See page 10 f for noise emissions and room acoustics.

Reference	Page
Selection table	221
Planning information	10 ff.

■ Special design

Different voltage, frequency, protection category, higher air flow temperature and acid protection upon request.

Other accessories	Page
Installation accessories	268 ff.
Silencers	486 ff.
Switching and control technology	591 ff.

Type	Ref. no.	Speed min ⁻¹	Flow rate free blowing V m ³ /h	Power consump. kW	Voltage V	Current consumption		Wiring diagram No.	Max. air flow temp.		Weight net aprx. kg	Speed controller 5-step		Frequency inverter with integrated sine filter	
						at rated voltage A	with control A		at rated voltage + °C	with control + °C		Type	Ref. no.	Type	Ref. no.
Single-phase alternating current, 50 Hz, protection category IP54															
AMW 355/4	02275	1430	4170	0.4	230	1.8	2.4	968.1	60	40	16.9	MWS 3 ¹⁾	01948	—	—
Three-phase current, 50 Hz, protection category IP54															
AMD 355/4	02276	1445	4300	0.35	400	0.9	1.1	469	60	40	15.7	RDS 2 ¹⁾	01315	FU-BS 2.5	05459
Two-speed, three-phase current, 50 Hz, Y/Δ connection, protection category IP54															
AMD 355/2/2	02277	2200/2775	8610/7640	1.3/2.3	400/400	3.0/5.4	5.6	520	60	40	30.3	RDS 7 ¹⁾	01578	FU-BS 8.0	05461

¹⁾ incl. motor protection circuit breaker.

Performance curves AMD 355/2

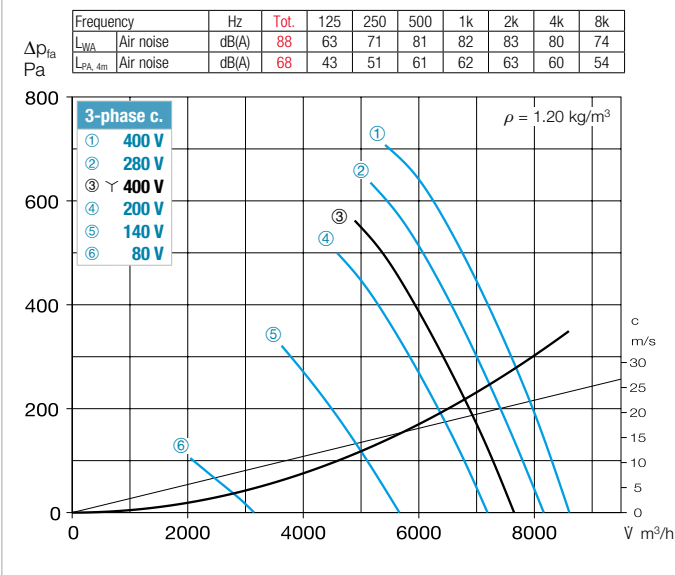

Performance curves AMD and AMW 355/4

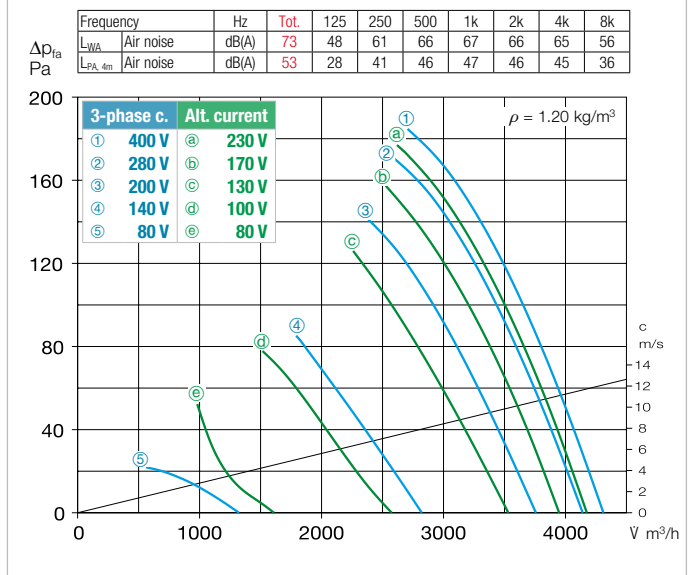

* Three-phase current noise data. Alternating current noise data see www.HeliosSelect.de.

Accessories AMD and AMW 355

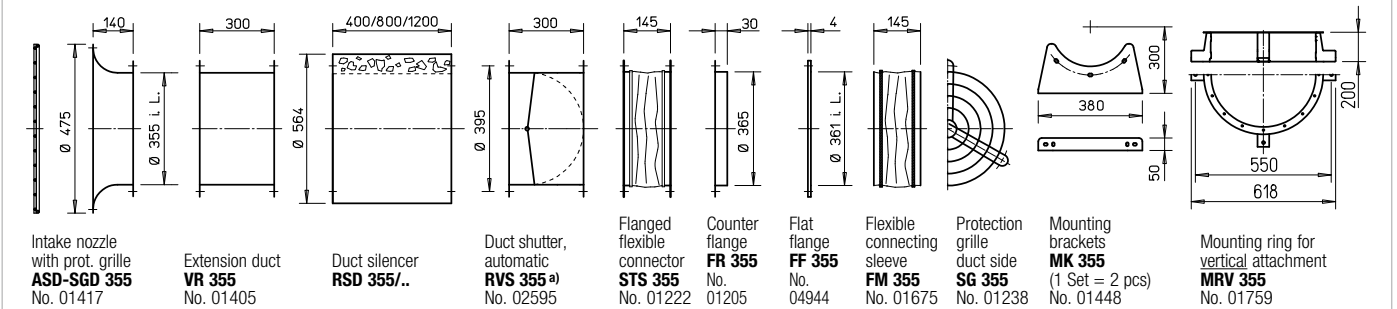

a) Shutter, motorised see Accessories product pages. * Type assignment see table, last column.

Motor protection circuit breaker for connecting built-in thermal contacts		Vibration dampers			
		Compression		Tension	
Type	Ref. no.	Type	Ref. no.	Type	Ref. no.
MW	01579	SDD 1	01452	SDZ 1	01454
MD	05849	SDD 1	01452	SDZ 1	01454
M 4	01571	SDD 1	01452	SDZ 1	01454

Axial and VAR fans

AMD and AMW 400



Dimensions AMD and AMW 400

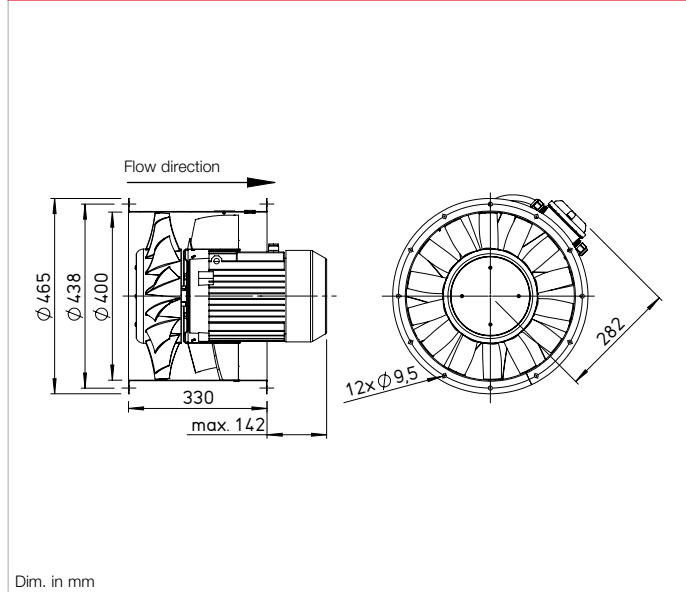

■ Casing

Duct with double-sided flange DIN 24155 p. 3. Made of galvanised steel sheet, fixed guide wheel with inner hub for mounting the flange motor.

■ Impeller / guide wheel

Impeller with 3D profiled blades and integrated flow geometry made of high-quality plastic. An optimised guide wheel made of galvanised steel is connected to the impeller. The impeller and guide wheel are efficiency-optimised and pressure-optimised for high volume flows by means of CFD. Dynamically balanced in accordance with ISO 21940-11. Operating range -30 to +60 °C.

■ Drive

Directly through maintenance-free flange motor. Closed design type IP54. Aluminium casing with cooling fins. Radio interference-free, sealed ball bearings. With condensate drain holes upon request and the installation method must be indicated when placing the order. Tropicalised winding with moisture proof coating upon request.

■ Power control

The voltage-controllable types are identified in the "Current consumption with control mode" column with a value which must be observed when determining the controller (see "speed controller" column). The flow rates are shown in the performance diagram. The planned use of a frequency inverter without a sine filter should be indicated when placing the order. This requires a change of fan version and additional costs, if necessary.

■ Electrical connection

Standard terminal box (protection category IP55) on outside of duct.

■ Installation

Installation possible in any position. Condensate drain holes in the motor depending on usage are possible upon request.

■ Motor protection

All types are equipped with thermal contacts. These should be wired with the motor protection circuit breaker (see type table) for effective motor protection.

■ Noise levels

See performance diagram. The sound power and sound pressure at 4 m distance under free field conditions are specified for the average operating point on the inlet/outlet side. See page 10 f for noise emissions and room acoustics.

Reference	Page
Selection table	221
Planning information	10 ff.
Special design	
Different voltage, frequency, protection category, higher air flow temperature and acid protection upon request.	

Other accessories	Page
Installation accessories	268 ff.
Silencers	486 ff.
Switching and control technology	591 ff.

Type	Ref. no.	Speed min ⁻¹	Flow rate free blowing V m ³ /h	Power consump. kW	Voltage V	Current consumption		Wiring diagram No.	Max. air flow temp.		Weight net aprx. kg	Speed controller 5-step		Frequency inverter with integrated sine filter	
						at rated voltage A	with control A		at rated voltage + °C	with control + °C		Type	Ref. no.	Type	Ref. no.
Single-phase alternating current, 50 Hz, protection category IP54															
AMW 400/4	02280	1395	6000	0.6	230	2.6	3.1	967.1	60	40	23.2	MWS 5 ¹⁾	01949	—	—
Three-phase current, 50 Hz, protection category IP54															
AMD 400/4	02281	1420	5980	0.6	400	1.9	2	469	60	40	22.0	RDS 4 ¹⁾	01316	FU-BS 2.5	05459
Two-speed, three-phase current, 50 Hz, Y/Δ connection, protection category IP54															
AMD 400/2/2	02282	2280/2780	10880/12430	2.4/4.4	400/400	5.5/9.5	9.5	520	50	30	44.9	RDS 11 ¹⁾	01332	FU-BS 14	05463

¹⁾ incl. motor protection circuit breaker.

Performance curves AMD 400/2

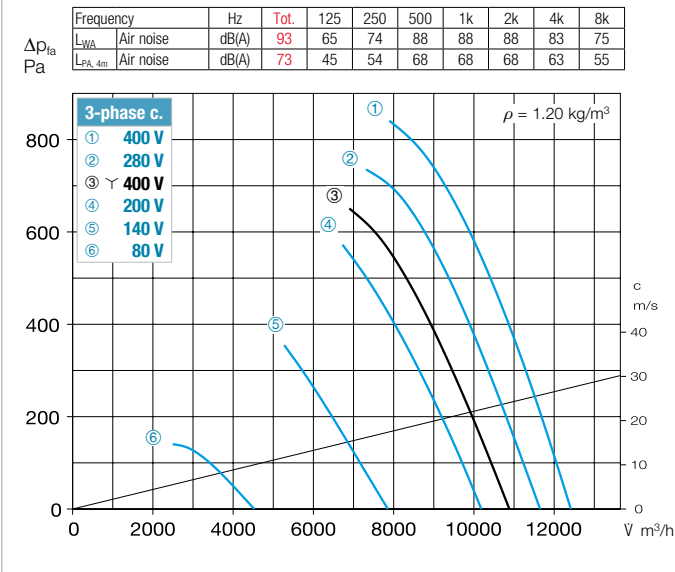

Performance curves AMD and AMW 400/4

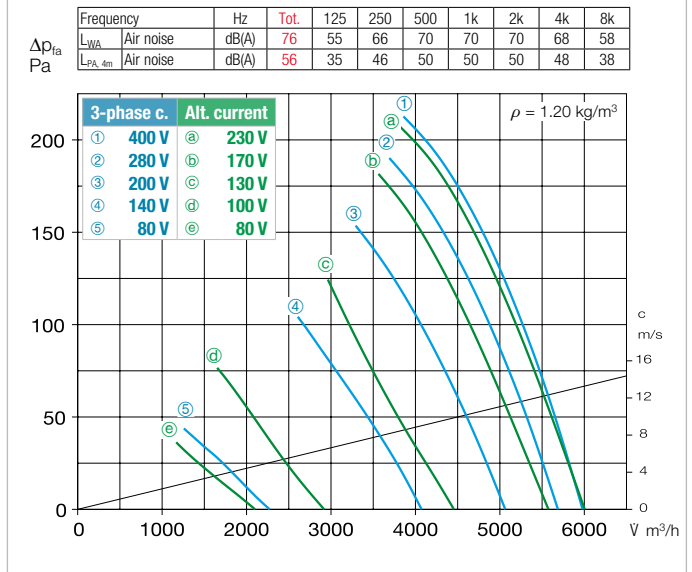

* Three-phase current noise data. Alternating current noise data see www.HeliosSelect.de.

Accessories AMD and AMW 200

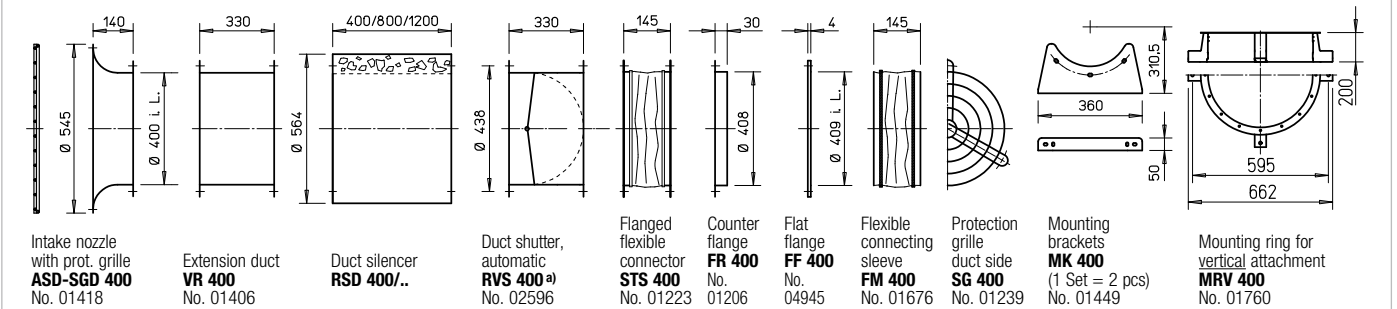

^{a)} Shutter, motorised see Accessories product pages. * Type assignment see table, last column.

Motor protection circuit breaker for connecting built-in thermal contacts		Vibration dampers			
		Compression		Tension	
Type	Ref. no.	Type	Ref. no.	Type	Ref. no.
MW	01579	SDD 1	01452	SDZ 1	01454
MD	05849	SDD 1	01452	SDZ 1	01454
M 4	01571	SDD 1	01452	SDZ 1	01454

Discover the Helios TGA catalogue.

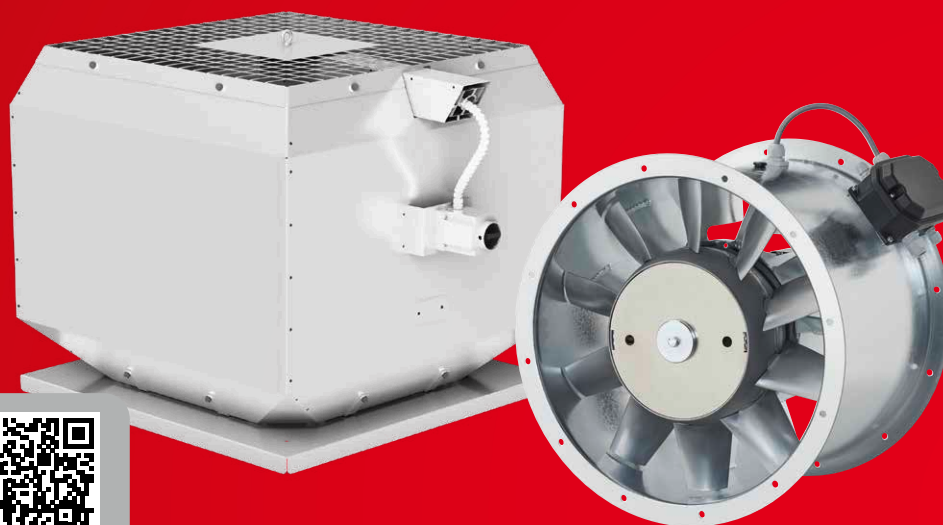
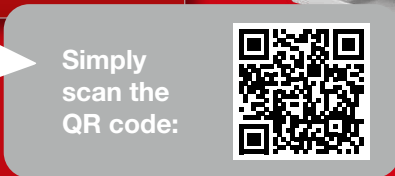

Axial and RADAX® VAR fans

The Helios TGA range includes low pressure and medium pressure axial fans as well as RADAX® VAR high pressure round duct fans in ND 280 to 1250 mm, $V = 1000 - 150\,000$ m³/h for smoke extraction applications with air flow temperatures of 300 °C, 400 °C and 600 °C over 120 min. (F300, F400, F600) or 40 °C for continuous ventilation.

Jet fans

Jet fans are used in parking garages for supply and extract ventilation and they ensure smoke extraction in case of fire.

Low-noise and universally applicable, the Helios axial jet fans set new standards in terms of thrust and weight. The centrifugal models excel on account of their ultra-flat, compact lightweight design and they are ideal when space is limited.

Smoke extraction roof fans and rectangular duct fans

Smoke extraction roof fans are available in ND 315 to 900 mm with flow rates from 1000 to 70 000 m³/h. The versions in temperature class F400 and F600 allow use in mechanical smoke extraction systems.

These fans can also be used for daily ventilation. Smoke extraction rectangular duct fans for rectangular ducts and connectors are ideal for applications with air flow temperatures of 400 °C/120 min.

Smoke protection pressure systems

In case of fire, smoke protection pressure systems (RDA) and stairway scavenging air systems (TSA) ensure life-saving smoke extraction in stairways and fire service lifts. The Helios RDA/TSA concept has a modular structure. The entire system is assembled in just a few steps with pre-configured packages. This guarantees smooth planning, installation and commissioning as well as completely secure system operation.



Request TGA catalogue
Ref. no. 86 979

■ Casing

- Tubular casing with welded-in motor support plate and guide wheel made of steel sheet. Flanges pressed on both sides according to DIN 24155, p. 3, for direct intermediate flanges in pipelines.
- Surface protection from hot-dip galvanising.

■ Impeller

- Hub and blades made of corrosion-resistant aluminium alloy.
- Dynamically balanced according to DIN ISO 21940-11, quality grade 6.3 for low-vibration operation.
- Ten aerodynamically profiled blades achieve the highest levels of efficiency and pressure rates in combination with the guide wheel.
- The angle of attack of the blades can be adjusted in the factory according to the ordered, optimal operating point.

■ Drive

- With regard to single-speed fans with a three-phase current motor and rated motor power ≤ 2.20 kW, the connection for direct start-up is provided (star-delta start-up for fans with rated motor power ≥ 3.00 kW).

□ AMD series

Directly through efficient IE 3 three-phase current standard motor. Pole-changeable fans with IEC standard motor. Protection category IP55, insulation class F.

■ Power control

Continuously variable (0-100 %) through the use of a frequency inverter. The planned use of a frequency inverter without a sine filter should be indicated when placing the order. This requires a change of fan version and additional costs, if necessary.

■ Motor protrusion

- The motor protrudes over the casing for some types. The protrusion dim. B in mm pursuant to the type table must be taken into account.

■ Motor protection

- All AMD types come with PTC thermistors as standard motor protection. Effective motor protection is possible by means of motor protection circuit breaker (type MSA, Ref. no. 01289, accessories) or FU (accessories).

■ Electrical connection

- Standard terminal box (protection category IP55) made of plastic, mounted on the outside of the fan casing.

■ Order data

The desired angle of attack must be specified when ordering.

Example:
AMD 355/2 1.5 kW 34°

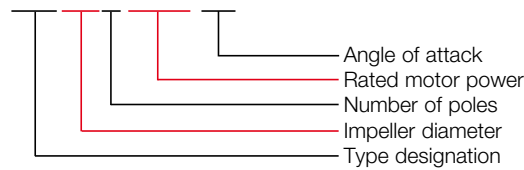

■ Air flow temperatures

- For supply and extract ventilation from -20 °C to $+60$ °C continuous temperature. Types for higher air flow temperatures upon request.

■ Air flow direction

- The fans are designed with air flow direction B = outlet over motor (Figure 1).

■ Noise levels

- The sound power values are specified over the frequency and as total levels for various angles of attack above the performance curves on the product pages.

■ Installation

- Horizontal and vertical installation depending on installation location.
- The use of vibration dampers (accessories) is recommended to prevent vibration transmission.

□ Duct installation (tipping over)

An extension duct (type VR, accessories) must be provided (Figure 2) to prevent the tendency of tipping over when installing medium pressure axial fans with inlet-side and outlet-side flanged flexible connectors (type STS, accessories).

□ Duct installation

Arrangement of mounting brackets (type MK) for horizontal attachment or a mounting ring (type MRV) for vertical attachment to the fan with vibration dampers. Use of vibration dampers for compression (type SDD, accessories) or tensile loads (type SDZ, accessories, for ceiling suspension). Inlet-side and outlet-side flanged flexible connectors (type STS, accessories) must be provided (Figure 3) to prevent the transmission of noise and vibrations.

□ Duct installation with inlet-side and outlet-side silencers

On-site brackets are necessary for attaching the silencers and supporting the weight depending on the local conditions. The inlet-side silencer must be provided with flanged flexible connectors (type STS, accessories) at the inlet (Figure 4) and the outlet-side silencer must be provided with these at the outlet.

Figure 1

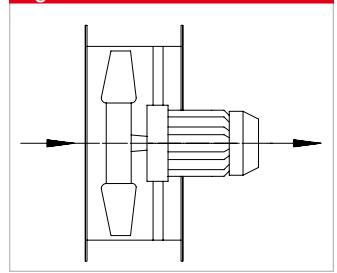

Figure 2

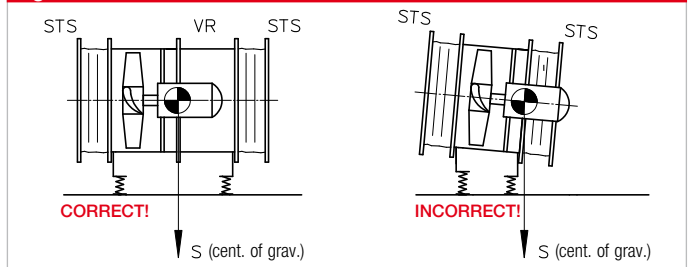

Figure 3

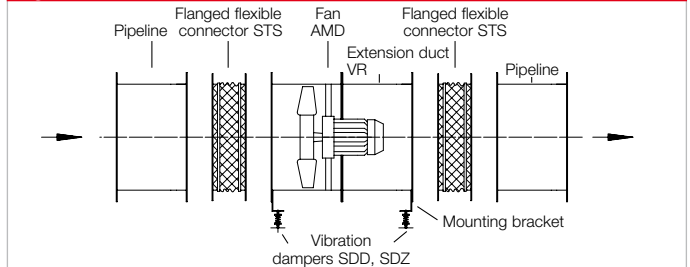

Figure 4

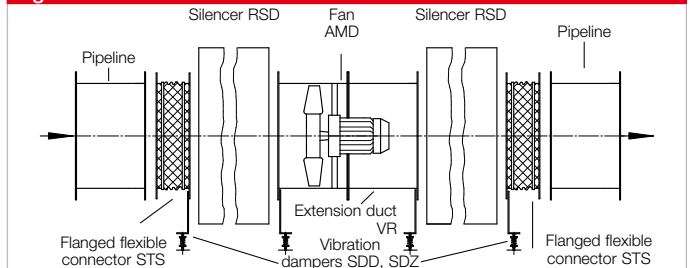
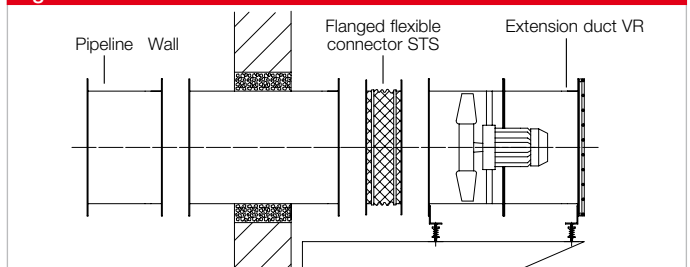

Figure 5



□ Wall installation (horizontal)

On on-site bracket. Wall outlet with round duct or rectangular duct, wall with mineral wool. Inlet-side and outlet-side flanged flexible connector (type STS, accessories) with extension duct (type VR, accessories) and protection grille (type SG, accessories) (Figure 5).

■ Reference

Page

Planning information	10 ff.
Installation accessories	268 ff.
Silencers	486
Speed controllers, pole changing switches	591 ff.

AMD 450



Dimensions AMD 450

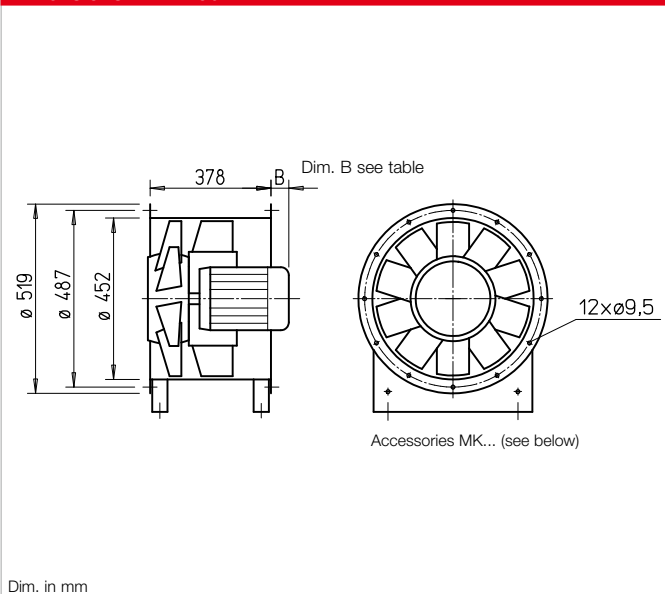

Casing

Tubular casing with welded-in motor support plate and guide wheel made of steel sheet. Flanges pressed on both sides according to DIN 24155, p. 3, for direct intermediate flanges in pipelines. Surface protection from hot-dip galvanising.

Impeller

Hub and blades made of corrosion-resistant aluminium alloy. Dynamically balanced according to DIN ISO 21940-11, quality grade 6.3 for low-vibration operation. Ten aerodynamically profiled blades achieve the highest levels of efficiency and pressure rates in combination with the guide wheel. The angle of attack of the blades can be adjusted in the factory according to the ordered, optimal operating point.

Drive

Directly through efficient IE 3 three-phase current standard motor. Pole-changeable fans with IEC standard motor. Protection category IP55, insulation class F.

Power control

Continuously variable (0-100 %) through the use of a frequency inverter. The planned use of a frequency inverter without a sine filter should be indicated when placing the order. This requires a change of fan version and additional costs, if necessary.

Electrical connection

Standard terminal box (protection category IP55) made of plastic, mounted on the outside of the fan casing.

Motor protection

All AMD types come with PTC thermistors as standard motor protection. Effective motor protection is possible by means of motor protection circuit breaker (type MSA, Ref. no. 01289, accessories) or FU (accessories).

Dimensions

The motor protrudes over the casing for some types. The protrusion dim. B in mm pursuant to the type table must be taken into account.

Noise levels

The sound power values are specified over the frequency and as total levels for various angles of attack above the performance curves on the product pages.

Reference Page

Planning information 10 ff.

Special design

Special design w/ inspect. opening (extra charge) upon request.

Other accessories Page

Installation accessories 268 ff.

Silencers 488 ff.

Switching and control technology 591 ff.

Type	Ref. no.	Speed	Rated motor power (output)	Voltage	Current consump. nominal	Dim. B Motor protrusion	Wiring diagram	Max. air flow temp.	Weight net	Frequency inverter with integrated sine filter	Motor protection circuit breaker or pole changing switch
		min ⁻¹	kW	V	A	mm	No.	+ °C	kg	Type Ref. no.	Type Ref. no.
Three-phase current, 400 V, 50 Hz, protection category IP55											
AMD 450/4 0.75 kW	03109	1430	0.75	400	1.8	15	796	60	40	FU-BS 2.5 05459	MSA 01289
AMD 450/4 1.1 kW	03110	1440	1.1	400	2.5	40	796	60	44	FU-BS 5.0 05460	MSA 01289
AMD 450/4 2.2 kW	03106	2890	2.2	400	4.3	65	796	60	47	FU-BS 5.0 05460	MSA 01289
AMD 450/2 3 kW	03107	2880	3	400*	5.7	105	776	60	54	FU-BS 8.0 05461	MSA 01289
AMD 450/2 4 kW	03108	2910	4	400*	7.4	155	776	60	57	FU-BS 8.0 05461	MSA 01289
Pole-changeable, 2 speeds, three-phase current, Dahlander winding $\gamma/\gamma\gamma$, 400 V, 50 Hz, protection category IP55											Surface-mounted pole changing switch
AMD 450/4/2 0.65/2.5 kW	03121	1380/2855	0.65/2.5	400	1.9/5.0	40	777	60	61	— —	PDA 12 ¹⁾ 05081
AMD 450/4/2 0.8/3.1 kW	03111	1380/2860	0.8/3.1	400	2.1/6.1	65	777	60	61	— —	PDA 12 ¹⁾ 05081
AMD 450/4/2 1.1/4.4 kW	03113	1390/2860	1.1/4.4	400	3.0/8.7	155	777	60	67	— —	PDA 12 ¹⁾ 05081

The angle of attack must be specified when ordering. ¹⁾ Flush-m. version see Switch product page.

* γ/Δ Start-up.

Performance curves AMD 450/2

n=2900 1/min

Frequency	Hz	Tot.	125	250	500	1k	2k	4k	8k	
L _{WA}	10°	dB(A)	100	77	90	95	99	99	94	85
L _{WA}	20°	dB(A)	101	79	91	99	100	100	96	87
L _{WA}	30°	dB(A)	104	81	93	101	103	102	98	89

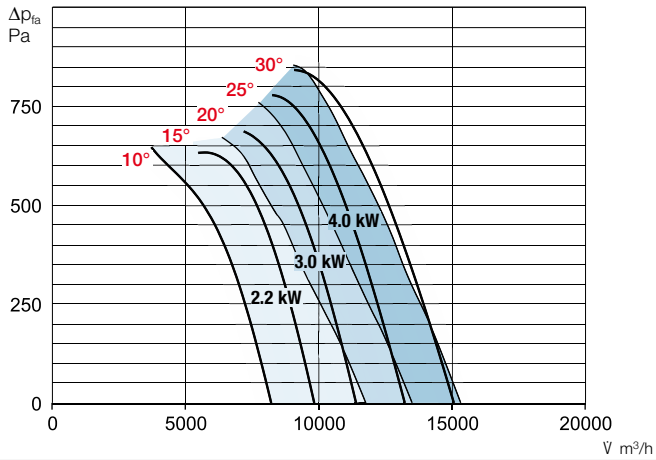

Performance curves AMD 450/4

n=1420 1/min

Frequency	Hz	Tot.	125	250	500	1k	2k	4k	8k	
L _{WA}	10°	dB(A)	83	68	78	81	82	80	73	61
L _{WA}	20°	dB(A)	85	69	79	84	84	82	74	63
L _{WA}	30°	dB(A)	86	71	81	83	85	82	76	65

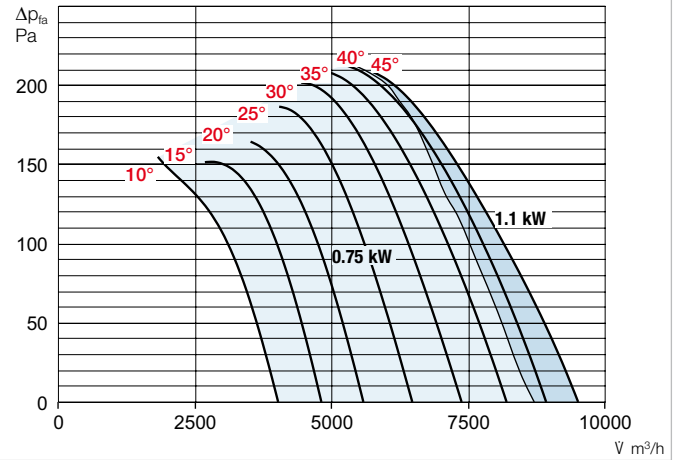

Accessories AMD 450

Intake nozzle with prot. grille **ASD-SGD 450** No. 01419

Extension duct **VR 450** No. 01407

Duct silencer **RSD 450/..**

Duct shutter **RVS 450^{a)}** No. 02597

Flanged flexible connector **STS 450** No. 01224

Counter flange **FR 450** No. 01207

Flat flange **FF 450** No. 04946

Protection grille duct side **SG 450** No. 01240

Mounting brackets **MK 400-450** (1 Set = 2 pcs) No. 01449

Mounting ring for vertical attachment **MRV 450** No. 01761

^{a)} Shutter, motorised, see Accessories product page.

Vibration dampers			
Compression		Tension	
Type	Ref. no.	Type	Ref. no.
SDD 1	01452	SDZ 1	01454
SDD 1	01452	SDZ 1	01454
SDD 1	01452	SDZ 1	01454
SDD 1	01452	SDZ 1	01454
SDD 1	01452	SDZ 1	01454
SDD 1	01452	SDZ 2	01455
SDD 1	01452	SDZ 2	01455
SDD 1	01452	SDZ 2	01455

Axial and VAR fans

AMD 500



Dimensions AMD 500

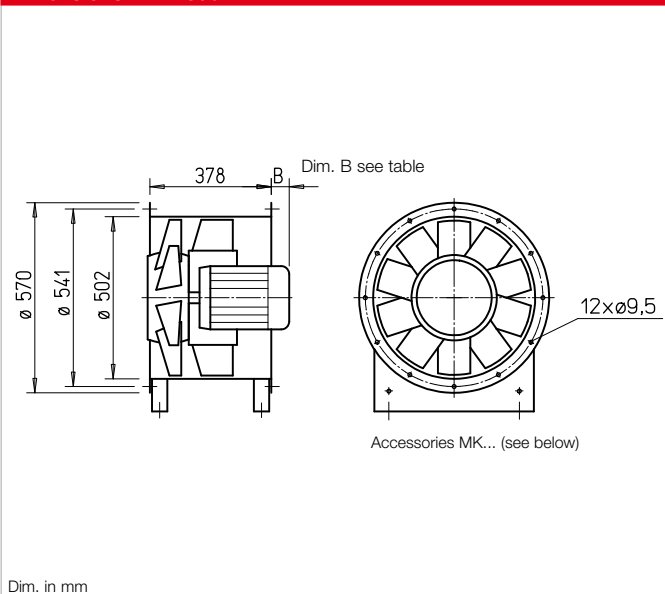

Casing

Tubular casing with welded-in motor support plate and guide wheel made of steel sheet. Flanges pressed on both sides according to DIN 24155, p. 3, for direct intermediate flanges in pipelines. Surface protection from hot-dip galvanising.

Impeller

Hub and blades made of corrosion-resistant aluminium alloy. Dynamically balanced according to DIN ISO 21940-11, quality grade 6.3 for low-vibration operation.

Ten aerodynamically profiled blades achieve the highest levels of efficiency and pressure rates in combination with the guide wheel. The angle of attack of the blades can be adjusted in the factory according to the ordered, optimal operating point.

Drive

Directly through efficient IE 3 three-phase current standard motor. Pole-changeable fans with IEC standard motor. Protection category IP55, insulation class F.

Power control

Continuously variable (0-100 %) through the use of a frequency inverter. The planned use of a frequency inverter without a sine filter should be indicated when placing the order. This requires a change of fan version and additional costs, if necessary.

Electrical connection

Standard terminal box (protection category IP55) made of plastic, mounted on the outside of the fan casing.

Motor protection

All AMD types come with PTC thermistors as standard motor protection. Effective motor protection is possible by means of motor protection circuit breaker (type MSA, Ref. no. 01289, accessories) or FU (accessories).

Dimensions

The motor protrudes over the casing for some types. The protrusion dim. B in mm pursuant to the type table must be taken into account.

Noise levels

The sound power values are specified over the frequency and as total levels for various angles of attack above the performance curves on the product pages.

Reference Page

Planning information 10 ff.

Special design

Special design w/ inspect. opening (extra charge) upon request.

Other accessories Page

Installation accessories 268 ff.
Silencers 486 ff.
Switching and control technology 591 ff.

Type	Ref. no.	Speed	Rated motor power (output)	Voltage	Current consump. nominal	Dim. B Motor protrusion	Wiring diagram	Max. air flow temp.	Weight net	Frequency inverter with integrated sine filter		Motor protection circuit breaker or pole changing switch	
										Type	Ref. no.	Type	Ref. no.
Three-phase current, 400 V, 50 Hz, protection category IP55													
AMD 500/4 0.75 kW	03118	1430	0.75	400	1.8	35	796	60	46	FU-BS 2.5	05459	MSA	01289
AMD 500/4 1.1 kW	03119	1440	1.1	400	2.5	60	796	60	50	FU-BS 5.0	05460	MSA	01289
AMD 500/4 1.5 kW	03122	1440	1.5	400	3.3	85	796	60	53	FU-BS 5.0	05460	MSA	01289
AMD 500/2 4 kW	03115	2910	4	400*	7.4	175	776	60	83	FU-BS 8.0	05461	MSA	01289
AMD 500/2 5.5 kW	03116	2940	5.5	400*	10.1	180	776	60	97	FU-BS 16	05463	MSA	01289
AMD 500/2 7.5 kW	03117	2930	7.5	400*	14.1	220	776	60	102	FU-BS 16	05463	MSA	01289
Pole-changeable, 2 speeds, three-phase current, Dahlander winding $\gamma/\gamma\gamma$, 400 V, 50 Hz, protection category IP55											Surface-mounted pole changing switch		
AMD 500/8/4 0.22/1.0 kW ³⁾	03275	645/1390	0.22/1.0	400	0.9/2.4	60	777	60	55	—	—	PDA 12 ¹⁾	05081
AMD 500/8/4 0.3/1.5 kW ³⁾	03276	645/1390	0.3/1.5	400	1.1/3.0	85	777	60	58	—	—	PDA 12 ¹⁾	05081
AMD 500/8/4 1.4/5.9 kW ³⁾	03273	1400/2900	1.4/5.9	400	3.6/11.4	180	777	60	118	—	—	PDA 12 ¹⁾	05081
AMD 500/8/4 2.0/8.0 kW ³⁾	03274	1410/2900	2.0/8.0	400	4.7/14.9	220	777	60	129	—	—	PDA 25	05060

The angle of attack must be specified when ordering.

* γ/Δ Start-up.

¹⁾ Flush-m. version see Switch product page.

²⁾ Extension duct VR over motor protrusion required.

³⁾ Performance curves for low speed available on request.

Performance curves AMD 500/2

n=2930 1/min

Frequency	Hz	Tot.	125	250	500	1k	2k	4k	8k
L _{WA} 10°	dB(A)	103	80	93	99	102	100	97	88
L _{WA} 20°	dB(A)	105	82	94	100	104	102	99	90
L _{WA} 30°	dB(A)	107	84	96	104	106	104	101	92

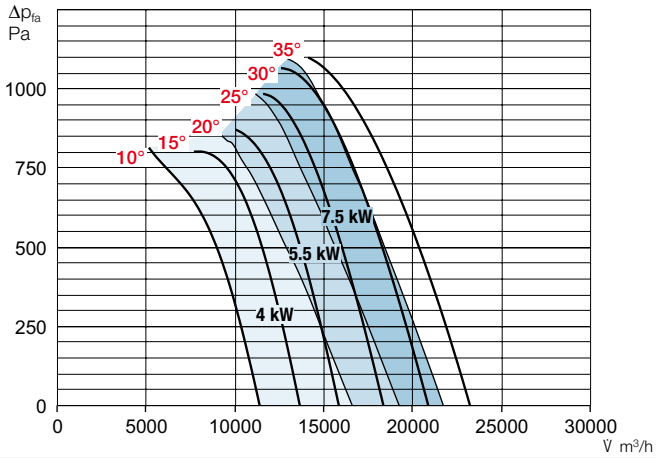

Performance curves AMD 500/4

n=1430 1/min

Frequency	Hz	Tot.	125	250	500	1k	2k	4k	8k
L _{WA} 10°	dB(A)	87	71	81	86	86	83	76	64
L _{WA} 20°	dB(A)	88	72	82	86	87	85	77	66
L _{WA} 30°	dB(A)	90	74	84	88	89	87	79	68

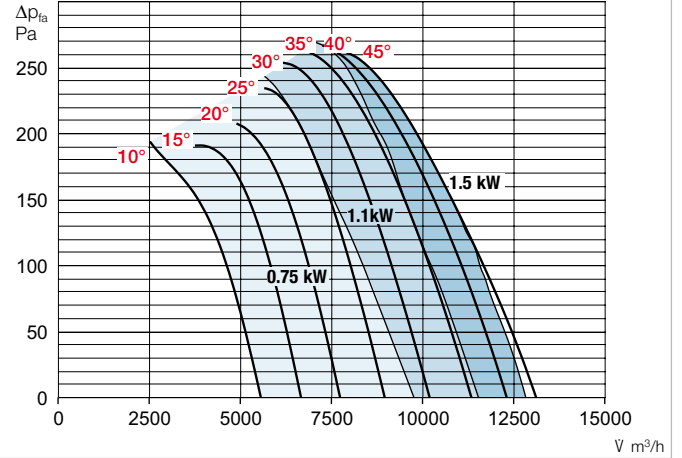

Accessories AMD 500

Intake nozzle with prot. grille ASD-SGD 500 No. 01420	Extension duct VR 500 No. 01408	Duct silencer RSD 500/..	Duct shutter RVS 500 a) No. 02598	Flanged flexible connector STS 500 No. 01225	Counter flange FR 500 No. 01208	Flat flange FF 500 No. 04947	Protection grille duct side SG 500 No. 01241	Mounting brackets MK 500 (1 Set = 2 pcs) No. 00674	Mounting ring for vertical attachment MRV 500 No. 01740

a) Shutter, motorised, see Accessories product page.

Vibration dampers		Compression		Tension	
Type	Ref. no.	Type	Ref. no.	Type	Ref. no.
SDD 1	01452	SDZ 1	01454		
SDD 1	01452	SDZ 1	01454		
SDD 1	01452	SDZ 1	01454		
SDD 2	01453	SDZ 2	01455		
SDD 2 ^{a)}	01453	SDZ 2 ^{a)}	01455		
SDD 2 ^{a)}	01453	SDZ 2 ^{a)}	01455		
SDD 1	01452	SDZ 1	01454		
SDD 1	01452	SDZ 2	01455		
SDD 2 ^{a)}	01453	SDZ 2 ^{a)}	01455		
SDD 2 ^{a)}	01453	SDZ 2 ^{a)}	01455		

AMD 560



Dimensions AMD 560

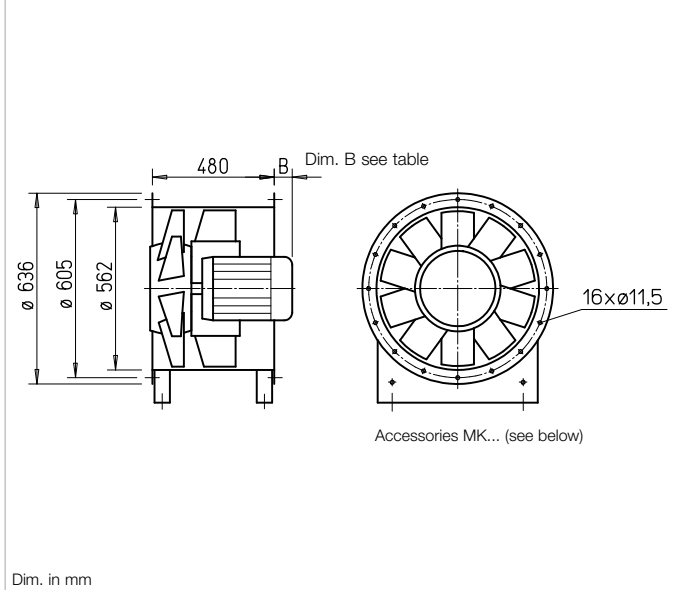

Casing

Tubular casing with welded-in motor support plate and guide wheel made of steel sheet. Flanges pressed on both sides according to DIN 24155, p. 3, for direct intermediate flanges in pipelines. Surface protection from hot-dip galvanising.

Impeller

Hub and blades made of corrosion-resistant aluminium alloy. Dynamically balanced according to DIN ISO 21940-11, quality grade 6.3 for low-vibration operation. Ten aerodynamically profiled blades achieve the highest levels of efficiency and pressure rates in combination with the guide wheel. The angle of attack of the blades can be adjusted in the factory according to the ordered, optimal operating point.

Drive

Directly through efficient IE 3 three-phase current standard motor. Pole-changeable fans with IEC standard motor. Protection category IP55, insulation class F.

Power control

Continuously variable (0-100 %) through the use of a frequency inverter. The planned use of a frequency inverter without a sine filter should be indicated when placing the order. This requires a change of fan version and additional costs, if necessary.

Electrical connection

Standard terminal box (protection category IP55) made of plastic, mounted on the outside of the fan casing.

Motor protection

All AMD types come with PTC thermistors as standard motor protection. Effective motor protection is possible by means of motor protection circuit breaker (type MSA, Ref. no. 01289, accessories) or FU (accessories).

Dimensions

The motor protrudes over the casing for some types. The protrusion dim. B in mm pursuant to the type table must be taken into account.

Noise levels

The sound power values are specified over the frequency and as total levels for various angles of attack above the performance curves on the product pages.

Reference	Page
Planning information	10 ff.
Special design	
Special design w/ inspect. opening (extra charge) upon request.	

Other accessories	Page
Installation accessories	268 ff.
Silencers	486 ff.
Switching and control technology	591 ff.

Type	Ref. no.	Speed	Rated motor power (output)	Voltage	Current consump. nominal	Dim. B Motor protrusion	Wiring diagram	Max. air flow temp.	Weight net	Frequency inverter with integrated sine filter	Motor protection circuit breaker or pole changing switch
		min ⁻¹	kW	V	A	mm	No.	+ °C	kg	Type	Ref. no.
Three-phase current, 400 V, 50 Hz, protection category IP55											
AMD 560/4 1.1 kW	03281	1440	1.1	400	2.5	0	796	60	61	FU-BS 5.0	05460
AMD 560/4 1.5 kW	03282	1440	1.5	400	3.3	0	796	60	64	FU-BS 5.0	05460
AMD 560/4 2.2 kW	03285	1455	2.2	400	4.5	40	796	60	74	FU-BS 5.0	05460
AMD 560/4 3 kW	03286	1440	3	400*	6.0	40	776	60	80	FU-BS 8.0	05461
AMD 560/2 7.5 kW	03279	2930	7.5	400*	14.1	100	776	60	123	FU-BS 16	05463
Pole-changeable, 2 speeds, three-phase current, Dahlander winding $\gamma/\gamma\gamma$, 400 V, 50 Hz, protection category IP55											
AMD 560/8/4 0.55/2.0 kW ²⁾	03272	680/1410	0.55/2.0	400	2.0/4.5	0	777	60	79	—	PDA 12 ¹⁾
AMD 560/8/4 0.65/2.4 kW ²⁾	03290	680/1410	0.65/2.4	400	2.5/5.5	40	777	60	79	—	PDA 12 ¹⁾
AMD 560/4/2 2.0/8.0 kW	03287	1410/2900	2.0/8.0	400	4.7/14.9	100	777	60	149	—	PDA 25

The angle of attack must be specified when ordering. ¹⁾ Flush-m. version see Switch product page.

²⁾ Performance curves for low speed available on request.

* γ/Δ Start-up.

Performance curves AMD 560/2

n=2930 1/min

Frequency	Hz	Tot.	125	250	500	1k	2k	4k	8k	
L _{WA}	10°	dB(A)	107	84	96	104	106	105	101	91
L _{WA}	20°	dB(A)	108	85	97	105	107	105	102	93
L _{WA}	30°	dB(A)	111	87	100	107	110	109	105	95

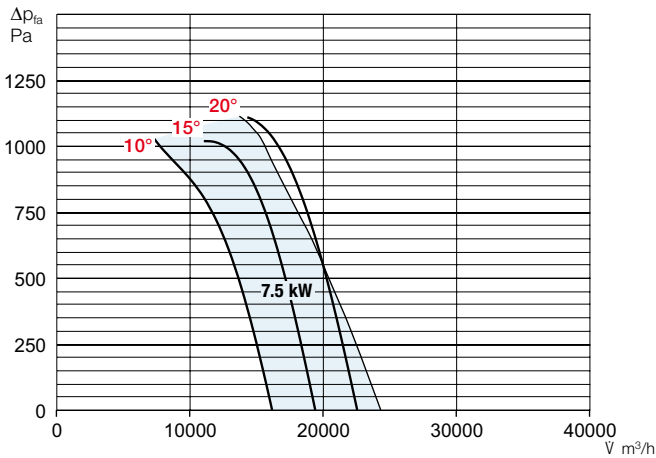

Performance curves AMD 560/4

n=1440 1/min

Frequency	Hz	Tot.	125	250	500	1k	2k	4k	8k	
L _{WA}	10°	dB(A)	90	74	84	89	89	87	79	68
L _{WA}	20°	dB(A)	92	76	85	91	91	88	81	69
L _{WA}	30°	dB(A)	93	77	87	91	92	90	82	71

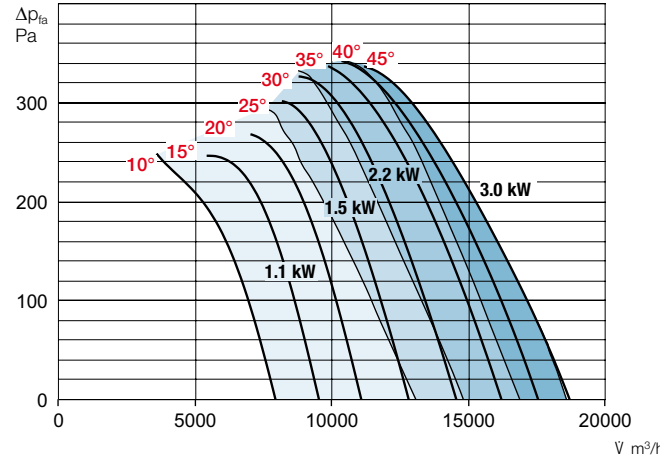

Accessories AMD 560

Intake nozzle with prot. grille **ASD-SGD 560** No. 01421

Extension duct **VR 560** No. 01409

Duct silencer **RSD 560/..**

Duct shutter **RVS 560** ^{a)} No. 02599

Flanged flexible connector **STS 560** No. 01226

Counter flange **FR 560** No. 01209

Flat flange **FF 560** No. 04948

Protection grille duct side **SG 560** No. 01242

Mounting brackets **MK 560** (1 Set = 2 pcs) No. 00675

Mounting ring for vertical attachment **MRV 560** No. 01741

^{a)} Shutter, motorised, see Accessories product page.

Axial and VAR fans

Vibration dampers			
Compression		Tension	
Type	Ref. no.	Type	Ref. no.
SDD 1	01452	SDZ 2	01455
SDD 1	01452	SDZ 2	01455
SDD 1	01452	SDZ 2	01455
SDD 2	01453	SDZ 2	01455
SDD 2	01453	SDZ 2	01455
SDD 2	01453	SDZ 2	01455
SDD 2	01453	SDZ 2	01455
SDD 2	01453	SDZ 2	01455
SDD 2	01453	SDZ 2	01455

AMD 630



Dimensions AMD 630

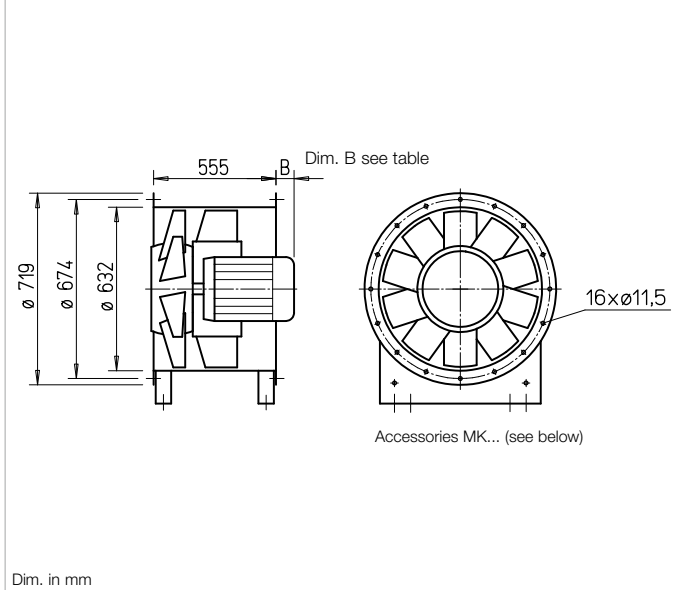

Casing

Tubular casing with welded-in motor support plate and guide wheel made of steel sheet. Flanges pressed on both sides according to DIN 24155, p. 3, for direct intermediate flanges in pipelines. Surface protection from hot-dip galvanising.

Impeller

Hub and blades made of corrosion-resistant aluminium alloy. Dynamically balanced according to DIN ISO 21940-11, quality grade 6.3 for low-vibration operation. Ten aerodynamically profiled blades achieve the highest levels of efficiency and pressure rates in combination with the guide wheel. The angle of attack of the blades can be adjusted in the factory according to the ordered, optimal operating point.

Drive

Directly through efficient IE 3 three-phase current standard motor. Pole-changeable fans with IEC standard motor. Protection category IP55, insulation class F.

Power control

Continuously variable (0-100 %) through the use of a frequency inverter. The planned use of a frequency inverter without a sine filter should be indicated when placing the order. This requires a change of fan version and additional costs, if necessary.

Electrical connection

Standard terminal box (protection category IP55) made of plastic, mounted on the outside of the fan casing.

Motor protection

All AMD types come with PTC thermistors as standard motor protection. Effective motor protection is possible by means of motor protection circuit breaker (type MSA, Ref. no. 01289, accessories) or FU (accessories).

Dimensions

The motor protrudes over the casing for some types. The protrusion dim. B in mm pursuant to the type table must be taken into account.

Noise levels

The sound power values are specified over the frequency and as total levels for various angles of attack above the performance curves on the product pages.

Reference	Page
Planning information	10 ff.
Special design	
Special design w/ inspect. opening (extra charge) upon request.	

Other accessories	Page
Installation accessories	268 ff.
Silencers	486 ff.
Switching and control technology	591 ff.

Type	Ref. no.	Speed	Rated motor power (output)	Voltage	Current consump. nominal	Dim. B Motor protrusion	Wiring diagram	Max. air flow temp.	Weight net	Frequency inverter with integrated sine filter	Motor protection circuit breaker or pole changing switch
		min ⁻¹	kW	V	A	mm	No.	+ °C	kg	Type Ref. no.	Type Ref. no.
Three-phase current, 400 V, 50 Hz, protection category IP55											
AMD 630/4 1.5 kW	03291	1440	1.5	400	3.3	0	796	60	84	FU-BS 5.0 05460	MSA 01289
AMD 630/4 2.2 kW	03292	1455	2.2	400	4.5	0	796	60	84	FU-BS 5.0 05460	MSA 01289
AMD 630/4 3 kW	03293	1440	3.0	400*	6.0	0	776	60	99	FU-BS 8.0 05461	MSA 01289
AMD 630/4 4 kW	03294	1500	4.0	400*	7.4	30	776	60	94	FU-BS 10 05462	MSA 01289
AMD 630/4 5.5 kW	03295	1470	5.0	400*	10.7	40	776	60	115	FU-BS 16 05463	MSA 01289
AMD 630/2 11 kW	03376	2945	11.0	400*	20.0	145	776	60	210	FU-CS 22 05470	MSA 01289
Pole-changeable, 2 speeds, three-phase current, Dahlander winding Δ/Δ, 400 V, 50 Hz, protection category IP55										Surface-mounted pole changing switch	
AMD 630/8/4 0.55/2.0 kW ²⁾	03297	680/1410	0.55/2.0	400	2.0/4.5	0	777	60	98	— —	PDA 12 ¹⁾ 05081
AMD 630/8/4 0.9/3.2 kW ²⁾	03298	680/1420	0.9/3.2	400	3.2/7.1	30	777	60	104	— —	PDA 12 ¹⁾ 05081
AMD 630/8/4 1.1/4.5 kW ²⁾	03299	680/1435	1.1/4.5	400	3.6/9.3	40	777	60	130	— —	PDA 12 ¹⁾ 05081

The angle of attack must be specified when ordering. ¹⁾ Flush-m. version see Switch product page.

²⁾ Performance curves for low speed available on request.

* Δ/Δ Start-up.

Performance curves AMD 630/2

n=2940 1/min

Frequency	Hz	Tot.	125	250	500	1k	2k	4k	8k
L _{WA} 10°		dB(A) 112	84	97	104	108	106	101	92
L _{WA} 20°		dB(A) 114	87	99	107	110	109	104	95
L _{WA} 30°		dB(A) 116	89	101	109	112	111	106	97

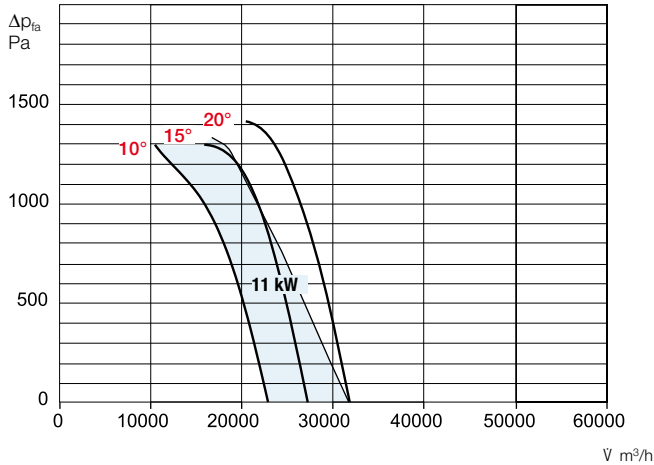

Performance curves AMD 630/4

n=1450 1/min

Frequency	Hz	Tot.	125	250	500	1k	2k	4k	8k
L _{WA} 10°		dB(A) 94	78	87	93	93	90	83	71
L _{WA} 20°		dB(A) 95	79	89	92	94	91	84	72
L _{WA} 30°		dB(A) 97	81	91	95	96	93	86	74

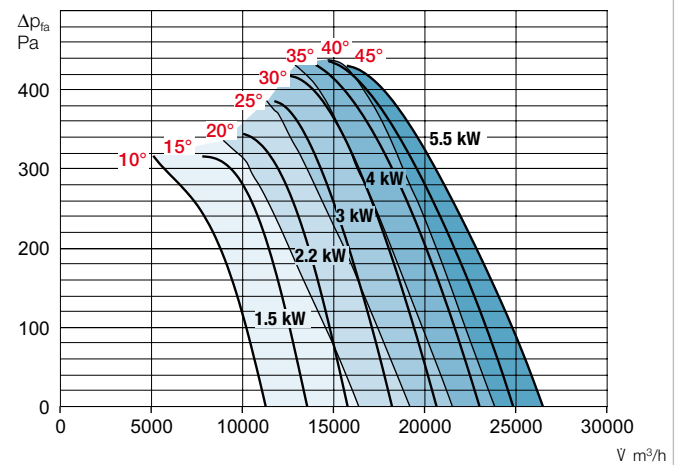

Accessories AMD 630

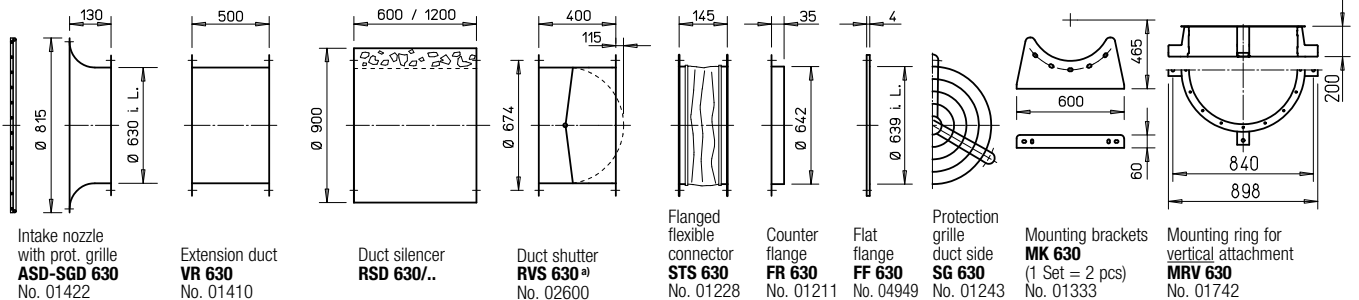

^{a)} Shutter, motorised, see Accessories product page.

Axial and VAR fans

		Vibration dampers	
		Compression	Tension
Type	Ref. no.	Type	Ref. no.
SDD 2	01453	SDZ 2	01455
SDD 2	01453	SDZ 2	01455
SDD 2	01453	SDZ 2	01455
SDD 2	01453	SDZ 2	01455
SDD 2	01453	SDZ 2	01455
SDD 3	01367	SDZ 3	01366
SDD 2	01453	SDZ 2	01455
SDD 2	01453	SDZ 2	01455
SDD 2	01453	SDZ 2	01455

The ideal solution for commercial and industrial applications: **RADAX[®] VAR.**

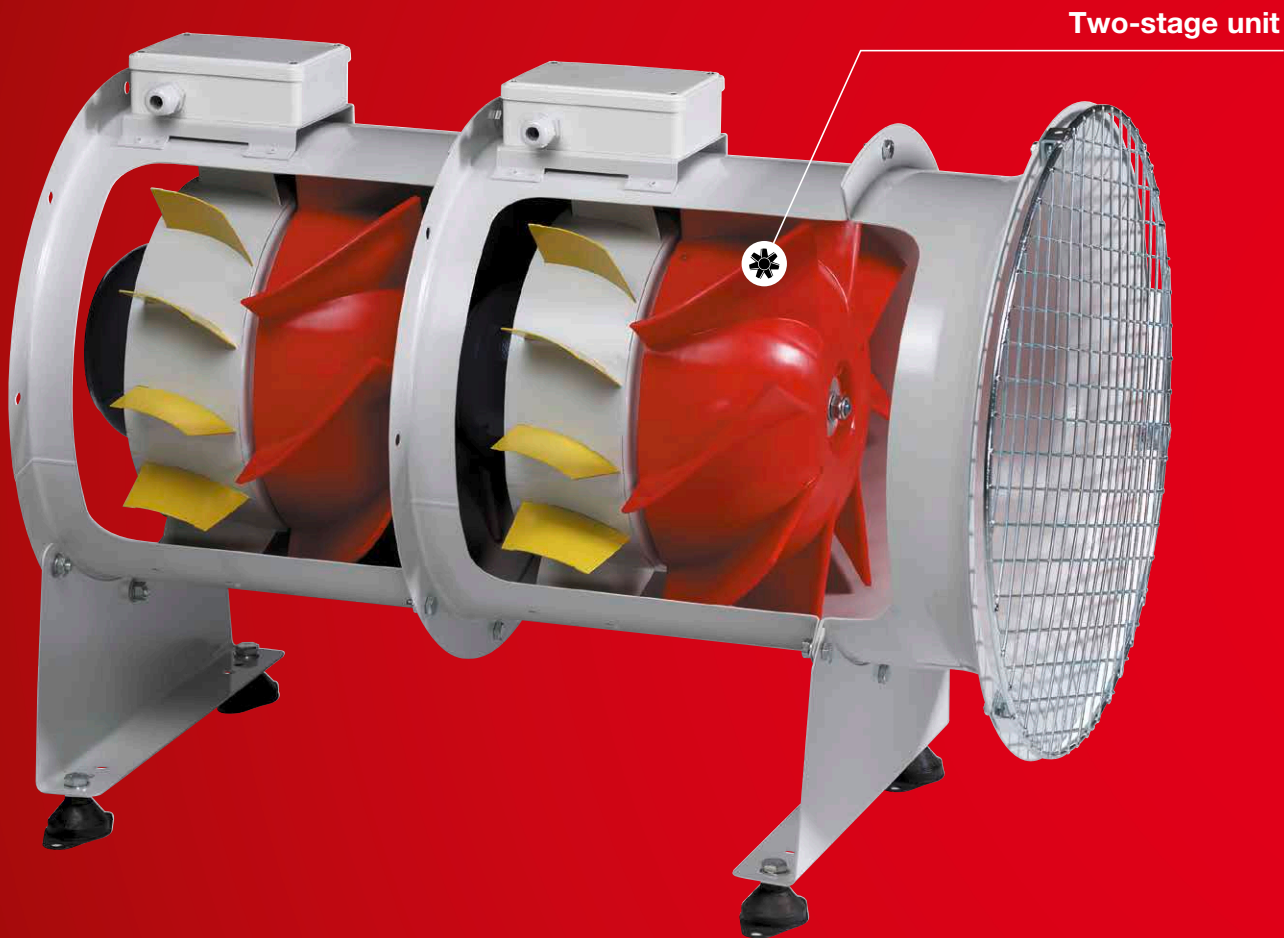

High pressure round duct fans RADAX[®] VAR are suitable for various commercial and industrial applications. **Almost 150 types in 14 sizes** impress with small and large volume flows and high resistances.

Helios offers the right system for practically any building in combination with perfectly tuned accessory components.





■ Compact

RADAX® VAR impellers offer high pressure and high flow rates, despite their extremely compact casing.

The winning VAR formula lies in the combination of centrifugal fan performance characteristics with an axial flow pattern. The linear air flow improves efficiency and provides a clear reduction in space requirement as well as pipe system savings.

■ High pressure

The synergy of performance and axial flow pattern results in enormous benefits:

- Maximum performance with minimal energy costs.
- Low noise levels.
- High pressure and volume rates with very small dimensions.
- Universal applications.
- Planning freedom.
- No need for on-site deflectors and fittings with associated resistances.
- Low installation costs.

■ Universal

In addition to single-stage types, the RADAX® VAR range offers:

- Other Ø up to 1000 mm.
- B VAR types for smoke extraction according to DIN 12101-3 F300 (60 min.) and F400, F600 (120 min.).
- Parallel units with high volumes and high pressures specifically for the ventilation of garages (VDI 2053).
- Two-stage TwinVent® with the highest pressure rates.

**Request TGA catalogue
Ref. no. 86 979**

This information supplements the “General technical information”.

Features

RADAX® VAR is a series of high pressure round duct fans which ideally combine the advantageous properties of axial and centrifugal fans.

The semiaxial impeller is matched to the fixed guide wheel so that high performance is achieved in pressure and volume flow with a good level of efficiency.

Flow pattern

The axial flow pattern enables a low-loss linear air flow and thus improves the efficiency of the fan. There is no need for the on-site fittings and deflectors required for centrifugal fans and their resistances. This saves installation costs and energy.

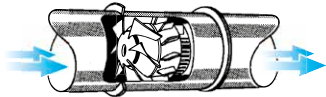

Casing

Tubular casing with double-sided flanges in accordance with DIN 24155, p.3 with integrated guide wheel and motor mount made of galvanised steel. Types with $n = 2800 \text{ min}^{-1}$ in nominal sizes 400, 450, 500 and all types in nominal size 630, welded casing, hot-dip galvanised. Terminal box (IP55) on outside of duct.

Impeller

Semiaxial impeller with 8 spatially curved blades. Made of plastic up to nominal size 355; made of hot-dip galvanised steel for types with $n = 2800 \text{ min}^{-1}$ in nominal size 355 as well as all types in nominal size 400 to 630. Aluminium (extra charge) available upon request. High level of efficiency, low operating noise, high corrosion resistance, low-vibration operation through dynamic balancing in accordance with DIN ISO 21940-11 – quality grade 6.3.

Air flow temperatures

The standard version can be used in the range from $-30 \text{ }^\circ\text{C}$ up to at least $+40 \text{ }^\circ\text{C}$. See information on product page. Approval for higher continuous temperatures is possible upon request.

Explosion protection

The explosion-proof types correspond to unit group II, category 2G for operation in zone 1 and 2. Larger air gaps which result in a performance reduction of approx. 10% are stipulated in accordance with Directive 2014/34/EU (ATEX).

Air flow direction

The air flow direction cannot be changed, but it can be set by the installation method. The correct motor rotation direction and air flow direction is marked by arrows on the fan.

Installation position, installation, condensate outlets

A duct section with length = $2 \times$ pipe diameter for free discharge and a corresponding straight duct section for intermediate positioning in a pipeline are required (Figure 1) to achieve the specified performance values.

- RADAX® VAR can be installed and operated in any position.
 - In case of equipment with condensate drain holes, please be aware of their position.
 - In case of outdoor installation, installation in permanently humid or wet environments or in case of installation with a vertical shaft, this must be indicated when placing the order.
- The installation site and mounting should be such that the fan can be mounted securely and without warping.

Positioning

The use of vibration dampers is recommended (accessories SDD, SDZ) to prevent vibration transmission). Larger motors may protrude from the back and cause uneven distribution due to their high weight. An extension duct VR (accessories) should be provided to adjust the centre of gravity!

Installation examples

- Horizontal**
 - **Figure 2**
Free intake, outlet-side operation. Mounting to ceiling, wall or floor.
 - **Figure 3**
Free intake, outlet-side operation with silencer provided with intermediate flanges. Duct silencers can be provided with intermediate flanges to reduce the inlet-side or outlet-side sound power.
 - **Figure 4**
Ceiling suspension
Figure 4 shows a typical installation in a ventilation application. The installation of VAR systems is possible through direct ceiling or wall suspension without any

Figure 1

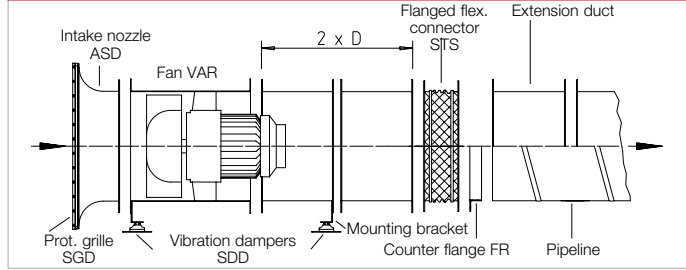

Figure 2

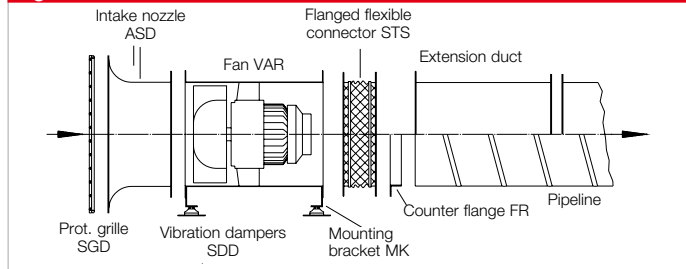

Figure 3

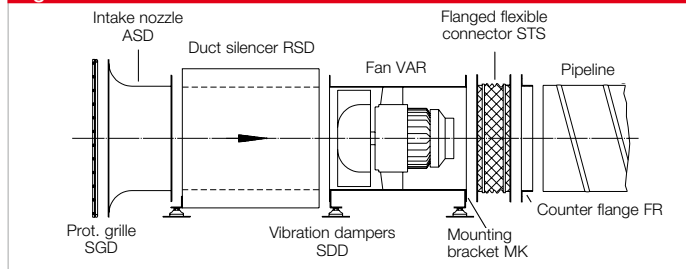
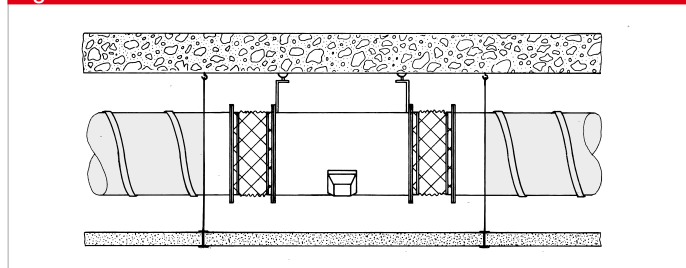

Figure 4



additional expenditure. The tubular casing with double-sided flanges (according to DIN 24155 p. 3) is designed for direct installation in the pipeline.

Vertical

- **Figure 5**
Integrated in the pipeline with inlet-side silencer. Wall mounted with brackets or through the ceiling. The elements must be suspended separately according to weight. Do not mount the fan with combined loads for inspection. Mounting rings MRV are available for the vertical attachment of the fan for size 315 and above. The fan weight including the attached accessories must not exceed the load-bearing capacity of the MRV.

Figure 5

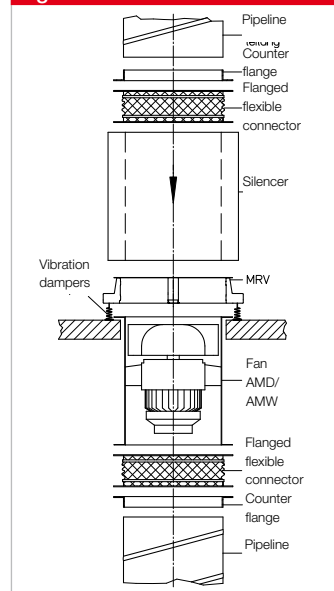

Reference	Page
Planning information, acoustics, expl. protection	10 ff.
General techn. information, power control	15 ff.

By combining the parameters of static pressure increase Δp_{fa} , flow rate V , speed min^{-1} , sound pressure level dB(A) and impeller diameter DN mm, the following table facilitates the selection of

RADAX®-VAR high pressure fans.
 Sizes from $\varnothing 710$ mm as well as two-stage and parallel VAR systems are available in the TGA catalogue, Ref. no. 86 979.

Diameter mm	Speed min^{-1}	Sound pressure inlet side L_{pa} dB(A) at 4 m distance	Flow rate V m^3/h depending on static pressure = N / m^2 = freely available pressure (Δp_{fa}) in Pa														
			0	50	100	150	200	300	400	500	600	700	800	900	1000		
225	2800	61	1770	1700	1600	1510	1400										
225	1450	46	900	730													
250	2800	64	2540	2450	2350	2250	2150	1910									
250	1450	49	1250	1050													
280	2800	68	3320	3220	3110	3010	2900	2670	2360								
280	1450	52	1630	1400	1000												
315	2800	71	4670	4550	4430	4310	4200	3930	3650	3280							
315	1450	56	2510	2300	2060	1730											
355	2800	75	7220	7080	6980	6850	6700	6450	6150	5850	5500	5050					
355	1450	60	3540	3300	3050	2750	2200										
400	2800	78	10150	10000	9850	9700	9600	9300	9000	8700	8350	7950	7500	7100	6400		
400	1450	63	5260	4950	4650	4310	3930										
400	930	52	3500	3060	2290												
450	2800	83	14200	14100	13900	13750	13600	13300	12900	12500	12200	11800	11400	10800	10350		
450	1450	67	7280	6950	6650	6300	5900	4800									
450	930	56	4990	4520	3870												

Diameter mm	Speed min^{-1}	Sound pressure inlet side L_{pa} dB(A) at 4 m distance	Flow rate V m^3/h depending on static pressure = N / m^2 = freely available pressure (Δp_{fa}) in Pa														
			0	50	100	150	200	300	400	500	600	700	800	900	1000		
500	2800	86	22310	21800	21400	20800	20300	19750	19200	18600	17900	16000	13500				
500	1450	70	9700	8640	7300												
500	930	59	6860	5150													
560	1450	73	13550	12500	11300	9850											
560	930	63	9850	8110													
560	725	56	7510														
630	1450	77	21460	20410	19110	17610	15760										
630	930	67	14040	12190	8740												
630	725	60	10690	7810													
Please request separate catalogue for the following performance variables.																	
710	1480	81	31350	30210	28920	27370	25680	23710	20790								
710	950	70	20110	18120	15390												
710	725	64	15330	12380													
800	1480	85	44870	43580	42210	40610	38810	36910	34780	32130	26670						
800	950	74	28770	26640	23850	19970											
800	725	67	21940	18810													
900	1480	88	63890	62450	60940	59300	57440	55410	53310	50990	48420	39610					
900	950	78	40990	38650	35710	32250	26830										
900	725	71	31260	27910	23160												
1000	1480	92	87640	86050	84410	82590	80770	78650	76400	74110	71650	66090	57450				
1000	950	81	56220	53690	50670	47080	42960	36050									
1000	725	74	42880	39330	34590	25090											

Axial and VAR fans

VAR 225



Also available in version:

Dimensions VAR 225

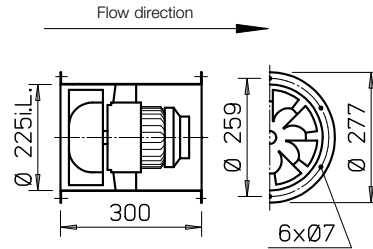

Dim. in mm

■ Casing

Duct with double-sided flange DIN 24155 p. 3. Made of galvanised steel sheet, fixed guide wheel with inner hub for mounting the flange motor.

■ Impeller

Optimised for high pressure and volume performance. Special development with spatially curved blades made of high-quality plastic.

■ Drive

Directly through maintenance-free flange motor. Closed design type IP54. Aluminium casing with cooling fins. Radio interference-free, sealed ball bearings. Tropicalised winding with moisture proof coating. With condensate drain holes upon request (except for explosion-proof types), and the installation method must be indicated when placing the order.

■ Power control

The voltage-controllable types are identified in the "Current consumption with control mode" column with a value which must be observed when determining the controller (see Speed controller column). The flow rates are shown in the performance diagram. The planned use of a frequency inverter without a sine filter should be indicated when placing the order. This requires a change of fan version and additional costs, if necessary. Explosion-proof types are not controllable.

■ Electrical connection

Standard terminal box (protection category IP55) on outside of duct.

■ Installation

Installation possible in any position; but be aware of any condensate drain holes depending on usage.

■ Motor protection

All types (except for 3~ explosion-proof) are equipped with thermal contacts. These should be wired with the motor protection circuit breaker (see type table) for effective motor protection. For 1~ explosion-proof types, the thermal contacts are wired in series with the winding, automatic deactivation and re-activation after cool down. Motors without thermal contacts must be protected by means of on-site a motor protection circuit breaker.

■ Noise levels

See sound power information above performance diagram. The lower sound pressure value can be determined using the diagram on the "Technical information" page. See page 10 f for noise emissions and room acoustics.

■ Reference

Techn. description	Page
Selection table	246
Planning information	247
	10 ff.

■ Special design

Different voltage, frequency, protection category, higher air flow temperature and acid protection upon request.

The technical information on p. 15 ff. must be observed.

Type	Ref. no.	Speed min ⁻¹	Flow rate free-blow. V m ³ /h	Power consump.* kW	Voltage V	Current consumption*		Wiring diagram No.	Max. air flow temp.		Weight net ca. kg	Speed controller 5-step Pole chang. switch		Motor protection circuit breaker for connecting built-in thermal contacts		Vibration dampers		
						at rated voltage A	with control A		at rated voltage +°C	with control +°C		Type	Ref. no.	Type	Ref. no.	Compr. Type	Tens. Type	
Single-phase alternating current, 50 Hz, protection category IP54																		
VARW 225/4	06660	1450	900	0.10	230	0.50	0.55	966	60	40	10.5	MWS 1 ¹⁾ 01947	MW	01579	SDD 1	SDZ 1		
VARW 225/2	06661	2770	1778	0.35	230	1.90	2.50	966	60	40	10.5	MWS 3 ¹⁾ 01948	MW	01579	SDD 1	SDZ 1		
Three-phase current, 50 Hz, protection category IP54																		
VARW 225/4	06662	1420	880	0.10	400 ^γ	0.20	0.20	469	60	40	10.5	RDS 1 ¹⁾ 01314	MD	05849	SDD 1	SDZ 1		
VARW 225/2	06663	2720	1750	0.28	400 ^γ	0.60	0.60	469	60	40	10.5	RDS 1 ¹⁾ 01314	MD	05849	SDD 1	SDZ 1		
Pole-changeable, 2 speeds (Dahlander winding γ/γγ), Three-phase current, 50 Hz, protection category IP54																		
VARW 225/4/2	06771	1460/2800	880/1800	0.06/0.30	400	0.22/0.57	–	472	60	–	10.5	PDA 12 ³⁾ 05081	M 3 ²⁾	01293	SDD 1	SDZ 1		
Ex Ex Explosion-proof, II 2G Ex h IIB T3 Gb, Motor Ex d, alternating current 230 Volt, 50 Hz, protection category IP55																		
VARW 225/4 Ex	06733	1400	950	0.06	230	0.70	–	757	40	–	12.0	not permitted	–	–	SDD 1	SDZ 1		
VARW 225/2 Ex	06734	2650	1780	0.18	230	1.23	–	757	40	–	12.5	not permitted	–	–	SDD 1	SDZ 1		
Ex Ex Explosion-proof, II 2G Ex h IIB + H, T3 Gb, Motor Ex e, three-phase current 400 Volt, 50 Hz, protection category IP55																		
VARW 225/4 Ex	06664	1400	940	0.12	400	0.41	–	470	40	–	12.5	not permitted	not permitted	–	SDD 1	SDZ 1		
VARW 225/2 Ex	06665	2850	1930	0.25	400	0.72	–	470	40	–	12.5	not permitted	not permitted	–	SDD 1	SDZ 1		

* For Ex types: Motor ratings see information on page 16. ¹⁾ incl. motor protection circuit breaker. ²⁾ includes operating and speed switch. ³⁾ Flush-m. version see Switch product page.

⁴⁾ Frequency inverter with integrated sine filter, Type FU-BS 2.5, No. 05459, see FU product page.

Performance curves VAR 225/2

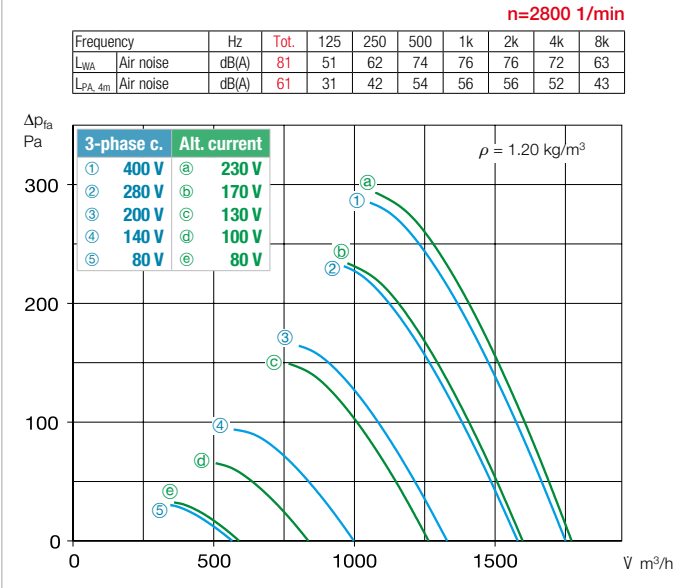

Performance curves VAR 225/4

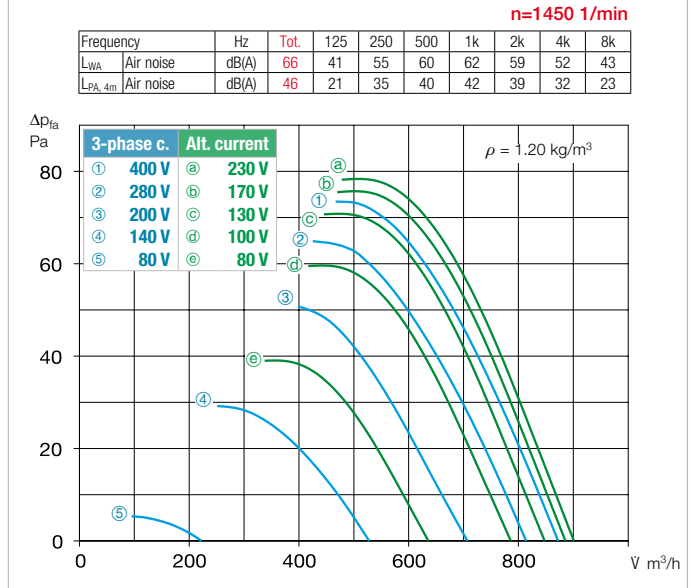

Accessories VAR 225 Description see page 268 ff.

Intake nozzle with prot. grille **ASD-SGD 225** No. 01413

Extension duct **VR 225** No. 01401

Duct silencer-**RSD 225/..**

Duct shutter, automatic **RVS 225 a)** No. 02591

Flanged flexible connector **STS 225 b)** No. 01218

Counter flange **FR 225** No. 01201

Flexible connecting sleeve **FM 225 b)** No. 01671

Protection grille duct side **SG 225** No. 01215

Mounting brackets **MK 225** (1 Set = 2 pcs) No. 01446

Vibration dampers for tensile load **SDZ 1** (1 set = 4 Pc) No. 01454

Vibration dampers for compression load **SDD 1** (1 set = 4 Pc) No. 01452

a) Shutter, motorised see Accessories product pages. b) Types for explosion-proof fans see above.

Axial and VAR fans

Other accessories	Page
Access. for expl.-proof fans	
Flanged flexible connector STS 225 Ex	Ref. no. 02500
Flexible connecting sleeve FM 225 Ex	Ref. no. 01687
Filters and silencers	473 ff.
Shutters and ventilation grilles	553 ff.
Speed controllers, controllers and switches	591 ff.

VAR 250



Also available in version:

Dimensions VAR 250

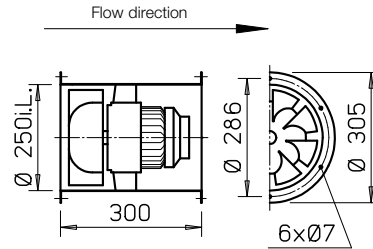

Dim. in mm

■ Casing

Duct with double-sided flange DIN 24155 p. 3. Made of galvanised steel sheet, fixed guide wheel with inner hub for mounting the flange motor.

■ Impeller

Optimised for high pressure and volume performance. Special development with spatially curved blades made of high-quality plastic.

■ Drive

Directly through maintenance-free flange motor. Closed design type IP54. Aluminium casing with cooling fins. Radio interference-free, sealed ball bearings. Tropicalised winding with moisture proof coating. With condensate drain holes upon request (except for explosion-proof types), and the installation method must be indicated when placing the order.

■ Power control

The voltage-controllable types are identified in the "Current consumption with control mode" column with a value which must be observed when determining the controller (see Speed controller column). The flow rates are shown in the performance diagram. The planned use of a frequency inverter without a sine filter should be indicated when placing the order. This requires a change of fan version and additional costs, if necessary. Explosion-proof types are not controllable.

■ Electrical connection

Standard terminal box (protection category IP55) on outside of duct.

■ Installation

Installation possible in any position; but be aware of any condensate drain holes depending on usage.

■ Motor protection

All types (except for 3~ explosion-proof) are equipped with thermal contacts. These should be wired with the motor protection circuit breaker (see type table) for effective motor protection. For 1~ explosion-proof types, the thermal contacts are wired in series with the winding, automatic deactivation and re-activation after cool down. Motors without thermal contacts must be protected by means of on-site a motor protection circuit breaker.

■ Noise levels

See sound power information above performance diagram. The lower sound pressure value can be determined using the diagram on the "Technical information" page. See page 10 f for noise emissions and room acoustics.

Reference	Page
Techn. description	246
Selection table	247
Planning information	10 ff.

■ Special design

Different voltage, frequency, protection category, higher air flow temperature and acid protection upon request.

The technical information on p. 15 ff. must be observed.

Type	Ref. no.	Speed min ⁻¹	Flow rate free-blow. V m ³ /h	Power consump.* kW	Voltage V	Current consumption*		Wiring diagram No.	Max. air flow temp.		Weight net ca. kg	Speed controller 5-step Pole chang. switch		Motor protection circuit breaker for connecting built-in thermal contacts		Vibration dampers	
						at rated voltage A	with control A		at rated voltage +°C	with control +°C		Type	Ref. no.	Type	Ref. no.	Compr. Type	Tens. Type
Single-phase alternating current 50 Hz, protection category IP54																	
VARW 250/4	06666	1420	1210	0.12	230	0.46	0.60	966	60	40	11.5	MWS 1.5 ¹⁾ 01947	MW	01579	SDD 1	SDZ 1	
VARW 250/2	06667	2840	2540	0.55	230	2.60	3.90	966	60	40	13.0	MWS 5 ¹⁾ 01949	MW	01579	SDD 1	SDZ 1	
Three-phase current, 50 Hz, protection category IP54																	
VARD 250/4	06668	1410	1250	0.09	400	0.30	0.30	469	60	40	11.5	RDS 1 ¹⁾ 01314	MD	05849	SDD 1	SDZ 1	
VARD 250/2	06669	2800	2450	0.47	400	1.10	1.10	469	60	40	11.5	RDS 2 ¹⁾ 01315	MD	05849	SDD 1	SDZ 1	
Pole-changeable, 2 speeds (Dahlander winding γ/γ), Three-phase current, 50 Hz, protection category IP54																	
VARW 250/4/2	06773	1425/2750	1200/2400	0.75/0.49	400	0.24/0.94	–	472	60	–	13.0	PDA 12 ³⁾ 05081	M 3 ²⁾	01293	SDD 1	SDZ 1	
Explosion-proof, II 2G Ex h IIB T3 Gb, Motor Ex d, alternating current 230 Volt, 50 Hz, protection category IP55																	
VARW 250/4 Ex	06735	1400	1290	0.06	230	0.70	–	757	40	–	13.0	not permitted	–	–	SDD 1	SDZ 1	
Explosion-proof, II 2G Ex h IIB + H₂ T3 Gb, Motor Ex e, three-phase current 400 Volt, 50 Hz, protection category IP5																	
VARD 250/4 Ex	06670	1400	1300	0.12	400	0.41	–	470	40	–	13.0	not permitted	not permitted	–	SDD 1	SDZ 1	
VARD 250/2 Ex	06671	2825	2590	0.37	400	0.95	–	470	40	–	15.5	not permitted	not permitted	–	SDD 1	SDZ 1	

* For Ex types: Motor ratings see information on page 16. ¹⁾ incl. motor protection circuit breaker. ²⁾ includes operating and speed switch. ³⁾ Flush-m. version see Switch product page.

⁴⁾ Frequency inverter with integrated sine filter, Type FU-BS 2.5, No. 05459, see product page FU.

Performance curves VAR 250/2

n=2800 1/min

Frequency	Hz	Tot.	125	250	500	1k	2k	4k	8k	
L _{WA}	Air noise	dB(A)	84	55	65	77	79	80	75	67
L _{PA,4m}	Air noise	dB(A)	64	35	45	57	59	60	55	47

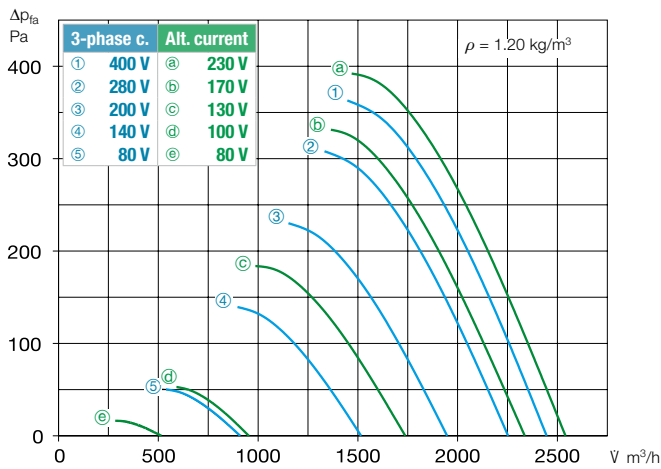

Performance curves VAR 250/4

n=1450 1/min

Frequency	Hz	Tot.	125	250	500	1k	2k	4k	8k	
L _{WA}	Air noise	dB(A)	69	44	58	63	65	63	56	46
L _{PA,4m}	Air noise	dB(A)	49	24	38	43	45	43	36	26

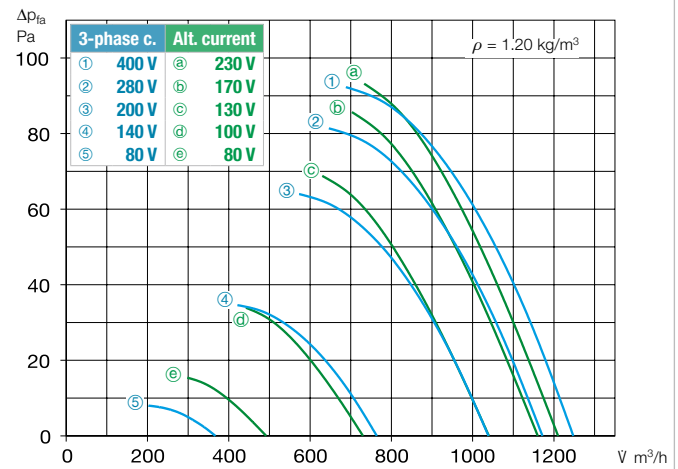

Accessories VAR 250 Description see page 268 ff.

Intake nozzle with prot. grille ASD-SGD 250 No. 01414	Extension duct VR 250 No. 01402	Duct silencer- RSD 250/..	Duct shutter, auto- matic RVS 250^{a)} No. 02592	Flanged flexible connector STS 250^{b)} No. 01220	Counter flange FR 250 No. 01203	Flat flange FF 250 No. 04941	Flexible connecting sleeve FM 250^{b)} No. 01672	Protection grille duct side SG 250 No. 01236	Mounting brackets MK 250 (1 Set = 2 pcs) No. 01447	Vibration dampers for tensile load SDZ 1 (1 set = 4 Pc) No. 01454 Vibration dampers for compression load SDD 1 (1 set = 4 Pc) No. 01452
--	--	-------------------------------------	--	--	--	---	---	---	--	--

^{a)} Shutter, motorised see Accessories product pages. ^{b)} Types for explosion-proof fans see above.

Axial and VAR fans

Other accessories	Page
^{b)} Access. for expl.-proof fans	
Flanged flexible connector STS 250 Ex	Ref. no. 02501
Flexible connecting sleeve FM 250 Ex	Ref. no. 01688
Filters and silencers	473 ff.
Shutters and ventilation grilles	553 ff.
Speed controllers, controllers and switches	591 ff.

VAR 280



Also available in version:

Dimensions VAR 280

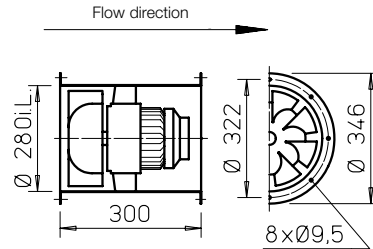

Dim. in mm

Casing

Duct with double-sided flange DIN 24155 p. 3. Made of galvanised steel sheet, fixed guide wheel with inner hub for mounting the flange motor.

Impeller

Optimised for high pressure and volume performance. Special development with spatially curved blades made of high-quality plastic.

Drive

Directly through maintenance-free flange motor. Closed design type IP54. Aluminium casing with cooling fins. Radio interference-free, sealed ball bearings. Tropicalised winding with moisture proof coating. With condensate drain holes upon request (except for explosion-proof types), and the installation method must be indicated when placing the order.

Power control

The voltage-controllable types are identified in the "Current consumption with control mode" column with a value which must be observed when determining the controller (see Speed controller column). The flow rates are shown in the performance diagram. The planned use of a frequency inverter without a sine filter should be indicated when placing the order. This requires a change of fan version and additional costs, if necessary. Explosion-proof types are not controllable.

Electrical connection

Standard terminal box (protection category IP55) on outside of duct.

Installation

Installation possible in any position; but be aware of any condensate drain holes depending on usage.

Motor protection

All types (except for 3~ explosion-proof) are equipped with thermal contacts. These should be wired with the motor protection circuit breaker (see type table) for effective motor protection. For 1~ explosion-proof types, the thermal contacts are wired in series with the winding, automatic deactivation and re-activation after cool down. Motors without thermal contacts must be protected by means of on-site a motor protection circuit breaker.

Noise levels

See sound power information above performance diagram. The lower sound pressure value can be determined using the diagram on the "Technical information" page. See page 10 f for noise emissions and room acoustics.

Reference	Page
Techn. description	246
Selection table	247
Planning information	10 ff.

Special design

Different voltage, frequency, protection category, higher air flow temperature and acid protection upon request.

The technical information on p. 15 ff. must be observed.

Type	Ref. no.	Speed min ⁻¹	Flow rate free-blow. V m ³ /h	Power consump.* kW	Voltage V	Current consumption*		Wiring diagram No.	Max. air flow temp.		Weight net ca. kg	Speed controller 5-step Pole chang. switch		Motor protection circuit breaker for connecting built-in thermal contacts		Vibration dampers	
						at rated voltage A	with control A		at rated voltage +°C	with control +°C		Type	Ref. no.	Type	Ref. no.	Compr. Type	Tens. Type
Single-phase alternating current 50 Hz, protection category IP54																	
VAR 280/4	06672	1330	1600	0.11	230	0.50	0.60	966	60	40	12.0	MWS 1.5 ¹⁾ 01947	MW	01579	SDD 1	SDZ 1	
VAR 280/2	06659	2715	3350	0.79	230	3.70	4.90	967	60	40	14.0	MWS 7.5 ¹⁾ 01950	MW	01579	SDD 1	SDZ 1	
Three-phase current, 50 Hz, protection category IP54																	
VARD 280/4	06673	1370	1650	0.12	400	0.35	0.35	469	60	40	12.0	RDS 1 ¹⁾ 01314	MD	05849	SDD 1	SDZ 1	
VARD 280/2	06674	2705	3315	0.80	400	1.52	1.64	469	60	40	13.5	RDS 2 ¹⁾ 01315	MD	05849	SDD 1	SDZ 1	
Pole-changeable, 2 speeds (Dahlander winding γ/γ), Three-phase current, 50 Hz, protection category IP54																	
VARD 280/4/2	06775	1405/2810	1760/3500	0.14/0.91	400	0.44/1.78	–	472	60	–	16.0	PDA 12 ³⁾ 05081	M 3 ²⁾	01293	SDD 1	SDZ 1	
Explosion-proof, II 2G Ex h IIB T3 Gb, Motor Ex d, alternating current 230 Volt, 50 Hz, protection category IP55																	
VAR 280/4 Ex	06737	1330	1720	0.18	230	1.25	–	757	40	–	14.0	not permitted	–	–	SDD 1	SDZ 1	
Explosion-proof, II 2G Ex h IIB + H₂ T3 Gb, Motor Ex e, three-phase current 400 Volt, 50 Hz, protection category IP55																	
VARD 280/4 Ex	06675	1400	1820	0.12	400	0.41	–	470	40	–	16.0	not permitted	not permitted	–	SDD 1	SDZ 1	
VARD 280/2 Ex	06676	1860	3720	0.75	400	1.65	–	470	40	–	18.0	not permitted	not permitted	–	SDD 1	SDZ 1	

* For Ex types: Motor ratings see information on page 16. ¹⁾ incl. motor protection circuit breaker. ²⁾ includes operating and speed switch. ³⁾ Flush-m. version see Switch product page.

⁴⁾ Frequency inverter with integrated sine filter, Type FU-BS 2.5, No. 05459, see product page FU.

Performance curves VAR 280/2

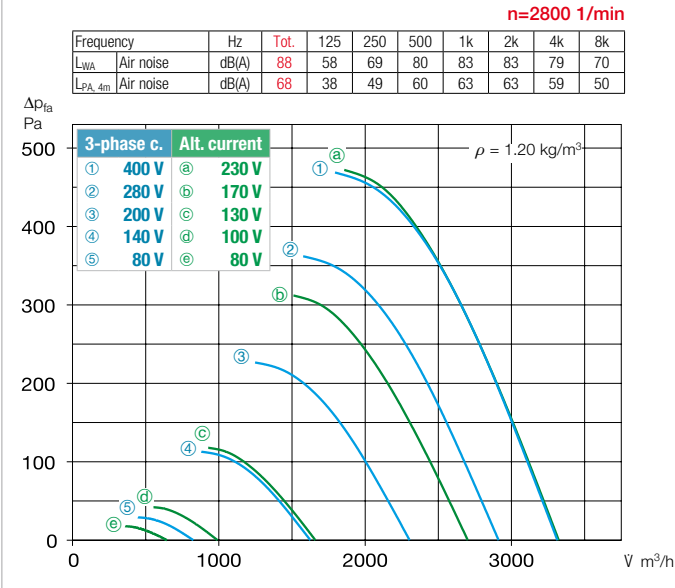

Performance curves VAR 280/4

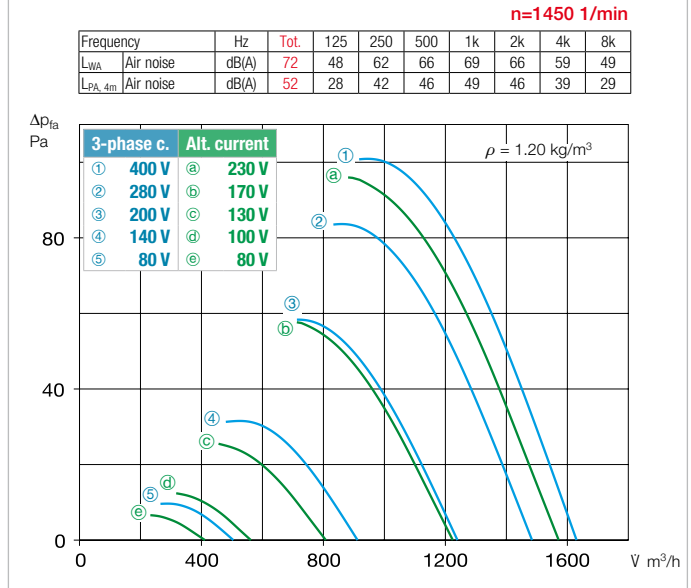

Accessories VAR 280 Description see page 268 ff.

<p>Intake nozzle with prot. grille ASD-SGD 280 No. 01415</p>	<p>Extension duct VR 280 No. 01403</p>	<p>Duct silencer- RSD 280/..</p>	<p>Duct shutter, auto-matic RVS 280^{a)} No. 02593</p>	<p>Flanged flexible connector STS 280^{b)} No. 01231</p>	<p>Counter flange FR 280 No. 01214</p>	<p>Flat flange FF 280 No. 04942</p>	<p>Flexible connecting sleeve FM 280^{b)} No. 01673</p>	<p>Protection grille duct side SG 280 No. 01428</p>	<p>Mounting brackets MK 280 (1 Set = 2 pcs) No. 01447</p>	<p>Vibration dampers for tensile load SDZ 1 (1 set = 4 Pc) No. 01454</p> <p>Vibration dampers for compression load SDD 1 (1 set = 4 Pc) No. 01452</p>
---	---	---	---	---	---	--	--	--	--	---

^{a)} Shutter, motorised see Accessories product pages. ^{b)} Types for explosion-proof fans see above.

Axial and VAR fans

Other accessories	Page
^{b)}Access. for expl.-proof fans	
Flanged flexible connector STS 280 Ex	Ref. no. 02502
Flexible connecting sleeve FM 280 Ex	Ref. no. 01689
Filters and silencers	473 ff.
Shutters and ventilation grilles	553 ff.
Speed controllers, controllers and switches	591 ff.

VAR 315



Also available in version:

Dimensions VAR 315

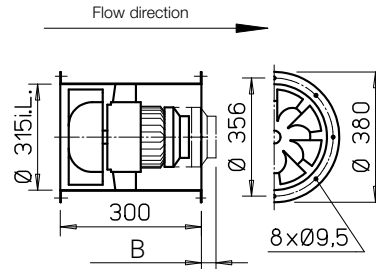

Dim. B see table
 Dim. in mm

Casing

Duct with double-sided flange DIN 24155 p. 3. Made of galvanised steel sheet, fixed guide wheel with inner hub for mounting the flange motor.

Impeller

Optimised for high pressure and volume performance. Special development with spatially curved blades made of high-quality plastic.

Drive

Directly through maintenance-free flange motor. Closed design type IP54. Aluminium casing with cooling fins. Radio interference-free, sealed ball bearings. Tropicalised winding with moisture proof coating. With condensate drain holes upon request (except for explosion-proof types), and the installation method must be indicated when placing the order.

Power control

The voltage-controllable types are identified in the "Current consumption with control mode" column with a value which must be observed when determining the controller (see Speed controller column). The flow rates are shown in the performance diagram. The planned use of a frequency inverter without a sine filter should be indicated when placing the order. This requires a change of fan version and additional costs, if necessary. Explosion-proof types are not controllable.

Electrical connection

Standard terminal box (protection category IP55) on outside of duct.

Installation

Installation possible in any position; but be aware of any condensate drain holes depending on usage.

Motor protection

All types (except for 3~ explosion-proof) are equipped with thermal contacts. These should be wired with the motor protection circuit breaker (see type table) for effective motor protection. For 1~ explosion-proof types, the thermal contacts are wired in series with the winding, automatic deactivation and re-activation after cool down. Motors without thermal contacts must be protected by means of on-site a motor protection circuit breaker.

Noise levels

See sound power information above performance diagram. The lower sound pressure value can be determined using the diagram on the "Technical information" page. See page 10 f for noise emissions and room acoustics.

Reference	Page
Techn. description	246
Selection table	247
Planning information	10 ff.

Special design

Different voltage, frequency, protection category, higher air flow temperature and acid protection upon request.

The technical information on p. 15 ff. must be observed.

Type	Ref. no.	Speed min ⁻¹	Flow rate free-blow. V m ³ /h	Power consump.* kW	Voltage V	Current consumption*		Wiring diagram No.	Max. air flow temp.		Weight net ca. kg	Dim. B Motor protru- sion mm	Speed controller 5-step Pole chang. switch		Motor pro- tection circuit breaker for connecting built-in thermal contacts		Vibration dampers		
						at rated voltage A	with control A		at rated voltage +°C	with control +°C			Type	Ref. no.	Type	No.	Compr. Type	Tens. Type	
Single-phase alternating current, 50 Hz, protection category IP54																			
VARW 315/4	06677	1440	2480	0.23	230	1.10	1.17	966	60	40	13.0	–	MWS 3 ¹⁾	01948	MW	01579	SDD 1	SDZ 1	
Three-phase current, 50 Hz, protection category IP54																			
VARD 315/4	06678	1450	2510	0.22	400	0.60	0.70	469	60	40	13.0	–	RDS 1 ¹⁾ 4 ¹⁾	01314	MD	05849	SDD 1	SDZ 1	
Two-speed, three-phase current, 50 Hz, Y/Δ connection, protection category IP54																			
VARD 315/2/2	06679	2150/2650	3580/4670	0.9/1.35	400Y/Δ	1.5/2.4	2.5	520	60	40	20.5	66	RDS 4 ¹⁾	01316	M 4 ²⁾	01571	SDD 1	SDZ 1	
Pole-changeable, 2 speeds (Dahlander winding Y/Y), Three-phase current, 50 Hz, protection category IP54																			
VARW 315/4/2	06777	1480/2890	2730/5340	0.42/1.83	400	1.2/3.3	–	472	60	–	20.5	54	PDA 12 ³⁾	05081	M 3 ²⁾	01293	SDD 1	SDZ 1	
Explosion-proof, II 2G Ex h IIB T3 Gb, Motor Ex d, alternating current 230 Volt, 50 Hz, protection category IP55																			
VARW 315/4 Ex	06738	1450	2680	0.18	230	1.25	–	757	40	–	15.0	6	not permitted	–	–	–	SDD 1	SDZ 1	
Explosion-proof, II 2G Ex h IIB + H₂ T3 Gb, Motor Ex e, three-phase current 400 Volt, 50 Hz, protection category IP55																			
VARD 315/4 Ex	06680	1420	2610	0.37	400	1.14	–	470	40	–	17.0	–	not permitted	not permitted	–	–	SDD 1	SDZ 1	
VARD 315/2 Ex	06681	2860	5260	1.50	400	3.15	–	470	40	–	23.0	44	not permitted	not permitted	–	–	SDD 1	SDZ 1	

* For Ex types: Motor ratings see information on page 16. ¹⁾ incl. motor protection circuit breaker. ²⁾ includes operating and speed switch. ³⁾ Flush-m. version see Switch product page.

⁴⁾ Frequency inverter with integrated sine filter, Type FU-BS 2.5, No. 05459, see product page FU.

Performance curves VAR 315/2

n=2700 1/min

Frequency	Hz	Tot.	125	250	500	1k	2k	4k	8k	
L _{WA} Air noise		dB(A)	91	62	73	84	86	87	82	74
L _{PA,4m} Air noise		dB(A)	71	42	53	64	66	67	62	54

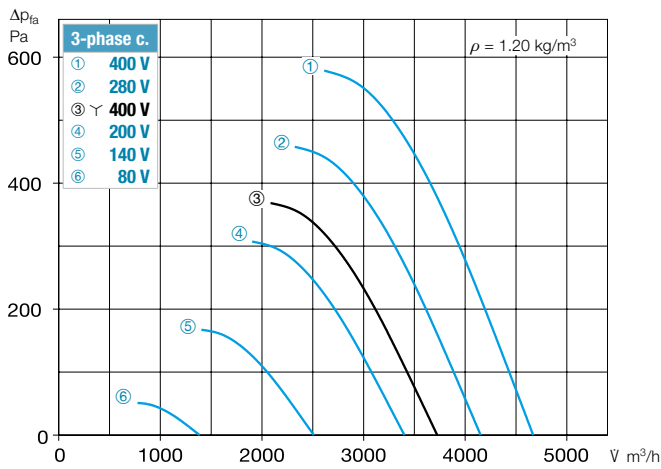

Performance curves VAR 315/4

n=1450 1/min

Frequency	Hz	Tot.	125	250	500	1k	2k	4k	8k	
L _{WA} Air noise		dB(A)	76	52	65	70	72	70	63	53
L _{PA,4m} Air noise		dB(A)	56	32	45	50	52	50	43	33

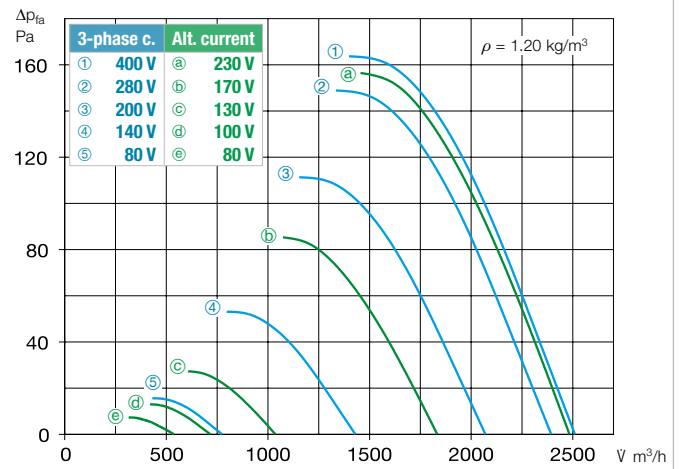

Accessories VAR 315 Description see page 268 ff.

Intake nozzle with prot. grille ASD-SGD 315 No. 01416	Extension duct VR 315 No. 01404	Duct silencer- RSD 315/..	Duct shutter, automatic RVS 315 a) No. 02594	Flanged flexible connector STS 315 b) No. 01221	Counter flange FR 315 No. 01204	Flat flange FF 315 No. 04943	Flexible connecting sleeve FM 315 b) No. 01674	Protection grille duct side SG 315 No. 01237	Mounting brackets MK 315 (1 Set = 2 pcs) No. 01448	Mounting ring for vertical attachment MRV 315 No. 01755

a) Shutter, motorised see Accessories product pages. b) Types for explosion-proof fans see above.

Axial and VAR fans

Other accessories	Page
Access. for expl.-proof fans	
Flanged flexible connector STS 315 Ex	Ref. no. 02503
Flexible connecting sleeve FM 315 Ex	Ref. no. 01690
Filters and silencers	473 ff.
Shutters and ventilation grilles	553 ff.
Speed controllers, controllers and switches	591 ff.

VAR 355



Also available in version:

Dimensions VAR 355

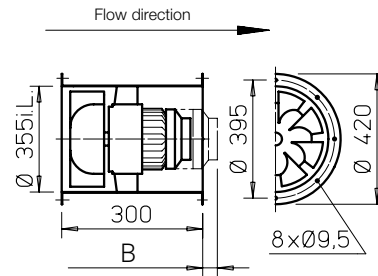

Dim. B see table
 Dim. in mm

Casing

Duct with double-sided flange DIN 24155 p. 3. Made of galvanised steel sheet, fixed guide wheel with inner hub for mounting the flange motor.

Impeller

Optimised for high pressure and volume performance. Special development with spatially curved blades made of high-quality plastic; made of hot-dip galvanised steel for types with $n = 2800 \text{ min}^{-1}$.

Drive

Directly through maintenance-free flange motor. Closed design type IP54. Aluminium casing with cooling fins. Radio interference-free, sealed ball bearings. Tropicalised winding with moisture proof coating. With condensate drain holes upon request (except for explosion-proof types), and the installation method must be indicated when placing the order.

Power control

The voltage-controllable types are identified in the "Current consumption with control mode" column with a value which must be observed when determining the controller (see Speed controller column). The flow rates are shown in the performance diagram. The planned use of a frequency inverter without a sine filter should be indicated when placing the order. This requires a change of fan version and additional costs, if necessary. Explosion-proof types are not controllable.

Electrical connection

Standard terminal box (protection category IP55) on outside of duct.

Installation

Installation possible in any position; but be aware of any condensate drain holes depending on usage.

Motor protection

All types (except for explosion-proof models and type VARD 355/4/2) are equipped with thermal contacts. These should be wired for effective motor protection. Motors without thermal contacts must be protected by means of on-site a motor protection circuit breaker.

Noise levels

See sound power information above performance diagram. The lower sound pressure value can be determined using the diagram on the "Technical information" page. See page 10 f for noise emissions and room acoustics.

Reference	Page
Techn. description	246
Selection table	247
Planning information	10 ff.

Special design

Different voltage, frequency, protection category, higher air flow temperature and acid protection upon request.

The technical information on p. 15 ff. must be observed.

Type	Ref. no.	Speed	Flow rate free-blow.	Power consump.*	Voltage	Current consumption*		Wiring diagram	Max. air flow temp.		Weight net	Dim. B Motor protrusion	Speed controller 5-step Pole chang. switch		Motor protection circuit breaker for connecting built-in thermal contacts		Vibration dampers						
						at rated voltage	with control		at rated voltage	with control			Type	Ref. no.	Type	No.	Compr.	Tens.					
																		Type	Ref. no.	Type	No.	Type	Type
Single-phase alternating current, 50 Hz, protection category IP54																							
VARW 355/4	06682	1380	3470	0.37	230	3.30	2.35	966	60	40	21.0	22	MWS 3 ¹⁾	01948	MW	01579	SDD 1	SDZ 1					
Three-phase current, 50 Hz, protection category IP54																							
VARD 355/4	06683	1440	3550	0.40	400	0.87	1.20	469	60	40	15.5	12	RDS 1 ¹⁾ 5)	01314	MD	05849	SDD 1	SDZ 1					
Two-speed, three-phase current, 50 Hz, γ/Δ connection, protection category IP54																							
VARD 355/2/2	06684	2415/2790	6040/7220	2.06/2.81	400 γ/Δ	3.40/5.40	–	520	60	30	30.3	94	RDS 7 ¹⁾	01578	M 4 ²⁾	01571	SDD 1	SDZ 1					
Pole-changeable, 2 speeds (Dahlander winding $\gamma/\gamma\gamma$), Three-phase current, 50 Hz, protection category IP54																							
VARD 355/4/2	06779	1470/2870	3830/7500	0.48/3.11	400	1.35/5.50	–	471	40	–	29.0	80	PDA 12 ³⁾	05081	M 3 ³⁾	01293	SDD 1	SDZ 1					
VARW 355/4 Ex	06685	1420	3740	0.37	400	1.14	–	470	40	–	19.0	–	not permitted	not permitted			SDD 1	SDZ 1					
VARD 355/4 Ex	06686	1420	3740	0.37	400	1.14	–	470	40	–	19.0	–	not permitted	not permitted			SDD 1	SDZ 1					
VARD 355/2 Ex ⁴⁾	06686	2860	7580	2.50	400	4.85/2.77	–	498	40	–	33.0	77	not permitted	not permitted			SDD 1	SDZ 1					

* For Ex types: Motor ratings see information on page 16. ¹⁾ incl. motor protection circuit breaker. ²⁾ includes operating and speed switch. ³⁾ Flush-m. version see Switch product page.
⁴⁾ A vibration monitoring system (on-site) must be provided according to DIN EN 14986. ⁵⁾ Frequency inverter with integrated sine filter, Type FU-BS 2.5, No. 05459, see product page FU.

Performance curves VAR 355/2

n=2800 1/min

Frequency	Hz	Tot.	125	250	500	1k	2k	4k	8k	
L _{WA} Air noise		dB(A)	95	65	76	88	90	90	86	77
L _{PA,4m} Air noise		dB(A)	75	45	56	68	70	70	66	57

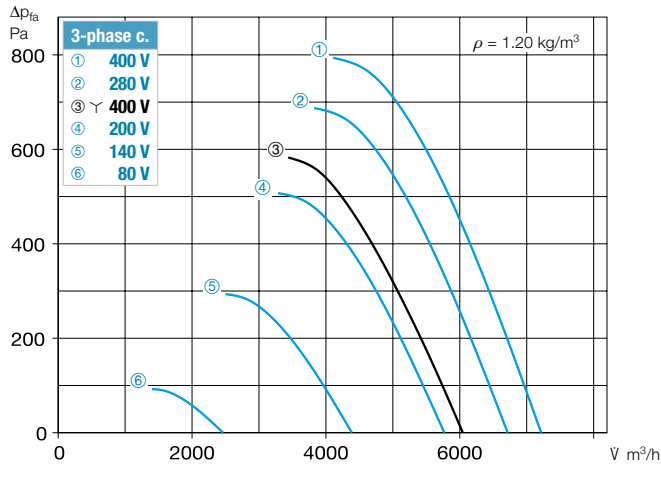

Performance curves VAR 355/4

n=1400 1/min

Frequency	Hz	Tot.	125	250	500	1k	2k	4k	8k	
L _{WA} Air noise		dB(A)	80	55	69	73	76	73	66	56
L _{PA,4m} Air noise		dB(A)	60	35	49	53	56	53	46	36

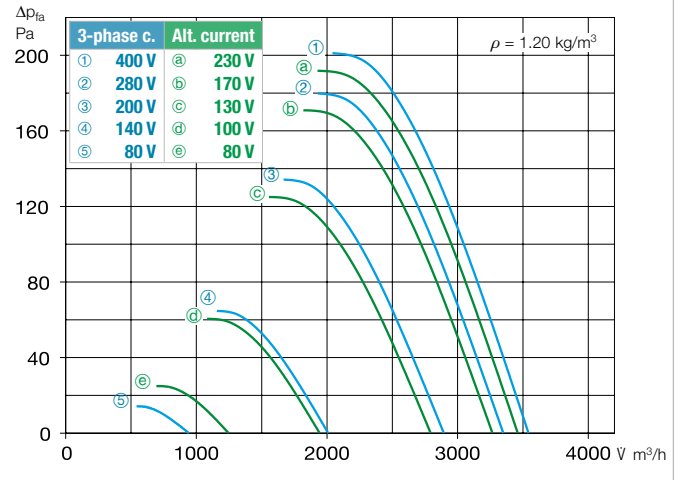

Accessories VAR 355 Description see page 268 ff.

Intake nozzle with prot. grille ASD-SGD 355 No. 01417	Extension duct VR 355 No. 01405	Duct silencer- RSD 355/..	Duct shutter, auto- matic RVS 355 a) No. 02595	Flanged flexible connector STS 355 b) No. 01222	Counter flange FR 355 No. 01205	Flat flange FF 355 No. 04944	Flexible connecting sleeve FM 355 b) No. 01675	Protection grille duct side SG 355 No. 01238	Mounting brackets MK 355 (1 Set = 2 pcs) No. 01448	Mounting ring for vertical attachment MRV 355 No. 01759
--	--	-------------------------------------	--	--	--	---	---	---	--	--

a) Shutter, motorised see Accessories product pages. b) Types for explosion-proof fans see above.

Axial and VAR fans

Other accessories	Page
Access. for expl.-proof fans	
Flanged flexible connector STS 355 Ex	Ref. no. 02504
Flexible connecting sleeve FM 355 Ex	Ref. no. 01691
Filters and silencers	473 ff.
Shutters and ventilation grilles	553 ff.
Speed controllers, controllers and switches	591 ff.

VAR 400



Also available in version:

Dimensions VAR 400

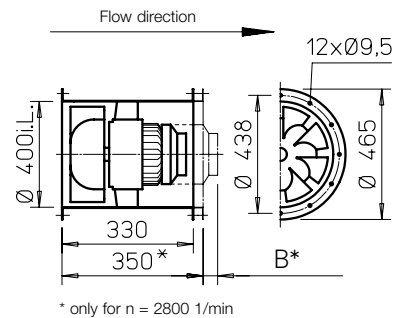

* only for n = 2800 1/min

Dim. B see table
 Dim. in mm

■ Casing

Duct with double-sided flange DIN 24155 p. 3. Made of galvanized steel sheet, fixed guide wheel with inner hub for mounting the flange motor. Types with n = 2800 min⁻¹ welded casing, hot-dip galvanized.

■ Impeller

Optimised for high pressure and volume performance. Special development with spatially curved blades made of hot-dip galvanized steel.

■ Drive

Directly through maintenance-free flange motor. Closed design type IP54. Aluminium or grey cast iron casing with cooling fins. Radio interference-free, sealed ball bearings. Tropicalised winding with moisture proof coating. With condensate drain holes upon request (except for explosion-proof types), and the installation method must be indicated when placing the order.

■ Power control

The voltage-controllable types are identified in the "Current consumption with control mode" column with a value which must be observed when determining the controller (see Speed controller column). The flow rates are shown in the performance diagram. The planned use of a frequency inverter without a sine filter should be indicated when placing the order. This requires a change of fan version and additional costs, if necessary. Explosion-proof types are not controllable.

■ Electrical connection

Standard terminal box (protection category IP55) on outside of duct.

■ Installation

Installation possible in any position; but be aware of any condensate drain holes depending on usage.

■ Motor protection

All types (except for explosion-proof models and type VARD 400/4/2) are equipped with thermal contacts. These should be wired with the motor protection circuit breaker (see type table) for effective motor protection. Motors without thermal contacts must be protected by means of on-site a motor protection circuit breaker.

■ Noise levels

See sound power information above performance diagram. The lower sound pressure value can be determined using the diagram on the "Technical information" page. See page 10 f for noise emissions and room acoustics.

■ Reference **Page**

Techn. description	246
Selection table	247
Planning information	10 ff.

Special design

Different voltage, frequency, protection category, higher air flow temperature and acid protection upon request.

The technical information on p. 15 ff. must be observed.

Type	Ref. no.	Speed min ⁻¹	Flow rate free-blow. V m ³ /h	Power consump.* kW	Voltage V	Current consumption*		Wiring diagram No.	Max. air flow temp.		Weight net ca. kg	Dim. B Motor protru- sion mm	Speed controller 5-step Pole chang. switch		Motor pro- tection circuit breaker for connecting built-in thermal contacts		Vibration dampers		
						at rated voltage A	with control A		at rated voltage +°C	with control +°C			Type	Ref. no.	Type	No.	Compr. Type	Tens. Type	
Single-phase alternating current, 50 Hz, protection category IP54																			
VARW 400/4	06688	1375	5130	0.70	230	3.00	3.35	967	60	40	22.5	–	MWS 5¹⁾	01949	MW	01579	SDD 1	SDZ 1	
Three-phase current, 50 Hz, protection category IP54																			
VARD 400/4	06690	1400	5240	0.72	400	1.95	2.00	469	60	40	22.5	–	RDS 4^{1) 2)}	01316	MD	05849	SDD 1	SDZ 1	
Two-speed, three-phase current, 50 Hz, γ/Δ connection, protection category IP54																			
VARD 400/2/2	06691	2475/2800	8320/10610	3.63/4.95	400 γ/Δ	5.75/7.95	–	520	60	40	74.0	202	RDS 11³⁾	01332	M 4²⁾	01571	SDD 1	SDZ 2	
Pole-changeable, 2 speeds (Dahlander winding $\gamma/\gamma\gamma$), Three-phase current, 50 Hz, protection category IP54																			
VARD 400/4/2	06782	1400/2890	5220/10700	0.80/5.90	400	2.43/9.13	–	471	40	–	74.0	207	PDA 12³⁾	05081	M 3²⁾	01293	SDD 1	SDZ 2	
Ex Explosion-proof, II 2G Ex h IIB T3 Gb, Motor Ex e, three-phase current 400 Volt, 50 Hz, protection category IP55																			
VARD 400/6 Ex	06692	920	3465	0.25	400	0.97	–	470	40	–	21.0	–	not permitted	not permitted			SDD 1	SDZ 1	
VARD 400/4 Ex	06693	1430	5360	0.55	400	1.51	–	470	40	–	25.0	–	not permitted	not permitted			SDD 1	SDZ 1	
VARD 400/2 Ex⁴⁾	06694	2895	10950	4.60	400	8.20	–	498	40	–	83.0	252	not permitted	not permitted			SDD 2	SDZ 2	

* For Ex types: Motor ratings see information on page 16. ¹⁾ incl. motor protection circuit breaker. ²⁾ includes operating and speed switch. ³⁾ Flush-m. version see Switch product page.
⁴⁾ A vibration monitoring system (on-site) must be provided according to DIN EN 14986. ⁵⁾ Frequency inverter with integrated sine filter, Type FU-BS 2.5, No. 05459, see product page FU.

Performance curves VAR 400/2

n=2800 1/min

Frequency	Hz	Tot.	125	250	500	1k	2k	4k	8k
L _{WA}	Air noise	dB(A)	98	69	80	91	94	90	81
L _{PA, 4m}	Air noise	dB(A)	78	49	60	71	74	70	61

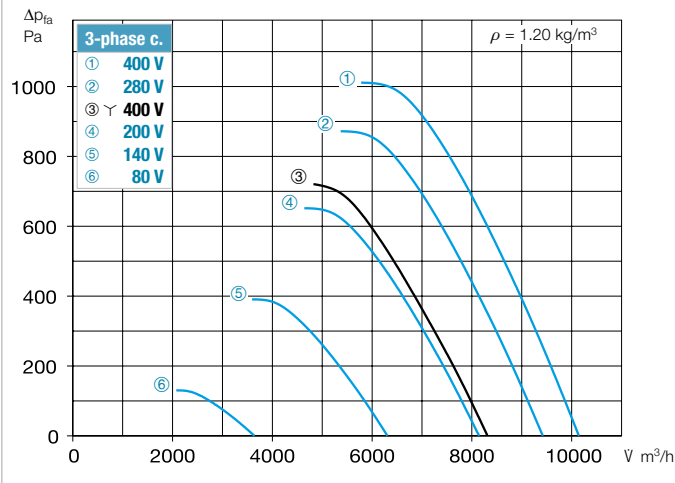

Performance curves VAR 400/4

n=1450 1/min

Frequency	Hz	Tot.	125	250	500	1k	2k	4k	8k
L _{WA}	Air noise	dB(A)	83	59	72	77	79	77	60
L _{PA, 4m}	Air noise	dB(A)	63	39	52	57	59	57	40

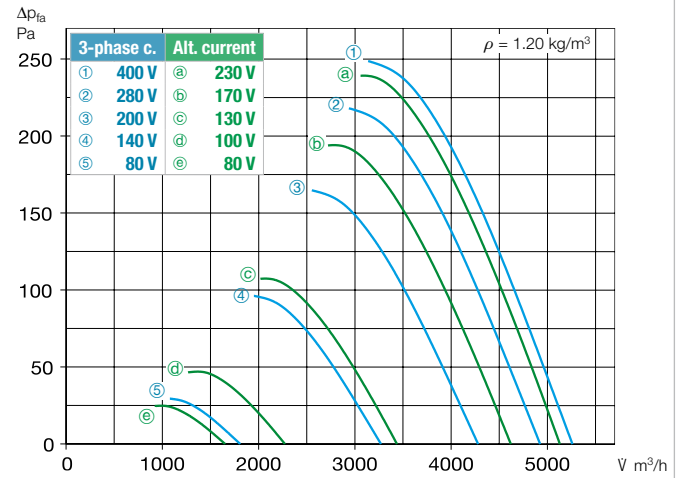

Performance curve VAR 400/6

n=930 1/min

Frequency	Hz	Tot.	125	250	500	1k	2k	4k	8k
L _{WA}	Air noise	dB(A)	72	56	62	68	64	56	47
L _{PA, 4m}	Air noise	dB(A)	52	36	42	48	44	36	27

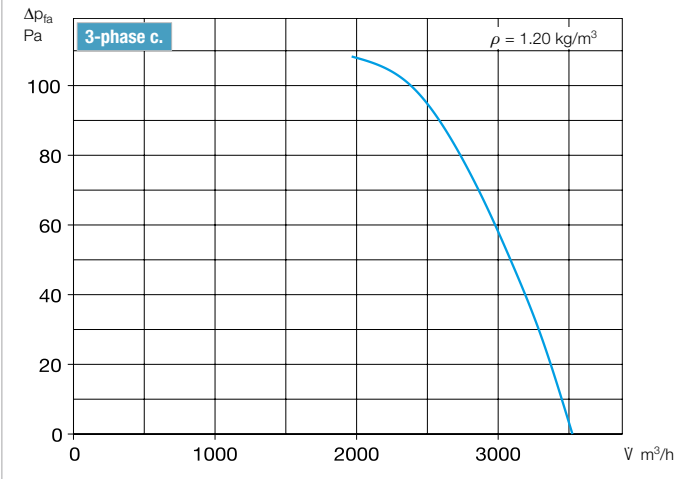

Other accessories Page

^{b)}Access. for expl.-proof fans

Flanged flexible connector

STS 400 Ex Ref. no. 02505

Flexible connecting sleeve

FM 400 Ex Ref. no. 01692

Filters and silencers 473 ff.

Shutters and

ventilation grilles 553 ff.

Speed controllers, controllers

and switches 591 ff.

Accessories VAR 400 Description see page 268 ff.

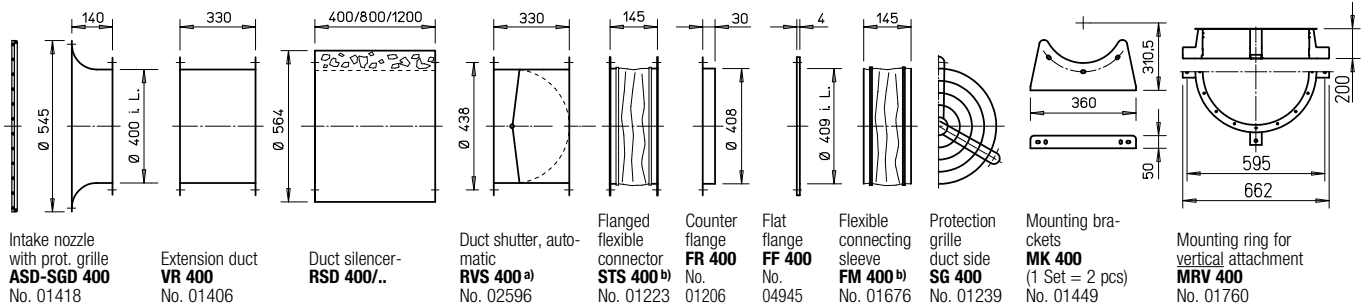

^{a)} Shutter, motorised see Accessories product pages. ^{b)} Types for explosion-proof fans see left page.

VAR 450



Also available in version:

Dimensions VAR 450

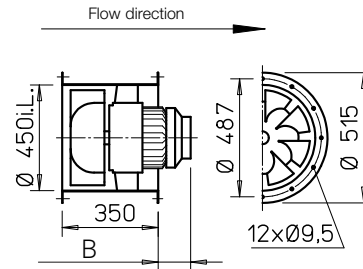

Dim. B see table
 Dim. in mm

Casing

Duct with double-sided flange DIN 24155 p. 3. Made of galvanised steel sheet, fixed guide wheel with inner hub for mounting the flange motor. Types with $n = 2800 \text{ min}^{-1}$ welded casing, hot-dip galvanised.

Impeller

Optimised for high pressure and volume performance. Special development with spatially curved blades made of hot-dip galvanised steel.

Drive

Directly through maintenance-free flange motor. Closed design type IP54. Aluminium or grey cast iron casing with cooling fins. Radio interference-free, sealed ball bearings. Tropicalised winding with moisture proof coating. With condensate drain holes upon request (except for explosion-proof types), and the installation method must be indicated when placing the order.

Power control

The voltage-controllable types are identified in the "Current consumption with control mode" column with a value which must be observed when determining the controller (see Speed controller column). The flow rates are shown in the performance diagram. The planned use of a frequency inverter without a sine filter should be indicated when placing the order. This requires a change of fan version and additional costs, if necessary. Explosion-proof types are not controllable.

Electrical connection

Standard terminal box (protection category IP55) on outside of duct.

Installation

Installation possible in any position; but be aware of any condensate drain holes depending on usage.

Motor protection

All types (except for explosion-proof models) are equipped with thermal contacts or PTC thermistors. These should be wired with the motor protection circuit breaker (see type table) for effective motor protection. Motors without thermal contacts must be protected by means of on-site a motor protection circuit breaker.

Noise levels

See sound power information above performance diagram. The lower sound pressure value can be determined using the diagram on the "Technical information" page. See page 10 f for noise emissions and room acoustics.

Reference	Page
Techn. description	246
Selection table	247
Planning information	10 ff.

Special design

Different voltage, frequency, protection category, higher air flow temperature and acid protection upon request.

The technical information on p. 15 ff. must be observed.

Type	Ref. no.	Speed min ⁻¹	Flow rate free-blow. V m ³ /h	Power consump.* kW	Voltage V	Current consumption*		Wiring diagram No.	Max. air flow temp.		Weight net ca. kg	Dim. B Motor protru- sion mm	Speed controller 5-step Pole chang. switch		Motor pro- tection circuit breaker for connecting built-in thermal contacts		Vibration dampers		
						at rated voltage A	with control A		at rated voltage +°C	with control +°C			Type	Ref. no.	Type	No.	Compr.	Tens.	
Single-phase alternating current 50 Hz, protection category IP54																			
VARW 450/4	06736	1330	7180	1.47	230	6.50	7.00	968	60	40	45.0	145	MWS 7.5 ¹⁾ 01950	MW 01579	SDD 1	SDZ 1			
Three-phase current, 50 Hz, protection category IP54																			
VARD 450/2	06698	2950	14210	8.03	400	13.8	–	776	60	–	95.0	252	FU-CS 18 ¹⁾ 05469	MSA ³⁾ 01289	SDD 2	SDZ 2			
Two-speed, three-phase current, 50 Hz, γ/Δ connection, protection category IP54																			
VARD 450/4/4	06697	1100/1370	5930/7390	0.74/1.00	400 γ/Δ	1.2/2.3	2.3	520	60	40	45.0	145	RDS 4 ¹⁾ 01316	M 4 ²⁾ 01571	SDD 1	SDZ 1			
													Pole chang. switch						
VARD 450/6 Ex	06699	900	5020	0.25	400	0.99	–	470	40	–	48.0	97	not permitted	not permitted	SDD 1	SDZ 1			
VARD 450/4 Ex	06700	1425	7640	1.10	400	2.55	–	470	40	–	51.0	98	not permitted	not permitted	SDD 1	SDZ 1			
VARD 450/2 Ex ⁴⁾	06701	2930	15810	7.50	400	14.10	–	498	40	–	155.0	259	not permitted	not permitted	SDD 2	SDZ 2			

* For Ex types: Motor ratings see information on page 16. ¹⁾ incl. motor protection circuit breaker. ²⁾ includes operating and speed switch. ³⁾ for PTC thermistor temperature sensor.
⁴⁾ A vibration monitoring system (on-site) must be provided according to DIN EN 14986. ⁵⁾ with integrated sine filter, see product page FU.

Performance curve VAR 450/2

n=2800 1/min

Frequency	Hz	Tot.	125	250	500	1k	2k	4k	8k
L _{WA}	Air noise	dB(A)	103	73	84	95	98	94	85
L _{PA, 4m}	Air noise	dB(A)	83	53	64	75	78	74	65

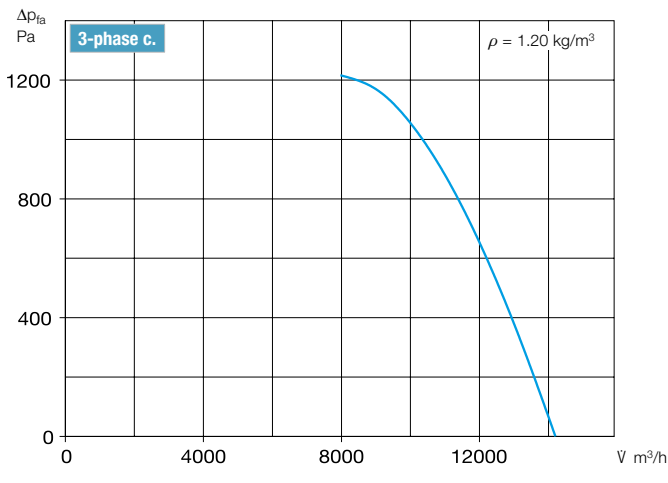

Performance curves VAR 450/4

n=1400 1/min

Frequency	Hz	Tot.	125	250	500	1k	2k	4k	8k
L _{WA}	Air noise	dB(A)	87	62	76	81	83	80	74
L _{PA, 4m}	Air noise	dB(A)	67	42	56	61	63	60	54

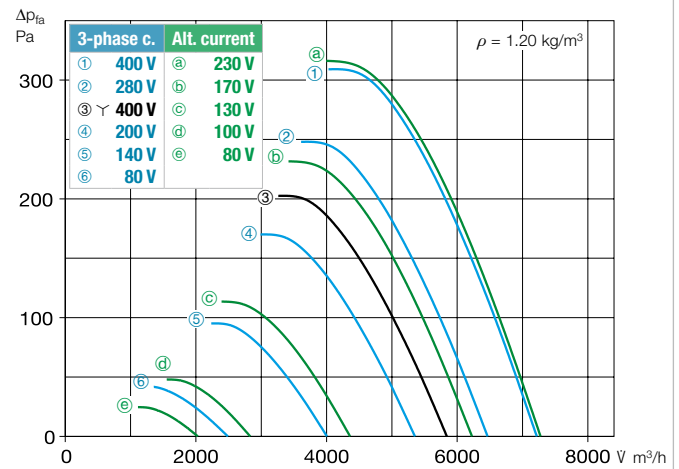

Performance curve VAR 450/6

n=930 1/min

Frequency	Hz	Tot.	125	250	500	1k	2k	4k	8k
L _{WA}	Air noise	dB(A)	76	60	65	71	72	67	59
L _{PA, 4m}	Air noise	dB(A)	56	40	45	51	52	47	39

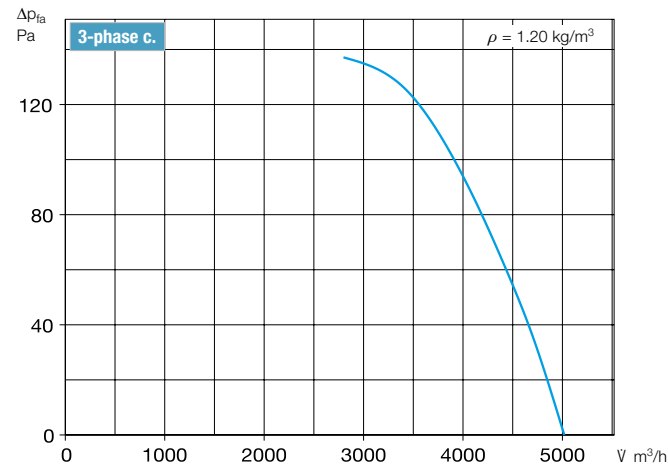

Other accessories Page

^{b)}Access. for expl.-proof fans

Flanged flexible connector

STS 450 Ex Ref. no. 02506

Flexible connecting sleeve

FM 450 Ex Ref. no. 01693

Filters and silencers 473 ff.

Shutters and

ventilation grilles 553 ff.

Speed controllers, controllers

and switches 591 ff.

Accessories VAR 450 Description see page 268 ff.

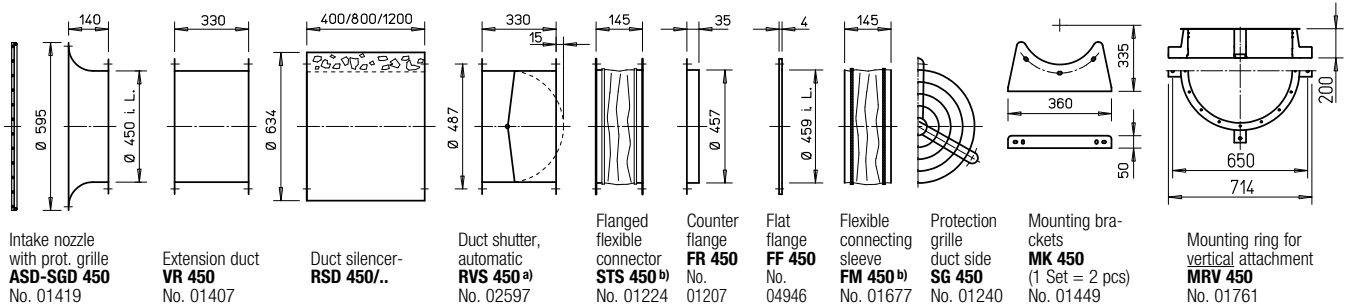

^{a)} Shutter, motorised see Accessories product pages. ^{b)} Types for explosion-proof fans see left page.

VAR 500



Also available in version:

Dimensions VAR 500

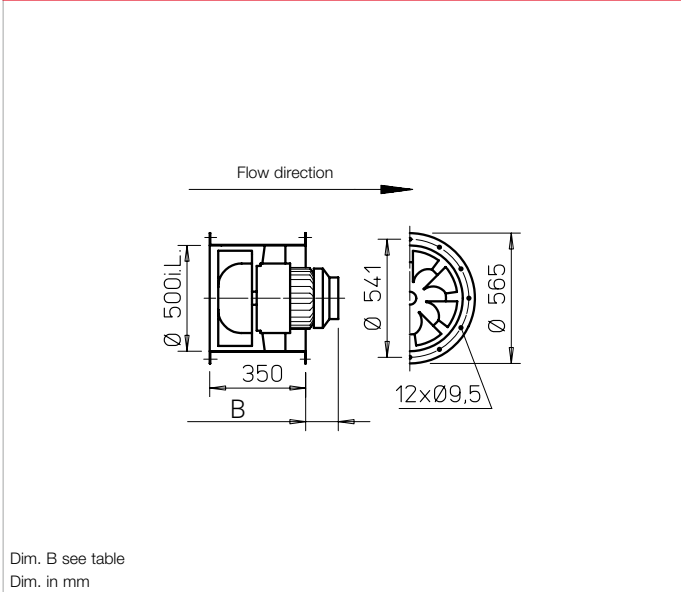

Dim. B see table
 Dim. in mm

Casing

Duct with double-sided flange DIN 24155 p. 3. Made of galvanized steel sheet, fixed guide wheel with inner hub for mounting the flange motor. Types with $n = 2800 \text{ min}^{-1}$ welded casing, hot-dip galvanized.

Impeller

Optimised for high pressure and volume performance. Special development with spatially curved blades made of hot-dip galvanized steel.

Drive

Directly through maintenance-free flange motor. Closed design type IP54. Aluminium or grey cast iron casing with cooling fins. Radio interference-free, sealed ball bearings. Tropicalised winding with moisture proof coating. With condensate drain holes upon request (except for explosion-proof types), and the installation method must be indicated when placing the order.

Power control

The voltage-controllable types are identified in the "Current consumption with control mode" column with a value which must be observed when determining the controller (see Speed controller column). The flow rates are shown in the performance diagram. The planned use of a frequency inverter without a sine filter should be indicated when placing the order. This requires a change of fan version and additional costs, if necessary. Explosion-proof types are not controllable.

Electrical connection

Standard terminal box (protection category IP55) on outside of duct.

Installation

Installation possible in any position; but be aware of any condensate drain holes depending on usage.

Motor protection

All types (except for explosion-proof models) are equipped with thermal contacts or PTC thermistors. These should be wired with the motor protection circuit breaker (see type table) for effective motor protection. Motors without thermal contacts must be protected by means of on-site a motor protection circuit breaker.

Noise levels

See sound power information above performance diagram. The lower sound pressure value can be determined using the diagram on the "Technical information" page. See page 10 f for noise emissions and room acoustics.

Reference	Page
Techn. description	246
Selection table	247
Planning information	10 ff.

Special design

Different voltage, frequency, protection category, higher air flow temperature and acid protection upon request.

The technical information on p. 15 ff. must be observed.

Type	Ref. no.	Speed	Flow rate free-blow.	Power consump.*	Voltage	Current consumption*		Wiring diagram	Max. air flow temp.		Weight net	Dim. B Motor protrusion	Speed controller 5-step Pole chang. switch		Motor protection circuit breaker for connecting built-in thermal contacts		Vibration dampers		
						at rated voltage	with control		at rated voltage	with control			Type	Ref. no.	Type	No.	Type	Type	
min ⁻¹																			
V m ³ /h																			
kW																			
V																			
A																			
A																			
No.																			
+°C																			
+°C																			
ca. kg																			
mm																			
Type																			
Ref. no.																			
Type																			
No.																			
Type																			
Type																			
Single-phase alternating current 50 Hz, protection category IP5																			
VARW 500/4	06739	1340	9920	2.02	230	9.10	9.10	968	60	40	70.0	181	MWS 10 ¹⁾	01946	MW	01579	SDD 2	SDZ 2	
Three-phase current, 50 Hz, protection category IP54																			
VARD 500/2	06705	2935	21730	15.70	400	29.00	–	776	40	–	180.0	367	FU-CS 32 ²⁾	05471	MSA ³⁾	01289	SDD 2	SDZ 3	
Two-speed, three-phase current, 50 Hz, γ/Δ connection, protection category IP54																			
VARD 500/4/4	06704	1120/1370	8360/10070	1.2/1.8	400 γ/Δ	2.1/3.9	3.9	520	60	40	70.0	126	RDS 7 ¹⁾	01578	M 4 ³⁾	01571	SDD 2	SDZ 2	
Ex Explosion-proof, II 2G Ex h IIB T3 Gb, Motor Ex e, three-phase current 400 Volt, 50 Hz, protection category IP55																			
VARD 500/6 Ex	06706	930	6810	0.55	400	1.83	–	470	40	–	70.0	121	not permitted				SDD 2	SDZ 2	
VARD 500/4 Ex	06707	1420	10470	2.00	400	4.65	–	470	40	–	75.0	144	not permitted				SDD 2	SDZ 2	
VARD 500/2 Ex ⁴⁾	06708	2930	21760	12.50	400	23.50	–	498	40	–	215.0	389	not permitted				SDD 3	SDZ 3	

* For Ex types: Motor ratings see information on page 16. ¹⁾ incl. motor protection circuit breaker. ²⁾ includes operating and speed switch. ³⁾ for PTC thermistor temperature sensor.
⁴⁾ A vibration monitoring system (on-site) must be provided according to DIN EN 14986. ⁵⁾ with integrated sine filter, see product page FU.

Performance curve VAR 500/2

n=2900 1/min

Frequency	Hz	Tot.	125	250	500	1k	2k	4k	8k
L _{WA} Air noise	dB(A)	106	76	87	99	101	101	97	89
L _{PA, 4m} Air noise	dB(A)	86	56	67	79	81	81	77	69

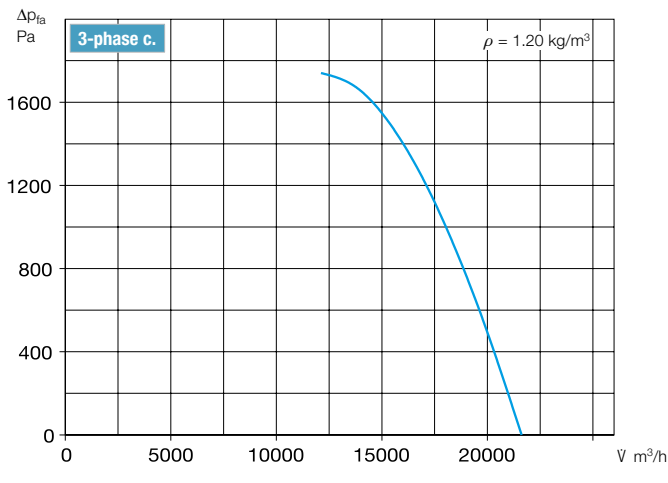

Performance curves VAR 500/4

n=1450 1/min

Frequency	Hz	Tot.	125	250	500	1k	2k	4k	8k
L _{WA} Air noise	dB(A)	90	66	79	84	86	84	77	67
L _{PA, 4m} Air noise	dB(A)	70	46	59	64	66	64	57	47

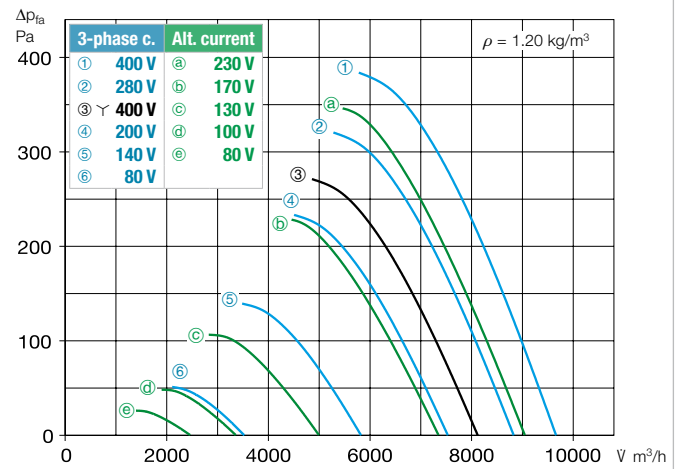

Performance curve VAR 500/6

n=930 1/min

Frequency	Hz	Tot.	125	250	500	1k	2k	4k	8k
L _{WA} Air noise	dB(A)	79	63	69	74	75	71	63	54
L _{PA, 4m} Air noise	dB(A)	59	43	49	54	55	51	43	34

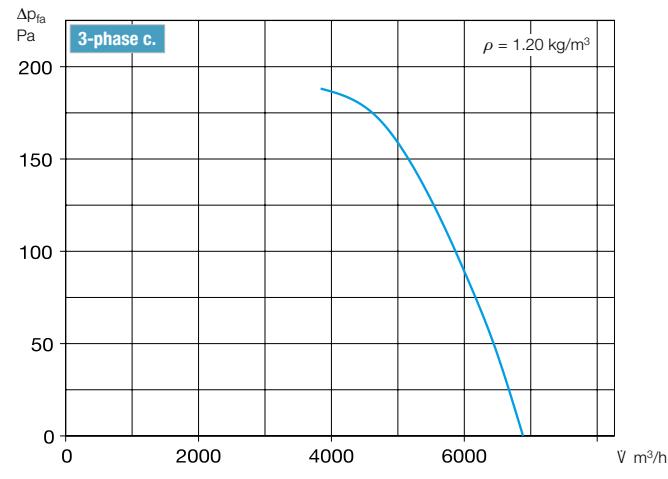

Other accessories Page

^{b)}Access. for expl.-proof fans

Flanged flexible connector

STS 500 Ex Ref. no. 02507

Flexible connecting sleeve

FM 500 Ex Ref. no. 01694

Filters and silencers 473 ff.

Shutters and

ventilation grilles 553 ff.

Speed controllers, controllers

and switches 591 ff.

Accessories VAR 500 Description see page 268 ff.

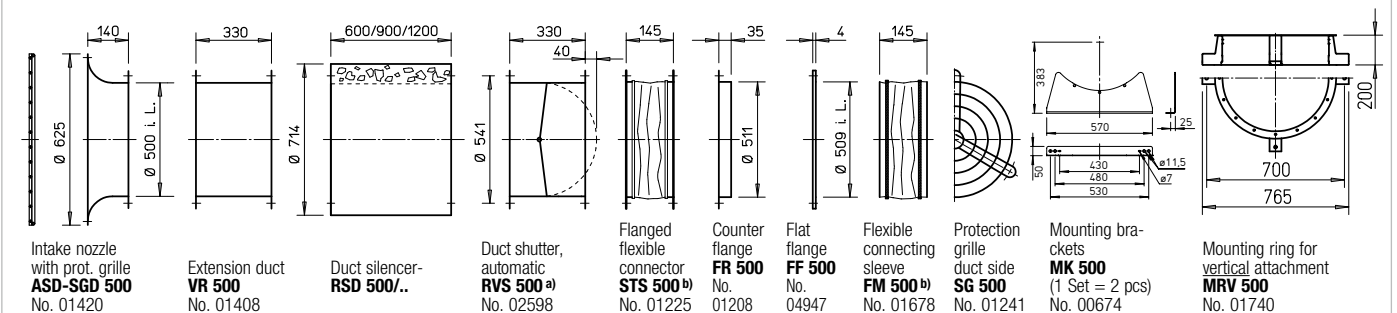

^{a)} Shutter, motorised see Accessories product pages. ^{b)} Types for explosion-proof fans see left page.

VAR 560



Also available in version:

Dimensions VAR 560

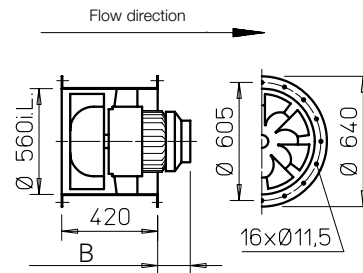

Dim. B see table
 Dim. in mm

■ Casing

Duct with double-sided flange DIN 24155 p. 3. Made of galvanised steel sheet, fixed guide wheel with inner hub for mounting the flange motor.

■ Impeller

Optimised for high pressure and volume performance. Special development with spatially curved blades made of hot-dip galvanised steel.

■ Drive

Directly through maintenance-free flange motor. Closed design type IP54. Aluminium or grey cast iron casing with cooling fins. Radio interference-free, sealed ball bearings. Tropicalised winding with moisture proof coating. With condensate drain holes upon request (except for explosion-proof types), and the installation method must be indicated when placing the order.

■ Power control

The voltage-controllable types are identified in the "Current consumption with control mode" column with a value which must be observed when determining the controller (see Speed controller column). The flow rates are shown in the performance diagram. Explosion-proof types are not controllable.

■ Electrical connection

Standard terminal box (protection category IP55) on outside of duct.

■ Installation

Installation possible in any position; but be aware of any condensate drain holes depending on usage.

■ Motor protection

All types (except for explosion-proof models) are equipped with thermal contacts. These should be wired with the motor protection circuit breaker (see type table) for effective motor protection. Motors without thermal contacts must be protected by means of on-site a motor protection circuit breaker.

■ Noise levels

See sound power information above performance diagram. The lower sound pressure value can be determined using the diagram on the "Technical information" page. See page 10 f for noise emissions and room acoustics.

Reference	Page
Techn. description	246
Selection table	247
Planning information	10 ff.

■ Special design

Different voltage, frequency, protection category, higher air flow temperature and acid protection upon request.

The technical information on p. 15 ff. must be observed.

Type	Ref. no.	Speed min ⁻¹	Flow rate free-blow. m ³ /h	Power consump.* kW	Voltage V	Current consumption*		Wiring diagram No.	Max. air flow temp.		Weight net ca. kg	Dim. B Motor protru- sion mm	Speed controller 5-step Pole chang. switch		Motor protection circuit breaker for connecting built-in thermal contacts		Vibration dampers		
						at rated voltage A	with control A		at rated voltage +°C	with control +°C			Type	Ref. no.	Type	No.	Compr. Type	Tens. Type	
Two-speed, three-phase current, 50 Hz, Y/Δ connection, protection category IP54																			
VAR 560/4/4	06711	1130/1380	10780/12810	2.20/3.00	400Y/Δ	3.5/5.9	6.5	520	60	40	95.0	159	RDS 7 ¹⁾	01578	M 4 ²⁾	01571	SDD 2	SDZ 2	
Pole-changeable, 2 speeds (Dahlander winding YYY), Three-phase current, 50 Hz, protection category IP54																			
VAR 560/8/4	06790	705/1440	6590/13570	0.90/3.60	400	2.9/8.3	—	471	60	—	100.0	175	PDA 12 ³⁾	05081	—	—	SDD 2	SDZ 2	
Ex Explosion-proof, II 2G Ex h IIB T3 Gb, Motor Ex e, three-phase current 400 Volt, 50 Hz, protection category IP55																			
VAR 560/8 Ex	06712	700	7120	0.37	400	1.61	—	470	40	—	85.0	84	not permitted	not permitted	SDD 2	SDZ 2			
VAR 560/6 Ex	06713	900	9360	1.10	400	3.10	—	470	40	—	90.0	148	not permitted	not permitted	SDD 2	SDZ 2			
VAR 560/4 Ex ⁴⁾	06714	1440	14980	3.60	400	7.70	—	498	40	—	105.0	190	not permitted	not permitted	SDD 2	SDZ 2			

* For Ex types: Motor ratings see information on page 16. ¹⁾ incl. motor protection circuit breaker. ²⁾ includes operating and speed switch. ³⁾ Flush-m. version see Switch product page.

⁴⁾ A vibration monitoring system (on-site) must be provided according to DIN EN 14986.

Performance curves VAR 560/4

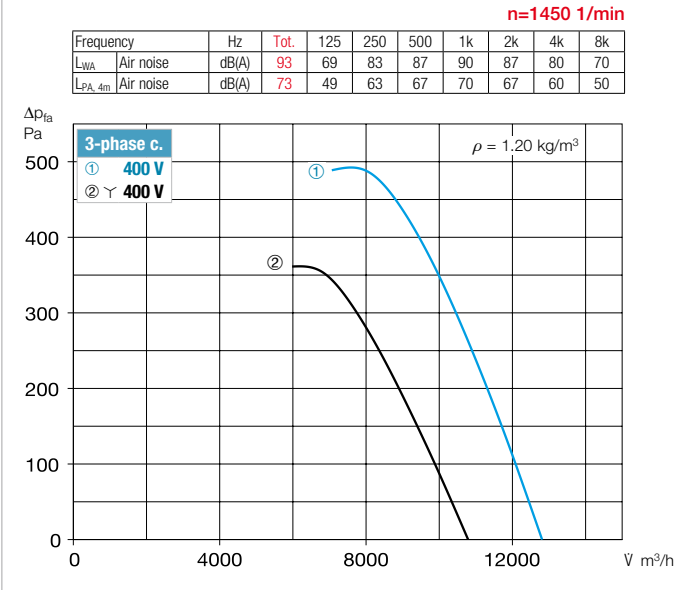

Performance curve VAR 560/6

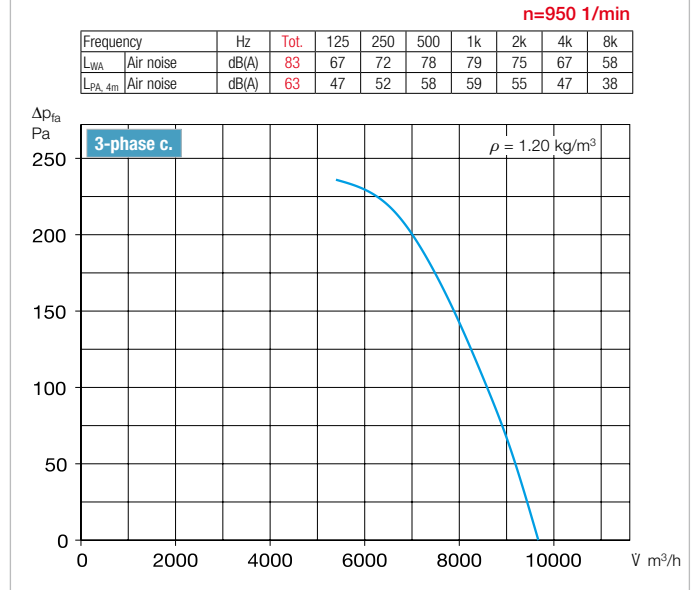

Performance curve VAR 560/8

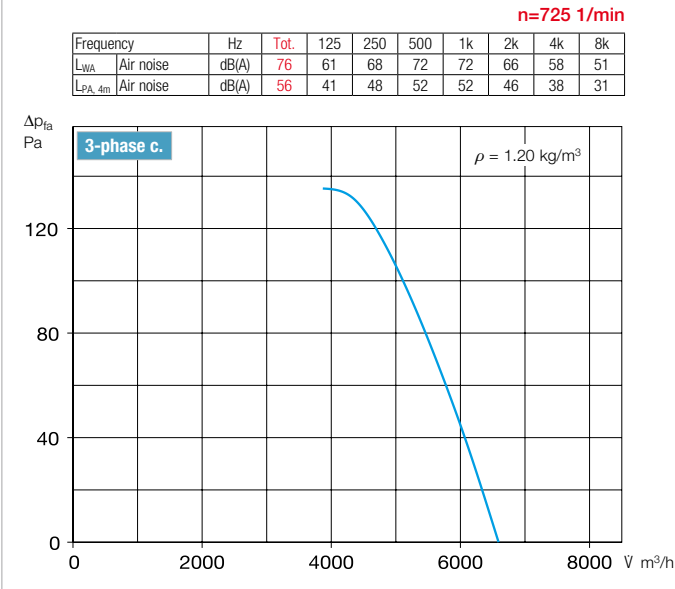

Other accessories	Page
Access. for expl.-proof fans	
Flanged flexible connector STS 560 Ex	Ref. no. 02508
Flexible connecting sleeve FM 560 Ex	Ref. no. 02508
Filters and silencers	473 ff.
Shutters and ventilation grilles	553 ff.
Speed controllers, controllers and switches	591 ff.

Accessories VAR 560 Description see page 268 ff.

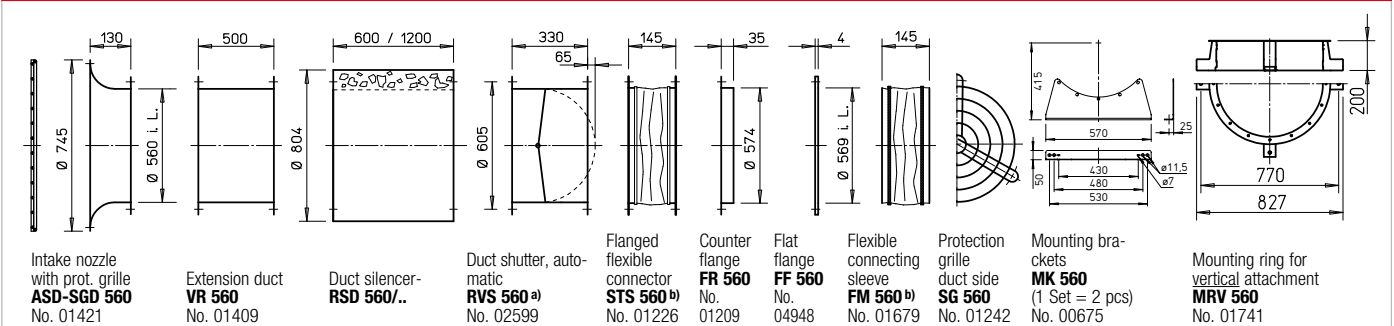

a) Shutter, motorised see Accessories product pages. b) Types for explosion-proof fans see left page.

VAR 630



Also available in version:

Dimensions VAR 630

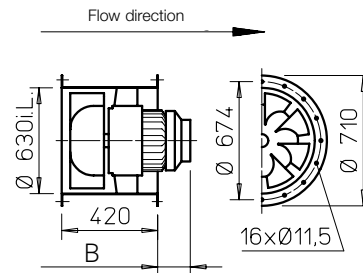

Dim. B see table
 Dim. in mm

■ Casing

Duct with double-sided flange DIN 24155 p. 3. welded construction, hot-dip galvanised. Welded-in guide wheel with inner hub for mounting the flange motor, hot-dip galvanised.

■ Impeller

Optimised for high pressure and volume performance. Special development with spatially curved blades made of hot-dip galvanised steel.

■ Drive

Directly through maintenance-free flange motor. Closed design type IP54. Aluminium or grey cast iron casing with cooling fins. Radio interference-free, sealed ball bearings. Tropicalised winding with moisture proof coating. With condensate drain holes upon request (except for explosion-proof types), and the installation method must be indicated when placing the order.

■ Power control

Continuously variable (0-100 %) through the use of a frequency inverter (except for pole-changeable models). The planned use of a frequency inverter without a sine filter should be indicated when placing the order. This requires a change of fan version and additional costs, if necessary. Explosion-proof types are not controllable.

■ Electrical connection

Standard terminal box (protection category IP55) on outside of duct.

■ Installation

Installation possible in any position; but be aware of any condensate drain holes depending on usage.

■ Motor protection

Type VARD 630/4 is equipped with PTC thermistors. These should be wired with the motor protection circuit breaker (see type table) for effective motor protection. Motors without thermal contacts must be protected by means of on-site a motor protection circuit breaker.

■ Noise levels

See sound power information above performance diagram. The lower sound pressure value can be determined using the diagram on the "Technical information" page. See page 10 f for noise emissions and room acoustics.

Reference	Page
Techn. description	246
Selection table	247
Planning information	10 ff.

Special design

Different voltage, frequency, protection category, higher air flow temperature and acid protection upon request.

The technical information on p. 15 ff. must be observed.

Type	Ref. no.	Speed	Flow rate free-blow.	Power consump.*	Voltage	Current consumption*		Wiring diagram	Max. air flow temp.		Weight net	Dim. B Motor protrusion	Speed controller 5-step Pole chang. switch		Motor protection circuit breaker for connecting built-in thermal contacts		Vibration dampers		
						at rated voltage	with control		at rated voltage	with control			Type	Ref. no.	Type	No.	Compr. Type	Tens. Type	
		min ⁻¹	V m ³ /h	kW	V	A	A	No.	+°C	+°C	ca. kg	mm							
Three-phase current, 50 Hz, protection category IP5																			
VARD 630/4	06717	1400	21320	6.20	400	12.0/6.9	–	776	60	–	145.0	230	FU-BS 14 ⁴⁾ 05463	MSA ⁴⁾ 01289	SDD 2	SDZ 2			
Pole-changeable, 2 speeds (Dahlander winding $\gamma/\gamma\gamma$), Three-phase current, 50 Hz, protection category IP54																			
VARD 630/8/4	06792	715/1430	10590/21170	1.40/5.50	400	5.0/12.0	–	471	60	–	145.0	255	PDA 12 ³⁾ 05081	–	–	SDD 2	SDZ 2		
Ex Explosion-proof, II 2G Ex h IIB T3 Gb, Motor Ex e, three-phase current 400 Volt, 50 Hz, protection category IP55																			
VARD 630/8 Ex	06718	705	10220	0.95	400	2.75	–	470	40	–	110.0	148	not permitted	not permitted	SDD 2	SDZ 2			
VARD 630/6 Ex	06719	950	13990	1.90	400	4.70	–	470	40	–	130.0	170	not permitted	not permitted	SDD 2	SDZ 2			
VARD 630/4 Ex ³⁾	06720	1435	21400	6.80	400	13.1	–	498	40	–	165.0	251	not permitted	not permitted	SDD 2	SDZ 3			

* For Ex types: Motor ratings see information on page 16. ¹⁾ incl. motor protection circuit breaker and sine filter. ²⁾ includes operating and speed switch.
³⁾ Flush-m. version see Switch product page. ⁴⁾ for PTC thermistor temperature sensor. ⁵⁾ A vibration monitoring system (on-site) must be provided according to DIN EN 14986.

Performance curve VAR 630/4

n=1450 1/min

Frequency	Hz	Tot.	125	250	500	1k	2k	4k	8k
L _{WA}	Air noise	dB(A)	97	73	89	91	93	84	74
L _{PA, 4m}	Air noise	dB(A)	77	53	69	71	71	64	54

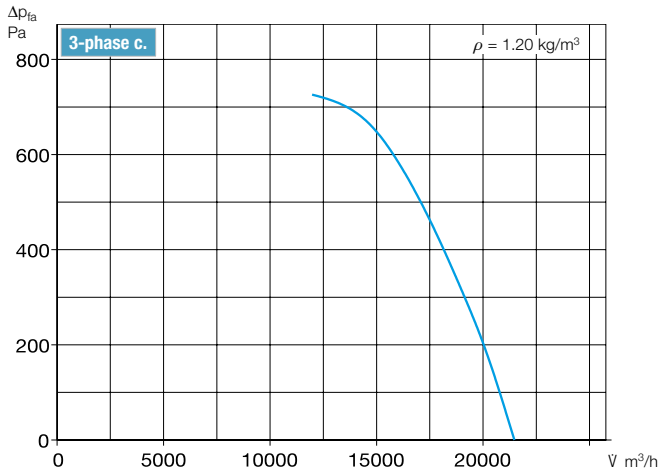

Performance curve VAR 630/6

n=1450 1/min

Frequency	Hz	Tot.	125	250	500	1k	2k	4k	8k
L _{WA}	Air noise	dB(A)	87	70	76	82	83	78	62
L _{PA, 4m}	Air noise	dB(A)	67	50	56	62	63	58	42

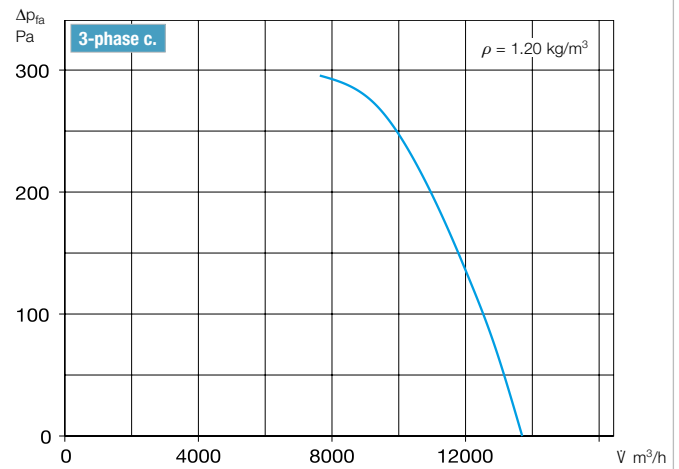

Performance curve VAR 630/8

n=725 1/min

Frequency	Hz	Tot.	125	250	500	1k	2k	4k	8k
L _{WA}	Air noise	dB(A)	80	65	71	76	75	62	55
L _{PA, 4m}	Air noise	dB(A)	60	45	51	56	55	42	35

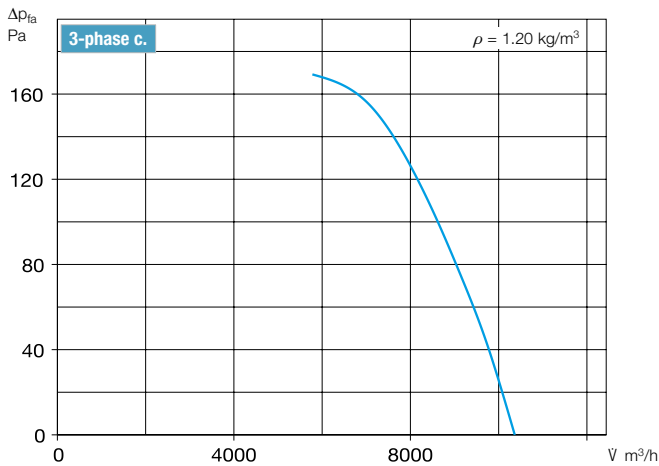

Other accessories Page

^{b)}Access. for expl.-proof fans

Flanged flexible connector
STS 630 Ex Ref. no. 02509

Flexible connecting sleeve
FM 630 Ex Ref. no. 01696

Filters and silencers 473 ff.

Shutters and

ventilation grilles 553 ff.

Speed controllers, controllers
and switches 591 ff.

Accessories VAR 630 Description see page 268 ff.

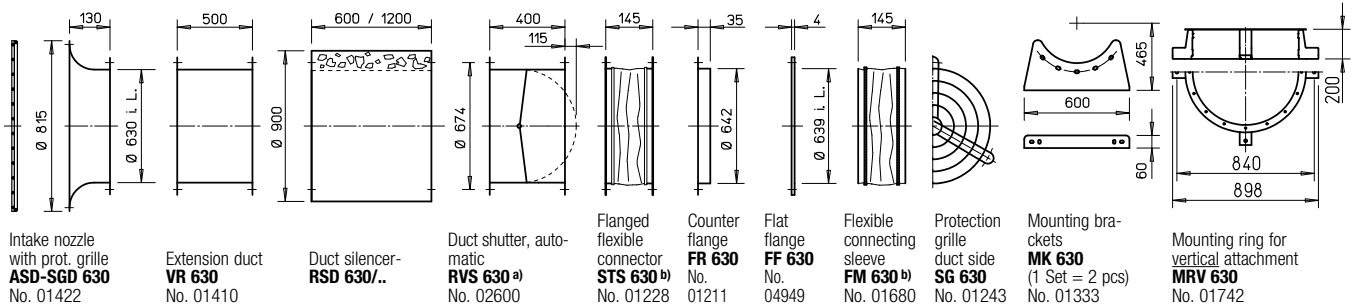

^{a)} Shutter, motorised see Accessories product pages. ^{b)} Types for explosion-proof fans see left page.

Smooth installation guaranteed – like clockwork.

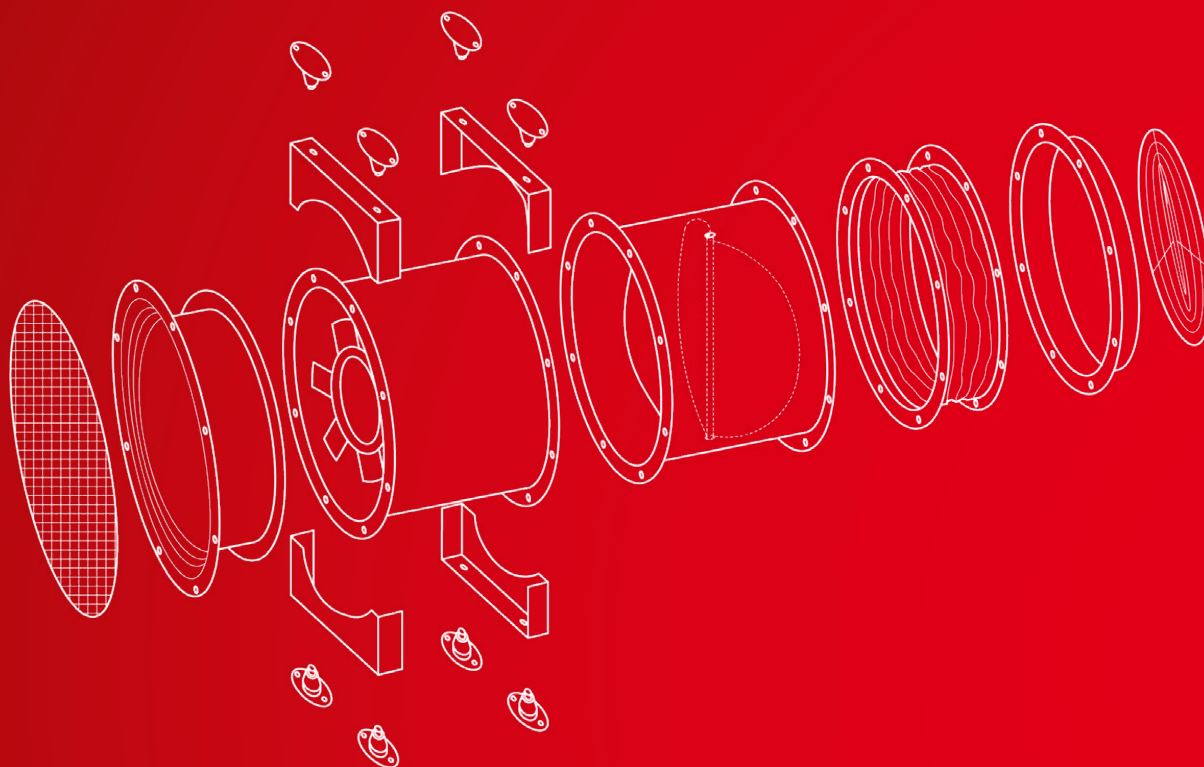

■ **Installation accessories circular duct fans**

Whatever the installation and duct connection requirements: Helios' wide range includes the right system components. From the intake nozzle to the electric duct shutter and vibration dampers.

269ff

■ **Silencers, air filters, heating elements**

Helios air treatment components provide for clean, warm and calm air. The extensive range includes all sizes and capacities, perfectly tailored to Helios fans. This provides the necessary flexibility for planning and installation.

473ff

■ **Shutters, ventilation grilles**

Weather-proof and corrosion-free. Made of break-resistant, UV-resistant plastic with a long service life. Helios shutters and weather protection grilles stand out due to their appealing design, robustness and ease of installation.

553ff

■ **Speed controllers, frequency inverters, controllers, switches**

In addition to the specific installation accessories for round duct fans, Helios offers a wide range of control and switching devices which are perfectly tailored to round duct fans.

591ff

ASD-SGD

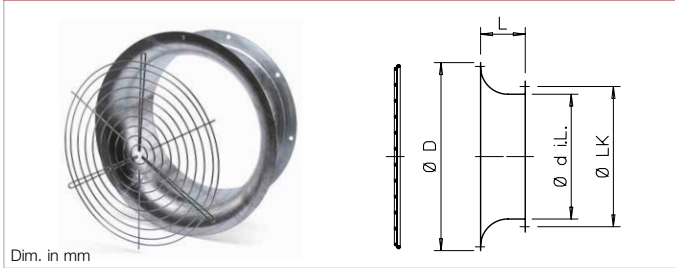

■ **Intake nozzle with protection grille** and large entry radius. Made sheet. With flange on connection side in accordance with DIN 24155, p. 2. Powder-coated protection

grille for inlet side coverage (galvanised from Ø 800) in accordance with DIN EN ISO 13857.

Type	Ref. no.	Ø D	L	Ø D i.L.	Ø LK	Weight aprx. kg
ASD 200*	01388	310	140	203	235	0.9
ASD-SGD 225	01413	345	140	225	259	2.5
ASD-SGD 250	01414	370	140	250	286	2.8
ASD-SGD 280	01415	400	140	280	322	3.2
ASD-SGD 315	01416	435	140	315	356	3.5
ASD-SGD 355	01417	475	140	355	395	4.0
ASD-SGD 400	01418	545	140	400	438	4.5
ASD-SGD 450	01419	595	140	450	487	5.7
ASD-SGD 500	01420	625	140	500	541	6.3
ASD-SGD 560	01421	745	130	560	605	7.0
ASD-SGD 630	01422	815	130	630	674	7.6
ASD-SGD 710	01423	955	200	710	751	19.5
ASD-SGD 800	01424	1060	200	800	837	22.3
ASD-SGD 900	01309	1140	200	900	934	25.0
ASD-SGD 1000	01310	1240	200	1000	1043	28.5

* without protection grille.

SG

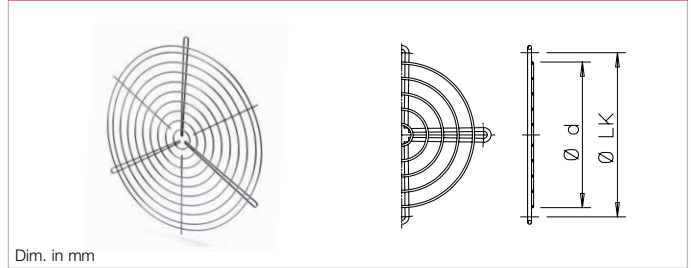

■ **Protection grille** for outlet side coverage. Powder-coated, colour: silver metallic (galvanised from Ø 800).

Dimensions and mounting clips tailored to fan/flange pipe nominal size in accordance with DIN 24155, p. 2. DIN EN ISO 13857.

Type	Ref. no.	Ø D	Ø LK	Weight aprx. kg	Number of attachment points
SG 200	01216	190	235	0.1	3
SG 225	01215	224	259	0.2	3
SG 250	01236	241	286	0.2	3
SG 280	01428	270	322	0.3	4
SG 315	01237	310	356	0.4	4
SG 355	01238	350	395	0.4	4
SG 400	01239	390	438	0.5	3
SG 450	01240	450	487	0.6	3
SG 500	01241	490	541	0.7	3
SG 560	01242	550	605	0.9	4
SG 630	01243	630	674	1.5	4
SG 710	01244	710	751	1.8	4
SG 800	01245	790	837	2.2	4
SG 900	01246	890	934	2.7	4
SG 1000	01290	990	1043	3.5	4

RVS



■ **Automatic duct shutter with spring return¹⁾**
Can be installed horizontally in any direction, vertically with through-flow from bottom to top. Shutter opening in flow direction; automatic function through fan operation. Spring mechanism outside of air

flow. Locking force depends on fan power and installation position can be changed. Shutter and casing made of galvanised steel sheet, shutter made of aluminium for nominal size 225 – 560 mm. Double-sided flange. Holes pursuant to DIN 24155, p. 2.

Type ²⁾	Ref. no.	Ø D i.L.	L	A	Ø LK	Weight aprx. kg
RVS 225	02591	225	300	—	259	3.0
RVS 250	02592	250	300	—	286	3.4
RVS 280	02593	280	300	—	322	3.9
RVS 315	02594	315	300	—	356	4.3
RVS 355	02595	355	300	—	395	5.0
RVS 400	02596	400	330	—	438	7.2
RVS 450	02597	454	330	15	487	10.4
RVS 500	02598	504	330	40	541	11.7
RVS 560	02599	560	330	65	605	16.1
RVS 630	02600	630	400	115	674	19.5
RVS 710	02601	710	400	155	751	26.5
RVS 800	02602	800	420	200	837	37.3
RVS 900	02603	900	420	250	934	41.8
RVS 1000	02604	1000	420	300	1043	47.3

¹⁾ Pressure loss diagram see page 556. ²⁾ Ambient temperature –30 to +100 °C.

RVM

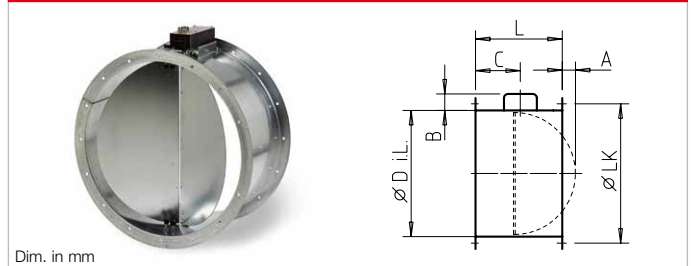

■ **Motorised duct shutter¹⁾**
like RVS, but can be installed horizontally and vertically in any direction and with a mounted spring return motor (outside of air flow). Elec. control parallel with fan; cable length 0.9 m, normally closed.

Ambient temperature –30 to +60 °C
Protection category IP54
Voltage/Frequency 230 V AC, 50/60 Hz
Power consumption – up to Ø 560 / from Ø 630 14 W/6.5 W
Shutter opening time, approx. 75 sec.
Wiring diagram no. 380.1

Type ³⁾	Ref. no.	Ø D i.L.	B	C	L	A	Ø LK	Weight aprx. kg
RVM 225	02575	225	95	130	300	—	259	3.3
RVM 250	02576	250	95	130	300	—	286	3.7
RVM 280	02577	280	95	130	300	—	322	4.2
RVM 315	02578	315	95	130	300	—	356	4.6
RVM 355	02579	355	95	130	300	—	395	5.3
RVM 400	02580	400	95	130	330	—	438	7.5
RVM 450	02581	454	95	130	330	15	487	10.7
RVM 500	02582	504	95	130	330	40	541	12.0
RVM 560	02583	560	95	130	330	65	605	16.4
RVM 630	02609	630	150	225	400	115	674	21.0
RVM 710	02610	710	150	225	400	155	751	28.0
RVM 800	02614	800	150	225	420	200	837	37.8
RVM 900	02615	900	150	225	420	250	934	42.3
RVM 1000*	02616	1000	150	225	420	300	1043	47.8

³⁾ Types RVM not for use in potentially explosive areas. *RVM 1000 only for horizontal throughflow.

VR

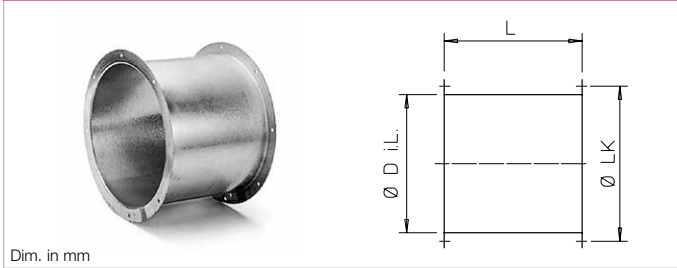

Extension duct

Pipe section with double-sided flanges and holes according to DIN 24155, p. 2. Made of hot-dip galvanised steel sheet for the

extension of the fan shaft. For types with protruding motor, for installation in pipeline. Prevents power losses in case of free outlet.

Type	Ref. no.	Ø D i.L.	L	Ø LK	Weight aprx. kg
VR 225	01401	225	300	259	2.5
VR 250	01402	250	300	286	2.8
VR 280	01403	280	300	322	3.2
VR 315	01404	315	300	356	3.5
VR 355	01405	355	300	395	4.0
VR 400	01406	400	330	438	6.0
VR 450	01407	454	330	487	9.0
VR 500	01408	504	330	541	10.0
VR 560	01409	560	500	605	14.0
VR 630	01410	630	500	674	15.5
VR 710	01411	710	500	751	21.5
VR 800	01412	800	420	837	31.0
VR 900	01311	900	420	934	34.0
VR 1000	01312	1000	420	1043	37.6

STS

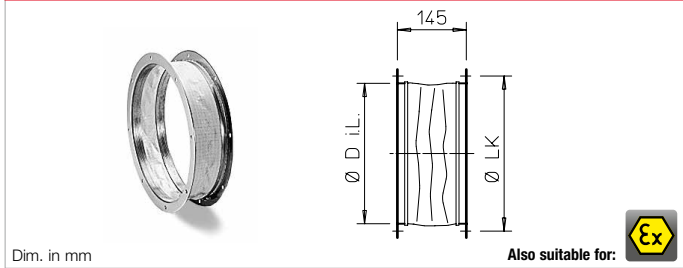

Flanged flexible connector

Flexible connector for installation between the fan and duct system. Prevents structure-borne noise transmission, bridges installation

tolerances. Elastic sleeve made of silicone-free PVC fabric (max. + 80 °C). With galvanised angle flange rings on both sides, dimensions according to DIN 24155 p. 2.

Type	Ref. no.	Ex Ex Type*	Ref. no.	Ø D i.L.	Ø LK	Weight aprx. kg
STS 200	01219	—	—	205	235	1.3
STS 225	01218	STS 225 Ex	02500	229	259	1.1
STS 250	01220	STS 250 Ex	02501	252	286	1.3
STS 280	01231	STS 280 Ex	02502	288	322	1.5
STS 315	01221	STS 315 Ex	02503	322	356	1.8
STS 355	01222	STS 355 Ex	02504	361	395	2.3
STS 400	01223	STS 400 Ex	02505	404	438	2.5
STS 450	01224	STS 450 Ex	02506	453	487	3.8
STS 500	01225	STS 500 Ex	02507	507	541	3.4
STS 560	01226	STS 560 Ex	02508	570	605	4.5
STS 630	01228	STS 630 Ex	02509	638	674	4.6
STS 710	01229	STS 710 Ex	02510	711	751	7.0
STS 800	01233	STS 800 Ex	02511	801	837	7.5
STS 900	01234	STS 900 Ex	02512	898	934	7.5
STS 1000	01235	STS 1000 Ex	02513	1004	1043	15.0

* for explosion-proof fans.

FR / FF

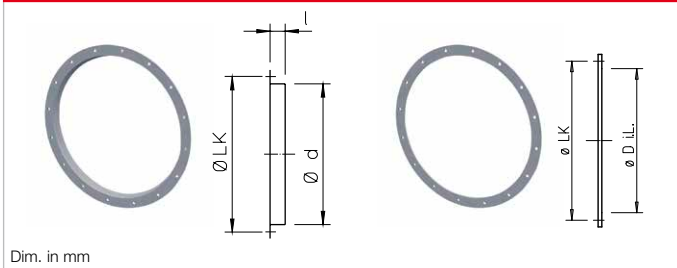

**Counter flange FR/
Flat flange FF**

Angle flange ring/flat flange ring made of galvanised steel sheet. Dimensions/holes according to DIN 24155 p. 2.

Type	Ref. no.	Type	Ref. no.	Ø LK	l	Ø D	Ø D i.L.	Weight aprx. kg
FR 200	01202	—	—	235	25	209	—	0.5
FR 225	01201	—	—	259	30	233	—	0.5
FR 250	01203	FF 250	04941	286	25	256	256	0.7
FR 280	01214	FF 280	04942	322	30	292	286	0.9
FR 315	01204	FF 315	04943	356	30	326	321	1.0
FR 355	01205	FF 355	04944	395	30	365	361	1.1
FR 400	01206	FF 400	04945	438	30	408	409	1.2
FR 450	01207	FF 450	04946	487	35	457	459	1.3
FR 500	01208	FF 500	04947	541	35	511	509	1.5
FR 560	01209	FF 560	04948	605	35	574	569	2.1
FR 630	01211	FF 630	04949	674	35	642	639	2.3
FR 710	01212	FF 710	04950	751	35	715	719	3.1
FR 800	01198	FF 800	04951	837	35	806	809	3.9
FR 900	01199	FF 900	04952	934	35	903	909	4.4
FR 1000	01210	FF 1000	04953	1043	35	1012	1009	9.5

FM

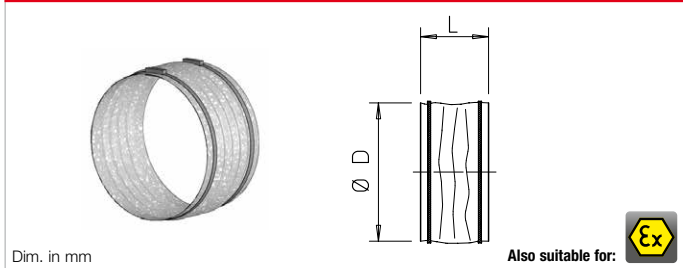

Flexible connecting sleeve

incl. 2 hose clamps. Installation between fan and duct system. Prevents structure-borne noise

transmission, bridges installation tolerances. Elastic sleeve made of silicone-free PVC fabric (max. temp. + 70 °C). Dimensions according to DIN 24155, p. 2.

Type	Ref. no.	Ex Ex Type*	Ref. no.	Ø D	L	Weight aprx. kg
FM 200	01670	FM 200 Ex	01686	213	145	0.2
FM 225	01671	FM 225 Ex	01687	235	145	0.2
FM 250	01672	FM 250 Ex	01688	260	145	0.2
FM 280	01673	FM 280 Ex	01689	296	145	0.2
FM 315	01674	FM 315 Ex	01690	330	145	0.2
FM 355	01675	FM 355 Ex	01691	369	145	0.3
FM 400	01676	FM 400 Ex	01692	412	145	0.3
FM 450	01677	FM 450 Ex	01693	461	145	0.3
FM 500	01678	FM 500 Ex	01694	515	145	0.4
FM 560	01679	FM 560 Ex	01695	577	145	0.4
FM 630	01680	FM 630 Ex	01696	646	145	0.4
FM 710	01666	—	—	720	145	0.5

* for explosion-proof fans.

MK

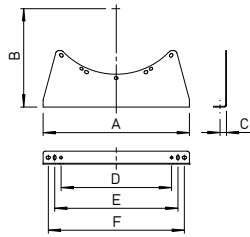

Dim. in mm

■ Mounting bracket

For attaching the fan flange casing to ceilings, walls or floors. Made of hot-dip galvanised steel. Hole matches the hole circle of the fan flange. Delivered as pair including screws and nuts.

■ Reference

In case of heavy motors, an extension duct VR (accessories) should be provided to place the centre of gravity. Attach the brackets to both external flanges.

Type	Ref. no.	A	B	C	D	E	F	Weight aprx. kg
MK 200-225	01446	310	208/220	20	—	220	265	1.5
MK 250-280	01447	340	227/245	20	—	240	285	1.7
MK 315-355	01448	380	281/300	25	250	295	340	2.2
MK 400-450	01449	360	311/335	25	240	280	320	2.6
MK 500	00674	570	383	25	430	480	530	5.3
MK 560	00675	570	415	25	430	480	530	5.3
MK 630	01333	600	465	30	460	510	560	8.5
MK 710	01372	670	515	35	515	565	620	10.5
MK 800	01373	680	565	35	500	550	—	15.5
MK 900	01374	760	625	35	580	630	—	18.0
MK 1000	01375	840	690	35	710	—	—	19.5

SDD-U

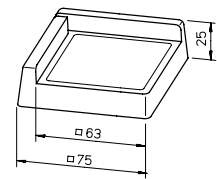

Dim. in mm

■ Vibration damper mounts

The elastic rubber elements SDD-U are suitable as mounts for the free-standing indoor installation of ventilation units on flat, horizontal surfaces. They prevent the direct transmission of vibrations and structure-borne noise to other

parts of buildings. A set consists of four elements which are placed under the corners of the ventilation unit. Maximum pressure load: 40 kg/element = total 160 kg.

SDD-U Ref. no. 05627

SDD

SDD 1 - 3



SDD 1F, 4 - 10



Dim. in mm

SDD 1

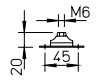

SDD 2

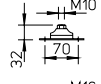

SDD 3

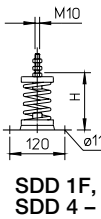
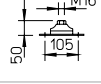

SDD 1F, SDD 4 - 10

■ Vibration dampers for compression load

For vibration and noise-insulating installation of fans on horizontal surfaces. Easy installation in combination with MK (accessories). Selection according to fan weight, see table.

Rubber bonded metal elements must be used for small and medium weight loads and temperatures up to max. +60 °C, and spring-type vibration dampers must be used for high loads and temperatures above +60 °C (e.g. smoke extraction).

Type	Ref. no.	Max. fan weight kg	H Height in mm	Spring-type vibration damper	Delivery unit 1 set = 4 pcs
SDD 1	01452	80	*	•	
SDD 1F	01942	80	112 - 87	•	
SDD 2	01453	180	*	•	
SDD 3	01367	750	*	•	
SDD 4	01944	130	112 - 87	•	
SDD 5	01924	210	112 - 86	•	
SDD 6	01926	350	112 - 85	•	
SDD 7	01928	520	112 - 85	•	
SDD 8	01930	900	112 - 82	•	
SDD 9	01934	1300	112 - 85	•	
SDD 10	01951	1800	112 - 88	•	

* specified in dimensional drawing.

SDZ

SDZ 1 - 2



SDZ 3

(no Fig., with square four-point attachment)

SDZ 1F, 4 - 9



Dim. in mm

SDZ 1

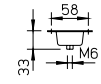

SDZ 2

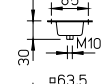

SDZ 3

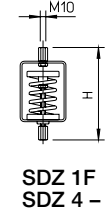
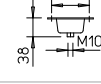

SDZ 1F, SDZ 4 - 9

■ Vibration dampers for tensile load

For vibration and noise-insulating fan suspension (ceiling mounting). Design, description and delivery according to SDD series.

■ Important installation note for vibration dampers:

A uniform load distribution (balance centre of gravity in case of heavy motor) must be ensured during installation.

Type	Ref. no.	Max. fan weight kg	H Height in mm	Spring-type vibration damper	Delivery unit 1 set = 4 pcs
SDZ 1	01454	60	*	•	
SDZ 1F	01943	80	190 - 215	•	
SDZ 2	01455	160	*	•	
SDZ 3	01366	300	*	•	
SDZ 4	01945	130	190 - 215	•	
SDZ 5	01925	210	190 - 216	•	
SDZ 6	01927	350	190 - 217	•	
SDZ 7	01929	520	190 - 217	•	
SDZ 8	01931	900	190 - 220	•	
SDZ 9	01935	1300	190 - 217	•	

* specified in dimensional drawing.

DIF

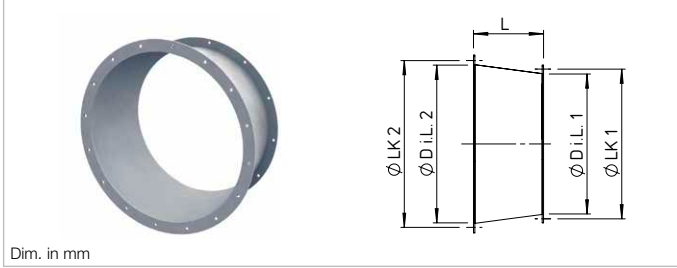

Dim. in mm

■ Diffusor DIF

Aerodynamically optimised diffusor for high pressure recovery. Delays air flow due to size step to convert dynamic pressure to static pressure. Additional application as an adapter for an optimised transition to the next size. Specially developed for application directly behind a fan and at the end of a pipeline as an outdoor outlet with reduced

outlet losses. In case of a free outlet at the diffusor, the protection grille (type SG) can be used in the next larger dimension. High-quality design made of hot-dip galvanised steel sheet with double-sided welded flange, hole pattern according to DIN 24155.

Type	Ref. no.	Size step	L	Ø D.i.L. 1	Ø LK 1	Ø D.i.L. 2	Ø LK 2	Weight aprx. kg
DIF 250	40230	250 to 400	200	250	286	400	438	5.5
DIF 280	03551	280 to 315	140	280	322	315	356	4.1
DIF 315	03552	315 to 355	160	315	356	355	395	4.9
DIF 355	03553	355 to 400	180	355	395	400	438	5.9
DIF 400	03554	400 to 450	200	400	438	450	487	7.0
DIF 450	03555	450 to 500	225	450	487	500	541	8.4
DIF 500	03556	500 to 560	250	500	541	560	605	11.5
DIF 560	03565	560 to 630	280	560	605	630	674	15.4
DIF 630	03566	630 to 710	315	630	674	710	751	19.0
DIF 710	03567	710 to 800	355	710	751	800	837	24.1
DIF 800	03568	800 to 900	400	800	837	900	934	37.8
DIF 900	03569	900 to 1000	450	900	934	1000	1043	45.7
DIF 1000	03570	1000 to 1120	500	1000	1043	1120	1174	54.9
DIF 1120	03571	1120 to 1250	560	1120	1174	1250	1311	66.5
DIF 1250	03572	1250 to 1400	630	1250	1311	1400	1465	81.3

MRV

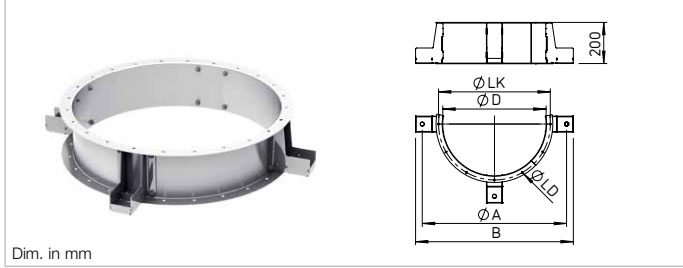

Dim. in mm

■ Mounting ring MRV

The mounting ring MRV is intended for the vertical attachment of fans (e.g. Helios types AVD, AMD, VAR etc.). Four mounting brackets for direct attachment or mounting vibration dampers (SDZ or SDD) ensure the secure vertical installation of fans. Made of hot-dip galvanised steel sheet.

Type	Ref. no.	Ø A	B	Ø D	Ø LK	Ø LD	Weight aprx. kg	Load capacity kg
MRV 315	01755	510	576	315	356	9.5 (8x)	6.5	280
MRV 355	01759	550	618	355	395	9.5 (8x)	6.9	280
MRV 400	01760	595	662	400	438	9.5 (12x)	7.4	280
MRV 450	01761	650	714	450	487	9.5 (12x)	7.9	280
MRV 500	01740	700	765	500	541	9.5 (12x)	8.3	280
MRV 560	01741	770	827	560	605	11.5 (16x)	12.9	390
MRV 630	01742	840	898	630	674	11.5 (16x)	13.9	390
MRV 710	01743	920	980	710	751	11.5 (16x)	15.7	390
MRV 800	01744	1030	1101	800	837	11.5 (24x)	24.8	1050
MRV 900	01745	1130	1201	900	934	11.5 (24x)	27.0	1050
MRV 1000	01749	1230	1301	1000	1043	11.5 (24x)	29.1	1050

Helios box fans. Powerful. Flexible. Compact.

Helios box fans are true all-rounders, offering almost unlimited flexibility in various applications. The compact design and the easy-to-install accessories allow optimal adaptation to the structural conditions of your project at any time.

■ GigaBox centrifugal fans

Efficient EC version.
Also available in T120 version up to max. 120 °C.

Ø 250 – 710 mm
V̇ = 2010 – 18 940 m³/h



278^{ff}

■ GigaBox centrifugal fans

Standard AC version.
Also available in T120 version up to max. 120 °C.

Ø 250 – 710 mm
V̇ = 1410 – 20 280 m³/h



Also available in version:



296^{ff}

■ GigaBox centrifugal fans

Product-specific information, selection table.

274^{ff}

Box fans

■ Fresh air boxes

Efficient EC version.
With electric or warm water heating and air filter.



332^{ff}

■ MegaBox centrifugal fans

Efficient EC version.

Ø 225 – 400 mm
V̇ = 1350 – 6550 m³/h

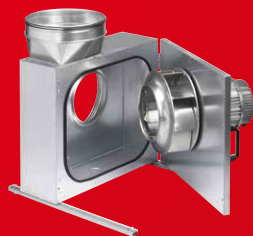

314^{ff}

■ MegaBox centrifugal fans

Standard AC version.

Ø 160 – 400 mm
V̇ = 960 – 7500 m³/h



Also available in version:



323^{ff}

■ MegaBox centrifugal fans

Product-specific information, selection table.

312^f

GigaBox and accessories

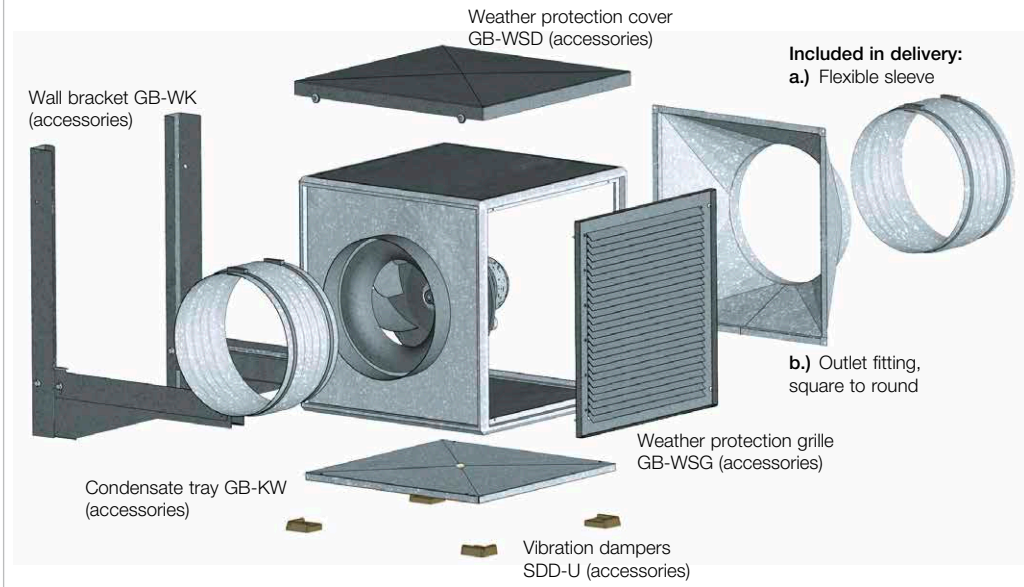

Reference	Page
Planning information, acoustics	10 ff.
General techn. information, power control	15 ff.

■ **Application**

Multifunctional fan box for the transportation of medium to large volume flows against high resistances in ventilation systems of all kinds. The compact frame design and easy-to-install accessories allow variable and thus optimal adaptation to structural conditions by simply repositioning the casing panels.

□ **GB T120 and GB EC T120**

The GigaBox T120 types are designed for the delivery of contaminated, humid and hot air up to max. 120 °C, e.g. as extract air fans in commercial kitchens and many process technology applications. GigaBox T120 types with EC drive technology are optionally available for energy-saving applications and the lowest operating costs.

□ **GB EC**

GigaBox types with EC drive technology are optionally available for energy-saving applications and the lowest operating costs.

■ **Casing**

Self-supporting frame construction made of aluminium hollow profiles. Double-walled, 20 mm thick side panels made of galvanised steel sheet, sound and heat insulated by non-flammable mineral wool lining.

Nozzle on inlet side for optimal inflow as well as connectors and flexible connecting sleeve for duct connection. Moulded part (square to round) on outlet side for low-loss outflow and flexible connecting sleeve to prevent structure-borne noise transmission. The flexible connecting sleeves included in the scope of delivery correspond to a maximum permissible air flow temperature of +70 °C or +120 °C

for types GB T120 and GB EC T120. Simple positioning with standard crane hook.

- The drive motor is located outside of the air flow for GB T120 and GB EC T120. The thermally insulated partition is also the support plate for the motor-impeller unit and it can be completely removed for inspection without dismantling the system components.

■ **Power control**

□ **GB and GB T120**

All types (excluding GBD 630/4 T120, GBD 710/4 and GBD 710/4 T120) are speed-controllable using 5-step transformer or electronic controllers. The 3~ GB types can also be inexpensively operated at two speeds using a ∇/Δ switch (accessory DS 2 or motor protection circuit breaker M4). Performance levels are shown in the performance diagram.

Control by means of frequency converter with integrated sine filter (FU-BS, accessories) is possible for 3~ types;

GBD 630/4 T120, GBD 710/4 and GBD 710/4 T120 can only be controlled by frequency converter FU-BS.

□ **GB EC and GB EC T120**

All EC types have continuously variable speed control with internal (delivery) or external via speed potentiometer. Control is also possible via three level switch or continuously variable via universal control system or electronic differential pressure/temperature controller. Performance levels are shown on the performance curve as examples.

■ **Positioning, installation**

□ **GB and GB EC**

Any installation position and flexible installation due to five possible outlet directions of the outlet fitting. Removable side panels allow inspection access from all sides.

□ **GB T120 and GB EC T120**

Installation position with condensate drain below. Flexible installation due to three possible centrifugal outlet directions of the outlet fitting. Inspection cover with handle, easily removable for cleaning and maintenance. Simple positioning with crane hook as standard. The transmission of structure-borne noise to buildings is minimised by vibration dampers (type SDD-U, accessories). The transmission of vibrations to the duct system is prevented by the standard flexible connecting sleeves.

■ **Impeller**

Free-running high performance centrifugal impeller with backward curved plastic blades (nominal size 250 made of steel) on galvanised steel plate, directly driven. Series GB EC, GB from nominal size 500 and GB T120 and GB EC T120 with aluminium impellers. Energy-efficient with low noise emission. Dynamically balanced together with the motor in accordance with DIN ISO 21940-11 – quality grade 6.3 or 2.5.

■ **Drive**

□ **GB and GB T120**

IEC standard motor or maintenance-free external rotor motor in protection category IP54 or 44. Thermal overload protection through thermal contacts in the winding. Suitable for continuous operation S1. Insulation class F. The ball bearings have a sufficient

lubricant supply for their service life.

□ **GB EC**

Energy-saving, speed-controllable EC external rotor motor in protection category IP54 with the highest level of efficiency. Maintenance-free and radio interference-free, ball bearing mounted.

■ **Electrical connection**

□ **GB and GB T120**

Standard terminal box, only for alternating currents.

■ **Air flow direction**

The air flow direction cannot be changed for centrifugal fans, but it can be set by the corresponding positioning. The throughflow can also be individually adapted to structural conditions by converting the outlet fitting and panels. The correct motor rotation direction and air flow direction is marked by arrows on the fan and must be checked during commissioning.

■ **Incorrect direction of rotation**

Operation in the incorrect direction of rotation overloads the AC motor and causes the thermal contacts to respond. Typical concomitant features include: Low flow rate, vibration and abnormal noise.

■ **Air flow temperature**

The maximum permissible air flow temperature is shown in the type table.

■ **Ambient temperature**

From –40 °C to +40 °C.

VDI 2052 “Ventilation equipment for kitchens – Planning, design, inspection” is applied for the planning of extract air systems in commercial kitchens. The following applies for extract air fans:

- Fans in extraction systems must be designed and installed so that they can be easily accessed, easily controlled and cleaned. It must be possible to deactivate them from the kitchen. The drive motors must be located outside of the extract air volume flow. Connected extraction hoods must separate solid and liquid components as far as possible. Flame propagation to downstream components must be prevented.

These specific requirements are remarkably fulfilled by the GigaBoxes GB T120 and GB EC T120. The freely accessible casing and double-walled side panels allow problem-free cleaning with degreasing agents and steam.

The guideline on fire protection requirements pertaining to ventilation systems (LüAR ventilation system guideline) of September 2006 has been largely introduced nationwide by law.

This resulted in additional requirements for extract air systems in commercial and comparable kitchens:

- Extract air ducts must also be made of non-combustible materials (building material class A1 or A2 pursuant to DIN 4102). From the point of exit from the kitchen, they must have fire resistance class L90 at least or be equipped with a damper with proof of use for this purpose.
- Kitchen extract air ducts must not be interconnected or connected to other ventilation ducts. The combination of room air with the cooking zone extraction within the kitchen as well as the connection of multiple kitchen extraction hoods to one shared extract air duct is permitted.
- Suitable grease filters or separating elements made of non-combustible materials must be connected to or directly behind the extraction systems (hoods or ventilation ceilings). It must be possible to easily install and remove these for cleaning.

- The extract air ducts must have smooth inner surfaces which are easy to clean. Profiled walls such as e.g. flexible ducts and porous or absorbent building materials are not permitted. Grease and condensate must not leak through the walls.

- The extract air ducts must have inspection openings at distances of max. 3 m after each change of direction and in horizontal, straight sections. Their dimensions must correspond to the duct cross-section or at least 3600 cm². Devices for catching and draining condensate and cleaning agents must be provided at suitable points in the pipeline.

■ Fire protection for neighbouring buildings

If a ventilation system is located on the building envelope (wall), the ventilation system parts must have a fire-resistant lining L90. This also applies to fans and their extract air ducts which lead outside (up to the roof).

■ Fire protection in the attic

Ventilation system (fan) parts in the attic must have a fire-resistant lining L90.

Ducts which lead outside must be lined up to the roofing. Ventilation ducts (in the building and attic) must have a fire-resistant lining.



- With regard to the GigaBox T120 series, the motor is located outside of the air flow and it is separated from the impeller by a thermally insulated wall. The motor-impeller unit can be removed without dismantling the duct system.

- Installation of outlet-side fitting for GB T120 and GB EC T120 radially upwards or laterally.

- GB T120 and GB EC T120 with easily removable inspection cover.

GigaBox EC centrifugal fans



Selection table



By combining the parameters of static pressure increase ΔP_{ra} , case-radiated noise and inlet side air noise as sound pressure at

4 m (free field conditions), the following table facilitates the selection of GigaBox EC centrifugal fans.

 Type	Sound press. Radiation	Sound press. Inlet side	Flow rate V m ³ /h depending on static pressure												
	L _{PA} dB(A)	L _{PA} dB(A)	(ΔP _{ra}) in Pa												
	at 4 m dist.	at 4 m dist.	0	50	100	150	200	250	300	350	400	500	600	700	800
GBW EC 250	31	43	2010	1880	1750	1600	1360	1010							
GBW EC 315	32	44	2620	2460	2310	2130	1830	1500							
GBW EC 355	30	49	3440	3270	3120	2950	2740	2500	2135	1630					
GBW EC 400 A	36	48	4050	3860	3600	3350	3050	2670	1880						
GBW EC 400 B	37	52	5160	4970	4730	4550	4210	4100	3800	3410	2900				
GBW EC 450	38	55	6460	6280	6100	5890	5660	5450	5190	4870	4600	3810			
GBD EC 450	39	56	7450	7240	7010	6760	6520	6270	6000	5690	5340	4420	390		
GBD EC 500 A	43	55	8450	8070	7740	7420	7030	6570	6140	5650	4890				
GBD EC 500 B	46	59	10670	10440	10210	9960	9700	9450	9200	8930	8620	7990	7210	5990	560
GBD EC 560	49	60	13970	13720	13460	13180	12880	12560	12240	11910	11540	10670	9680	8090	5150
GBD EC 630	44	60	15570	15170	14760	14360	13950	13520	13050	12560	11990	10450	8160		
GBD EC 710 A	42	53	15680	15030	14350	13680	12950	11880	10880	9450	6560				
GBD EC 710 B	48	61	18940	18370	17920	17400	16830	16220	15570	14850	14040	11880	6930		

  Type	Sound press. Radiation	Sound press. Inlet side	Flow rate V m ³ /h depending on static pressure												
	L _{PA} dB(A)	L _{PA} dB(A)	(ΔP _{ra}) in Pa												
	at 4 m dist.	at 4 m dist.	0	100	200	300	400	500	600	700	800	900	1000	1100	1200
GBW EC 250 T120	40	52	2340	2140	1890	1630	1320	800							
GBW EC 315A T120	39	52	3030	2750	2390	1920	800								
GBW EC 355 T120	40	53	3830	3470	3020	2420	1210								
GBD EC 355 T120	40	53	3840	3470	3030	2420	1210								
GBW EC 400 T120	43	56	4730	4280	3730	2870	1490								
GBD EC 400 T120	46	56	5410	5010	4510	3930	3130	1990							
GBW EC 450 T120	45	57	6200	5720	5070	4130	2610								
GBD EC 450 T120	48	60	7080	6610	6140	5460	4660	3350							
GBD EC 500 T120	51	63	9610	9110	8550	7960	7170	6180	4920	2530					
GBD EC 560 T120	53	65	11650	11140	10630	10090	9510	8870	8060	7140	5520				
GBD EC 630 T120	54	68	14540	14060	13600	13150	12660	12050	11330	10540	9530	8060	4590		
GBD EC 710 T120	51	65	18360	17910	17440	16930	16370	15730	15030	14250	13330	12210	10920	9300	6760

By combining the parameters of static pressure increase ΔP_{sta} , case-radiated noise and inlet side air noise as sound pressure at

4 m (free field conditions), the following table facilitates the selection of GigaBox AC centrifugal fans.

Type	Sound press. Radiation	Sound press. Inlet side	Flow rate \dot{V} m ³ /h depending on static pressure												
	L_{PA} dB(A)	L_{PA} dB(A)	(ΔP_{sta}) in Pa												
	at 4 m dist.	at 4 m dist.	0	50	100	150	200	250	300	350	400	500	600	700	800
GBW 250/4	27	39	1420	1160	890	500									
GBW 315/4	29	41	1760	1500	1260	970	560								
GBW 355/4	38	48	3060	2850	2640	2420	2180	1900	1510	560					
GBD 355/4/4	34	46	3090	2910	2720	2520	2290	2030	1680	1000					
GBW 400/4	38	50	4120	3920	3720	3500	3270	3000	2690	2260	1440				
GBD 400/4/4	38	50	4120	3910	3710	3500	3290	3050	2780	2430	1870				
GBW 450/4	40	49	4610	4400	4200	3990	3770	3530	3270	2970	2610				
GBD 450/4/4	33	49	6500	6220	5940	5660	5350	5000	4660	4300	3770	2060	110	6110	
GBW 500/4	47	59	8320	8020	7740	7460	7180	6910	6630	6340	6030	5330	4340	370	
GBD 500/4/4	45	57	8860	8540	8220	7880	7530	7160	6770	6350	5900	4800	2940	140	
GBW 560/4	45	57	9150	8910	8670	8420	8160	7890	7620	7330	7030	6360	5570	4500	2270
GBD 560/4/4	44	57	12610	12260	11910	11560	11200	10830	10450	10050	9630	8690	7540	5950	2940
GBD 560/6/6	35	48	8670	8160	7600	6990	6280	5410	4210	2190					
GBD 630/4/4	51	62	14430	14070	13710	13370	13040	12720	12390	12050	11710	11000	10200	9280	8110
GBD 630/6/6	42	53	9990	9430	8870	8290	7670	6980	6160	5070	3020				
GBD 710/4	46	59	20280	20020	19760	19490	19210	18930	18640	18340	18040	17400	16730	15990	15190
GBD 710/6/6	51	62	18740	17980	17190	16360	15490	14560	13550	12440	11170	7730	970		

Type	Sound press. Radiation	Sound press. Inlet side	Flow rate \dot{V} m ³ /h depending on static pressure												
	L_{PA} dB(A)	L_{PA} dB(A)	(ΔP_{sta}) in Pa												
	at 4 m dist.	at 4 m dist.	0	100	200	300	400	500	600	700	800	900	1000	1100	1200
GBW 355/4 T120	36	49	3460	2990	2460	1505									
GBD 355/4/4 T120	36	49	3470	3045	2510	1690									
GBW 400/4 T120	40	53	4930	4380	3790	2900	1580								
GBD 400/4/4 T120	40	53	4870	4295	3650	2740	1370								
GBW 450/4 T120	45	57	7110	6480	5850	5135	4350	3300	1900						
GBD 450/4/4 T120	45	57	7180	6600	5950	5220	4340	3230	1340						
GBW 500/4 T120	45	59	8345	7770	7160	6480	5670	4680	3510	1840					
GBD 500/4/4 T120	45	59	8350	7765	7180	6600	5910	4970	3820	1920					
GBD 560/4/4 T120	48	62	12300	11690	11080	10475	9800	9120	8410	7430	6000				
GBD 630/4 T120	53	67	14140	13690	13200	12720	12230	11670	11150	10470	8830	7850	6820	5150	
GBD 710/4 T120	55	66	18200	17650	17200	16650	16000	15300	14500	13750	12800	11850	10850	9800	8500

GB EC 250

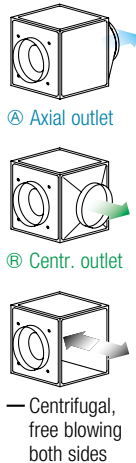

Any installation position and location due to five possible outlet directions.



GB EC 250 T120

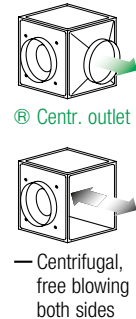

For the delivery of contaminated, humid and hot air up to max. 120 °C. Motor located outside of air flow.



Dimensions GB EC 250

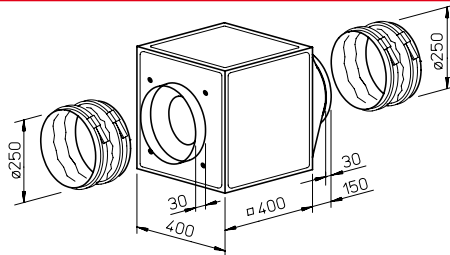

Dim. in mm

Dimensions GB EC 250 T120

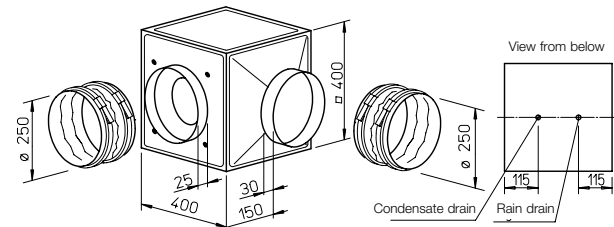

Dim. in mm

Special features of the GB EC T120 series

- Designed for the delivery of contaminated, humid and hot air up to max. 120 °C, e.g. as an extract air fan in commercial kitchens and many process technology applications.
- Motor located outside of air flow.
- Thermally insulated partition between motor and impeller, made of galvanised steel sheet, with 20 mm thick, non-flammable mineral wool.
- Complete motor-impeller unit can be removed without dismantling the system components.
- Inspection cover with handle, easily removable for cleaning and maintenance.
- Condensate tray with condensate drain as standard. Hole provided for rain drain (accessories) for outdoor installation.

Installation

Installation position with condensate drain below. Flexible installation due to three possible centrifugal outlet directions of the outlet fitting. Protected outdoor installation possible with weather protection cover and grille (accessories).

Electrical connection

Standard terminal box (IP54) directly to the commutation electronics.

Special features of the GB EC series

Any installation position and flexible installation due to five possible outlet directions of the outlet fitting. The wall bracket (accessories) must be used for wall installation. Protected outdoor installation possible with weather protection cover and grille (accessories).

Electrical connection

Standard terminal box (IP54) mounted to external cable.

Description for both series

Casing

Self-supporting frame construction made of aluminium hollow profiles. Double-walled, 20 mm thick side panels made of galvanised steel sheet, sound and heat insulated by non-flammable mineral wool lining. Nozzle on inlet side for optimal inflow as well as connectors and flexible connecting sleeve (for the respective max. permissible air flow temperature) for duct connection. Moulded part (square to round) on outlet side for low-loss outflow and flexible connecting sleeve to prevent structure-borne noise transmission. Simple positioning with standard crane hook.

Impeller

Free-running high performance centrifugal impeller made of aluminium, directly driven. Energy-efficient with low noise emission. Dynamically balanced together with the motor in accordance with DIN ISO 21940-11 – quality grade 6.3.

Drive

Energy-saving, speed-controllable EC external rotor motor in protection category IP54 with the highest level of efficiency. Maintenance-free and radio interference-free, ball bearing mounted.

Motor protection

Integrated electronic temperature monitoring system for EC motor and electronics.

Type	Connection Ø	Flow rate free blowing	Rated speed	Case-rad. sound pressure	Power consumption	Current consumption	Wiring diagram	Max. air flow temp.	Weight net aprx.	Universal control system		Speed potentiometer				
										Type	Ref. no.	Type	Ref. no.	Type	Ref. no.	Type
Alternating current, 1~, 230 V, 50/60 Hz, EC motor, protection category IP54																
GBW EC 250	05807	250	2010	1650	31	0.17	0.76	973	55	20.0	EUR EC ^{1) 2)}	01347	PU 24 ¹⁾	01736	PA 24 ¹⁾	01737
T120 Alternating current, 1~, 230 V, 50/60 Hz, EC motor, protection category IP54																
GBW EC 250 T120	06371	250	2335	2200	40	0.27	1,20	1354	120	27.0	EUR EC ^{1) 2)}	01347	PU 10 ¹⁾	01734	PA 10 ¹⁾	01735

1) Multiple EC fans can normally be connected. 2) Alternative electronic diff. pressure/temperature controller (EDR/ETR, No. 01437/01438) or three level speed switch (SU/SA, No. 04266/04267).

Performance curves GBW EC 250

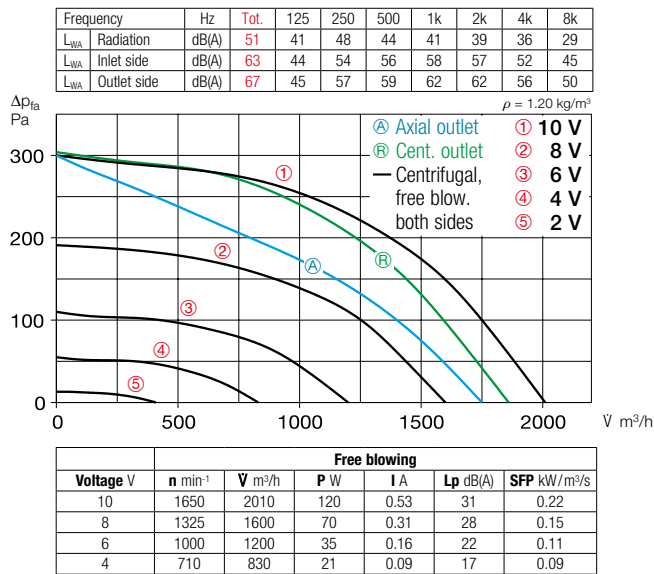

Performance curves GBW EC 250 T120

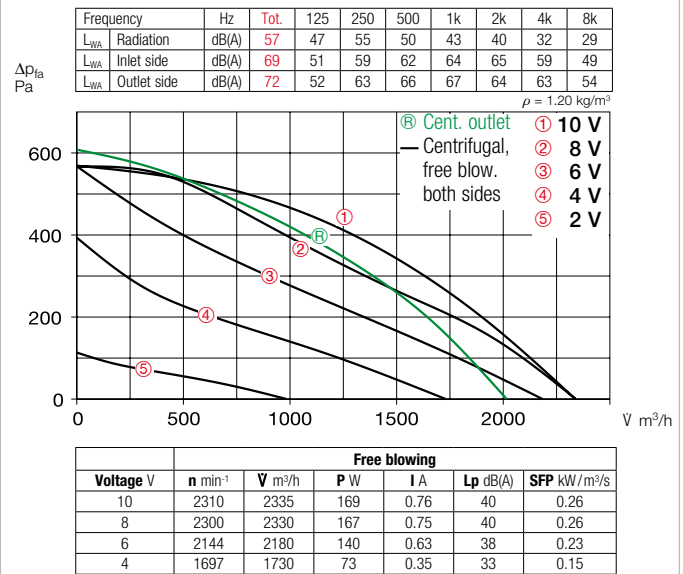

Power control

Continuously variable speed control with internal (delivery) or external potentiometer or continuously variable speed regulation with universal control system (see table). Performance levels are shown in the performance curve as an example.

Noise

The total level and range are specified above the performance diagram for:

- Case-radiated sound power
- Inlet side sound power
- Outlet side sound power

The case-radiated noise as sound pressure at 4 m (free field conditions) is also specified in the type table and the table below the performance curve.

Accessories for both series

Vibration dampers for indoor installation. 1 set = 4 pcs.

SDD-U Ref. no. 05627

Wall bracket for wall installation.

GB-WK 250 Ref. no. 05625

Weather protection grille for outlet-side coverage.

GB-WSG 250 Ref. no. 05637

Weather protection cover for protected outdoor installation.

GB-WSD 250 Ref. no. 05746

Special accessories

for GB EC series

Condensate tray with drain connectors (central) for duct/hose connection.
GB-KW 250 Ref. no. 05642
(a condensate tray with condensate drain is included in delivery for GB EC T120).

for GB EC T120 series

Rain drain for outdoor installation (Hole in casing base already provided).
GB-RA Ref. no. 09418

References	Page
Planning information	10 ff.
General techn. information, power control	15 ff.
Accessory details	Page
Universal control system, electronic controllers, speed potentiometer	605 ff.

GB EC 315

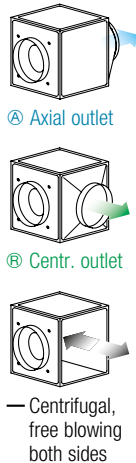

Any installation position and location due to five possible outlet directions.



GB EC 315 T120

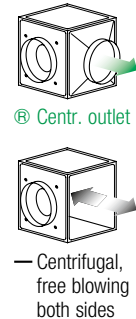

For the delivery of contaminated, humid and hot air up to max. 120 °C. Motor located outside of air flow.



Dimensions GB EC 315

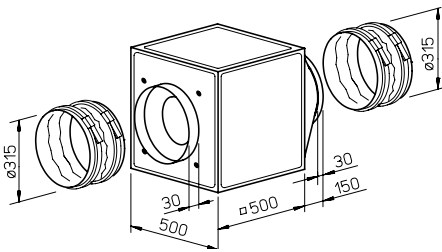

Dim. in mm

Dimensions GB EC 315 T120

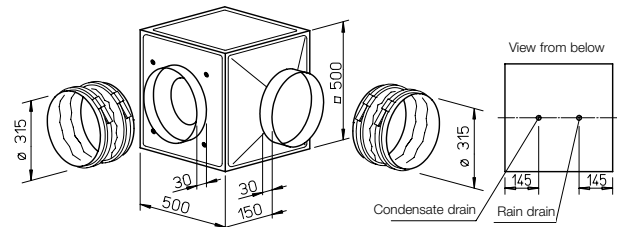

Dim. in mm

Special features of the GB EC T120 series

- Designed for the delivery of contaminated, humid and hot air up to max. 120 °C, e.g. as an extract air fan in commercial kitchens and many process technology applications.
- Motor located outside of air flow.
- Thermally insulated partition between motor and impeller, made of galvanised steel sheet, with 20 mm thick, non-flammable mineral wool.
- Complete motor-impeller unit can be removed without dismantling the system components.
- Inspection cover with handle, easily removable for cleaning and maintenance.
- Condensate tray with condensate drain as standard. Hole provided for rain drain (accessories) for outdoor installation.

Installation

Installation position with condensate drain below. Flexible installation due to three possible centrifugal outlet directions of the outlet fitting. Protected outdoor installation possible with weather protection cover and grille (accessories).

Electrical connection

Standard terminal box (IP54) directly to the commutation electronics.

Special features of the GB EC series

Any installation position and flexible installation due to five possible outlet directions of the outlet fitting. The wall bracket (accessories) must be used for wall installation. Protected outdoor installation possible with weather protection cover and grille (accessories).

Electrical connection

Standard terminal box (IP54) mounted to external cable.

Description for both series

Casing

Self-supporting frame construction made of aluminium hollow profiles. Double-walled, 20 mm thick side panels made of galvanised steel sheet, sound and heat insulated by non-flammable mineral wool lining. Nozzle on inlet side for optimal inflow as well as connectors and flexible connecting sleeve (for the respective max. permissible air flow temperature) for duct connection. Moulded part (square to round) on outlet side for low-loss outflow and flexible connecting sleeve to prevent structure-borne noise transmission. Simple positioning with standard crane hook.

Impeller

Free-running high performance centrifugal impeller made of aluminium, directly driven. Energy-efficient with low noise emission. Dynamically balanced together with the motor in accordance with DIN ISO 21940-11 – quality grade 6.3.

Drive

Energy-saving, speed-controllable EC external rotor motor in protection category IP54 with the highest level of efficiency. Maintenance-free and radio interference-free, ball bearing mounted.

Motor protection

Integrated electronic temperature monitoring system for EC motor and electronics.

Type	Connection Ø	Flow rate free blowing	Rated speed	Case-rad. sound pressure	Power consumption	Current consumption	Wiring diagram	Max. air flow temp.	Weight net aprx.	Universal control system		Speed potentiometer			
										Type	Ref. no.	Type	Ref. no.	Type	Ref. no.
Alternating current, 1~, 230 V, 50/60 Hz, EC motor, protection category IP54															
GBW EC 315	05808	315	2620	1500	0.20	0.9	973	55	31.0	EUR EC ^{1) 2)}	01347	PU 24 ¹⁾	01736	PA 24 ¹⁾	01737
T120 Alternating current, 1~, 230 V, 50/60 Hz, EC motor, protection category IP54															
GBW EC 315 A T120	06370	315	3050	1700	0.29	1.3	1223.1	120	42.0	EUR EC ^{1) 2)}	01347	PU 10 ¹⁾	01734	PA 10 ¹⁾	01735

1) Multiple EC fans can normally be connected. 2) Alternative electronic diff. pressure/temperature controller (EDR/ETR, No. 01437/01438) or three level speed switch (SU/SA, No. 04266/04267).

Performance curves GBW EC 315

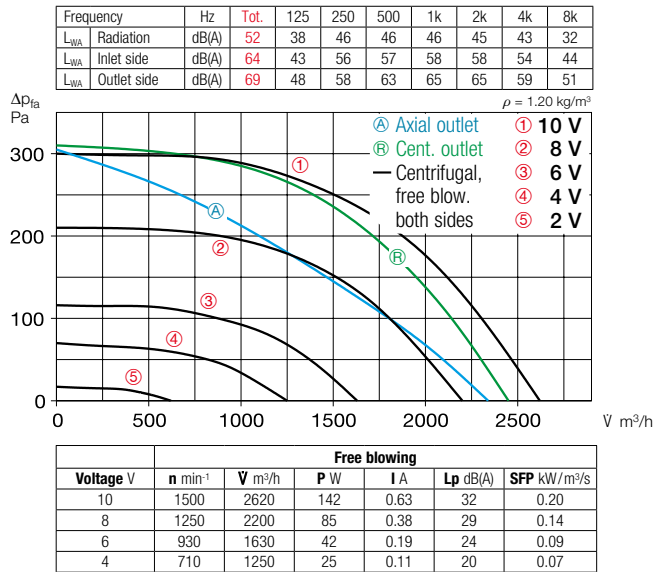

Performance curves GBW EC 315 A T120

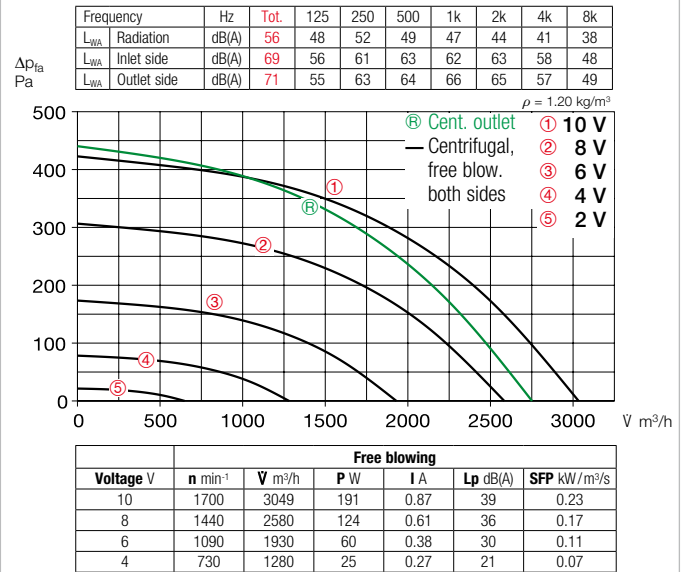

Power control

Continuously variable speed control with internal (delivery) or external potentiometer or continuously variable speed regulation with universal control system (see table). Performance levels are shown in the performance curve as an example.

Noise

The total level and range are specified above the performance diagram for:

- Case-radiated sound power
- Inlet side sound power
- Outlet side sound power

The case-radiated noise as sound pressure at 4 m (free field conditions) is also specified in the type table and the table below the performance curve.

Accessories for both series

Vibration dampers for indoor installation. 1 set = 4 pcs.

SDD-U Ref. no. 05627

Wall bracket for wall installation.

GB-WK 315 Ref. no. 05625

Weather protection grille for outlet-side coverage.

GB-WSG 315 Ref. no. 05638

Weather protection cover for protected outdoor installation.

GB-WSD 315 Ref. no. 05747

Special accessories

for GB EC series

Condensate tray with drain connectors (central) for duct/hose connection.

GB-KW 315 Ref. no. 05643

(a condensate tray with condensate drain is included in delivery for GB EC T120).

for GB EC T120 series

Rain drain for outdoor installation (Hole in casing base already provided).

GB-RA Ref. no. 09418

References	Page
Planning information	10 ff.
General techn. information, power control	15 ff.
Accessory details	Page
Universal control system, electronic controllers, speed potentiometer	605 ff.

GB EC 355

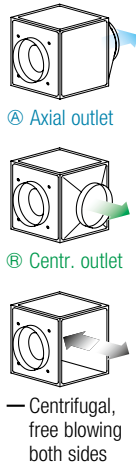

Any installation position and location due to five possible outlet directions.



GB EC 355 T120

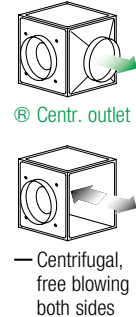

For the delivery of contaminated, humid and hot air up to max. 120 °C. Motor located outside of air flow.



Dimensions GB EC 355

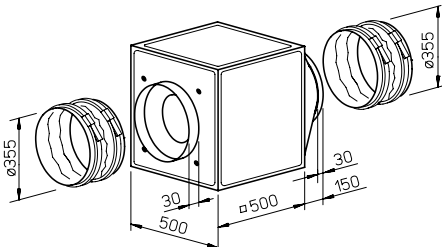

Dim. in mm

Dimensions GB EC 355 T120

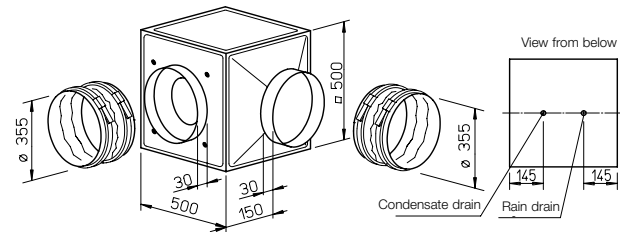

Dim. in mm

Special features of the GB EC T120 series

- Designed for the delivery of contaminated, humid and hot air up to max. 120 °C, e.g. as an extract air fan in commercial kitchens and many process technology applications.
- Motor located outside of air flow.
- Thermally insulated partition between motor and impeller, made of galvanised steel sheet, with 20 mm thick, non-flammable mineral wool.
- Complete motor-impeller unit can be removed without dismantling the system components.
- Inspection cover with handle, easily removable for cleaning and maintenance.
- Condensate tray with condensate drain as standard. Hole provided for rain drain (accessories) for outdoor installation.

Installation

Installation position with condensate drain below. Flexible installation due to three possible centrifugal outlet directions of the outlet fitting. Protected outdoor installation possible with weather protection cover and grille (accessories).

Electrical connection

Standard terminal box (IP54) directly to the commutation electronics.

Special features of the GB EC series

Any installation position and flexible installation due to five possible outlet directions of the outlet fitting. The wall bracket (accessories) must be used for wall installation. Protected outdoor installation possible with weather protection cover and grille (accessories).

Electrical connection

Standard terminal box (IP54) mounted to external cable.

Description for both series

Casing

Self-supporting frame construction made of aluminium hollow profiles. Double-walled, 20 mm thick side panels made of galvanised steel sheet, sound and heat insulated by non-flammable mineral wool lining. Nozzle on inlet side for optimal inflow as well as connectors and flexible connecting sleeve (for the respective max. permissible air flow temperature) for duct connection. Moulded part (square to round) on outlet side for low-loss outflow and flexible connecting sleeve to prevent structure-borne noise transmission. Simple positioning with standard crane hook.

Impeller

Free-running high performance centrifugal impeller made of aluminium, directly driven. Energy-efficient with low noise emission. Dynamically balanced together with the motor in accordance with DIN ISO 21940-11 – quality grade 6.3.

Drive

Energy-saving, speed-controllable EC external rotor motor in protection category IP54 with the highest level of efficiency. Maintenance-free and radio interference-free, ball bearing mounted.

Motor protection

Integrated electronic temperature monitoring system for EC motor and electronics.

Type	Connection Ø	Flow rate free blowing	Rated speed	Case-rad. sound pressure	Power consumption	Current consumption	Wiring diagram	Max. air flow temp.	Weight net aprx.	Universal control system	Speed potentiometer			
											Flush-mounted	Surface-mounted	Type	Ref. no.
Alternating current, 1~, 230 V, 50/60 Hz, EC motor, protection category IP54														
GBW EC 355	05809	355	3440	1500	30	0.35	1.55	973	50	33.0	EUR EC ¹⁾²⁾ 01347	PU 24 ¹⁾ 01736	PA 24 ¹⁾ 01737	
T120 Alternating current, 1~, 230 V, 50/60 Hz, EC motor, protection category IP54														
GBW EC 355 T120	06372	315	2620	1500	32	0.20	0.9	973	55	31.0	EUR EC ¹⁾²⁾ 01347	PU 10 ¹⁾ 01734	PA 10 ¹⁾ 01735	
T120 Three-phase current, 3~, 400 V, 50/60 Hz, EC motor, protection category IP54														
GBD EC 355 T120	06452	355	3840	1500	40	0.36	0.7	1214.1	120	44.0	EUR EC ¹⁾²⁾ 01347	PU 10 ¹⁾ 01734	PA 10 ¹⁾ 01735	

1) Multiple EC fans can normally be connected. 2) Alternative electronic diff. pressure/temperature controller (EDR/ETR, No. 01437/01438) or three level speed switch (SU/SA, No. 04266/04267).

Performance curves GBW EC 355

Frequency	Hz	Tot.	125	250	500	1k	2k	4k	8k
L _{WA} Radiation		dB(A)	50	45	39	42	41	38	29
L _{WA} Inlet side		dB(A)	69	49	63	65	62	59	48
L _{WA} Outlet side		dB(A)	72	52	64	68	66	63	51

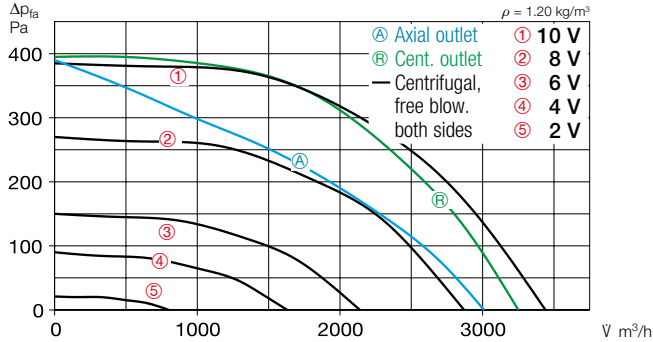

Free blowing						
Voltage V	n min ⁻¹	V m³/h	P W	I A	Lp dB(A)	SFP kW/m³/s
10	1500	3440	235	1.04	30	0.25
8	1250	2870	140	0.62	27	0.17
6	930	2140	64	0.28	22	0.11
4	710	1630	34	0.15	18	0.08

Performance curves GBW EC 355 T120

Frequency	Hz	Tot.	125	250	500	1k	2k	4k	8k
L _{WA} Radiation		dB(A)	57	49	53	50	48	45	39
L _{WA} Inlet side		dB(A)	70	57	62	64	63	64	49
L _{WA} Outlet side		dB(A)	72	56	64	65	67	66	50

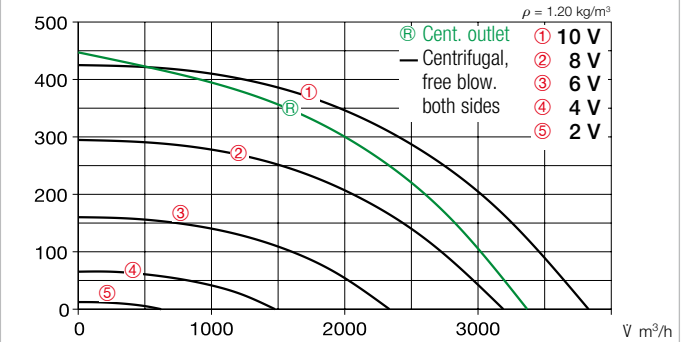

Free blowing						
Voltage V	n min ⁻¹	V m³/h	P W	I A	Lp dB(A)	SFP kW/m³/s
10	1500	3830	255	1.15	40	0.24
8	1250	3190	154	0.74	36	0.17
6	920	2330	68	0.43	30	0.11
4	590	1490	26	0.28	20	0.06

Performance curves GBD EC 355 T120

Frequency	Hz	Tot.	125	250	500	1k	2k	4k	8k
L _{WA} Radiation		dB(A)	57	49	53	50	48	45	39
L _{WA} Inlet side		dB(A)	70	57	62	64	63	64	49
L _{WA} Outlet side		dB(A)	72	56	64	65	67	66	50

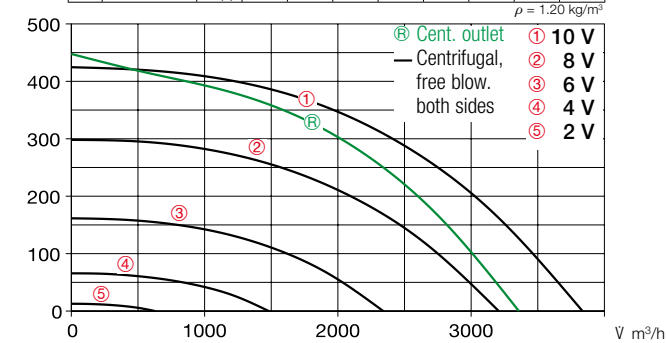

Free blowing						
Voltage V	n min ⁻¹	V m³/h	P W	I A	Lp dB(A)	SFP kW/m³/s
10	1500	3840	261	1.70	40	0.24
8	1250	3220	160	1.31	36	0.18
6	920	2350	75	0.85	30	0.11
4	590	1480	32	0.63	20	0.08

Accessories for both series

Vibration dampers for indoor installation. 1 set = 4 pcs.
SDD-U Ref. no. 05627

Wall bracket for wall installation.
GB-WK 355 Ref. no. 05625

Weather protection grille for outlet-side coverage.
GB-WSG 355 Ref. no. 05638

Weather protection cover for protected outdoor installation.
GB-WSD 355 Ref. no. 05747

Special accessories

for GB EC series
Condensate tray with drain connectors (central) for duct/hose connection.
GB-KW 355 Ref. no. 05643
(a condensate tray with condensate drain is included in delivery for GB EC T120).

for GB EC T120 series
Rain drain for outdoor installation (Hole in casing base already provided).
GB-RA Ref. no. 09418

Power control

Continuously variable speed control with internal (delivery) or external potentiometer or continuously variable speed regulation with universal control system (see table). Performance levels are shown in the performance curve as an example.

Noise

The total level and range are specified above the performance diagram for:

- Case-radiated sound power
- Inlet side sound power
- Outlet side sound power

The case-radiated noise as sound pressure at 4 m (free field conditions) is also specified in the type table and the table below the performance curve.

References	Page
Planning information	10 ff.
General techn. information, power control	15 ff.
Accessory details	Page
Universal control system, electronic controllers, speed potentiometer	605 ff.

GB EC 400

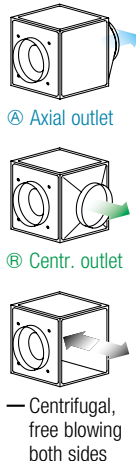

Any installation position and location due to five possible outlet directions.



GB EC 400 T120

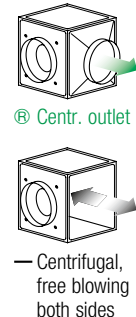

For the delivery of contaminated, humid and hot air up to max. 120 °C. Motor located outside of air flow.



Dimensions GB EC 400

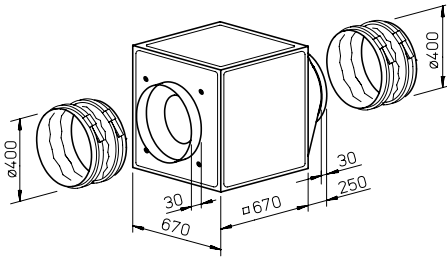

Dimensions GB EC 400 T120

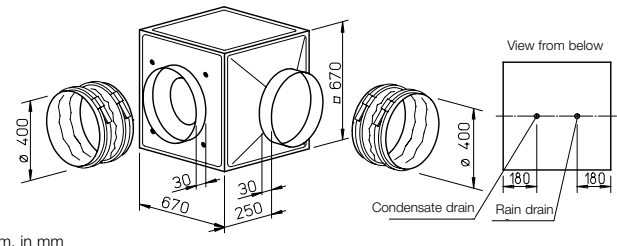

Special features of the GB EC T120 series

- Designed for the delivery of contaminated, humid and hot air up to max. 120 °C, e.g. as an extract air fan in commercial kitchens and many process technology applications.
- Motor located outside of air flow.
- Thermally insulated partition between motor and impeller, made of galvanised steel sheet, with 20 mm thick, non-flammable mineral wool.
- Complete motor-impeller unit can be removed without dismantling the system components.
- Inspection cover with handle, easily removable for cleaning and maintenance.
- Condensate tray with condensate drain as standard. Hole provided for rain drain (accessories) for outdoor installation.

Installation

Installation position with condensate drain below. Flexible installation due to three possible centrifugal outlet directions of the outlet fitting. Protected outdoor installation possible with weather protection cover and grille (accessories).

Electrical connection

Standard terminal box (IP54) directly to the commutation electronics.

Special features of the GB EC series

Any installation position and flexible installation due to five possible outlet directions of the outlet fitting. The wall bracket (accessories) must be used for wall installation. Protected outdoor installation possible with weather protection cover and grille (accessories).

Electrical connection

Standard terminal box (IP54) mounted to external cable.

Description for both series

Casing

Self-supporting frame construction made of aluminium hollow profiles. Double-walled, 20 mm thick side panels made of galvanised steel sheet, sound and heat insulated by non-flammable mineral wool lining. Nozzle on inlet side for optimal inflow as well as connectors and flexible connecting sleeve (for the respective max. permissible air flow temperature) for duct connection. Moulded part (square to round) on outlet side for low-loss outflow and flexible connecting sleeve to prevent structure-borne noise transmission. Simple positioning with standard crane hook.

Impeller

Free-running high performance centrifugal impeller made of aluminium, directly driven. Energy-efficient with low noise emission. Dynamically balanced together with the motor in accordance with DIN ISO 21940-11 – quality grade 2.5.

Drive

Energy-saving, speed-controllable EC external rotor motor in protection category IP54 with the highest level of efficiency. Maintenance-free and radio interference-free, ball bearing mounted.

Motor protection

Integrated electronic temperature monitoring system for EC motor and electronics.

Type	Connection Ø	Flow rate free blowing	Rated speed	Case-rad. sound pressure	Power consumption	Current consumption	Wiring diagram	Max. air flow temp.	Weight net aprx.	Universal control system		Speed potentiometer				
										Type	Ref. no.	Type	Ref. no.			
Alternating current, 1~, 230 V, 50/60 Hz, EC motor, protection category IP54																
GBW EC 400 A	05817	400	4050	1200	36	0.34	1.52	973	50	43.0	EUR EC ^{1) 2)}	01347	PU 24 ¹⁾	01736	PA 24 ¹⁾	01737
GBW EC 400 B	05810	400	5155	1500	37	0.62	2.80	973	50	46.0	EUR EC ^{1) 2)}	01347	PU 24 ¹⁾	01736	PA 24 ¹⁾	01737
⚡ T120 Alternating current, 1~, 230 V, 50/60 Hz, EC motor, protection category IP54																
GBW EC 400 T120	06453	400	4730	1320	43	0.43	1.80	1223.1	120	60.0	EUR EC ^{1) 2)}	01347	PU 10 ¹⁾	01734	PA 10 ¹⁾	01735
⚡ T120 Three-phase current, 3~, 400 V, 50/60 Hz, EC motor, protection category IP54																
GBD EC 400 T120	06454	400	5410	1500	46	0.62	1,20	1214.1	120	60.0	EUR EC ^{1) 2)}	01347	PU 10 ¹⁾	01734	PA 10 ¹⁾	01735

1) Multiple EC fans can normally be connected. 2) Alternative electronic diff. pressure/temperature controller (EDR/ETR, No. 01437/01438) or three level speed switch (SU/SA, No. 04266/04267).

Performance curves GBW EC 400 A

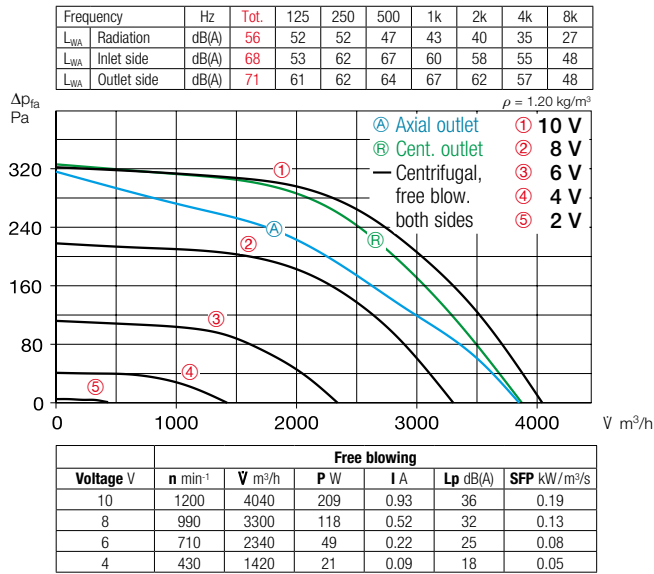

Performance curves GBW EC 400 B

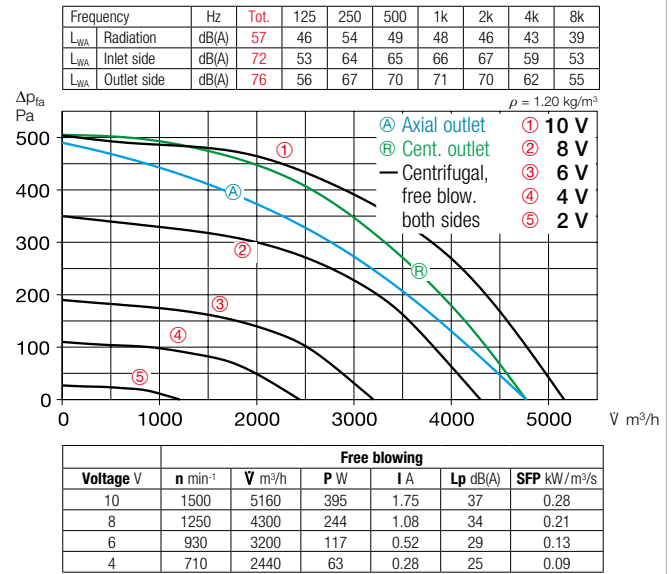

Performance curves GBW EC 400 T120

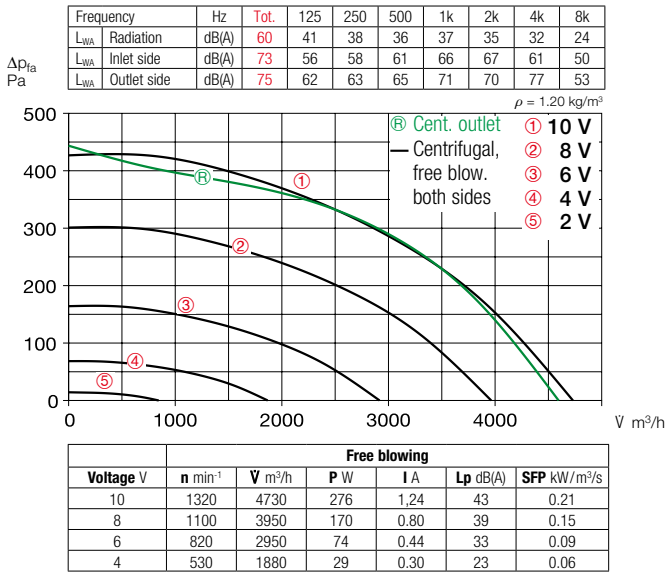

Performance curves GBD EC 400 T120

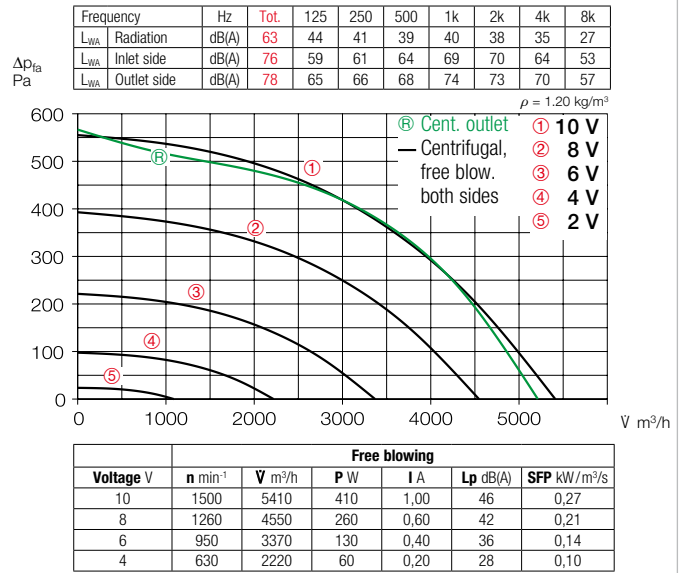

■ Power control

Continuously variable speed control with internal (delivery) or external potentiometer or continuously variable speed regulation with universal control system (see table). Performance levels are shown in the performance curve as an example.

■ Noise

The total level and range are specified above the performance diagram for:

- Case-radiated sound power
- Inlet side sound power
- Outlet side sound power

The case-radiated noise as sound pressure at 4 m (free field conditions) is also specified in the type table and the table below the performance curve.

■ Accessories for both series

Vibration dampers for indoor installation. 1 set = 4 pcs.
SDD-U Ref. no. 05627

Wall bracket for wall installation.
GB-WK 400 Ref. no. 05626

Weather protection grille for outlet-side coverage.
GB-WSG 400 Ref. no. 05639

Weather protection cover for protected outdoor installation.
GB-WSD 400 Ref. no. 05748

■ Special accessories

for GB EC series
Condensate tray with drain connectors (central) for duct/hose connection.
GB-KW 400 Ref. no. 05644
(a condensate tray with condensate drain is included in delivery for GB EC T120).

for GB EC T120 series
Rain drain for outdoor installation (Hole in casing base already provided).
GB-RA Ref. no. 09418

References	Page
Universal control system, electronic controllers, Speed potentiometer	605 ff.

GB EC 450

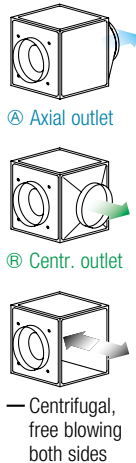

Any installation position and location due to five possible outlet directions.



GB EC 450 T120

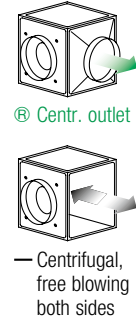

For the delivery of contaminated, humid and hot air up to max. 120 °C. Motor located outside of air flow.



Dimensions GB EC 450

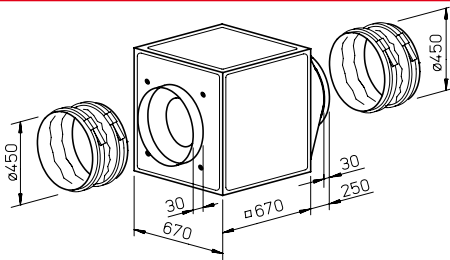

Dimensions GB EC 450 T120

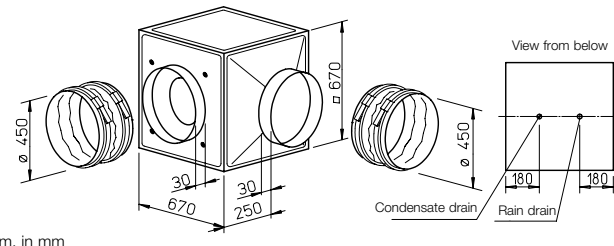

Special features of the GB EC T120 series

- Designed for the delivery of contaminated, humid and hot air up to max. 120 °C, e.g. as an extract air fan in commercial kitchens and many process technology applications.
- Motor located outside of air flow.
- Thermally insulated partition between motor and impeller, made of galvanised steel sheet, with 20 mm thick, non-flammable mineral wool.
- Complete motor-impeller unit can be removed without dismantling the system components.
- Inspection cover with handle, easily removable for cleaning and maintenance.
- Condensate tray with condensate drain as standard. Hole provided

for rain drain (accessories) for outdoor installation.

- **Installation**
 Installation position with condensate drain below. Flexible installation due to three possible centrifugal outlet directions of the outlet fitting. Protected outdoor installation possible with weather protection cover and grille (accessories).

- **Electrical connection**
 Standard terminal box (IP54) directly to the commutation electronics.

Special features of the GB EC series

Any installation position and flexible installation due to five possible outlet directions of the outlet fitting. The

wall bracket (accessories) must be used for wall installation. Protected outdoor installation possible with weather protection cover and grille (accessories).

- **Electrical connection**
 Standard terminal box (IP54) mounted to external cable.

Description for both series

- **Casing**
 Self-supporting frame construction made of aluminium hollow profiles. Double-walled, 20 mm thick side panels made of galvanised steel sheet, sound and heat insulated by non-flammable mineral wool lining. Nozzle on inlet side for optimal inflow as well as connectors and flexible connecting sleeve (for the respective max. permis-

sible air flow temperature) for duct connection. Moulded part (square to round) on outlet side for low-loss outflow and flexible connecting sleeve to prevent structure-borne noise transmission. Simple positioning with standard crane hook.

- **Impeller**
 Free-running high performance centrifugal impeller made of aluminium, directly driven. Energy-efficient with low noise emission. Dynamically balanced together with the motor in accordance with DIN ISO 21940-11 – quality grade 2.5.

Type	Connection Ø	Flow rate free blowing	Rated speed	Case-rad. sound pressure	Power consumption	Current consumption	Wiring diagram	Max. air flow temp.	Weight net aprx.	Universal control system		Speed potentiometer		
										Type	Ref. no.	Type	Ref. no.	
Alternating current, 1~, 230 V, 50/60 Hz, EC motor, protection category IP54														
GBW EC 450	05811	450	6460	1450	38	1.00	4.5	973	50	52.0	EUR EC ¹⁾ 01347	PU 24 ¹⁾ 01736	PA 24 ¹⁾ 01737	
Three-phase current, 3~, 400 V, 50/60 Hz, EC motor, protection category IP54														
GBD EC 450	05812	450	7450	1500	39	1.10	1.9	1415	55	52.0	EUR EC ¹⁾ 01347	PU 24 ¹⁾ 01736	PA 24 ¹⁾ 01737	
T120 Alternating current, 1~, 230 V, 50/60 Hz, EC motor, protection category IP54														
GBW EC 450 T120	06475	450	6250	1230	45	0.65	2.8	1223.1	120	66.0	EUR EC ¹⁾ 01347	PU 10 ¹⁾ 01734	PA 10 ¹⁾ 01735	
T120 Three-phase current, 3~, 400 V, 50/60 Hz, EC motor, protection category IP54														
GBD EC 450 T120	06476	450	6450	1400	48	0.95	1.7	1214.1	120	66.0	EUR EC ¹⁾ 01347	PU 10 ¹⁾ 01734	PA 10 ¹⁾ 01735	

1) Multiple EC fans can normally be connected. 2) Alternative electronic diff. pressure/temperature controller (EDR/ETR, No. 01437/01438) or three level speed switch (SU/SA, No. 04266/04267).

Performance curves GBW EC 450

Frequency	Hz	Tot.	125	250	500	1k	2k	4k	8k	
L _{WA} Radiation		dB(A)	58	48	56	48	47	46	42	31
L _{WA} Inlet side		dB(A)	75	54	66	68	70	69	64	57
L _{WA} Outlet side		dB(A)	79	60	70	74	75	74	65	60

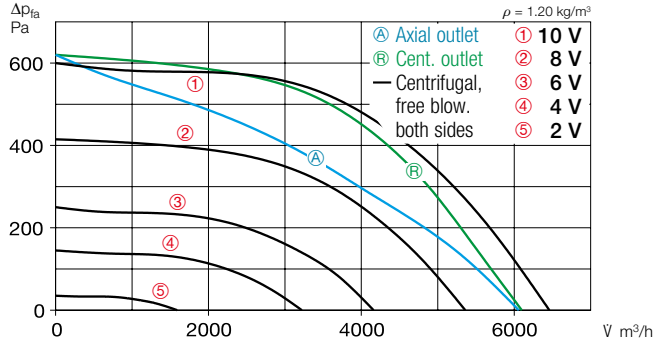

Free blowing						
Voltage V	n min ⁻¹	V m ³ /h	P W	I A	Lp dB(A)	SFP kW/m ³ /s
10	1450	6460	614	2.72	38	0.34
8	1200	5360	363	1.61	35	0.24
6	930	4160	185	0.82	31	0.16
4	710	3220	92	0.41	26	0.10

Performance curves GBD EC 450

Frequency	Hz	Tot.	125	250	500	1k	2k	4k	8k	
L _{WA} Radiation		dB(A)	59	49	57	49	48	47	43	32
L _{WA} Inlet side		dB(A)	76	55	67	69	71	70	65	58
L _{WA} Outlet side		dB(A)	80	61	71	75	76	75	66	61

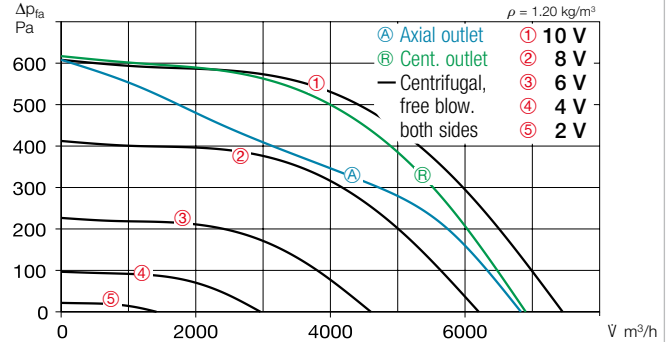

Free blowing						
Voltage V	n min ⁻¹	V m ³ /h	P W	I A	Lp dB(A)	SFP kW/m ³ /s
10	1500	7450	700	1.3	39	0.34
8	1240	6200	400	0.9	36	0.23
6	920	4600	170	0.5	30	0.13
4	600	2960	60	0.24	21	0.07

Performance curves GBW EC 450 T120

Frequency	Hz	Tot.	125	250	500	1k	2k	4k	8k	
L _{WA} Radiation		dB(A)	62	39	42	38	39	39	35	31
L _{WA} Inlet side		dB(A)	74	55	62	63	64	67	60	52
L _{WA} Outlet side		dB(A)	77	60	67	69	75	71	65	56

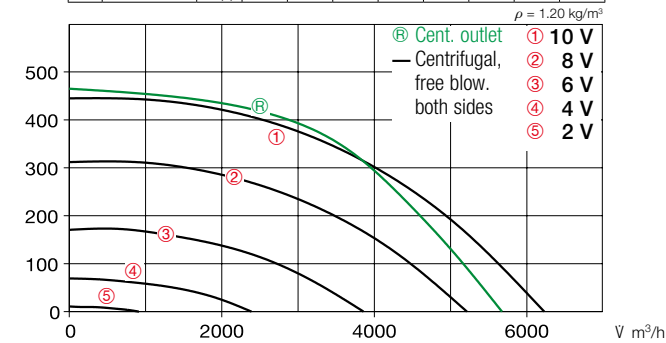

Free blowing						
Voltage V	n min ⁻¹	V m ³ /h	P W	I A	Lp dB(A)	SFP kW/m ³ /s
10	1230	6250	376	1.67	45	0.22
8	1030	5210	227	1.04	41	0.16
6	760	3860	102	0.53	35	0.10
4	500	2480	37	0.32	25	0.05

Performance curves GBD EC 450 T120

Frequency	Hz	Tot.	125	250	500	1k	2k	4k	8k	
L _{WA} Radiation		dB(A)	65	42	45	41	42	42	38	34
L _{WA} Inlet side		dB(A)	77	58	65	66	67	70	63	55
L _{WA} Outlet side		dB(A)	80	63	70	72	78	74	68	59

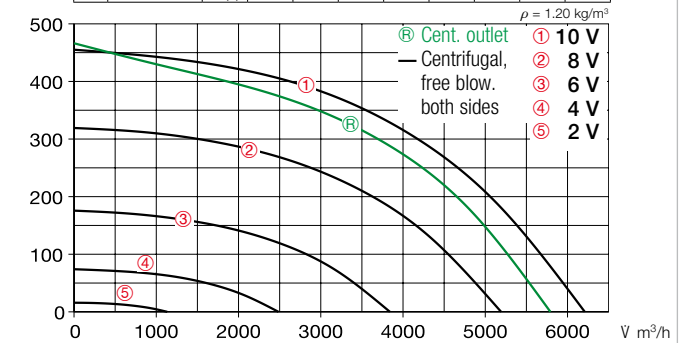

Free blowing						
Voltage V	n min ⁻¹	V m ³ /h	P W	I A	Lp dB(A)	SFP kW/m ³ /s
10	1400	6450	380	2.20	48	0.21
8	1030	5200	368	1.60	41	0.25
6	760	3850	108	1.00	35	0.10
4	500	2510	44	0.67	26	0.06

■ Drive

Energy-saving, speed-control-able EC external rotor motor in protection category IP54 with the highest level of efficiency. Maintenance-free and radio interference-free, ball bearing mounted.

■ Motor protection

Integrated electronic temperature monitoring system for EC motor and electronics.

■ Power control

Continuously variable speed control with internal (delivery) or external potentiometer or continuously variable speed regulation with universal control system (see table). Performance levels are shown in the performance curve as an example.

■ Noise

The total level and range are specified above the performance diagram for:

- Case-radiated sound power
- Inlet side sound power
- Outlet side sound power

The case-radiated noise as sound pressure at 4 m (free field conditions) is also specified in the type table and the table below the performance curve.

■ Accessories for both series

Vibration dampers for indoor installation. 1 set = 4 pcs.

SDD-U Ref. no. 05627

Wall bracket for wall installation.

GB-WK 450 Ref. no. 05626

Weather protection grille for outlet-side coverage.

GB-WSG 450 Ref. no. 05639

Weather protection cover for protected outdoor installation.

GB-WSD 450 Ref. no. 05748

■ Special accessories

for GB EC series

Condensate tray with drain connectors (central) for duct/hose connection.
GB-KW 450 Ref. no. 05644
(a condensate tray with condensate drain is included in delivery for GB EC T120).

for GB EC T120 series

Rain drain for outdoor installation (Hole in casing base already provided).
GB-RA Ref. no. 09418

■ References

Page

Universal control system, electronic controllers, Speed potentiometer	605 ff.
---	---------

GB EC 500

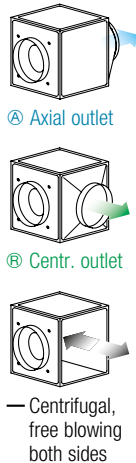

Any installation position and location due to five possible outlet directions.



GB EC 500 T120

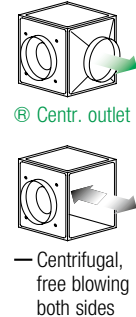

For the delivery of contaminated, humid and hot air up to max. 120 °C. Motor located outside of air flow.



Dimensions GB EC 500

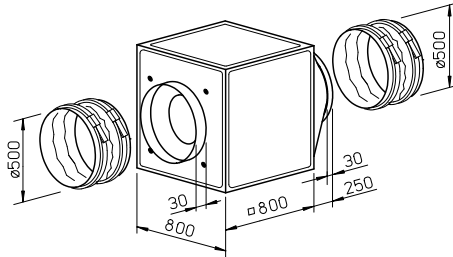

Dimensions GB EC 500 T120

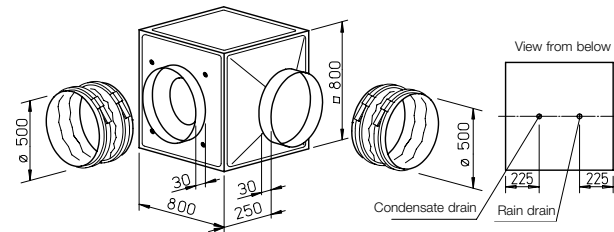

Special features of the GB EC T120 series

- Designed for the delivery of contaminated, humid and hot air up to max. 120 °C, e.g. as an extract air fan in commercial kitchens and many process technology applications.
- Motor located outside of air flow.
- Thermally insulated partition between motor and impeller, made of galvanised steel sheet, with 20 mm thick, non-flammable mineral wool.
- Complete motor-impeller unit can be removed without dismantling the system components.
- Inspection cover with handle, easily removable for cleaning and maintenance.
- Condensate tray with condensate drain as standard. Hole provided for rain drain (accessories) for outdoor installation.

Installation

Installation position with condensate drain below. Flexible installation due to three possible centrifugal outlet directions of the outlet fitting. Protected outdoor installation possible with weather protection cover and grille (accessories).

Electrical connection

Standard terminal box (IP54) directly to the commutation electronics.

Special features of the GB EC series

Any installation position and flexible installation due to five possible outlet directions of the outlet fitting. The wall bracket (accessories) must be used for wall installation. Protected outdoor installation possible with weather protection cover and grille (accessories).

Electrical connection

Standard terminal box (IP54) mounted to external cable.

Description for both series

Casing

Self-supporting frame construction made of aluminium hollow profiles. Double-walled, 20 mm thick side panels made of galvanised steel sheet, sound and heat insulated by non-flammable mineral wool lining. Nozzle on inlet side for optimal inflow as well as connectors and flexible connecting sleeve (for the respective max. permissible air flow temperature) for duct connection. Moulded part (square to round) on outlet side for low-loss outflow and flexible connecting sleeve to prevent structure-borne noise transmission. Simple positioning with standard crane hook.

Impeller

Free-running high performance centrifugal impeller made of aluminium, directly driven. Energy-efficient with low noise emission. Dynamically balanced together with the motor in accordance with DIN ISO 21940-11 – quality grade 2.5.

Drive

Energy-saving, speed-controllable EC external rotor motor in protection category IP54 with the highest level of efficiency. Maintenance-free and radio interference-free, ball bearing mounted.

Motor protection

Integrated electronic temperature monitoring system for EC motor and electronics.

Type	Connection Ø	Flow rate free blowing	Rated speed	Case-rad. sound pressure	Power consumption	Current consumption	Wiring diagram	Max. air flow temp.	Weight net aprx.	Universal control system		Speed potentiometer		
										Type	Ref. no.	Type	Ref. no.	Type
Three-phase current, 3~, 400 V, 50/60 Hz, EC motor, protection category IP54														
GBD EC 500 A	05818	500	8450	1200	43	0.95	1.60	1415	50	80.5	EUR EC^{1) 2)} 01347	PU 24¹⁾ 01736	PA 24¹⁾ 01737	
GBD EC 500 B	05813	500	10680	1500	46	2.00	3.14	1415	60	82.0	EUR EC^{1) 2)} 01347	PU 24¹⁾ 01736	PA 24¹⁾ 01737	
T120 Three-phase current, 3~, 400 V, 50/60 Hz, EC motor, protection category IP54														
GBD EC 500 A T120	06477	500	9850	1400	51	1.45	2.4	1214.1	120	96.0	EUR EC^{1) 2)} 01347	PU 10¹⁾ 01734	PA 10¹⁾ 01735	

1) Multiple EC fans can normally be connected. 2) Alternative electronic diff. pressure/temperature controller (EDR/ETR, No. 01437/01438) or three level speed switch (SU/SA, No. 04266/04267).

Performance curves GBD EC 500 A

Frequency	Hz	Tot.	125	250	500	1k	2k	4k	8k	
L _{WA} Radiation		dB(A)	63	57	60	55	54	45	39	31
L _{WA} Inlet side		dB(A)	75	57	66	66	69	68	66	59
L _{WA} Outlet side		dB(A)	78	61	66	70	74	72	68	60

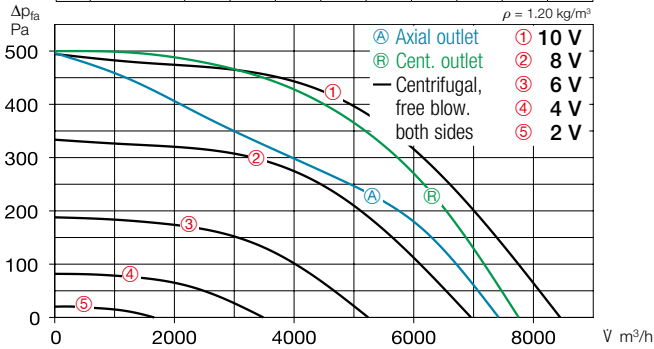

Free blowing						
Voltage V	n min ⁻¹	V m³/h	P W	I A	Lp dB(A)	SFP kW/m³/s
10	1200	8450	620	1.14	43	0.27
8	990	6960	350	0.76	39	0.18
6	740	5240	160	0.43	33	0.11
4	490	3490	60	0.23	25	0.06

Performance curves GBD EC 500 B

Frequency	Hz	Tot.	125	250	500	1k	2k	4k	8k	
L _{WA} Radiation		dB(A)	66	56	65	58	57	53	50	43
L _{WA} Inlet side		dB(A)	79	58	70	72	74	73	68	61
L _{WA} Outlet side		dB(A)	82	62	73	76	77	75	71	64

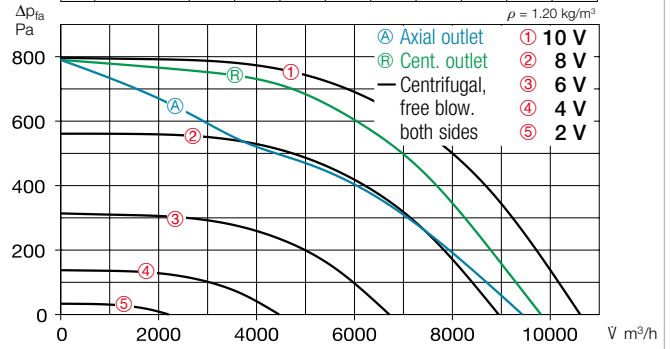

Free blowing						
Voltage V	n min ⁻¹	V m³/h	P W	I A	Lp dB(A)	SFP kW/m³/s
10	1500	10680	1270	2.1	46	0.43
8	1260	9000	770	1.3	42	0.31
6	940	6740	350	0.77	36	0.19
4	630	4500	120	0.41	28	0.10

Performance curves GBD EC 500 T120

Frequency	Hz	Tot.	125	250	500	1k	2k	4k	8k	
L _{WA} Radiation		dB(A)	68	42	49	66	45	44	38	30
L _{WA} Inlet side		dB(A)	80	58	67	70	71	72	77	58
L _{WA} Outlet side		dB(A)	83	67	75	77	78	76	70	61

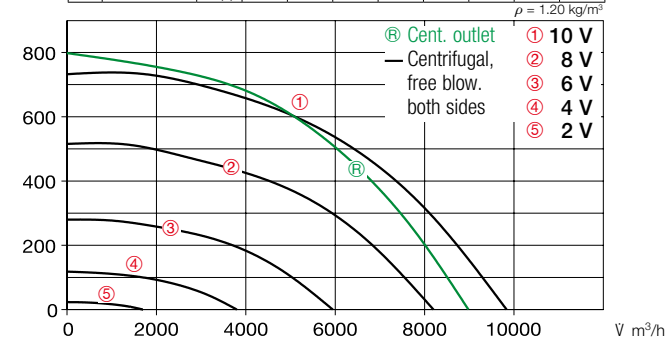

Free blowing						
Voltage V	n min ⁻¹	V m³/h	P W	I A	Lp dB(A)	SFP kW/m³/s
10	1400	9850	856	4.60	51	0.31
8	1170	8020	520	4.60	47	0.23
6	860	5930	224	1.80	40	0.14
4	550	3800	76	1.05	31	0.07

Power control

Continuously variable speed control with internal (delivery) or external potentiometer or continuously variable speed regulation with universal control system (see table). Performance levels are shown in the performance curve as an example.

Noise

The total level and range are specified above the performance diagram for:

- Case-radiated sound power
- Inlet side sound power
- Outlet side sound power

The case-radiated noise as sound pressure at 4 m (free field conditions) is also specified in the type table and the table below the performance curve.

Accessories for both series

Vibration dampers for indoor installation. 1 set = 4 pcs.
SDD-U Ref. no. 05627

Wall bracket for wall installation.
GB-WK 500 Ref. no. 05626

Weather protection grille for outlet-side coverage.
GB-WSG EC 500 Ref. no. 05640

Weather protection cover for protected outdoor installation.
GB-WSD EC 500 Ref. no. 05749

Special accessories

for GB EC series
Condensate tray with drain connectors (central) for duct/hose connection.
GB-KW EC 500 Ref. no. 05645 (a condensate tray with condensate drain is included in delivery for GB EC T120).

for GB EC T120 series
Rain drain for outdoor installation (Hole in casing base already provided).
GB-RA Ref. no. 09418

References	Page
Universal control system, electronic controllers, Speed potentiometer	605 ff.

GB EC 560

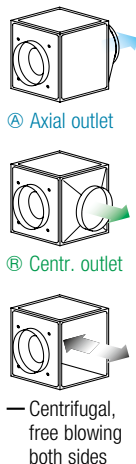

Any installation position and location due to five possible outlet directions.



GB EC 560 T120

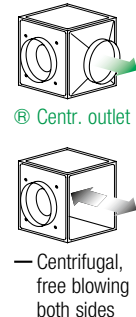

For the delivery of contaminated, humid and hot air up to max. 120 °C. Motor located outside of air flow.



Dimensions GB EC 560

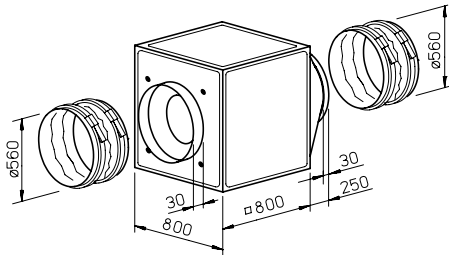

Dimensions GB EC 560 T120

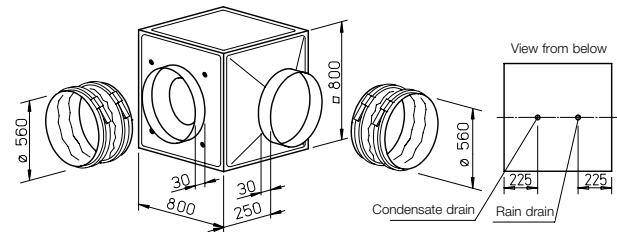

Special features of the GB EC T120 series

- Designed for the delivery of contaminated, humid and hot air up to max. 120 °C, e.g. as an extract air fan in commercial kitchens and many process technology applications.
- Motor located outside of air flow.
- Thermally insulated partition between motor and impeller, made of galvanised steel sheet, with 20 mm thick, non-flammable mineral wool.
- Complete motor-impeller unit can be removed without dismantling the system components.
- Inspection cover with handle, easily removable for cleaning and maintenance.
- Condensate tray with condensate drain as standard. Hole provided for rain drain (accessories) for outdoor installation.

Installation

Installation position with condensate drain below. Flexible installation due to three possible centrifugal outlet directions of the outlet fitting. Protected outdoor installation possible with weather protection cover and grille (accessories).

Electrical connection

Standard terminal box (IP54) directly to the commutation electronics.

Special features of the GB EC series

Any installation position and flexible installation due to five possible outlet directions of the outlet fitting. The wall bracket (accessories) must be used for wall installation. Protected outdoor installation possible with weather protection cover and grille (accessories).

Electrical connection

Standard terminal box (IP54) mounted to external cable.

Description for both series

Casing

Self-supporting frame construction made of aluminium hollow profiles. Double-walled, 20 mm thick side panels made of galvanised steel sheet, sound and heat insulated by non-flammable mineral wool lining. Nozzle on inlet side for optimal inflow as well as connectors and flexible connecting sleeve (for the respective max. permissible air flow temperature) for duct connection. Moulded part (square to round) on outlet side for low-loss outflow and flexible connecting sleeve to prevent structure-borne noise transmission. Simple positioning with standard crane hook.

Impeller

Free-running high performance centrifugal impeller made of aluminium, directly driven. Energy-efficient with low noise emission. Dynamically balanced together with the motor in accordance with DIN ISO 21940-11 – quality grade 2.5.

Drive

Energy-saving, speed-controllable EC external rotor motor in protection category IP54 with the highest level of efficiency. Maintenance-free and radio interference-free, ball bearing mounted.

Motor protection

Integrated electronic temperature monitoring system for EC motor and electronics.

Type	Connection Ø	Flow rate free blowing	Rated speed	Case-rad. sound pressure	Power consumption	Current consumption	Wiring diagram	Max. air flow temp.	Weight net aprx.	Universal control system		Speed potentiometer					
										Type	Ref. no.	Type	Ref. no.	Type	Ref. no.	Type	Ref. no.
Three-phase current, 3~, 400 V, 50/60 Hz, EC motor, protection category IP54																	
GBD EC 560	05814	560	14040	1375	49	2.80	4.30	1415	50	83.0	EUR EC ^{1) 2)}	01347	PU 24 ¹⁾	01736	PA 24 ¹⁾	01737	
⚡ T120 Three-phase current, 3~, 400 V, 50/60 Hz, EC motor, protection category IP54																	
GBD EC 560 T120	06481	560	12100	1400	5	2.30	3.60	1214.1	120	102.0	EUR EC ^{1) 2)}	01347	PU 10 ¹⁾	01734	PA 10 ¹⁾	01735	

1) Multiple EC fans can normally be connected. 2) Alternative electronic diff. pressure/temperature controller (EDR/ETR, No. 01437/01438) or three level speed switch (SU/SA, No. 04266/04267).

Performance curves GBD EC 560

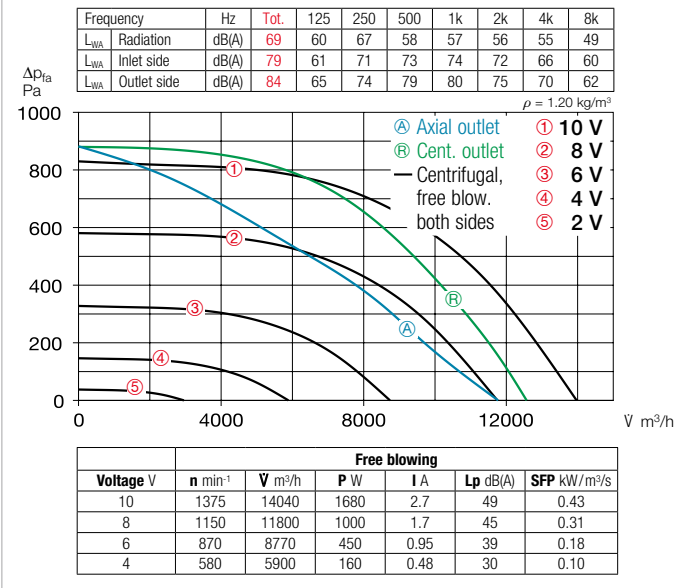

Performance curves GBD EC 560 T120

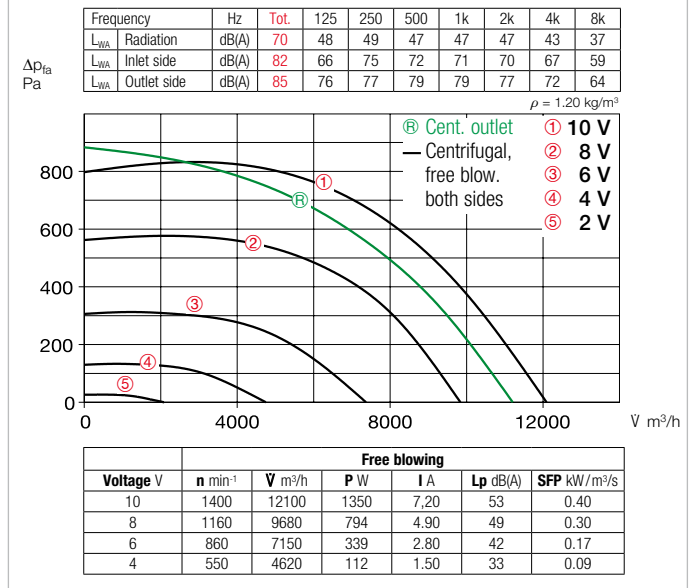

■ Power control

Continuously variable speed control with internal (delivery) or external potentiometer or continuously variable speed regulation with universal control system (see table). Performance levels are shown in the performance curve as an example.

■ Noise

The total level and range are specified above the performance diagram for:

- Case-radiated sound power
- Inlet side sound power
- Outlet side sound power

The case-radiated noise as sound pressure at 4 m (free field conditions) is also specified in the type table and the table below the performance curve.

■ Accessories for both series

Vibration dampers for indoor installation. 1 set = 4 pcs.

SDD-U Ref. no. 05627

Wall bracket for wall installation.

GB-WK 560 Ref. no. 05626

Weather protection grille for outlet-side coverage.

GB-WSG 560 Ref. no. 05640

Weather protection cover for protected outdoor installation.

GB-WSD 560 Ref. no. 05749

■ Special accessories

for GB EC series

Condensate tray with drain connectors (central) for duct/hose connection.

GB-KW 560 Ref. no. 05645

(a condensate tray with condensate drain is included in delivery for GB EC T120).

for GB EC T120 series

Rain drain for outdoor installation (Hole in casing base already provided).

GB-RA Ref. no. 09418

References	Page
Planning information	10 ff.
General techn. information, power control	15 ff.
Accessory details	Page
Universal control system, electronic controllers, speed potentiometer	605 ff.

GB EC 630

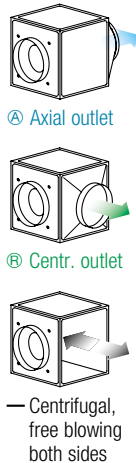

Any installation position and location due to five possible outlet directions.



GB EC 630 T120

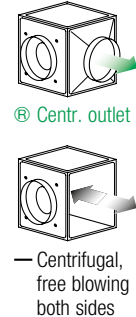

For the delivery of contaminated, humid and hot air up to max. 120 °C. Motor located outside of air flow.



Dimensions GB EC 630

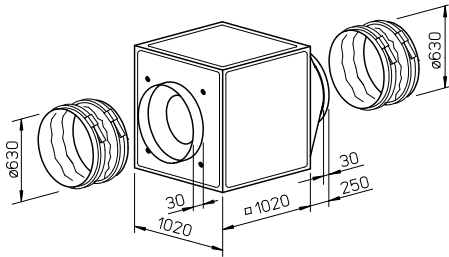

Dimensions GB EC 630 T120

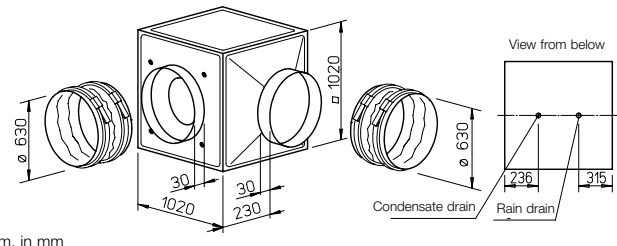

Special features of the GB EC T120 series

- Designed for the delivery of contaminated, humid and hot air up to max. 120 °C, e.g. as an extract air fan in commercial kitchens and many process technology applications.
- Motor located outside of air flow.
- Thermally insulated partition between motor and impeller, made of galvanised steel sheet, with 20 mm thick, non-flammable mineral wool.
- Complete motor-impeller unit can be removed without dismantling the system components.
- Inspection cover with handle, easily removable for cleaning and maintenance.
- Condensate tray with condensate drain as standard. Hole provided for rain drain (accessories) for outdoor installation.

Installation

Installation position with condensate drain below. Flexible installation due to three possible centrifugal outlet directions of the outlet fitting. Protected outdoor installation possible with weather protection cover and grille (accessories).

Electrical connection

Standard terminal box (IP54) directly to the commutation electronics.

Special features of the GB EC series

Any installation position and flexible installation due to five possible outlet directions of the outlet fitting. The wall bracket (accessories) must be used for wall installation. Protected outdoor installation possible with weather protection cover and grille (accessories).

Electrical connection

Standard terminal box (IP54) mounted to external cable.

Description for both series

Casing

Self-supporting frame construction made of aluminium hollow profiles. Double-walled, 20 mm thick side panels made of galvanised steel sheet, sound and heat insulated by non-flammable mineral wool lining. Nozzle on inlet side for optimal inflow as well as connectors and flexible connecting sleeve (for the respective max. permissible air flow temperature) for duct connection. Moulded part (square to round) on outlet side for low-loss outflow and flexible connecting sleeve to prevent structure-borne noise transmission. Simple positioning with standard crane hook.

Impeller

Free-running high performance centrifugal impeller made of aluminium, directly driven. Energy-efficient with low noise emission. Dynamically balanced together with the motor in accordance with DIN ISO 21940-11 – quality grade 2.5.

Drive

Energy-saving, speed-controllable EC external rotor motor in protection category IP54 with the highest level of efficiency. Maintenance-free and radio interference-free, ball bearing mounted.

Motor protection

Integrated electronic temperature monitoring system for EC motor and electronics.

Type	Connection Ø	Flow rate free blowing	Rated speed	Case-rad. sound pressure	Power consumption	Current consumption	Wiring diagram	Max. air flow temp.	Weight net aprx.	Universal control system	Speed potentiometer					
											Flush-mounted	Surface-mounted	Type	Ref. no.		
Three-phase current, 3~, 400 V, 50/60 Hz, EC motor, protection category IP54													Type	Ref. no.	Type	Ref. no.
GBD EC 630	05815	630	15570	1100	44	2.49	3.87	1415	60	113.0	EUR EC ^{1) 2)}	01347	PU 24 ¹⁾	01736	PA 24 ¹⁾	01737
Three-phase current, 3~, 400 V, 50/60 Hz, EC motor, protection category IP54													Type	Ref. no.	Type	Ref. no.
GBD EC 630 T120	06485	630	15300	1350	54	3.60	5.50	1214.1	120	112.0	EUR EC ^{1) 2)}	01347	PU 10 ¹⁾	01734	PA 10 ¹⁾	01735

1) Multiple EC fans can normally be connected. 2) Alternative electronic diff. pressure/temperature controller (EDR/ETR, No. 01437/01438) or three level speed switch (SU/SA, No. 04266/04267).

Performance curves GBD EC 630

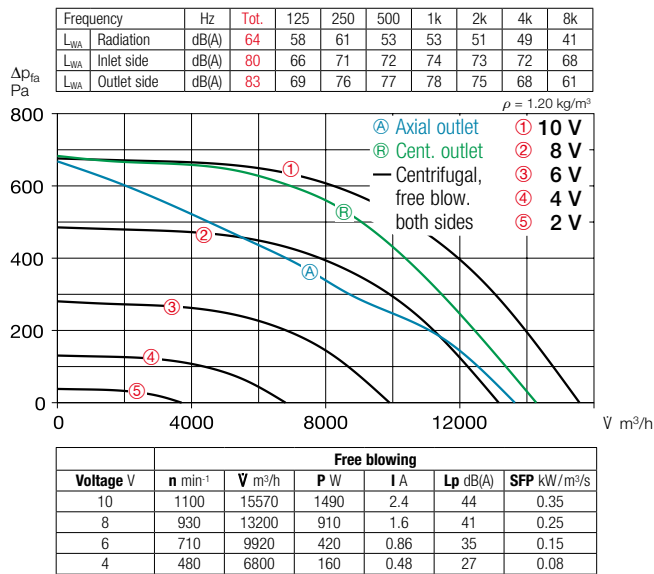

Performance curves GBD EC 630 T120

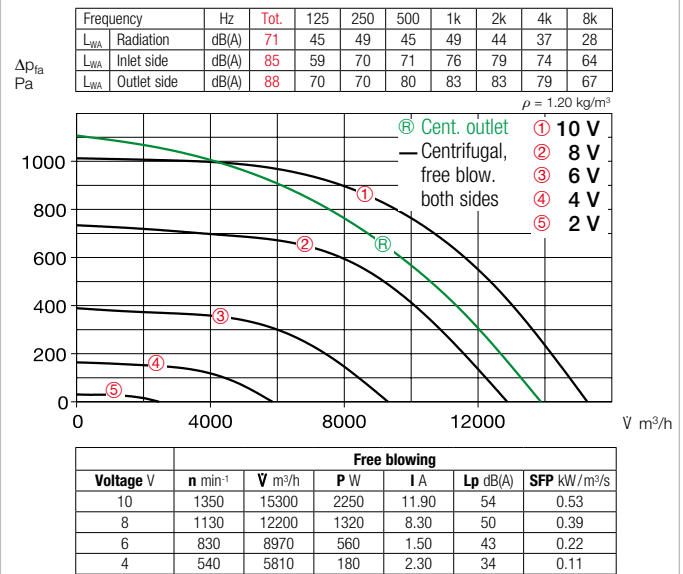

■ Power control

Continuously variable speed control with internal (delivery) or external potentiometer or continuously variable speed regulation with universal control system (see table). Performance levels are shown in the performance curve as an example.

■ Noise

The total level and range are specified above the performance diagram for:

- Case-radiated sound power
- Inlet side sound power
- Outlet side sound power

The case-radiated noise as sound pressure at 4 m (free field conditions) is also specified in the type table and the table below the performance curve.

■ Accessories for both series

Vibration dampers for indoor installation. 1 set = 4 pcs.
SDD-U Ref. no. 05627

Wall bracket for wall installation.
GB-WK 630 Ref. no. 05626

Weather protection grille for outlet-side coverage.
GB-WSG 630 Ref. no. 05641

Weather protection cover for protected outdoor installation.
GB-WSD 630 Ref. no. 05749

■ Special accessories

for GB EC series
Condensate tray with drain connectors (central) for duct/hose connection.
GB-KW EC 630 Ref. no. 05646
(a condensate tray with condensate drain is included in delivery for GB EC T120).

for GB EC T120 series
Rain drain for outdoor installation (Hole in casing base already provided).
GB-RA Ref. no. 09418

■ References	Page
Planning information	10 ff.
General techn. information, power control	15 ff.
■ Accessory details	Page
Universal control system, electronic controllers, speed potentiometer	605 ff.

GB EC 710

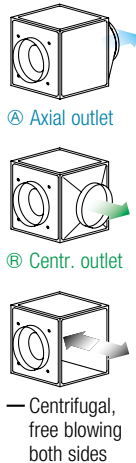

Any installation position and location due to five possible outlet directions.



GB EC 710 T120

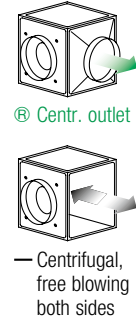

For the delivery of contaminated, humid and hot air up to max. 120 °C. Motor located outside of air flow.



Dimensions GB EC 710

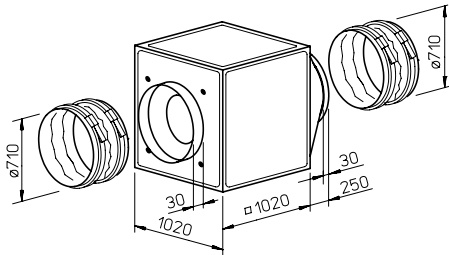

Dimensions GB EC 710 T120

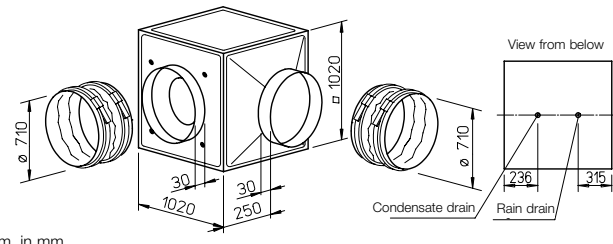

Special features of the GB EC T120 series

- Designed for the delivery of contaminated, humid and hot air up to max. 120 °C, e.g. as an extract air fan in commercial kitchens and many process technology applications.
- Motor located outside of air flow.
- Thermally insulated partition between motor and impeller, made of galvanised steel sheet, with 20 mm thick, non-flammable mineral wool.
- Complete motor-impeller unit can be removed without dismantling the system components.
- Inspection cover with handle, easily removable for cleaning and maintenance.
- Condensate tray with condensate drain as standard. Hole provided for rain drain (accessories) for outdoor installation.

Installation

Installation position with condensate drain below. Flexible installation due to three possible centrifugal outlet directions of the outlet fitting. Protected outdoor installation possible with weather protection cover and grille (accessories).

Electrical connection

Standard terminal box (IP54) directly to the commutation electronics.

Special features of the GB EC series

Any installation position and flexible installation due to five possible outlet directions of the outlet fitting. The wall bracket (accessories) must be used for wall installation. Protected outdoor installation possible with weather protection cover and grille (accessories).

Electrical connection

Standard terminal box (IP54) mounted to external cable.

Description for both series

Casing

Self-supporting frame construction made of aluminium hollow profiles. Double-walled, 20 mm thick side panels made of galvanised steel sheet, sound and heat insulated by non-flammable mineral wool lining. Nozzle on inlet side for optimal inflow as well as connectors and flexible connecting sleeve (for the respective max. permissible air flow temperature) for duct connection. Moulded part (square to round) on outlet side for low-loss outflow and flexible connecting sleeve to prevent structure-borne noise transmission. Simple positioning with standard crane hook.

Impeller

Free-running high performance centrifugal impeller made of aluminium, directly driven. Energy-efficient with low noise emission. Dynamically balanced together with the motor in accordance with DIN ISO 21940-11 – quality grade 2.5.

Drive

Energy-saving, speed-controllable EC external rotor motor in protection category IP54 with the highest level of efficiency. Maintenance-free and radio interference-free, ball bearing mounted.

Motor protection

Integrated electronic temperature monitoring system for EC motor and electronics.

Type	Connection Ø	Flow rate free blowing	Rated speed	Case-rad. sound pressure	Power consumption	Current consumption	Wiring diagram	Max. air flow temp.	Weight net aprx.	Universal control system		Speed potentiometer				
										Type	Ref. no.	Type	Ref. no.	Type	Ref. no.	
Three-phase current, 3~, 400 V, 50/60 Hz, EC motor, protection category IP54																
GBD EC 710 A	05816	710	15680	775	42	1.57	2.53	1415	60	117.0	EUR EC ¹⁾²⁾	01347	PU 24 ¹⁾	01736	PA 24 ¹⁾	01737
GBD EC 710 B	05819	710	18940	940	48	2.78	4.30	1415	60	121.0	EUR EC ¹⁾²⁾	01347	PU 24 ¹⁾	01736	PA 24 ¹⁾	01737
T120 Three-phase current, 3~, 400 V, 50/60 Hz, EC motor, protection category IP54																
GBD EC 710 T120	06488	710	18360	1380	51	4.63	7.80	1214.1	120	207.0	EUR EC ¹⁾²⁾	01347	PU 10 ¹⁾	01734	PA 10 ¹⁾	01735

1) Multiple EC fans can normally be connected. 2) Alternative electronic diff. pressure/temperature controller (EDR/ETR, No. 01437/01438) or three level speed switch (SU/SA, No. 04266/04267).

Performance curves GBD EC 710 A

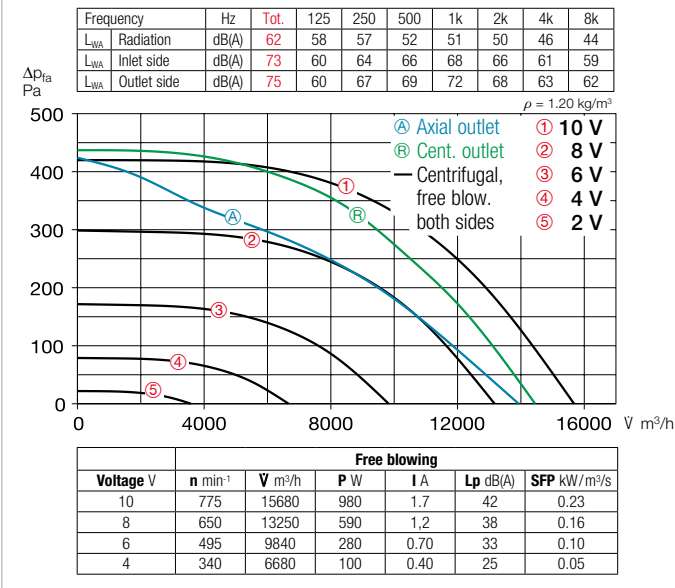

Performance curves GBD EC 710 B

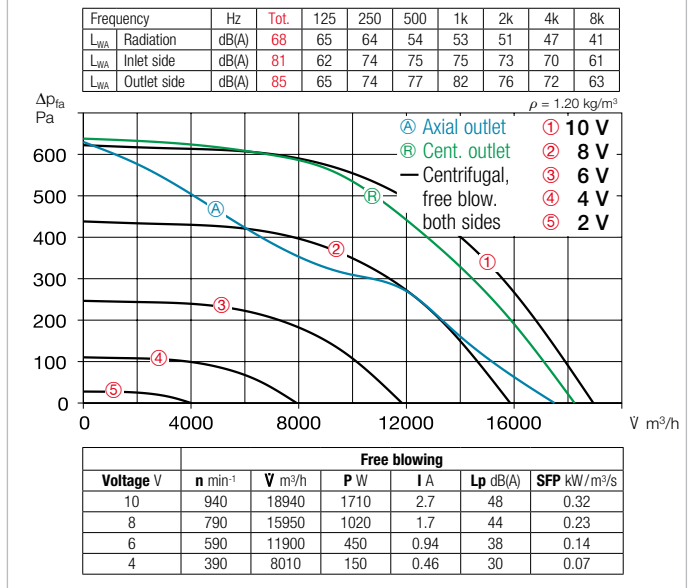

Performance curves GBD EC 710 T120

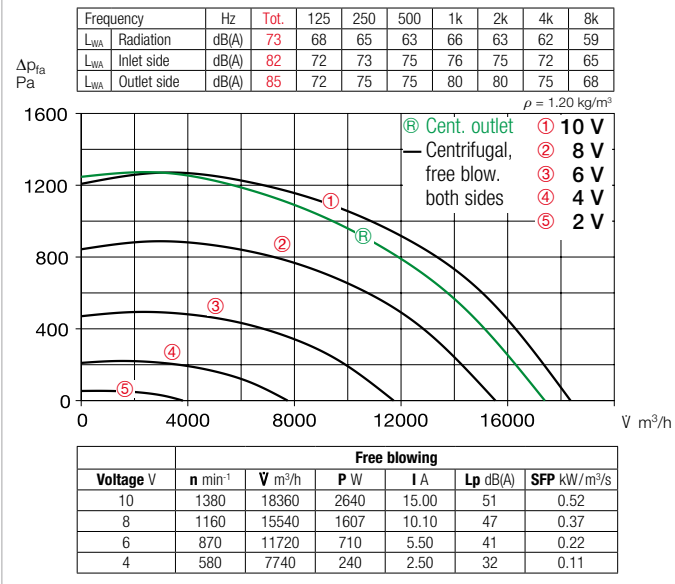

■ Power control

Continuously variable speed control with internal (delivery) or external potentiometer or continuously variable speed regulation with universal control system (see table). Performance levels are shown in the performance curve as an example.

■ Noise

The total level and range are specified above the performance diagram for:

- Case-radiated sound power
- Inlet side sound power
- Outlet side sound power

The case-radiated noise as sound pressure at 4 m (free field conditions) is also specified in the type table and the table below the performance curve.

■ Special accessories

for GB EC series

Condensate tray with drain connectors (central) for duct/hose connection.

GB-KW 710 Ref. no. 05646

(a condensate tray with condensate drain is included in delivery for GB EC T120).

Vibration dampers for indoor installation. 1 set = 4 pcs.

SDD-U Ref. no. 05627

for GB EC T120 series

Rain drain for outdoor installation (Hole in casing base already provided).

GB-RA Ref. no. 09418

■ Accessories for both series

Weather protection grille for outlet-side coverage.

GB-WSG 710 Ref. no. 05741

Weather protection cover for protected outdoor installation.

GB-WSD 710 Ref. no. 05750

■ References Page

Universal control system, electronic controllers, Speed potentiometer	605 ff.
---	---------

GB 250

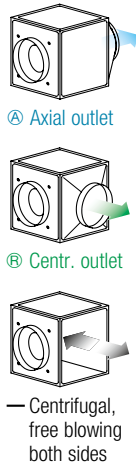

Any installation position and location due to five possible outlet directions.

Dimensions GB 250

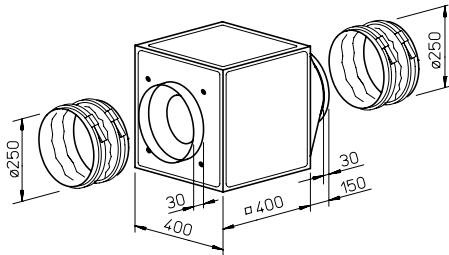

■ Casing

Self-supporting frame construction made of aluminium hollow profiles. Double-walled, 20 mm thick side panels made of galvanised steel sheet, sound and heat insulated by non-flammable mineral wool lining. Nozzle on inlet side for optimal inflow as well as connectors and flexible connecting sleeve (for the respective max. permissible air flow temperature) for duct connection. Moulded part (square to round) on outlet side for low-loss outflow and flexible connecting sleeve to prevent structure-borne noise transmission. Simple positioning with standard crane hook.

■ Impeller

Free-running high performance centrifugal impeller made of steel with backward curved blades on galvanised steel plate, directly driven. Energy-efficient with low noise emission.

Dynamically balanced together with the motor in accordance with DIN ISO 21940-11 – quality grade 2.5.

■ Drive

Through maintenance-free, speed-controllable external rotor motor in protection category IP44. Ball bearing mounted, radio interference-free.

■ Electrical connection

Standard terminal box (IP54) on motor.

■ Motor protection

Through built-in thermal contacts wired in series to the winding, automatic deactivation and reactivation after cooling.

■ Power control

Through voltage reduction using 5-step transformer or electronically speed-controllable. Performance levels are shown in the performance curve as an example.

Performance curves GBW 250/4

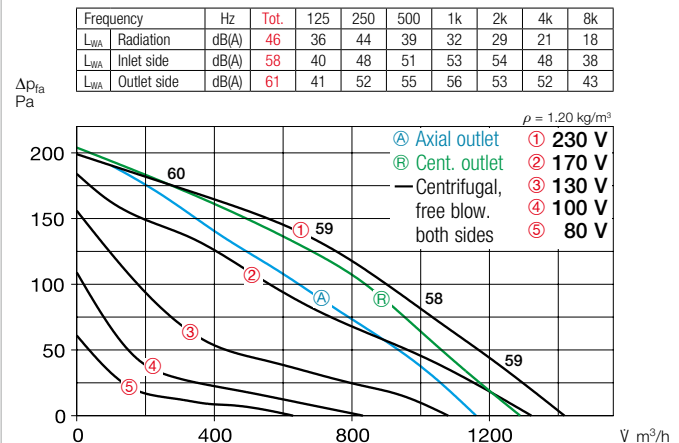

■ Accessories

Vibration dampers for indoor installation. 1 set = 4 pcs.
SDD-U Ref. no. 05627

Wall bracket for wall installation.
GB-WK 250 Ref. no. 05625

Weather protection grille for outlet-side coverage.
GB-WSG 250 Ref. no. 05637

Weather protection cover for protected outdoor installation.
GB-WSD 250 Ref. no. 05746

Condensate tray with drain connectors (central) for duct/hose connection.
GB-KW 250 Ref. no. 05642

■ References	Page
Planning information	10 ff.
General techn. information, power control	15 ff.
■ Accessory details	Page
Speed contr., controllers	591 ff.

Type	Ref. no.	Max. flow rate	Rated speed	Case-rad. sound pressure	Power consumption	Current consumption at rated voltage	Current consumption in control mode	Wiring diagram	Maximum air flow temp. at Rat. vol.	Maximum air flow temp. at control	Weight net aprx.	Transformer speed controller 5-step without motor protection circuit breaker
		V m ³ /h	min ⁻¹	dB(A) in 4m	kW	A	A	No.	+ °C	+ °C	kg	Type Ref. no.
Alternating current, 1~, 230 V, 50 Hz, Capacitor motor, protection category IP44												
GBW 250/4	05509	1410	1340	26	0.095	0.44	0.44	923	70	70	18.0	TSW 1.5 01495

GB 315



Dimensions GB 315

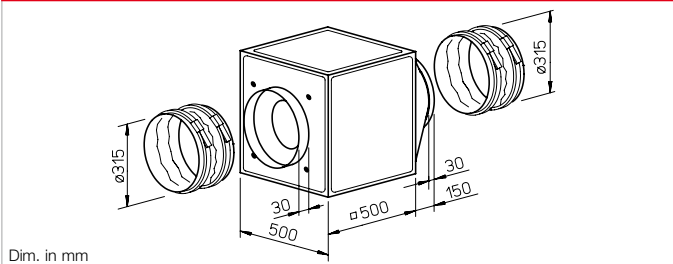

- Casing**
Self-supporting frame construction made of aluminium hollow profiles. Double-walled, 20 mm thick side panels made of galvanised steel sheet, sound and heat insulated by non-flammable mineral wool lining. Nozzle on inlet side for optimal inflow as well as connectors and flexible connecting sleeve (for the respective max. permissible air flow temperature) for duct connection. Moulded part (square to round) on outlet side for low-loss outflow and flexible connecting sleeve to prevent structure-borne noise transmission. Simple positioning with standard crane hook.
- Impeller**
Free-running high performance centrifugal impeller made of steel with backward curved blades on galvanised steel plate, directly driven. Energy-efficient with low noise emission. Dynamically balanced together with
- the motor in accordance with DIN ISO 21940-11 – quality grade 6.3.
- Drive**
Through maintenance-free, speed-controllable external rotor motor in protection category IP44. Ball bearing mounted, radio interference-free.
- Electrical connection**
Standard terminal box (IP54) on motor.
- Motor protection**
Through built-in thermal contacts wired in series to the winding, automatic deactivation and reactivation after cooling.
- Power control**
Through voltage reduction using 5-step transformer or electronically speed-controllable. Performance levels are shown in the performance curve as an example.

Performance curves GBW 315/4

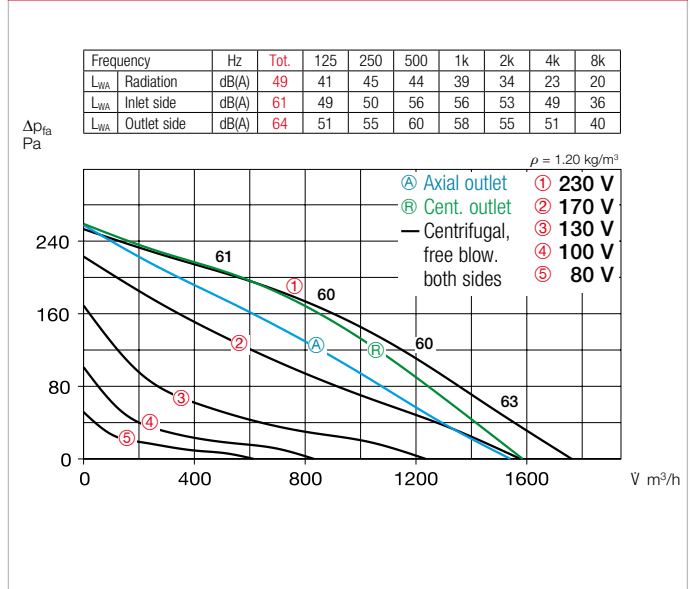

Box fans

- Installation**
Any installation position and flexible installation due to five possible outlet directions of the outlet fitting. The wall bracket (accessories) must be used for wall installation. Protected outdoor installation possible with weather protection cover and grille (accessories)
- Noise**
The total level and range are specified above the performance diagram for:
 Case-radiated sound power
 Inlet side sound power
 Outlet side sound power
 The inlet side sound power level is also specified above the nominal performance curve in the performance diagram.
 The case-radiated noise as sound pressure at 4 m (free field conditions) is also specified in the type table.
- Accessories**
Vibration dampers for indoor installation. 1 set = 4 pcs.
SDD-U Ref. no. 05627
Wall bracket for wall installation.
GB-WK 315 Ref. no. 05625
Weather protection grille for outlet-side coverage.
GB-WSG 315 Ref. no. 05638
Weather protection cover for protected outdoor installation.
GB-WSD 315 Ref. no. 05747
Condensate tray with drain connectors (central) for duct/hose connection.
GB-KW 315 Ref. no. 05643
- References**

References	Page
Planning information	10 ff.
General techn. information, power control	15 ff.

■ Accessory details

Accessory details	Page
Speed contr., controllers	591 ff.

Type	Ref. no.	Max. flow rate	Rated speed	Case-rad. sound pressure	Power consumption	Current consumption at rated voltage	Current consumption in control mode	Wiring diagram	Maximum air flow temp. at control	Weight net aprx.	Transformer speed controller 5-step without motor protection circuit breaker
		m^3/h	min^{-1}	dB(A) in 4m	kW	A	A	No.	+ °C	kg	Type Ref. no.
Alternating current, 1~, 230 V, 50 Hz, Capacitor motor, protection category IP44											
GBW 315/4	05510	1760	1230	29	0.123	0.55	0.55	923	55	55	31.0 TSW 1.5 01495

GB 355

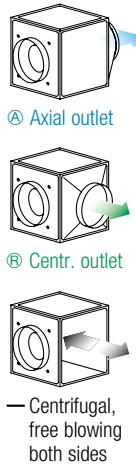

Any installation position and location due to five possible outlet directions.

GB 355 T120

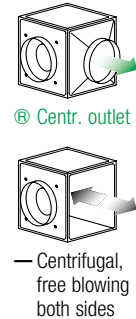

For the delivery of contaminated, humid and hot air up to max. 120 °C. Motor located outside of air flow.



Dimensions GB 355

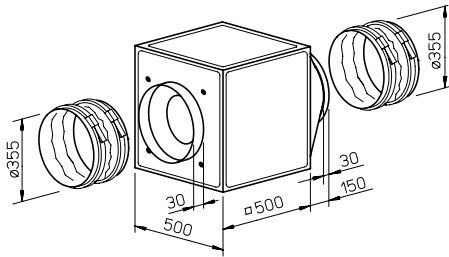

Dim. in mm

Dimensions GB 355 T120

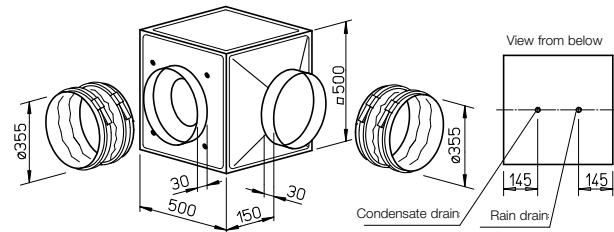

Dim. in mm

Special features of the GB T120 series

- Designed for the delivery of contaminated, humid and hot air up to max. 120 °C.
- Motor located outside of air flow.
- Thermally insulated partition between motor and impeller, made of galvanised steel sheet, with 20 mm thick, non-flammable mineral wool.
- Complete motor-impeller unit can be removed without dismantling the system components.
- Inspection cover with handle, easily removable for cleaning and maintenance.
- Condensate tray with condensate drain as standard. Hole provided for rain drain (accessories) for outdoor installation.

Installation GB T120

Installation position with condensate drain below. Flexible installation due to three possible centrifugal outlet directions of the outlet fitting. Protected outdoor installation possible with weather protection cover and grille (accessories).

Special features of the GB series

Any installation position and flexible installation due to five possible outlet directions of the outlet fitting. The wall bracket (accessories) must be used for wall installation. Protected outdoor installation possible with weather protection cover and grille (accessories).

Description for both series

Casing

Self-supporting frame construction made of aluminium hollow profiles. Double-walled, 20 mm thick side panels made of galvanised steel sheet, sound and heat insulated by non-flammable mineral wool lining. Nozzle on inlet side for optimal inflow as well as connectors and flexible connecting sleeve (for the respective max. permissible air flow temperature) for duct connection. Moulded part (square to round) on outlet side for low-loss outflow and flexible connecting sleeve to prevent structure-borne noise transmission. Simple positioning with standard crane hook.

Impeller

Free-running high performance centrifugal impeller with backward curved plastic blades on galvanised steel plate (aluminium impellers for GB T120), directly driven. Energy-efficient with low noise emission. Dynamically balanced together with the motor in accordance with DIN ISO 21940-11 – quality grade 6.3.

Drive

Through maintenance-free, speed-controllable external rotor motor or IEC standard motor in protection category IP54. Ball bearing mounted, radio interference-free.

Type	Max. flow rate	Rated speed	Case-rad. sound pressure	Power consumption	Current consumption at rated voltage	Current consumption in control mode	Wiring diagram	Max. air flow temperature at		Weight net appr.	Speed controller 5-step		Mot. prot. circ. break. for connecting built-in thermal contacts				
								Rat. vol.	Control		with motor prot. circuit breaker	without motor prot. circuit breaker		Type	Ref. no.	Type	Ref. no.
Alternating current, 1~, 230 V, 50 Hz, Capacitor motor, protection category IP54																	
GBW 355/4	05511	3060	1375	38	0.29	1.47	1.90	864	60	60	32.0	MWS 3	01948	TSW 3.0	01496	MW ¹⁾	01579
Two-speed, three-phase current motor, 3~, 400 V, 50 Hz, Y/Δ connection, protection category IP54																	
GBD 355/4/4	05512	2850/3100	1230/1405	34	0.25/0.34	0.41/0.75	0.75	867	55	55	35.0	RDS 1	01736	TSD 1.5	01737	MD	05849
T120 Alternating current, 1~, 230 V, 50 Hz, Capacitor motor, protection category IP54																	
GBW 355/4 T120	05770	3460	1340	36	0.32	1.55	1.75	935	120	120	38.0	MWS 3	01948	TSD 3.0	01496	MW ¹⁾	01579
T120 Two-speed, three-phase current motor, 3~, 400 V, 50 Hz, Y/Δ connection, protection category IP54																	
GBD 355/4/4 T120	05771	2990/3470	1100/1360	36	0.22/0.33	0.40/0.75	0.75	947	120	120	38.0	RDS 1	01736	TSD 0.8	01500	MD	05849

1) Incl. operating switch

Performance curves GBW 355/4

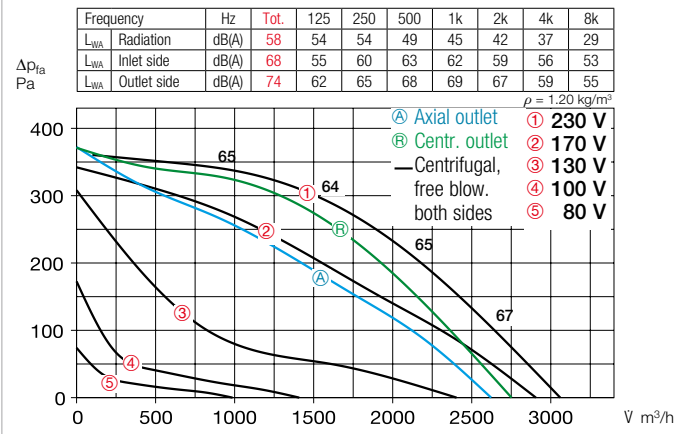

Performance curves GBW 355/4 T120

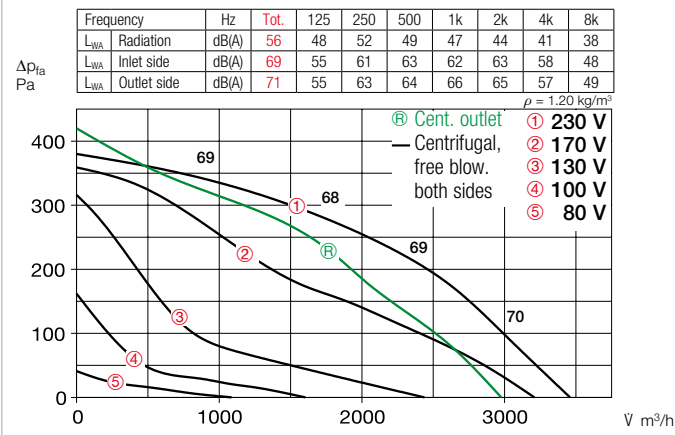

Performance curves GBD 355/4/4

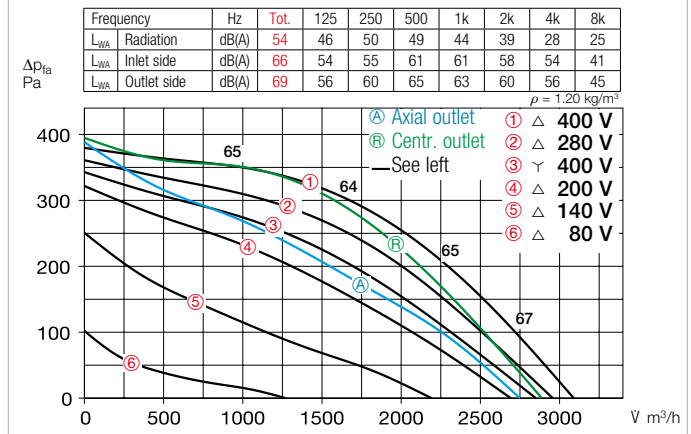

Performance curves GBD 355/4/4 T120

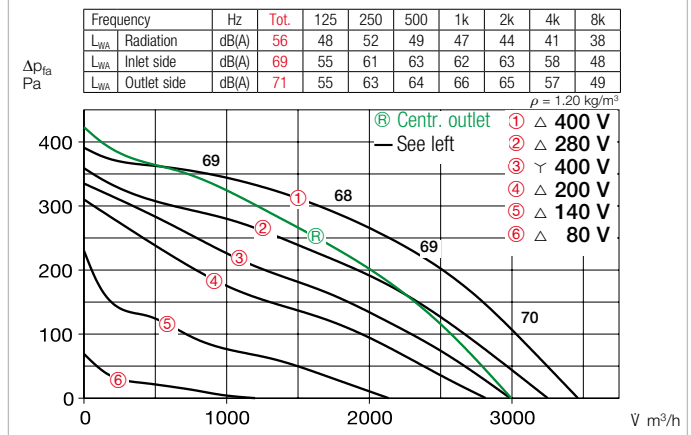

Electrical connection

Standard terminal box (IP54) on motor; on the motor support plate for GB T120.

Motor protection

With external thermal contacts on the terminal block, which must be wired to the motor protection circuit breaker.

Power control

All types are speed-controllable using voltage reduction by means of transformer (accessories). The 3~ types can also be operated at two speeds using a ∇/Δ switch or motor protection circuit breaker M4. Performance levels are shown in the performance diagram.

Noise

The total level and range are specified above the performance diagram for:

- Case-radiated sound power
- Inlet side sound power
- Outlet side sound power

The inlet side sound power level is also specified above the nominal performance curve in the performance diagram.

- The case-radiated noise as sound pressure at 4 m (free field conditions) is also specified in the type table.

Accessories for both series

Vibration dampers for indoor installation. 1 set = 4 pcs.

SDD-U Ref. no. 05627

Wall bracket for wall installation.

GB-WK 355 Ref. no. 05625

Weather protection grille for outlet-side coverage.

GB-WSG 355 Ref. no. 05638

Weather protection cover for protected outdoor installation.

GB-WSD 355 Ref. no. 05747

Speed switch and on/off switch for two-speed ∇/Δ switchable three-phase current fans.

DS 2²⁾ Ref. no. 01351

²⁾ required motor protection circuit breaker: Type MD, No. 05849.

Special accessories

for GB series

Condensate tray with drain connectors (central) for duct/hose connection.

GB-KW 355 Ref. no. 05643

(a condensate tray with condensate drain is included in delivery for GB T120).

for GB T120 series

Rain drain for outdoor installation (Hole in casing base already provided).

GB-RA Ref. no. 09418

References	Page
Planning information	10 ff.
General techn. information, power control	15 ff.
Accessory details	Page
Speed controllers and motor prot. circ. breakers	591 ff.

GB 400

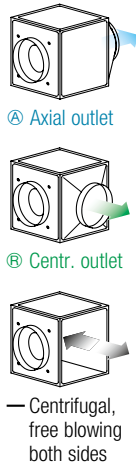

Any installation position and location due to five possible outlet directions.

GB 400 T120

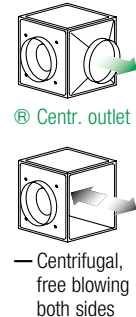

For the delivery of contaminated, humid and hot air up to max. 120 °C. Motor located outside of air flow.



Dimensions GB 400

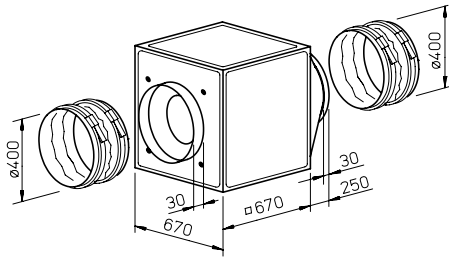

Dim. in mm

Dimensions GB 400 T120

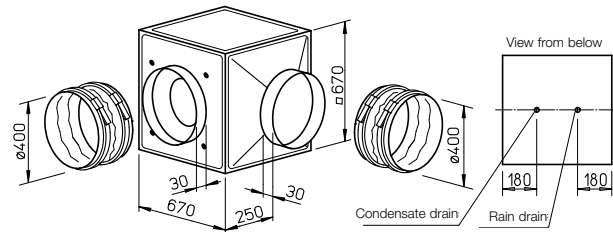

Dim. in mm

Special features of the GB T120 series

- Designed for the delivery of contaminated, humid and hot air up to max. 120 °C.
- Motor located outside of air flow.
- Thermally insulated partition between motor and impeller, made of galvanised steel sheet, with 20 mm thick, non-flammable mineral wool.
- Complete motor-impeller unit can be removed without dismantling the system components.
- Inspection cover with handle, easily removable for cleaning and maintenance.
- Condensate tray with condensate drain as standard. Hole provided for rain drain (accessories) for outdoor installation.

Installation GB T120

Installation position with condensate drain below. Flexible installation due to three possible centrifugal outlet directions of the outlet fitting. Protected outdoor installation possible with weather protection cover and grille (accessories).

Special features of the GB series

Any installation position and flexible installation due to five possible outlet directions of the outlet fitting. The wall bracket (accessories) must be used for wall installation. Protected outdoor installation possible with weather protection cover and grille (accessories).

Description for both series

- Casing**
Self-supporting frame construction made of aluminium hollow profiles. Double-walled, 20 mm thick side panels made of galvanised steel sheet, sound and heat insulated by non-flammable mineral wool lining. Nozzle on inlet side for optimal inflow as well as connectors and flexible connecting sleeve (for the respective max. permissible air flow temperature) for duct connection. Moulded part (square to round) on outlet side for low-loss outflow and flexible connecting sleeve to prevent structure-borne noise transmission. Simple positioning with standard crane hook.

Impeller

Free-running high performance centrifugal impeller with backward curved plastic blades on galvanised steel plate (aluminium impellers for GB T120), directly driven. Energy-efficient with low noise emission. Dynamically balanced together with the motor in accordance with DIN ISO 21940-11 – quality grade 2.5.

Drive

Through maintenance-free, speed-controllable external rotor motor or IEC standard motor in protection category IP54. Ball bearing mounted, radio interference-free.

Type	Max. flow rate	Rated speed	Case-rad. sound pressure	Power consumption	Current consumption at rated voltage		Wiring diagram No.	Max. air flow temperature at		Weight net appr. kg	Speed controller 5-step		Mot. prot. circ. break. for connecting built-in thermal contacts				
	V m³/h	min⁻¹	dB(A) in 4m	kW	A	A		Rat. vol.	Control		with motor prot. circuit breaker	without motor prot. circuit breaker	Type	Ref. no.	Type	Ref. no.	
Alternating current, 1~, 230 V, 50 Hz, Capacitor motor, protection category IP54																	
GBW 400/4	05513	4680	1400	29	0.51	2.45	3.26	864	60	60	52.0	MWS 5	01949	TSW 5.0	01497	MW ¹⁾	01579
Two-speed, three-phase current motor, 3~, 400 V, 50 Hz, Y/Δ connection, protection category IP54																	
GBD 400/4/4	05514	4140/4650	1105/1355	28	0.31/0.44	0.51/0.88	0.92	867	60	60	52.0	RDS 2	01315	TSD 1.5	01501	MD	05849
T120 Alternating current, 1~, 230 V, 50 Hz, Capacitor motor, protection category IP54																	
GBW 400/4 T120	05772	4930	1280	40	0.54	2.50	2.50	935	120	100	62.0	MWS 3	01948	TSD 3.0	01496	MW ¹⁾	01579
T120 Two-speed, three-phase current motor, 3~, 400 V, 50 Hz, Y/Δ connection, protection category IP54																	
GBD 400/4/4 T120	05773	4010/4870	975/1255	40	0.29/0.48	0.50/1.10	1.10	947	120	120	62.0	RDS 2	01315	TSD 1.5	01501	MD	05849

1) Incl. operating switch

Performance curves GBW 400/4

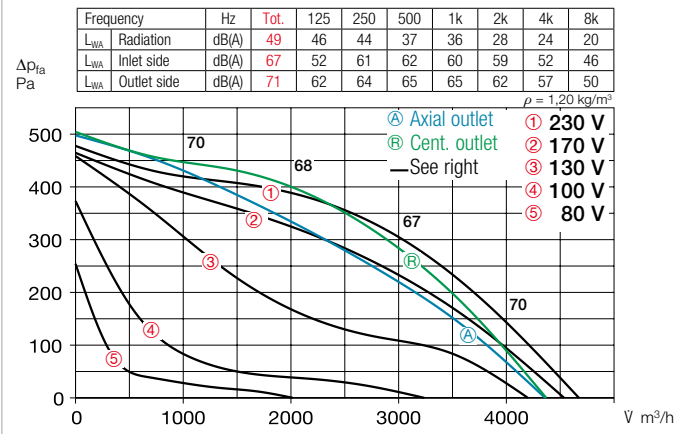

Performance curves GBD 400/4/4

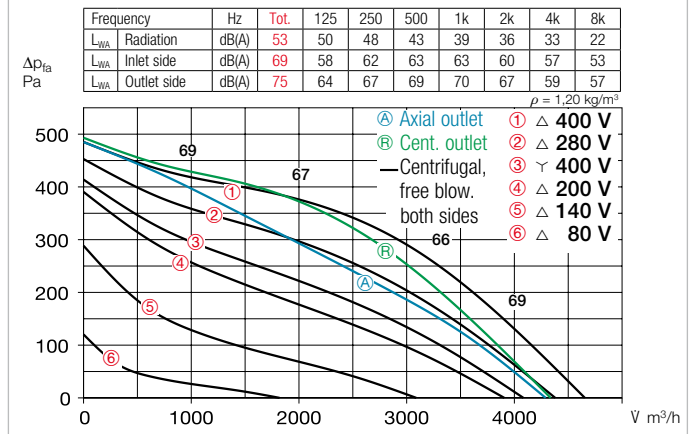

Performance curves GBW 400/4 T120

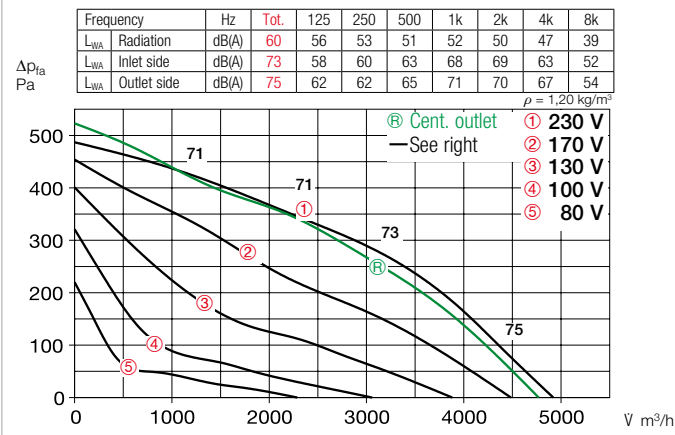

Performance curves GBD 400/4/4 T120

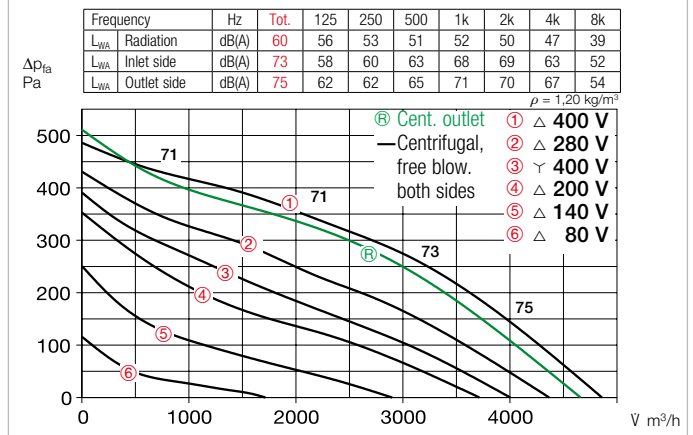

Electrical connection

Standard terminal box (IP54) on motor; on the motor support plate for GB T120.

Motor protection

With external thermal contacts on the terminal block, which must be wired to the motor protection circuit breaker.

Power control

All types are speed-controllable using voltage reduction by means of transformer (accessories). The 3~ types can also be operated at two speeds using a ∇/Δ switch or motor protection circuit breaker M4. Performance levels are shown in the performance diagram.

Noise

The total level and range are specified above the performance diagram for:

- Case-radiated sound power
- Inlet side sound power
- Outlet side sound power

The inlet side sound power level is also specified above the nominal performance curve in the performance diagram.

- The case-radiated noise as sound pressure at 4 m (free field conditions) is also specified in the type table.

Accessories for both series

Vibration dampers for indoor installation. 1 set = 4 pcs.

SDD-U Ref. no. 05627

Wall bracket for wall installation.

GB-WK 400 Ref. no. 05626

Weather protection grille for outlet-side coverage.

GB-WSG 400 Ref. no. 05639

Weather protection cover for protected outdoor installation.

GB-WSD 400 Ref. no. 05748

Speed switch and on/off switch

for two-speed ∇/Δ switchable three-phase current fans.

DS 2²⁾ Ref. no. 01351

²⁾ required motor protection circuit breaker: Type MD, No. 05849.

Special accessories

for GB series

Condensate tray with drain connectors (central) for duct/hose connection.

GB-KW 400 Ref. no. 05644

(a condensate tray with condensate drain is included in delivery for GB T120).

for GB T120 series

Rain drain for outdoor installation (Hole in casing base already provided).

GB-RA Ref. no. 09418

References	Page
Planning information	10 ff.
General techn. information, power control	15 ff.
Accessory details	Page
Speed controllers and motor prot. circ. breakers	591 ff.

GB 450

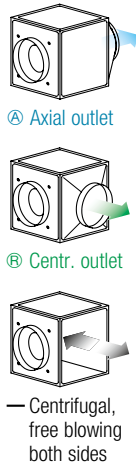

Any installation position and location due to five possible outlet directions.

GB 450 T120

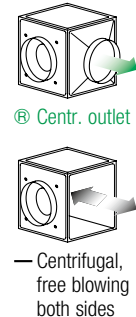

For the delivery of contaminated, humid and hot air up to max. 120 °C. Motor located outside of air flow.



Dimensions GB 450

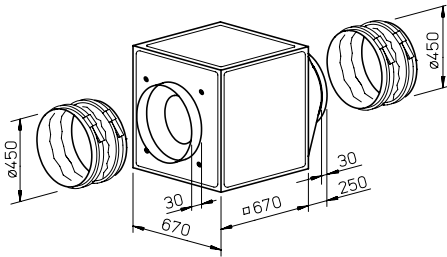

Dimensions GB 450 T120

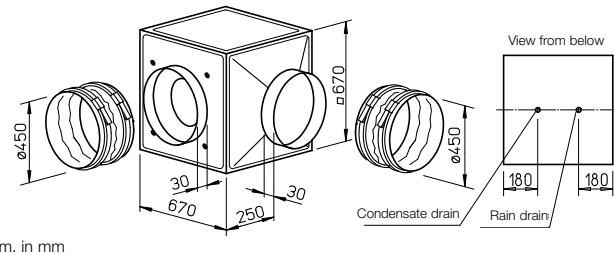

Special features of the GB T120 series

- Designed for the delivery of contaminated, humid and hot air up to max. 120 °C.
- Motor located outside of air flow.
- Thermally insulated partition between motor and impeller, made of galvanised steel sheet, with 20 mm thick, non-flammable mineral wool.
- Complete motor-impeller unit can be removed without dismantling the system components.
- Inspection cover with handle, easily removable for cleaning and maintenance.
- Condensate tray with condensate drain as standard. Hole provided for rain drain (accessories) for outdoor installation.

Installation GB T120

Installation position with condensate drain below. Flexible installation due to three possible centrifugal outlet directions of the outlet fitting. Protected outdoor installation possible with weather protection cover and grille (accessories).

Special features of the GB series

Any installation position and flexible installation due to five possible outlet directions of the outlet fitting. The wall bracket (accessories) must be used for wall installation. Protected outdoor installation possible with weather protection cover and grille (accessories).

Description for both series

- **Casing**
Self-supporting frame construction made of aluminium hollow profiles. Double-walled, 20 mm thick side panels made of galvanised steel sheet, sound and heat insulated by non-flammable mineral wool lining. Nozzle on inlet side for optimal inflow as well as connectors and flexible connecting sleeve (for the respective max. permissible air flow temperature) for duct connection. Moulded part (square to round) on outlet side for low-loss outflow and flexible connecting sleeve to prevent structure-borne noise transmission. Simple positioning with standard crane hook.

Impeller

Free-running high performance centrifugal impeller with backward curved plastic blades (aluminium impellers for GB T120), directly driven. Energy-efficient with low noise emission. Dynamically balanced together with the motor in accordance with DIN ISO 21940-11 – quality grade 2.5.

Drive

Through maintenance-free, speed-controllable external rotor motor or IEC standard motor in protection category IP54. Ball bearing mounted, radio interference-free.

Electrical connection

Standard terminal box (IP54) on motor; on the motor support plate for GB T120.

Type	Max. flow rate	Rated speed	Case-rad. sound pressure	Power consumption	Current consumption		Wiring diagram	Max. air flow temperature at		Weight net aprx.	Speed controller 5-step		Mot. prot. circ. break. for connecting built-in thermal contacts				
					at rated voltage	in control mode		Rat. vol.	Control		with motor prot. circuit breaker	without motor prot. circuit breaker	Type	Ref. no.	Type	Ref. no.	
	V m³/h	min⁻¹	dB(A) in 4m	kW	A	A	No.	+ °C	+ °C	kg	Type	Ref. no.	Type	Ref. no.	Type	Ref. no.	
Alternating current, 1~, 230 V, 50 Hz, Capacitor motor, protection category IP54																	
GBW 450/4	05515	4600	1380	40	0.66	2.90	4.0	864	45	45	49.0	MWS 5	01949	TSW 5.0	01497	MW ¹⁾	01579
Two-speed, three-phase current motor, 3~, 400 V, 50 Hz, Y/Δ connection, protection category IP54																	
GBD 450/4/4	05516	5670/6500	1060/1345	42	0.50/0.73	0.87/1.47	1.52	867	55	55	50.0	RDS 2	01315	TSD 1.5	01501	MD	05849
Ⓜ T120 Alternating current, 1~, 230 V, 50 Hz, Capacitor motor, protection category IP54																	
GBW 450/4 T120	05774	7110	1370	45	1.00	4.60	5.50	935	120	100	74.0	MWS 7.5	01950	TSD 7.5	01596	MW ¹⁾	01579
Ⓜ T120 Two-speed, three-phase current motor, 3~, 400 V, 50 Hz, Y/Δ connection, protection category IP54																	
GBD 450/4/4 T120	05775	6210/7180	1100/1350	45	0.65/0.90	1.10/1.60	1.80	947	120	110	74.0	RDS 2	01315	TSD 3.0	01502	MD	05849

1) Incl. operating switch.

Performance curves GBW 450/4

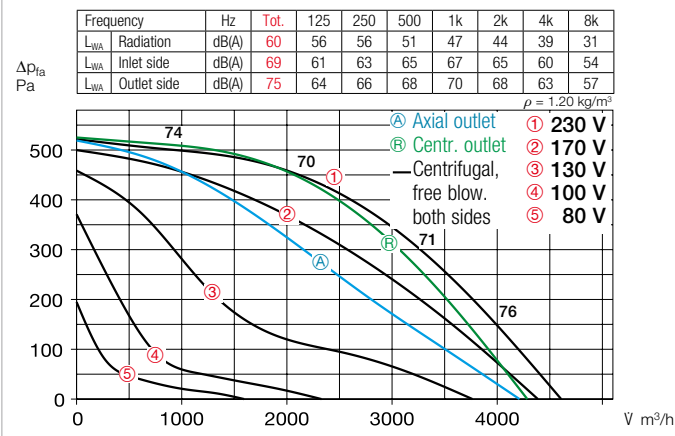

Performance curves GBD 450/4/4

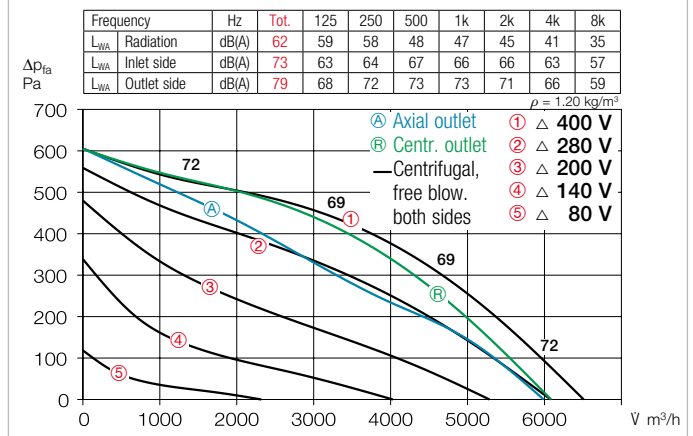

Performance curves GBW 450/4 T120

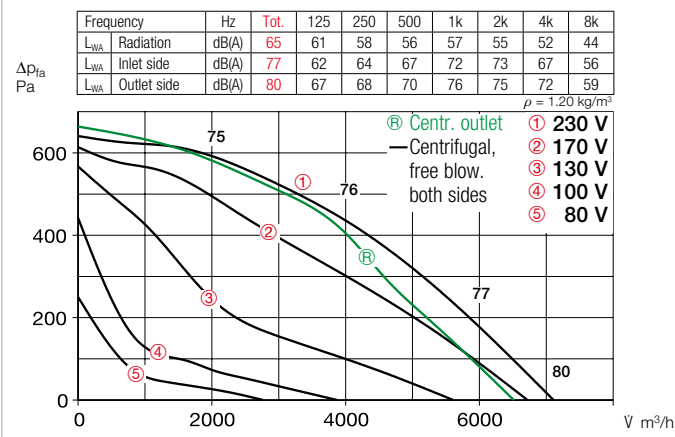

Performance curves GBD 450/4/4 T120

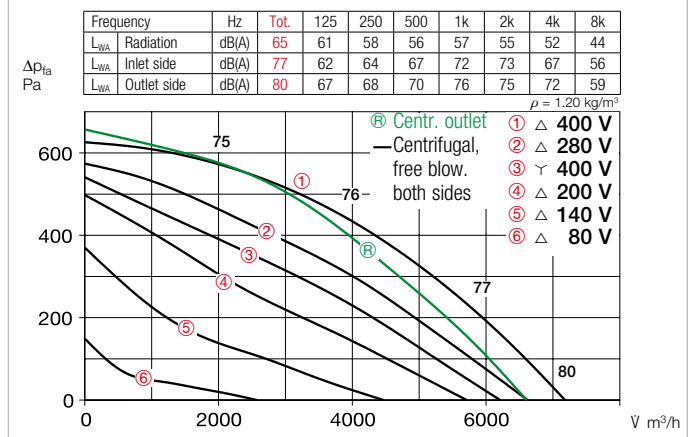

Motor protection

With external thermal contacts on the terminal block, which must be wired to the motor protection circuit breaker.

Power control

All types are speed-controllable using voltage reduction by means of transformer (accessories). The 3~ types can also be operated at two speeds using a Y/Δ switch or motor protection circuit breaker M4. Performance levels are shown in the performance diagram.

Noise

The total level and range are specified above the performance diagram for:

- Case-radiated sound power
- Inlet side sound power
- Outlet side sound power

The inlet side sound power level is also specified above the nominal performance curve in the performance diagram.

- The case-radiated noise as sound pressure at 4 m (free field conditions) is also specified in the type table.

Accessories for both series

Vibration dampers for indoor installation. 1 set = 4 pcs.

SDD-U Ref. no. 05627

Wall bracket for wall installation.

GB-WK 450 Ref. no. 05626

Weather protection grille for outlet-side coverage.

GB-WSG 450 Ref. no. 05639

Weather protection cover for protected outdoor installation.

GB-WSD 450 Ref. no. 05748

Speed switch and on/off switch

for two-speed Y/Δ switchable three-phase current fans.

DS 2²⁾ Ref. no. 01351

²⁾ required motor protection circuit breaker: Type MD, No. 05849.

Special accessories

for GB series

Condensate tray with drain connectors (central) for duct/hose connection.

GB-KW 450 Ref. no. 05644

(a condensate tray with condensate drain is included in delivery for GB T120).

for GB T120 series

Rain drain for outdoor installation (Hole in casing base already provided).

GB-RA Ref. no. 09418

References	Page
Planning information	10 ff.
General techn. information, power control	15 ff.
Accessory details	Page
Speed controllers and motor prot. circ. breakers	591 ff.

GB 500

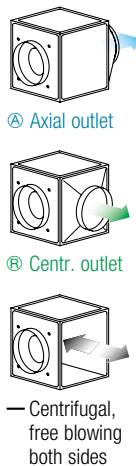

Any installation position and location due to five possible outlet directions.

GB 500 T120

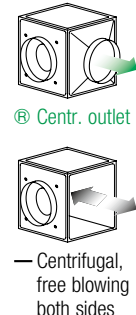

For the delivery of contaminated, humid and hot air up to max. 120 °C. Motor located outside of air flow.



Dimensions GB 500

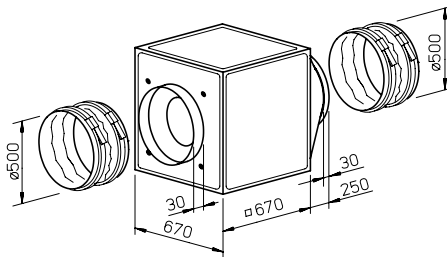

Dim. in mm

Dimensions GB 500 T120

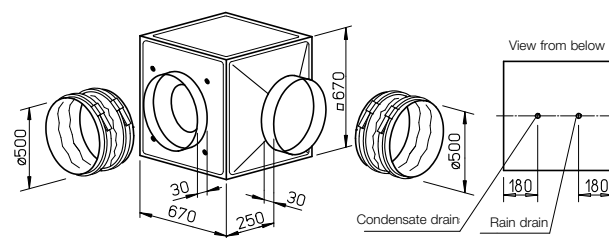

Dim. in mm

Special features of the GB T120 series

- Designed for the delivery of contaminated, humid and hot air up to max. 120 °C.
- Motor located outside of air flow.
- Thermally insulated partition between motor and impeller, made of galvanised steel sheet, with 20 mm thick, non-flammable mineral wool.
- Complete motor-impeller unit can be removed without dismantling the system components.
- Inspection cover with handle, easily removable for cleaning and maintenance.
- Condensate tray with condensate drain as standard. Hole provided for rain drain (accessories) for outdoor installation.

Installation GB T120

Installation position with condensate drain below. Flexible installation due to three possible centrifugal outlet directions of the outlet fitting. Protected outdoor installation possible with weather protection cover and grille (accessories).

Special features of the GB series

Any installation position and flexible installation due to five possible outlet directions of the outlet fitting. The wall bracket (accessories) must be used for wall installation. Protected outdoor installation possible with weather protection cover and grille (accessories).

Description for both series

- **Casing**
Self-supporting frame construction made of aluminium hollow profiles. Double-walled, 20 mm thick side panels made of galvanised steel sheet, sound and heat insulated by non-flammable mineral wool lining. Nozzle on inlet side for optimal inflow as well as connectors and flexible connecting sleeve (for the respective max. permissible air flow temperature) for duct connection. Moulded part (square to round) on outlet side for low-loss outflow and flexible connecting sleeve to prevent structure-borne noise transmission. Simple positioning with standard crane hook.

Impeller

Free-running high performance centrifugal impeller made of aluminium with backward curved blades, directly driven. Energy-efficient with low noise emission. Dynamically balanced together with the motor in accordance with DIN ISO 21940-11 – quality grade 2.5.

Drive

Through maintenance-free, speed-controllable external rotor motor or IEC standard motor in protection category IP54. Ball bearing mounted, radio interference-free.

Electrical connection

Standard terminal box (IP54) on motor; on the motor support plate for GB T120.

Type	Max. flow rate	Rated speed	Case-rad. sound pressure	Power consumption	Current consumption at rated voltage	Current consumption in control mode	Wiring diagram	Max. air flow temperature at Rat. vol.	Weight net appr.	Speed controller 5-step		Mot. prot. circ. break. for connecting built-in thermal contacts	
										with motor prot. circuit breaker	without motor prot. circuit breaker		Type
Alternating current, 1~, 230 V, 50 Hz, Capacitor motor, protection category IP54													
GBW 500/4	05517	8320	1400	47	1.50	6.70	9.60	65	55	61	MWS 10 01946	TSW 10 01498	MW ¹⁾ 01579
Two-speed, three-phase current motor, 3~, 400 V, 50 Hz, Y/Δ connection, protection category IP54													
GBD 500/4/4	05518	8000/9200	1075/1340	45	0.97/1.45	1.60/2.80	2.90	867	50	50	RDS 7 01578	TSD 5.5 01503	MD 05849
T120 Alternating current, 1~, 230 V, 50 Hz, Capacitor motor, protection category IP54													
GBW 500/4 T120	05776	8345	1340	45	1.40	6.1	7.0	301	120	100	MWS 10 01946	–	–
T120 Two-speed, three-phase current motor, 3~, 400 V, 50 Hz, Y/Δ connection, protection category IP54													
GBD 500/4/4 T120	05777	7320/8350	1120/1370	45	0.95/1.30	1.60/2.50	2.5	947	120	110	RDS 4 01316	TSD 3.0 01502	MD 05849

1) Incl. operating switch

Performance curves GBW 500/4

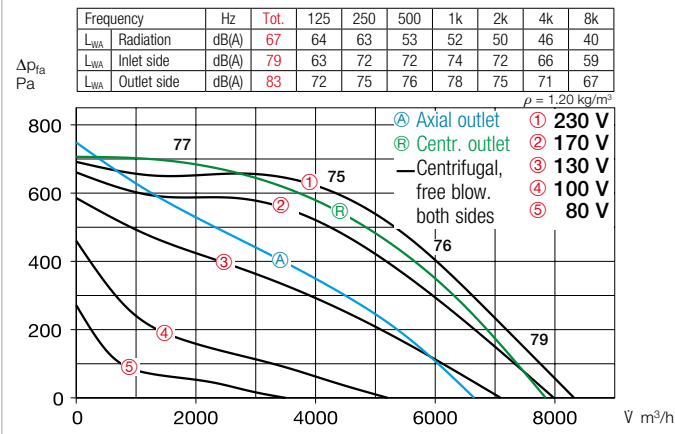

Performance curves GBW 500/4 T120

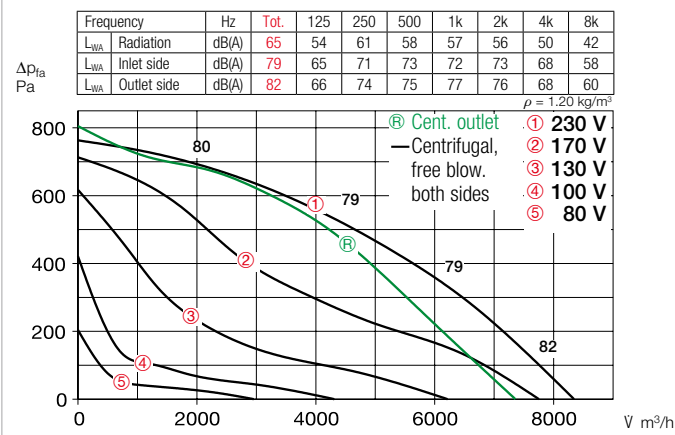

Performance curves GBD 500/4/4

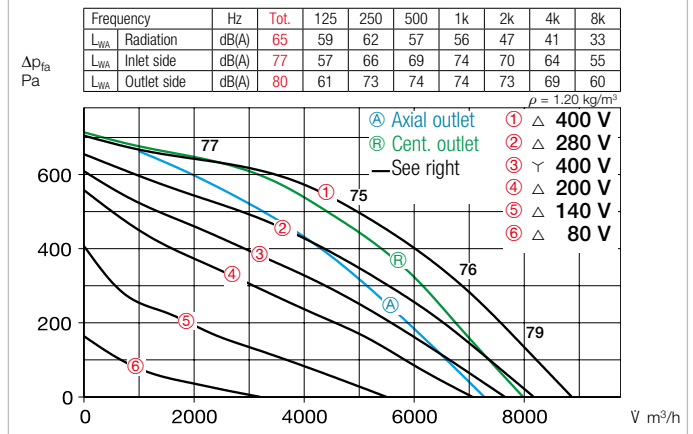

Performance curves GBD 500/4/4 T120

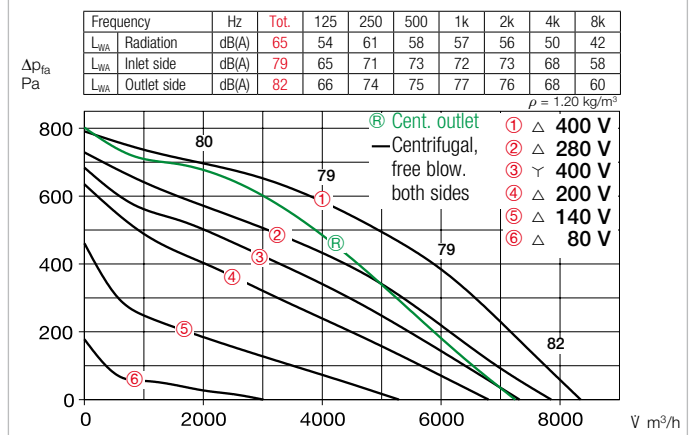

Motor protection

With external thermal contacts on the terminal block, which must be wired to the motor protection circuit breaker.

Power control

All types are speed-controllable using voltage reduction by means of transformer (accessories). The 3~ types can also be operated at two speeds using a ∇/Δ switch or motor protection circuit breaker M4. Performance levels are shown in the performance diagram.

Noise

The total level and range are specified above the performance diagram for:

- Case-radiated sound power
- Inlet side sound power
- Outlet side sound power

The inlet side sound power level is also specified above the nominal performance curve in the performance diagram.

- The case-radiated noise as sound pressure at 4 m (free field conditions) is also specified in the type table.

Accessories for both series

Vibration dampers for indoor installation. 1 set = 4 pcs.

SDD-U Ref. no. 05627

Wall bracket for wall installation.

GB-WK 500 Ref. no. 05626

Weather protection grille for outlet-side coverage.

GB-WSG 500 Ref. no. 05639

Weather protection cover for protected outdoor installation.

GB-WSD 500 Ref. no. 05748

Speed switch and on/off switch for two-speed ∇/Δ switchable three-phase current fans.

DS 2²⁾ Ref. no. 01351

²⁾ required motor protection circuit breaker: Type MD, No. 05849.

Special accessories

for GB series

Condensate tray with drain connectors (central) for duct/hose connection.

GB-KW 500 Ref. no. 05644

(a condensate tray with condensate drain is included in delivery for GB T120).

for GB T120 series

Rain drain for outdoor installation (Hole in casing base already provided).

GB-RA Ref. no. 09418

References	Page
Planning information	10 ff.
General techn. information, power control	15 ff.
Accessory details	Page
Speed controllers and motor prot. circ. breakers	591 ff.

GB 560

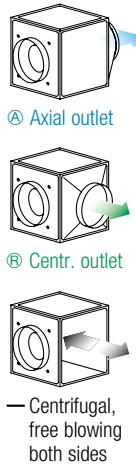

Any installation position and location due to five possible outlet directions.

GB 560 T120

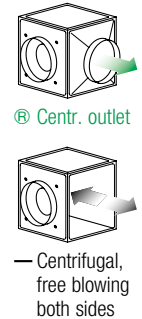

For the delivery of contaminated, humid and hot air up to max. 120 °C. Motor located outside of air flow.



Dimensions GB 560

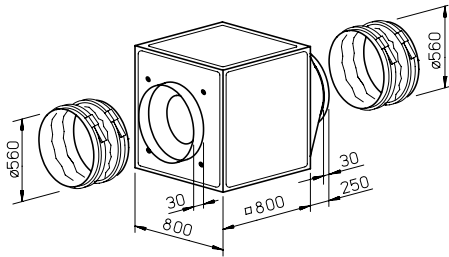

Dimensions GB 560 T120

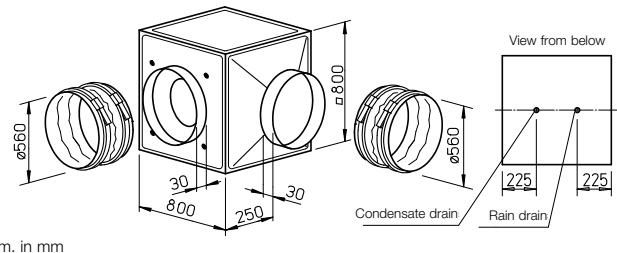

Special features of the GB T120 series

- Designed for the delivery of contaminated, humid and hot air up to max. 120 °C.
- Motor located outside of air flow.
- Thermally insulated partition between motor and impeller, made of galvanised steel sheet, with 20 mm thick, non-flammable mineral wool.
- Complete motor-impeller unit can be removed without dismantling the system components.
- Inspection cover with handle, easily removable for cleaning and maintenance.
- Condensate tray with condensate drain as standard. Hole provided for rain drain (accessories) for outdoor installation.

Installation GB T120

Installation position with condensate drain below. Flexible installation due to three possible centrifugal outlet directions of the outlet fitting. Protected outdoor installation possible with weather protection cover and grille (accessories).

Special features of the GB series

Any installation position and flexible installation due to five possible outlet directions of the outlet fitting. The wall bracket (accessories) must be used for wall installation. Protected outdoor installation possible with weather protection cover and grille (accessories).

Description for both series

- Casing**
Self-supporting frame construction made of aluminium hollow profiles. Double-walled, 20 mm thick side panels made of galvanised steel sheet, sound and heat insulated by non-flammable mineral wool lining. Nozzle on inlet side for optimal inflow as well as connectors and flexible connecting sleeve (for the respective max. permissible air flow temperature) for duct connection. Moulded part (square to round) on outlet side for low-loss outflow and flexible connecting sleeve to prevent structure-borne noise transmission. Simple positioning with standard crane hook.

Impeller

Free-running high performance centrifugal impeller made of aluminium with backward curved blades, directly driven. Energy-efficient with low noise emission. Dynamically balanced together with the motor in accordance with DIN ISO 21940-11 – quality grade 2.5.

Drive

Through maintenance-free, speed-controllable external rotor motor or IEC standard motor in protection category IP54. Ball bearing mounted, radio interference-free.

Electrical connection

Standard terminal box (IP54) on motor; on the motor support plate for GB T120.

Type	Max. flow rate	Rated speed	Case-rad. sound pressure	Power consumption	Current consumption at rated voltage	Current consumption in control mode	Wiring diagram	Max. air flow temperature at Rat. vol.	Max. air flow temperature at Control	Weight net aprx.	Speed controller 5-step		Mot. prot. circ. break. for connecting built-in thermal contacts				
	V m³/h	min⁻¹	dB(A) in 4m	kW	A	A	No.	+ °C	+ °C	kg	Type	Ref. no.	Type	Ref. no.	Type	Ref. no.	
Alternating current, 1~, 230 V, 50 Hz, Capacitor motor, protection category IP54																	
GBW 560/4	05508	9120	1410	45	1.83	7.93	11.1	865	45	45	92	MWS 10	01946	TSW 10	01498	MW ¹⁾	01579
Two-speed, three-phase current motor, 3~, 400 V, 50 Hz, Y/Δ connection, protection category IP54																	
GBD 560/6/6	05522	7800/9000	705/885	35	0.51/0.80	0.90/1.85	1.90	867	60	60	80	RDS 4	01578	TSD 3.0	01502	MD	05849
GBD 560/4/4	05521	11500/13000	1110/1350	44	1.70/2.60	2.80/4.80	4.90	867	55	45	90	RDS 7	01578	TSD 7.0	01504	MD	05849
T120 Two-speed, three-phase current motor, 3~, 400 V, 50 Hz, Y/Δ connection, protection category IP54																	
GBD 560/4/4 T120	05778	11520/12300	1250/1400	48	1.85/2.50	3.20/6.80	6.80	520	120	120	105	RDS 7	01578	TSD 7.0	01504	MD	05849

1) Incl. operating switch.

Performance curves GBD 560/6/6

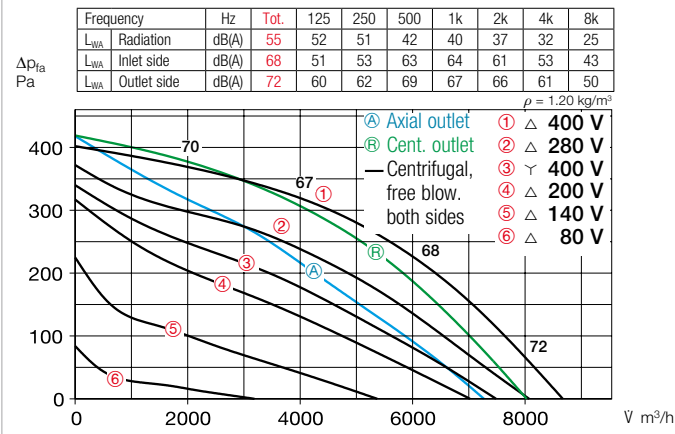

Performance curves GBD 560/4/4

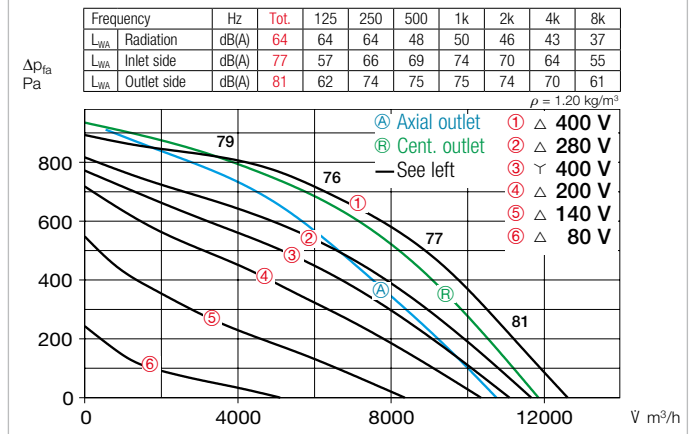

Performance curves GBD 560/4/4 T120

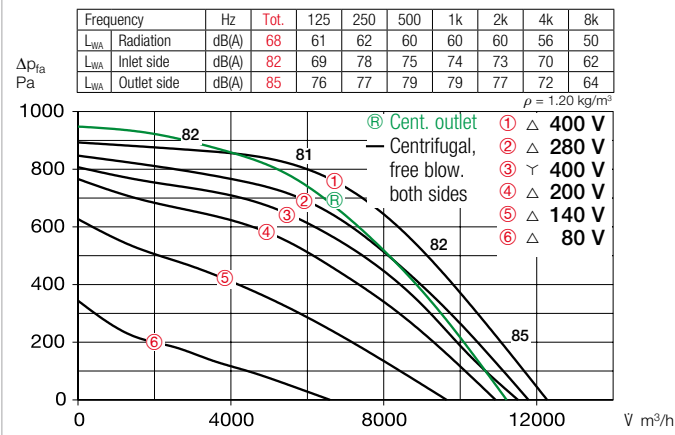

Performance curves GBW 560/4

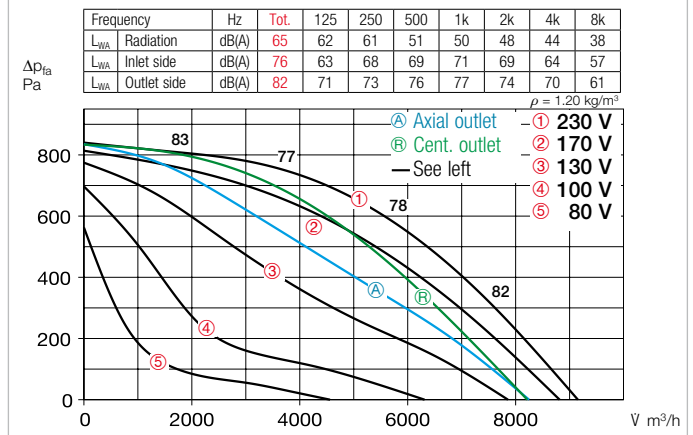

■ Motor protection

With external thermal contacts on the terminal block, which must be wired to the motor protection circuit breaker.

■ Power control

All types are speed-controllable using voltage reduction by means of transformer (accessories). The 3~ types can also be operated at two speeds using a ∇/Δ switch or motor protection circuit breaker M4. Performance levels are shown in the performance diagram.

■ Noise

The total level and range are specified above the performance diagram for:

- Case-radiated sound power
- Inlet side sound power
- Outlet side sound power

The inlet side sound power level is also specified above the nominal performance curve in the performance diagram.

- The case-radiated noise as sound pressure at 4 m (free field conditions) is also specified in the type table.

■ Accessories for both series

Vibration dampers for indoor installation. 1 set = 4 pcs.

SDD-U Ref. no. 05627

Wall bracket for wall installation.

GB-WK 560 Ref. no. 05626

Weather protection grille for outlet-side coverage.

GB-WSG 560 Ref. no. 05640

Weather protection cover for protected outdoor installation.

GB-WSD 560 Ref. no. 05749

Speed switch and on/off switch for two-speed ∇/Δ switchable three-phase current fans.

DS 2²⁾ Ref. no. 01351

²⁾ required motor protection circuit breaker: Type MD, No. 05849.

■ Special accessories

for GB series

Condensate tray with drain connectors (central) for duct/hose connection.

GB-KW 560 Ref. no. 05645

(a condensate tray with condensate drain is included in delivery for GB T120).

for GB T120 series

Rain drain for outdoor installation (Hole in casing base already provided).

GB-RA Ref. no. 09418

References	Page
Planning information	10 ff.
General techn. information, power control	15 ff.
Accessory details	Page
Speed controllers and motor prot. circ. breakers	591 ff.

GB 630

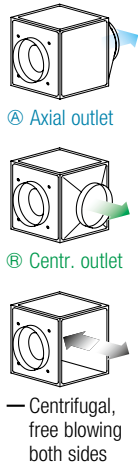

Any installation position and location due to five possible outlet directions.

GB 630 T120

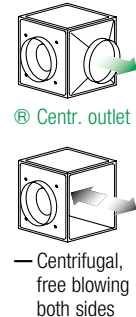

For the delivery of contaminated, humid and hot air up to max. 120 °C. Motor located outside of air flow.



Dimensions GB 630

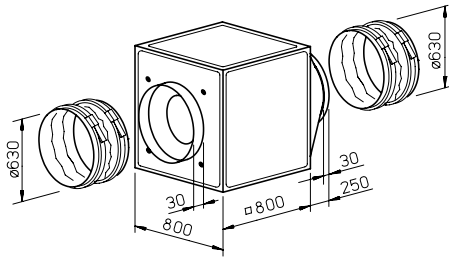

Dimensions GB 630 T120

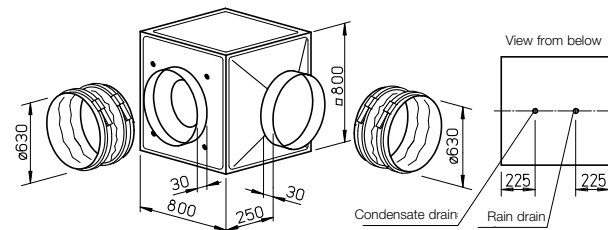

Special features of the GB T120 series

- Designed for the delivery of contaminated, humid and hot air up to max. 120 °C.
- Motor located outside of air flow.
- Thermally insulated partition between motor and impeller, made of galvanised steel sheet, with 20 mm thick, non-flammable mineral wool.
- Complete motor-impeller unit can be removed without dismantling the system components.
- Inspection cover with handle, easily removable for cleaning and maintenance.
- Condensate tray with condensate drain as standard. Hole provided for rain drain (accessories) for outdoor installation.

Installation GB T120

Installation position with condensate drain below. Flexible installation due to three possible centrifugal outlet directions of the outlet fitting. Protected outdoor installation possible with weather protection cover and grille (accessories).

Special features of the GB series

Any installation position and flexible installation due to five possible outlet directions of the outlet fitting. The wall bracket (accessories) must be used for wall installation. Protected outdoor installation possible with weather protection cover and grille (accessories).

Description for both series

- **Casing**
Self-supporting frame construction made of aluminium hollow profiles. Double-walled, 20 mm thick side panels made of galvanised steel sheet, sound and heat insulated by non-flammable mineral wool lining. Nozzle on inlet side for optimal inflow as well as connectors and flexible connecting sleeve (for the respective max. permissible air flow temperature) for duct connection. Moulded part (square to round) on outlet side for low-loss outflow and flexible connecting sleeve to prevent structure-borne noise transmission. Simple positioning with standard crane hook.

Impeller

Free-running high performance centrifugal impeller made of aluminium with backward curved blades, directly driven. Energy-efficient with low noise emission. Dynamically balanced together with the motor in accordance with DIN ISO 21940-11 – quality grade 2.5.

Drive

Through maintenance-free, speed-controllable external rotor motor or IEC standard motor in protection category IP54. Ball bearing mounted, radio interference-free.

Electrical connection

Standard terminal box (IP54) on motor; on the motor support plate for GB T120.

Type	Max. flow rate	Rated speed	Case-rad. sound pressure	Power consumption	Current consumption		Wiring diagram	Max. air flow temperature at		Weight net aprx.	Speed controller 5-step		Mot. prot. circ. break. for connecting built-in thermal contacts				
					at rated voltage	in control mode		Rat. vol.	Control		with motor prot. circuit breaker	without motor prot. circuit breaker	Type	Ref. no.	Type	Ref. no.	Type
Two-speed, three-phase current motor, 3~, 400 V, 50 Hz, γ/Δ connection, protection category IP54																	
GBD 630/6/6	05524	8600/9990	720/890	42	0.64/0.93	1.08/1.88	2.03	867	60	60	86	RDS 4	01316	TSD 5.5	01503	MD	05849
GBD 630/4/4	05523	12950/14430	1130/1380	51	2.40/3.45	4.10/6.20	7.20	867	75	50	105	RDS 11	01332	TSD 11.0	01513	MD	05849
T120 Three-phase current motor, 3~, 400 V, 50 Hz, protection category IP54																	
GBD 630/4 T120	05779	14200	1445	53	4.40	8.0	–	499	120	–	105	–	–	–	–	MD	05849

Performance curves GBD 630/6/6

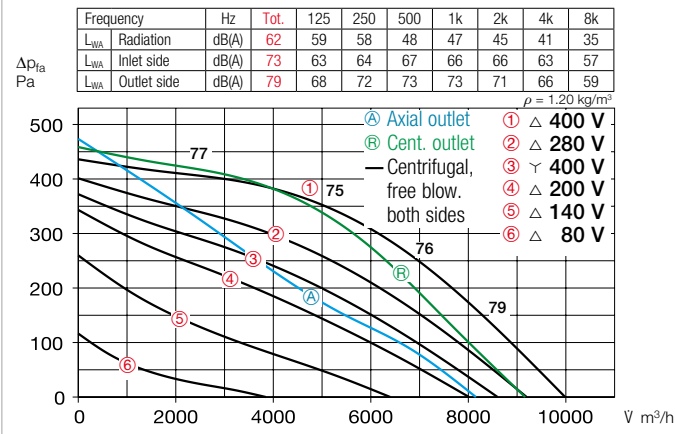

Performance curves GBD 630/4/4

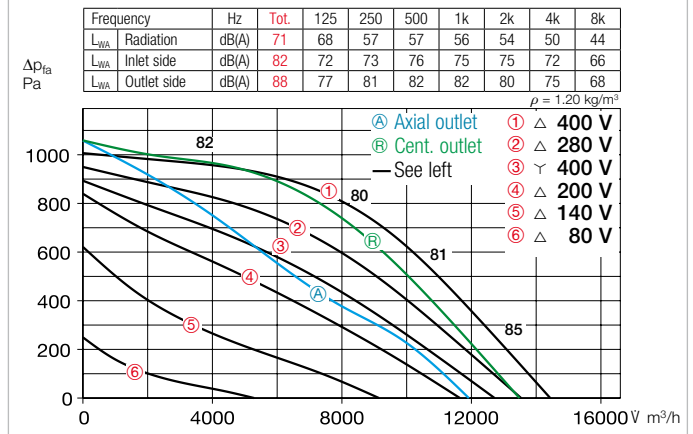

Performance curves GBD 630/4 T120

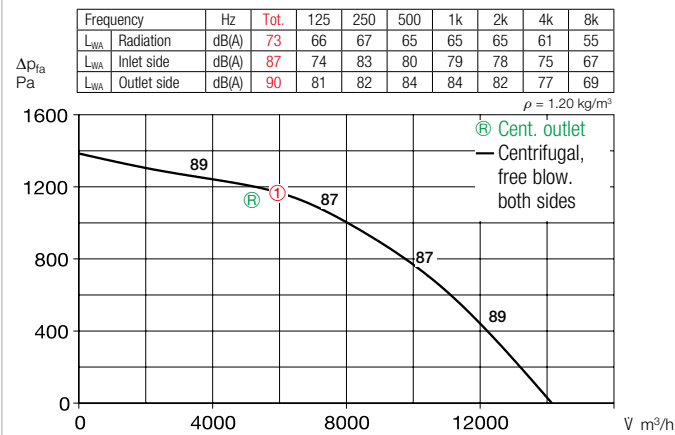

Motor protection

Types GBD with external thermal contacts on the terminal block, which must be wired to the motor protection circuit breaker. Type GBD T120 with PTC thermistors for direct wiring to the motor protection circuit breaker or the frequency converter FU-BS (see type table, accessories).

Power control

All types (except for GBD T120) are speed-controllable using voltage reduction by means of transformer (accessories). The 3~ types can also be operated at two speeds using a ∇/Δ switch or motor protection circuit breaker M4; Type GBD T120 can only be controlled using a frequency converter with sine filter. Performance levels are shown in the performance diagram.

Noise

The total level and range are specified above the performance diagram for:

- Case-radiated sound power
- Inlet side sound power
- Outlet side sound power

The inlet side sound power level is also specified above the nominal performance curve in the performance diagram.

- The case-radiated noise as sound pressure at 4 m (free field conditions) is also specified in the type table.

Accessories for both series

Vibration dampers for indoor installation. 1 set = 4 pcs.

SDD-U Ref. no. 05627

Wall bracket for wall installation.

GB-WK 630 Ref. no. 05626

Weather protection grille for outlet-side coverage.

GB-WSG 630 Ref. no. 05640

Weather protection cover for protected outdoor installation.

GB-WSD 630 Ref. no. 05749

Special accessories

for GB series

Condensate tray with drain connectors (central) for duct/hose connection.

GB-KW 630 Ref. no. 05645

(a condensate tray with condensate drain is included in delivery for GB T120).

Speed switch and on/off switch for two-speed ∇/Δ switchable three-phase current fans.

DS 2¹⁾ Ref. no. 01351

¹⁾ required motor protection circuit breaker: Type MD, No. 05849.

for GB T120 series

Rain drain for outdoor installation (Hole in casing base already provided).

GB-RA Ref. no. 09418

References Page

Planning information	10 ff.
General techn. information, power control	15 ff.

Accessory details Page

Speed controllers and motor prot. circ. breakers	591 ff.
--	---------

GB 710

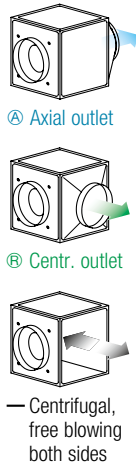

Any installation position and location due to five possible outlet directions.

GB 710 T120

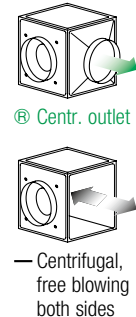

For the delivery of contaminated, humid and hot air up to max. 120 °C. Motor located outside of air flow.



Dimensions GB 710

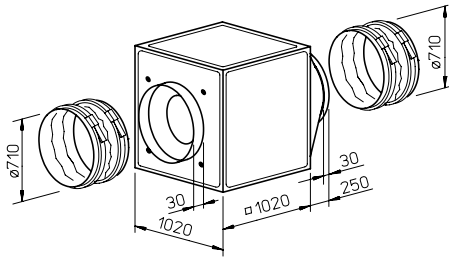

Dimensions GB 710 T120

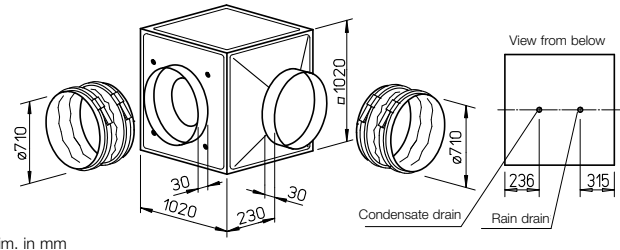

Special features of the GB T120 series T120

- Designed for the delivery of contaminated, humid and hot air up to max. 120 °C.
- Motor located outside of air flow.
- Thermally insulated partition between motor and impeller, made of galvanised steel sheet, with 20 mm thick, non-flammable mineral wool.
- Complete motor-impeller unit can be removed without dismantling the system components.
- Inspection cover with handle, easily removable for cleaning and maintenance.
- Condensate tray with condensate drain as standard. Hole provided for rain drain (accessories) for outdoor installation.

Installation GB T120

Installation position with condensate drain below. Flexible installation due to three possible centrifugal outlet directions of the outlet fitting. Protected outdoor installation possible with weather protection cover and grille (accessories).

Special features of the GB series

Any installation position and flexible installation due to five possible outlet directions of the outlet fitting. The wall bracket (accessories) must be used for wall installation. Protected outdoor installation possible with weather protection cover and grille (accessories).

Description for both series

- Casing**
Self-supporting frame construction made of aluminium hollow profiles. Double-walled, 20 mm thick side panels made of galvanised steel sheet, sound and heat insulated by non-flammable mineral wool lining. Nozzle on inlet side for optimal inflow as well as connectors and flexible connecting sleeve (for the respective max. permissible air flow temperature) for duct connection. Moulded part (square to round) on outlet side for low-loss outflow and flexible connecting sleeve to prevent structure-borne noise transmission. Simple positioning with standard crane hook.

Impeller

Free-running high performance centrifugal impeller made of aluminium with backward curved blades, directly driven. Energy-efficient with low noise emission. Dynamically balanced together with the motor in accordance with DIN ISO 21940-11 – quality grade 2.5.

Drive

Through maintenance-free, speed-controllable external rotor motor or IEC standard motor in protection category IP54. Ball bearing mounted, radio interference-free.

Electrical connection

Standard terminal box (IP54/55) on motor; on the motor support plate for GB T120.

Type	Max. flow rate	Rated speed	Case-rad. sound pressure	Power consumption	Current consumption at rated voltage	Current consumption in control mode	Wiring diagram	Max. air flow temperature at		Weight net aprx.	Speed controller 5-step				Mot. prot. circ. break. for connecting built-in thermal contacts		
								Rat. vol.	Control		kg	Type	Ref. no.	Type	Ref. no.	Type	Ref. no.
Three-phase current motor, 3~, 400 V, 50 Hz, protection category IP55																	
GBD 710/4	05529	20285	1465	51	10.20	–	499	75	–	170	–	–	–	–	–	MD	05849
Two-speed, three-phase current motor, 3~, 400 V, 50 Hz, Y/Δ connection, protection category IP54																	
GBD 710/6/6	05525	16500/19000	690/890	46	1.55/2.45	2.90/4.70	4.70	867	50	50	157	RDS 7	01578	TSD 7.0	01504	MD	05849
T120 Three-phase current motor, 3~, 400 V, 50 Hz, protection category IP54																	
GBD 710/4 T120	05756	18200	1465	55	5.89	10.4	–	499	120	–	188	–	–	–	–	MD	05849

Performance curves GBD 710/4

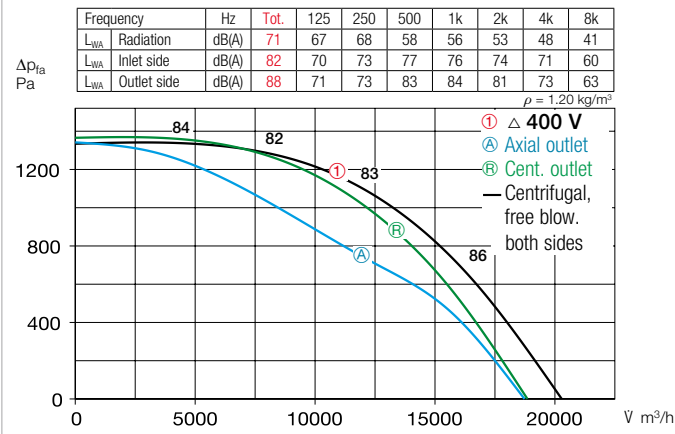

Performance curves GBD 710/4 T120

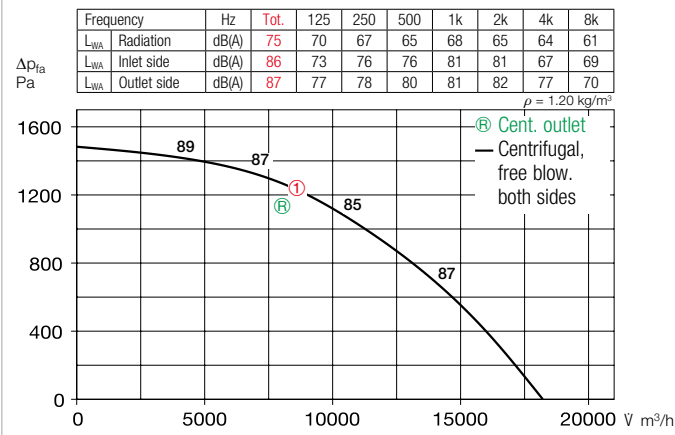

Performance curves GBD 710/6/6

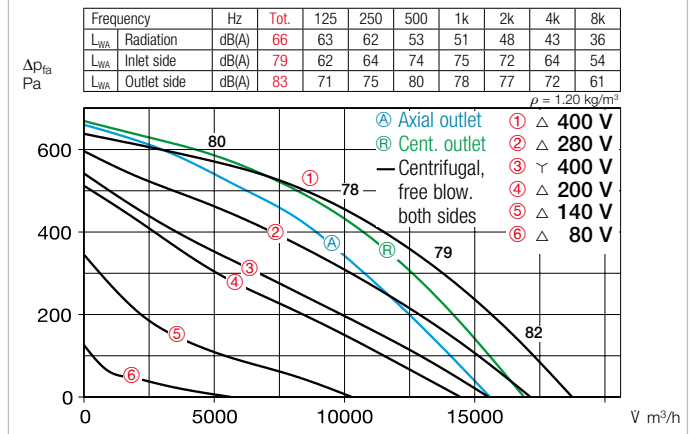

Motor protection

Types GBD with external thermal contacts on the terminal block, which must be wired to the motor protection circuit breaker. Type GBD T120 with PTC thermistors for direct wiring to the motor protection circuit breaker or the frequency converter FU-BS (see type table, accessories).

Power control

All types (except for GBD T120) are speed-controllable using voltage reduction by means of transformer (accessories). GBD 710/6/6 can also be operated at two speeds using a √/Δ switch or motor protection circuit breaker M4; Type GBD T120 can only be controlled using a frequency converter with sine filter. Performance levels are shown in the performance diagram.

Noise

The total level and range are specified above the performance diagram for:

- Case-radiated sound power
- Inlet side sound power
- Outlet side sound power

The inlet side sound power level is also specified above the nominal performance curve in the performance diagram.

- The case-radiated noise as sound pressure at 4 m (free field conditions) is also specified in the type table.

Special accessories

- for GB series

Condensate tray with drain connectors (central) for duct/hose connection.
GB-KW 710 Ref. no. 05646
(a condensate tray with condensate drain is included in delivery for GB T120).

Speed switch and on/off switch for two-speed √/Δ switchable three-phase current fans.

DS 2¹⁾ Ref. no. 01351

¹⁾ required motor protection circuit breaker: Type MD, No. 05849.

- for GBD 710/6/6

Vibration dampers for indoor installation. 1 set = 4 pcs.

SDD-U Ref. no. 05627

- for GB T120 series

Rain drain for outdoor installation (Hole in casing base already provided).

GB-RA Ref. no. 09418

Accessories for both series

Weather protection grille for outlet-side coverage.

GB-WSG 710 Ref. no. 05641

Weather protection cover for protected outdoor installation.

GB-WSD 710 Ref. no. 05750

References Page

Planning information	10 ff.
General techn. information, power control	15 ff.

Accessory details Page

Speed controllers and motor prot. circ. breakers	591 ff.
--	---------

■ **Application**

Noise-encapsulated centrifugal fan with retractable motor-impeller unit and motor located outside of the air flow. Suitable for harsh operating conditions and the transportation of contaminated, greasy, hot (up to +100 °C, types MBD EC up to +120 °C) and humid air against high resistances. Ideal as extract air fan for extraction hood in commercial kitchens.

□ **MB EC**

MegaBox types with EC drive technology are optionally available for energy-saving applications and the lowest operating costs.

■ **Casing**

□ **MB 315 – 400 and MB Ex**

Double-walled, made of galvanised steel sheet. Sound insulated by lining with 50 mm thick mineral wool insulation boards. Duct connectors on inlet side and outlet side, with rubber lip seal, adapted to standard diameter. Motor-impeller unit fully retractable for inspection and cleaning, suspended on stable hinges. Includes mounting rails made of galvanised steel with screwed-on vibration dampers for easy installation.

□ **MB 225 – 280 and MB EC**

Like MB 315 – 400, but lined with 30 mm thick mineral wool insulation boards. Comes with condensate drain and drip protection with the doors open as standard.

■ **Impeller**

High performance centrifugal impeller with good level of efficiency. All types are backward curved and made of aluminium, MB EC 225 to 250 made of galvanised steel sheet. MB Ex series types are forward curved and made of galvanised steel. Dynamically balanced in accordance with DIN ISO 21940-11 – quality grade 6.3.

■ **Drive**

□ **MB**

Maintenance-free squirrel-cage rotor motor in IEC dimensions pursuant to DIN EN 60034/VDE 0530 and DIN EN 60335-1/VDE 0700-1 as well as other relevant standards. With flange mounting and self-ventilation. Thermal overload protection through thermal contacts in the winding. Suitable for continuous operation S1. Insulation class F. Closed casing in protection category IP55.

□ **MB EC**

Energy-saving, speed-controllable EC external rotor motor in protection category IP55 with the highest level of efficiency, located outside of the air flow. Maintenance-free and radio interference-free, ball bearing mounted.

■ **Power control**

□ **MB**

All types (except for explosion-proof types) are speed-controllable using voltage reduction by means of transformer controllers. The three-phase current types can also be operated at two speeds by star/delta connection or motor protection circuit breaker. The power level can then be set according to requirements and optimally to the desired operating point. One or more fans can be operated until the max. rated current is reached with the offered speed controllers. 10% power reserves must be provided when dimensioning the speed controller.

□ **MB EC**

All EC types have continuously variable control using via speed potentiometer. Control is also possible via three level switch or continuously variable via universal control system or electronic differential pressure/temperature controller. Performance levels are shown on the performance curve as examples.

■ **Electrical connection**

Standard terminal box mounted to external cable, protection category IP55. The swivelling range of the motor-impeller unit must be considered when cutting the connecting cable to length. For MBD 315/2/2, 355/2/2 and 400/2/2, terminal box on outside of motor.

■ **Motor protection**

□ **MB**

With external thermal contacts on the terminal block, which must be wired to the motor protection circuit breaker.

□ **MB EC**

Integrated electronic temperature monitoring system for EC motor and electronics. If the maximum permissible motor temperature is exceeded, 3~ types will automatically reduce the speed which then returns back to the originally set value after cooling down. The motors in 1~ types will be deactivated if the maximum permissible temperature is exceeded.

■ **Explosion protection**

The explosion-proof types correspond to unit group II, category 2G for operation in zone 1 and 2 in accordance with Directive 2014/34/EU (ATEX).

■ **Air flow direction**

The air flow direction cannot be changed for centrifugal fans. The correct motor rotation direction is marked by arrows on the fan and must be checked during commissioning.

■ **Incorrect direction of rotation**

Operation in the incorrect direction of rotation overloads the AC motor and causes the thermal contacts to respond. Typical concomitant features include: Low flow rate, vibration and abnormal noise.

■ **Air flow temperature**

The maximum permissible air flow temperature is shown in the type table.

■ **Ambient temperature**

From –40 °C to +40 °C.

■ **Installation position, installation**

The swivelling range and weight of the motor-impeller unit and free accessibility must be taken into account for positioning.

■ **Structure-borne noise transmission**

to buildings and duct systems must be prevented. The fan must not be rigidly connected to the pipeline; flexible connecting sleeves (type FM, accessories) must be used.

References	Page
Planning information, acoustics	10 ff.
General techn. information, power control	14 ff.

Other accessories	Page
Flexible connecting sleeve, speed controller and protection circuit breakers	270
Universal control system, electronic controllers, speed potentiometer for MB EC types	591 ff. 605 ff.

By combining the parameters of static pressure increase ΔP_{fa} , case-radiated noise and inlet side air noise as sound pressure at

1 m (free field conditions), the following table facilitates the selection of MegaBox centrifugal fans.

	Sound pres. Radiation	Sound pres. inlet side	Flow rate \dot{V} m ³ /h depending on static pressure												
	L_{pA} dB(A)	L_{pA} dB(A)	(ΔP_{fa}) in Pa												
	at 4 m dist.	at 4 m dist.	0	50	100	200	300	400	500	600	700	800	1000	1500	2000
MBW EC 225	55	66	1350	1238	1250	1123	1000	878	764	500					
MBW EC 250	56	73	1900	1815	1730	1560	1420	1270	1125	985	800				
MBW EC 280	56	71	2620	2550	2475	2320	2150	1945	1680	1380	1000	545			
MBD EC 280	58	75	3000	2940	2860	2740	2625	2440	2300	2140	1945	1625	900		
MBW EC 315	50	62	2150	2035	1915	1620	1000								
MBW EC 315 A	59	73	3400	3320	3235	3080	2920	2740	2550	2270	1900	1380			
MBW EC 315 B	65	81	4200	4140	4065	3920	3800	3670	3530	3380	3220	3090	2700		
MBW EC 355	54	69	3050	2920	2790	2470	2080	1350							
MBW EC 355 A	66	78	5000	4890	4830	4680	4550	4380	4240	4045	4100	3530	2914		
MBW EC 355 B	68	82	5600	5520	5450	5255	5130	4940	4770	4640	4470	4300	3850	2210	
MBD EC 400 A	68	80	5000	4890	4760	4565	4370	4130	3870	3520	3050	2200			
MBD EC 400 B	72	85	6550	6475	6400	6300	6160	6000	5800	5550	5350	5100	4550	2525	

	Sound pres. Radiation	Sound pres. inlet side	Flow rate \dot{V} m ³ /h depending on static pressure												
	L_{pA} dB(A)	L_{pA} dB(A)	(ΔP_{fa}) in Pa												
	at 4 m dist.	at 4 m dist.	0	50	100	200	300	400	500	600	700	800	1000	1500	2000
MBW 225/2	52	64	1170	1130	1090	1010	920	800	640	370					
MBD 225/2/2	52	65	1170	1130	1090	1000	900	790	650	310					
MBW 250/2	55	68	1620	1580	1530	1430	1320	1200	1040	850	510				
MBD 250/2/2	56	68	1590	1550	1510	1430	1330	1210	1050	860	250				
MBD 280/2/2	60	75	2520	2470	2420	2320	2190	2040	1880	1710	1510	1250			
MBW 315/4	41	61	1950	1820	1640	1270	820								
MBD 315/4/4	41	61	1990	1860	1720	1310	910								
MBD 315/2/2	64	80	3980	3910	3820	3660	3450	3500	3050	2750	2630	2440	2090	800	
MBW 355/4	43	60	2810	2660	2520	2070	1630	1140							
MBD 355/4/4	42	60	2850	2660	2440	2070	1650	1200							
MBD 355/2/2	68	84	5800	5770	5680	5480	5280	5030	4800	4570	4390	4160	3700	2700	
MBW 400/4	48	70	3550	3360	3170	2800	2470	2090	1640	750					
MBD 400/4/4	50	69	3440	3290	3140	2800	2460	2100	1630	720					
MBD 400/2/2	74	90	7500	7380	7270	7070	6830	6660	6480	6310	6130	5990	5610	4730	3500

	Sound pres. Radiation	Sound pres. inlet side	Flow rate \dot{V} m ³ /h depending on static pressure												
	L_{pA} dB(A)	L_{pA} dB(A)	(ΔP_{fa}) in Pa												
	at 4 m dist.	at 4 m dist.	0	50	100	200	300	400	500	600	700	800	1000	1500	2000
MBD 160/4 Ex	48	64	960	850	730										
MBD 160/2 Ex	63	79	2020	1970	1920	1820	1700	1570	1420	1270	1110				
MBD 180/4 Ex	51	67	1390	1290	1180	860									
MBD 200/4 Ex	54	70	*	*	1840	1530	1080								
MBD 225/4 Ex	56	74	*	2720	2570	2250	1840	940							
MBD 250/4 Ex	62	78	4130	3990	3840	3520	3150	2670	1950						
MBD 280/6 Ex	56	72	*	*	3240	2740									
MBD 280/4 Ex	65	81	*	*	*	*	4800	4410	3900	3150					

* Consider required minimum system resistance.

MB EC 225



Performance curves MBW EC 225

Frequency	Hz	Tot.	125	250	500	1k	2k	4k	8k	
L _{WA} Radiation		dB(A)	63	47	50	52	58	57	51	41
L _{WA} Inlet side		dB(A)	74	52	65	70	68	65	64	62
L _{WA} Outlet side		dB(A)	77	53	64	73	67	70	66	61

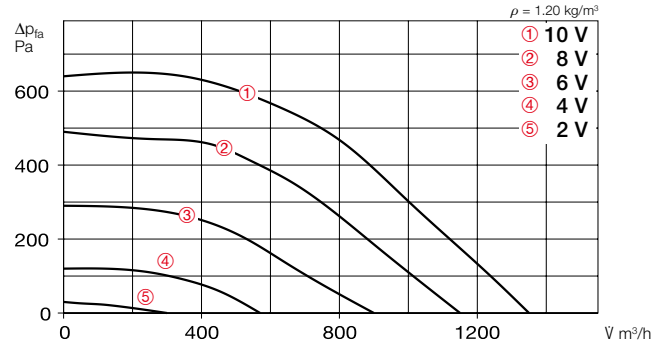

Free blowing						
Voltage V	n min ⁻¹	V m³/h	P W	I A	Lp dB(A)	SFP kW/m³/s
10	3000	1350	230	1.00	55	0.61
8	2600	1150	150	0.68	52	0.47
6	2000	900	90	0.42	47	0.34
4	1300	570	50	0.27	38	0.25

Dimensions MB EC 225

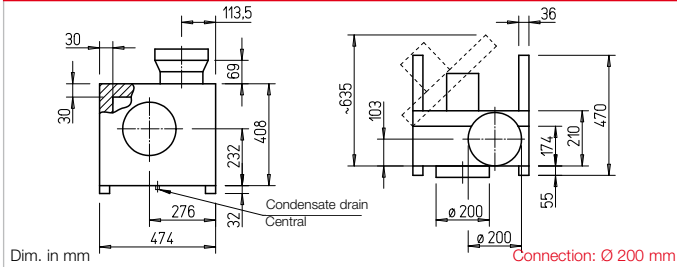

■ Casing

Double-walled, made of galvanised steel sheet. Sound insulated by lining with 30 mm thick mineral wool insulation boards. Duct connectors on inlet side and outlet side, with rubber lip seal, adapted to standard diameter. Motor-impeller unit fully retractable for inspection and cleaning, suspended on stable hinges. Comes with condensate drain and drip protection with the doors open as standard. Includes mounting rails made of galvanised steel with screwed-on vibration dampers for easy installation.

■ Impeller

Backward curved, free-running high performance centrifugal impeller made of galvanised steel, mounted directly on motor shaft. High efficiency, low noise. Dynamically balanced in accordance with DIN ISO 21940-11 – quality grade 6.3.

■ Drive

Energy-saving, speed-controllable EC internal rotor motor in protection category IP55 with the highest level of efficiency, located outside of the air flow. Maintenance-free and radio interference-free, ball bearing mounted.

■ Electrical connection

Standard terminal box (IP55) mounted to external cable.

■ Motor protection

Integrated electronic temperature monitoring system for EC motor and electronics. The motor is deactivated if the maximum permissible temperature is exceeded.

■ Power control

Continuously variable speed control with potentiometer or continuously variable speed control with universal control system (see table). Performance levels are shown in the performance curve as an example.

■ Noise

The total level and range are specified above the performance diagram for:
 Case-radiated sound power
 Inlet side sound power
 Outlet side sound power
 The case-radiated noise as sound pressure at 1 m (free field conditions) is also specified in the type table and the table below the performance curve.

■ Accessories

Wall bracket made of galv. steel sheet.

MB-WK EC225 Ref. no. 05526

Weather protection cover made of galv. steel sheet, mounted above motor.

MB-WSD EC225 No. 01856

Flexible connecting sleeve for installation between fan and duct.

Max. temperature +70 °C

FM 200 Ref. no. 01670

Max. temperature +120 °C

FM 200 T120 Ref. no. 01654

■ Accessory details Page

Accessory details	Page
Universal control system, electronic controller, speed potentiometer	605 ff.

Type	Ref. no.	Connection Ø	Flow rate free blowing	Rated speed	Case-rad. sound pressure	Power consumption	Current consumption	Wiring diagram	Max. air flow temp.	Weight net aprx.	Universal control system		Speed potentiometer			
											Type	Ref. no.	Type	Ref. no.		
Alternating current, 1~, 230 V, 50/60 Hz, EC motor, protection category IP55																
MBW EC 225	05842	200	1350	3000	55	0.27	1.20	985	100	25	EUR EC ¹⁾²⁾	01347	PU 10 ¹⁾	01734	PA 10 ¹⁾	01735

1) Multiple EC fans can normally be connected. 2) Alternative electronic diff. pressure/temperature controller (EDR/ETR, No. 01437/01438) or three level speed switch (SU/SA, No. 04266/04267).

MB EC 250



Dimensions MB EC 250

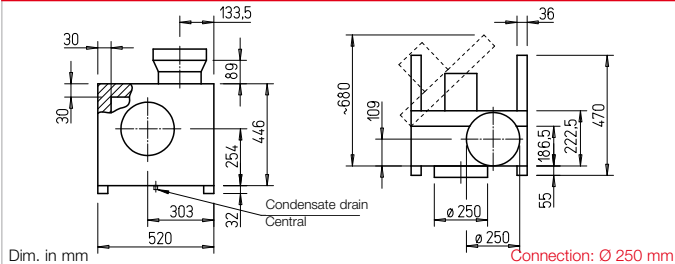

Performance curves MBW EC 250

Frequency	Hz	Tot.	125	250	500	1k	2k	4k	8k	
L _{wa} Radiation		dB(A)	64	43	52	60	56	57	52	46
L _{wa} Inlet side		dB(A)	81	62	72	77	75	72	71	66
L _{wa} Outlet side		dB(A)	83	62	71	79	75	76	71	65

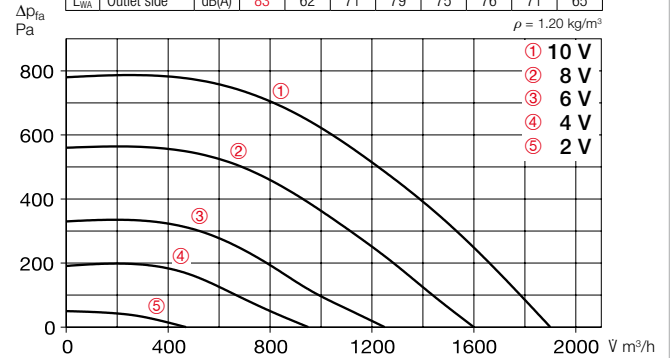

Free blowing						
Voltage V	n min ⁻¹	V m ³ /h	P W	I A	Lp dB(A)	SFP kW/m ² /s
10	3000	1900	310	1.3	56	0.59
8	2600	1600	200	0.90	51	0.45
6	2000	1250	110	0.51	47	0.32
4	1300	950	70	0.4	42	0.25

■ Casing

Double-walled, made of galvanised steel sheet. Sound insulated by lining with 30 mm thick mineral wool insulation boards. Duct connectors on inlet side and outlet side, with rubber lip seal, adapted to standard diameter. Motor-impeller unit fully retractable for inspection and cleaning, suspended on stable hinges. Comes with condensate drain and drip protection with the doors open as standard. Includes mounting rails made of galvanised steel with screwed-on vibration dampers for easy installation.

■ Impeller

Backward curved, free-running high performance centrifugal impeller made of galvanised steel, mounted directly on motor shaft. High efficiency, low noise. Dynamically balanced in accordance with DIN ISO 21940-11 – quality grade 6.3.

■ Drive

Energy-saving, speed-controllable EC internal rotor motor in protection category IP55 with the highest level of efficiency, located outside of the air flow. Maintenance-free and radio interference-free, ball bearing mounted.

■ Electrical connection

Standard terminal box (IP55) mounted to external cable.

■ Motor protection

Integrated electronic temperature monitoring system for EC motor and electronics. The motor is deactivated if the maximum permissible temperature is exceeded.

■ Power control

Continuously variable speed control with potentiometer or continuously variable speed control with universal control system (see table). Performance levels are shown in the performance curve as an example.

■ Noise

The total level and range are specified above the performance diagram for:
 Case-radiated sound power
 Inlet side sound power
 Outlet side sound power
 The case-radiated noise as sound pressure at 1 m (free field conditions) is also specified in the type table and the table below the performance curve.

■ Accessories

- Wall bracket** made of galv. steel sheet.
MB-WK EC250 Ref. no. 05526
- Weather protection cover** made of galv. steel sheet, mounted above motor.
MB-WSD EC250 Ref. no. 01856
- Flexible connecting sleeve** for installation between fan and duct
 Max. temperature +70 °C
FM 250 Ref. no. 01672
 Max. temperature +120 °C
FM 250 T120 Ref. no. 01655

Accessory details	Page
Universal control system, electronic controller, speed potentiometer	605 ff.

Type	Ref. no.	Connection Ø	Flow rate free blowing	Rated speed	Case-rad. sound pressure	Power consumption	Current consumption	Wiring diagram	Max. air flow temp.	Weight net aprx.	Universal control system		Speed potentiometer		
											Type	Ref. no.	Type	Ref. no.	
		mm	V m ³ /h	min ⁻¹	dB(A) at 1 m	kW	A	No.	+ °C	kg	Type	Ref. no.	Type	Ref. no.	
Alternating current, 1~, 230 V, 50/60 Hz, EC motor, protection category IP55															
MBW EC 250	05843	250	1900	3000	56	0.38	1.70	985	100	28.0	EUR EC ¹⁾²⁾ 01347	PU 10 ¹⁾ 01734	PA 10 ¹⁾ 01735		

1) Multiple EC fans can normally be connected. 2) Alternative electronic diff. pressure/temperature controller (EDR/ETR, No. 01437/01438) or three level speed switch (SU/SA, No. 04266/04267).

MB EC 280



Dimensions MB EC 280

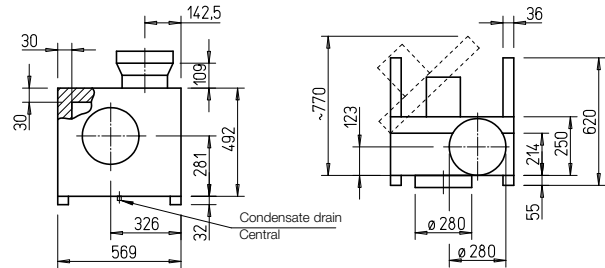

Dim. in mm

Connection: Ø 280 mm

■ **Casing**

Double-walled, made of galvanised steel sheet. Sound insulated by lining with 30 mm thick mineral wool insulation boards. Duct connectors on inlet side and outlet side, with rubber lip seal, adapted to standard diameter. Motor-impeller unit fully retractable for inspection and cleaning, suspended on stable hinges. Comes with condensate drain and drip protection with the doors open as standard. Includes mounting rails made of galvanised steel with screwed-on vibration dampers for easy installation.

■ **Impeller**

Backward curved, free-running high performance centrifugal impeller made of galvanised steel, mounted directly on motor shaft. High efficiency, low noise. Dynamically balanced in accordance with DIN ISO 21940-11 – quality grade 6.3.

■ **Drive**

Energy-saving, speed-controllable EC internal rotor motor in protection category IP55 with the highest level of efficiency, located outside of the air flow. Maintenance-free and radio interference-free, ball bearing mounted.

■ **Electrical connection**

Standard terminal box (IP55) on outside of motor, mounted to external cable for 1~ type.

■ **Motor protection**

Integrated electronic temperature monitoring system for EC motor and electronics. If the maximum permissible motor temperature is exceeded, 3~ types will automatically reduce the speed which then returns back to the originally set value after cooling down. The motors in 1~ types will be deactivated if the maximum permissible temperature is exceeded.

■ **Power control**

Continuously variable speed control with potentiometer or continuously variable speed control with universal control system (see table). Performance levels are shown in the performance curve as an example.

■ **Noise**

The total level and range are specified above the performance diagram for:

- Case-radiated sound power
- Inlet side sound power
- Outlet side sound power

The case-radiated noise as sound pressure at 1 m (free field conditions) is also specified in the type table and the table below the performance curve.

Type	Ref. no.	Connection Ø	Flow rate free blowing	Rated speed	Case-rad. sound pressure	Power consumption	Current consumption	Wiring diagram	Max. air flow temp.	Weight net appr.	Universal control system		Speed potentiometer			
											Type	Ref. no.	flush-mounted	surf.-mounted	Type	Ref. no.
mm																
			V m³/h	min⁻¹	dB(A) at 1 m	kW	A	No.	+ °C	kg	Type	Ref. no.	Type	Ref. no.	Type	Ref. no.
Alternating current, 1~, 230 V, 50/60 Hz, EC motor, protection category IP55																
MBW EC 280	05850	280	2630	2450	56	0.48	2.10	985	100	33.0	EUR EC ¹⁾²⁾ 01347	PU 10 ¹⁾	01734	PA 10 ¹⁾	01735	
Three-phase current, 3~, 400 V, 50/60 Hz, EC motor, protection category IP55																
MBD EC 280	05845	280	3000	3000	58	0.75	1.40	988	120	34.0	EUR EC ¹⁾²⁾ 01347	PU 10 ¹⁾	01734	PA 10 ¹⁾	01735	

1) Multiple EC fans can normally be connected. 2) Alternative electronic diff. pressure/temperature controller (EDR/ETR, No. 01437/01438) or three level speed switch (SU/SA, No. 04266/04267).

Performance curves MBW EC 280

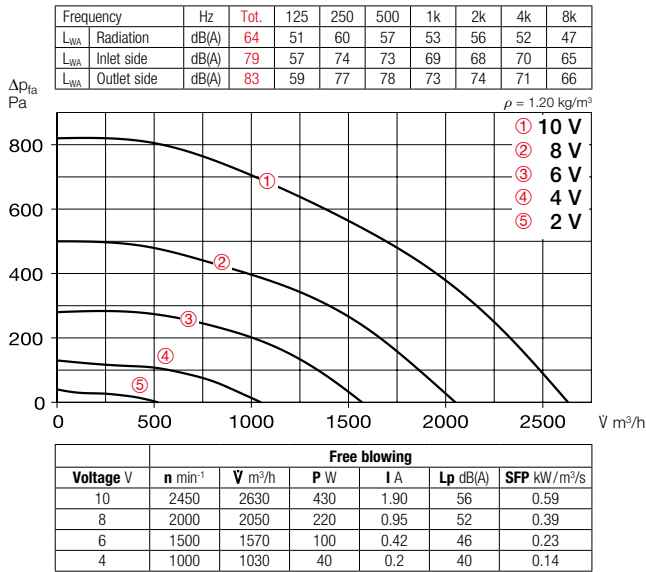

Performance curves MBD EC 280

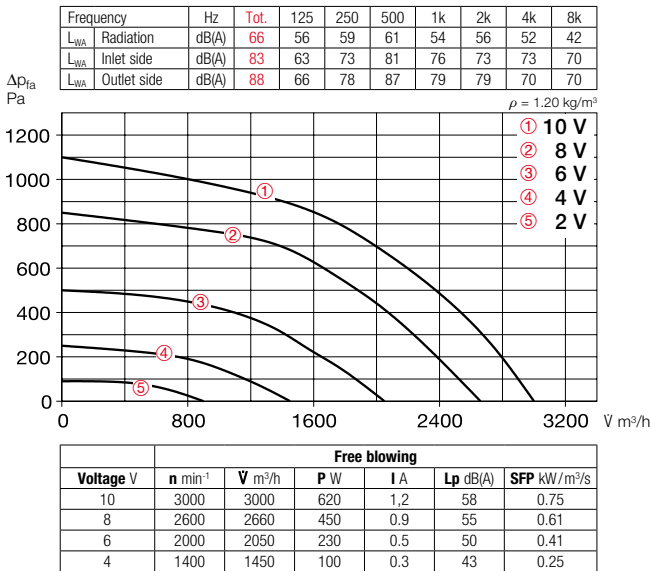

Accessories

Wall bracket

Bracket for wall installation, made of galvanised steel sheet.

MB-WK EC280 Ref. no. 05527



Weather protection cover

For protected outdoor coverage. Made of galvanised steel sheet, mounted above motor.

MB-WSD EC280 No. 01856



Flexible connecting sleeve

Includes 2 hose clamps; for installation between fan and duct system. Prevents structure-borne noise transmission and bridges installation tolerances.

- Max. temperature +70 °C

FM 280 Ref. no. 01673

- Max. temperature +120 °C

FM 280 T120 Ref. no. 01656



Universal control system

For continuously variable control or regulation of single phase and three-phase EC fans with a setpoint input of 0-10 V DC.

EUR EC Ref. no. 01347



Speed potentiometer

For direct control/setpoint setting for EC fans with potentiometer input.

PU 10 Ref. no. 01734

For flush-mounting.

PA 10 Ref. no. 01735

For surface-mounting.



Accessory details Page

Universal control system, electronic controller, speed potentiometer 605 ff.

MB EC 315



Dimensions MB EC 315

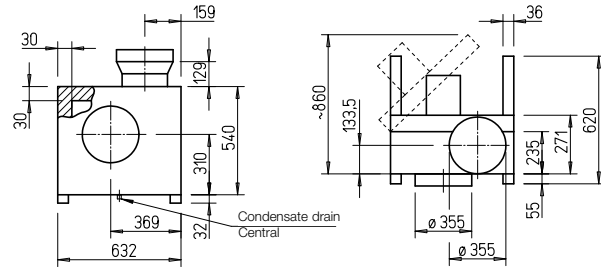

Dim. in mm

Connection: Ø 355 mm

■ Casing

Double-walled, made of galvanised steel sheet. Sound insulated by lining with 30 mm thick mineral wool insulation boards. Duct connectors on inlet side and outlet side, with rubber lip seal, adapted to standard diameter. Motor-impeller unit fully retractable for inspection and cleaning, suspended on stable hinges. Comes with condensate drain and drip protection with the doors open as standard. Includes mounting rails made of galvanised steel with screwed-on vibration dampers for easy installation.

■ Impeller

Backward curved, free-running high performance centrifugal impeller made of galvanised steel, mounted directly on motor shaft. High efficiency, low noise. Dynamically balanced in accordance with DIN ISO 21940-11 – quality grade 6.3.

■ Drive

Energy-saving, speed-controllable EC internal rotor motor in protection category IP55 with the highest level of efficiency, located outside of the air flow. Maintenance-free and radio interference-free, ball bearing mounted.

■ Electrical connection

Standard terminal box (IP55) on outside of motor, mounted to external cable for 1~ type.

■ Motor protection

Integrated electronic temperature monitoring system for EC motor and electronics. If the maximum permissible motor temperature is exceeded, 3~ types will automatically reduce the speed which then returns back to the originally set value after cooling down. The motors in 1~ types will be deactivated if the maximum permissible temperature is exceeded.

■ Power control

Continuously variable speed control with potentiometer or continuously variable speed control with universal control system (see table). Performance levels are shown in the performance curve as an example.

■ Noise

The total level and range are specified above the performance diagram for:

- Case-radiated sound power
- Inlet side sound power
- Outlet side sound power

The case-radiated noise as sound pressure at 1 m (free field conditions) is also specified in the type table and the table below the performance curve.

Type	Ref. no.	Connection Ø	Flow rate free blowing	Rated speed	Case-rad. sound pressure	Power consumption	Current consumption	Wiring diagram	Max. air flow temp.	Weight net aprx.	Universal control system		Speed potentiometer			
											Type	Ref. no.	flush-mounted	surf.-mounted	Type	Ref. no.
		mm	m ³ /h	min ⁻¹	dB(A) at 1 m	kW	A	No.	+ °C	kg	Type	Ref. no.	Type	Ref. no.	Type	Ref. no.
Alternating current, 1~, 230 V, 50/60 Hz, EC motor, protection category IP55																
MBW EC 315	05852	355	2150	1500	50	0.20	0.85	985	100	43.0	EUR EC ¹⁾²⁾	01347	PU 10 ¹⁾	01734	PA 10 ¹⁾	01735
Three-phase current, 3~, 400 V, 50/60 Hz, EC motor, protection category IP55																
MBD EC 315 A	05851	355	3400	2400	59	0.72	1.30	988	120	44.0	EUR EC ¹⁾²⁾	01347	PU 10 ¹⁾	01734	PA 10 ¹⁾	01735
MBD EC 315 B	05846	355	4200	3000	65	1.38	2.20	988	120	50.0	EUR EC ¹⁾²⁾	01347	PU 10 ¹⁾	01734	PA 10 ¹⁾	01735

1) Multiple EC fans can normally be connected. 2) Alternative electronic diff. pressure/temperature controller (EDR/ETR, No. 01437/01438) or three level speed switch (SU/SA, No. 04266/04267).04266/04267), see accessories.

Performance curves MBW EC 315

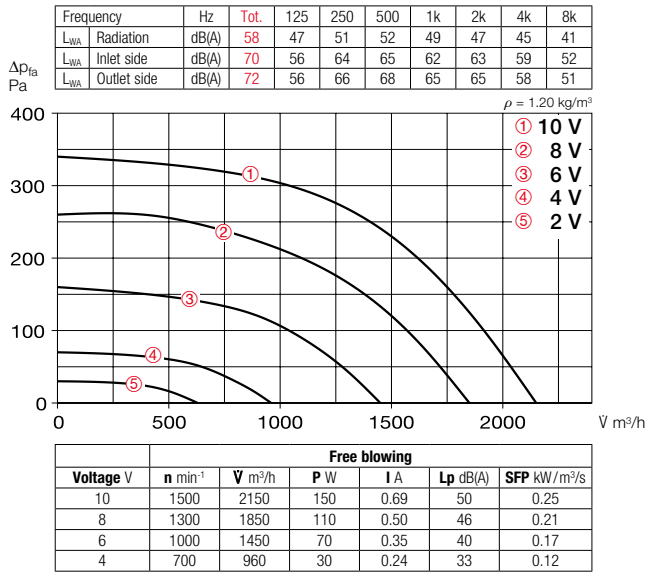

Accessories

Wall bracket

Bracket for wall installation, made of galvanised steel sheet.

MB-WK EC315 Ref. no. 05527



Weather protection cover

For protected outdoor coverage. Made of galvanised steel sheet, mounted above motor.

MB-WSD EC315 No. 01865



Performance curves MBD EC 315 A

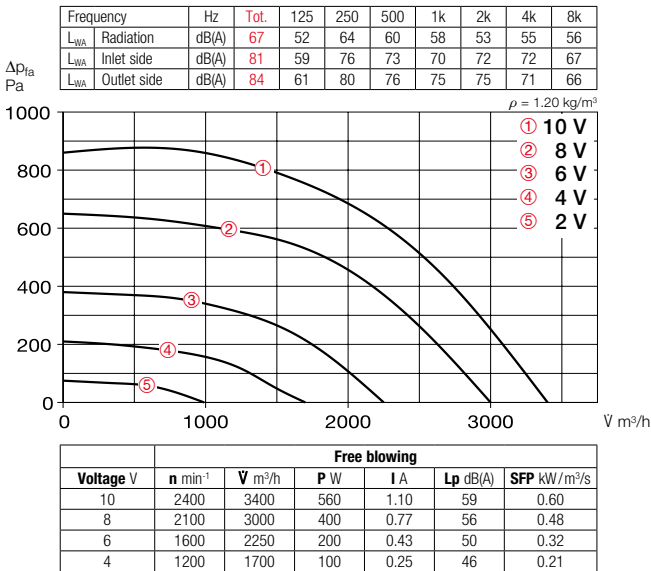

Flexible connecting sleeve

Includes 2 hose clamps; for installation between fan and duct system. Prevents structure-borne noise transmission and bridges installation tolerances.

- Max. temperature +70 °C

FM 355 Ref. no. 01675

- Max. temperature +120 °C

FM 355 T120 Ref. no. 01658



Universal control system

For continuously variable control or regulation of single phase and three-phase EC fans with a setpoint input of 0-10 V DC.

EUR EC Ref. no. 01347



Performance curves MBD EC 315 B

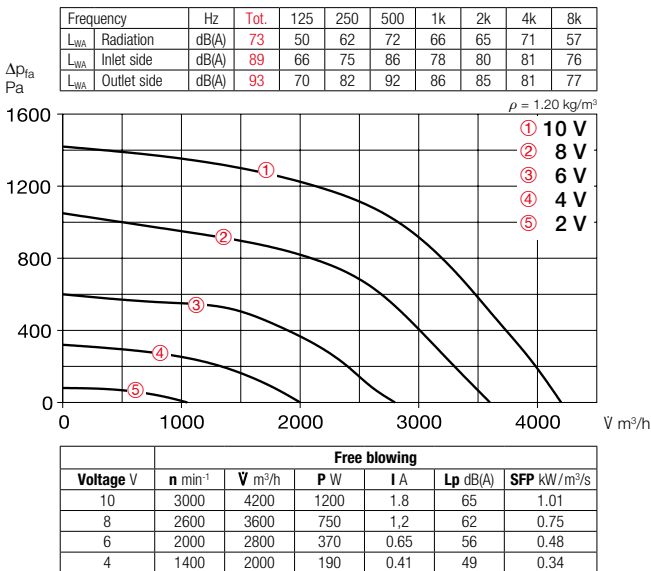

Speed potentiometer

For direct control/setpoint setting for EC fans with potentiometer input.

PU 10 Ref. no. 01734

For flush-mounting.

PA 10 Ref. no. 01735

For surface-mounting.



Accessory details Page

Universal control system, electronic controller, speed potentiometer 605 ff.

MB EC 355



Dimensions MB EC 355

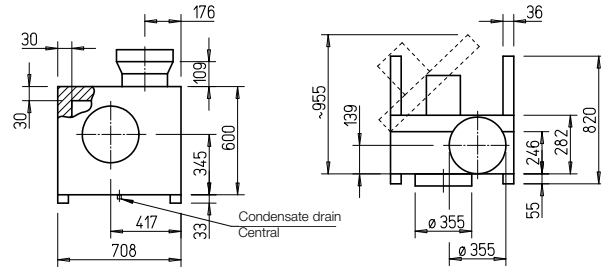

Dim. in mm

Connection: Ø 355 mm

■ Casing

Double-walled, made of galvanised steel sheet. Sound insulated by lining with 30 mm thick mineral wool insulation boards. Duct connectors on inlet side and outlet side, with rubber lip seal, adapted to standard diameter. Motor-impeller unit fully retractable for inspection and cleaning, suspended on stable hinges. Comes with condensate drain and drip protection with the doors open as standard. Includes mounting rails made of galvanised steel with screwed-on vibration dampers for easy installation.

■ Impeller

Backward curved, free-running high performance centrifugal impeller made of galvanised steel, mounted directly on motor shaft. High efficiency, low noise. Dynamically balanced in accordance with DIN ISO 21940-11 – quality grade 6.3.

■ Drive

Energy-saving, speed-controllable EC internal rotor motor in protection category IP55 with the highest level of efficiency, located outside of the air flow. Maintenance-free and radio interference-free, ball bearing mounted.

■ Electrical connection

Standard terminal box (IP55) on outside of motor, mounted to external cable for 1~ type.

■ Motor protection

Integrated electronic temperature monitoring system for EC motor and electronics. If the maximum permissible motor temperature is exceeded, 3~ types will automatically reduce the speed which then returns back to the originally set value after cooling down. The motors in 1~ types will be deactivated if the maximum permissible temperature is exceeded.

■ Power control

Continuously variable speed control with potentiometer or continuously variable speed control with universal control system (see table). Performance levels are shown in the performance curve as an example.

■ Noise

The total level and range are specified above the performance diagram for:

- Case-radiated sound power
- Inlet side sound power
- Outlet side sound power

The case-radiated noise as sound pressure at 1 m (free field conditions) is also specified in the type table and the table below the performance curve.

Type	Ref. no.	Connection Ø	Flow rate free blowing	Rated speed	Case-rad. sound pressure	Power consumption	Current consumption	Wiring diagram	Max. air flow temp.	Weight net aprx.	Universal control system		Speed potentiometer			
											Type	Ref. no.	flush-mounted	surf.-mounted	Type	Ref. no.
		mm	m ³ /h	min ⁻¹	dB(A) at 1 m	kW	A	No.	+ °C	kg	Type	Ref. no.	Type	Ref. no.	Type	Ref. no.
Alternating current, 1~, 230 V, 50/60 Hz, EC motor, protection category IP55																
MBW EC 355	05854	355	3050	1500	54	0.33	1.50	985	100	50.0	EUR EC ¹⁾²⁾	01347	PU 10 ¹⁾	01734	PA 10 ¹⁾	01735
Three-phase current, 3~, 400 V, 50/60 Hz, EC motor, protection category IP55																
MBD EC 355 A	05853	355	5000	2500	66	1.45	2.20	988	120	56.0	EUR EC ¹⁾²⁾	01347	PU 10 ¹⁾	01734	PA 10 ¹⁾	01735
MBD EC 355 B	05847	355	5600	2800	68	1.90	3.10	988	120	63.0	EUR EC ¹⁾²⁾	01347	PU 10 ¹⁾	01734	PA 10 ¹⁾	01735

¹⁾ Multiple EC fans can normally be connected. ²⁾ Alternative electronic diff. pressure/temperature controller (EDR/ETR, No. 01437/01438) or three level speed switch (SU/SA, No. 04266/04267), see Accessories.

Performance curves MBW EC 355

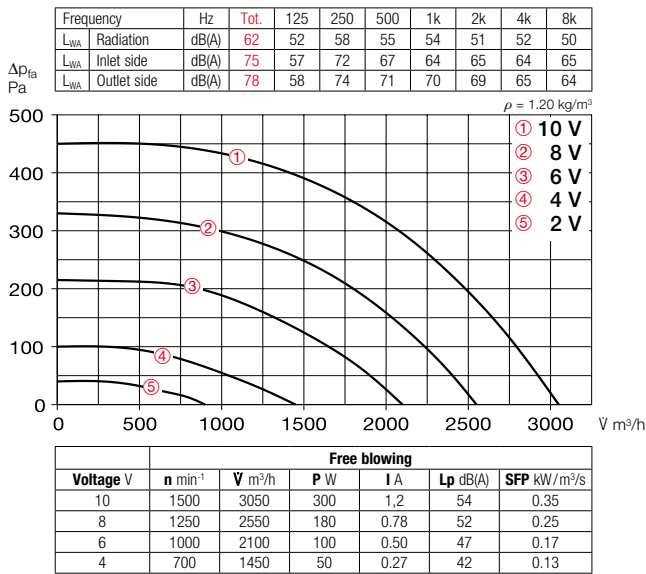

Performance curves MBD EC 355 A

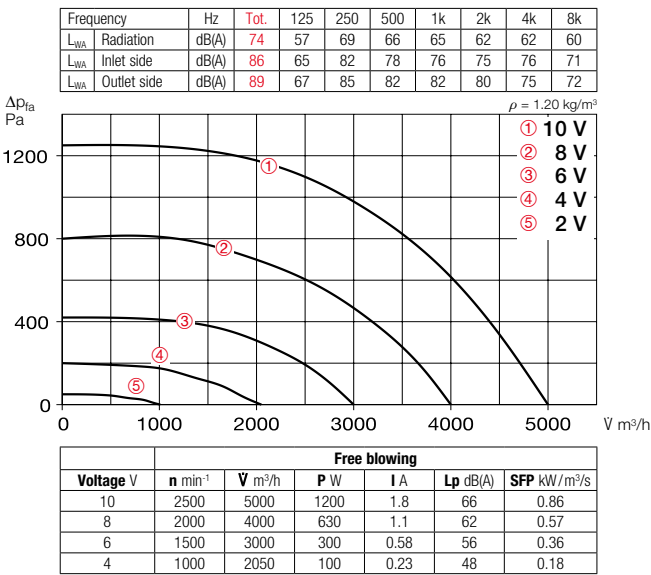

Performance curves MBD EC 355 B

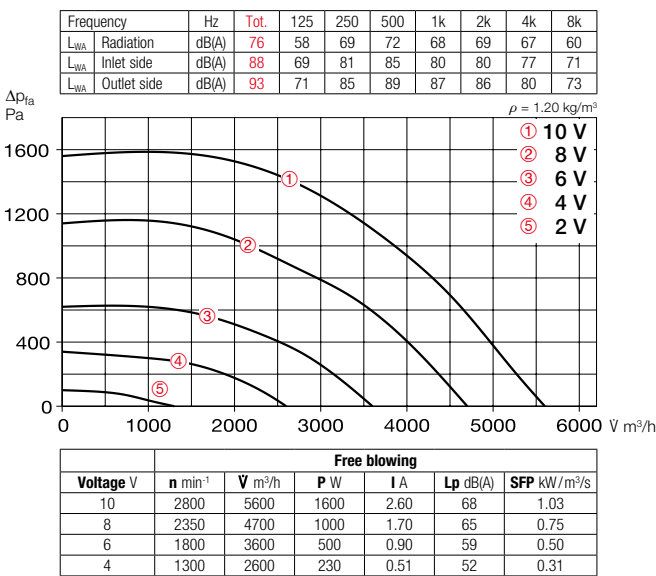

Accessories

Wall bracket

Bracket for wall installation, made of galvanised steel sheet.

MB-WK EC355 Ref. no. 05528



Weather protection cover

For protected outdoor coverage. Made of galvanised steel sheet, mounted above motor.

MB-WSD EC355 No. 01865



Flexible connecting sleeve

Includes 2 hose clamps; for installation between fan and duct system. Prevents structure-borne noise transmission and bridges installation tolerances.

- Max. temperature +70 °C

FM 355 Ref. no. 01675

- Max. temperature +120 °C

FM 355 T120 Ref. no. 01658



Universal control system

For continuously variable control or regulation of single phase and three-phase EC fans with a setpoint input of 0-10 V DC.

EUR EC Ref. no. 01347



Speed potentiometer

For direct control/setpoint setting for EC fans with potentiometer input.

PU 10 Ref. no. 01734

For flush-mounting.

PA 10 Ref. no. 01735

For surface-mounting.



Accessory details Page

Universal control system, electronic controller, speed potentiometer 605 ff.

MB EC 400



Dimensions MB EC 400

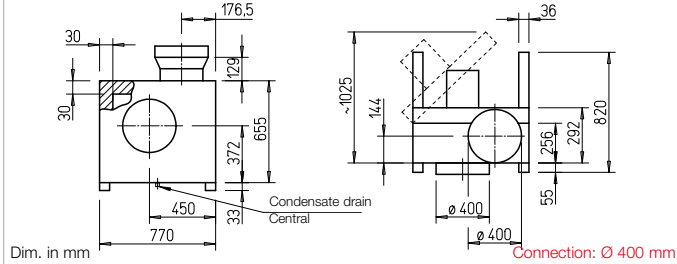

Casing

See description on page 312 for casing, impeller, drive and noise.

Electrical connection

Standard terminal box (IP55) on outside of motor.

Motor protection

Integrated electronic temperature monitoring system for EC motor and electronics. If the maximum permissible motor temperature is exceeded, the speed will be automatically reduced and then returned back to the originally set value after cooling down.

Power control

Continuously variable speed control with potentiometer or continuously variable speed control with universal control system (see table). Performance levels are shown in the performance curve as an example.

Accessories

Wall bracket

Made of galvanised steel sheet.
MB-WK EC400 Ref. no. 05528

Weather protection cover

Made of galvanised steel sheet, mounted above motor.
MB-WSD EC400 No. 01865

Flexible connecting sleeve

For installation between fan and duct.
 – Max. temperature +70 °C
FM 400 Ref. no. 01676
 – Max. temperature +120 °C
FM 400 T120 Ref. no. 01659

Performance curves MBD EC 400 A

Frequency	Hz	Tot.	125	250	500	1k	2k	4k	8k
L _{WA} Radiation		dB(A)	76	55	69	70	71	68	60
L _{WA} Inlet side		dB(A)	88	65	81	82	79	80	73
L _{WA} Outlet side		dB(A)	90	70	89	85	84	83	73

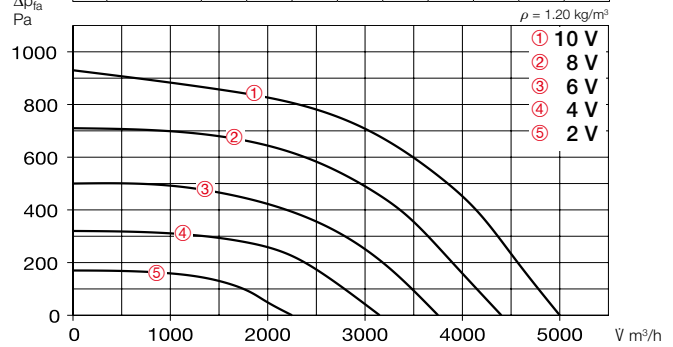

Free blowing						
Voltage V	n min ⁻¹	V m ³ /h	P W	I A	Lp dB(A)	SFP kW/m ³ /s
10	2000	5000	1120	1.8	68	0.81
8	1750	4400	800	1.3	65	0.65
6	1500	3750	520	0.90	62	0.50
4	1250	3150	320	0.60	57	0.37

Performance curves MBD EC 400 B

Frequency	Hz	Tot.	125	250	500	1k	2k	4k	8k
L _{WA} Radiation		dB(A)	80	60	73	75	76	73	63
L _{WA} Inlet side		dB(A)	93	71	86	88	84	85	79
L _{WA} Outlet side		dB(A)	95	75	88	90	90	88	77

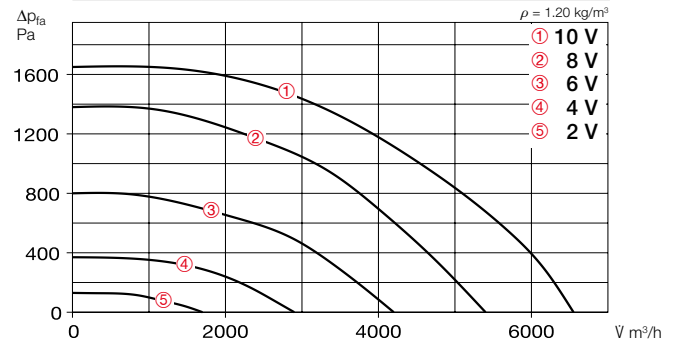

Free blowing						
Voltage V	n min ⁻¹	V m ³ /h	P W	I A	Lp dB(A)	SFP kW/m ³ /s
10	2600	6550	2300	3.60	72	1.27
8	2300	5400	1600	2.60	69	1.06
6	1800	4200	800	1.50	64	0.68
4	1250	2900	270	0.60	57	0.35

Accessory details Page

Universal control system, electronic controller, speed potentiometer 605 ff.

Type	Ref. no.	Connection Ø	Flow rate free blowing	Rated speed	Case-rad. sound pressure	Power consumption	Current consumption	Wiring diagram	Max. air flow temp.	Weight net aprx.	Universal control system		Speed potentiometer			
											Type	Ref. no.	Type	Ref. no.	Type	Ref. no.
Three-phase current, 3~, 400 V, 50/60 Hz, EC motor, protection category IP55																
MBD EC 400 A	05855	400	5000	2000	68	1.30	2.00	988	120	65.0	EUR EC ¹⁾²⁾ 01347	PU 10 ¹⁾	01734	PA 10 ¹⁾	01735	
MBD EC 400 B	05848	400	6550	2600	72	2.65	4.10	988	120	72.0	EUR EC ¹⁾²⁾ 01347	PU 10 ¹⁾	01734	PA 10 ¹⁾	01735	

1) Multiple EC fans can normally be connected. 2) Alternative electronic diff. pressure/temperature controller (EDR/ETR, No. 01437/01438) or three level speed switch (SU/SA, No. 04266/04267), see accessories.

MB 160 Ex



Dimensions MB 160 Ex

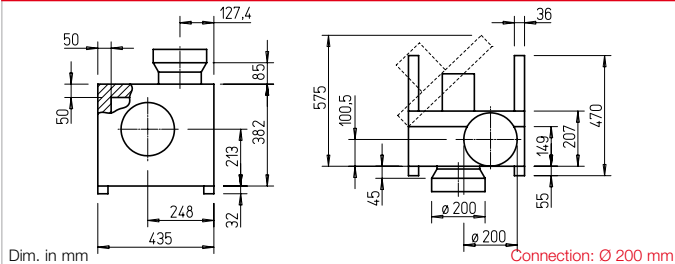

Casing

Double-walled, made of galvanised steel sheet. Sound insulated by lining with 50 mm thick mineral wool insulation boards. Duct connectors on inlet side and outlet side, with rubber lip seal, adapted to standard diameter. Motor-impeller unit fully retractable for inspection and cleaning, suspended on stable hinges. Includes mounting rails made of galvanised steel with screwed-on vibration dampers for easy installation.

Impeller

Forward curved high performance centrifugal impeller made of galvanised steel, dynamically balanced together with the motor.

High efficiency, low noise, aerodynamically optimised volute casing.

Drive

Through maintenance-free IEC flange motor in protection category IP55. Ball bearing mounted, radio interference-free.

Electrical connection

Standard terminal box (IP55) on outside of motor.

Performance curves MBD 160/4 Ex

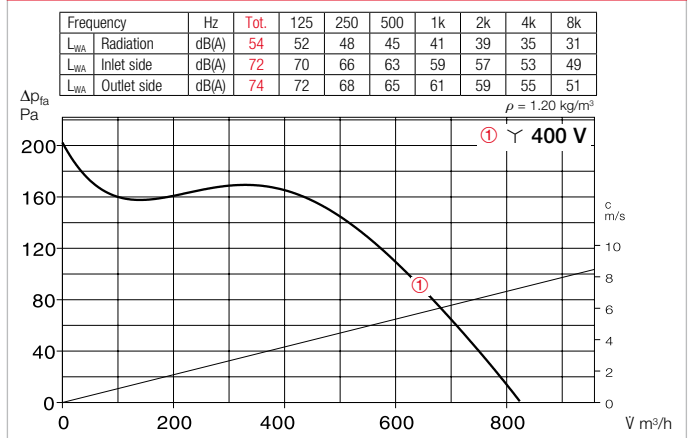

Performance curves MBD 160/2 Ex

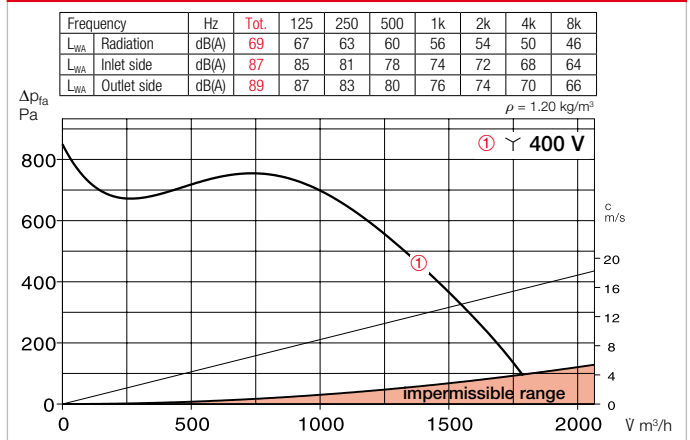

Accessories

Wall bracket

Made of galvanised steel sheet.
MB-WK 160 Ref. no. 05526

Weather protection cover

Made of galvanised steel sheet, mounted above motor.
MB-WSD Ref. no. 01856

Flexible connecting sleeve

For installation between fan and duct.
FM 200 Ex Ref. no. 01686

Reference

Techn. description, selection table
Page 312 ff.

EC box fans

Type	Ref. no.	Flow rate free blowing V m³/h	Rated speed min ⁻¹	Case-rad. sound pressure dB(A) at 1m	Power consumption* kW	Current consumption*		Wiring diagram No.	Max. air flow temperature		Weight net aprx. kg	Transformer speed controller 5-step			
						at rated voltage A	in contr. mode A		Rat. vol.. + °C	Control + °C		with motor prot. circuit breaker Type	Ref. no.	w/o motor prot. circuit breaker Type	Ref. no.
Explosion-proof, II 2G Ex h IIB T3 Gb, motor Ex e, three-phase current 400 V, 50 Hz, protection category IP55															
MBD 160/4 Ex	06001	970	1370	48	0.37	1.08	–	470	40	–	25.0	Not permitted	Not permitted	–	
MBD 160/2 Ex	06002	2020	2840	63	1.50	3.15	–	470	40	–	34.0	Not permitted	Not permitted	–	

* For ex-proof types: Motor ratings, see info p. 16.

MB 180 Ex



Performance curves MBD 180/4 Ex

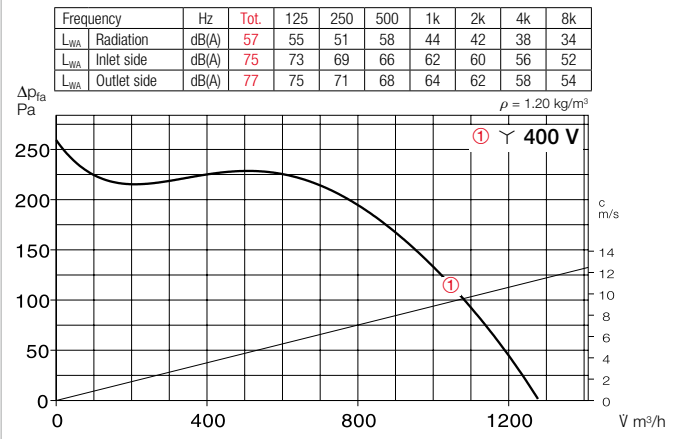

Dimensions MB 180 Ex

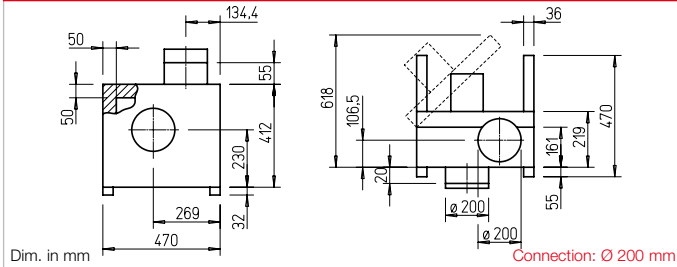

■ Casing

Double-walled, made of galvanised steel sheet. Sound insulated by lining with 50 mm thick mineral wool insulation boards. Duct connectors on inlet side and outlet side, with rubber lip seal, adapted to standard diameter. Motor-impeller unit fully retractable for inspection and cleaning, suspended on stable hinges. Includes mounting rails made of galvanised steel with screwed-on vibration dampers for easy installation.

■ Impeller

Forward curved high performance centrifugal impeller made of galvanised steel, dynamically balanced together with the motor.
 High efficiency, low noise, aerodynamically optimised volute casing.

■ Drive

Through maintenance-free IEC flange motor in protection category IP55. Ball bearing mounted, radio interference-free.

■ Electrical connection

Standard terminal box (IP55) on outside of motor.

■ Accessories

Wall bracket
 Made of galvanised steel sheet.
MB-WK 180 Ref. no. 05526

Weather protection cover
 Made of galvanised steel sheet, mounted above motor.
MB-WSD Ref. no. 01856

Flexible connecting sleeve
 For installation between fan and duct.
FM 200 Ex Ref. no. 01686

Reference	Page
Techn. description, selection table	312 ff.

Type	Ref. no.	Flow rate free blowing	Rated speed	Case-rad. sound pressure	Power consumption*	Current consumption*		Wiring diagram	Max. air flow temperature		Weight net aprx.	Transformer speed controller 5-step		Mot. prot. circ. break. for connecting built-in thermal contacts	
						at rated voltage	in contr. mode		Rat. vol..	Control		with motor prot. circuit breaker	w/o motor prot. circuit breaker		Type
		V m³/h	min ⁻¹	dB(A) at 1m	kW	A	A	No.	+ °C	+ °C	kg	Type	Ref. no.	Type	Ref. no.
Explosion-proof, II 2G Ex h IIB T3 Gb, motor Ex e, three-phase current 400 V, 50 Hz, protection category IP55															
MBD 180/4 Ex	06004	1370	1420	51	0.37	1.08	-	470	40	-	29.0	Not permitted	Not permitted	-	-

* For Ex types: Motor ratings, see info p. 16.

MB 200 Ex



Performance curves MBD 200/4 Ex

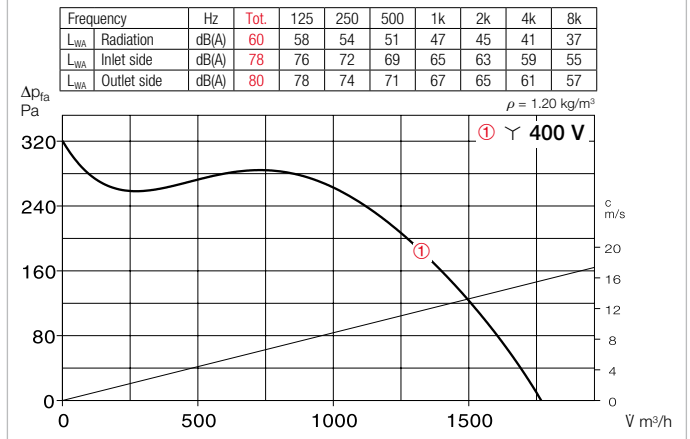

Dimensions MB 200 Ex

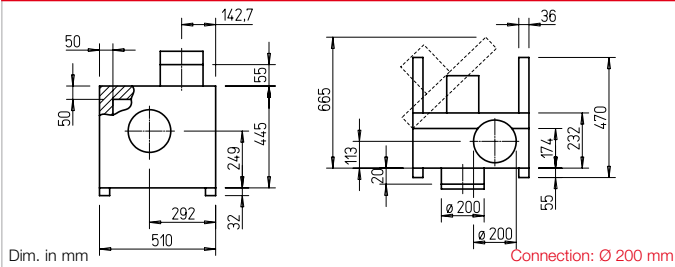

■ Casing

Double-walled, made of galvanised steel sheet. Sound insulated by lining with 50 mm thick mineral wool insulation boards. Duct connectors on inlet side and outlet side, with rubber lip seal, adapted to standard diameter. Motor-impeller unit fully retractable for inspection and cleaning, suspended on stable hinges. Includes mounting rails made of galvanised steel with screwed-on vibration dampers for easy installation.

■ Impeller

Forward curved high performance centrifugal impeller made of galvanised steel, dynamically balanced together with the motor.

High efficiency, low noise, aerodynamically optimised volute casing.

■ Drive

Through maintenance-free IEC flange motor in protection category IP55. Ball bearing mounted, radio interference-free.

■ Electrical connection

Standard terminal box (IP55) on outside of motor.

■ Accessories

Wall bracket

Made of galvanised steel sheet.
MB-WK 200 Ref. no. 05526

Weather protection cover

Made of galvanised steel sheet, mounted above motor.
MB-WSD Ref. no. 01856

Flexible connecting sleeve

For installation between fan and duct.
FM 200 Ex Ref. no. 01686

■ Reference

Techn. description, selection table **Page**
312 ff.

Type	Ref. no.	Flow rate free blowing V m ³ /h	Rated speed min ⁻¹	Case-rad. sound pressure dB(A) at 1m	Power consumption* kW	Current consumption*		Wiring diagram No.	Max. air flow temperature		Weight net aprx. kg	Transformer speed controller 5-step				Mot. prot. circ. break. for connecting built-in thermal contacts Type Ref. no.
						at rated voltage A	in contr. mode A		Rat. vol.. + °C	Control + °C		with motor prot. circuit breaker Type Ref. no.	w/o motor prot. circuit breaker Type Ref. no.			
Explosion-proof, II 2G Ex h IIB T3 Gb, motor Ex e, three-phase current 400 V, 50 Hz, protection category IP55																
MBD 200/4 Ex	06008	1840	1430	54	0.55	1.36	–	470	40	–	35.0	Not permitted	Not permitted	–	–	

* For Ex types: Motor ratings, see info p. 16.

MB 225



(Fig. similar)

Also available in version:



Dimensions MB 225

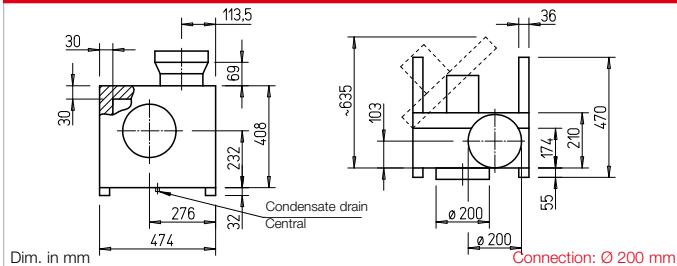

Casing

See page 312.

Impeller

Backward curved high performance centrifugal impeller made of aluminium, forward curved and made of galvanised steel for explosion-proof types. Dynamically balanced together with the motor. High efficiency, low noise, aerodynamically optimised casing.

Drive

Through maintenance-free, speed-controllable IEC flange motor in protection category IP55. Ball bearing mounted, radio interference-free.

Electrical connection

Standard terminal box (IP55) mounted to external cable, on outside of motor for explosion-proof types.

Motor protection

With external thermal contacts on the terminal block, which must be wired to the motor protection circuit breaker.

Power control

See page 312.

Accessories

Wall bracket made of galv. steel sheet.

MB-WK EC225 Ref. no. 05526

Wall bracket for Ex types.

MB-WK 225 Ref. no. 05527

Weather protection cover (galv. steel sheet), mounted above motor.

MB-WSD Ref. no. 01856

Performance curves MBW 225/2

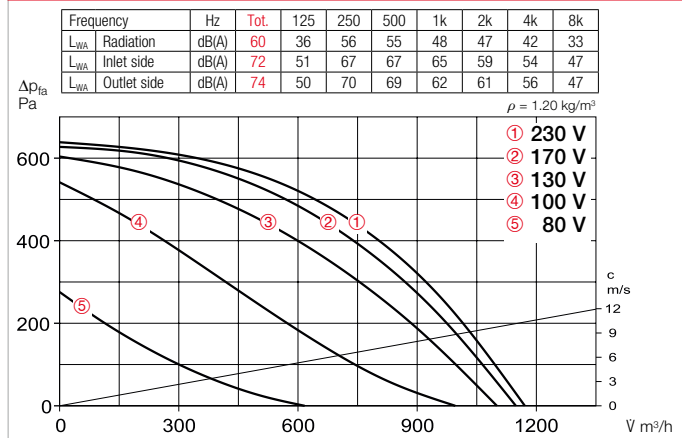

Performance curves MBD 225/2/2

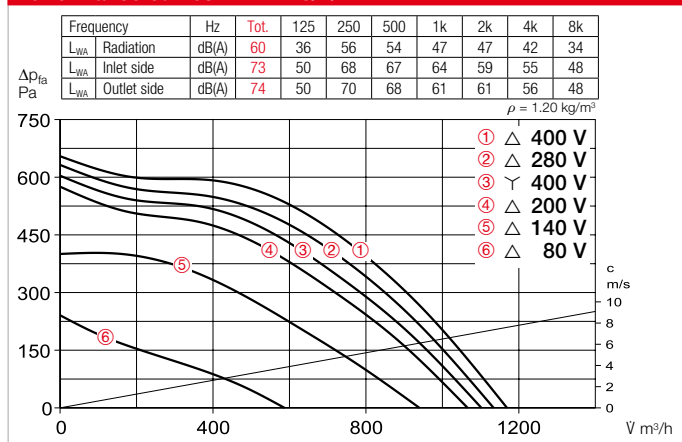

Performance curves MBD 225/4 Ex

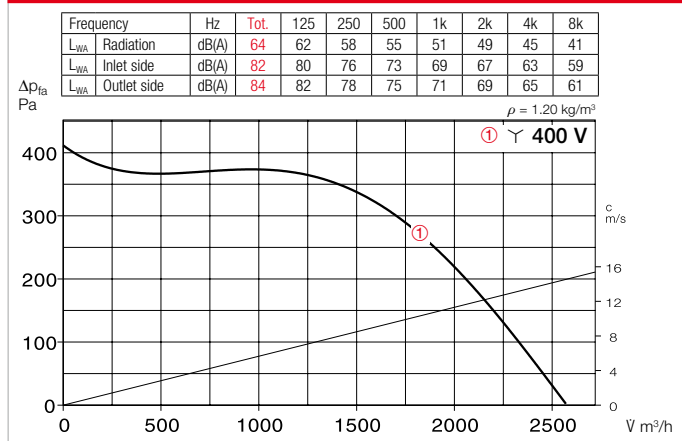

Flexible connecting sleeve for installation between fan and duct.

FM 200 (+70 °C) No. 01670

FM 200 T120 (+120 °C) No. 01654

FM 250 Ex No. 01688

Speed switch and on/off switch for two-speed ∇/Δ switchable three-phase current fans.

DS 2³⁾ Ref. no. 01351

Type	Ref. no.	Flow rate free blowing V m³/h	Rated speed min ⁻¹	Case-rad. sound pressure dB(A) at 1m	Power consumption* kW	Current consumption*		Wiring diagram No.	Max. air flow temperature		Weight net aprx. kg	Transformer speed controller 5-step				Mot. prot. circ. break for connecting built-in thermal contacts Type Ref. no.	
						at rated voltage A	in contr. mode A		Rat. vol. + °C	Control + °C		with motor prot. circuit breaker Type Ref. no.	w/o motor prot. circuit breaker Type Ref. no.				
Alternating current, 230 V, 50 Hz, Capacitor motor, protection category IP55																	
MBW 225/2	06456	1170	2900	52	0.21	1.10	1.80	1119	100	60	25.0	MWS 3	01948	TSW 3.0	01496	MW ¹⁾	01579
Two-speed, three-phase current motor, 400 V, 50 Hz, ∇/Δ connection, protection category IP55																	
MBD 225/2/2	06457	1100/1170	2675/2885	49.52	0.16/0.20	0.29/0.57	0.57	520	100	60	25.0	RDS 1	01314	TSD 0.8 ³⁾	01500	M4 ²⁾	01571
Ex Explosion-proof, II 2G Ex h IIB T3 Gb, motor Ex e, three-phase current 400 Volt, 50 Hz, protection category IP55																	
MBD 225/4 Ex ⁴⁾	06011	2770	1390	56	0.75	2.00	-	470	40	-	40	Not permitted		Not permitted		-	

* For Ex types: Motor ratings, see info p. 16.

¹⁾ Incl. operating switch.

²⁾ Incl. operating and speed switch. ³⁾ Req. motor protection circuit breaker: Type MD, No. 05849.

⁴⁾ Dimensional drawing at www.HeliosSelect.de.

MB 250



(Fig. similar)

Also available in version:



Dimensions MB 250

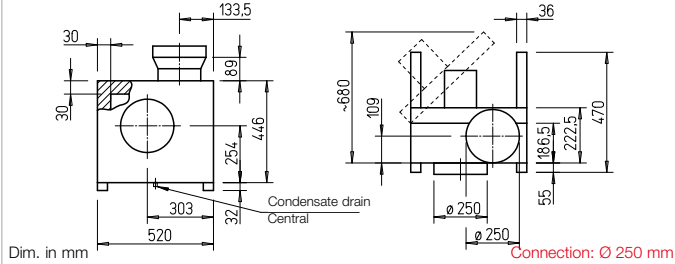

Casing

See page 312.

Impeller

Backward curved high performance centrifugal impeller made of aluminium, forward curved and made of galvanised steel for explosion-proof types. Dynamically balanced together with the motor. High efficiency, low noise, aerodynamically optimised casing.

Drive

Through maintenance-free, speed-controllable IEC flange motor in protection category IP55. Ball bearing mounted, radio interference-free.

Electrical connection

Standard terminal box (IP55) mounted to external cable, on outside of motor for explosion-proof types.

Motor protection

With external thermal contacts on the terminal block, which must be wired to the motor protection circuit breaker.

Power control

See page 312.

Accessories

Wall bracket made of galv. steel sheet.

MB-WK EC250 Ref. no. 05526

Wall bracket for Ex types.

MB-WK 250 Ref. no. 05527

Weather protection cover (galv. steel sheet), mounted above motor.

MB-WSD Ref. no. 01856

Performance curves MBW 250/2

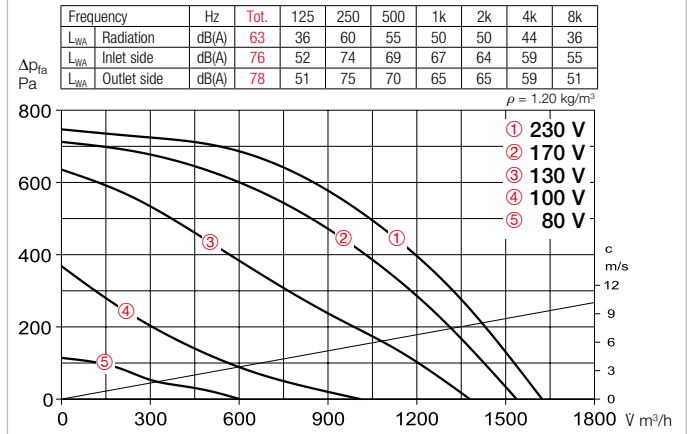

Performance curves MBD 250/2/2

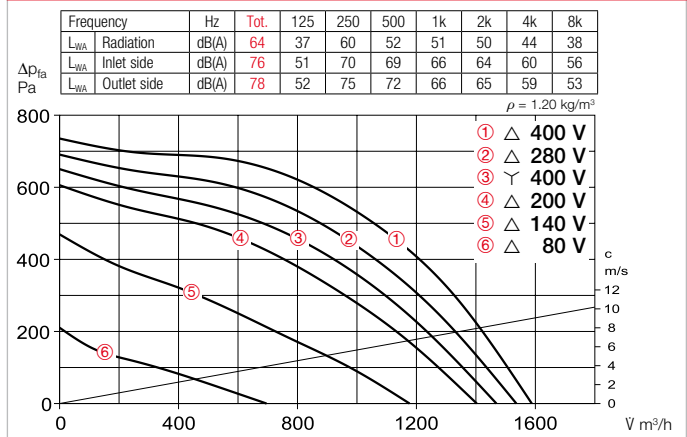

Performance curves MBD 250/4 Ex

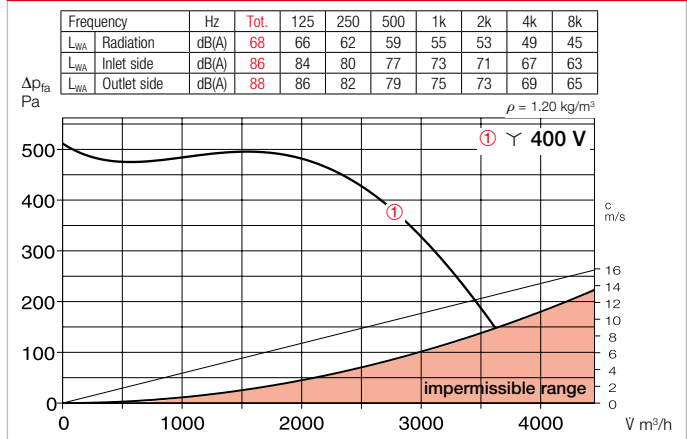

Flexible connecting sleeve for installation between fan and duct.
FM 250 (+70 °C) No. 01672
FM 250 T120 (+120 °C) No. 01655
FM 315 Ex No. 01690

Speed switch and on/off switch for two-speed Υ/Δ switchable three-phase current fans.
DS 2³⁾ Ref. no. 01351

Type	Ref. no.	Flow rate free blowing	Rated speed	Case-rad. sound pressure	Power consumption*	Current consumption*		Wiring diagram	Max. air flow temperature	Weight net appr.	Transformer speed controller 5-step		Mot. prot. circ. break. for connecting built-in thermal contacts						
		V m³/h	min ⁻¹	dB(A) at 1m	kW	at rated voltage	in contr. mode		Rat. vol.		Control	kg		with motor prot. circuit breaker	w/o motor prot. circuit breaker	Type	Ref. no.	Type	Ref. no.
Alternating current, 230 V, 50 Hz, Capacitor motor, protection category IP55																			
MBW 250/2	06458	1620	2840	55	0.30	1.40	2.10	1119	100	60	28.0	MWS 3	01948	TSW 3.0	01496	MW ¹⁾	01579		
Two-speed, three-phase current motor, 400 V, 50 Hz, Υ/Δ connection, protection category IP55																			
MBD 250/2/2	06459	1470/1600	2500/2820	53/56	0.23/0.29	0.40/0.70	0.70	520	100	60	28.0	RDS 1	01314	TSD 0.8 ³⁾	01500	M4 ²⁾	01571		
Ex Explosion-proof, II 2G Ex h IIB T3 Gb, motor Ex e, three-phase current 400 Volt, 50 Hz, protection category IP55																			
MBD 250/4 Ex ⁴⁾	06014	4140	1405	62	1.50	3.35	-	470	40	-	52.0	Not permitted		Not permitted					

* For Ex types: Motor ratings, see info p. 16.

¹⁾ Incl. operating switch.

²⁾ Incl. operating and speed switch. ³⁾ Req. motor protection circuit breaker: Type MD, No. 05849.

⁴⁾ Dimensional drawing at www.HeliosSelect.de.

MB 280



(Fig. similar)

Also available in version:



Dimensions MB 280

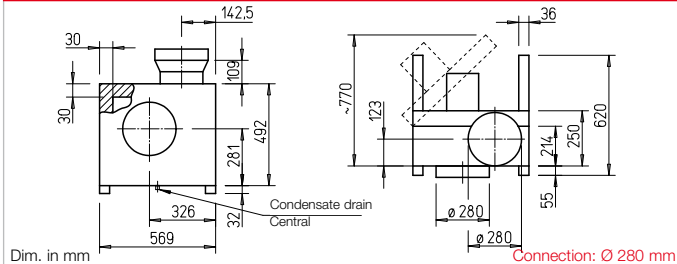

■ Casing

See page 312.

■ Impeller

Backward curved high performance centrifugal impeller made of aluminium, forward curved and made of galvanised steel for explosion-proof types. Dynamically balanced together with the motor. High efficiency, low noise, aerodynamically optimised casing.

■ Drive

Through maintenance-free, speed-controllable IEC flange motor in protection category IP55. Ball bearing mounted, radio interference-free.

■ Electrical connection

Standard terminal box (IP55) mounted to external cable, on outside of motor for explosion-proof types.

■ Motor protection

With external thermal contacts on the terminal block, which must be wired to the motor protection circuit breaker.

■ Power control

See page 312.

■ Accessories

Wall bracket made of galv. steel sheet.

MB-WK EC280 Ref. no. 05527

Wall bracket for Ex types.

MB-WK 280 Ref. no. 05527

Weather protection cover (galv. steel sheet), mounted above motor.

MB-WSD Ref. no. 01856

Performance curves MBD 280/2/2

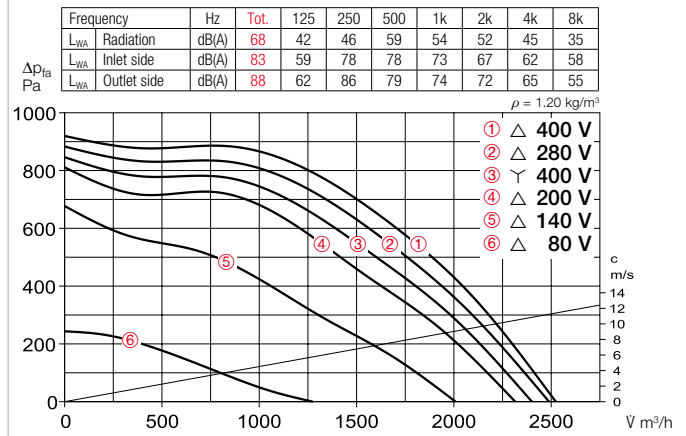

Performance curves MBD 280/6 Ex

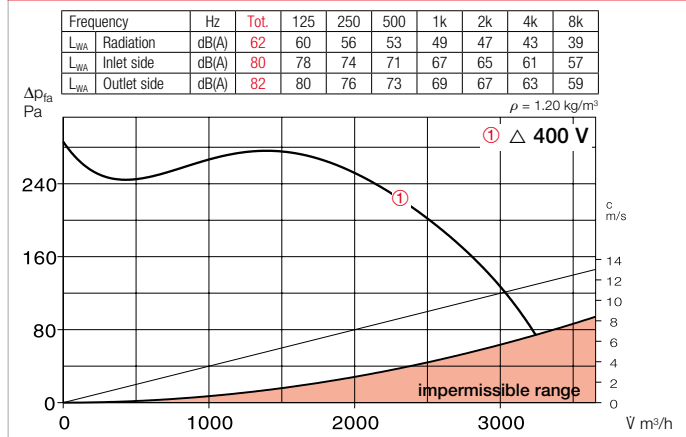

Performance curves MBD 280/4 Ex

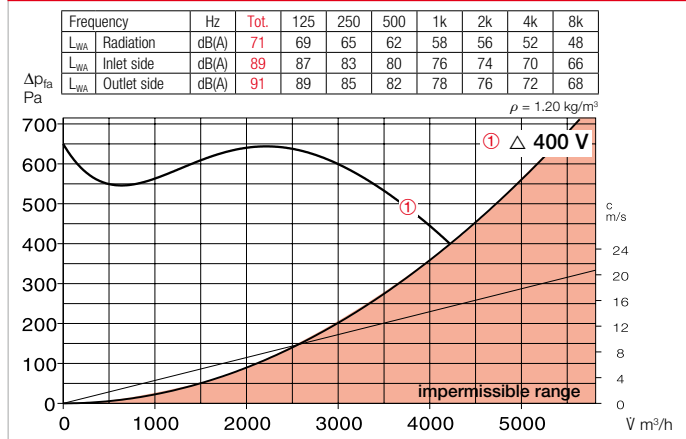

Flexible connecting sleeve for installation between fan and duct.

FM 280 (+70 °C) No. 01673

FM 280 T120(+120 °C) No. 01656

FM 315 Ex No. 01690

Speed switch and on/off switch for two-speed Y/Δ switchable three-phase current fans.

DS 2²⁾ Ref. no. 01351

Type	Ref. no.	Flow rate free blowing	Rated speed	Case-rad. sound pressure	Power consumption*	Current consumption*		Wiring diagram	Max. air flow temperature		Weight net appr.	Transformer speed controller 5-step				Mot. prot. circ. break. for connecting built-in thermal contacts	
						at rated voltage	in contr. mode		Rat. vol..	Control		with motor prot. circuit breaker	w/o motor prot. circuit breaker	Type	Ref. no.		Type
Two-speed, three-phase current motor, 400 V, 50 Hz, Y/Δ connection, protection category IP55																	
MBD 280/2/2	06460	2400/2520	2680/2890	56/60	0.48/0.57	0.80/1.50	1.60	520	100	60	35.0	RDS 2	01315	TSD 3.0²⁾	01502	M4¹⁾	01571
Ex Explosion-proof, II 2G Ex h IIB T3 Gb, motor Ex e, three-phase current 400 Volt, 50 Hz, protection category IP55																	
MBD 280/6 Ex³⁾	06016	2960	925	56	0.95	2.70	-	498	40	-	60.0	Not permitted		Not permitted		-	-
MBD 280/4 Ex³⁾	06017	4960	1420	65	2.00	4.65	-	498	40	-	68.0	Not permitted		Not permitted		-	-

* For Ex types: Motor ratings, see info p.16. ¹⁾ Incl. operating and speed switch. ²⁾ Req. motor prot. circuit breaker: Type MD, No. 05849. ³⁾ Dim. drawing at www.HeliosSelect.de.

MB 315



Dimensions MB 315

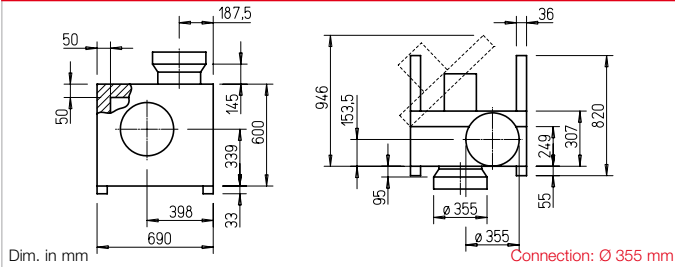

Casing

See page 312.

Impeller

Backward curved high performance centrifugal impeller made of aluminium, mounted directly on motor shaft. High efficiency, low noise, aerodynamically optimised volute casing. Dynamically balanced in accordance with DIN ISO 21940-11 – quality grade 6.3.

Drive

Through maintenance-free, speed-controllable IEC flange motor in protection category IP55. Ball bearing mounted, radio interference-free.

Electrical connection

Standard terminal box (IP55) mounted to external cable, on outside of motor for type MBD 315/2/2.

Motor protection

With external thermal contacts on the terminal block, which must be wired to the motor protection circuit breaker.

Power control

All types are speed-controllable using voltage reduction by means of transformer (accessories). The 3~ types can also be operated at two speeds using a Y/Δ switch or motor protection circuit breaker M4. Performance levels are shown in the performance diagram.

Accessories

Wall bracket made of galv. steel sheet.

MB-WK 315 Ref. no. 05528

Weather protection cover (galv. steel sheet), mounted above motor.

MB-WSD Ref. no. 01856

Performance curves MBW 315/4

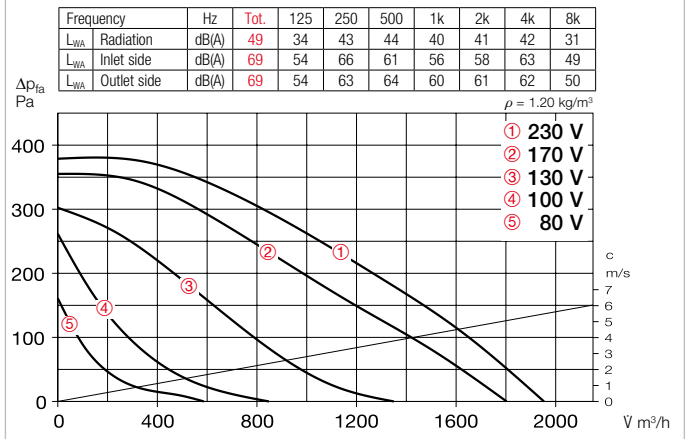

Performance curves MBD 315/4/4

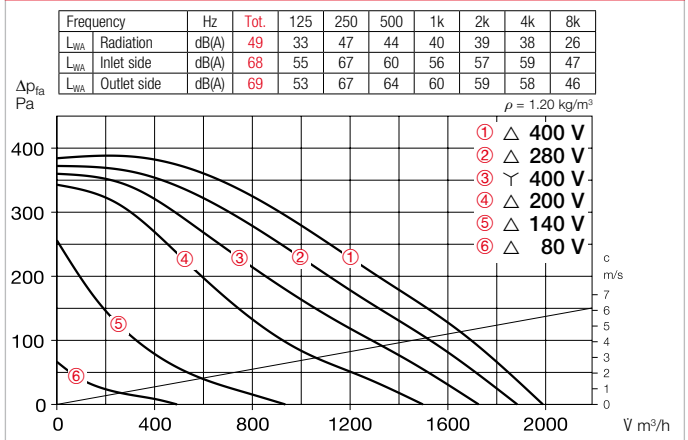

Performance curves MBD 315/2/2

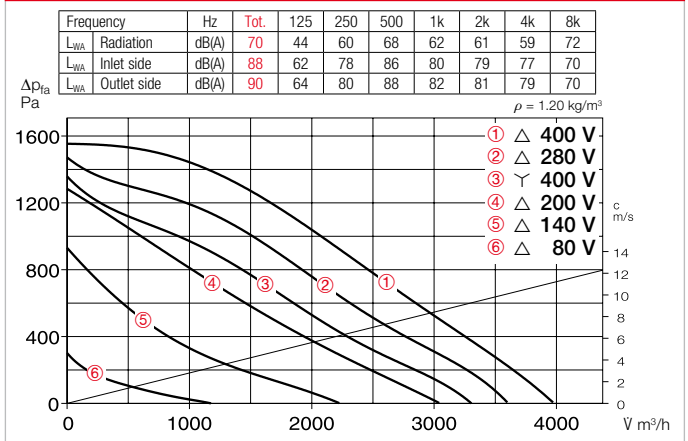

Flexible connecting sleeve for installation between fan and duct.

FM 355 (+70 °C) No. 01675

FM 355 T120 (+120 °C) No. 01658

Speed switch and on/off switch for two-speed Y/Δ switchable three-phase current fans.

DS 2³⁾ Ref. no. 01351

Type	Ref. no.	Flow rate free blowing	Rated speed	Case-rad. sound pressure	Power consumption	Current consumption		Wiring diagram	Max. air flow temperature		Weight net aprx.	Transformer speed controller 5-step				Mot. prot. circ. break. for connecting built-in thermal contacts	
						at rated voltage	in contr. mode		Rat. vol..	Control		with motor prot. circuit breaker	w/o motor prot. circuit breaker	Type	Ref. no.		Type
		V m ³ /h	min ⁻¹	dB(A) at 1m	kW	A	A	No.	+ °C	+ °C	kg	Type	Ref. no.	Type	Ref. no.	Type	Ref. no.
Alternating current, 230 V, 50 Hz, Capacitor motor, protection category IP55																	
MBW 315/4	05929	1950	1400	41	0.16	0.80	0.97	1119	100	60	72.0	MWS 1.5	01947	TSW 1.5	01495	MW ¹⁾	01579
Two-speed, three-phase current motor, 400 V, 50 Hz, Y/Δ connection, protection category IP55																	
MBD 315/4/4	05945	1730/1990	1180/1430	37/41	0.14/0.16	0.27/0.37	0.46	520	100	60	72.0	RDS 1	01314	TSD 0.8 ³⁾	01500	M4 ²⁾	01571
MBD 315/2/2	05946	3300/3980	2270/2780	60/64	0.86/1.16	1.40/2.20	2.40	520	100	60	75.0	RDS 4	01316	TSD 3.0 ³⁾	01502	M4 ²⁾	01571

¹⁾ Incl. operating switch.

²⁾ Incl. operating and speed switch.

³⁾ Req. motor protection circuit breaker: Type MD, No. 05849.

MB 355



Dimensions MB 355

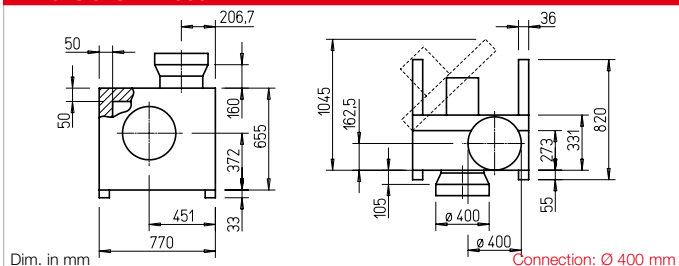

Casing

See page 312.

Impeller

Backward curved high performance centrifugal impeller made of aluminium, mounted directly on motor shaft. High efficiency, low noise, aerodynamically optimised volute casing. Dynamically balanced in accordance with DIN ISO 21940-11 – quality grade 6.3.

Drive

Through maintenance-free, speed-controllable IEC flange motor in protection category IP55. Ball bearing mounted, radio interference-free.

Electrical connection

Standard terminal box (IP55) mounted to external cable, on outside of motor for type MBD 355/2/2.

Motor protection

With external thermal contacts on the terminal block, which must be wired to the motor protection circuit breaker.

Power control

All types are speed-controllable using voltage reduction by means of transformer (accessories). The 3~ types can also be operated at two speeds using a Υ/Δ switch or motor protection circuit breaker M4. Performance levels are shown in the performance diagram.

Accessories

- Wall bracket** made of galv. steel sheet.
MB-WK 355 Ref. no. 05528
- Weather protection cover** (galv. steel sheet), mounted above motor.
MB-WSD Ref. no. 01856

Performance curves MBW 355/4

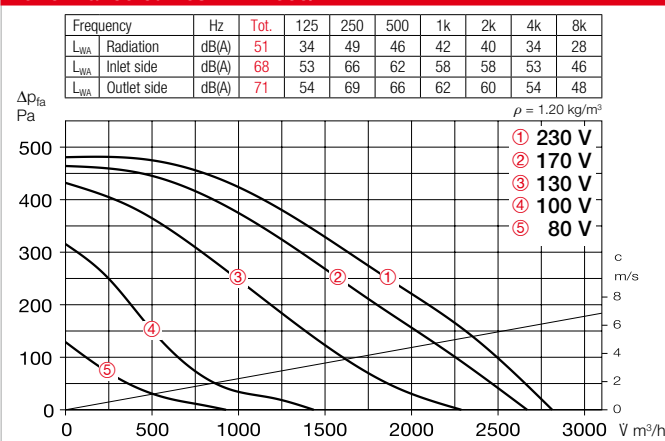

Performance curves MBD 355/4/4

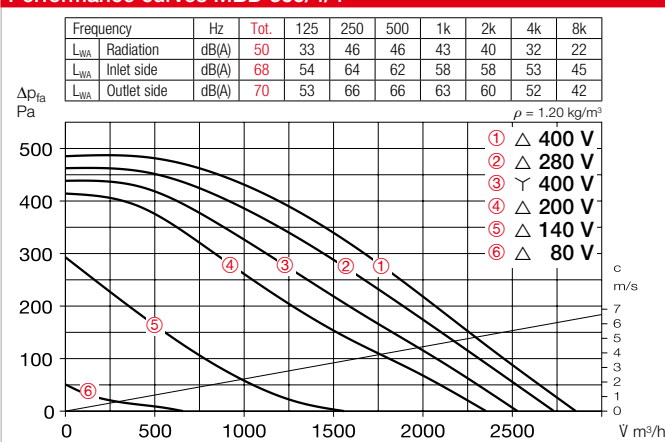

Performance curves MBD 355/2/2

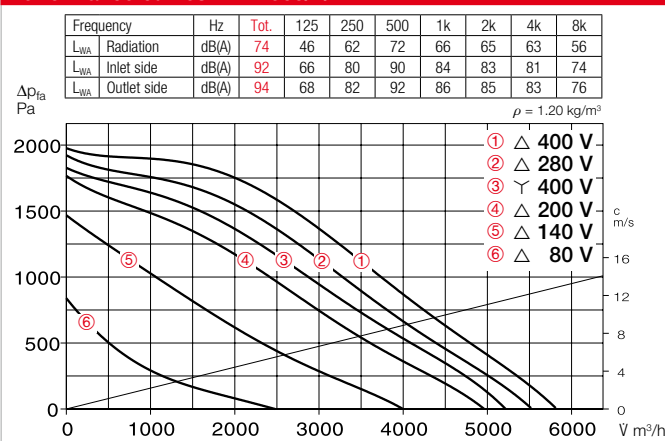

Flexible connecting sleeve for installation between fan and duct.
FM 400 (+70 °C) No. 01676
FM 400 T120(+120 °C) No. 01659

Speed switch and on/off switch for two-speed Υ/Δ switchable three-phase current fans.
DS 2³⁾ Ref. no. 01351

Type	Ref. no.	Flow rate free blowing	Rated speed	Case-rad. sound pressure	Power consumption	Current consumption		Wiring diagram	Max. air flow temperature		Weight net appr.	Transformer speed controller 5-step					
						at rated voltage	in contr. mode		Rat. vol..	Control		with motor prot. circuit breaker	w/o motor prot. circuit breaker	Mot. prot. circ. break. for connecting built-in thermal contacts			
		V m³/h	min⁻¹	dB(A) at 1m	kW	A	A	No.	+ °C	+ °C	kg	Type	Ref. no.	Type	Ref. no.	Type	Ref. no.
Alternating current, 230 V, 50 Hz, Capacitor motor, protection category IP55																	
MBW 355/4	05951	2810	1410	43	0.30	1.40	1.90	1119	100	60	81.0	MWS 3	01948	TSW 3.0	01496	MW 1)	01579
Two-speed, three-phase current motor, 400 V, 50 Hz, Υ/Δ connection, protection category IP55																	
MBD 355/4/4	05947	2530/2850	1240/1430	40/42	0.26/0.30	0.45/0.63	0.84	520	100	60	81.0	RDS 2	01315	TSD 1.5 3)	01501	M4 2)	01571
MBD 355/2/2	05948	5210/5800	2840/2510	65/68	2.20/1.65	2.9/5.0	5.50	520	100	60	100.0	RDS 7	01578	TSD 7.0 3)	01504	M4 2)	01571

¹⁾ Incl. operating switch. ²⁾ Incl. operating and speed switch. ³⁾ Req. motor protection circuit breaker: Type MD, No. 05849.

MB 400



Dimensions MB 400

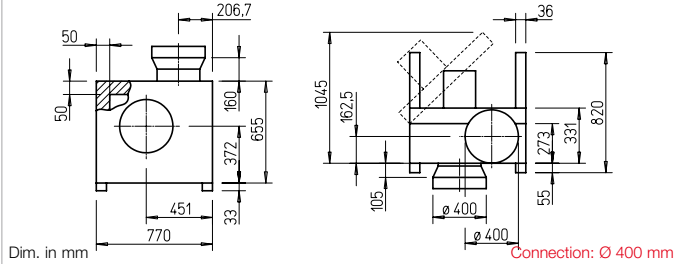

- Casing**
See page 312.
- Impeller**
Backward curved high performance centrifugal impeller made of aluminium, mounted directly on motor shaft.
High efficiency, low noise, aerodynamically optimised volute casing.
Dynamically balanced in accordance with DIN ISO 21940-11 – quality grade 6.3.
- Drive**
Through maintenance-free, speed-controllable IEC flange motor in protection category IP55. Ball bearing mounted, radio interference-free.
- Electrical connection**
Standard terminal box (IP55) mounted to external cable, on outside of motor for type MBD 400/2/2.

- Motor protection**
With external thermal contacts on the terminal block, which must be wired to the motor protection circuit breaker.
- Power control**
All types are speed-controllable using voltage reduction by means of transformer (accessories).
The 3~ types can also be operated at two speeds using a Y/Δ switch or motor protection circuit breaker M4. Performance levels are shown in the performance diagram.
- Accessories**
Wall bracket made of galv. steel sheet.
MB-WK 400 Ref. no. 05528
Weather protection cover (galv. steel sheet), mounted above motor.
MB-WSD Ref. no. 01856

Performance curves MBW 400/4

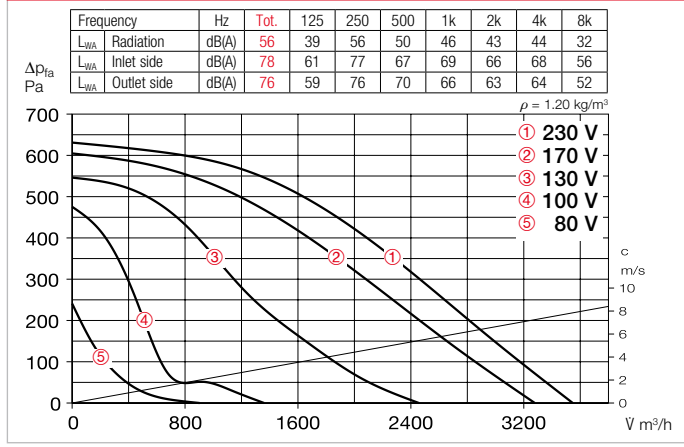

Performance curves MBD 400/4/4

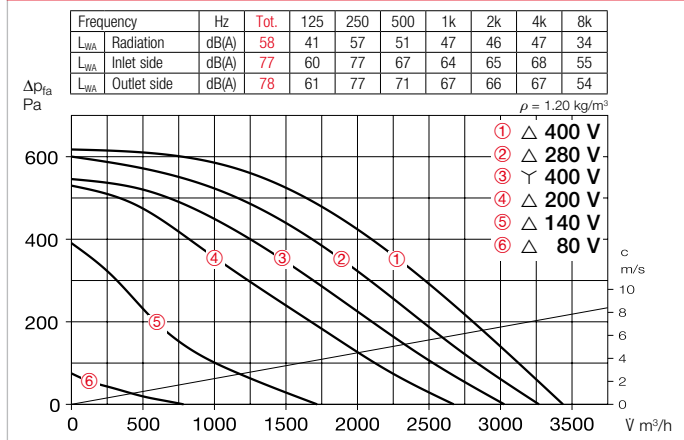

Performance curves MBD 400/2/2

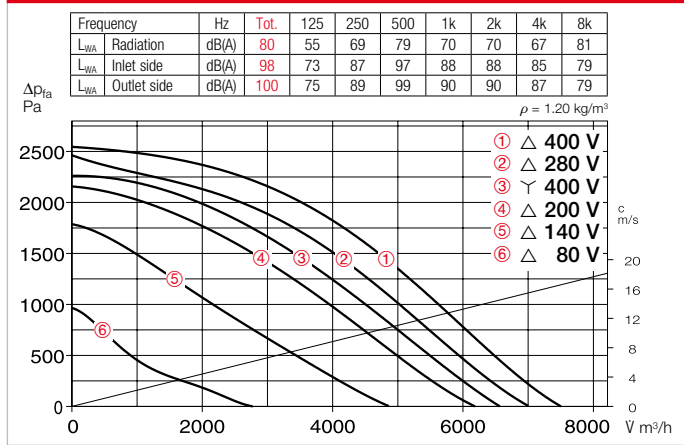

Flexible connecting sleeve for installation between fan and duct.
FM 400 (+70 °C) No. 01676
FM 400 T120(+120 °C) No. 01659

Speed switch and on/off switch for two-speed Y/Δ switchable three-phase current fans.
DS 2³⁾ Ref. no. 01351

Type	Ref. no.	Flow rate free blowing	Rated speed	Case-rad. sound pressure	Power consumption	Current consumption		Wiring diagram	Max. air flow temperature		Weight net appr.	Transformer speed controller 5-step				Mot. prot. circ. break. for connecting built-in thermal contacts	
						at rated voltage	in contr. mode		Rat. vol..	Control		kg	with motor prot. circuit breaker	w/o motor prot. circuit breaker	Type		Ref. no.
		V m³/h	min ⁻¹	dB(A) at 1m	kW	A	A	No.	+ °C	+ °C		Type	Ref. no.	Type	Ref. no.	Type	Ref. no.
Alternating current, 230 V, 50 Hz, Capacitor motor, protection category IP55																	
MBW 400/4	05953	3550	1410	48	0.49	2.50	3.70	1119	100	60	85.0	MWS 5	01949	TSW 7.5	01596	MW ¹⁾	01579
Two-speed, three-phase current motor, 400 V, 50 Hz, Y/Δ connection, protection category IP55																	
MBD 400/4/4	05955	3030/3440	1180/1410	46/50	0.41/0.50	0.71/1.00	1.30	520	100	60	82.0	RDS 2	01315	TSD 1.5 ³⁾	01501	M4 ²⁾	01571
MBD 400/2/2	05949	6570/7500	2840/2510	71/74	3.10/3.70	6.10/4.80	9.00	520	100	60	110.0	RDS 11	01332	TSD 11 ³⁾	01513	M4 ²⁾	01571

¹⁾ Incl. operating switch. ²⁾ Incl. operating and speed switch. ³⁾ Req. motor protection circuit breaker: Type MD, No. 05849.

Box fans

Feel-good climate thanks to pre-heated and filtered supply air.

System solution: **Supply air ductwork.**

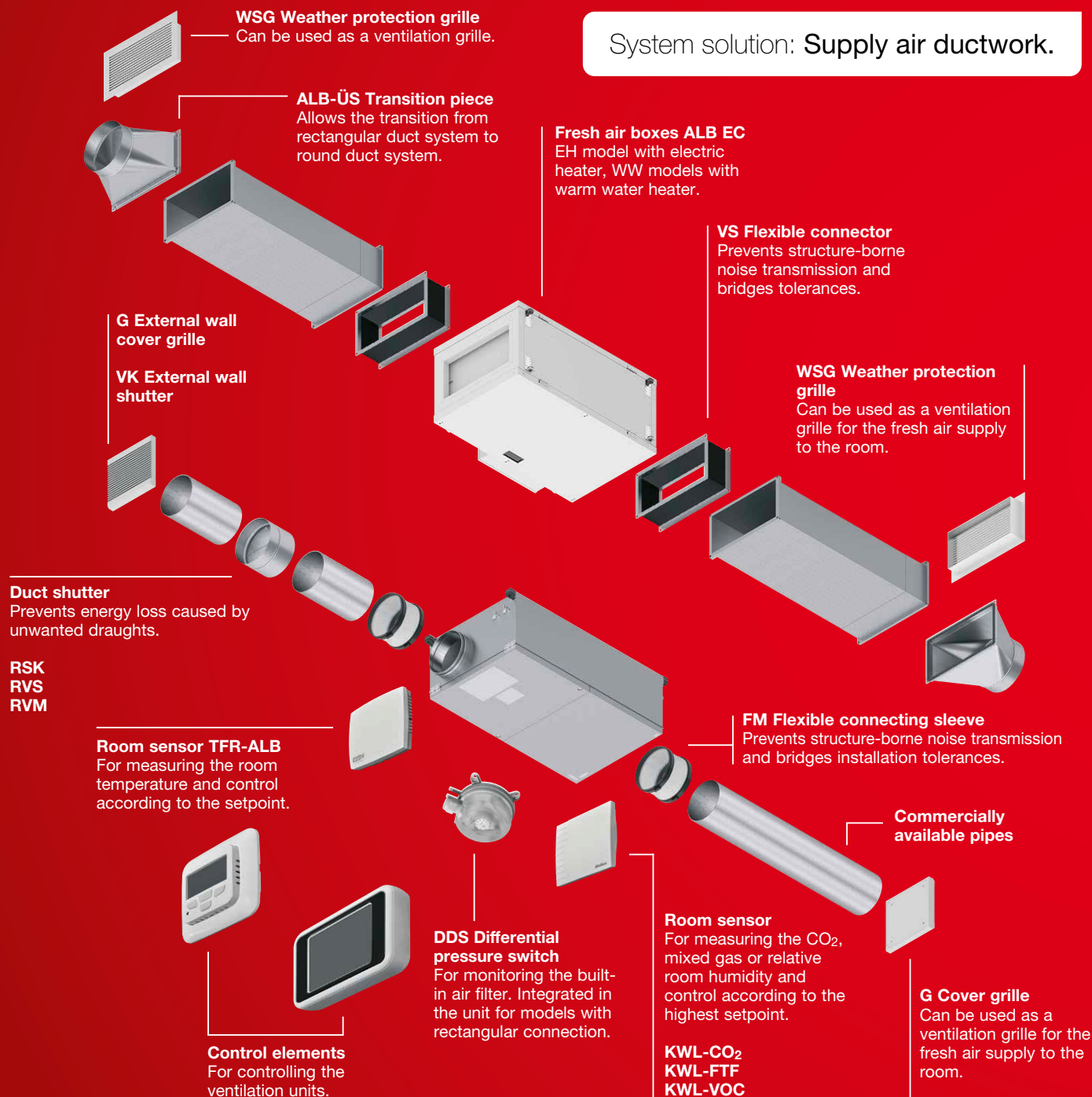

System solution: **Extract air ductwork**

The fresh air box control elements allow the control of extract air fans in the Helios range.

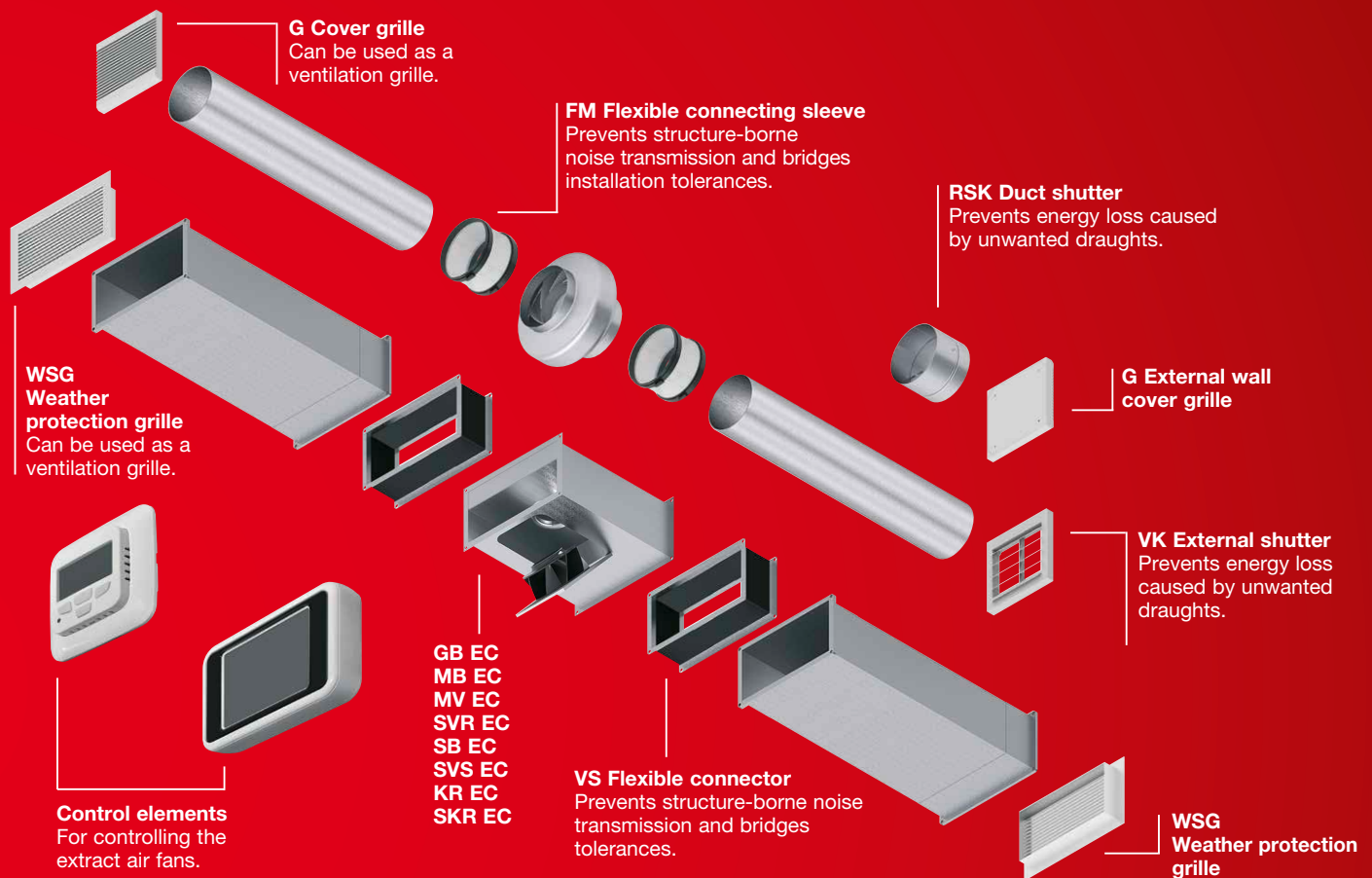

Box fans

Incredibly practical:

Supply air, heating and filter in one single unit. For direct insertion in round duct and rectangular duct runs. The Helios fresh air boxes ALB provide for a pleasant indoor climate by supplying external intake air which is filtered and heated to the pre-set temperature. ALB are ideally suitable for all rooms where clean and preheated fresh air is required.

Whether in bistros, boutiques or other commercial areas. Specially equipped silencer casings and low-noise centrifugal fans ensure that the fresh air boxes are virtually silent.

Large cartridge filters result in the longest possible cleaning intervals. Control options for maximum comfort and efficient energy saving are included in the scope of delivery or available as accessories.

EH models with electric heater
ALB EC EH

With electric heater and air filter. Heat output control is continuously variable. Delivered ready-for-connection with control unit included.

Ø 125 – 250 mm
□ 30 x 20 cm

334ff
WW models with warm water heater
ALB EC WW

With warm water heater and air filter. Delivered ready-for-connection with control unit included.

□ 40 x 20 cm, 50 x 30 cm,
60 x 35 cm, 80 x 50 cm

342ff

ALB EC 125 EH



Efficiency class

B

ALB EC 125 EH



Dimensions ALB EC 125 EH

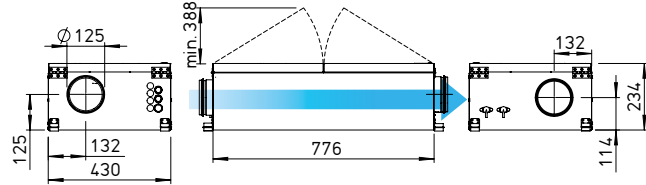

Dim. in mm

Application /Function
 Pleasant indoor climate through the addition of external fresh air which is filtered and automatically heated to the specified temperature.

Operational unit for connection to round duct systems. Suitable for a wide range of applications.

Description / Scope of delivery
 The air filter, fan, heater with controller and electrical terminal box are integrated in a compact flat casing which is thermally and acoustically insulated. Equipped as standard with a continuously variable, electronic heating controller and an external control unit for controlling the unit, as well as a connection cable (10 metres). Air quality, humidity and temperature sensors (see Accessories) can be connected to the electronics in the terminal box to control the specified setpoints.

Casing
 Robust construction made of galvanised steel sheet, 50 mm thick mineral wool lining on all sides, which is also covered with dirt-repellent glass fabric. The cover is easy to open with screw caps and hinge for cleaning purposes. Round duct connectors on inlet side and outlet side with sealing lips, adapted to standard duct Ø. No thermal bridges, smooth surface for easy cleaning.

Filter
 The large filter for long cleaning intervals is freely accessible by opening the casing cover. Standard version ISO ePM_{2.5} 60% (M5). Alternatively, filters with higher classifications ISO ePM₁ 50% (F7) (see accessories) can be used. The volume output reduction must be taken into account. Periodic filter inspection / cleaning is required. Equipment with automatic monitoring DDS (see Accessories) is recommended.

Fan
 The volume flow rate switching is continuously variable with the control unit. Low-noise and high performance centrifugal fan made of galvanised steel sheet. Motor/impeller unit freely accessible for servicing. Drive through energy-saving, speed-controllable EC motor with the highest level of efficiency. Maintenance-free, with lifetime lubricated ball bearings.

Heating element
 Enclosed sheathed heating elements made of stainless steel with low surface temperature heat the intake air to the specified setpoint temperature. The electronic pulser continuously variably controls the heat output in constant comparison between the setpoint and the temperature measured by the room or duct sensor.

Turn-off delay
 The unit has a fixed turn-off delay time of approx. 2 minutes if the heating element has been activated.

Electrical connection
 Spacious terminal box inside the casing. Cable entry from the front of the unit through three cable glands and another four holes are provided.

Motor protection
 Deactivation when overheating is imminent. Automatic reactivation after cool down.

Noise
 The total level and range for the case-radiated sound power and outlet side sound power in dB(A) are specified above the performance diagram. In addition, the type table shows the radiated noise and outlet side air noise as sound pressure at 1 m (free field conditions). If necessary, a cross talk silencer (see Accessories) must be integrated in the duct system on site. The radiated noise as sound pressure level at 1 m (free field conditions) is additionally stated in the type table as well as in the table below the performance curve.

Control
 The control element is included in the delivery and offers the following functions:

- Operation with different volume flows.
- Weekly and seasonal timer.
- Temperature control (using room sensor, accessories).
- Control of electronic heating controller. Specification of min./max. temperature.
- Control of an EC extract air fan.
- Display of ambient temperature, outdoor temperature, supply air temperature, fan control and filter contamination (using differential pressure switch, accessories).

- Other inputs and outputs:**
- Emergency switch contact.
 - Boost switch contact.
 - Input for air quality or humidity sensor.
 - Input for room temperature sensor.



Control element with connection cable (10 m) included in delivery. For flush-mounted installation. Dimensions mm (W x H) 82 x 82

Type	Ref. no.	Flow rate* free blowing V m³/h (max.)	Max. speed min-1	Freq. Hz	Sound pressure level		Prot. category	Voltage Volt	Power consumption kW	Current consump. max. tot. A	Wiring diagram No.	Max. intake temp. +°C	Weight net aprx. kg
					Case-radiation dB(A) at 1m	Air noise outlet side dB(A) at 1m							
ALB EC 125 EH	06808	445	3640	50/60	45	64	IP44	230, 1~	2.10	9.52	SS-1308	40	20

* Volume reduction by approx. 15% when using the filter ISO ePM₁ 50% (F7).

Performance curves ALB EC 125 EH

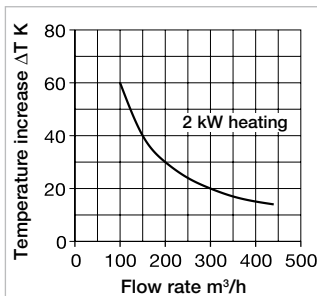
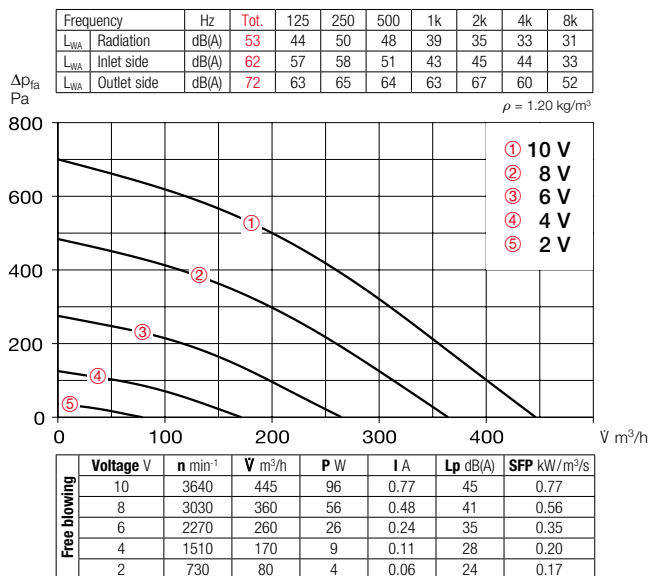

Reference

The integration of air filters ELF-ALB 125 F7 (ISO ePM₁, 50%) and differential pressure switches DDS (accessories) in outdoor installation fulfils the requirements of VDI 6022.

Reference

Planning information 10 ff.

Other accessories

Silencers 486 ff.
Flexible ventilation ducts, ventilation grilles, fittings, shutters, 576 ff.
Supply air disc valves

Accessories

Replacement and pollen filter

Large cassette filter for long cleaning intervals.

Unit = 3 pcs.

– Filter class ISO ePM_{2.5} 60% (M5)

ELF-ALB 125 M5 No. 07231

– Filter class ISO ePM₁ 50% (F7)

ELF-ALB 125 F7 No. 07337



Differential pressure switch

DDS Ref. no. 00445

Adjustable normally closed / normally open contact for monitoring drops in pressure.

Room sensor – Temperature

TFR-ALB Ref. no. 40000

Room temperature sensor for surface installation.

Temperature range 0 – 30 °C

Protection category IP20

Dim. mm W 86 x H 86 x D 30

Weight approx. 0.1 kg



Flexible cross talk silencer

FSD 125 Ref. no. 00677

Made of aluminium pipe with double-sided plug-in connectors. Sound insulation lining 50 mm thick, installation length 1 m.

Surface-mounted casing incl. frame

ALB-APG Ref. no. 00134

Casing for surface-mounting of control element.

Dim. mm (W x H x D) 85 x 85 x 48.

Protection category IP20.



External wall cover grille

G 160 Ref. no. 00893

Made of plastic, white. For covering and insertion in round ventilation openings.

Plastic supply air disc valve

KTVZ 125 Ref. no. 02737

Made of plastic, for low and high flow velocities or resistances.



Metal supply air disc valve

MTVZ 125 Ref. no. 09605

Made of metal, for low and high flow velocities.

ALB EC 200 EH



Efficiency class

B

ALB EC 200 EH



Dimensions ALB EC 200 EH

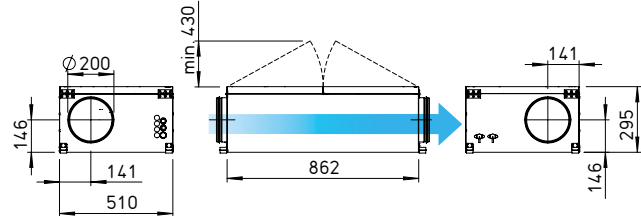

Dim. in mm

Application /Function
 Pleasant indoor climate through the addition of external fresh air which is filtered and automatically heated to the specified temperature.

Operational unit for connection to round duct systems. Suitable for a wide range of applications.

Description / Scope of delivery
 The air filter, fan, heater with controller and electrical terminal box are integrated in a compact flat casing which is thermally and acoustically insulated. Equipped as standard with a continuously variable, electronic heating controller and an external control unit for controlling the unit, as well as a connection cable (10 metres). Air quality, humidity and temperature sensors (see Accessories) can be connected to the electronics in the terminal box to control the specified setpoints.

Casing
 Robust construction made of galvanised steel sheet, 50 mm thick mineral wool lining on all sides, which is also covered with dirt-repellent glass fabric. The cover is easy to open with screw caps and hinge for cleaning purposes. Round duct connectors on inlet side and outlet side with sealing lips, adapted to standard duct Ø. No thermal bridges, smooth surface for easy cleaning.

Filter
 The large filter for long cleaning intervals is freely accessible by opening the casing cover. Standard version ISO ePM_{2.5} 60% (M5). Alternatively, filters with higher classifications ISO ePM₁ 50% (F7) (see accessories) can be used. The volume output reduction must be taken into account. Periodic filter inspection / cleaning is required. Equipment with automatic monitoring DDS (see Accessories) is recommended.

Fan
 The volume flow rate switching is continuously variable with the control unit. Low-noise and high performance centrifugal fan made of galvanised steel sheet. Motor/impeller unit freely accessible for servicing. Drive through energy-saving, speed-controllable EC motor with the highest level of efficiency. Maintenance-free, with lifetime lubricated ball bearings.

Heating element
 Enclosed sheathed heating elements made of stainless steel heat the intake air to the specified setpoint temperature. The electronic pulser continuously variably controls the heat output in constant comparison between the setpoint and the temperature measured by the room or duct sensor.

Turn-off delay
 The unit has a fixed turn-off delay time of approx. 2 minutes if the heating element has been activated.

Electrical connection
 Spacious terminal box inside the casing. Cable entry from the front of the unit through three cable glands and another four holes are provided.

Motor protection
 Deactivation when overheating is imminent. Automatic reactivation after cool down.

Noise
 The total level and range for the case-radiated sound power and outlet side sound power in dB(A) are specified above the performance diagram. In addition, the type table shows the radiated noise and outlet side air noise as sound pressure at 1 m (free field conditions). If necessary, a cross talk silencer (see Accessories) must be integrated in the duct system on site. The radiated noise as sound pressure level at 1 m (free field conditions) is additionally stated in the type table as well as in the table below the performance curve.

Control
 The control element is included in the delivery and offers the following functions:

- Operation with different volume flows.
- Weekly and seasonal timer.
- Temperature control (using room sensor, accessories).
- Control of electronic heating controller. Specification of min./max. temperature.
- Control of an EC extract air fan.
- Display of ambient temperature, outdoor temperature, supply air temperature, fan control and filter contamination (using differential pressure switch, accessories).

Other inputs and outputs:

- Emergency switch contact.
- Boost switch contact.
- Input for air quality or humidity sensor.
- Input for room temperature sensor.



Control element with connection cable (10 m) included in delivery. For flush-mounted installation. Dimensions mm (W x H) 82 x 82

Type	Ref. no.	Flow rate* free blowing	Max. speed	Freq.	Sound pressure level		Prot. category	Voltage	Power consumption	Current consump. max. tot.	Wiring diagram	Max. intake temp.	Weight net appr.
					Case-radiation	Air noise outlet side							
		V m³/h (max.)	min-1	Hz	dB(A) at 1m	dB(A) at 1m		Volt	kW	A	No.	+°C	kg
ALB EC 200 EH	06809	720	2910	50/60	44	66	IP44	400, 3N~	5.12	13.52	SS-1309	40	26

* Volume reduction by approx. 15% when using the filter ISO ePM₁ 50% (F7).

Performance curves ALB EC 200 EH

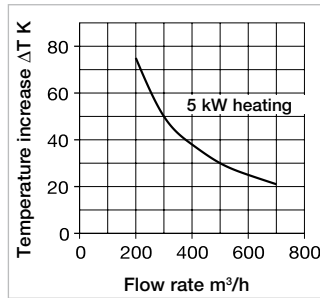
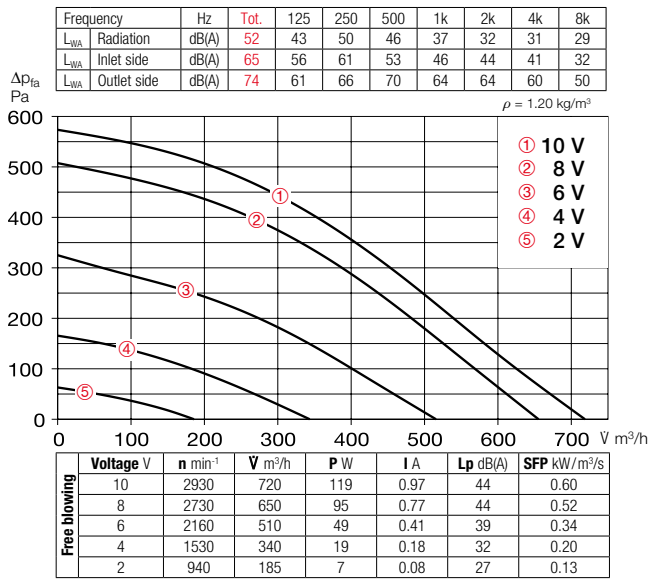

Reference

The integration of air filters ELF-ALB 125 F7 (ISO ePM₁, 50%) and differential pressure switches DDS (accessories) in outdoor installation fulfils the requirements of VDI 6022.

Reference

Planning information 10 ff.

Other accessories

Silencers 486 ff.
Flexible ventilation ducts, ventilation grilles, fittings, shutters, 576 f.
Supply air disc valves

Accessories

Replacement and pollen filter

Large cassette filter for long cleaning intervals.

Unit = 3 pcs.

- Filter class ISO ePM_{2,5} 60% (M5)

ELF-ALB 200 M5 No. 07238

- Filter class ISO ePM₁ 50% (F7)

ELF-ALB 200 F7 No. 07266



Differential pressure switch

DDS Ref. no. 00445

Adjustable normally closed / normally open contact for monitoring drops in pressure.

Room sensor - Temperature

TFR-ALB Ref. no. 40000

Room temperature sensor for surface installation.

Temperature range 0 - 30 °C

Protection category IP20

Dim. mm W 86 x H 86 x D 30

Weight approx. 0.1 kg



Flexible cross talk silencer

FSD 200 Ref. no. 00679

Made of aluminium pipe with double-sided plug-in connectors. Sound insulation lining 50 mm thick, installation length 1 m.

Surface-mounted casing incl. frame

ALB-APG Ref. no. 00134

Casing for surface-mounting of control element.

Dim. mm (W x H x D) 85 x 85 x 48.

Protection category IP20.



Duct shutter

RSK 200 Ref. no. 05074

Automatic, made of plastic.

Supply air disc valve

KTVZ 125 Ref. no. 02737

Made of plastic, for low and high flow velocities or resistances.



Supply air disc valve

MTVZ 200 Ref. no. 09607

Made of metal, for low and high flow velocities.

ALB EC 250 EH



Efficiency class

B

ALB EC 250 EH



Dimensions ALB EC 250 EH

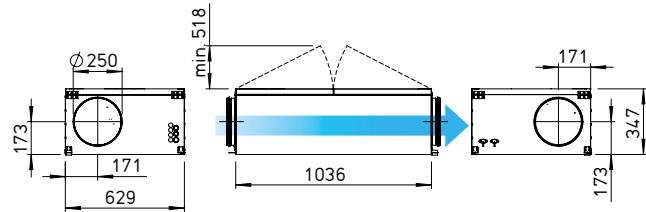

Dim. in mm

Application /Function
 Pleasant indoor climate through the addition of external fresh air which is filtered and automatically heated to the specified temperature.

Operational unit for connection to round duct systems. Suitable for a wide range of applications.

Description / Scope of delivery
 The air filter, fan, heater with controller and electrical terminal box are integrated in a compact flat casing which is thermally and acoustically insulated. Equipped as standard with a continuously variable, electronic heating controller and an external control unit for controlling the unit, as well as a connection cable (10 metres). Air quality, humidity and temperature sensors (see Accessories) can be connected to the electronics in the terminal box to control the specified setpoints.

Casing
 Robust construction made of galvanised steel sheet, 50 mm thick mineral wool lining on all sides, which is also covered with dirt-repellent glass fabric. The cover is easy to open with screw caps and hinge for cleaning purposes. Round duct connectors on inlet side and outlet side with sealing lips, adapted to standard duct Ø. No thermal bridges, smooth surface for easy cleaning.

Filter
 The large filter for long cleaning intervals is freely accessible by opening the casing cover. Standard version ISO ePM_{2.5} 60% (M5). Alternatively, filters with higher classifications ISO ePM₁, 50% (F7) (see accessories) can be used. The volume output reduction must be taken into account. Periodic filter inspection / cleaning is required. Equipment with automatic monitoring DDS (see Accessories) is recommended.

Fan
 The volume flow rate switching is continuously variable with the control unit. Low-noise and high performance centrifugal fan made of galvanised steel sheet. Motor/impeller unit freely accessible for servicing. Drive through energy-saving, speed-controllable EC motor with the highest level of efficiency. Maintenance-free, with lifetime lubricated ball bearings.

Heating element
 Enclosed sheathed heating elements made of stainless steel heat the intake air to the specified setpoint temperature. The electronic pulser continuously variably controls the heat output in constant comparison between the setpoint and the temperature measured by the room or duct sensor.

Turn-off delay
 The unit has a fixed turn-off delay time of approx. 2 minutes if the heating element has been activated.

Electrical connection
 Spacious terminal box inside the casing. Cable entry from the front of the unit through three cable glands and another four holes are provided.

Motor protection
 Deactivation when overheating is imminent. Automatic reactivation after cool down.

Noise
 The total level and range for the case-radiated sound power and outlet side sound power in dB(A) are specified above the performance diagram. In addition, the type table shows the radiated noise and outlet side air noise as sound pressure at 1 m (free field conditions). If necessary, a cross talk silencer (see Accessories) must be integrated in the duct system on site. The radiated noise as sound pressure level at 1 m (free field conditions) is additionally stated in the type table as well as in the table below the performance curve.

Control
 The control element is included in the delivery and offers the following functions:

- Operation with different volume flows.
- Weekly and seasonal timer.
- Temperature control (using room sensor, accessories).
- Control of electronic heating controller. Specification of min./max. temperature.
- Control of an EC extract air fan.
- Display of ambient temperature, outdoor temperature, supply air temperature, fan control and filter contamination (using differential pressure switch, accessories).

Other inputs and outputs:

- Emergency switch contact.
- Boost switch contact.
- Input for air quality or humidity sensor.
- Input for room temperature sensor.



Control element with connection cable (10 m) included in delivery. For flush-mounted installation. Dimensions mm (W x H) 82 x 82

Type	Ref. no.	Flow rate* free blowing	Max. speed	Freq.	Sound pressure level		Prot. category	Voltage	Power consumption	Current consump. max. tot.	Wiring diagram	Max. intake temp.	Weight net appr.
					Case-radiation	Air noise outlet side							
		V m³/h (max.)	min-1	Hz	dB(A) at 1m	dB(A) at 1m		Volt	kW	A	No.	+°C	kg
ALB EC 250 EH	06818	1010	2810	50/60	41	63	IP44	400, 3N~	5.15	13.73	SS-1309	40	36

* Volume reduction by approx. 15% when using the filter ISO ePM₁, 50% (F7).

Performance curves ALB EC 250 EH

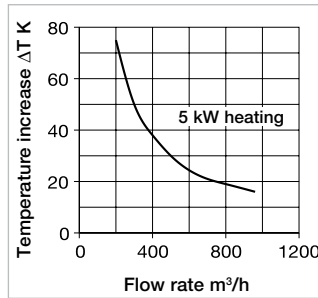
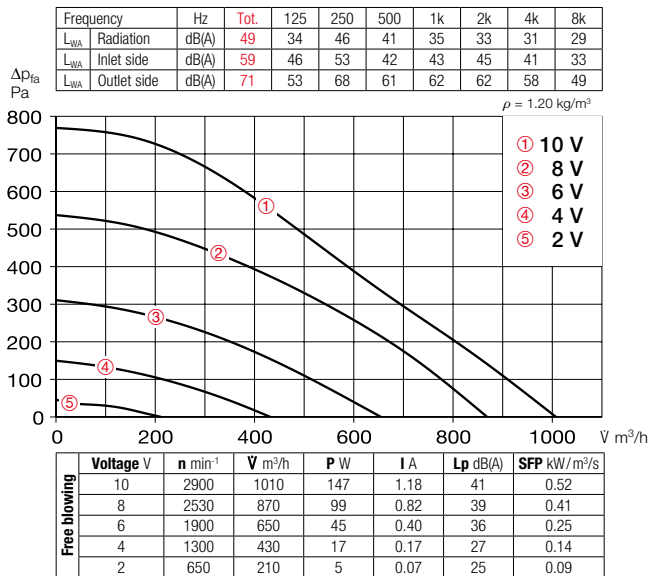

Reference
The integration of air filters ELF-ALB 125 F7 (ISO ePM₁ 50%) and differential pressure switches DDS (accessories) in outdoor installation fulfils the requirements of VDI 6022.

Reference **Page**
Planning information 10 ff.

Other accessories **Page**
Silencers 486 ff.
Flexible ventilation ducts, ventilation grilles, fittings, shutters, Supply air disc valves 576 f.

Accessories

Replacement and pollen filter
Large cassette filter for long cleaning intervals.
Unit = 3 pcs.
– Filter class ISO ePM_{2.5} 60% (M5)
ELF-ALB 250 M5 No. 07294
– Filter class ISO ePM₁ 50% (F7)
ELF-ALB 250 F7 No. 07305



Differential pressure switch DDS Ref. no. 00445
Adjustable normally closed / normally open contact for monitoring drops in pressure.

Room sensor – Temperature TFR-ALB Ref. no. 40000
Room temperature sensor for surface installation.
Temperature range 0 – 30 °C
Protection category IP20
Dim. mm W 86 x H 86 x D 30
Weight approx. 0.1 kg



Flexible cross talk silencer FSD 250 Ref. no. 00680
For structure-borne noise-free connection of fan and piping and for suspension (1 set = 2 pcs).

Surface-mounted casing incl. frame ALB-APG Ref. no. 00134
Casing for surface-mounting of control element.
Dim. mm (W x H x D) 85 x 85 x 48.
Protection category IP20.



Duct shutter RSK 250 Ref. no. 05673
Automatic, made of plastic.

External wall cover grille G 250 Ref. no. 00256
Made of plastic, white. For covering and insertion in round ventilation openings.



Automatic duct shutter RVS 250 Ref. no. 02592
With spring return, can be installed horizontally in any direction, vertically with throughflow from bottom to top. Shutter opening in flow direction; automatic function through fan operation.

ALB EC 30/20 EH



Dimensions ALB EC 30/20 EH

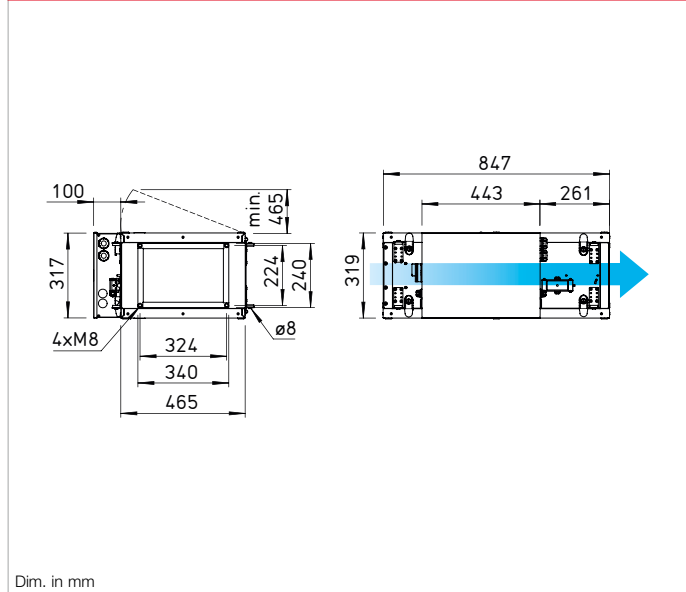

Dim. in mm

Application /Function
Pleasant indoor climate through the addition of external fresh air which is filtered and automatically heated to the specified temperature.

Operational unit for connection to rectangular duct systems. Suitable for a wide range of commercial applications.

Description/Scope of delivery
The air filter, fan and electric heating element are integrated in a compact flat casing which is thermally and acoustically insulated. The unit is delivered ready for connection and includes an external control unit for controlling the unit, as well as a connection cable (10 metres). Air quality, humidity and temperature sensors (see Accessories) can be connected to the electronics in the terminal box to control the specified setpoints.

Casing
Robust construction made of coated steel sheet, double-walled with 30 mm thick mineral wool lining. The cover is easy to open with screw caps and hinge for cleaning purposes. Rectangular duct connectors on inlet and outlet side, adapted to standard rectangular duct dimensions. No thermal bridges, smooth surface for easy cleaning.

Filter
The large filter for long cleaning intervals is freely accessible by opening the casing cover. Standard version ISO Coarse 90% (G4). Alternatively, filters with higher classifications ISO ePM₁₀ 70% (M5) or ISO ePM₁ 50% (F7) (see accessories) can be used. The volume output reduction must be taken into account. Periodic filter inspection /cleaning is required. A filter monitoring system is integrated. The requirements of VDI 6022 are fulfilled through the integration of a ISO ePM₁ 50% filter.

Fan
The volume flow rate switching is continuously variable with the control unit. Low-noise and high performance centrifugal fan made of galvanised steel sheet. Motor/impeller unit freely accessible for servicing. Drive through energy-saving, speed-controllable EC motor with the highest level of efficiency. Maintenance-free, with lifetime lubricated ball bearings.

Heating element
The electric heating element made of stainless steel with low surface temperature heats the intake air to the specified setpoint temperature. Control via the integrated control board.

The setpoint and the temperature measured by the room sensor (accessories) are constantly compared. The electric heating element is equipped with an automatic safety temperature limiter (+ 50 °C) and a manually resettable safety temperature limiter (+ 115 °C).

Electrical connection
Spacious terminal box in IP20 on outside of casing

Motor protection
Deactivation when overheating is imminent. Automatic reactivation after cool down.

Noise
The type table shows the radiated noise and outlet side air noise as sound pressure at 1 m (free field conditions). If necessary, a cross talk silencer (see Accessories) must be integrated in the duct system on site. The radiated noise as sound pressure level at 1 m (free field conditions) is additionally stated in the type table as well as in the table below the performance curve.

Control
The control element is included in the delivery and offers the following functions:

- Operation with different volume flows.
- Weekly and seasonal timer.
- Temperature control (using room sensor, accessories).
- Control of an EC extract air fan.
- Display of ambient temperature, fan control and filter contamination.

Other inputs and outputs:

- Emergency switch contact.
- Boost switch contact.
- External switch.
- Input for air quality or humidity sensor.
- Input for room temperature sensor.
- Output for shutter control.



Control element with connection cable (10 m) included in delivery. Dimensions mm (W x H x D) 115 x 80 x 25

Type	Ref. no.	Flow rate* free blowing V m³/h (max.)	Max. speed min-1	Sound pressure level		Voltage 50/60 Hz Volt	Power consump.		Current consump. max. tot. A	Wiring diagram No.	Maximum intake temp. +°C	Weight net aprx. kg
				Case-radiation dB(A) at 1m	Air noise outlet side dB(A) at 1m		Motor kW	Heating kW				
ALB EC 30/20 EH	06538	720	3900	49	69	230, 1~	0.12	6.60	10.4	1371	40	36

* Volume reduction by approx. 5% when using the filter ISO ePM₁₀ 50% (M5), by approx. 15% when using the filter ISO ePM₁ 50% (F7).

Performance curves ALB EC 30/20 EH

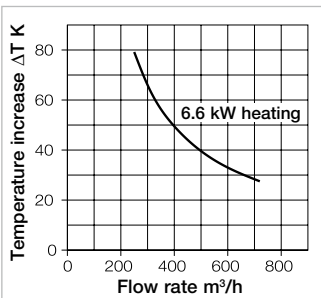
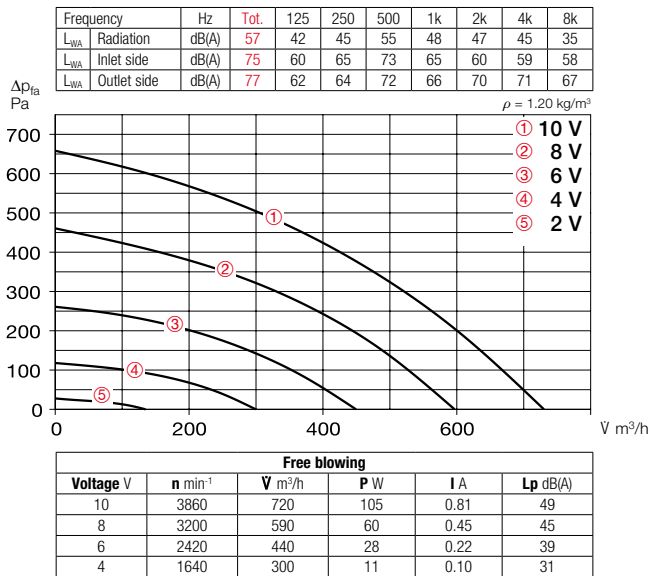

Reference

The integration of air filters ELF-ALB 30/20 F7 (ISO ePM₁, 50% (F7)) in intake air systems fulfils the requirements of VDI 6022.

Reference

Reference	Page
Planning information	10 ff.

Other accessories

Other accessories	Page
Silencers	486 ff.
Flexible ventilation ducts, ventilation grilles, fittings, shutters,	
Supply air disc valves	576 f.

Accessories

Replacement and pollen filter

- ISO Coarse 90% (G4)
- ELF-ALB 30/20 G4** No. 07284
- Filter class ISO ePM₁₀ 70% (M5)
- ELF-ALB 30/20 M5** No. 07285
- Filter class ISO ePM₁ 50% (F7)
- ELF-ALB 30/20 F7** No. 07319

Large cassette filter for long cleaning intervals. Unit = 3 pcs.



Room sensor – Air quality

- AIR1/KWL-CO2 0-10V** No. 20251
- AIR1/KWL-FTF 0-10V** No. 20252

For measuring the CO₂ concentration or relative room humidity. Maximum total of one sensor can be connected.

Dim. mm (W x H x D) 85 x 85 x 27



Room sensor – Temperature

- TFR-ALB/KWL** Ref. no. 07277

For measuring the room temperature and controlling the ventilation unit according to the setpoint.

Incl. 20 m control line.

Dim. mm (W x H x D) 80 x 80 x 25



Connection cable

- 20 metres long
- ALB EC-SK 20** Ref. no. 06816
- 40 metres long
- ALB EC-SK 40** Ref. no. 06817

Attach between ALB and control element as well as between ALB and TFR-ALB/KWL.



Transition piece – Symmetrical

- KWL-ÜS 700 D** Ref. no. 04206

From unit flange to round duct systems.

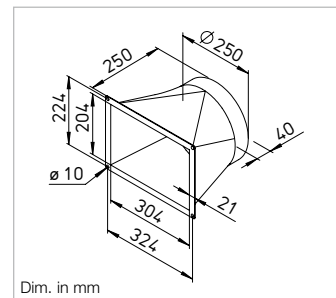

Flexible connecting sleeve

- FM 250** Ref. no. 01672

For acoustic decoupling, incl. 2 pcs. hose clamps.

Angle flange ring

- FR 250** Ref. no. 01203

Made of galvanised steel sheet, for duct connection.

Duct shutter, motorised

- RVM 250** Ref. no. 02576

Prevents cold draughts when the unit is at a standstill. Automatic function through fan operation, with mounted spring return motor. Installation in any position, closing force adjustable corresponding to fan power and installation position.



EC box fans

ALB EC 40/20 WW



Dimensions ALB EC 40/20 WW

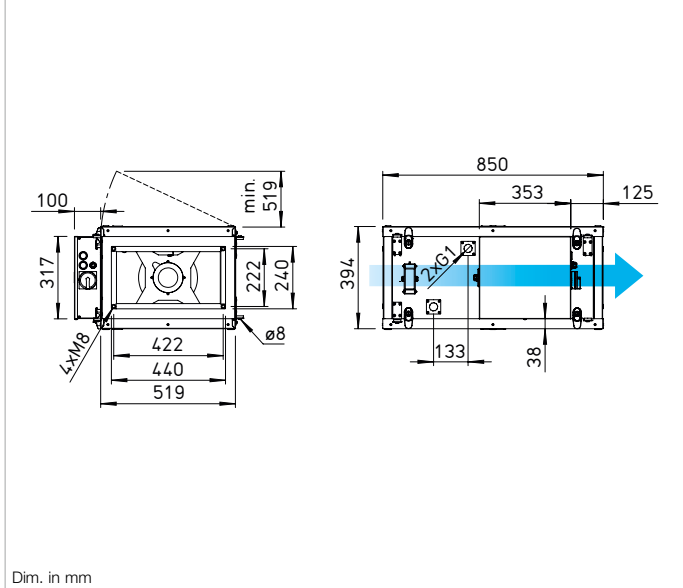

Application /Function
Pleasant indoor climate through the addition of external fresh air which is filtered and automatically heated to the specified temperature.

Operational unit for connection to rectangular duct systems. Suitable for a wide range of commercial applications.

Description/Scope of delivery

The air filter, fan and warm water heater are integrated in a compact flat casing which is thermally and acoustically insulated. The unit is delivered ready for connection and includes an external control unit for controlling the unit, as well as a connection cable (10 metres). Air quality, humidity and temperature sensors (see Accessories) can be connected to the electronics in the terminal box to control the specified setpoints. In order to prevent frost damage to the unit, a shutter (see Accessories) is essential.

Casing

Robust construction made of coated steel sheet, double-walled with 30 mm thick mineral wool lining. The cover is easy to open with screw caps and hinge for cleaning purposes. Rectangular duct connectors on inlet side and outlet side, adapted to standard rectangular duct dimensions. No thermal bridges, smooth surface for easy cleaning.

Filter

The large filter for long cleaning intervals is freely accessible by opening the casing cover. Standard version ISO Coarse 90% (G4). Alternatively, filters with higher classifications ISO ePM₁₀ 70% (M5) or ISO ePM₁ 50% (F7) (see accessories) can be used. The volume output reduction must be taken into account. Periodic filter inspection /cleaning is required. A filter monitoring system is integrated. The filters comply with VDI 6022.

Fan

The volume flow rate switching is continuously variable with the control unit. Low-noise and high performance centrifugal fan made of galvanised steel sheet. Motor/impeller unit freely accessible for servicing. Drive through energy-saving, speed-controllable EC motor with the highest level of efficiency. Maintenance-free, with lifetime lubricated ball bearings.

Heating element

Air heater with AL blades and staggered copper pipes heat the intake air to the specified setpoint temperature. Control through connection of a hydraulic unit (accessories) via the integrated control board. The setpoint and the temperature measured by the room sensor (accessories) are constantly compared.

A frost protection circuit is integrated as standard. Max. operating pressure 1.6 MPa. Water connection pipes with external thread.

Electrical connection

Spacious terminal box in IP20 on outside of casing.

Motor protection

Deactivation when overheating is imminent. Automatic reactivation after cool down.

Noise

The type table shows the radiated noise and outlet side air noise as sound pressure at 1 m (free field conditions). If necessary, a cross talk silencer (see Accessories) must be integrated in the duct system on site. The radiated noise as sound pressure level at 1 m (free field conditions) is additionally stated in the type table as well as in the table below the performance curve.

Control

The control element is included in the delivery and offers the following functions:

- Operation with different volume flows.
- Weekly and seasonal timer.
- Temperature control (using room sensor, accessories).
- Frost protection.
- Control of hydraulic unit (accessories) to control the WW heating element. Specification of min./max. temperature.
- Control of an EC extract air fan.

- Display of ambient temperature, fan control and filter contamination.

Other inputs and outputs:

- Emergency switch contact.
- Boost switch contact.
- External switch.
- Input for air quality or humidity sensor.
- Input for room temperature sensor.
- Output for shutter control.



Type	Ref. no.	Flow rate* free blowing V m ³ /h (max.)	Max. speed min-1	Sound pressure level		Voltage 50/60 Hz Volt	Power consump.		Current consump. max. tot. A	Wiring diagram No.	Maximum intake temp. +°C	Weight net aprx. kg
				Case-radiation dB(A) at 1m	Air noise outlet side dB(A) at 1m		Motor kW	Heating kW				
ALB EC 40/20 WW	06533	1100	2900	52	73	230, 1~	0.15	-	1.09	1371	40	37

* Volume reduction by approx. 5% when using the filter ISO ePM₁₀ 50% (M5), by approx. 15% when using the filter ISO ePM₁ 50% (F7).

Performance curves ALB EC 40/20 WW

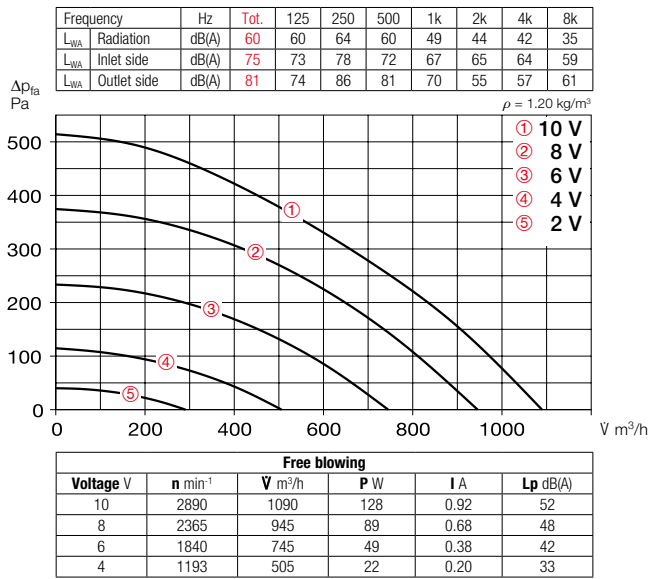

- Heat output WW element ①-③
These diagrams show the heat output depending on the flow/return/outside temp. over the air volume.
- Water volume WW element ④
shows the water flow rate depending on the flow/return/outside temp. over the air volume.
- Pressure loss WW element ⑤
shows the water throughflow over water pressure loss kPa.

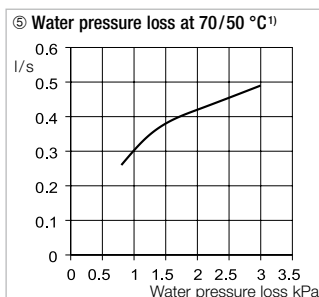
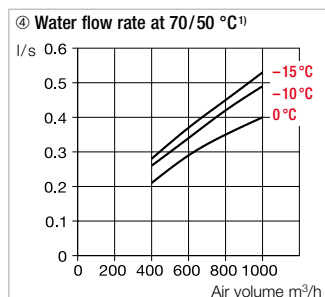
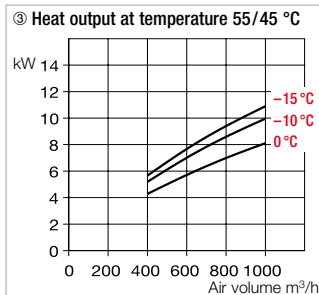
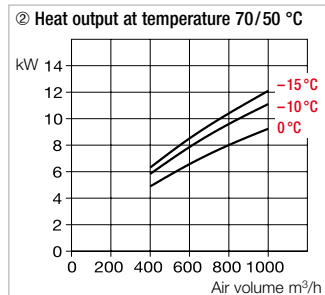
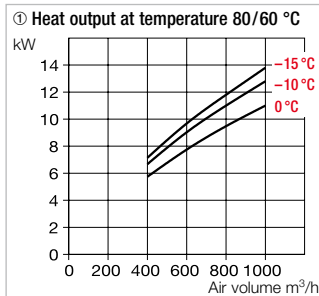

¹⁾ Correction factor for 80/50 °C: 1.16; for 55/45 °C: 1.81.

Reference

The integration of air filters ELF-ALB 40/20 F7 (ISO ePM₁ 50% (F7)) in intake air systems fulfils the requirements of VDI 6022.

Reference	Page
Planning information	10 ff.

Other accessories Page

Silencers	486 ff.
Hydraulic unit details	484 ff.
Flexible ventilation ducts, ventilation grilles, fittings, shutters	553 ff.
Supply air disc valves	576 f.

Accessories

Hydraulic unit

WHSH HE 24 V (0-10V) No. 08318

For controlling the heat output of the warm water heating element in combination with room/duct sensors. Includes flow/return temperature display, pump, actuator, mixer valve, gravity brake, thermal cladding and flexible connection hoses.



Replacement and pollen filter

- ISO Coarse 90% (G4)

ELF-ALB 40/20 G4 No. 07619

- Filter class ISO ePM₁₀ 70% (M5)

ELF-ALB 40/20 M5 No. 06766

- Filter class ISO ePM₁ 50% (F7)

ELF-ALB 40/20 F7 No. 06767

Large cassette filter for long cleaning intervals.

Unit = 3 pcs.



Room sensor - Air quality

AIR1/KWL-CO2 0-10V No. 20251

AIR1/KWL-FTF 0-10V No. 20252

For measuring the CO₂ concentration or relative room humidity.

Maximum total of one sensor can be connected.

Dim. mm (W x H x D) 85 x 85 x 27



Room sensor - Temperature

TFR-ALB/KWL Ref. no. 07277

For measuring the room temperature and controlling the ventilation unit according to the setpoint.

Incl. 20 m control line.

Dim. mm (W x H x D) 80 x 80 x 25



Connection cable

- 20 metres long

ALB EC-SK 20 Ref. no. 06816

- 40 metres long

ALB EC-SK 40 Ref. no. 06817

Attach between ALB and control element as well as between ALB and TFR-ALB/KWL.

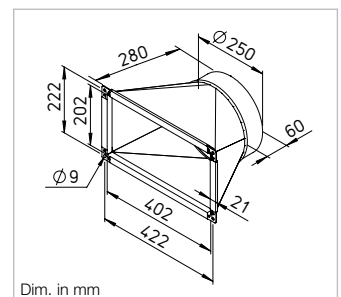

Transition piece - Symmetrical

ALB-ÜS 40/20 Ref. no. 07617

From unit flange to round duct systems.

Flexible connecting sleeve

FM 250 Ref. no. 01672

For acoustic decoupling, incl. 2 pcs. hose clamps.

Angle flange ring

FR 250 Ref. no. 01203

Made of galvanised steel sheet, for duct connection.



Duct shutter, motorised

RVM 250 Ref. no. 02576

Prevents cold draughts when the unit is at a standstill. Automatic function through fan operation, with mounted spring return motor. Installation in any position, closing force adjustable corresponding to fan power and installation position.

ALB EC 50/30 WW



Dimensions ALB EC 50/30 WW

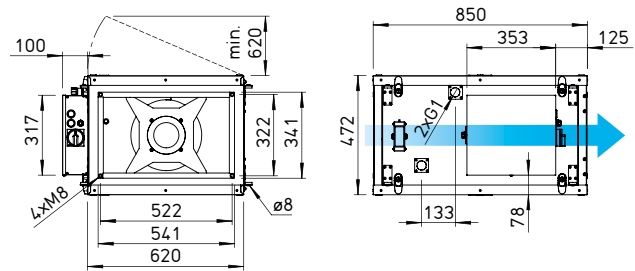

Dim. in mm

Application /Function
Pleasant indoor climate through the addition of external fresh air which is filtered and automatically heated to the specified temperature.

Operational unit for connection to rectangular duct systems. Suitable for a wide range of commercial applications.

Description/Scope of delivery

The air filter, fan and warm water heater are integrated in a compact flat casing which is thermally and acoustically insulated. The unit is delivered ready for connection and includes an external control unit for controlling the unit, as well as a connection cable (10 metres). Air quality, humidity and temperature sensors (see Accessories) can be connected to the electronics in the terminal box to control the specified setpoints. In order to prevent frost damage to the unit, a shutter (see Accessories) is essential.

Casing

Robust construction made of coated steel sheet, double-walled with 30 mm thick mineral wool lining. The cover is easy to open with screw caps and hinge for cleaning purposes. Rectangular duct connectors on inlet side and outlet side, adapted to standard rectangular duct dimensions. No thermal bridges, smooth surface for easy cleaning.

Filter

The large filter for long cleaning intervals is freely accessible by opening the casing cover. Standard version ISO Coarse 90% (G4). Alternatively, filters with higher classifications ISO ePM₁₀ 70% (M5) or ISO ePM₁ 50% (F7) (see accessories) can be used. The volume output reduction must be taken into account. Periodic filter inspection /cleaning is required. A filter monitoring system is integrated. The filters comply with VDI 6022.

Fan

The volume flow rate switching is continuously variable with the control unit. Low-noise and high performance centrifugal fan made of galvanised steel sheet. Motor/impeller unit freely accessible for servicing. Drive through energy-saving, speed-controllable EC motor with the highest level of efficiency. Maintenance-free, with lifetime lubricated ball bearings.

Heating element

Air heater with AL blades and staggered copper pipes heat the intake air to the specified setpoint temperature. Control through connection of a hydraulic unit (accessories) via the integrated control board. The setpoint and the temperature measured by the room sensor (accessories) are constantly compared.

A frost protection circuit is integrated as standard. Max. operating pressure 1.6 MPa. Water connection pipes with external thread.

Electrical connection

Spacious terminal box in IP20 on outside of casing.

Motor protection

Deactivation when overheating is imminent. Automatic reactivation after cool down.

Noise

The type table shows the radiated noise and outlet side air noise as sound pressure at 1 m (free field conditions). If necessary, a cross talk silencer (see Accessories) must be integrated in the duct system on site. The radiated noise as sound pressure level at 1 m (free field conditions) is additionally stated in the type table as well as in the table below the performance curve.

Control

The control element is included in the delivery and offers the following functions:

- Operation with different volume flows.
- Weekly and seasonal timer.
- Temperature control (using room sensor, accessories).
- Frost protection.
- Control of hydraulic unit (accessories) to control the WW heating element. Specification of min./max. temperature.
- Control of an EC extract air fan.

- Display of ambient temperature, fan control and filter contamination.

Other inputs and outputs:

- Emergency switch contact.
- Boost switch contact.
- External switch.
- Input for air quality or humidity sensor.
- Input for room temperature sensor.
- Output for shutter control.



Control element with connection cable (10 m) included in delivery. Dimensions mm (W x H x D) 115 x 80 x 25

Type	Ref. no.	Flow rate* free blowing V m ³ /h (max.)	Max. speed min-1	Sound pressure level		Voltage 50/60 Hz Volt	Power consump.		Current consump. max. tot. A	Wiring diagram No.	Maximum intake temp. +°C	Weight net aprx. kg
				Case-radiation dB(A) at 1m	Air noise outlet side dB(A) at 1m		Motor kW	Heating kW				
ALB EC 40/20 WW	06534	2100	2600	57	74	230, 1~	0.47	-	2.90	1371	40	55

* Volume reduction by approx. 5% when using the filter ISO ePM₁₀ 50% (M5), by approx. 15% when using the filter ISO ePM₁ 50% (F7).

Performance curves ALB EC 50/30 WW

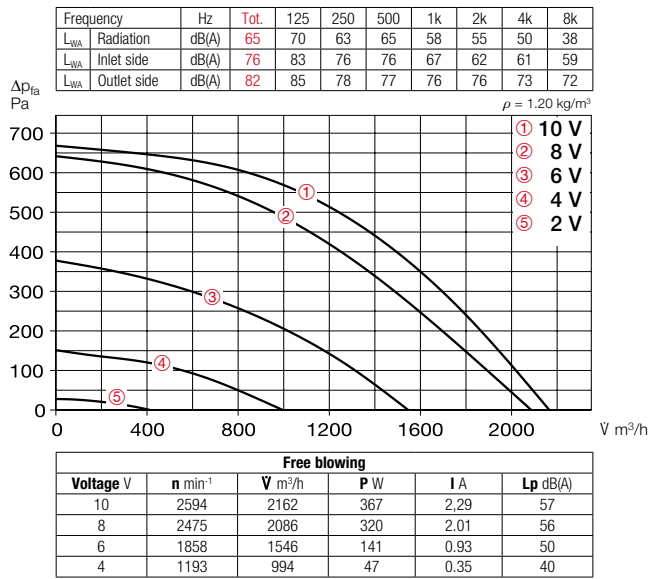

- Heat output WW element ①-③
These diagrams show the heat output depending on the flow/return/outside temp. over the air volume.
- Water volume WW element ④
shows the water flow rate depending on the flow/return/outside temp. over the air volume.
- Pressure loss WW element ⑤
shows the water throughflow over water pressure loss kPa.

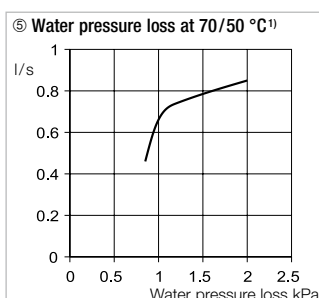
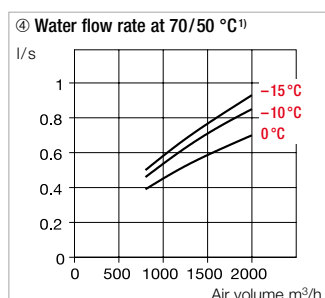
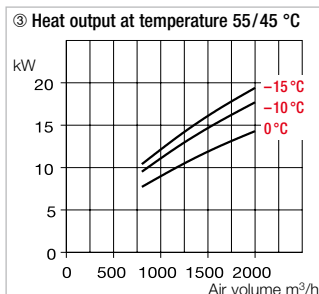
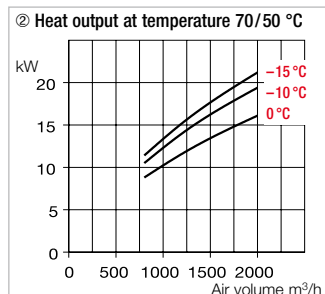
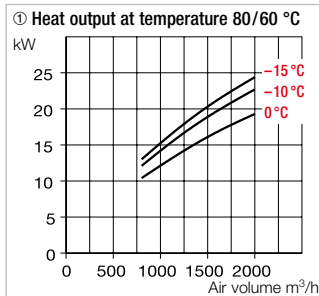

¹⁾ Correction factor for 80/50 °C: 1.16; for 55/45 °C: 1.81.

Reference

The integration of air filters ELF-ALB 50/30 F7 (ISO ePM₁ 50% (F7)) in intake air systems fulfils the requirements of VDI 6022.

Reference	Page
Planning information	10 ff.

Other accessories Page

Silencers	486 ff.
Hydraulic unit details	484 ff.
Flexible ventilation ducts, ventilation grilles, fittings, shutters	553 ff.
Supply air disc valves	576 f.

Accessories

Hydraulic unit

WHSH HE 24 V (0-10V) No. 08318

For controlling the heat output of the warm water heating element in combination with room/duct sensors. Includes flow/return temperature display, pump, actuator, mixer valve, gravity brake, thermal cladding and flexible connection hoses.



Replacement and pollen filter

- ISO Coarse 90% (G4)

ELF-ALB 220/4/50/30 G4 No. 03646

- Filter class ISO ePM₁₀ 70% (M5)

ELF-ALB 220/4/50/30 M5 No. 03647

- Filter class ISO ePM₁ 50% (F7)

ELF-ALB 220/4/50/30 F7 No. 03648

Large cassette filter for long cleaning intervals.

Unit = 3 pcs.



Room sensor - Air quality

AIR1/KWL-FTF 0-10V No. 20252

For measuring the relative room humidity. Maximum total of one sensor can be connected.

Dim. mm (W x H x D) 85 x 85 x 27



Room sensor - Temperature

TFR-ALB/KWL Ref. no. 07277

For measuring the room temperature and controlling the ventilation unit according to the setpoint.

Incl. 20 m control line.

Dim. mm (W x H x D) 80 x 80 x 25



Connection cable

- 20 metres long

ALB EC-SK 20 Ref. no. 06816

- 40 metres long

ALB EC-SK 40 Ref. no. 06817

Attach between ALB and control element as well as between ALB and TFR-ALB/KWL.

Transition piece - Symmetrical

ALB-ÜS 220/4/50/30 No. 07515

From unit flange to round duct systems.

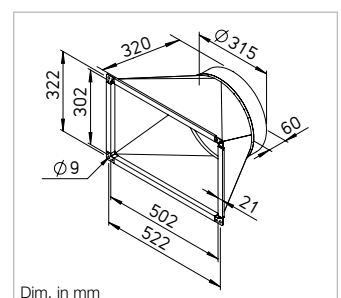

Flexible connecting sleeve

FM 315 Ref. no. 01674

For acoustic decoupling, incl. 2 pcs. hose clamps.

Angle flange ring

FR 315 Ref. no. 01204

Made of galvanised steel sheet, for duct connection.

Duct shutter, motorised

RVM 315 Ref. no. 02578

Prevents cold draughts when the unit is at a standstill. Automatic function through fan operation, with mounted spring return motor. Installation in any position, closing force adjustable corresponding to fan power and installation position.



ALB EC 60/35 WW



Dimensions ALB EC 60/35 WW

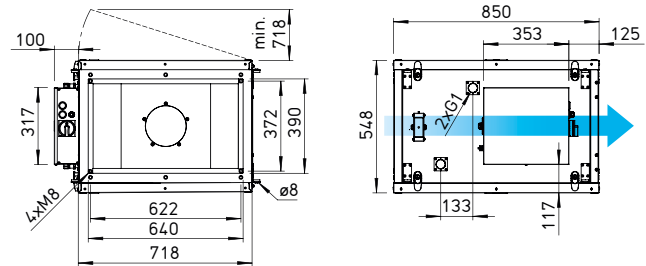

Dim. in mm

Application /Function
Pleasant indoor climate through the addition of external fresh air which is filtered and automatically heated to the specified temperature.

Operational unit for connection to rectangular duct systems. Suitable for a wide range of commercial applications.

Description/Scope of delivery

The air filter, fan and warm water heater are integrated in a compact flat casing which is thermally and acoustically insulated. The unit is delivered ready for connection and includes an external control unit for controlling the unit, as well as a connection cable (10 metres). Air quality, humidity and temperature sensors (see Accessories) can be connected to the electronics in the terminal box to control the specified setpoints. In order to prevent frost damage to the unit, a shutter (see Accessories) is essential.

Casing

Robust construction made of coated steel sheet, double-walled with 30 mm thick mineral wool lining. The cover is easy to open with screw caps and hinge for cleaning purposes. Rectangular duct connectors on inlet side and outlet side, adapted to standard rectangular duct dimensions. No thermal bridges, smooth surface for easy cleaning.

Filter

The large filter for long cleaning intervals is freely accessible by opening the casing cover. Standard version ISO Coarse 90% (G4). Alternatively, filters with higher classifications ISO ePM₁₀ 70% (M5) or ISO ePM₁ 50% (F7) (see accessories) can be used. The volume output reduction must be taken into account. Periodic filter inspection /cleaning is required. A filter monitoring system is integrated. The filters comply with VDI 6022.

Fan

The volume flow rate switching is continuously variable with the control unit. Low-noise and high performance centrifugal fan made of galvanised steel sheet. Motor/impeller unit freely accessible for servicing. Drive through energy-saving, speed-controllable EC motor with the highest level of efficiency. Maintenance-free, with lifetime lubricated ball bearings.

Heating element

Air heater with AL blades and staggered copper pipes heat the intake air to the specified setpoint temperature. Control through connection of a hydraulic unit (accessories) via the integrated control board. The setpoint and the temperature measured by the room sensor (accessories) are constantly compared.

A frost protection circuit is integrated as standard. Max. operating pressure 1.6 MPa. Water connection pipes with external thread.

Electrical connection

Spacious terminal box in IP20 on outside of casing.

Motor protection

Deactivation when overheating is imminent. Automatic reactivation after cool down.

Noise

The type table shows the radiated noise and outlet side air noise as sound pressure at 1 m (free field conditions). If necessary, a cross talk silencer (see Accessories) must be integrated in the duct system on site. The radiated noise as sound pressure level at 1 m (free field conditions) is additionally stated in the type table as well as in the table below the performance curve.

Control

The control element is included in the delivery and offers the following functions:

- Operation with different volume flows.
- Weekly and seasonal timer.
- Temperature control (using room sensor, accessories).
- Frost protection.
- Control of hydraulic unit (accessories) to control the WW heating element. Specification of min./max. temperature.
- Control of an EC extract air fan.

- Display of ambient temperature, fan control and filter contamination.

Other inputs and outputs:

- Emergency switch contact.
- Boost switch contact.
- External switch.
- Input for air quality or humidity sensor.
- Input for room temperature sensor.
- Output for shutter control.



Control element with connection cable (10 m) included in delivery. Dimensions mm (W x H x D) 115 x 80 x 25

Type	Ref. no.	Flow rate* free blowing V m ³ /h (max.)	Max. speed min-1	Sound pressure level		Voltage 50/60 Hz Volt	Power consump.		Current consump. max. tot. A	Wiring diagram No.	Maximum intake temp. +°C	Weight net aprx. kg
				Case-radiation dB(A) at 1m	Air noise outlet side dB(A) at 1m		Motor kW	Heating kW				
ALB EC 60/35 WW	06536	4070	2650	63	80	400, 3N~	1.03	-	1.90	1371	40	70

* Volume reduction by approx. 5% when using the filter ISO ePM₁₀ 50% (M5), by approx. 15% when using the filter ISO ePM₁ 50% (F7).

Performance curves ALB EC 60/35 WW

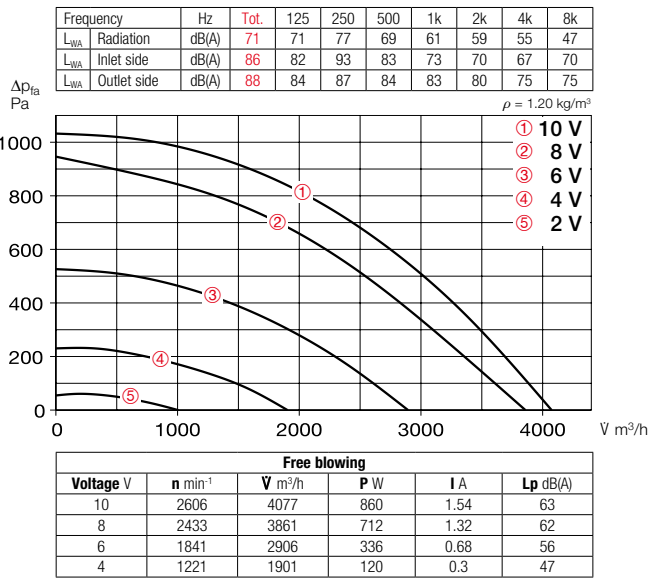

- Heat output WW element ①-③
These diagrams show the heat output depending on the flow/return/outside temp. over the air volume.
- Water volume WW element ④
shows the water flow rate depending on the flow/return/outside temp. over the air volume.
- Pressure loss WW element ⑤
shows the water throughflow over water pressure loss kPa.

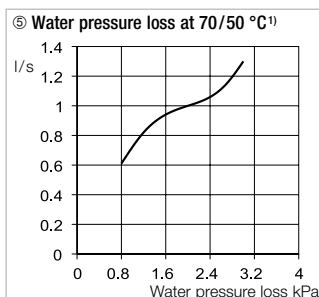
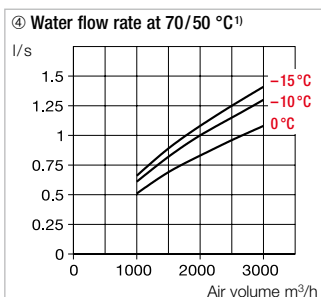
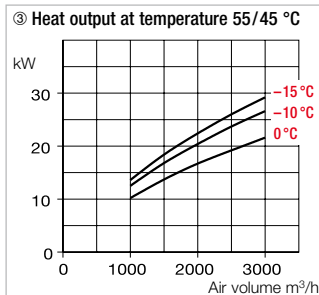
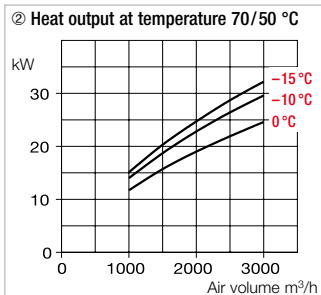
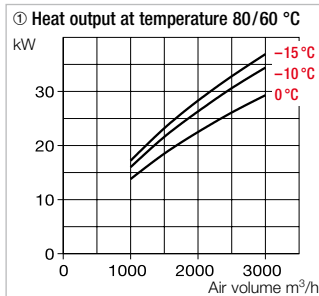

¹⁾ Correction factor for 80/50 °C: 1.16; for 55/45 °C: 1.81.

Reference

The integration of air filters ELF-ALB 60/35 F7 (ISO ePM₁ 50% (F7)) in intake air systems fulfils the requirements of VDI 6022.

Reference	Page
Planning information	10 ff.

Other accessories Page

Silencers	486 ff.
Hydraulic unit details	484 ff.
Flexible ventilation ducts, ventilation grilles, fittings, shutters	553 ff.
Supply air disc valves	576 f.

Accessories

Hydraulic unit

WHSH HE 24 V (0-10V) No. 08318

For controlling the heat output of the warm water heating element in combination with room/duct sensors. Includes flow/return temperature display, pump, actuator, mixer valve, gravity brake, thermal cladding and flexible connection hoses.



Replacement and pollen filter

- ISO Coarse 90% (G4)

ELF-ALB 280/4/60/35 G4 No. 03649

- Filter class ISO ePM₁₀ 70% (M5)

ELF-ALB 280/4/60/35 M5 No. 03650

- Filter class ISO ePM₁ 50% (F7)

ELF-ALB 280/4/60/35 F7 No. 03654

Large cassette filter for long cleaning intervals.

Unit = 3 pcs.



Room sensor - Air quality

AIR1/KWL-CO2 0-10V No. 20251

AIR1/KWL-FTF 0-10V No. 20252

For measuring the CO₂ concentration or relative room humidity. Maximum total of one sensor can be connected.

Dim. mm (W x H x D) 85 x 85 x 27



Room sensor - Temperature

TFR-ALB/KWL Ref. no. 07277

For measuring the room temperature and controlling the ventilation unit according to the setpoint.

Incl. 20 m control line.

Dim. mm (W x H x D) 80 x 80 x 25



Connection cable

- 20 metres long

ALB EC-SK 20 Ref. no. 06816

- 40 metres long

ALB EC-SK 40 Ref. no. 06817

Attach between ALB and control element as well as between ALB and TFR-ALB/KWL.

Transition piece - Symmetrical

ALB-ÜS 280/4/60/35 No. 07516

From unit flange to round duct systems.

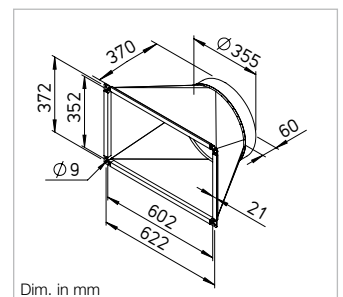

Flexible connecting sleeve

FM 355 Ref. no. 01675

For acoustic decoupling, incl. 2 pcs. hose clamps.

Angle flange ring

FR 355 Ref. no. 01205

Made of galvanised steel sheet, for duct connection.

Duct shutter, motorised

RVM 355 Ref. no. 02579

Prevents cold draughts when the unit is at a standstill. Automatic function through fan operation, with mounted spring return motor. Installation in any position, closing force adjustable corresponding to fan power and installation position.



ALB EC 80/50 WW



Dimensions ALB EC 80/50 WW

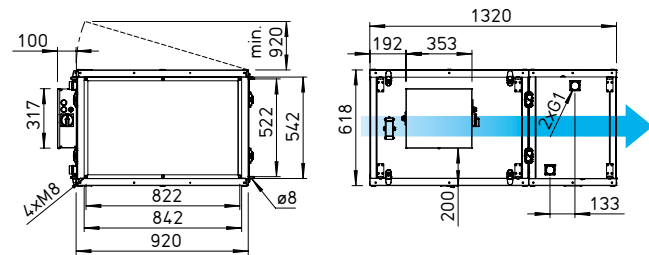

Dim. in mm

Application /Function
Pleasant indoor climate through the addition of external fresh air which is filtered and automatically heated to the specified temperature.

Operational unit for connection to rectangular duct systems. Suitable for a wide range of commercial applications.

Description/Scope of delivery

The air filter, fan and warm water heater are integrated in a compact flat casing which is thermally and acoustically insulated. The unit is delivered ready for connection and includes an external control unit for controlling the unit, as well as a connection cable (10 metres). Air quality, humidity and temperature sensors (see Accessories) can be connected to the electronics in the terminal box to control the specified setpoints. In order to prevent frost damage to the unit, a shutter (see Accessories) is essential.

Casing

Robust construction made of coated steel sheet, double-walled with 30 mm thick mineral wool lining. The cover is easy to open with screw caps and hinge for cleaning purposes. Rectangular duct connectors on inlet side and outlet side, adapted to standard rectangular duct dimensions. No thermal bridges, smooth surface for easy cleaning.

Filter

The large filter for long cleaning intervals is freely accessible by opening the casing cover. Standard version ISO Coarse 90% (G4). Alternatively, filters with higher classifications ISO ePM₁₀ 70% (M5) or ISO ePM₁ 50% (F7) (see accessories) can be used. The volume output reduction must be taken into account. Periodic filter inspection /cleaning is required. A filter monitoring system is integrated. The filters comply with VDI 6022.

Fan

The volume flow rate switching is continuously variable with the control unit. Low-noise and high performance centrifugal fan made of galvanised steel sheet. Motor/impeller unit freely accessible for servicing. Drive through energy-saving, speed-controllable EC motor with the highest level of efficiency. Maintenance-free, with lifetime lubricated ball bearings.

Heating element

Air heater with AL blades and staggered copper pipes heat the intake air to the specified setpoint temperature. Control through connection of a hydraulic unit (accessories) via the integrated control board. The setpoint and the temperature measured by the room sensor (accessories) are constantly compared.

A frost protection circuit is integrated as standard. Max. operating pressure 1.6 MPa. Water connection pipes with external thread.

Electrical connection

Spacious terminal box in IP20 on outside of casing.

Motor protection

Deactivation when overheating is imminent. Automatic reactivation after cool down.

Noise

The type table shows the radiated noise and outlet side air noise as sound pressure at 1 m (free field conditions). If necessary, a cross talk silencer (see Accessories) must be integrated in the duct system on site. The radiated noise as sound pressure level at 1 m (free field conditions) is additionally stated in the type table as well as in the table below the performance curve.

Control

The control element is included in the delivery and offers the following functions:

- Operation with different volume flows.
- Weekly and seasonal timer.
- Temperature control (using room sensor, accessories).
- Frost protection.
- Control of hydraulic unit (accessories) to control the WW heating element. Specification of min./max. temperature.

- Control of an EC extract air fan.
- Display of ambient temperature, fan control and filter contamination.

Other inputs and outputs:

- Emergency switch contact.
- Boost switch contact.
- External switch.
- Input for air quality or humidity sensor.
- Input for room temperature sensor.
- Output for shutter control.



Control element with connection cable (10 m) included in delivery. Dimensions mm (W x H x D) 115 x 80 x 25

Type	Ref. no.	Flow rate* free blowing V m³/h (max.)	Max. speed min-1	Sound pressure level		Voltage 50/60 Hz Volt	Power consump.		Current consump. max. tot. A	Wiring diagram No.	Maximum intake temp. +°C	Weight net aprx. kg
				Case-radiation dB(A) at 1m	Air noise outlet side dB(A) at 1m		Motor kW	Heating kW				
ALB EC 80/50 WW	06537	6200	2600	69	81	400, 3N~	1.91	-	2.90	1371	40	104

* Volume reduction by approx. 5% when using the filter ISO ePM₁₀ 50% (M5), by approx. 15% when using the filter ISO ePM₁ 50% (F7).

Performance curves ALB EC 80/50 WW

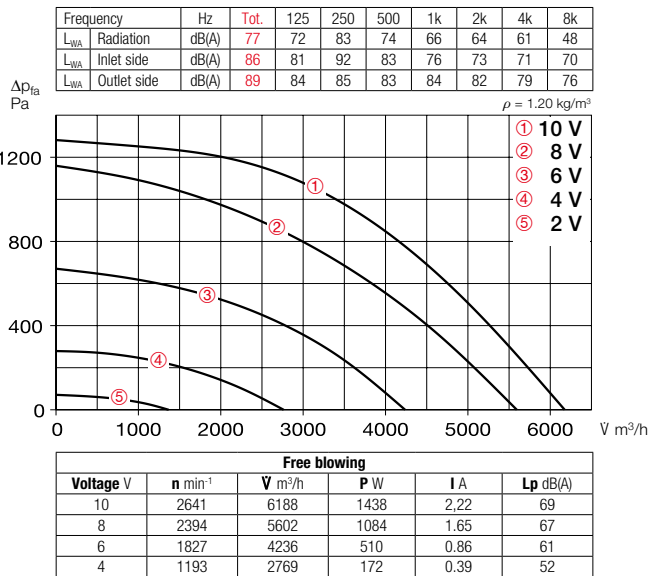

- Heat output WW element ①-③
These diagrams show the heat output depending on the flow/return/outside temp. over the air volume.
- Water volume WW element ④
shows the water flow rate depending on the flow/return/outside temp. over the air volume.
- Pressure loss WW element ⑤
shows the water throughflow over water pressure loss kPa.

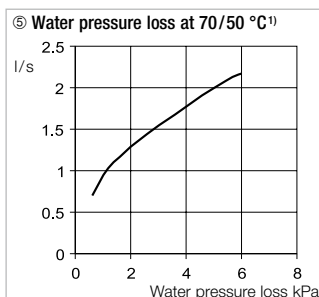
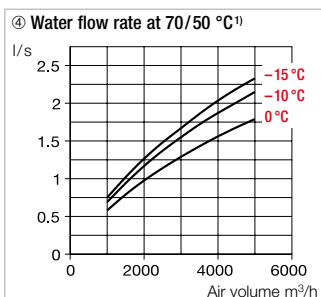
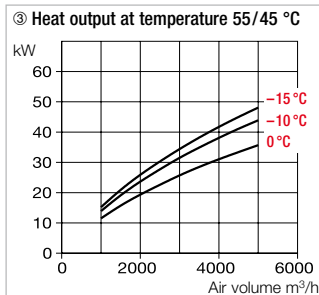
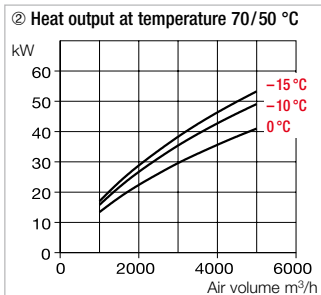
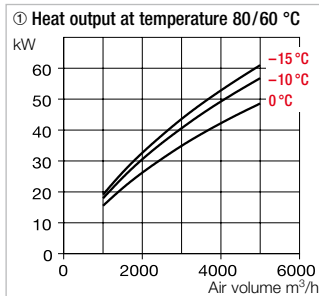

¹⁾ Correction factor for 80/50 °C: 1.16; for 55/45 °C: 1.81.

Reference

The integration of air filters ELF-ALB 80/50 F7 (ISO ePM₁ 50% (F7)) in intake air systems fulfils the requirements of VDI 6022.

Reference	Page
Planning information	10 ff.

Other accessories Page

Silencers	486 ff.
Hydraulic unit details	484 ff.
Flexible ventilation ducts, ventilation grilles, fittings, shutters	553 ff.
Supply air disc valves	576 f.

Accessories

Hydraulic unit

WHSH HE 24 V (0-10V) No. 08318

For controlling the heat output of the warm water heating element in combination with room/duct sensors. Includes flow/return temperature display, pump, actuator, mixer valve, gravity brake, thermal cladding and flexible connection hoses.



Replacement and pollen filter

- ISO Coarse 90% (G4)

ELF-ALB 80/50 G4 No. 06768

- Filter class ISO ePM₁₀ 70% (M5)

ELF-ALB 80/50 M5 No. 06769

- Filter class ISO ePM₁ 50% (F7)

ELF-ALB 80/50 F7 No. 06815

Large cassette filter for long cleaning intervals.

Unit = 3 pcs.



Room sensor - Air quality

AIR1/KWL-CO2 0-10V No. 20251

AIR1/KWL-FTF 0-10V No. 20252

For measuring the CO₂ concentration or relative room humidity. Maximum total of one sensor can be connected.

Dim. mm (W x H x D) 85 x 85 x 27



Room sensor - Temperature

TFR-ALB/KWL Ref. no. 07277

For measuring the room temperature and controlling the ventilation unit according to the setpoint.

Incl. 20 m control line.

Dim. mm (W x H x D) 80 x 80 x 25



Connection cable

- 20 metres long

ALB-EC-SK 20 Ref. no. 06816

- 40 metres long

ALB-EC-SK 40 Ref. no. 06817

Attach between ALB and control element as well as between ALB and TFR-ALB/KWL.

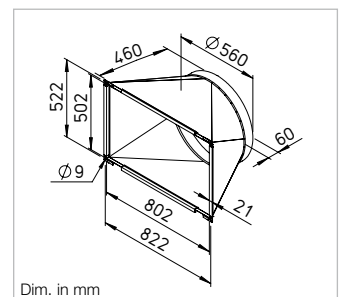

Transition piece - Symmetrical

ALB-ÜS 80/50 Ref. no. 07618

From unit flange to round duct systems.

Flexible connecting sleeve

FM 560 Ref. no. 01679

For acoustic decoupling, incl. 2 pcs. hose clamps.

Angle flange ring

FR 560 Ref. no. 01209

Made of galvanised steel sheet, for duct connection.



Duct shutter, motorised

RVM 560 Ref. no. 02583

Prevents cold draughts when the unit is at a standstill. Automatic function through fan operation, with mounted spring return motor. Installation in any position, closing force adjustable corresponding to fan power and installation position.

Helios circular duct fans. System solutions for your next project.

RSK Duct shutter
Prevents energy loss caused by unwanted draughts.

BM Pipe clamp connector
For structure-borne noise-free connection of fan and piping and for suspension.

Flat centrifugal round duct fan SV
Also available in Acoustic Line version (Type SVS) for lowest noise levels.

Centrifugal round duct fan RR and RRK
Also available as explosion-proof compact fans RRK Ex.

LFBR Air filter box
Large-surface, installation in round duct system.

High performance circular duct fans HRF, AMD, VAR
See product pages.

Heating element
Heating element.
① WHR warm water
② EHR-R electric

MultiVent®
Retractable, for space-saving installation.

WHST, WHS HE Temperature control systems
for warm water heating element.

Acoustic Line SilentBox® SB and SVS
Virtually silent.

WGS Weather protection grille

VK External shutter

DDS Differential pressure switch
For monitoring the air filter, system pressure and fan operation.

Commercially available pipes
Available from stock everywhere. Standard sizes suitable for the Helios components.

FSD Flexible cross talk silencer
For quiet ventilation.

EHS Electronic temperature control system
for electric heating element.



■ Fresh air boxes

Efficient EC version.
With electric or warm water heating and air filter.

ALB EC EH

Ø 125 – 250 mm
□ 30 x 20 cm

ALB EC WW

□ 40 x 20 cm, 50 x 30 cm,
60 x 35 cm, 80 x 50 cm



332ff

■ MultiVent® MV circular duct fans

Compact circular duct fans for space-saving installation in the pipeline.

7 types available from Ø 100 – 315 with highly efficient EC motors for the lowest operating costs.



354ff

■ Explosion-proof compact fans RRK Ex, 230 V~



372ff

■ Centrifugal circular duct fans

Product-specific information, selection table.

352ff

■ InLineVent® RR, RRK and SVR circular duct fans

RR, RRK: Optionally made of galvanised steel sheet or in corrosion-resistant plastic casing.

SlimVent: Slimline, with retractable motor-impeller unit.

18 types available from Ø 100 – 315 with highly efficient EC motors for the lowest operating costs.

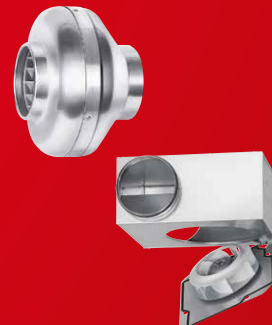

374ff

■ Acoustic Line SilentBox® SB and SlimVent SVS, sound-insulated

Virtually silent with high volume output and pressure performance. SlimVent models for limited installation spaces.

20 types available from Ø 125 – 400 with highly efficient EC motors for the lowest operating costs.



400ff

Properties

InlineVent and MultiVent circular duct fans have the advantages of axial design, such as linear flow pattern and easy, cost-effective installation, as well as the performance characteristics of high performance centrifugal fans.

Highlights:

- Low space requirement.
- Unrestricted controllability.
- Low installation costs.
- Cost-effective installation.
- Low sound power level.
- High pressure reserve.

Designs – Overview

MultiVent® MV

High pressure performance and volume output with space-saving dimensions.
 With 190 – 1860 m³/h and above 800 Pa, universally suitable for the ventilation of small to medium-sized rooms of any kind.
 19 types from standard diameter 100 – 250 mm in single and two level as well as parallel design.

■ **MV EC**

7 types available from Ø 100 – 315 mm with highly efficient EC motors for the lowest operating costs.

RR

Market-leading solution with favourable price/performance ratio. Centrifugal circular duct fans with small to medium output in standard diameters from 100 – 315 mm. Robust casing made of galvanised steel sheet.

■ **RR EC**

9 types available from Ø 100 – 315 mm with highly efficient EC motors for the lowest operating costs.

RRK

Alternative in corrosion-resistant and impact-resistant plastic casing in standard diameters from 100 – 315 mm.

■ **Reference**

The integration of air filters in class ISO ePM₁ 50% (F7) and differential pressure switches DDS (Ref. no. 00445) in intake air systems meets the requirements of VDI 6022.

■ Reference	Page
Planning information, acoustics, expl. protection	10 ff.
General techn. information, power control	15 ff.

SVV, SVR

Compact flat circular duct fans from Ø 80 – 200 mm. With energy-efficient centrifugal impellers for the delivery of small to large volume flows.

■ **SVR EC**

9 types available from Ø 100 – 315 mm with highly efficient EC motors for the lowest operating costs.

RRK Ex

Explosion-proof compact fans for 230 V, 1~ alternating current. Especially suitable for the ventilation of chemical and pharmaceutical laboratories, workshops, etc. For installation in the pipeline, approved for operation in zones 1 and 2 according to DIN EN 60079 / VDE 0165.

Acoustic Line SB

Helios SilentBox – the virtually silent solution for powerful centrifugal fans with duct connection to standard diameters 125 – 400 mm.

■ **SB EC**

12 types available from Ø 125 – 400 mm with highly efficient EC motors for the lowest operating costs.

Acoustic Line SVS

Fully lined with sound-insulating mineral wool. In an extremely compact design. Ideal for suspended ceilings, with duct connection to standard diameters 125 – 200 mm.

■ **SVS EC**

8 types available from Ø 125 – 315 mm with highly efficient EC motors for the lowest operating costs.

This information supplements the “General technical information” and the information on the product pages.

■ **Installation position, installation, condensate outlets**

All series (except for SVR, SVS) can be installed in any position. With regard to series SV, the swivelling range must be kept clear and access for inspection and cleaning must be unhindered. In case of condensation (e.g. in case of intermittent operation, air flow with high moisture and varying temperatures), the unit must be installed so that condensate can drain downwards without restriction. Corresponding holes must be made in the fan casing, if necessary. With regard to RR types, there are condensate outlets in the impeller disc and the motor casing. If necessary, the pipeline must be insulated so that condensation is prevented.

■ **Structure-borne noise transmission**

to buildings and duct systems must be prevented. The fan must not be rigidly connected to the pipeline. Suitable connecting sleeves are offered as accessories.

■ **Explosion-proof types**

With regard to the operating conditions and standards, reference is made to the information in “Planning information Explosion protection”. The explosion proof types RRK Ex correspond to unit group II, category 2G for operation in zones 1 and 2 in accordance with Directive 2014/34/EU (ATEX).

■ **Drive, impeller**

External rotor motors which are located in the air flow and in protection category IP44 are used for all types. They correspond to DIN EN 60034/VDE 0530 and DIN EN 60335-1/VDE 0700 and they are in ISO class F with additional humidity protection.

The EC types are equipped with especially energy-saving, speed-controllable EC external rotor motors. They are maintenance-free and radio interference-free and they are suitable for continuous operation (S1). The ball bearings have a sufficient lubricant supply for their service life.

The centrifugal impellers are pressed on the motor body, i.e. fixed to it, and dynamically balanced as a unit according to DIN ISO 21940-11 – quality grade 6.3.

■ **Power control**

All InlineVent-, MultiVent and Acoustic Line AC standard types can be controlled from 0 – 100% through voltage reduction. As a result, the output can be set to the desired volume. One or more AC fans (until the max. rated current is reached) can be operated with the offered speed controls.

The dimensioning must be based on a 10% reserve. Type SVV 80 can also be controlled using a three level switch and types SVR, SVS and RR can be controlled using a two level switch.

Control via two level switch or a five-step transformer is possible for all MultiVent AC types. Continuously variable control is also possible via electronic speed controller.

All EC types have continuously variable speed control via speed potentiometer. Control is also possible via three level switch or continuously variable via universal control system or electronic differential pressure/temperature controller. The performance levels are shown on the performance curve as examples.

■ **Air flow direction**

The air flow direction cannot be changed for centrifugal fans; but it can be set by the corresponding positioning. The correct motor rotation direction and air flow direction is marked by arrows and must be checked during commissioning.

■ **Incorrect direction of rotation**

Operation in the incorrect direction of rotation overloads the AC motor and causes the thermal contacts to respond. Typical concomitant features include virtually non-existent flow rate, vibration and abnormal noise.

■ **Air flow temperature**

The units can be used in the range from –40 °C to at least +40 °C (type-dependent).



MultiVent®, flat and acoustic line centrifugal circular duct fans

Selection table

By combining the parameters of static pressure increase Δp_{fa} , case-radiated noise and inlet side air noise as sound pressure at

1 m (free field conditions), the following table facilitates the selection of circular duct fans.

 Type	Sound pre. Radiation	Sound pre. inlet side	Flow rate V m³/h depending on static pressure												
	L _{PA} dB(A)	L _{PA} dB(A)	(ΔP _{fa}) in Pa												
	at 1m dist.	at 1m dist.	0	50	100	150	200	250	300	350	400	500	600	700	800
MV EC 100	44	57	280	150	100	60	30	10							
MV EC 125	44	57	360	290	210	140	90	40							
MV EC 150	48	61	600	540	460	390	320	250	190	130					
MV EC 160	49	61	620	560	520	470	390	290	210	150	100				
MV EC 200	51	62	1100	1030	950	840	670	410	170						
MV EC 250	53	66	1470	1380	1270	1160	1010	850	470	160	30				
MV EC 315	57	72	2620	2490	2370	2240	2100	1880	1660	280	110				
RR EC 100	46	70	370	350	330	300	280	250	230	200	170	100			
RR EC 125	45	71	570	530	490	450	410	370	330	290	240	140			
RR EC 160	44	67	650	620	590	550	510	470	430	370	330	200			
RR EC 200 A	44	67	980	930	880	820	750	670	590	470	340				
RR EC 200 B	47	69	1130	1070	1010	950	890	830	770	700	620	450	180		
RR EC 250 A	44	66	1050	1000	940	870	800	720	610	500	390				
RR EC 250 B	45	68	1200	1130	1060	1000	930	860	800	730	650	490	190		
RR EC 315 A	47	66	1910	1830	1730	1580	1370	1210	1050	930	820	620	450	160	
RR EC 315 B	48	71	2140	2030	1920	1800	1690	1580	1480	1380	1260	1060	820	560	230
SB EC 125 A	41	54	520	500	480	460	440	420	390	370	350	280	140		
SB EC 125 B	45	54	530	500	480	460	430	410	380	360	330	280	210	220	130
SB EC 160 A	41	57	590	570	550	530	510	480	450	420	380	280	60		
SB EC 160 B	46	57	590	560	530	500	470	440	410	380	350	280	200	240	150
SB EC 200 A	39	55	900	850	800	740	670	600	540	450	360				
SB EC 200 B	43	57	1020	960	910	860	790	740	660	590	520	360	110		
SB EC 250	43	56	1190	1130	1060	990	910	830	730	660	560	380	130		
SB EC 315 A	49	62	2490	2380	2270	2160	2040	1910	1770	1600	1380	130		80	
SB EC 315 B	53	65	3280	3210	3140	3060	2980	2900	2820	2720	2630	2440	2190		
SB EC 355	53	64	2710	2530	2390	2250	2110	1960	1780	1610	1380				
SB EC 400 A	51	60	2980	2850	2700	2540	2390	2200	2000	1780	1520				
SB EC 400 B	58	68	4570	4370	4190	4020	3850	3680	3490	3290	3080	2590	1810		
SVR EC 100	52	67	400	380	360	340	320	300	280	260	230	170	90		
SVR EC 125	50	70	520	490	470	450	420	400	370	340	310	240	150		
SVR EC 160 A	52	68	580	550	530	510	480	450	420	380	350	260	150	220	20
SVR EC 160 B	54	68	740	700	660	620	580	530	490	440	400	290	180		
SVR EC 200 A	50	68	850	800	760	700	650	590	520	450	360	40			
SVR EC 200 B	53	68	980	930	880	820	770	720	670	620	570	450	320		
SVR EC 250	48	65	1180	1120	1050	980	920	830	770	700	630	480	310		
SVR EC 315 A	52	67	1700	1590	1460	1350	1230	1120	1010	900	810	610	400	220	20
SVR EC 315 B	54	71	1950	1830	1730	1630	1540	1440	1350	1270	1180	1010	840	650	450
SVS EC 125	53	62	540	510	490	460	430	410	380	350	310	240	150		
SVS EC 160 A	51	62	570	550	520	500	470	430	410	370	330	250	140		
SVS EC 160 B	52	61	780	740	690	640	580	540	490	440	390	300	180		
SVS EC 200 A	49	60	900	850	800	740	680	620	560	490	410				
SVS EC 200 B	52	61	1010	950	900	840	780	730	680	610	560	420	270	0	
SVS EC 250	46	58	1210	1150	1070	1010	930	860	790	720	650	510	340		
SVS EC 315 A	50	60	1700	1580	1450	1340	1230	1110	1000	890	780	580	390	200	0
SVS EC 315 B	52	64	1950	1830	1720	1620	1520	1420	1330	1250	1160	970	800	620	410

Type	Sound pre. Radiation	Sound pre. inlet side	Flow rate V m³/h depending on static pressure												
	L _{PA} dB(A)	L _{PA} dB(A)	(ΔP _{fa}) in Pa												
	at 1m dist.	at 1m dist.	0	50	100	150	200	250	300	350	400	500	600	700	800
MV 100 A	34/38	45/50	190												
MV 100 B	32/38	46/52	230	120	40										
MV 125	35/42	49/56	350	300	100										
MV 150	40/48	56/64	520	480	420	350	80								
MV 160	41/49	57/65	550	470	410	350	120								
MV 200	36/44	50/58	930	860	770	630	160								
MV 250	40/52	53/66	910	830	700	600	500	390	270	180	110				
RR 100 A	36	59	250	200	160	120	90	60	30						
RR 100 C	42	63	330	290	240	190	150	100	70	20					
RR 125 C	42	63	480	420	350	250	170	120	70	30					
RR 160 B	42	62	530	470	380	300	240	160	100						
RR 160 C	49	66	870	800	730	600	500	400	320	180					
RR 200 A	47	65	960	900	830	760	670	590	480	350	230				
RR 200 B	44	66	980	940	890	830	760	690	610	520	410	120			
RR 250 A	47	67	950	880	800	730	650	550	450	320	100				
RR 250 C	45	67	970	930	870	810	760	690	630	560	470	160			
RR 315	46	68	1260	1190	1140	1080	1010	940	870	790	700	390			
RRK 100	44	55	290	230	170	110	70	20							
RRK 125	36	52	390	350	300	250	190	120	40						
RRK 160	36	53	520	470	410	340	260	170	70						
RRK 200	40	57	930	870	790	660	570	440	340	250	150				
RRK 250	40	56	1000	910	820	700	580	450	350	240	130				
RRK 315	48	65	1080	1040	980	920	850	780	710	630	530	320	30		
SB 125 A	28	46	230	220	200	180	150	120							
SB 125 C	37	55	440	420	400	370	340	310	270	10					
SB 160 B	36	54	360	340	330	310	290	240							
SB 160 D	43	60	580	540	510	470	440	400	360	20					
SB 200 C	44	55	810	730	650	570	470	350	240	120					
SB 200 D	48	58	1030	940	880	830	770	710	650	560	450	150			
SB 250 C	43	56				940	890	820	740	590	330				
SB 250 E	45	55	1080	990	910	840	770	700	630	550	460	200			
SB 315	51	59	2420	2250	2080	1830	1530	1020	130						
SBD 315 A	50	61	2200	2020	1830	1640	1420	1120	710	240					
SBD 315 B	47	57	2250	2150	2030	1830	1620	1430	1200						
SB 355	52	63	2960	2730	2490	2230	1950	1560	310						
SBD 355	51	65	3330	3210	3070	2920	2770	2600	2420	2200	1930				
SB 400	51	62	3930	3670	3410	3100	2750	2380	1860	1030					
SBD 400	50	65	3450	3320	3190	3060	2900	2730	2530	2280	1950				
SVR 100 C	40/45	54/59	310	290	270	240	210	160	110	50					
SVR 125 B	38/46	53/61	400	360	320	290	240	190	120	50					
SVR 160 K	37/45	51/60	450	400	360	320	270	220	160	80					
SVR 200 K	57	70	980	930	870	820	760	710	650	580	510	320	80		
SVS 125 B	35/44	45/55	400	360	330	280	240	180	130	60					
SVS 160 K	35/44	45/55	440	400	360	310	260	210	150	70					
SVS 160 L	39/50	48/58	670	620	570	510	440	370	290	210	90				
SVS 200 K	55	63	940	900	850	800	750	690	620	540	460	300	90		
SVV 80	24/26/37	25/32/43	110	100	90	80	70	60	20						

Round duct fans

MultiVent® circular duct fans. As slimline as the duct system itself.

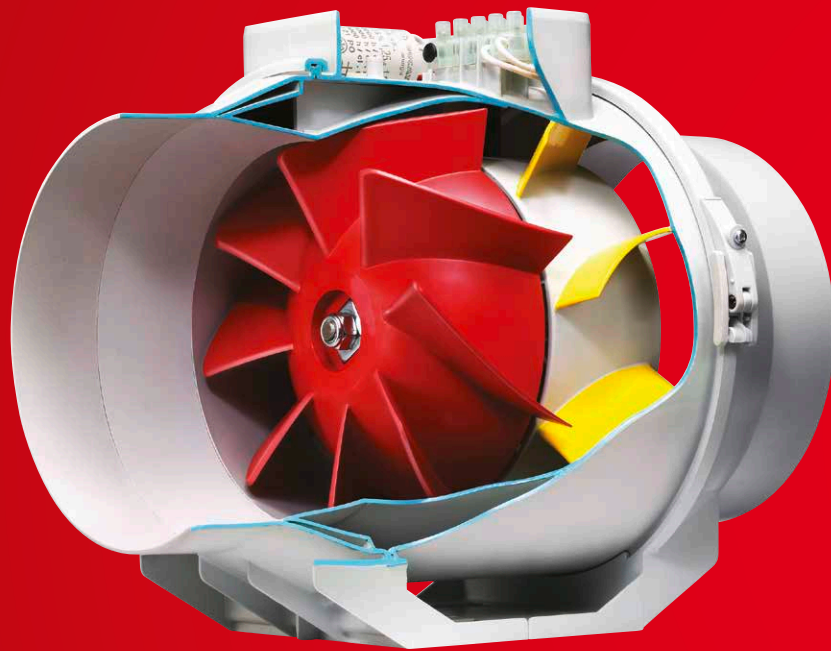

■ Energy-efficient
EC version

– Ø 100 – 315 mm
V̇ = 280 – 2620 m³/h



356ff

■ Standard AC types
available in two level
or parallel design

– Ø 100 – 250 mm
V̇ = 190 – 1820 m³/h

360ff



■ Space-saving

With a volume output of 190 to 2620 m³/h and a pressure rate above 800 Pa (with two level configuration), Helios MultiVent units are suitable for the ventilation of small to medium-sized rooms of any kind. Their special advantage lies in their especially small dimensions. The casing diameter is only slightly larger than the ventilation duct. Horizontal, vertical or diagonal installation possible in any position.

■ Rotates as required

The installation of Helios MultiVent directly in the pipeline is space-saving and easy. Ideal in narrow spaces, e.g. below suspended ceilings. The casing with integrated bracket can be installed in any position. The fan unit with terminal box can also be rotated to any position. It can be easily removed by loosening the clamp.

■ Freely accessible

This unit concept guarantees the easiest installation in the pipeline as well as problem-free inspection. The concept meets the requirements of VDI 6022. The energy-saving capacitor motors (protection category IP44) are fully enclosed and equipped with ball bearings for 30000 operating hours. This means that it can also be used for contaminated and dusty air.

MV EC 100



MV EC 125



Dimensions MV EC 100

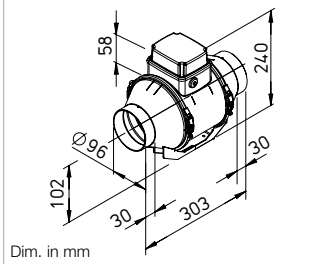

Dimensions MV EC 125

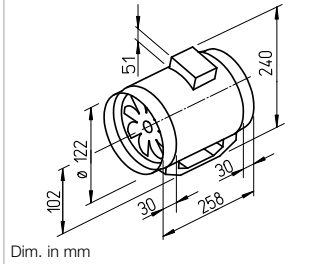

Energy-saving EC round duct fan with high pressure performance, high volume output and space-saving dimensions.

Specifically designed for direct insertion in duct systems. Various applications in commercial, industrial and residential areas.

Description

- **Casing**
The fan unit can be removed from the duct casing with integrated mounting bracket by loosening the clamp. All components are made of impact-resistant and corrosion-resistant plastic. Colour: Light grey.
- **Impeller**
Optimised for high pressure performance and volume output, made of high-quality plastic. Dynamically balanced for low-noise operation.
- **Drive**
Energy-saving, speed-controllable EC external rotor motor with the highest level of efficiency. Maintenance-free and radio interference-free, ball bearing mounted.
- **Electrical connection**
Spacious terminal box (IP44) on outside of casing; can be rotated into any position.

- **Motor protection**
Integrated electronic temperature monitoring system for EC motor and electronics.
- **Power control**
Continuously variable speed control with potentiometer or continuously variable speed regulation with universal control system (see table). Performance levels are shown in the performance curve as an example.
- **Installation**
No restrictions in any position (horizontal, vertical, diagonal) through corresponding installation for supply or extract ventilation. Installation in duct system, preferably away from the room to be ventilated for less noise.

- **Noise**
The total level and range are specified above the performance diagram for:
 - Case-radiated sound power.
 - Inlet side sound power
 - Outlet side sound power.
 The case-radiated noise as sound pressure at 1 m (free field conditions) is also specified in the type table and the table below the performance curve.

Performance curves MV EC 100

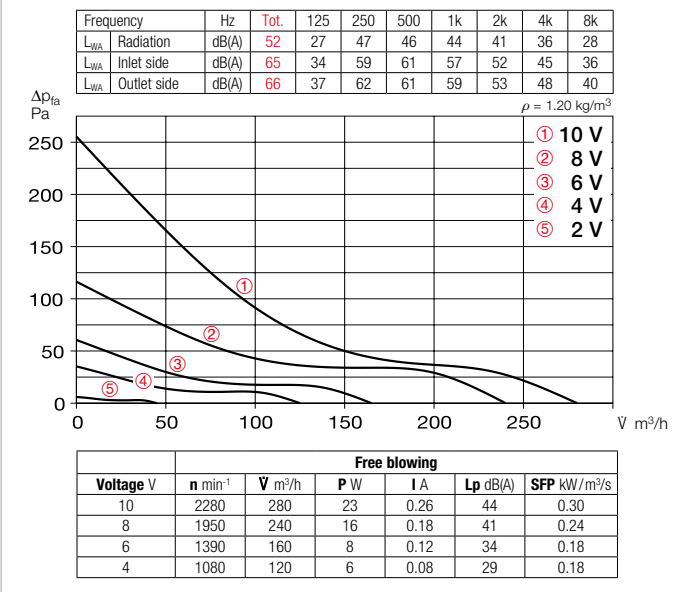

Performance curves MV EC 125

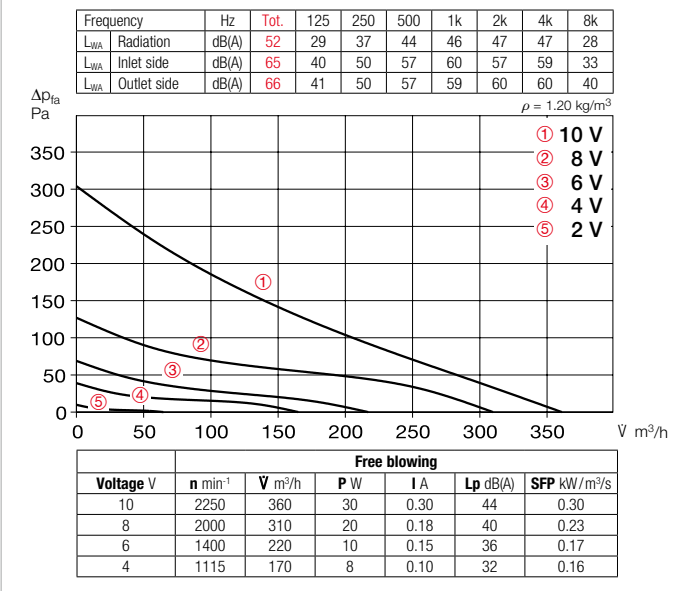

Accessory details	Page
Filters, heating elements and silencers	473 ff.
Temperature control systems for heating elements	479, 483 ff.
Flexible ventilation ducts, ventilation grilles, fittings, roof outlets	553 ff.
Disc valves	574 ff.
Universal control system, electronic controllers, speed potentiometer	605 ff.

Type	Ref. no.	Connec- tion Ø	Flow rate Free blow- ing	Rated speed	Sound press. case radiation	Power consum.	Current consum.	Wiring diagram	Max. air flow temp.	Wgt net aprx.	Universal control system	Speed potentiometer flush-mount. surf-mount.				
		mm	V m ³ /h	min ⁻¹	dB(A) in 1 m	kW	A	No.	+ °C	kg	Type	Ref. no.	Type	Ref. no.	Type	Ref. no.
Single-phase alternating current, 230 V, 50 Hz, EC motor, IP45																
MV EC 100	09513	100	280	3250	44	0.029	0.31	1194	60	1.8	EUR EC ¹⁾²⁾ 01347	PU 10 ¹⁾ 01734	PA 10 ¹⁾	01735		
MV EC 125	06032	125	360	3600	44	0.039	0.39	1194	60	1.8	EUR EC ¹⁾²⁾ 01347	PU 10 ¹⁾ 01734	PA 10 ¹⁾	01735		

¹⁾ Multiple EC fans can normally be connected. ²⁾ alternative electronic diff. pressure/ temperature controller (EDR/ETR, No. 01437/01438) or three level speed switch (SU/SA, No. 04266/04267), see accessories.

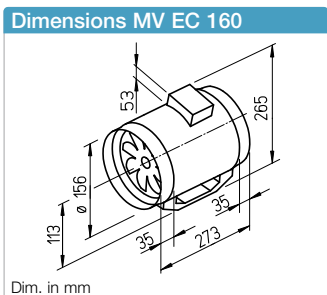
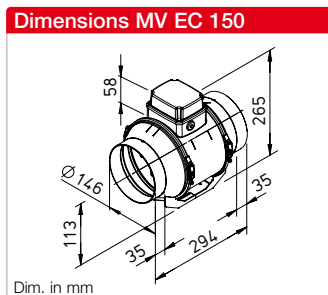

Energy-saving EC round duct fan with high pressure performance, high volume output and space-saving dimensions.

Specifically designed for direct insertion in duct systems. Various applications in commercial, industrial and residential areas.

Description

- Casing**
The fan unit can be removed from the duct casing with integrated mounting bracket by loosening the clamp. All components are made of impact-resistant and corrosion-resistant plastic. Colour: Light grey.
- Impeller**
Optimised for high pressure performance and volume output, made of high-quality plastic. Dynamically balanced for low-noise operation.
- Drive**
Energy-saving, speed-controllable EC external rotor motor with the highest level of efficiency. Maintenance-free and radio interference-free, ball bearing mounted.
- Electrical connection**
Spacious terminal box (IP44) on outside of casing; can be rotated into any position.

- Motor protection**
Integrated electronic temperature monitoring system for EC motor and electronics.
- Power control**
Continuously variable speed control with potentiometer or continuously variable speed regulation with universal control system (see table). Performance levels are shown in the performance curve as an example.
- Installation**
No restrictions in any position (horizontal, vertical, diagonal) through corresponding installation for supply or extract ventilation. Installation in duct system, preferably away from the room to be ventilated for less noise.

- Noise**
The total level and range are specified above the performance diagram for:
 Case-radiated sound power.
 Inlet side sound power
 Outlet side sound power.
 The case-radiated noise as sound pressure at 1 m (free field conditions) is also specified in the type table and the table below the performance curve.

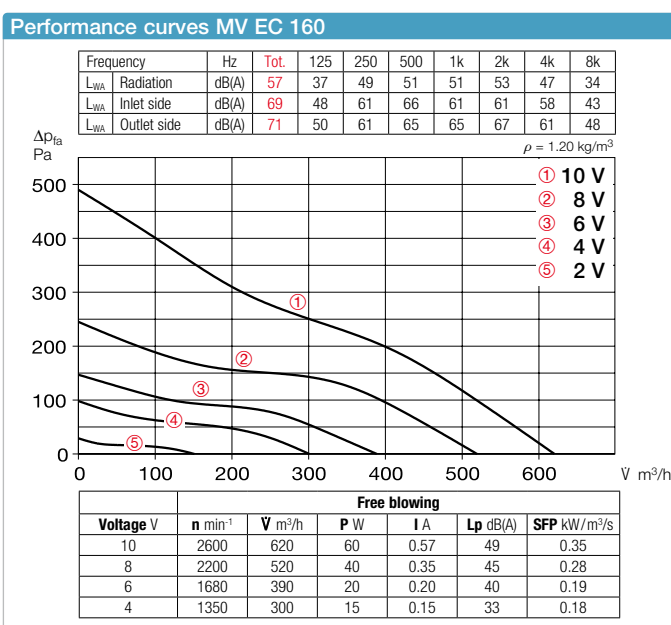
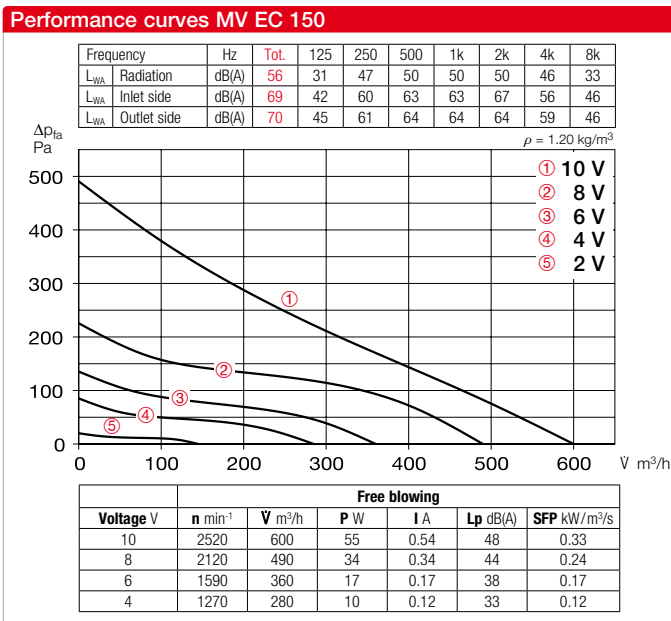

Accessory details	Page
Filters, heating elements and silencers	473 ff.
Temperature control systems for heating elements	479, 483 ff.
Flexible ventilation ducts, ventilation grilles, fittings, roof outlets	553 ff.
Disc valves	574 ff.
Universal control system, electronic controllers, speed potentiometer	605 ff.

Type	Ref. no.	Connection Ø	Flow rate Free blowing	Rated speed	Sound press. case radiation	Power consum.	Current consum.	Wiring diagram	Max. air flow temp.	Wgt net aprx.	Universal control system	Speed potentiometer flush-mount.	Speed potentiometer surf-mount.			
		mm	V m ³ /h	min ⁻¹	dB(A) in 1 m	kW	A	No.	+ °C	kg	Type	Ref. no.	Type	Ref. no.	Type	Ref. no.
Single-phase alternating current, 230 V, 50 Hz, EC motor, IP45																
MV EC 150	09307	150	600	3580	48	0.068	0.62	1194	60	2.1	EUR EC ¹⁾²⁾ 01347	PU 10 ¹⁾ 01734	PA 10 ¹⁾ 01735			
MV EC 160	06033	160	620	3530	49	0.068	0.62	1194	60	2.1	EUR EC ¹⁾²⁾ 01347	PU 10 ¹⁾ 01734	PA 10 ¹⁾ 01735			

¹⁾ Multiple EC fans can normally be connected. ²⁾ alternative electronic diff. pressure/ temperature controller (EDR/ETR, No. 01437/01438) or three level speed switch (SU/SA, No. 04266/04267), see accessories.

EC round duct fans

MV EC 200



Dimensions MV EC 200

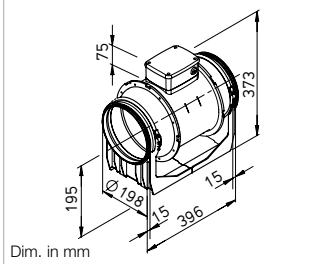

Performance curves MV EC 200

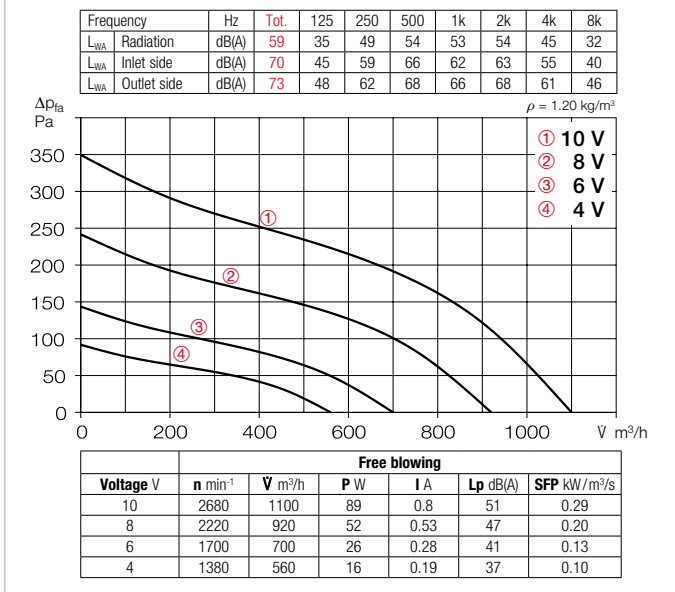

Energy-saving EC round duct fan with high pressure performance, high volume output and space-saving dimensions.

Specifically designed for direct insertion in duct systems. Various applications in commercial, industrial and residential areas.

Special features

- Highly efficiency EC motor for lowest operating costs.
- Low space requirement and minimal installation costs due to linear throughflow.
- No need for elaborate deflectors.
- Connectors on inlet and outlet side correspond to standard duct Ø.
- Performance adjustment through 100% speed control.
- Can be used in any position.
- Long-life ball bearings, designed for 30 000 operating hours.
- Problem-free maintenance and cleaning without dismantling the duct system due to the removable fan unit.
- Fan unit with terminal box can be rotated into any position.
- Integrated mounting bracket for easy installation to walls and ceilings.

Description

Casing

The fan unit can be removed from the duct casing with integrated mounting bracket by loosening the clamp. All components are made of impact-resistant and corrosion-resistant plastic. Colour: Light grey.

Impeller

Optimised for high pressure performance and volume output, made of high-quality plastic. Dynamically balanced for low-noise operation.

Drive

Energy-saving, speed-controllable EC external rotor motor with the highest level of efficiency. Maintenance-free and radio interference-free, ball bearing mounted.

Electrical connection

Spacious terminal box (IP44) on outside of casing; can be rotated into any position.

Motor protection

Integrated electronic temperature monitoring system for EC motor and electronics.

Power control

Continuously variable speed control with potentiometer or continuously variable speed regulation with universal control system (see table). Performance levels are shown in the performance curve as an example.

Installation

No restrictions in any position (horizontal, vertical, diagonal) through corresponding installation for supply or extract ventilation. Installation in duct system, preferably away from the room to be ventilated for less noise.

Noise

The total level and range are specified above the performance diagram for:

- Case-radiated sound power.
- Inlet side sound power
- Outlet side sound power.

The case-radiated noise as sound pressure at 1 m (free field conditions) is also specified in the type table and the table below the performance curve.

Accessory details	Page
Filters, heating elements and silencers	473 ff.
Temperature control systems for heating elements	479, 483 ff.
Flexible ventilation ducts, ventilation grilles, fittings, roof outlets	553 ff.
Disc valves	574 ff.
Universal control system, electronic controllers, speed potentiometer	605 ff.

Type	Ref. no.	Connec-tion Ø	Flow rate Free blowing	Rated speed	Sound press. case radiation	Power consum.	Current consum.	Wiring diagram	Max. air flow temp.	Wgt net aprx.	Universal control system		Speed potentiometer			
											Type	Ref. no.	Type	Ref. no.		
Single-phase alternating current, 230 V, 50/60 Hz, EC motor, IP45																
MV EC 200	06034	200	1100	3000	51	0.090	0.80	1194	50	2.5	EUR EC ¹⁾	01347	PU 10 ¹⁾	01734	PA 10 ¹⁾	01735

¹⁾ Multiple EC fans can normally be connected. ²⁾ alternative electronic diff. pressure/ temperature controller (EDR/ETR, No. 01437/01438) or three level speed switch (SU/SA, No. 04266/04267), see accessories.

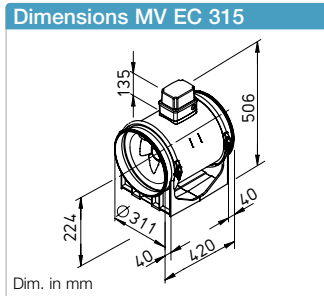
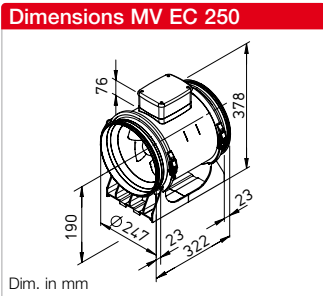

Energy-saving EC round duct fan with high pressure performance, high volume output and space-saving dimensions.

Specifically designed for direct insertion in duct systems. Various applications in commercial, industrial and residential areas.

Description

- Casing**
The fan unit can be removed from the duct casing with integrated mounting bracket by loosening the clamp. All components are made of impact-resistant and corrosion-resistant plastic. Colour: Light grey.
- Impeller**
Optimised for high pressure performance and volume output, made of high-quality plastic. Dynamically balanced for low-noise operation.
- Drive**
Energy-saving, speed-controllable EC external rotor motor with the highest level of efficiency. Maintenance-free and radio interference-free, ball bearing mounted.
- Electrical connection**
Spacious terminal box (IP44) on outside of casing; can be rotated into any position.

- Motor protection**
Integrated electronic temperature monitoring system for EC motor and electronics.
- Power control**
Continuously variable speed control with potentiometer or continuously variable speed regulation with universal control system (see table). Performance levels are shown in the performance curve as an example.
- Installation**
No restrictions in any position (horizontal, vertical, diagonal) through corresponding installation for supply or extract ventilation. Installation in duct system, preferably away from the room to be ventilated for less noise.

- Noise**
The total level and range are specified above the performance diagram for:

 - Case-radiated sound power.
 - Inlet side sound power
 - Outlet side sound power.

The case-radiated noise as sound pressure at 1 m (free field conditions) is also specified in the type table and the table below the performance curve.

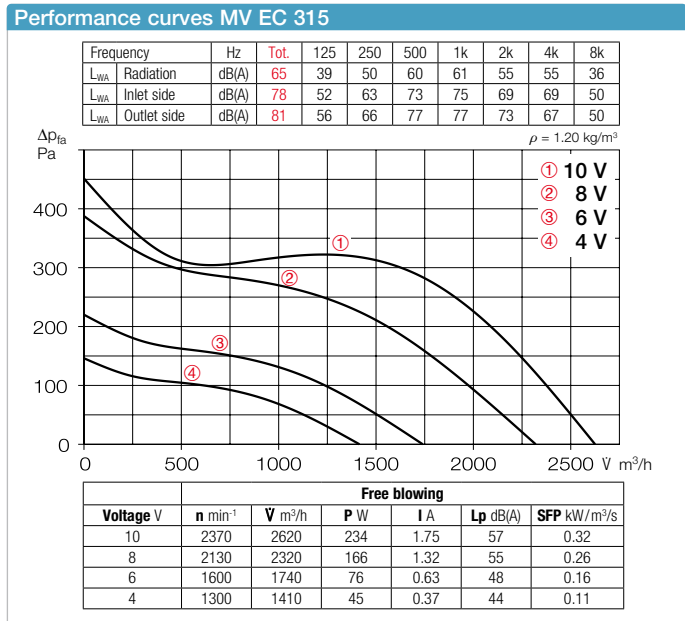
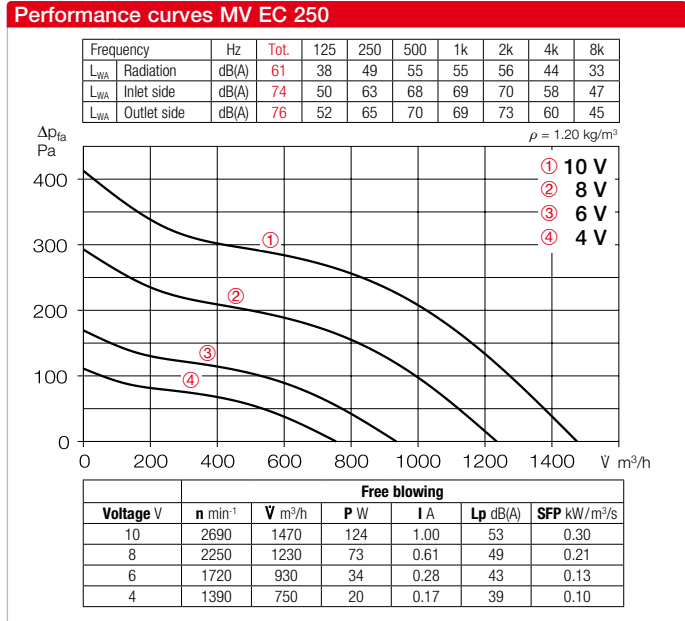

Accessory details	Page
Filters, heating elements and silencers	473 ff.
Temperature control systems for heating elements	479, 483 ff.
Flexible ventilation ducts, ventilation grilles, fittings, roof outlets	553 ff.
Disc valves	574 ff.
Universal control system, electronic controllers, speed potentiometer	605 ff.

Type	Ref. no.	Connection Ø	Flow rate Free blowing	Rated speed	Sound press. case radiation	Power consum.	Current consum.	Wiring diagram	Max. air flow temp.	Wgt net aprx.	Universal control system	Speed potentiometer				
		mm	V m ³ /h	min ⁻¹	dB(A) in 1 m	kW	A	No.	+ °C	kg	Type	Ref. no.	Type	Ref. no.	Type	Ref. no.
Single-phase alternating current, 230 V, 50/60 Hz, EC motor, IP45																
MV EC 250	06035	250	1470	2740	53	0.126	1.00	1194	50	5.3	EUR EC ¹⁾²⁾	01347	PU 10 ¹⁾	01734	PA 10 ¹⁾	01735
MV EC 315	06036	315	2620	2350	57	0.268	1.86	1195	50	9.5	EUR EC ¹⁾²⁾	01347	PU 10 ¹⁾	01734	PA 10 ¹⁾	01735

¹⁾ Multiple EC fans can normally be connected. ²⁾ alternative electronic diff. pressure/ temperature controller (EDR/ETR, No. 01437/01438) or three level speed switch (SU/SA, No. 04266/04267), see accessories.

EC round duct fans

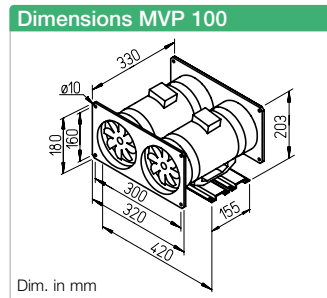
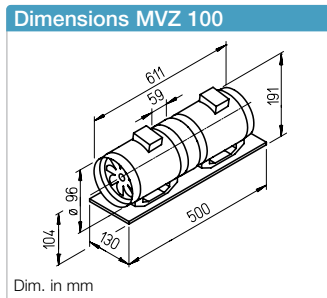
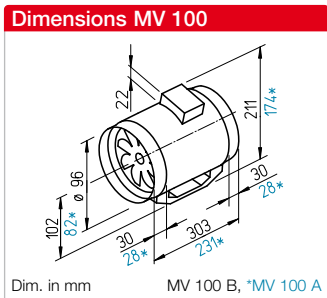
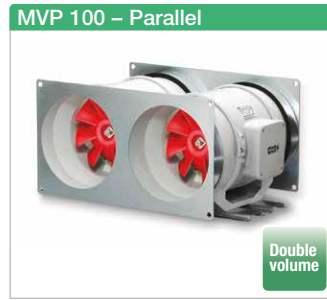

High pressure performance and high volume output with space-saving dimensions.
 Specifically designed for direct insertion in duct systems. Various applications in commercial, industrial and residential areas.

- **Special features**
 - Low space requirement and minimal installation costs due to linear throughflow.
 - No need for elaborate deflectors.
 - Connectors on inlet and outlet side correspond to standard duct Ø.
 - Comes with two performance levels; 100% speed-controllable as standard.
 - Can be used in any position.
 - Long-life ball bearings, designed for 30000 operating hours.
 - Problem-free maintenance and cleaning without dismantling the duct system due to the removable fan unit.
 - Fan unit with terminal box can be rotated into any position.
 - Integrated mounting bracket for easy installation to walls and ceilings.

Common features

- **Casing**
 The fan unit can be removed

from the duct casing with integrated mounting bracket by loosening the clamp. All components are made of impact-resistant and corrosion-resistant plastic. Colour: Light grey.

- **Power control**
 With two performance levels as standard using an external operating switch MVB (accessories). Also with continuously variable control through electronic controller or five-step transformer.
- **Motor**
 Enclosed, ball bearing mounted motor with humidity protection, insulation class F, for continuous operation, maintenance-free and radio interference-free.
- **Motor protection**
 Through thermal overload protection in the winding.
- **Noise**
 See information on page 363.

Description MV

- **Impeller**
 Optimised for high pressure performance and volume output, made of high-quality plastic.

- **Electrical connection**
 Spacious terminal box (IP44) on outside of casing; can be rotated into any position.

- **Installation**
 No restrictions in any position (horizontal, vertical, diagonal) through corresponding installation for supply or extract ventilation. Installation in duct system, preferably away from the room to be ventilated for less noise.

Description MVZ

Two MV fans arranged in series, connected by a sleeve and mounted on a shared base plate. Delivered as a ready-to-install kit. The pressure performance is approximately doubled through series operation.

- **Impeller**
 As described on the left.

- **Electrical connection**
 Each fan is equipped with its own terminal box on the outside of the casing. A coupling relay must be provided according to the wiring diagram for controlling the two fans at two performance levels via one operating switch MVB (ac-

cessories) or one on-site changeover switch. The high performance level must be connected when using speed controllers.

- **Installation**
 No restrictions in any position (horizontal, vertical, diagonal) through corresponding installation for supply or extract ventilation. Installation in duct system, preferably away from the room to be ventilated for less noise.

Description MVP

Two MV fans arranged in parallel are connected together by inlet and outlet side-mounted rectangular duct connection plates and screwed to mounting rails. Delivered as a ready-to-install kit. The volume output doubles during parallel operation (joint control).

- **Impeller**
 As described on the left.

- **Power control/Connection**
 Each fan is equipped with its own terminal box on the outside of the casing. A coupling relay must be provided according to the wiring diagram for controlling the two fans at two performance levels via one operating switch MVB (accessories) or one on-site changeover switch. The high performance level must be connected when using speed controllers. Each fan can also be individually controlled and connected to the second fan if necessary. In order to prevent backflow in this case, two duct shutters (type RSK, accessories) must be provided on the outlet side.

Type	Ref. no.	Conne- ction Ø	Flow rate min./max.	Speed min./max.	Sound pres. lev at 1m		Power consum. min./max.	Current consum. min./max.	Wiring diagram	Max. air flow temp.	Wgt net aprx.	Transformer speed controller 5-step		Electronic* speed controller, cont. variable flush/ surf-mount.	
					Case radiation	Air noise min./max.						Type	Ref. no.	Type	Ref. no.
mm															
			m³/h	min ⁻¹	dB (A)		W	A	No.	+ °C	kg	Type	Ref. no.	Type	Ref. no.
Single-phase alternating current, 230 V, 50 Hz, EC motor, IP44															
MV 100 A	06050	100	150/190	2070/2620	34/38	45/50	12/15	0.05/0.07	844.1	60	1.2	TSW 0.3	03608	ESU1/ESA1	00236/00238
MV 100 B	06051	100	170/240	1590/2170	32/38	46/52	20/23	0.09/0.11	844.1	60	1.7	TSW 0.3	03608	ESU1/ESA1	00236/00238
Double pressure Two level fan unit, 230 V, 50 Hz, Capacitor motor, IP44															
MVZ 100 B	06058	100	170/240	1590/2170	37/43	49/55	40/46	0.18/0.22	845.1	60	4.5	TSW 0.3	03608	ESU1/ESA1	00236/00238
Double volume Parallel twin unit, 230 V, 50 Hz, Capacitor motor, IP44															
MVP 100	06065	-	340/480	1590/2170	35/41	49/55	40/46	0.18/0.22	845.1	60	5.7	TSW 0.3	03608	ESU1/ESA1	00236/00238

* Transformer control units must be provided in noise-relevant cases. Electronic phase angle control can cause disturbing magnetisation humming.

Performance curves MV 100 A – Single level

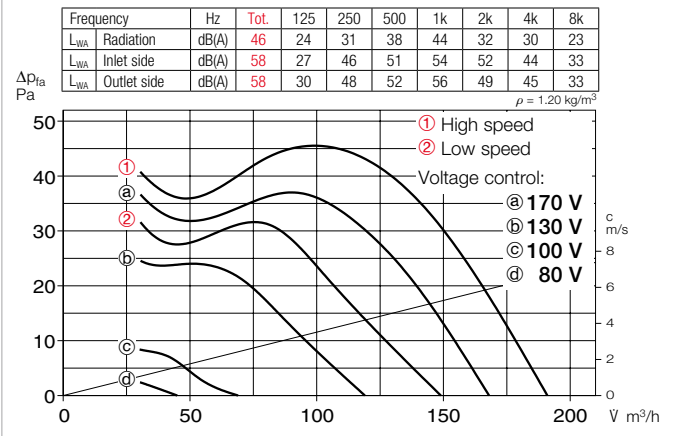

Performance curves MV 100 B – Single level

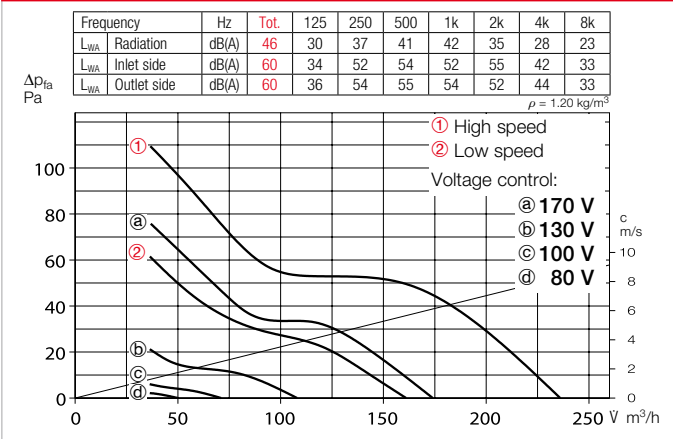

Performance curves MVZ 100 B – Two level

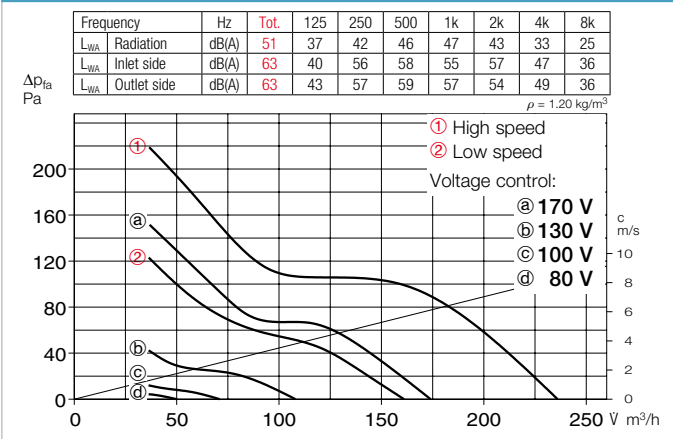

Performance curves MVP 100 B – Parallel

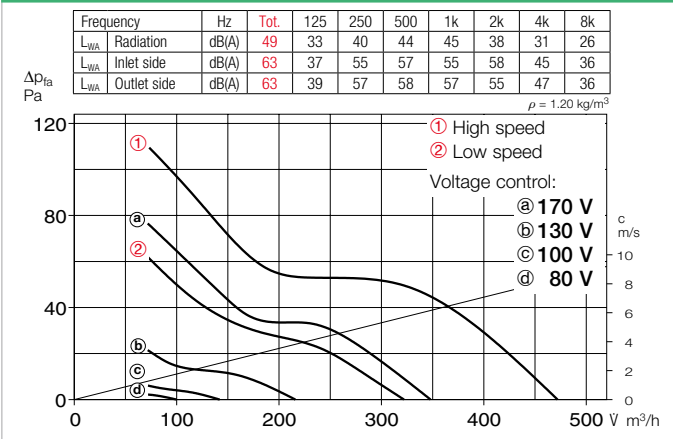

■ Accessories for MV and MVZ

Flexible connecting sleeve FM 100 Ref. no. 01681
Includes 2 hose clamps; for installation between fan and duct system. Prevents structure-borne noise transmission and bridges installation tolerances. 2 pcs required for inlet and outlet side application.



External wall shutter VK 100 Ref. no. 00757
Automatic overpressure shutter for external wall connection of air outlet opening. Made of white plastic.



External wall cover grille G 100 Ref. no. 00796
For covering and insertion in round ventilation openings. Made of break-resistant, white plastic.



Protection grille MVS 100 Ref. no. 06071
For inlet and outlet side installation on fan.



Flexible cross talk silencer FSD 100 Ref. no. 00676
Made of aluminium pipe with double-sided plug-in connectors. Sound insulation lining 50 mm thick, installation length 1 m.



Air filter box LFBR 100 Coarse 70%* 08576
Large-surface, installation in round duct system.



Electric heating element EHR-R 0.4/100 0.4 kW No. 08708
In duct casing made of galvanised steel sheet.



Warm water heating element WHR 100 Ref. no. 09479
For installation in duct system.



■ Accessories for all types

Duct shutter RSKK 100 Ref. no. 05106
Automatic, made of plastic. For installation in pipeline.



Operating switch 0-1-2 MVB Ref. no. 06091
With functions On/Off, Low and high speed.



Transformer speed controller TSW See type table
Five-step, for surface installation.



Electronic speed controller ESU/ESA See type table
For flush/surface installation.



Electronic turn-off delay switch ZNE Ref. no. 00342
With continuously variable turn-off delay periods.



* See product page for detailed description

Round duct fans

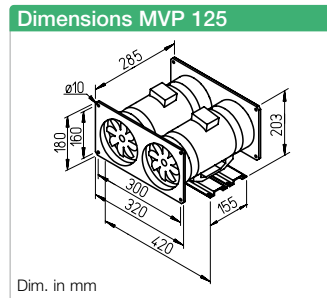
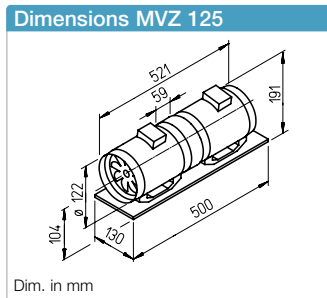
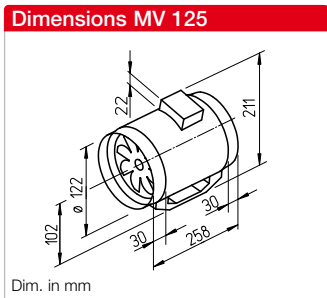

High pressure performance and high volume output with space-saving dimensions.
 Specifically designed for direct insertion in duct systems. Various applications in commercial, industrial and residential areas.

Special features

- Low space requirement and minimal installation costs due to linear throughflow.
- No need for elaborate deflectors.
- Connectors on inlet and outlet side correspond to standard duct Ø.
- Comes with two performance levels; 100% speed-controllable as standard.
- Can be used in any position.
- Long-life ball bearings, designed for 30000 operating hours.
- Problem-free maintenance and cleaning without dismantling the duct system due to the removable fan unit.
- Fan unit with terminal box can be rotated into any position.
- Integrated mounting bracket for easy installation to walls and ceilings.

Common features

Casing

The fan unit can be removed from the duct casing with integ-

rated mounting bracket by loosening the clamp. All components are made of impact-resistant and corrosion-resistant plastic. Colour: Light grey.

Power control

With two performance levels as standard using an external operating switch MVB (accessories). Also with continuously variable control through electronic controller or five-step transformer.

Motor

Enclosed, ball bearing mounted motor with humidity protection, insulation class F, for continuous operation, maintenance-free and radio interference-free.

Motor protection

Through thermal overload protection in the winding.

Noise

See right page.

Description MV

Impeller

Optimised for high pressure performance and volume output, made of high-quality plastic.

Electrical connection

Spacious terminal box (IP44) on

outside of casing; can be rotated into any position.

Installation

No restrictions in any position (horizontal, vertical, diagonal) through corresponding installation for supply or extract ventilation. Installation in duct system, preferably away from the room to be ventilated for less noise.

Description MVZ

Two MV fans arranged in series, connected by a sleeve and mounted on a shared base plate. Delivered as a ready-to-install kit.

The pressure performance is approximately doubled through series operation.

Impeller

As described on the left.

Electrical connection

Each fan is equipped with its own terminal box on the outside of the casing.

A coupling relay must be provided according to the wiring diagram for controlling the two fans at two performance levels via one operating switch MVB (accessories) or one on-site changeover switch.

The high performance level must

be connected when using speed controllers.

Installation

No restrictions in any position (horizontal, vertical, diagonal) through corresponding installation for supply or extract ventilation. Installation in duct system, preferably away from the room to be ventilated for less noise.

Description MVP

Two MV fans arranged in parallel are connected together by inlet and outlet side-mounted rectangular duct connection plates and screwed to mounting rails. Delivered as a ready-to-install kit.

The volume output doubles during parallel operation (joint control).

Impeller

As described on the left.

Power control/Connection

Each fan is equipped with its own terminal box on the outside of the casing.

A coupling relay must be provided according to the wiring diagram for controlling the two fans at two performance levels via one operating switch MVB (accessories) or one on-site changeover switch.

The high performance level must be connected when using speed controllers.

Each fan can also be individually controlled and connected to the second fan if necessary. In order to prevent backflow in this case, two duct shutters (type RSK, accessories) must be provided on the outlet side.

Type	Ref. no.	Connection Ø	Flow rate min./max.	Speed min./max.	Sound pres. lev at 1 m		Power consum. min/max.	Current consum. min/max.	Wiring diagram	Max. air flow temp.	Wgt net aprx.	Transformer speed controller 5-step		Electronic* speed controller, cont. variable flush/ surf-mount.	
					Case radiation	Air noise min./max.						Type	Ref. no.	Type	Ref. no.
Single level round duct fan, 230 V, 50 Hz, Capacitor motor, IP44															
MV 125	06052	125	250/360	1670/2300	35/42	49/56	25/33	0.11/0.15	844.1	60	1.7	TSW 0.3	03608	ESU1/ESA1	00236/00238
Double pressure Two level fan unit, 230 V, 50 Hz, Capacitor motor, IP44															
MVZ 125	06059	125	250/360	1670/2300	40/47	52/59	50/66	0.22/0.30	845.1	60	4.6	TSW 0.3	03608	ESU1/ESA1	00236/00238
Double volume Parallel twin unit, 230 V, 50 Hz, Capacitor motor, IP44															
MVP 125	06066	-	500/720	1670/2300	38/45	52/59	50/66	0.22/0.30	845.1	60	5.8	TSW 0.3	03608	ESU1/ESA1	00236/00238

* Transformer control units must be provided in noise-relevant cases. Electronic phase angle control can cause disturbing magnetisation humming.

Performance curves MV 125 – Single level

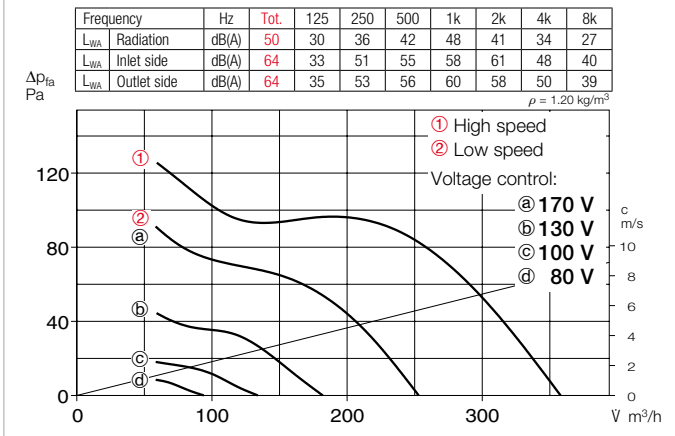

Performance curves MVZ 125 – Two level

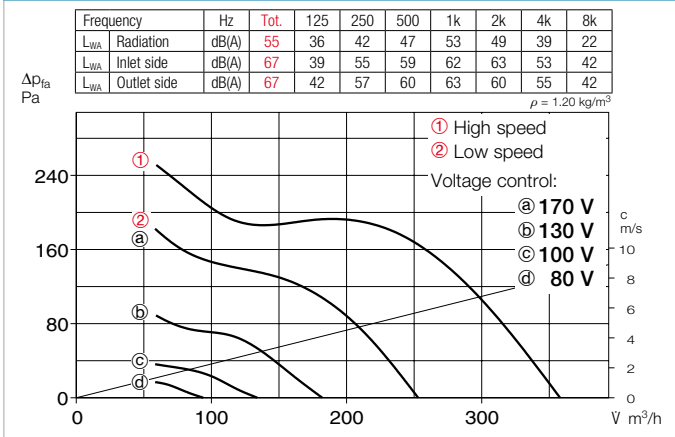

Performance curves MVP 125 – Parallel

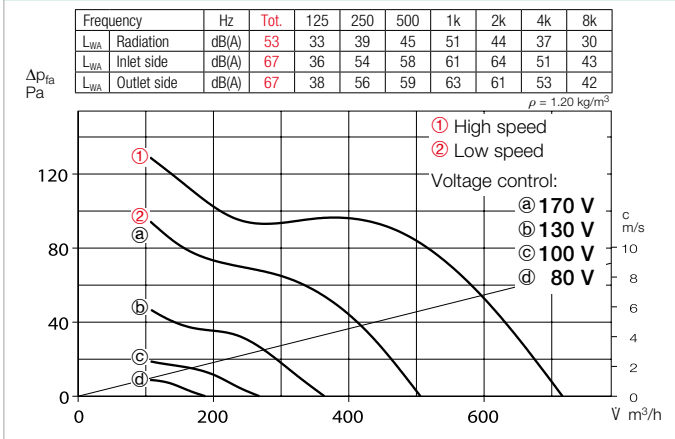

Noise

The total level and range are specified above the performance diagram for

- case-radiated sound power.
- Inlet/outlet side sound power in dB(A).
- The case-radiated noise and inlet/outlet side air noise as sound pressure at 1 m (free field conditions) are also specified in the type table.

Accessory details Page

Filter, heating elements and silencers	473 ff.
Temperature control systems for heating elements	479, 483 ff.
Flexible ventilation ducts, ventilation grilles, fittings, roof outlets	553 ff.
Disc valves	574 ff.
Speed controllers, controllers and switches	591 ff.

Accessories for MV and MVZ

Flexible connecting sleeve

FM 125 Ref. no. 01682
Includes 2 hose clamps; for installation between fan and duct system. Prevents structure-borne noise transmission and bridges installation tolerances.
2 pcs required for inlet and outlet side application.



External wall shutter

VK 125 Ref. no. 00857
Automatic overpressure shutter for external wall connection of air outlet opening. Made of white plastic.



External wall cover grille

G 160 Ref. no. 00893
For covering and insertion in round ventilation openings. Made of break-resistant, white plastic.



Protection grille

MVS 125 Ref. no. 06072
For inlet and outlet side installation on fan.



Flexible cross talk silencer

FSD 125 Ref. no. 00677
Made of aluminium pipe with double-sided plug-in connectors. Sound insulation lining 50 mm thick, installation length 1 m.



Air filter box

LFBR 125 Coarse 70%* 08577
Large-surface, installation in round duct system.



Electric heating element

EHR-R 0.8/125 0.8 kW No. 08709
In duct casing made of galvanised steel sheet.



Warm water heating element

WHR 125 Ref. no. 09480
For installation in duct system.



Accessories for all types

Duct shutter

RSKK 125 Ref. no. 05107
Automatic, made of plastic. For installation in pipeline.



Operating switch 0-1-2

MVB Ref. no. 06091
With functions On/Off, Low and high speed.



Transformer speed controller

TSW See type table
Five-step, for surface installation.



Electronic speed controller

ESU/ESA See type table
For flush/surface installation.



Electronic turn-off delay switch

ZNE Ref. no. 00342
With continuously variable turn-off delay periods.

* See product page for detailed description

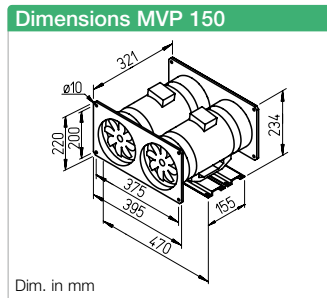
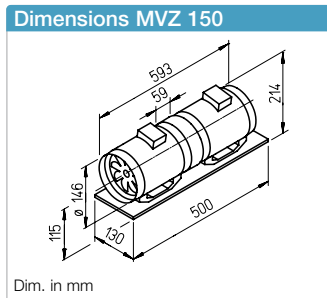
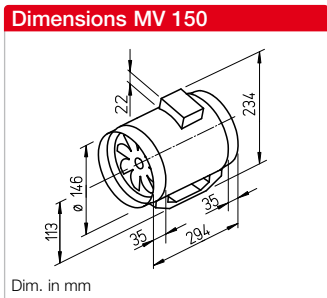

High pressure performance and high volume output with space-saving dimensions.
 Specifically designed for direct insertion in duct systems. Various applications in commercial, industrial and residential areas.

Special features

- Low space requirement and minimal installation costs due to linear throughflow.
- No need for elaborate deflectors.
- Connectors on inlet and outlet side correspond to standard duct Ø.
- Comes with two performance levels; 100% speed-controllable as standard.
- Can be used in any position.
- Long-life ball bearings, designed for 30000 operating hours.
- Problem-free maintenance and cleaning without dismantling the duct system due to the removable fan unit.
- Fan unit with terminal box can be rotated into any position.
- Integrated mounting bracket for easy installation to walls and ceilings.

Common features

Casing

The fan unit can be removed from the duct casing with integ-

rated mounting bracket by loosening the clamp. All components are made of impact-resistant and corrosion-resistant plastic. Colour: Light grey.

Power control

With two performance levels as standard using an external operating switch MVB (accessories). Also with continuously variable control through electronic controller or five-step transformer.

Motor

Enclosed, ball bearing mounted motor with humidity protection, insulation class F, for continuous operation, maintenance-free and radio interference-free.

Motor protection

Through thermal overload protection in the winding.

Noise

See right page.

Description MV

Impeller

Optimised for high pressure performance and volume output, made of high-quality plastic.

Electrical connection

Spacious terminal box (IP44) on

outside of casing; can be rotated into any position.

Installation

No restrictions in any position (horizontal, vertical, diagonal) through corresponding installation for supply or extract ventilation. Installation in duct system, preferably away from the room to be ventilated for less noise.

Description MVZ

Two MV fans arranged in series, connected by a sleeve and mounted on a shared base plate. Delivered as a ready-to-install kit.

The pressure performance is approximately doubled through series operation.

Impeller

As described on the left.

Electrical connection

Each fan is equipped with its own terminal box on the outside of the casing.

A coupling relay must be provided according to the wiring diagram for controlling the two fans at two performance levels via one operating switch MVB (accessories) or one on-site changeover switch.

The high performance level must

be connected when using speed controllers.

Installation

No restrictions in any position (horizontal, vertical, diagonal) through corresponding installation for supply or extract ventilation. Installation in duct system, preferably away from the room to be ventilated for less noise.

Description MVP

Two MV fans arranged in parallel are connected together by inlet and outlet side-mounted rectangular duct connection plates and screwed to mounting rails. Delivered as a ready-to-install kit.

The volume output doubles during parallel operation (joint control).

Impeller

As described on the left.

Power control/Connection

Each fan is equipped with its own terminal box on the outside of the casing.

A coupling relay must be provided according to the wiring diagram for controlling the two fans at two performance levels via one operating switch MVB (accessories) or one on-site changeover switch.

The high performance level must be connected when using speed controllers.

Each fan can also be individually controlled and connected to the second fan if necessary. In order to prevent backflow in this case, two duct shutters (type RSK, accessories) must be provided on the outlet side.

Type	Ref. no.	Connection Ø	Flow rate min./max.	Speed min./max.	Sound pres. lev at 1m		Power consum. min/max.	Current consum. min/max.	Wiring diagram	Max. air flow temp.	Wgt net aprx.	Transformer speed controller 5-step		Electronic* speed controller, cont. variable flush/ surf-mount.	
					Case radiation	Air noise min./max.						Type	Ref. no.	Type	Ref. no.
Single level round duct fan, 230 V, 50 Hz, Capacitor motor, IP44															
MV 150	06053	150	380/520	1520/2290	40/48	56/64	40/58	0.18/0.26	844.1	60	2.3	TSW 0.3	03608	ESU1/ESA1	00236/00238
Double pressure Two level fan unit, 230 V, 50 Hz, Capacitor motor, IP44															
MVZ 150	06060	150	380/520	1520/2290	46/54	59/67	80/116	0.36/0.52	845.1	60	5.8	TSW 1.5	01495	ESU1/ESA1	00236/00238
Double volume Parallel twin unit, 230 V, 50 Hz, Capacitor motor, IP44															
MVP 150	06067	-	760/1040	1520/2290	43/51	59/67	80/116	0.36/0.52	845.1	60	8.0	TSW 1.5	01495	ESU1/ESA1	00236/00238

* Transformer control units must be provided in noise-relevant cases. Electronic phase angle control can cause disturbing magnetisation humming.

Performance curves MV 150 – Single level

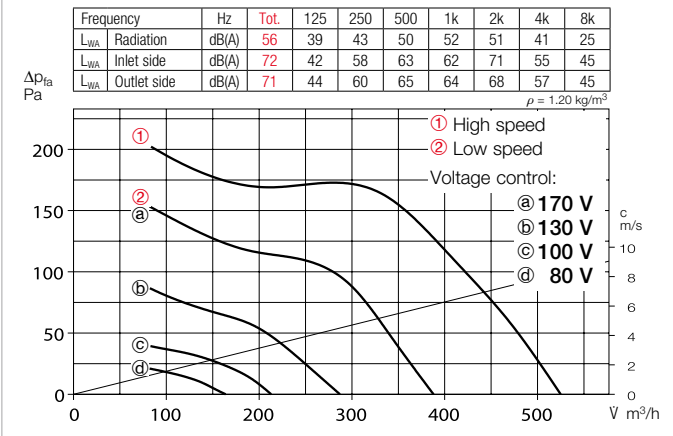

Performance curves MVZ 150 – Two level

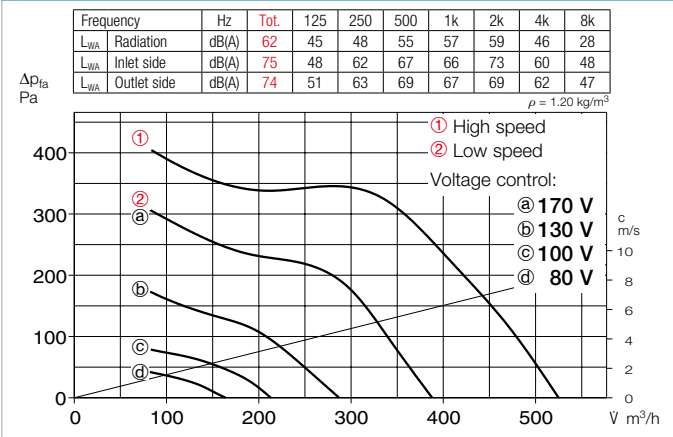

Performance curves MVP 150 – Parallel

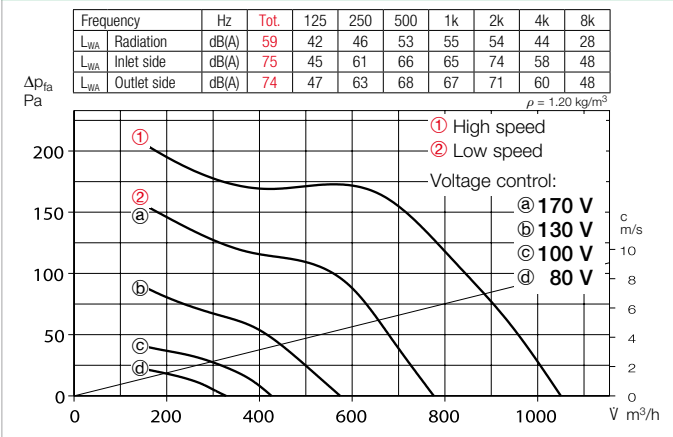

Noise

The total level and range are specified above the performance diagram for

- case-radiated sound power.
- Inlet/outlet side sound power in dB(A).
- The case-radiated noise and inlet/outlet side air noise as sound pressure at 1 m (free field conditions) are also specified in the type table.

Accessory details Page

Filter, heating elements and silencers	473 ff.
Temperature control systems for heating elements	479, 483 ff.
Flexible ventilation ducts, ventilation grilles, fittings, roof outlets	553 ff.
Disc valves	574 ff.
Speed controllers, controllers and switches	591 ff.

Accessories for MV and MVZ

Flexible connecting sleeve

FM 150 Ref. no. 01683
Includes 2 hose clamps; for installation between fan and duct system. Prevents structure-borne noise transmission and bridges installation tolerances.
2 pcs required for inlet and outlet side application.



External wall shutter

VK 160 Ref. no. 00892
Automatic overpressure shutter for external wall connection of air outlet opening. Made of white plastic.



External wall cover grille

G 160 Ref. no. 00893
For covering and insertion in round ventilation openings. Made of break-resistant, white plastic.



Protection grille

MVS 150 Ref. no. 06073
For inlet and outlet side installation on fan.



Flexible cross talk silencer

FSD 160¹⁾ Ref. no. 00678
Made of aluminium pipe with double-sided plug-in connectors. Sound insulation lining 50 mm thick, installation length 1 m.



Air filter box

LFBR 160 Coarse 70%¹⁾²⁾ 08578
Large-surface, installation in round duct system.



Electric heating element

EHR-R 1.2/160¹⁾ 1.2 kW No. 09434
In duct casing made of galvanised steel sheet.



Warm water heating element

WHR 160¹⁾ Ref. no. 09481
For installation in duct system.



Accessories for all types

Duct shutter

RSK 150 Ref. no. 05073
Automatic, made of metal. For installation in pipeline.



Operating switch 0-1-2

MVB Ref. no. 06091
With functions On/Off, Low and high speed.



Transformer speed controller

TSW See type table
Five-step, for surface installation.



Electronic speed controller

ESU/ESA See type table
For flush/surface installation.



Electronic turn-off delay switch

ZNE Ref. no. 00342
With continuously variable turn-off delay periods.



¹⁾ This accessory with ND 160 mm can be used for ducts with Ø 150 mm through on-site filling with foam rubber.

²⁾ See product page for detailed description

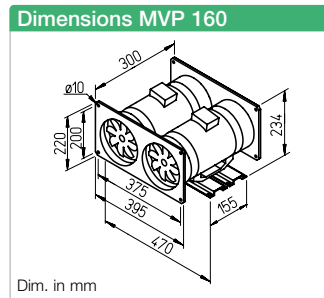
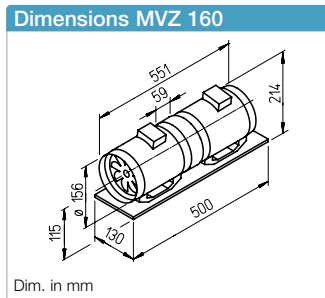
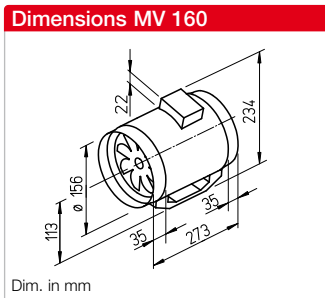
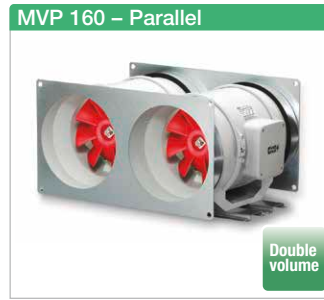

High pressure performance and high volume output with space-saving dimensions.
 Specifically designed for direct insertion in duct systems. Various applications in commercial, industrial and residential areas.

Special features

- Low space requirement and minimal installation costs due to linear throughflow.
- No need for elaborate deflectors.
- Connectors on inlet and outlet side correspond to standard duct Ø.
- Comes with two performance levels; 100% speed-controllable as standard.
- Can be used in any position.
- Long-life ball bearings, designed for 30000 operating hours.
- Problem-free maintenance and cleaning without dismantling the duct system due to the removable fan unit.
- Fan unit with terminal box can be rotated into any position.
- Integrated mounting bracket for easy installation to walls and ceilings.

Common features

Casing

The fan unit can be removed from the duct casing with integ-

rated mounting bracket by loosening the clamp. All components are made of impact-resistant and corrosion-resistant plastic. Colour: Light grey.

Power control

With two performance levels as standard using an external operating switch MVB (accessories). Also with continuously variable control through electronic controller or five-step transformer.

Motor

Enclosed, ball bearing mounted motor with humidity protection, insulation class F, for continuous operation, maintenance-free and radio interference-free.

Motor protection

Through thermal overload protection in the winding.

Noise

See right page.

Description MV

Impeller

Optimised for high pressure performance and volume output, made of high-quality plastic.

Electrical connection

Spacious terminal box (IP44) on

outside of casing; can be rotated into any position.

Installation

No restrictions in any position (horizontal, vertical, diagonal) through corresponding installation for supply or extract ventilation. Installation in duct system, preferably away from the room to be ventilated for less noise.

Description MVZ

Two MV fans arranged in series, connected by a sleeve and mounted on a shared base plate. Delivered as a ready-to-install kit.

The pressure performance is approximately doubled through series operation.

Impeller

As described on the left.

Electrical connection

Each fan is equipped with its own terminal box on the outside of the casing.

A coupling relay must be provided according to the wiring diagram for controlling the two fans at two performance levels via one operating switch MVB (accessories) or one on-site changeover switch.

The high performance level must

be connected when using speed controllers.

Installation

No restrictions in any position (horizontal, vertical, diagonal) through corresponding installation for supply or extract ventilation. Installation in duct system, preferably away from the room to be ventilated for less noise.

Description MVP

Two MV fans arranged in parallel are connected together by inlet and outlet side-mounted rectangular duct connection plates and screwed to mounting rails. Delivered as a ready-to-install kit.

The volume output doubles during parallel operation (joint control).

Impeller

As described on the left.

Power control/Connection

Each fan is equipped with its own terminal box on the outside of the casing.

A coupling relay must be provided according to the wiring diagram for controlling the two fans at two performance levels via one operating switch MVB (accessories) or one on-site changeover switch.

The high performance level must be connected when using speed controllers.

Each fan can also be individually controlled and connected to the second fan if necessary. In order to prevent backflow in this case, two duct shutters (type RSK, accessories) must be provided on the outlet side.

Type	Ref. no.	Connection Ø	Flow rate min./max.	Speed min./max.	Sound pres. lev at 1m		Power consum. min/max.	Current consum. min/max.	Wiring diagram	Max. air flow temp.	Wgt net aprx.	Transformer speed controller 5-step		Electronic* speed controller, cont. variable flush/ surf-mount.	
					Case radiation	Air noise min./max.						Type	Ref. no.	Type	Ref. no.
Single level round duct fan, 230 V, 50 Hz, Capacitor motor, IP44															
MV 160	06054	160	390/550	1520/2290	41/49	57/65	40/58	0.18/0.26	844.1	60	2.3	TSW 0.3	03608	ESU1/ESA1	00236/00238
Double pressure Two level fan unit, 230 V, 50 Hz, Capacitor motor, IP44															
MVZ 160	06061	160	390/550	1520/2290	47/55	59/67	80/116	0.36/0.52	845.1	60	5.8	TSW 1.5	01495	ESU1/ESA1	00236/00238
Double volume Parallel twin unit, 230 V, 50 Hz, Capacitor motor, IP44															
MVP 160	06068	-	780/110	1520/2290	44/52	60/68	80/116	0.36/0.52	845.1	60	7.7	TSW 1.5	01495	ESU1/ESA1	00236/00238

* Transformer control units must be provided in noise-relevant cases. Electronic phase angle control can cause disturbing magnetisation humming.

Performance curves MV 160 – Single level

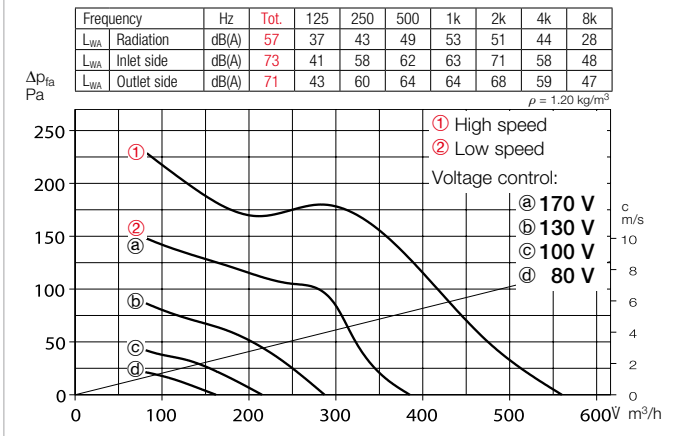

Performance curves MVZ 160 – Two level

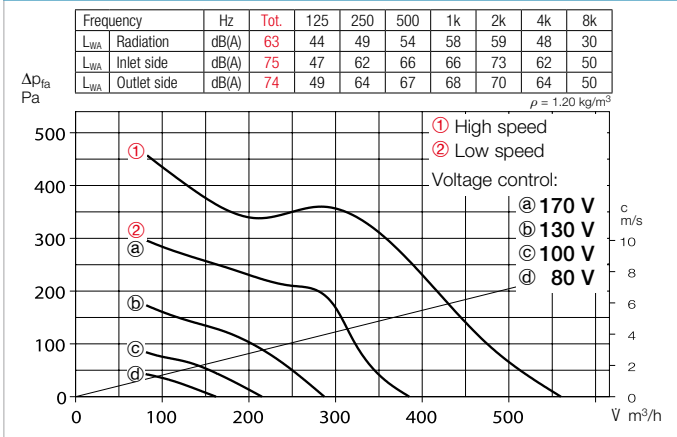

Performance curves MVP 160 – Parallel

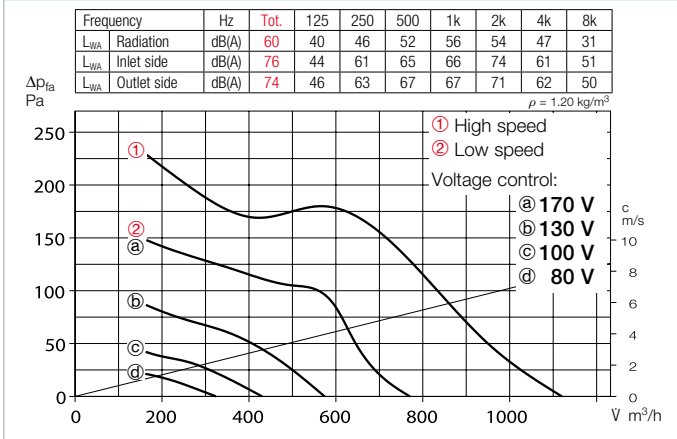

Noise

The total level and range are specified above the performance diagram for

- case-radiated sound power.
- Inlet/outlet side sound power in dB(A).
- The case-radiated noise and inlet/outlet side air noise as sound pressure at 1 m (free field conditions) are also specified in the type table.

Accessory details Page

Filter, heating elements and silencers	473 ff.
Temperature control systems for heating elements	479, 483 ff.
Flexible ventilation ducts, ventilation grilles, fittings, roof outlets	553 ff.
Disc valves	574 ff.
Speed controllers, controllers and switches	591 ff.

Accessories for MV and MVZ

Flexible connecting sleeve

FM 160 Ref. no. 01684
Includes 2 hose clamps; for installation between fan and duct system. Prevents structure-borne noise transmission and bridges installation tolerances.
2 pcs required for inlet and outlet side application.



External wall shutter

VK 160 Ref. no. 00892
Automatic overpressure shutter for external wall connection of air outlet opening. Made of white plastic.



External wall cover grille

G 160 Ref. no. 00893
For covering and insertion in round ventilation openings. Made of break-resistant, white plastic.



Protection grille

MVS 160 Ref. no. 06074
For inlet and outlet side installation on fan.



Flexible cross talk silencer

FSD 160 Ref. no. 00678
Made of aluminium pipe with double-sided plug-in connectors. Sound insulation lining 50 mm thick, installation length 1 m.



Air filter box

LFBR 160 Coarse 70%* 08578
Large-surface, installation in round duct system.



Electric heating element

EHR-R 1.2/160 1.2 kW No. 09434
In duct casing made of galvanised steel sheet.



Warm water heating element

WHR 160 Ref. no. 09481
For installation in duct system.



Accessories for all types

Duct shutter

RSK 160 Ref. no. 05669
Automatic, made of metal.
For installation in pipeline.



Operating switch 0-1-2

MVB Ref. no. 06091
With functions On/Off, Low and high speed.



Transformer speed controller

TSW See type table
Five-step, for surface installation.



Electronic speed controller

ESU/ESA See type table
For flush/surface installation.



Electronic turn-off delay switch

ZNE Ref. no. 00342
With continuously variable turn-off delay periods.

* See product page for detailed description

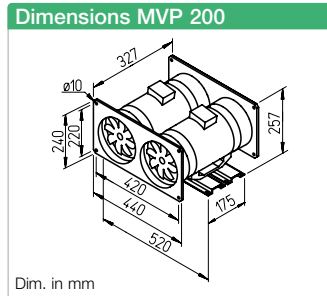
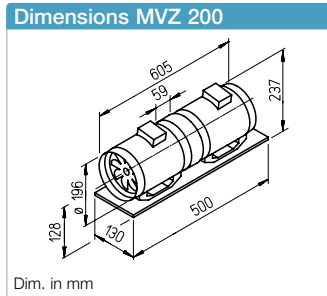
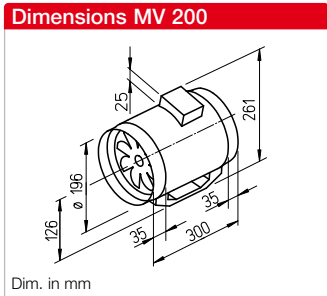

High pressure performance and high volume output with space-saving dimensions.
Specifically designed for direct insertion in duct systems. Various applications in commercial, industrial and residential areas.

Special features

- Low space requirement and minimal installation costs due to linear throughflow.
- No need for elaborate deflectors.
- Connectors on inlet and outlet side correspond to standard duct Ø.
- Comes with two performance levels; 100% speed-controllable as standard.
- Can be used in any position.
- Long-life ball bearings, designed for 30000 operating hours.
- Problem-free maintenance and cleaning without dismantling the duct system due to the removable fan unit.
- Fan unit with terminal box can be rotated into any position.
- Integrated mounting bracket for easy installation to walls and ceilings.

Common features

- Casing**
The fan unit can be removed from the duct casing with integ-

rated mounting bracket by loosening the clamp. All components are made of impact-resistant and corrosion-resistant plastic. Colour: Light grey.

- Power control**
With two performance levels as standard using an external operating switch MVB (accessories). Also with continuously variable control through electronic controller or five-step transformer.

- Motor**
Enclosed, ball bearing mounted motor with humidity protection, insulation class F, for continuous operation, maintenance-free and radio interference-free.

- Motor protection**
Through thermal overload protection in the winding.

- Noise**
See right page.

Description MV

- Impeller**
Optimised for high pressure performance and volume output, made of high-quality plastic.

- Electrical connection**
Spacious terminal box (IP44) on

outside of casing; can be rotated into any position.

- Installation**
No restrictions in any position (horizontal, vertical, diagonal) through corresponding installation for supply or extract ventilation. Installation in duct system, preferably away from the room to be ventilated for less noise.

Description MVZ

Two MV fans arranged in series, connected by a sleeve and mounted on a shared base plate. Delivered as a ready-to-install kit. The pressure performance is approximately doubled through series operation.

- Impeller**
As described on the left.

- Electrical connection**
Each fan is equipped with its own terminal box on the outside of the casing. A coupling relay must be provided according to the wiring diagram for controlling the two fans at two performance levels via one operating switch MVB (accessories) or one on-site changeover switch. The high performance level must

be connected when using speed controllers.

- Installation**
No restrictions in any position (horizontal, vertical, diagonal) through corresponding installation for supply or extract ventilation. Installation in duct system, preferably away from the room to be ventilated for less noise.

Description MVP

Two MV fans arranged in parallel are connected together by inlet and outlet side-mounted rectangular duct connection plates and screwed to mounting rails. Delivered as a ready-to-install kit. The volume output doubles during parallel operation (joint control).

- Impeller**
As described on the left.

- Power control/Connection**
Each fan is equipped with its own terminal box on the outside of the casing. A coupling relay must be provided according to the wiring diagram for controlling the two fans at two performance levels via one operating switch MVB (accessories) or one on-site changeover switch. The high performance level must be connected when using speed controllers. Each fan can also be individually controlled and connected to the second fan if necessary. In order to prevent backflow in this case, two duct shutters (type RSK, accessories) must be provided on the outlet side.

Type	Ref. no.	Connection Ø	Flow rate min./max.	Speed min./max.	Sound pres. lev at 1m		Power consum. min/max.	Current consum. min/max.	Wiring diagram	Max. air flow temp.	Wgt net aprx.	Transformer speed controller 5-step		Electronic* speed controller, cont. variable flush/ surf-mount.	
					Case radiation	Air noise min./max.						Type	Ref. no.	Type	Ref. no.
Single level round duct fan, 230 V, 50 Hz, Capacitor motor, IP44															
MV 200	06055	200	680/930	1780/2740	36/44	50/58	45/75	0.22/0.37	844.1	60	3.7	TSW 1.5	01495	ESU1/ESA1	00236/00238
Double pressure Two level fan unit, 230 V, 50 Hz, Capacitor motor, IP44															
MVZ 200	06062	200	755/900	1780/2740	44/51	55/62	90/150	0.44/0.74	845.1	60	8.5	TSW 1.5	01495	ESU1/ESA1	00236/00238
Double volume Parallel twin unit, 230 V, 50 Hz, Capacitor motor, IP44															
MVP 200	06069	-	1360/1860	1780/2740	39/47	53/61	90/150	0.44/0.74	845.1	60	11.2	TSW 1.5	01495	ESU1/ESA1	00236/00238

* Transformer control units must be provided in noise-relevant cases. Electronic phase angle control can cause disturbing magnetisation humming.

Performance curves MV 200 – Single level

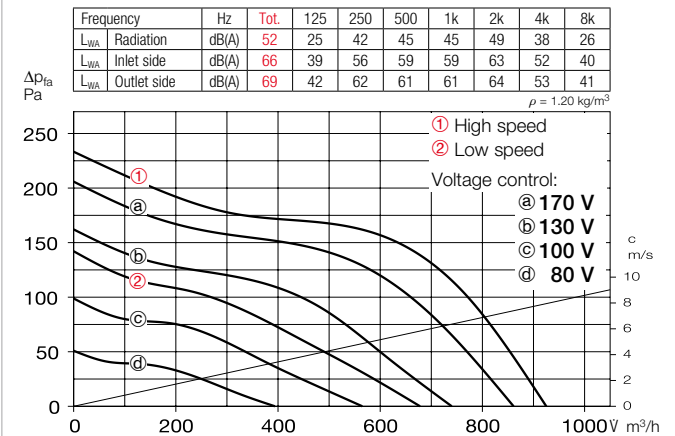

Performance curves MVZ 200 – Two level

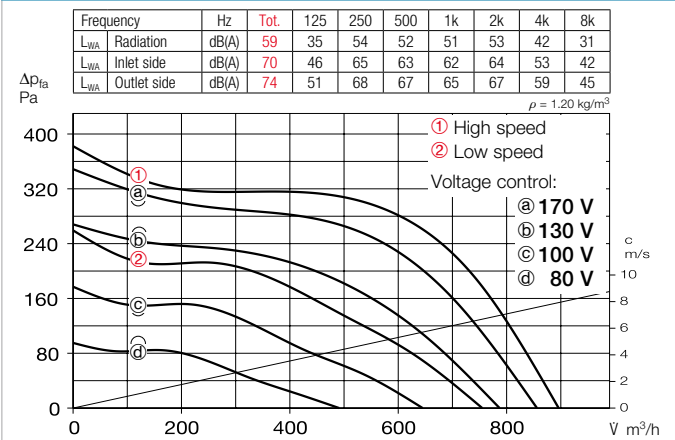

Performance curves MVP 200 – Parallel

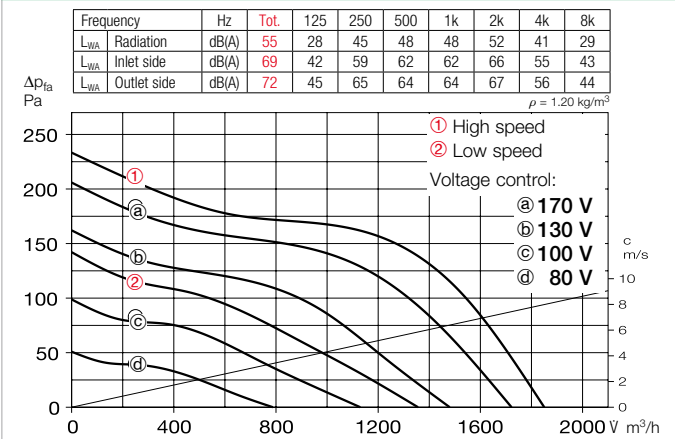

Noise

The total level and range are specified above the performance diagram for

- case-radiated sound power.
- Inlet/outlet side sound power in dB(A).
- The case-radiated noise and inlet/outlet side air noise as sound pressure at 1 m (free field conditions) are also specified in the type table.

Accessory details Page

Filter, heating elements and silencers	473 ff.
Temperature control systems for heating elements	479, 483 ff.
Flexible ventilation ducts, ventilation grilles, fittings, roof outlets	553 ff.
Disc valves	574 ff.
Speed controllers, controllers and switches	591 ff.

Accessories for MV and MVZ

Flexible connecting sleeve

FM 200 Ref. no. 01670
Includes 2 hose clamps; for installation between fan and duct system. Prevents structure-borne noise transmission and bridges installation tolerances.
2 pcs required for inlet and outlet side application.



External wall shutter

VK 200 Ref. no. 00758
Automatic overpressure shutter for external wall connection of air outlet opening. Made of plastic; colour: light grey.



External wall cover grille

RAG 200 Ref. no. 00750
For placement in front of air inlet and outlet openings in facades. Made of plastic; colour: light grey.



Protection grille

MVS 200 Ref. no. 06075
For inlet and outlet side installation on fan.



Flexible cross talk silencer

FSD 200 Ref. no. 00679
Made of aluminium pipe with double-sided plug-in connectors. Sound insulation lining 50 mm thick, installation length 1 m.



Air filter box

LFBR 200 Coarse 70%* 08579
Large-surface, installation in round duct system.



Electric heating element

EHR-R 1.2/200 1.2 kW No. 09436
In duct casing made of galvanised steel sheet.



Warm water heating element

WHR 200 Ref. no. 09482
For installation in duct system.



Accessories for all types

Duct shutter

RSK 200 Ref. no. 05074
Automatic, made of metal. For installation in pipeline.



Operating switch 0-1-2

MVB Ref. no. 06091
With functions On/Off, Low and high speed.



Transformer speed controller

TSW See type table
Five-step, for surface installation.



Electronic speed controller

ESU/ESA See type table

Electronic turn-off delay switch – für MV

ZNE Ref. no. 00342



* See product page for detailed description

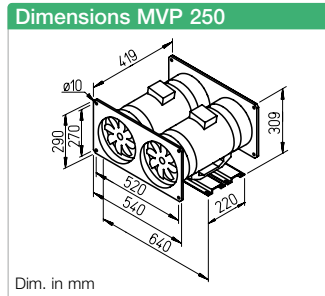
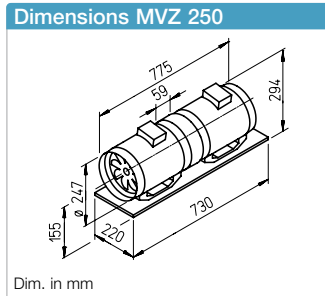
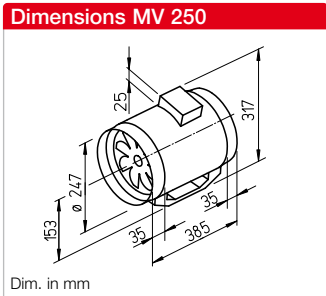

High pressure performance and high volume output with space-saving dimensions.
 Specifically designed for direct insertion in duct systems. Various applications in commercial, industrial and residential areas.

- **Special features**
 - Low space requirement and minimal installation costs due to in-line throughflow.
 - No need for elaborate deflectors.
 - Connectors on inlet and outlet side correspond to standard duct Ø.
 - Comes with two performance levels; 100% speed-controllable as standard.
 - Can be used in any position.
 - Long-life ball bearings, designed for 30000 operating hours.
 - Problem-free maintenance and cleaning without dismantling the duct system due to the removable fan unit.
 - Fan unit with terminal box can be rotated into any position.
 - Integrated mounting bracket for easy installation to walls and ceilings.

Common features

- **Casing**
 The fan unit can be removed from the duct casing with integ-

rated mounting bracket by loosening the clamp. All components are made of impact-resistant and corrosion-resistant plastic. Colour: Light grey.

- **Power control**
 With two performance levels as standard using an external operating switch MVB (accessories). Also with continuously variable control through electronic controller or five-step transformer.
- **Motor**
 Enclosed, ball bearing mounted motor with humidity protection, insulation class F, for continuous operation, maintenance-free and radio interference-free.
- **Motor protection**
 Through thermal contact connected to the winding in series, which responds if the temperature is too high. Recommissioning only after disconnection from the mains and motor cooling.

- **Noise**
 See right page.

Description MV

- **Impeller**
 Optimised for high pressure per-

formance and volume output, made of high-quality plastic.

- **Electrical connection**
 Spacious terminal box (IP44) on outside of casing; can be rotated into any position.
- **Installation**
 No restrictions in any position (horizontal, vertical, diagonal) through corresponding installation for supply or extract ventilation. Installation in duct system, preferably away from the room to be ventilated for less noise.

Description MVZ

Two MV fans arranged in series, connected by a sleeve and mounted on a shared base plate. Delivered as a ready-to-install kit. The pressure performance is approximately doubled through series operation.

- **Impeller**
 As described on the left.
- **Electrical connection**
 Each fan is equipped with its own terminal box on the outside of the casing. A coupling relay must be provided according to the wiring diagram for controlling the two fans

at two performance levels via one operating switch MVB (accessories) or one on-site changeover switch. The high performance level must be connected when using speed controllers.

- **Installation**
 No restrictions in any position (horizontal, vertical, diagonal) through corresponding installation for supply or extract ventilation. Installation in duct system, preferably away from the room to be ventilated for less noise.

Description MVP

Two MV fans arranged in parallel are connected together by inlet and outlet side-mounted rectangular duct connection plates and screwed to mounting rails. Delivered as a ready-to-install kit. The volume output doubles during parallel operation (joint control).

- **Impeller**
 As described on the left.
- **Power control/Connection**
 Each fan is equipped with its own terminal box on the outside of the casing. A coupling relay must be provided according to the wiring diagram for controlling the two fans at two performance levels via one operating switch MVB (accessories) or one on-site changeover switch. The high performance level must be connected when using speed controllers. Each fan can also be individually controlled and connected to the second fan if necessary. In order to prevent backflow in this case, two duct shutters (type RSK, accessories) must be provided on the outlet side.

Type	Ref. no.	Connection Ø	Flow rate min./max.	Speed min./max.	Sound pres. lev at 1m		Power consum. min/max.	Current consum. min/max.	Wiring diagram	Max. air flow temp.	Wgt net aprx.	Transformer speed controller 5-step		Electronic* speed controller, cont. variable flush/ surf-mount.	
					Case radiation	Air noise min./max.						Type	Ref. no.	Type	Ref. no.
mm															
m³/h															
min ⁻¹															
dB (A)															
dB (A)															
W															
A															
No.															
+ °C															
kg															
Type															
Ref. no.															
Type															
Ref. no.															
Single level round duct fan, 230 V, 50 Hz, Capacitor motor, IP44															
MV 250	06056	250	680/910	1850/2550	40/52	53/66	85/110	0.40/0.50	844.1	60	7.0	TSW 1.5	01495	ESU1/ESA1	00236/00238
Double pressure Two level fan unit, 230 V, 50 Hz, Capacitor motor, IP44															
MVZ 250	06063	250	710/900	1850/2550	46/56	57/67	170/220	0.80/1.00	845.1	60	17.6	TSW 1.5	01495	ESU3/ESA3	00237/00239
Double volume Parallel twin unit, 230 V, 50 Hz, Capacitor motor, IP44															
MVP 250	06070	-	1280/1820	1850/2550	43/55	56/69	170/220	0.80/1.00	845.1	60	18.7	TSW 1.5	01495	ESU3/ESA3	00237/00239

* Transformer control units must be provided in noise-relevant cases. Electronic phase angle control can cause disturbing magnetisation humming.

Performance curves MV 250 – Single level

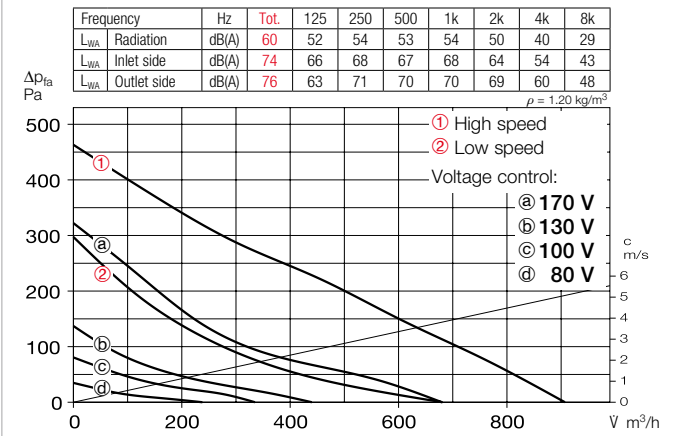

Performance curves MVZ 250 – Two level

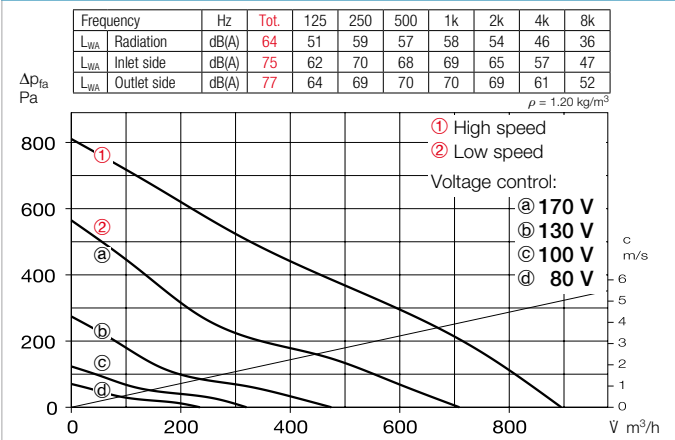

Performance curves MVP 250 – Parallel

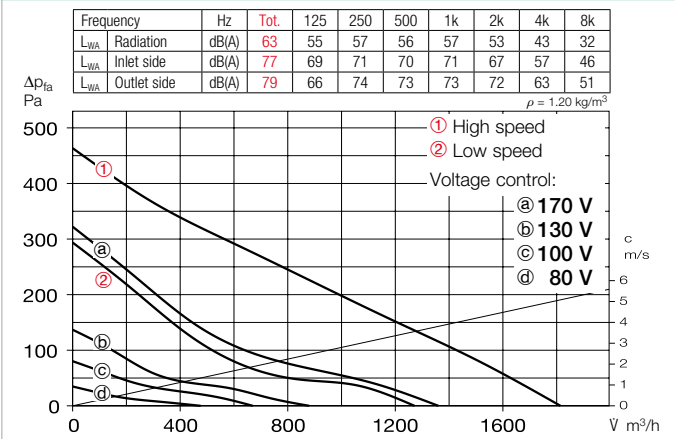

Noise

The total level and range are specified above the performance diagram for

- case-radiated sound power.
- Inlet/outlet side sound power in dB(A).
- The case-radiated noise and inlet/outlet side air noise as sound pressure at 1 m (free field conditions) are also specified in the type table.

Accessory details Page

Filter, heating elements and silencers	473 ff.
Temperature control systems for heating elements	479, 483 ff.
Flexible ventilation ducts, ventilation grilles, fittings, roof outlets	553 ff.
Disc valves	574 ff.
Speed controllers, controllers and switches	591 ff.

Accessories for MV and MVZ

Flexible connecting sleeve

FM 250 Ref. no. 01672
Includes 2 hose clamps; for installation between fan and duct system. Prevents structure-borne noise transmission and bridges installation tolerances.
2 pcs required for inlet and outlet side application.



External wall shutter

VK 250 Ref. no. 00759
Automatic overpressure shutter for external wall connection of air outlet opening. Made of plastic; colour: light grey.



External wall cover grille

RAG 250 Ref. no. 00751
For placement in front of air inlet and outlet openings in facades. Made of plastic; colour: light grey.



Protection grille

MVS 250 Ref. no. 06076
For inlet and outlet side installation on fan.



Flexible cross talk silencer

FSD 250 Ref. no. 00680
Made of aluminium pipe with double-sided plug-in connectors. Sound insulation lining 50 mm thick, installation length 1 m.



Air filter box

LFBR 250 Coarse 70%* 08580
Large-surface, installation in round duct system.



Electric heating element

EHR-R 6/250 6.0 kW No. 08712
In duct casing made of galvanised steel sheet.



Warm water heating element

WHR 250 Ref. no. 09483
For installation in duct system.



Accessories for all types

Duct shutter

RSK 250 Ref. no. 05673
Automatic, made of metal. For installation in pipeline.



Operating switch 0-1-2

MVB Ref. no. 06091
With functions On/Off, Low and high speed.



Transformer speed controller

TSW See type table
Five-step, for surface installation.



Electronic speed controller

ESU/ESA See type table
For flush/surface installation.



* See product page for detailed description

Explosion-proof circular duct fans according to Directive 2014/34/EU (ATEX).



■ Explosion protection

The requirements for facilities and equipment, which may present an ignition hazard, have been standardised across Europe and listed in the Directive 2014/34/EU (ATEX).

This contains the basic health and safety requirements for explosion-proof products and describes the conformity assessment procedure for units which are used in potentially explosive atmospheres.

■ RRK Ex from Helios

The compact fans RRK Ex are suitable for the transportation of potentially explosive gas, vapour and air mixtures and they meet the requirements of Directive 2014/34/EU (ATEX). They have ignition protection type “e” (= increased safety) and thus they correspond to unit group II, category 2G for operation in zones 1 and 2. Hazardous, potentially explosive atmospheres occur occasionally or rarely and briefly in these zones.

■ Ideal for commercial and industrial applications

When RRK Ex units are professionally installed, they meet all basic health and safety requirements.

RRK Ex units are suitable for the transportation of small volume flows for the ventilation of commercial and industrial rooms.

Ø 180 – 250 mm
V̇ = 290 – 870 m³/h



RRK 180 Ex / RRK 200 Ex / RRK 250 Ex



For the delivery of small volume flows for the ventilation of rooms and workspaces in commercial and industrial buildings where the occasional occurrence of potentially explosive atmospheres can be expected. Suitable for installation in the pipeline.

Approved for operation in zones 1 and 2 according to DIN EN 60079-10. Especially suitable for the ventilation of chemical and pharmaceutical laboratories, storerooms, workshops, dyeing facilities, battery rooms, etc.

Special features

- EC type-examination certificate provided according to Directive 2014/34/EU (ATEX).
- Explosion protection, increased safety according to DIN EN 60079-0, 60079-7, 1127-1, 14986.
- Operating voltage Alternating current ~230 V, 50 Hz.
- Preferably for direct installation in the pipeline. Cross-section reduction possible. See diagram RRK 180 Ex for perform. loss.
- Low space requirement and minimal installation costs due to linear throughflow.
- Installation poss. in any position.

Description

Casing and impeller

Made of high-quality, break-re-

sistant and antistatic plastic. Surface resistance lower than $10^9 \Omega$.

Motor

Closed design (IP54) for continuous operation. Ball bearing mounted, with moisture protection, maintenance-free and radio interference-free.

Electrical connection

Terminal box made of plastic, IP54, explosion-tested, on outside of duct casing.

Installation

In any position. For supply and extract ventilation through corresponding installation.

Installation information

The regulations DIN EN 60079-10 shall apply. According to this, overload protection must be provided for each fan by a motor protection circuit breaker, which must be triggered within the heating time specified in the test certificate in case of a short circuit. Fans must be protected by a protection grille or shutter against foreign bodies larger than 12 mm getting sucked in or falling in.

Approved operating mode according to DIN EN 60034-1/ VDE 0530 = S1 (continuous operation). Speed control is not permitted.

Dimensions RRK 180 Ex / RRK 200 Ex / RRK 250 Ex

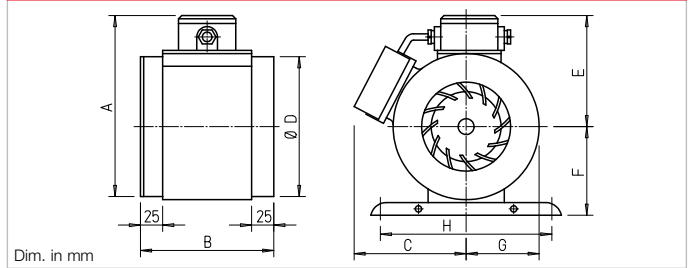

Type	RRK 180 Ex	RRK 200 Ex	RRK 250 Ex
A	231	278	304
B	164	267	205
C	160	195	210
D	Ø 178	Ø 198 ¹⁾	Ø 248
E	142	179	180
F	120	140	160
G	92	115	128
H	275	299	311

¹⁾ via reducers connected on the inlet and outlet side.

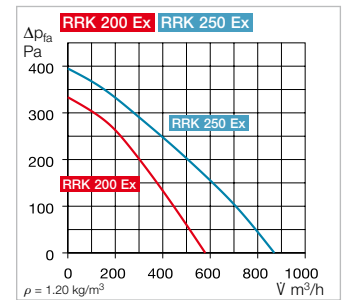
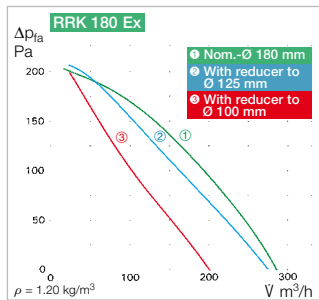

Accessories for RRK 180 Ex Reducer

RZ 180/125	Ref. no. 05876
RZ 180/100	Ref. no. 05877

Accessories for all types Mounting bracket

MK 4	Ref. no. 05824
------	----------------

Flexible connecting sleeve

For installation between fan and duct system.

FM 180 Ex	Ref. no. 01685
FM 200 Ex	Ref. no. 01686
FM 250 Ex	Ref. no. 01688

Protection grille

SGR 180 Ex	Ref. no. 05051
SGR 200 Ex	Ref. no. 05049
SGR 250 Ex	Ref. no. 05052

Duct shutter

RSK 180	Ref. no. 05662
RSK 200	Ref. no. 05074
RSK 250	Ref. no. 05673



Other accessories Page

Filters and silencers	473 ff.
Flexible ventilation ducts, ventilation grilles, fittings and roof outlets	553 ff.
Disc valves	574 ff.

Reference Page

Explosion protection	
- Zoning	14
- Directive 2014/34/EU	16

Type	Ref. no.	Impeller Ø	Flow rate free blowing	Rated speed	Sound power L _{WA}	Sound press. at 1 m	Power consum.	Current consum.	Wiring diagram	Max. air flow temp.	Weight net approx.
		mm	V m ³ /h	min ⁻¹	dB (A)	dB (A)	W	A	No.	+°C	kg
Explosion-proof, II 2G Ex eb h IIB + H₂ T3 Gb, Alternating current 230 V, 50 Hz, Protection category IP54											
RRK 180 Ex ¹⁾	05889	170	290	2780	66	58	50	0.25	453	50	3.0
RRK 200 Ex	05890	215	560	2860	64	56	200	0.92	453	50	5.5
RRK 250 Ex	05891	240	870	2860	77	69	300	1.40	453	50	7.0

¹⁾ Temperature class T4.

Helios InlineVent®. Robust and slimline.



InlineVent® circular duct fans from Helios combine the performance characteristics of centrifugal fans with the advantages of axial design. The linear flow pattern allows direct insertion in duct systems as well as easy, cost-effective installation.

Helios SlimVent
SlimVent centrifugal fans are ideal for limited installation spaces in residential, commercial and industrial buildings. Thanks to their compact dimensions, they can be easily installed below suspended ceilings, wall coverings, above and inside built-in cupboards or behind cavities.

Helios RR and RRK
For the delivery of medium and low air volumes against high resistances. For various applications in residential, commercial and industrial buildings. Available in galvanised steel sheet or corrosion-resistant plastic.

■ **InlineVent®-
circular duct fans RR
and SlimVent SVR**

– Energy efficient
EC version

Ø 100 – 315 mm
V = 340 – 2050 m³/h



376ff



■ **InlineVent® round
duct fans RR, RRK
and SlimVent SVR**

– Standard AC types

Ø 100 – 315 mm
V = 250 – 1260 m³/h

388ff

SVV 80



Performance curves SVV 80

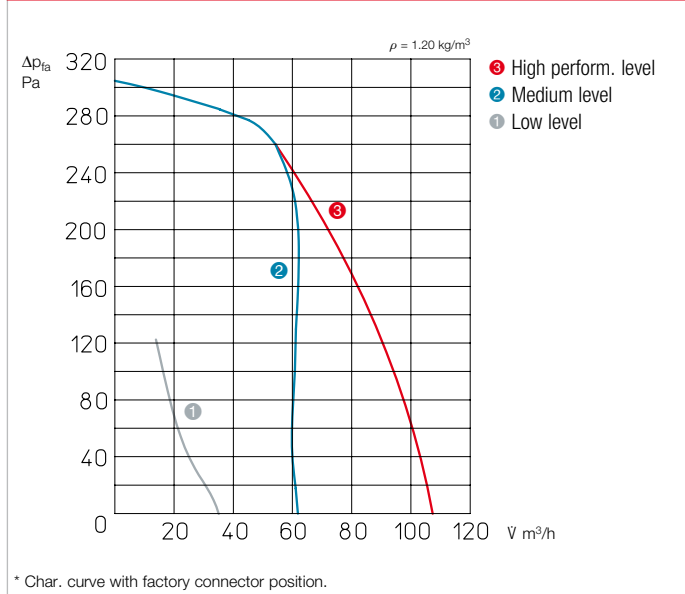

Dimensions SVV 80

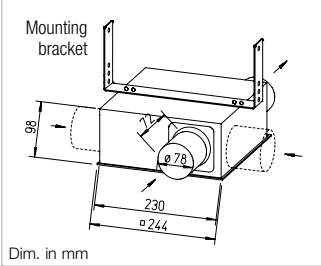

SVV 80 Connector position

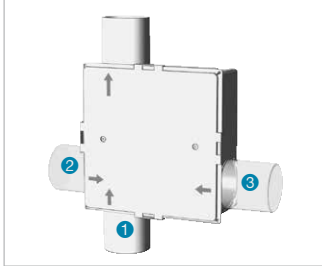

Connector position			Total output
No. 1	No. 2	No. 3	V m³/h
35	45	45	125
65	closed	60	125
zu	45	75	120
50	60	closed	110
110*	closed*	closed*	110*
closed	closed	110	110
closed	100	zu	100

Volume output depending on number of inlet side connectors and position.

Flat casing in compact design made of high-quality, impact-resistant plastic. Suitable for the ventilation of wet rooms, toilets, etc. in industrial, commercial and residential buildings. Standard delivery with inlet and outlet side connectors for standard duct Ø. One or two additional inlet connectors (accessories) can be inserted in the casing by removing the blind cover for the ventilation of multiple rooms.

- Casing**
Plastic cover easily removable for removal of the volute casing.
- Impeller**
Energy-saving centrifugal impeller with forward curved blades made of high-quality plastic.
- Motor**
Enclosed, ball bearing mounted energy-saving motor, maintenance-free.

- Motor protection**
Through thermal overload protection in the winding.
- Power control**
Manual three level operation using DSEL 3. Medium or low performance level can be connected for continuous operation and switched using DSEL 2.
- Electrical connection**
Terminal box (IP55) on outside of casing.
- Installation**
Possible in any position. The removable volute casing allows inspection and cleaning without dismantling the duct system. An inspection opening must be taken into account.
- Protection category**
IP54 with connected duct system.

- Delivery and accessories**
Delivery includes mounting bracket as well as inlet and outlet side connectors. One or two additional inlet connectors (accessories, DN 75/80 mm) can be inserted in the casing by removing the blind cover.
ELS-ZAS Ref. no. 08184

- Three level speed and operating switch with 0 position.**
Convenient flush-mounted speed switch. Room light not switchable in parallel. Installation in flush-mounted switch box.
Dim. mm (WxHxD) 80 x 80 x 23
DSEL 3 Ref. no. 01611



Round duct fans

Type	Ref. no.	Connection Ø	Flow rate free blowing*	Rated speed*	Sound pressure level Case-radiation*	Sound press. level Air noise inlet side*	Power consumption*	Current consumption*	Wiring diagram ¹⁾	Max. air flow temperature	Weight net aprx.
		mm	V m³/h	min ⁻¹	dB(A) in 3 m / 1 m	dB(A) in 3 m / 1 m	kW	A	No.	+ °C	kg
Single phase Alternating current, 230 V, 50 Hz, IP45											
SVV 80	02660	80	110 / 65 / 35	2710 / 1200 / 650	29/37 18/26 16/24	35/43 24/32 17/25	27 / 20 / 11	0.13 / 0.12 / 0.09	913	40	2.0

* Values refer to the three performance levels (see performance diagram).

¹⁾ With three level speed switch DSEL 3: Wiring diagram no. 914.

RR EC 100



SVR EC 100



SlimVent – Slimline EC space saver w/ retractable motor-impeller unit.



Dimensions RR EC 100

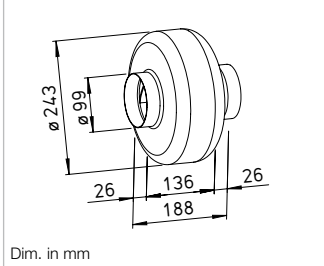

Dim. in mm

Dimensions SVR EC 100

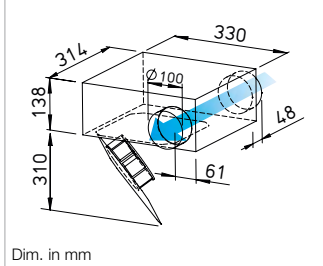

Dim. in mm

Energy-saving EC circular duct fans for the delivery medium and small air volumes against high resistances.

Specifically designed for direct insertion in duct systems. High pressure performance for overcoming friction losses, deflection losses and aggregate resistances. For various applications in commercial, industrial and residential areas.

Special features

- Highly efficient EC motor for the lowest operating costs.
- Low space requirement and minimal installation costs due to lie near throughflow.
- No need for elaborate deflectors.
- Connectors on inlet and outlet side correspond to standard duct Ø.
- Performance adjustment through 100% speed control.
- Can be used in any position.
- Wide range of accessories.
- Aerodynamically optimised casing design.

Common features RR EC and SVR EC

Drive

Energy-saving, speed-controllable EC external rotor motor in protection category IP44 with the highest level of efficiency. Maintenance-free and radio interference-free, ball bearing mounted.

Motor protection

Integrated electronic temperature monitoring system for EC motor and electronics.

Installation

No restrictions in any position (horizontal, vertical, diagonal) through corresponding installation for supply or extract ventilation. Installation in duct system, preferably away from the room to be ventilated for less noise.

Description RR EC

Casing

Made of galvanised steel sheet, robust for harsh operating conditions. Inlet and outlet side connection dimensions correspond to standard duct Ø.

Power control

Continuously variable speed control with internal (delivery) or external potentiometer or continuously variable speed control with universal control system (see table). Performance levels are shown in the performance curve as an example.

Electrical connection

Terminal box (IP54) on outside of casing.

Impeller

Centrifugal, with backward curved blades made of plastic. Dynamically balanced together with motor for low-noise operation, high level of efficiency.

Protection category

Protection category IP54 through inlet and outlet-side installation in a duct system which prevents the ingress of rainwater.

Description SVR EC

Casing

Flat casing in compact design made of galvanised steel sheet. Connectors and lip seal on inlet and outlet side for standard duct Ø. The retractable motor-impeller unit allows inspection and cleaning without dismantling components. The swivelling range must be considered for the inspection opening.

Power control

Continuously variable speed control with internal (delivery) or external potentiometer or continuously variable speed control with universal control system (see table). Performance levels are shown in the performance curve as an example.

Electrical connection

Terminal box (IP54) on external cable.

Impeller

Energy-saving centrifugal impeller with backward curved blades made of high-quality plastic. Dynamically balanced together with motor for low-noise operation.

Protection category

IP44 with connected duct system.

Noise

The total level and range are specified above the performance diagram for:

- Case-radiated sound power
- Inlet side sound power
- Outlet side sound power.

The case-radiated noise as sound pressure at 1 m (free field conditions) is also specified in the type table and the table below the performance curve.

Type	Ref. no.	Connection Ø	Flow rate Free blowing	Rated speed	Sound press. case radiation	Power consum.	Current consum.	Wiring diagram	Max. air flow temp.	Wgt net appr.	Universal control system		Speed potentiometer			
											Type	Ref. no.	flush-mount.	surf-mount.	Type	Ref. no.
Type RR EC, Single-phase alternating current, 230 V, 50/60 Hz, EC motor, IP44																
RR EC 100	05804	100	370	3640	46	0.10	0.80	979	60	2.5	EUR EC ¹⁾²⁾	01347	PU 10 ¹⁾	01734	PA 10 ¹⁾	01735
Type SVR EC, Single-phase alternating current, 230 V, 50/60 Hz, EC motor, IP44																
SVR EC 100	06124	100	390	3600	52	0.090	0.76	979	60	5.3	EUR EC ¹⁾²⁾	01347	PU 10 ¹⁾	01734	PA 10 ¹⁾	01735

¹⁾ Multiple EC fans can normally be connected. ²⁾ alternative electronic diff. pressure/ temperature controller (EDR/ETR, No. 01437/01438) or three level speed switch (SU/SA, No. 04266/04267), see accessories.

* See ERP product data sheet at www.HeliosSelect.de.

Performance curves RR EC 100

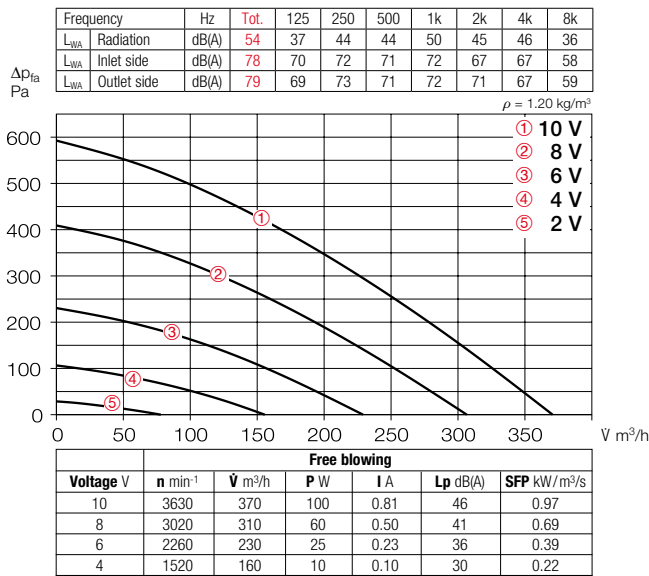

Performance curves SVR EC 100

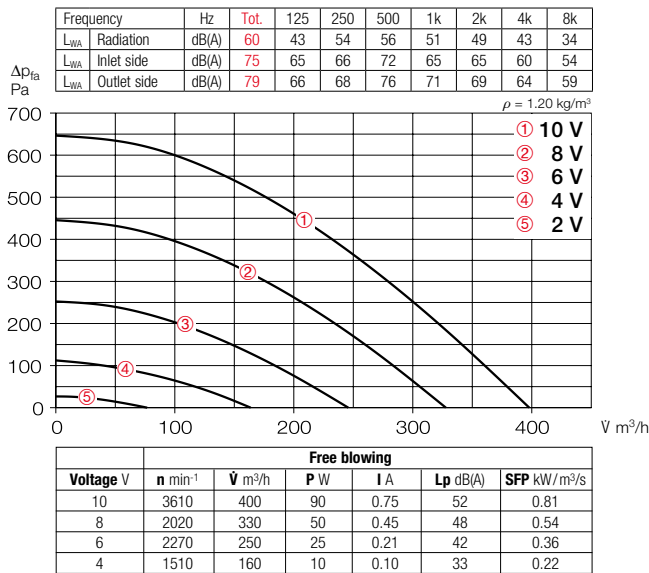

Other accessories Page

- Filters, heating elements and silencers 473 ff.
- Temperature control systems for heating elements 479, 483 ff.
- Flexible ventilation ducts, ventilation grilles, fittings, roof outlets 553 ff.
- Disc valves 574 ff.
- Universal control system, electronic controllers, speed potentiometer 605 ff.

Accessories

Pipe clamp connectors

BM 100 Ref. no. 05075
For structure-borne noise-free connection of fan and piping and for suspension (1 set = 2 pcs). Mount ventilation duct and fan connector at a distance and fold sleeve over during installation.

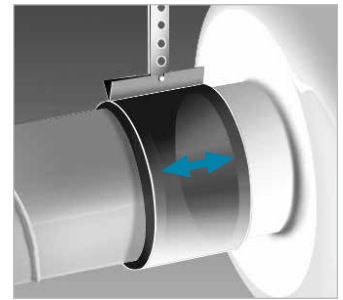

Mounting bracket for RR EC

MK 4 Ref. no. 05824



External wall shutter

VK 100 Ref. no. 00757
Automatic made of plastic, white.



External wall cover grille

G 100 Ref. no. 00796
Made of plastic, white.



Protection grille

SGR 100 Ref. no. 05063
For inlet and outlet side installation. Made of powder-coated steel wire.



Duct shutter

RSKK 100 Ref. no. 05106
Automatic, made of plastic



Flexible cross talk silencer

FSD 100 Ref. no. 00676
Made of aluminium pipe with double-sided plug-in connectors. Sound insulation lining 50 mm thick, installation length 1 m.



Air filter box

LFBR 100 Coarse 70%* 08576
LFBR 100 ePM1 50%* 08530
Air filter with large surface area, for installation in pipeline.



Electric heating element

EHR-R 0.4/100 0.4 kW No. 08708
In duct casing made of galvanised steel sheet.



Temperature control system for electric heating element

EHR-R
EHS Ref. no. 05002



Warm water heating element

WHR 100 Ref. no. 09479
Compact heat exchanger for installation in duct system.



Temperature control system for warm water heating element

WHST 300 T38 Ref. no. 08817

* See product page 476 for detailed description.

RR EC 125



SVR EC 125



SlimVent – Slimline EC space saver w/ retractable motor-impeller unit.

Dimensions RR EC 125

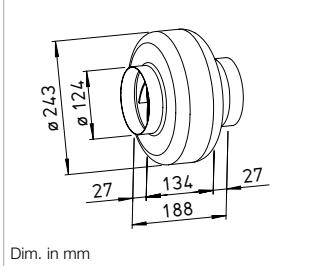

Dim. in mm

Dimensions SVR EC 125

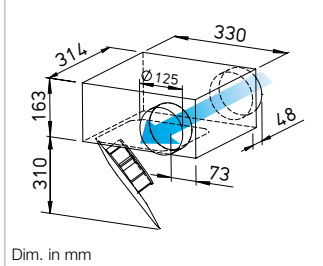

Dim. in mm

Energy-saving EC circular duct fans for the delivery medium and small air volumes against high resistances.

Specifically designed for direct insertion in duct systems. High pressure performance for overcoming friction losses, deflection losses and aggregate resistances. For various applications in commercial, industrial and residential areas.

Special features

- Highly efficient EC motor for the lowest operating costs.
- Low space requirement and minimal installation costs due to lip-near throughflow.
- No need for elaborate deflectors.
- Connectors on inlet and outlet side correspond to standard duct Ø.
- Performance adjustment through 100% speed control.
- Can be used in any position.
- Wide range of accessories.
- Aerodynamically optimised casing design.

Common features RR EC and SVR EC

Drive

Energy-saving, speed-controllable EC external rotor motor in protection category IP44 with the highest level of efficiency. Maintenance-free and radio interference-free, ball bearing mounted.

Motor protection

Integrated electronic temperature monitoring system for EC motor and electronics.

Installation

No restrictions in any position (horizontal, vertical, diagonal) through corresponding installation for supply or extract ventilation. Installation in duct system, preferably away from the room to be ventilated for less noise.

Description RR EC

Casing

Made of galvanised steel sheet, robust for harsh operating conditions. Inlet and outlet side connection dimensions correspond to standard duct Ø.

Power control

Continuously variable speed control with internal (delivery) or external potentiometer or continuously variable speed control with universal control system (see table). Performance levels are shown in the performance curve as an example.

Electrical connection

Terminal box (IP54) on outside of casing.

Impeller

Centrifugal, with backward curved blades made of plastic. Dynamically balanced together with motor for low-noise operation, high level of efficiency.

Protection category

Protection category IP54 through inlet and outlet-side installation in a duct system which prevents the ingress of rainwater.

Description SVR EC

Casing

Flat casing in compact design made of galvanised steel sheet. Connectors and lip seal on inlet and outlet side for standard duct Ø. The retractable motor-impeller unit allows inspection and cleaning without dismantling components. The swivelling range must be considered for the inspection opening.

Power control

Continuously variable speed control with internal (delivery) or external potentiometer or continuously variable speed control with universal control system (see table). Performance levels are shown in the performance curve as an example.

Electrical connection

Terminal box (IP54) on external cable.

Impeller

Energy-saving centrifugal impeller with backward curved blades made of high-quality plastic. Dynamically balanced together with motor for low-noise operation.

Protection category

IP44 with connected duct system.

Noise

The total level and range are specified above the performance diagram for:

- Case-radiated sound power
 - Inlet side sound power
 - Outlet side sound power.
- The case-radiated noise as sound pressure at 1 m (free field conditions) is also specified in the type table and the table below the performance curve.

Type	Ref. no.	Connection Ø	Flow rate Free blowing	Rated speed	Sound press. case radiation	Power consum.	Current consum.	Wiring diagram	Max. air flow temp.	Wgt net aprx.	Universal control system		Speed potentiometer			
											Type	Ref. no.	flush-mount.	Ref. no.	surf-mount.	Ref. no.
		mm	V m ³ /h	min ⁻¹	dB(A) in 1 m	kW	A	No.	+ °C	kg	Type	Ref. no.	Type	Ref. no.	Type	Ref. no.
Type RR EC, Single-phase alternating current, 230 V, 50/60 Hz, EC motor, IP44																
RR EC 125	05789	125	570	3600	45	0.10	0.83	979	60	2.5	EUR EC ¹⁾²⁾	01347	PU 10 ¹⁾	01734	PA 10 ¹⁾	01735
Type SVR EC, Single-phase alternating current, 230 V, 50/60 Hz, EC motor, IP44																
SVR EC 125	02531	125	520	3640	50	0.10	0.81	979	60	6.5	EUR EC ¹⁾²⁾	01347	PU 10 ¹⁾	01734	PA 10 ¹⁾	01735

1) Multiple EC fans can normally be connected. 2) alternative electronic diff. pressure/ temperature controller (EDR/ETR, No. 01437/01438) or three level speed switch (SU/SA, No. 04266/04267), see accessories.

Performance curves RR EC 125

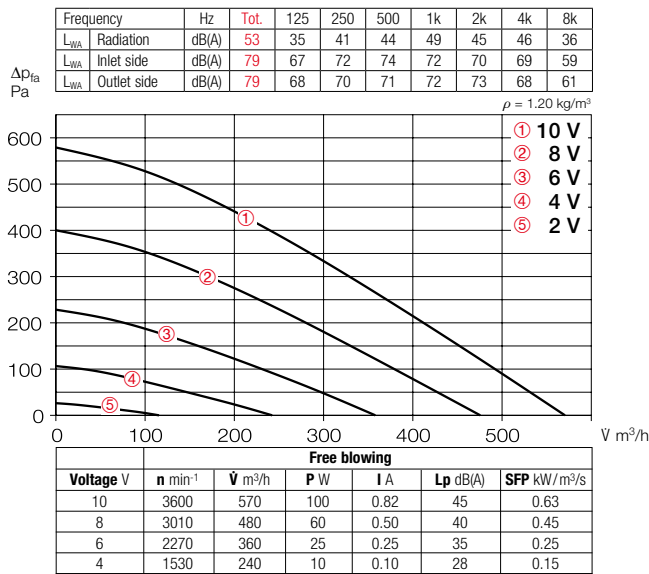

Performance curves SVR EC 125

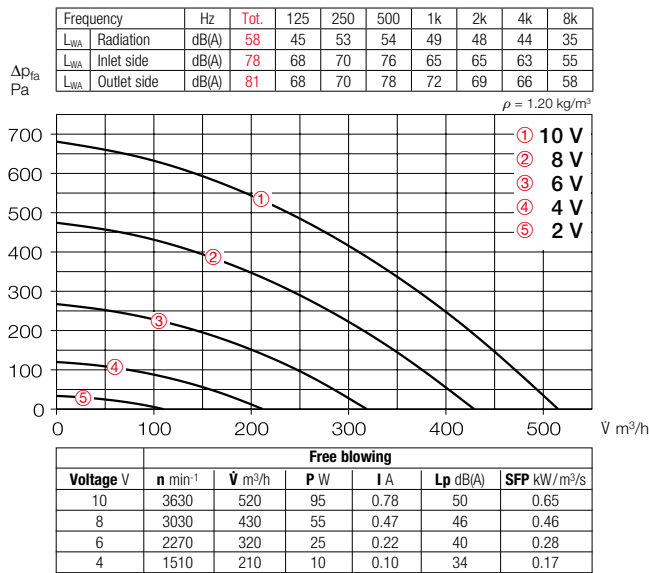

Other accessories Page

- Filters, heating elements and silencers 473 ff.
- Temperature control systems for heating elements 479, 483 ff.
- Flexible ventilation ducts, ventilation grilles, fittings, roof outlets 553 ff.
- Disc valves 574 ff.
- Universal control system, electronic controllers, speed potentiometer 605 ff.

Accessories

Pipe clamp connectors

BM 125 Ref. no. 05076
For structure-borne noise-free connection of fan and piping and for suspension (1 set = 2 pcs). Mount ventilation duct and fan connector at a distance and fold sleeve over during installation.

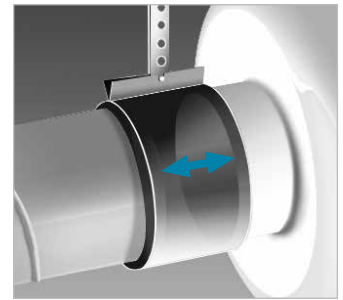

Mounting bracket for RR EC

MK 4 Ref. no. 05824



External wall shutter

VK 125 Ref. no. 00857
Automatic made of plastic, white.



External wall cover grille

G 160 Ref. no. 00893
Made of plastic, white.



Protection grille

SGR 125 Ref. no. 05064
For inlet and outlet side installation. Made of powder-coated steel wire.



Duct shutter

RSKK 125 Ref. no. 05107
Automatic, made of plastic



Flexible cross talk silencer

FSD 125 Ref. no. 00677
Made of aluminium pipe with double-sided plug-in connectors. Sound insulation lining 50 mm thick, installation length 1 m.



Air filter box

LFBR 125 Coarse 70%* 08577
LFBR 125 ePM1 50%* 08531
Air filter with large surface area, for installation in pipeline.



Electric heating element

EHR-R 0.8/125 0.8 kW No.08709
EHR-R 1.2/125 1.2 kW No.09433
- with integrated temp. control
EHR-R 0.8/125 TR 0.8 kW No.05293
Room or duct sensor (TFK/TFR, Accessories) required.



Temperature control system for electric heating element

EHR-R
EHS Ref. no. 05002



Warm water heating element

WHR 125 Ref. no. 09480
Compact heat exchanger for installation in duct system.



Temperature control system for warm water heating element

WHST 300 T38 Ref. no. 08817



* See product page 476 for detailed description.

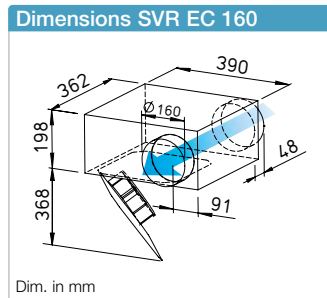
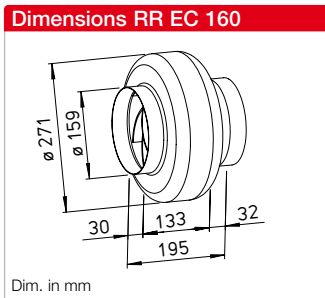

Energy-saving EC circular duct fans for the delivery medium and small air volumes against high resistances.

Specifically designed for direct insertion in duct systems. High pressure performance for overcoming friction losses, deflection losses and aggregate resistances. For various applications in commercial, industrial and residential areas.

Special features

- Highly efficient EC motor for the lowest operating costs.
- Low space requirement and minimal installation costs due to linear throughflow.
- No need for elaborate deflectors.
- Connectors on inlet and outlet side correspond to standard duct Ø.
- Performance adjustment through 100% speed control.
- Can be used in any position.
- Wide range of accessories.
- Aerodynamically optimised casing design.

Common features RR EC and SVR EC

Drive

Energy-saving, speed-controllable EC external rotor motor in protection category IP44 with the highest level of efficiency. Maintenance-free and radio interference-free, ball bearing mounted.

Motor protection

Integrated electronic temperature monitoring system for EC motor and electronics.

Installation

No restrictions in any position (horizontal, vertical, diagonal) through corresponding installation for supply or extract ventilation. Installation in duct system, preferably away from the room to be ventilated for less noise.

Description RR EC

Casing

Made of galvanised steel sheet, robust for harsh operating conditions. Inlet and outlet side connection dimensions correspond to standard duct Ø.

Power control

Continuously variable speed control with internal (delivery) or external potentiometer or continuously variable speed control with universal control system (see table). Performance levels are shown in the performance curve as an example.

Electrical connection

Terminal box (IP54) on outside of casing.

Impeller

Centrifugal, with backward curved blades made of plastic. Dynamically balanced together with motor for low-noise operation, high level of efficiency.

Protection category

Protection category IP54 through inlet and outlet-side installation in a duct system which prevents the ingress of rainwater.

Description SVR EC

Casing

Flat casing in compact design made of galvanised steel sheet. Connectors and lip seal on inlet and outlet side for standard duct Ø. The retractable motor-impeller unit allows inspection and cleaning without dismantling components. The swivelling range must be considered for the inspection opening.

Power control

Continuously variable speed control with internal (delivery) or external potentiometer or continuously variable speed control with universal control system (see table). Performance levels are shown in the performance curve as an example.

Electrical connection

Terminal box (IP54) on external cable.

Impeller

Energy-saving centrifugal impeller with backward curved blades made of high-quality plastic. Dynamically balanced together with motor for low-noise operation.

Protection category

IP44 with connected duct system.

Noise

The total level and range are specified above the performance diagram for:

- Case-radiated sound power
 - Inlet side sound power
 - Outlet side sound power.
- The case-radiated noise as sound pressure at 1 m (free field conditions) is also specified in the type table and the table below the performance curve.

Type	Ref. no.	Connection Ø	Flow rate Free blowing	Rated speed	Sound press. case radiation	Power consum.	Current consum.	Wiring diagram	Max. air flow temp.	Wgt net aprx.	Universal control system		Speed potentiometer			
											Type	Ref. no.	flush-mount.	surf-mount.	Type	Ref. no.
		mm	V m³/h	min⁻¹	dB(A) in 1 m	kW	A	No.	+ °C	kg	Type	Ref. no.	Type	Ref. no.	Type	Ref. no.
Type RR EC, Single-phase alternating current, 230 V, 50/60 Hz, EC motor, IP44																
RR EC 160	05785	160	650	3640	44	0.10	0.82	979	60	2.8	EUR EC ¹⁾²⁾	01347	PU 10 ¹⁾	01734	PA 10 ¹⁾	01735
Type SVR EC, Single-phase alternating current, 230 V, 50/60 Hz, EC motor, IP44																
SVR EC 160 A	02535	160	580	3630	52	0.10	0.81	979	60	6.5	EUR EC ¹⁾²⁾	01347	PU 10 ¹⁾	01734	PA 10 ¹⁾	01735
SVR EC 160 B	02543	160	740	3110	54	0.12	0.98	979	60	6.9	EUR EC ¹⁾²⁾	01347	PU 10 ¹⁾	01734	PA 10 ¹⁾	01735

1) Multiple EC fans can normally be connected. 2) alternative electronic diff. pressure/ temperature controller (EDR/ETR, No. 01437/01438) or three level speed switch (SU/SA, No. 04266/04267), see accessories.

Performance curves RR EC 160

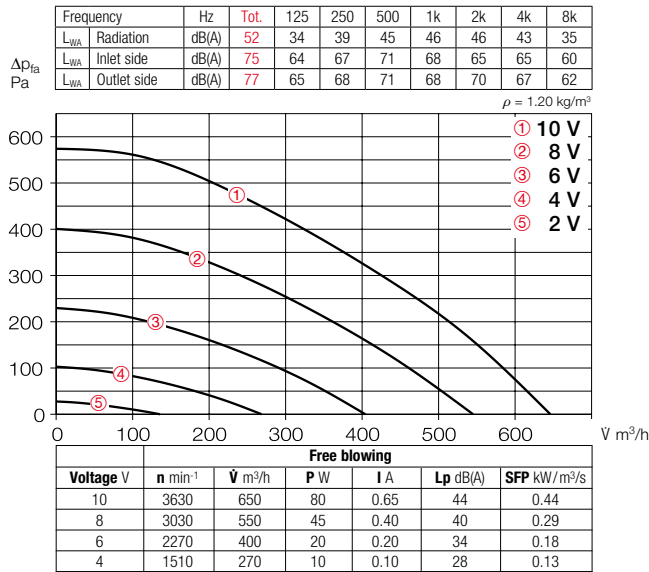

Performance curves SVR EC 160 A

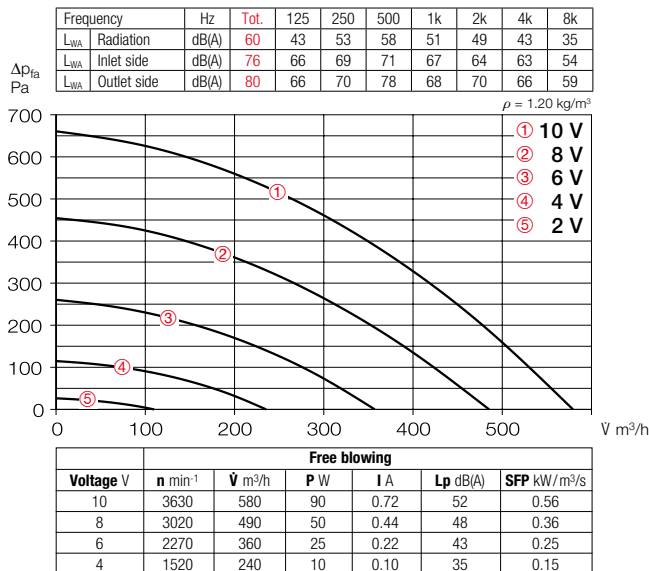

Performance curves SVR EC 160 B

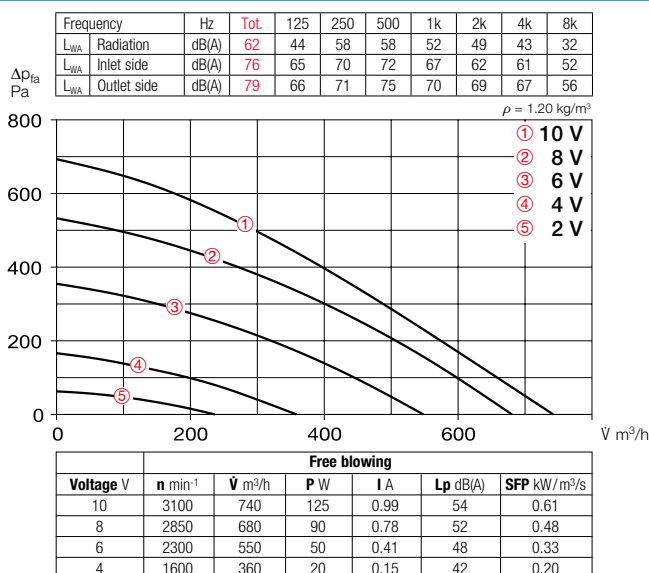

Accessories

Pipe clamp connectors

BM 160 Ref. no. 05077
For structure-borne noise-free connection of fan and piping and for suspension (1 set = 2 pcs). Mount ventilation duct and fan connector at a distance and fold sleeve over during installation.

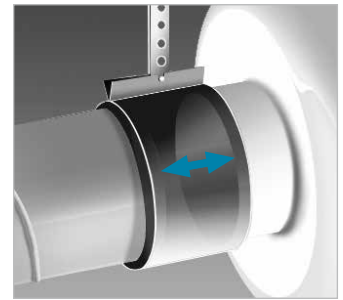

Mounting bracket for RR EC

MK 4 Ref. no. 05824



External wall shutter

VK 160 Ref. no. 00892
Automatic made of plastic, white.



External wall cover grille

G 160 Ref. no. 00893
Made of plastic, white.

Protection grille

SGR 160 Ref. no. 05069
For inlet and outlet side installation. Made of galvanised steel.



Duct shutter

RSK 160 Ref. no. 05669
Automatic, made of metal.



Flexible cross talk silencer

FSD 160 Ref. no. 00678
Made of aluminium pipe with double-sided plug-in connectors. Sound insulation lining 50 mm thick, installation length 1 m.



Air filter box

LFBR 160 Coarse 70%* 08578
LFBR 160 ePM1 50%* 08532
Air filter with large surface area, for installation in pipeline.



Electric heating element

EHR-R 1.2/160 1.2 kW No.09434
EHR-R 2.4/160 2.4 kW No.09435
EHR-R 5/160 5.0 kW No.08710
- with integrated temp. control
EHR-R 2.4/160 TR 2.4 kW No.05294
Room or duct sensor (TFK/TFR, Accessories) required.



Temperature control system for electric heating element

EHR-R
EHS Ref. no. 05002



Warm water heating element

WHR 160 Ref. no. 09481
Compact heat exchanger for installation in duct system.



Temperature control system for warm water heating element

WHST 300 T38 Ref. no. 08817



* See product page 476 for detailed description.

RR EC 200



SVR EC 200



SlimVent – Slimline EC space saver w/ retractable motor-impeller unit.



Dimensions RR EC 200

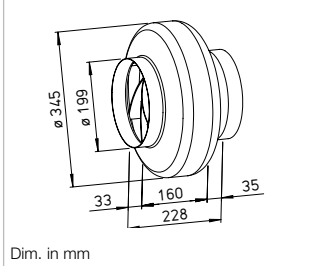

Dim. in mm

Dimensions SVR EC 200

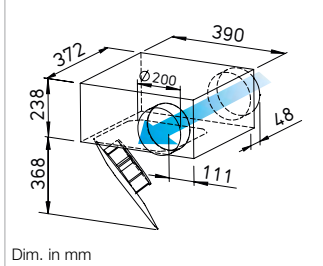

Dim. in mm

Energy-saving EC circular duct fans for the delivery medium and small air volumes against high resistances.

Specifically designed for direct insertion in duct systems. High pressure performance for overcoming friction losses, deflection losses and aggregate resistances. For various applications in commercial, industrial and residential areas.

Special features

- Highly efficient EC motor for the lowest operating costs.
- Low space requirement and minimal installation costs due to linear throughflow.
- No need for elaborate deflectors.
- Connectors on inlet and outlet side correspond to standard duct Ø.
- Performance adjustment through 100% speed control.
- Can be used in any position.
- Wide range of accessories.
- Aerodynamically optimised casing design.

Common features RR EC and SVR EC

Drive

Energy-saving, speed-controllable EC external rotor motor in protection category IP44 with the highest level of efficiency. Maintenance-free and radio interference-free, ball bearing mounted.

Motor protection

Integrated electronic temperature monitoring system for EC motor and electronics.

Installation

No restrictions in any position (horizontal, vertical, diagonal) through corresponding installation for supply or extract ventilation. Installation in duct system, preferably away from the room to be ventilated for less noise.

Description RR EC

Casing

Made of galvanised steel sheet, robust for harsh operating conditions. Inlet and outlet side connection dimensions correspond to standard duct Ø.

Power control

Continuously variable speed control with internal (delivery) or external potentiometer or continuously variable speed control with universal control system (see table). Performance levels are shown in the performance curve as an example.

Electrical connection

Terminal box (IP54) on outside of casing.

Impeller

Centrifugal, with backward curved blades made of plastic. Dynamically balanced together with motor for low-noise operation, high level of efficiency.

Protection category

Protection category IP54 through inlet and outlet-side installation in a duct system which prevents the ingress of rainwater.

Description SVR EC

Casing

Flat casing in compact design made of galvanised steel sheet. Connectors and lip seal on inlet and outlet side for standard duct Ø. The retractable motor-impeller unit allows inspection and cleaning without dismantling components. The swivelling range must be considered for the inspection opening.

Power control

Continuously variable speed control with internal (delivery) or external potentiometer or continuously variable speed control with universal control system (see table). Performance levels are shown in the performance curve as an example.

Electrical connection

Terminal box (IP54) on external cable.

Impeller

Energy-saving centrifugal impeller with backward curved blades made of high-quality plastic. Dynamically balanced together with motor for low-noise operation.

Protection category

IP44 with connected duct system.

Noise

The total level and range are specified above the performance diagram for:

- Case-radiated sound power
 - Inlet side sound power
 - Outlet side sound power.
- The case-radiated noise as sound pressure at 1 m (free field conditions) is also specified in the type table and the table below the performance curve.

Type	Ref. no.	Connection Ø	Flow rate Free blowing	Rated speed	Sound press. case radiation	Power consum.	Current consum.	Wiring diagram	Max. air flow temp.	Wgt net aprx.	Universal control system		Speed potentiometer			
											Type	Ref. no.	Type	Ref. no.	Type	Ref. no.
Type RR EC, Single-phase alternating current, 230 V, 50/60 Hz, EC motor, IP44																
RR EC 200 A	06121	200	985	2890	44	0.12	1.00	979	60	3.4	EUR EC ¹⁾²⁾	01347	PU 10 ¹⁾	01734	PA 10 ¹⁾	01735
RR EC 200 B	05786	200	1130	3200	47	0.17	1.37	979	60	4.0	EUR EC ¹⁾²⁾	01347	PU 10 ¹⁾	01734	PA 10 ¹⁾	01735
Type SVR EC, Single-phase alternating current, 230 V, 50/60 Hz, EC motor, IP44																
SVR EC 200 A	03310	200	850	2900	50	0.12	1.02	979	60	7.4	EUR EC ¹⁾²⁾	01347	PU 10 ¹⁾	01734	PA 10 ¹⁾	01735
SVR EC 200 B ³⁾	02539	200	980	2890	53	0.15	1.19	979	60	7.4	EUR EC ¹⁾²⁾	01347	PU 10 ¹⁾	01734	PA 10 ¹⁾	01735

¹⁾ Multiple EC fans can normally be connected. ²⁾ alternative electronic diff. pressure/ temperature controller (EDR/ETR, No. 01437/01438) or three level speed switch (SU/SA, No. 04266/04267), see accessories.

³⁾ Performance diagram at www.HeliosSelect.de

Performance curves RR EC 200 A

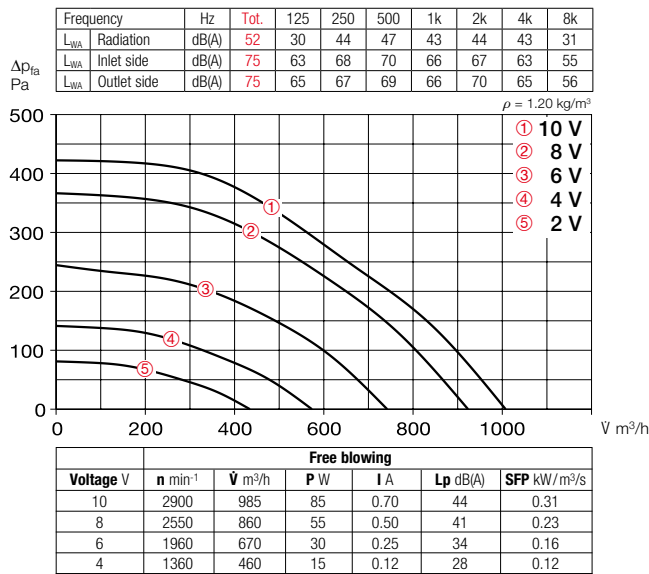

Performance curves RR EC 200 B

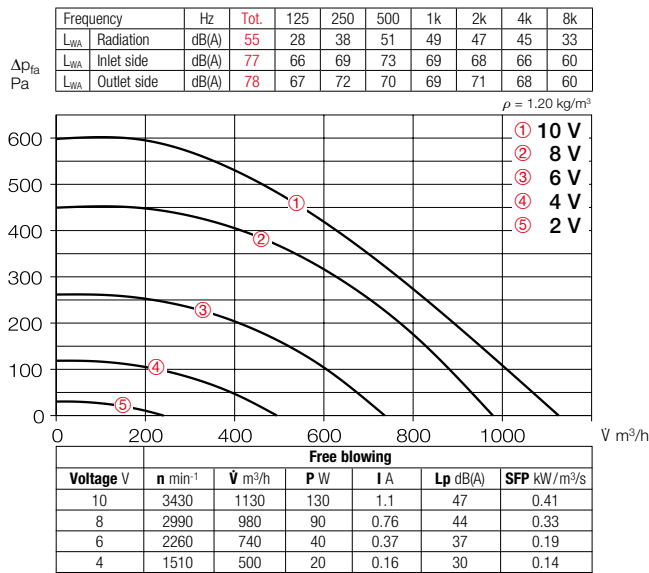

Performance curves SVR EC 200 A

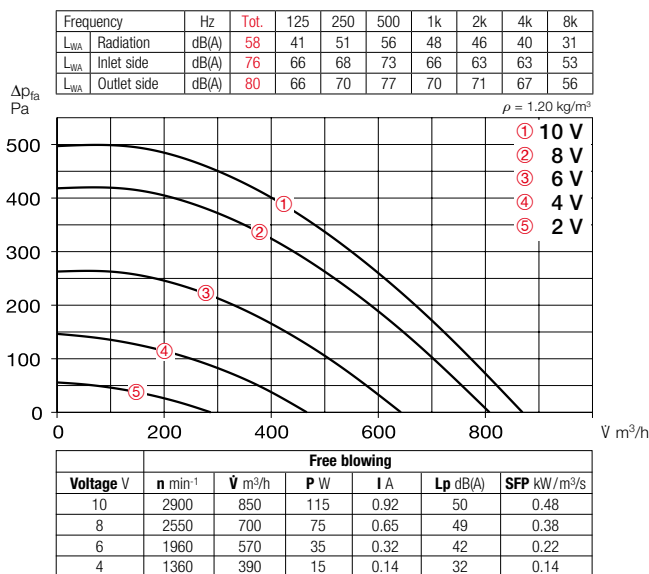

Accessories

Pipe clamp connectors

BM 200 Ref. no. 05078
For structure-borne noise-free connection of fan and piping and for suspension (1 set = 2 pcs). Mount ventilation duct and fan connector at a distance and fold sleeve over during installation.

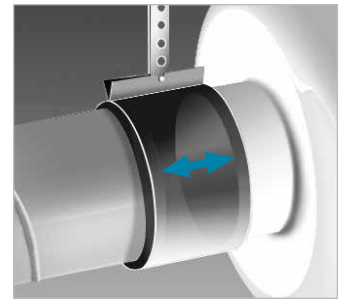

Mounting bracket for RR EC

MK 4 Ref. no. 05824



External wall shutter

VK 200 Ref. no. 00758
Made of plastic, light grey.



External wall cover grille

RAG 200 Ref. no. 00750
Made of plastic, light grey.

Protection grille

SGR 200 Ref. no. 05066
For inlet and outlet side installation. Made of galvanised steel.



Duct shutter

RSK 200 Ref. no. 05074
Automatic, made of metal.



Flexible cross talk silencer

FSD 200 Ref. no. 00679
Made of aluminium pipe with double-sided plug-in connectors. Sound insulation lining 50 mm thick, installation length 1 m.



Air filter box

LFBR 200 Coarse 70%* 08579
LFBR 200 ePM1 50%* 08533
Air filter with large surface area, for installation in pipeline.



Electric heating element

EHR-R 1.2/200 1.2 kW No.09436
EHR-R 2/200 2.0 kW No.09437
EHR-R 5/200 5.0 kW No.08711
– with integrated temp. control
EHR-R 5/200 TR 5.0 kW No.05295
Room or duct sensor (TFK/TFR, Accessories) required.



Temperature control system for electric heating element

EHR-R
EHS Ref. no. 05002



Warm water heating element

WHR 200 Ref. no. 09482
Compact heat exchanger for installation in duct system.



Temperature control system for warm water heating element

WHST 300 T38 Ref. no. 08817



* See product page 476 for detailed description.

EC round duct fans

RR EC 250



SVR EC 250



SlimVent – Slimline EC space saver w/ retractable motor-impeller unit.



Dimensions RR EC 250

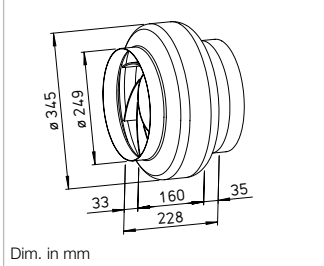

Dim. in mm

Dimensions SVR EC 250

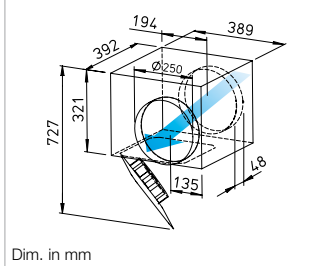

Dim. in mm

Energy-saving EC circular duct fans for the delivery medium and small air volumes against high resistances.

Specifically designed for direct insertion in duct systems. High pressure performance for overcoming friction losses, deflection losses and aggregate resistances. For various applications in commercial, industrial and residential areas.

Special features

- Highly efficient EC motor for the lowest operating costs.
- Low space requirement and minimal installation costs due to liear throughflow.
- No need for elaborate deflectors.
- Connectors on inlet and outlet side correspond to standard duct Ø.
- Performance adjustment through 100% speed control.
- Can be used in any position.
- Wide range of accessories.
- Aerodynamically optimised casing design.

Common features RR EC and SVR EC

Drive

Energy-saving, speed-controllable EC external rotor motor in protection category IP44 with the highest level of efficiency. Maintenance-free and radio interference-free, ball bearing mounted.

Motor protection

Integrated electronic temperature monitoring system for EC motor and electronics.

Installation

No restrictions in any position (horizontal, vertical, diagonal) through corresponding installation for supply or extract ventilation. Installation in duct system, preferably away from the room to be ventilated for less noise.

Description RR EC

Casing

Made of galvanised steel sheet, robust for harsh operating conditions. Inlet and outlet side connection dimensions correspond to standard duct Ø.

Power control

Continuously variable speed control with internal (delivery) or external potentiometer or continuously variable speed control with universal control system (see table). Performance levels are shown in the performance curve as an example.

Electrical connection

Terminal box (IP54) on outside of casing.

Impeller

Centrifugal, with backward curved blades made of plastic. Dynamically balanced together with motor for low-noise operation, high level of efficiency.

Protection category

Protection category IP54 through inlet and outlet-side installation in a duct system which prevents the ingress of rainwater.

Description SVR EC

Casing

Flat casing in compact design made of galvanised steel sheet. Connectors and lip seal on inlet and outlet side for standard duct Ø. The retractable motor-impeller unit allows inspection and cleaning without dismantling components. The swivelling range must be considered for the inspection opening.

Power control

Continuously variable speed control with internal (delivery) or external potentiometer or continuously variable speed control with universal control system (see table). Performance levels are shown in the performance curve as an example.

Electrical connection

Terminal box (IP54) on external cable.

Impeller

Energy-saving centrifugal impeller with backward curved blades made of high-quality plastic. Dynamically balanced together with motor for low-noise operation.

Protection category

IP44 with connected duct system.

Noise

The total level and range are specified above the performance diagram for:

- Case-radiated sound power
 - Inlet side sound power
 - Outlet side sound power.
- The case-radiated noise as sound pressure at 1 m (free field conditions) is also specified in the type table and the table below the performance curve.

Type	Ref. no.	Connection Ø	Flow rate Free blowing	Rated speed	Sound press. case radiation	Power consum.	Current consum.	Wiring diagram	Max. air flow temp.	Wgt net aprx.	Universal control system		Speed potentiometer			
											Type	Ref. no.	flush-mount.	surf-mount.	Type	Ref. no.
		mm	V m³/h	min⁻¹	dB(A) in 1 m	kW	A	No.	+ °C	kg	Type	Ref. no.	Type	Ref. no.	Type	Ref. no.
Type RR EC, Single-phase alternating current, 230 V, 50/60 Hz, EC motor, IP44																
RR EC 250 A	06122	250	1050	3830	44	0.12	1.04	979	60	3.4	EUR EC ¹⁾²⁾	01347	PU 10 ¹⁾	01734	PA 10 ¹⁾	01735
RR EC 250 B	05787	250	1200	3200	45	0.17	1.35	979	60	4.2	EUR EC ¹⁾²⁾	01347	PU 10 ¹⁾	01734	PA 10 ¹⁾	01735
Type SVR EC, Single-phase alternating current, 230 V, 50/60 Hz, EC motor, IP44																
SVR EC 250	02294	250	1180	2800	48	0.15	1.22	979	60	7.9	EUR EC ¹⁾²⁾	01347	PU 10 ¹⁾	01734	PA 10 ¹⁾	01735

1) Multiple EC fans can normally be connected. 2) alternative electronic diff. pressure/ temperature controller (EDR/ETR, No. 01437/01438) or three level speed switch (SU/SA, No. 04266/04267), see accessories.

Performance curves RR EC 250 A

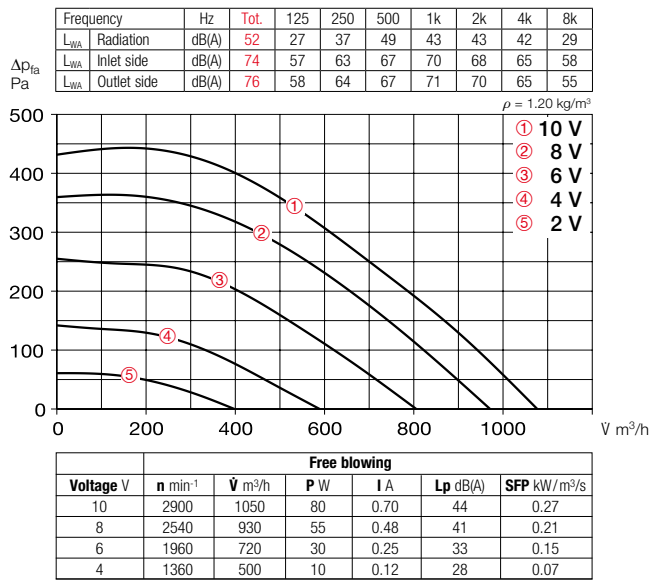

Performance curves RR EC 250 B

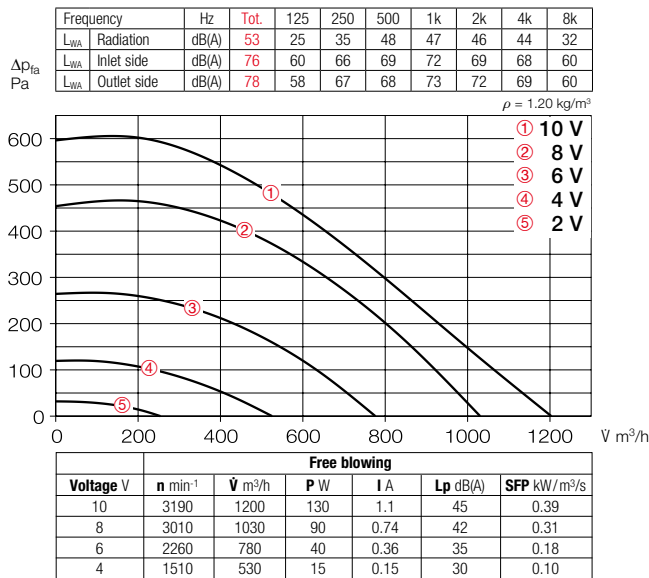

Performance curves SVR EC 250

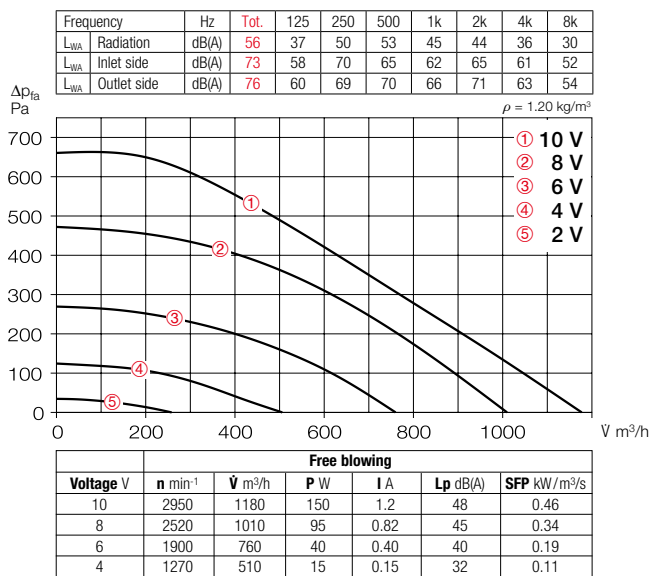

Accessories

Pipe clamp connectors

BM 250 Ref. no. 05079
For structure-borne noise-free connection of fan and piping and for suspension (1 set = 2 pcs). Mount ventilation duct and fan connector at a distance and fold sleeve over during installation.

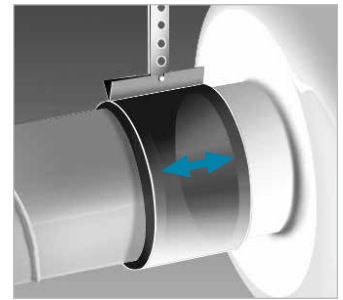

Mounting bracket

MK 4 Ref. no. 05824
Made of galvanised steel sheet.



External wall shutter

VK 250 Ref. no. 00759
Automatic made of plastic, light grey.



External wall cover grille

RAG 250 Ref. no. 00751
Made of plastic, light grey.

Protection grille

SGR 250 Ref. no. 05067
For inlet and outlet side installation. Made of galvanised steel.



Duct shutter

RSK 250 Ref. no. 05673
Automatic, made of metal.



Flexible cross talk silencer

FSD 250 Ref. no. 00680
Made of aluminium pipe with double-sided plug-in connectors. Sound insulation lining 50 mm thick, installation length 1 m.



Air filter box

LFBR 250 Coarse 70%* 08580
LFBR 250 ePM1 50%* 08534
Air filter with large surface area, for installation in pipeline.

Electric heating element

EHR-R 6/250 6.0 kW No.08712
- with integrated temp. control
EHR-R 6/250 TR 6.0 kW No.05296
Room or duct sensor (TFK/TFR, Accessories) required.



Temperature control system for electric heating element

EHR-R
EHS Ref. no. 05002



Warm water heating element

WHR 250 Ref. no. 09483
Compact heat exchanger for installation in duct system.



Temperature control system for warm water heating element

WHS HE Ref. no. 08319



* See product page 476 for detailed description.

RR EC 315



SVR EC 315



SlimVent – Slimline EC space saver w/ retractable motor-impeller unit.

Dimensions RR EC 315

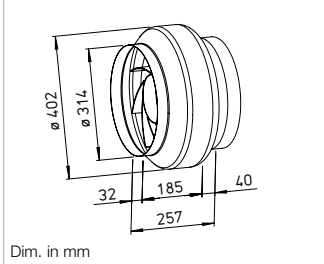

Dim. in mm

Dimensions SVR EC 315

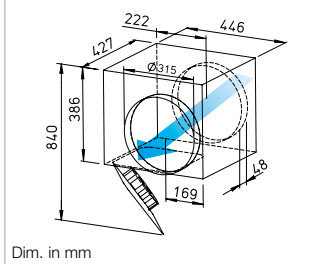

Dim. in mm

Energy-saving EC circular duct fans for the delivery medium and small air volumes against high resistances.

Specifically designed for direct insertion in duct systems. High pressure performance for overcoming friction losses, deflection losses and aggregate resistances. For various applications in commercial, industrial and residential areas.

Special features

- Highly efficient EC motor for the lowest operating costs.
- Low space requirement and minimal installation costs due to lie near throughflow.
- No need for elaborate deflectors.
- Connectors on inlet and outlet side correspond to standard duct Ø.
- Performance adjustment through 100% speed control.
- Can be used in any position.
- Wide range of accessories.
- Aerodynamically optimised casing design.

Common features RR EC and SVR EC

Drive

Energy-saving, speed-controllable EC external rotor motor in protection category IP44 with the highest level of efficiency. Maintenance-free and radio interference-free, ball bearing mounted.

Motor protection

Integrated electronic temperature monitoring system for EC motor and electronics.

Installation

No restrictions in any position (horizontal, vertical, diagonal) through corresponding installation for supply or extract ventilation. Installation in duct system, preferably away from the room to be ventilated for less noise.

Description RR EC

Casing

Made of galvanised steel sheet, robust for harsh operating conditions. Inlet and outlet side connection dimensions correspond to standard duct Ø.

Power control

Continuously variable speed control with internal (delivery) or external potentiometer or continuously variable speed control with universal control system (see table). Performance levels are shown in the performance curve as an example.

Electrical connection

Terminal box (IP54) on outside of casing.

Impeller

Centrifugal, with backward curved blades made of plastic, made of galvanised steel sheet for RR EC 315 B impeller. Dynamically balanced together with motor for low-noise operation, high level of efficiency.

Protection category

Protection category IP54 through inlet and outlet-side installation in a duct system which prevents the ingress of rainwater.

Description SVR EC

Casing

Flat casing in compact design made of galvanised steel sheet. Connectors and lip seal on inlet and outlet side for standard duct Ø.

The retractable motor-impeller unit allows inspection and cleaning without dismantling components. The swivelling range must be considered for the inspection opening.

Power control

Continuously variable speed control with internal (delivery) or external potentiometer or continuously variable speed control with universal control system (see table). Performance levels are shown in the performance curve as an example.

Electrical connection

Terminal box (IP54) on external cable.

Impeller

Energy-saving centrifugal impeller with backward curved blades made of high-quality plastic. Dynamically balanced together with motor for low-noise operation.

Protection category

IP44 with connected duct system.

Noise

The total level and range are specified above the performance diagram for:

- Case-radiated sound power
- Inlet side sound power
- Outlet side sound power.

The case-radiated noise as sound pressure at 1 m (free field conditions) is also specified in the type table and the table below the performance curve.

Type	Ref. no.	Connection Ø	Flow rate Free blowing	Rated speed	Sound press. case radiation	Power consum.	Current consum.	Wiring diagram	Max. air flow temp.	Wgt net aprx.	Universal control system		Speed potentiometer			
											Type	Ref. no.	Type	Ref. no.	Type	Ref. no.
		mm	V m³/h	min⁻¹	dB(A) in 1 m	kW	A	No.	+ °C	kg	Type	Ref. no.	Type	Ref. no.	Type	Ref. no.
Type RR EC, Single-phase alternating current, 230 V, 50/60 Hz, EC motor, IP44																
RR EC 315 A	05788	315	1910	2370	47	0.22	1.69	979	60	4.8	EUR EC ¹⁾²⁾	01347	PU 10 ¹⁾	01734	PA 10 ¹⁾	01735
RR EC 315 B	06123	315	2140	2880	48	0.32	2.30	979	60	7.6	EUR EC ¹⁾²⁾	01347	PU 10 ¹⁾	01734	PA 10 ¹⁾	01735
Type SVR EC, Single-phase alternating current, 230 V, 50/60 Hz, EC motor, IP44																
SVR EC 315 A	02669	315	1700	2570	52	0.21	1.65	979	60	13.6	EUR EC ¹⁾²⁾	01347	PU 10 ¹⁾	01734	PA 10 ¹⁾	01735
SVR EC 315 B ³⁾	00668	315	1940	2890	54	0.32	2.29	979	60	14.8	EUR EC ¹⁾²⁾	01347	PU 10 ¹⁾	01734	PA 10 ¹⁾	01735

¹⁾ Multiple EC fans can normally be connected. ²⁾ alternative electronic diff. pressure/ temperature controller (EDR/ETR, No. 01437/01438) or three level speed switch (SU/SA, No. 04266/04267), see accessories.

³⁾ Performance diagram at www.HeliosSelect.de

Performance curves RR EC 315 A

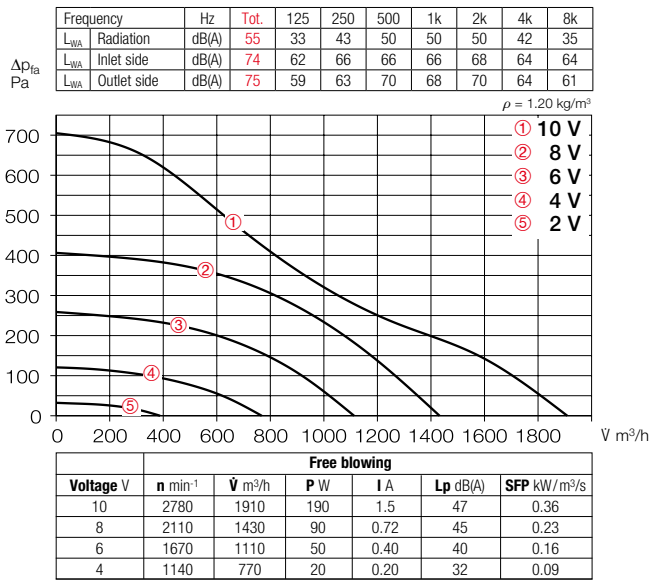

Performance curves RR EC 315 B

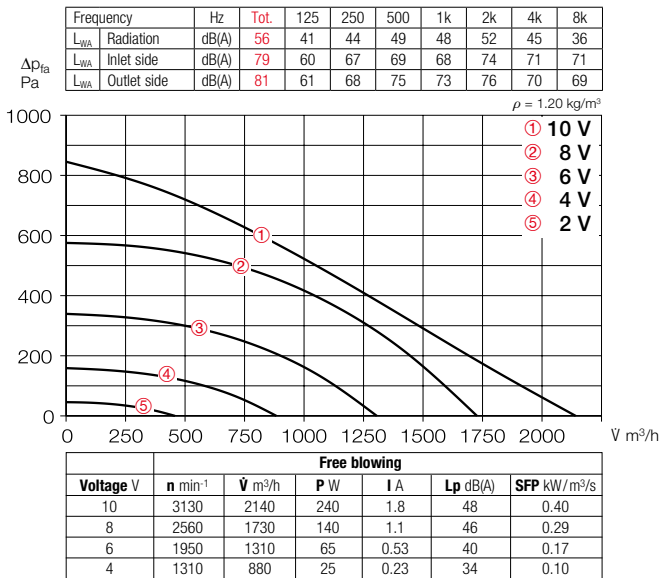

Performance curves SVR EC 315 A

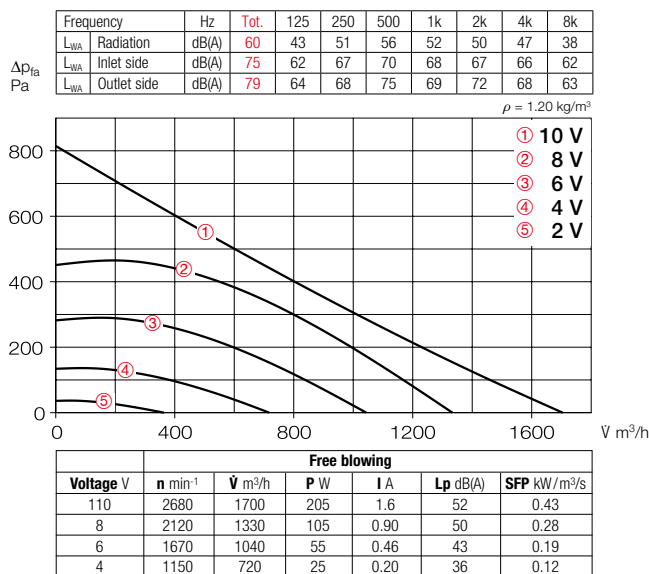

Accessories

Pipe clamp connectors

BM 315 Ref. no. 05080
For structure-borne noise-free connection of fan and piping and for suspension (1 set = 2 pcs). Mount ventilation duct and fan connector at a distance and fold sleeve over during installation.

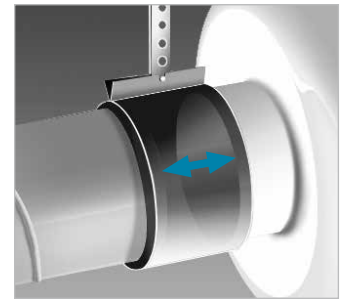

Mounting bracket

MK 4 Ref. no. 05824
Made of galvanised steel sheet.



External wall shutter

VK 315 Ref. no. 00760
Automatic made of plastic, light grey.



External wall cover grille

RAG 315 Ref. no. 00752
Made of plastic, light grey.

Protection grille

SGR 315 Ref. no. 05068
For inlet and outlet side installation. Made of galvanised steel.



Duct shutter

RSK 315 Ref. no. 05674
Automatic, made of metal.



Flexible cross talk silencer

FSD 315 Ref. no. 00681
Made of aluminium pipe with double-sided plug-in connectors. Sound insulation lining 50 mm thick, installation length 1 m.



Air filter box

LFBR 315 Coarse 70%* 08581
LFBR 315 ePM1 50%* 08535
Air filter with large surface area, for installation in pipeline.



Electric heating element

EHR-R 6/315 6.0 kW No.08713
- with integrated temp. control
EHR-R 6/315 TR 6.0 kW No.05301
Room or duct sensor (TFK/TFR, Accessories) required.



Temperature control system for electric heating element

EHR-R
EHS Ref. no. 05002

Warm water heating element

WHR 315 Ref. no. 09484
Compact heat exchanger for installation in duct system.



Temperature control system for warm water heating element

WHS HE Ref. no. 08319



* See product page 476 for detailed description.

RR 100



Efficiency class
C RR + accessories*

RRK 100



Alternative in corrosion-resistant and impact-resistant plastic casing.

SVR 100



Efficiency class
C SVR + accessories*

- **Power control**
From 0 – 100 % possible using electronic controller or step transformer (see table).
- **Electrical connection**
Terminal box (IP44) on outside of casing.
- **Impeller**
Centrifugal, with backward curved blades made of plastic. Directly pressed on motor and dynamically balanced as a unit. Low-noise, high level of efficiency.

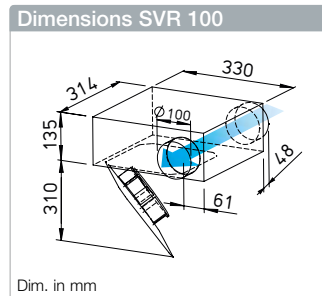
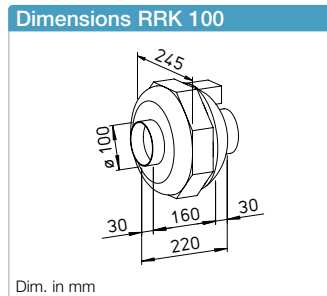
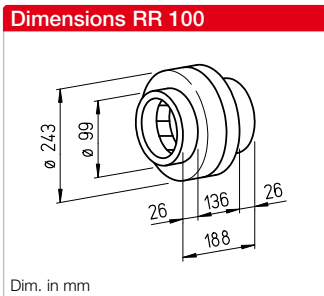

- **Protection category**
IP44

Description SVR

- **Casing**
Flat casing in compact design made of galvanised steel sheet. Connectors and lip seal on inlet and outlet side for standard duct Ø.
The retractable motor-impeller unit allows inspection and cleaning without dismantling components. The swivelling range must be considered for the inspection opening.

For the delivery of medium and small air volumes against high resistances.

Specifically designed for direct insertion in duct systems. High pressure performance for overcoming friction losses, deflection losses and aggregate resistances. For various applications in commercial, industrial and residential areas.

■ **Special features**

- Low space requirement and minimal installation costs due to linear throughflow.
- No need for elaborate deflectors.
- Connectors on inlet and outlet side correspond to standard duct Ø.
- Performance adjustment through 100% speed control.
- Can be used in any position.
- Wide range of accessories.
- Aerodynamically optimised casing design.

Common features

■ **Motor**

Enclosed, ball bearing mounted external rotor motor with humidity protection, insulation class F, for continuous operation, maintenance-free and radio interference-free.

■ **Motor protection**

Through built-in thermal contacts wired in series to the winding, automatic deactivation and reactivation after cooling.

■ **Installation**

No restrictions in any position (horizontal, vertical, diagonal) through corresponding installation for supply or extract ventilation (exception: SVR must not be installed with the retractable motor-impeller unit upward). Installation in duct system, preferably away from the room to be ventilated for less noise.

■ **Noise**

See page 390.

Description RR

■ **Casing**

Made of galvanised steel sheet, robust for harsh operating conditions. Inlet and outlet side connection dimensions correspond to standard duct Ø.

■ **Power control**

For type RR 100 A from 0–100% possible using electronic controller or step transformer (see table). For Type RR 100 C also two level operation using type DS 2/2 (accessories).
DS 2/2 Ref. no. 01267

■ **Electrical connection**

Terminal box (IP54) on outside of casing.

■ **Impeller**

Centrifugal, with backward curved blades made of plastic. Directly pressed on motor and dynamically balanced as a unit. Low-noise, high level of efficiency.

■ **Protection category**

Protection category IP44 through inlet and outlet-side installation in a duct system which prevents the ingress of rainwater.

Description RRK

■ **Casing**

All components made of corrosion-resistant and impact-resistant plastic. Six built-in guide blades additionally increase the level of efficiency. Colour: Silver-grey.

■ **Power control**

From 0 – 100 % possible using electronic controller or step transformer (see table) or two level operation with type DS 2/2 (accessories).
DS 2/2 Ref. no. 01267

■ **Electrical connection**

Terminal box (IP54) mounted to external cable.

■ **Impeller**

Energy-saving centrifugal impeller with backward curved blades made of high-quality plastic. Dynamically balanced for low-noise operation.

■ **Protection category**

IP44 with connected duct system.

Type	Ref. no.	Flow rate Free blowing	Rated speed	Sound press. case radiation	Power consum.	Power consump.		Wiring diagram	Max air flow temp.		Wgt net aprx.	Transformer speed controller 5-step	Electronic ³⁾ Speed controller, cont. var. flush-mount. / surf-mount.		
						at rated voltage	with control		at rated voltage	with control			Type	Ref. no.	Type
		V m ³ /h	min ⁻¹	dB(A) in 1 m	W	A	A	No.	+ °C	+ °C	kg	Type	Ref. no.	Type	Ref. no.
Type RR, Single-phase alternating current, 230 V, 50 Hz, Capacitor motor, IP44															
RR 100 A	05653	250	1730	36	41	0.18	0.18	508	60	60	2.9	TSW 0.3	03608	ESU 1 / ESA 1	00236 / 00238
RR 100 C ¹⁾	05654	330 ¹⁾ /220	2530 ¹⁾ /1655	42	62 ¹⁾ /40	0.27 ¹⁾ /0.18	0.27	934.1	60	60	2.9	TSW 0.3	03608	ESU 1 / ESA 1	00236 / 00238
Type RRK, Single-phase alternating current, 230 V, 50 Hz, Capacitor motor, IP44															
RRK 100	05973	290	2125	44	29	0.13	0.13	508	70	60	2.0	TSW 0.3	03608	ESU 1 / ESA 1	00236 / 00238
Type SVR, Single-phase alternating current, 230 V, 50 Hz, Capacitor motor, IP33															
SVR 100 C ²⁾	02658	310/245 ²⁾	2600/1940 ²⁾	45/40 ²⁾	58/40 ²⁾	0.25/0.18 ²⁾	0.23	934.1	60	60	4.8	TSW 1.5	01495	ESU 1 / ESA 1	00236 / 00238

¹⁾ Type with high speed; with additional energy-saving level as standard (see performance diagram). ²⁾ Values refer to the two performance levels (see performance diagram).

³⁾ Transformer control units must be provided in noise-relevant cases. Electronic phase angle control can cause disturbing magnetisation humming.

* See ErP product data sheet at www.HeliosSelect.de.

Performance curves RR 100 A

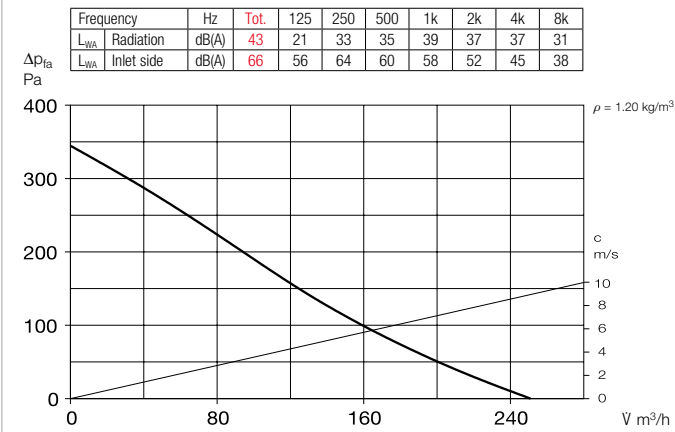

Performance curves RR 100 C

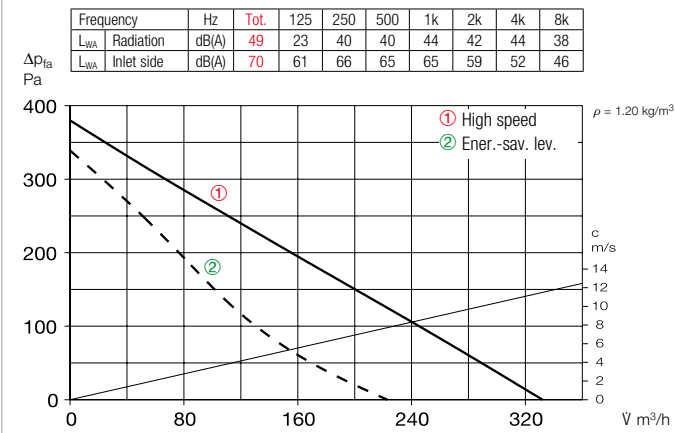

Performance curves RRK 100

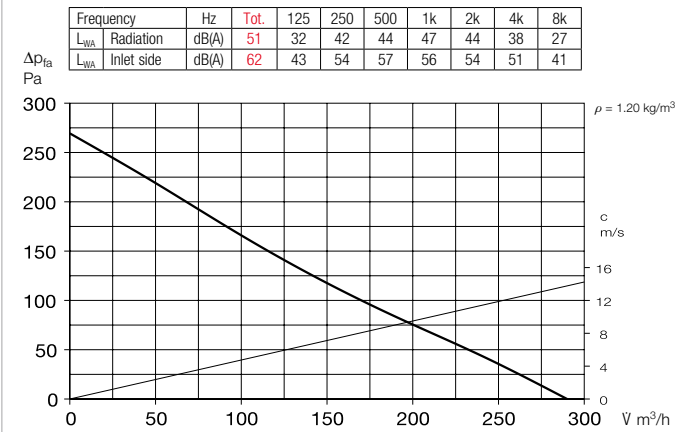

Performance curves SVR 100 C

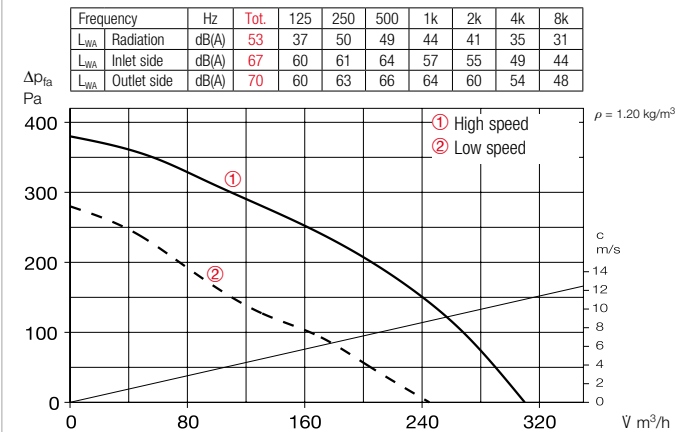

Accessories

Pipe clamp connectors

BM 100 Ref. no. 05075
For structure-borne noise-free connection of fan and piping and for suspension (1 set = 2 pcs). Mount ventilation duct and fan connector at a distance and fold sleeve over during installation.

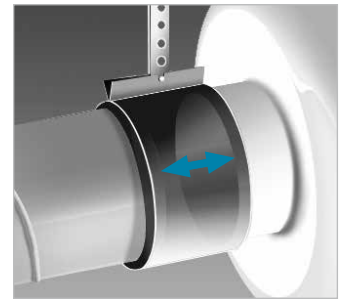

Mounting bracket for RR

MK 4 Ref. no. 05824
Mounting bracket for RRK
MK 1 Ref. no. 05821
Made of galvanised steel sheet.



External wall shutter

VK 100 Ref. no. 00757
Automatic made of plastic, white.



External wall cover grille

G 100 Ref. no. 00796
Made of plastic, white.



Protection grille

SGR 100 Ref. no. 05063
For inlet and outlet side installation.
Made of powder-coated steel wire.



Duct shutter

RSKK 100 Ref. no. 05106
Automatic, made of plastic.



Flexible cross talk silencer

FSD 100 Ref. no. 00676
Made of aluminium pipe with double-sided plug-in connectors. Sound insulation lining 50 mm thick, installation length 1 m.



Air filter box

LFBR 100 Coarse 70%* 08576
LFBR 100 ePM1 50%* 08530
Air filter with large surface area, for installation in pipeline.



Electric heating element

EHR-R 0.4/100 0.4 kW No. 08708
In duct casing made of galvanised steel sheet.



Temperature control system for electric heating element

EHR-R
EHS Ref. no. 05002



Warm water heating element

WHR 100 Ref. no. 09479
Compact heat exchanger for installation in duct system.



Temperature control system for warm water heating element

WHST 300 T38 Ref. no. 08817

* See product page 476 for detailed description.



■ **Impeller**
Centrifugal, with backward curved blades made of plastic. directly pressed on motor and dynamically balanced as a unit. Low-noise, high level of efficiency.

■ **Protection category**
IP44

Description SVR

■ **Casing**
Flat casing in compact design made of galvanised steel sheet. Connectors and lip seal on inlet and outlet side for standard duct Ø. The retractable motor-impeller unit allows inspection and cleaning without dismantling components. The swivelling range must be considered for the inspection opening.

■ **Power control**
From 0 – 100 % possible using electronic controller or step transformer (see table) or two level operation with type DS 2/2 (accessories).
DS 2/2 Ref. no. 01267

■ **Electrical connection**
Terminal box (IP54) mounted to external cable.

■ **Impeller**
Energy-saving centrifugal impeller with backward curved blades made of high-quality plastic. Dynamically balanced for low-noise operation.

■ **Protection category**
IP44 with connected duct system.

■ **Noise**
The total level and range are specified above the performance diagram for
 Case-radiated sound power
 Inlet/outlet side sound power in dB(A).
 The case-radiated noise and inlet/outlet side air noise as sound pressure at 1 m (free field conditions) are also specified in the type table.

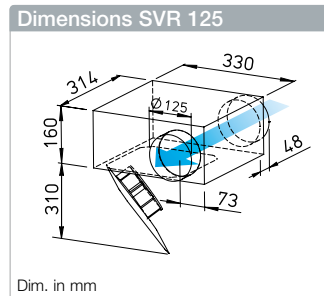
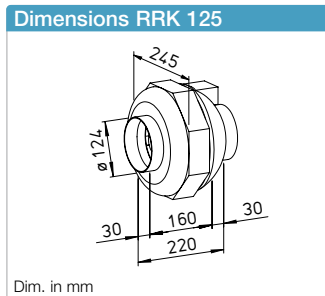
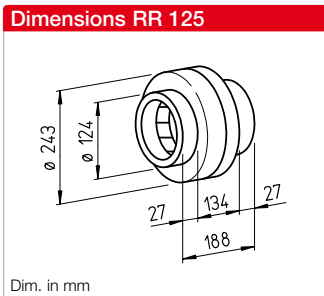

For the delivery of medium and small air volumes against high resistances.
Specifically designed for direct insertion in duct systems. High pressure performance for overcoming friction losses, deflection losses and aggregate resistances. For various applications in commercial, industrial and residential areas.

- **Special features**
- Low space requirement and minimal installation costs due to linear throughflow.
 - No need for elaborate deflectors.
 - Connectors on inlet and outlet side correspond to standard duct Ø.
 - Performance adjustment through 100% speed control.
 - Can be used in any position.
 - Wide range of accessories.
 - Aerodynamically optimised casing design.

Common features

■ **Motor**
Enclosed, ball bearing mounted external rotor motor with humidity protection, insulation class F, for continuous operation, maintenance-free and radio interference-free.

■ **Motor protection**
Through built-in thermal contacts wired in series to the winding, automatic deactivation and reactivation after cooling.

■ **Installation**
No restrictions in any position (horizontal, vertical, diagonal) through corresponding installation for supply or extract ventilation (exception: SVR must not be installed with the retractable motor-impeller unit upward). Installation in duct system, preferably away from the room to be ventilated for less noise.

Description RR

■ **Casing**
Made of galvanised steel sheet, robust for harsh operating conditions. Inlet and outlet side connection dimensions correspond to standard duct Ø.

■ **Power control**
From 0 – 100 % possible using electronic controller or step transformer (see table) or two level operation with type DS 2/2 (accessories).
DS 2/2 Ref. no. 01267

■ **Electrical connection**
Terminal box (IP54) on outside of casing.

■ **Impeller**
Centrifugal, with backward curved blades made of plastic. directly pressed on motor and dynamically balanced as a unit. Low-noise, high level of efficiency.

■ **Protection category**
Protection category IP44 through inlet and outlet-side installation in a duct system which prevents the ingress of rainwater.

Description RRK

■ **Casing**
All components made of corrosion-resistant and impact-resistant plastic. Six built-in guide blades additionally increase the level of efficiency. Colour: Silver-grey.

■ **Power control**
From 0 – 100 % possible using electronic controller or step transformer (see table).

■ **Electrical connection**
Terminal box (IP44) on outside of casing.

Type	Ref. no.	Flow rate	Rated speed	Sound press. case radiation	Power consum.	Power consump.		Wiring diagram	Max air flow temp.		Wgt net aprx.	Transformer speed controller 5-step	Electronic ³⁾ Speed controller, cont. var. flush-mount. / surf-mount.		
		Free blowing				at rated voltage	with control		at rated voltage	with control			Type	Ref. no.	Type
		V m³/h	min ⁻¹	dB(A) in 1 m	W	A	A	No.	+ °C	+ °C	kg	Type	Ref. no.	Type	Ref. no.
Type RR, Single-phase alternating current, 230 V, 50 Hz, Capacitor motor, IP44															
RR 125 C ¹⁾	05655	480 ¹⁾ /310	2480 ¹⁾ /1655	42	62 ¹⁾ /40	0.27 ¹⁾ /0.18	0.27	934.1	70	70	2.9	TSW 0.3	03608	ESU 1 / ESA 1	00236 / 00238
Type RRK, Single-phase alternating current, 230 V, 50 Hz, Capacitor motor, IP44															
RRK 125	05974	390	2635	36	42	0.19	0.19	508	70	60	2.5	TSW 0.3	03608	ESU 1 / ESA 1	00236 / 00238
Type SVR, Single-phase alternating current, 230 V, 50 Hz, Capacitor motor, IP33															
SVR 125 B ²⁾	02671	400/290 ²⁾	2570/1810 ²⁾	46/38 ²⁾	59/41 ²⁾	0.26/0.18 ²⁾	0.24	934.1	60	60	5.1	TSW 1.5	01495	ESU 1 / ESA 1	00236 / 00238

¹⁾ Type with high speed; with additional energy-saving level as standard (see performance diagram). ²⁾ Values refer to the two performance levels (see performance diagram).

³⁾ Transformer control units must be provided in noise-relevant cases. Electronic phase angle control can cause disturbing magnetisation humming.

* See ErP product data sheet at www.HeliosSelect.de.

Performance curves RR 125 C

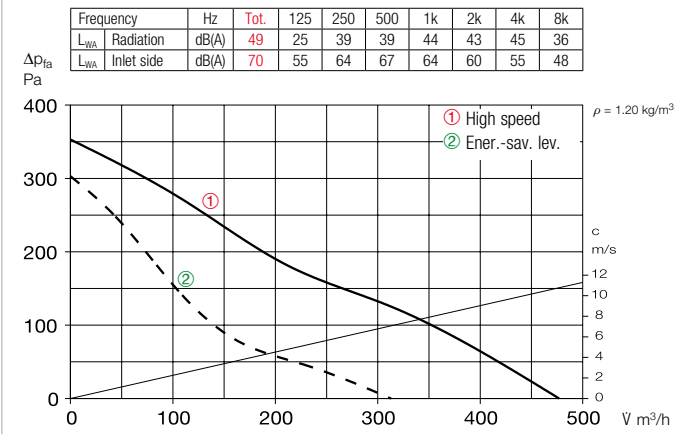

Performance curves RRK 125

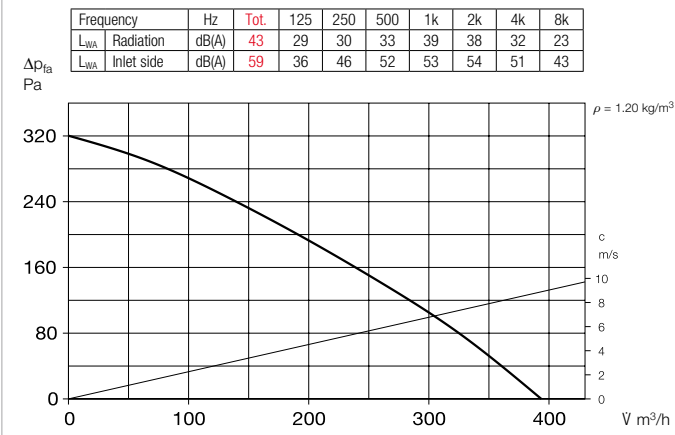

Performance curves SVR 125 B

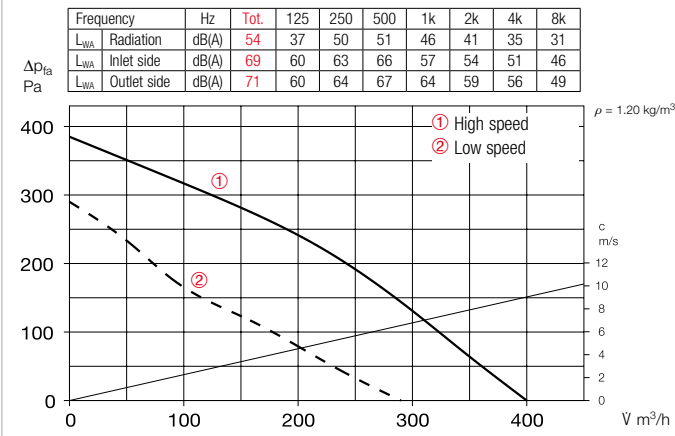

References	Page
Techn. description	352
Selection table	353
Planning information	10 ff.
Modular system	350

Other accessories	Page
Filter, heating elements and silencers	473 ff.
Temperature control systems for heating elements	479, 483 ff.
Flexible ventilation ducts, ventilation grilles, fittings, roof outlets	553 ff.
Disc valves	574 ff.
Speed controllers, controllers and switches	591 ff.

Accessories

Pipe clamp connectors

BM 125 Ref. no. 05076
For structure-borne noise-free connection of fan and piping and for suspension (1 set = 2 pcs). Mount ventilation duct and fan connector at a distance and fold sleeve over during installation.

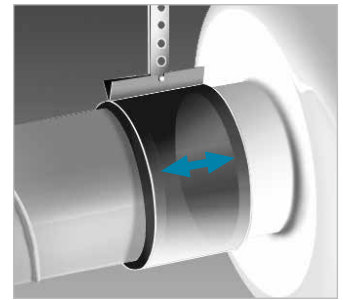

Mounting bracket for RR

MK 4 Ref. no. 05824
Mounting bracket for RRK
MK 1 Ref. no. 05821
Made of galvanised steel sheet.



External wall shutter

VK 125 Ref. no. 00857
Automatic made of plastic, white.



External wall cover grille

G 160 Ref. no. 00893
Made of plastic, white.



Protection grille

SGR 125 Ref. no. 05064
For inlet and outlet side installation. Made of powder-coated steel wire.



Duct shutter

RSKK 125 Ref. no. 05107
Automatic, made of plastic



Flexible cross talk silencer

FSD 125 Ref. no. 00677
Made of aluminium pipe with double-sided plug-in connectors. Sound insulation lining 50 mm thick, installation length 1 m.



Air filter box

LFBR 125 Coarse 70%* 08577
LFBR 125 ePM1 50%* 08531
Air filter with large surface area, for installation in pipeline.



Electric heating element

EHR-R 0.8/125 0.8 kW No.08709
EHR-R 1.2/125 1.2 kW No.09433
- with integrated temp. control
EHR-R 0.8/125 TR 0.8 kW No.05293
Room or duct sensor (TFK/TFR, Accessories) required.



Temperature control system for electric heating element

EHR-R
EHS Ref. no. 05002



Warm water heating element

WHR 125 Ref. no. 09480
Compact heat exchanger for installation in duct system.



Temperature control system for warm water heating element

WHST 300 T38 Ref. no. 08817

* See product page 476 for detailed description.

RR 160

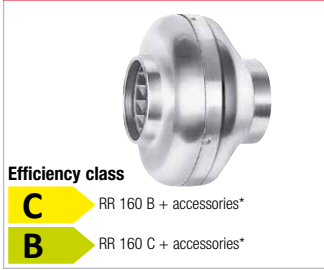

RRK 160



SVR 160



Dimensions RR 160

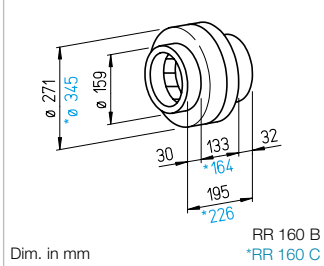

Dimensions RRK 160

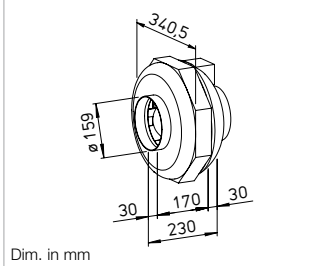

Dimensions SVR 160

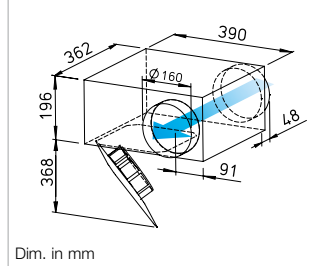

For the delivery of medium and small air volumes against high resistances.

Specifically designed for direct insertion in duct systems. High pressure performance for overcoming friction losses, deflection losses and aggregate resistances. For various applications in commercial, industrial and residential areas.

Special features

- Low space requirement and minimal installation costs due to linear throughflow.
- No need for elaborate deflectors.
- Connectors on inlet and outlet side correspond to standard duct Ø.
- Performance adjustment through 100% speed control.
- Can be used in any position.
- Wide range of accessories.
- Aerodynamically optimised casing design.

Common features

Motor

Enclosed, ball bearing mounted external rotor motor with humidity protection, insulation class F, for continuous operation, maintenance-free and radio interference-free.

Motor protection

Through built-in thermal contacts wired in series to the winding, automatic deactivation and reactivation after cooling.

Installation

No restrictions in any position (horizontal, vertical, diagonal) through corresponding installation for supply or extract ventilation (exception: SVR must not be installed with the retractable motor-impeller unit upward). Installation in duct system, preferably away from the room to be ventilated for less noise.

Noise

See page 390.

Description RR

Casing

Made of galvanised steel sheet, robust for harsh operating conditions. Inlet and outlet side connection dimensions correspond to standard duct Ø.

Power control

From 0 – 100 % possible using electronic controller or step transformer (see table) or two level operation with type DS 2/2 (accessories).

DS 2/2 Ref. no. 01267

Electrical connection

Terminal box (IP54) on outside of casing.

Impeller

Centrifugal, with backward curved blades made of plastic. Directly pressed on motor and dynamically balanced as a unit. Low-noise, high level of efficiency.

Protection category

Protection category IP44 through inlet and outlet-side installation in a duct system which prevents the ingress of rainwater.

Description RRK

Casing

All components made of corrosion-resistant and impact-resistant plastic. Six built-in guide blades additionally increase the level of efficiency. Colour: Silver-grey.

Power control

From 0 – 100 % possible using electronic controller or step transformer (see table).

Electrical connection

Terminal box (IP44) on outside of casing.

Impeller

Centrifugal, with backward curved blades made of plastic. Directly pressed on motor and dynamically balanced as a unit. Low-noise, high level of efficiency.

Protection category

IP44

Description SVR

Casing

Flat casing in compact design made of galvanised steel sheet. Connectors and lip seal on inlet and outlet side for standard duct Ø.

The retractable motor-impeller unit allows inspection and cleaning without dismantling components. The swivelling range must be considered for the inspection opening.

Power control

From 0 – 100 % possible using electronic controller or step transformer (see table) or two level operation with type DS 2/2 (accessories).

DS 2/2 Ref. no. 01267

Electrical connection

Terminal box (IP54) mounted to external cable.

Impeller

Energy-saving centrifugal impeller with backward curved blades made of high-quality plastic. Dynamically balanced for low-noise operation.

Protection category

IP44 with connected duct system.

Type	Ref. no.	Flow rate Free blowing	Rated speed	Sound press. case radiation	Power consum.	Power consump.		Wiring diagram	Max air flow temp.		Wgt net aprx.	Transformer speed controller 5-step	Electronic ³⁾ Speed controller, cont. var. flush-mount. / surf-mount.		
						at rated voltage	with control		at rated voltage	with control			Type	Ref. no.	Type
		V m ³ /h	min ⁻¹	dB(A) in 1 m	W	A	A	No.	+ °C	+ °C	kg	Type	Ref. no.	Type	Ref. no.
Type RR, Single-phase alternating current, 230 V, 50 Hz, Capacitor motor, IP44															
RR 160 B ¹⁾	05656	530 ¹⁾ /370	2540 ¹⁾ /1695	42	62 ¹⁾ /40	0.27 ¹⁾ /0.18	0.27	934.1	60	60	3.2	TSW 0.3	03608	ESU 1 / ESA 1	00236 / 00238
RR 160 C ¹⁾	05657	870 ¹⁾ /610	2480 ¹⁾ /1580	49	101 ¹⁾ /64	0.44 ¹⁾ /0.28	0.44	934.1	65	65	4.3	TSW 1.5	01495	ESU 1 / ESA 1	00236 / 00238
Type RRK, Single-phase alternating current, 230 V, 50 Hz, Capacitor motor, IP44															
RRK 160	05976	500	2380	32	53	0.24	0.24	508	70	60	2.7	TSW 0.3	03608	ESU 1 / ESA 1	00236 / 00238
Type SVR, Single-phase alternating current, 230 V, 50 Hz, Capacitor motor, IP33															
SVR 160 K ²⁾	02672	450/310 ²⁾	2550/1740 ²⁾	45/37 ²⁾	61/42 ²⁾	0.26/0.19 ²⁾	0.25	934.1	60	60	6.7	TSW 1.5	01495	ESU 1 / ESA 1	00236 / 00238

¹⁾ Type with high speed; with additional energy-saving level as standard (see performance diagram). ²⁾ Values refer to the two performance levels (see performance diagram).

³⁾ Transformer control units must be provided in noise-relevant cases. Electronic phase angle control can cause disturbing magnetisation humming.

* See ErP product data sheet at www.HeliosSelect.de.

Performance curves RR 160 B

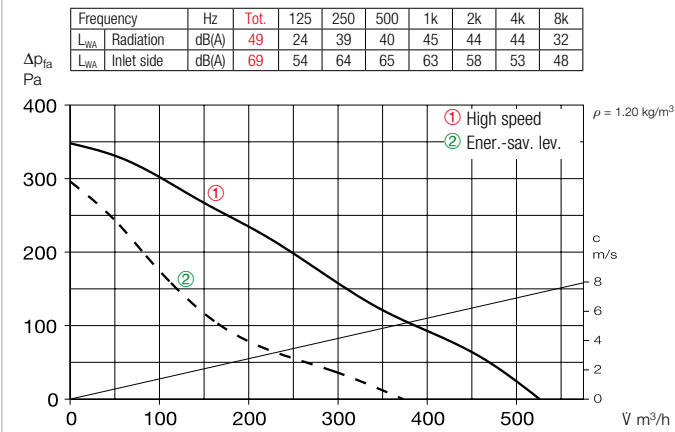

Performance curves RR 160 C

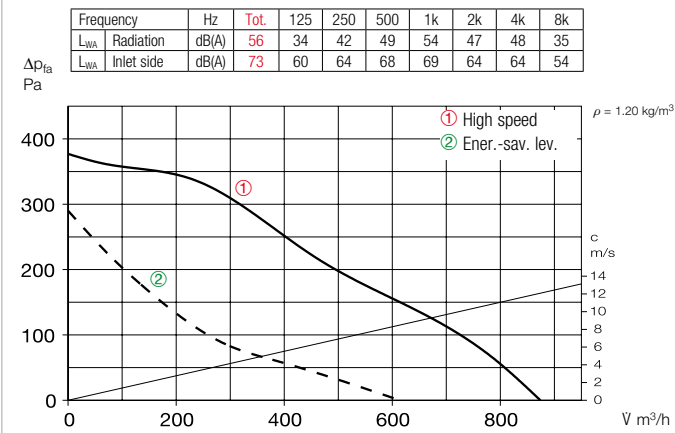

Performance curves RRK 160

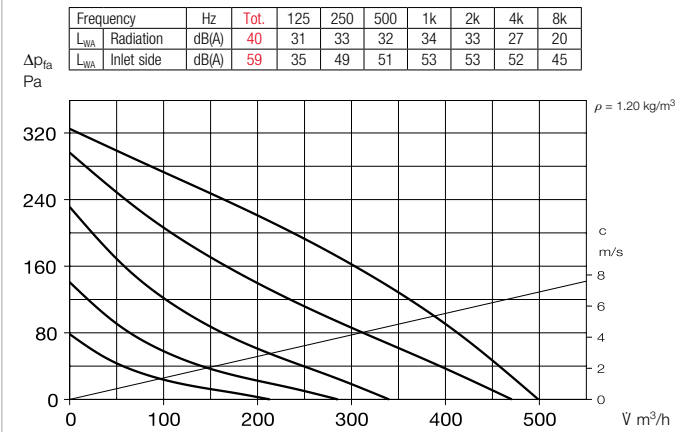

Performance curves SVR 160 K

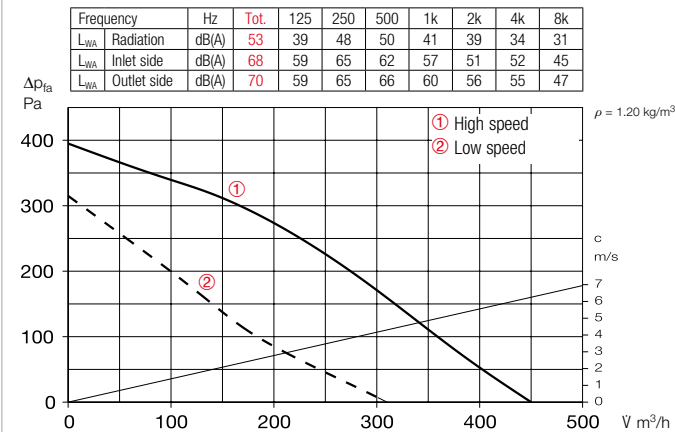

Accessories

Pipe clamp connectors

BM 160 Ref. no. 05077
For structure-borne noise-free connection of fan and piping and for suspension (1 set = 2 pcs). Mount ventilation duct and fan connector at a distance and fold sleeve over during installation.

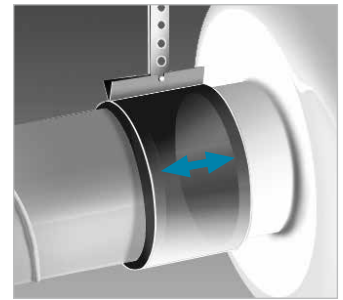

Mounting bracket for RR

MK 4 Ref. no. 05824

Mounting bracket for RRK

MK 2 Ref. no. 05822

Made of galvanised steel sheet.



External wall shutter

VK 160 Ref. no. 00892

Automatic made of plastic, white.



External wall cover grille

G 160 Ref. no. 00893

Made of plastic, white.



Protection grille

SGR 160 Ref. no. 05069

For inlet and outlet side installation. Made of galvanised steel.



Duct shutter

RSK 160 Ref. no. 05669

Automatic, made of metal.



Flexible cross talk silencer

FSD 160 Ref. no. 00678

Made of aluminium pipe with double-sided plug-in connectors. Sound insulation lining 50 mm thick, installation length 1 m.



Air filter box

LFBR 160 Coarse 70%* 08578

LFBR 160 ePM1 50%* 08532

Air filter with large surface area, for installation in pipeline.



Electric heating element

EHR-R 1.2/160 1.2 kW No.09434

EHR-R 2.4/160 2.4 kW No.09435

EHR-R 5/160 5.0 kW No.08710

– with integrated temp. control

EHR-R 2.4/160 TR 2.4 kW No.05294

Room or duct sensor (TFK/TFR, Accessories) required.



Temperature control system for electric heating element

EHR-R

EHS Ref. no. 05002



Warm water heating element

WHR 160 Ref. no. 09481

Compact heat exchanger for installation in duct system.



Temperature control system for warm water heating element

WHST 300 T38 Ref. no. 08817

* See product page 476 for detailed description.

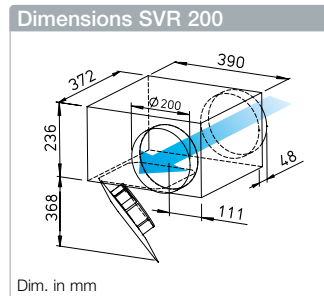
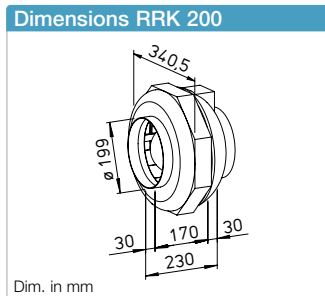
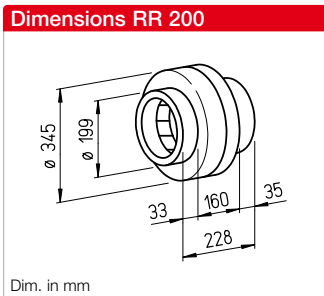

For the delivery of medium and small air volumes against high resistances.

Specifically designed for direct insertion in duct systems. High pressure performance for overcoming friction losses, deflection losses and aggregate resistances. For various applications in commercial, industrial and residential areas.

Special features

- Low space requirement and minimal installation costs due to linear throughflow.
- No need for elaborate deflectors.
- Connectors on inlet and outlet side correspond to standard duct Ø.
- Performance adjustment through 100% speed control.
- Can be used in any position.
- Wide range of accessories.
- Aerodynamically optimised casing design.

Common features

Motor

Enclosed, ball bearing mounted external rotor motor with humidity protection, insulation class F, for continuous operation, maintenance-free and radio interference-free.

Motor protection

Through built-in thermal contacts wired in series to the winding, automatic deactivation and reactivation after cooling.

Installation

No restrictions in any position (horizontal, vertical, diagonal) through corresponding installation for supply or extract ventilation (exception: SVR must not be installed with the retractable motor-impeller unit upward). Installation in duct system, preferably away from the room to be ventilated for less noise.

Noise

See page 390.

Description RR

Casing

Made of galvanised steel sheet, robust for harsh operating conditions. Inlet and outlet side connection dimensions correspond to standard duct Ø.

Power control

From 0 – 100 % possible using electronic controller or step transformer (see table). Two level operation with type RR 200 A using Type DS 2/2 (Accessories).
DS 2/2 Ref. no. 01267

Electrical connection

Terminal box (IP54) on outside of casing.

Impeller

Centrifugal, with backward curved blades made of plastic. Dynamically balanced as a unit. Low-noise, high level of efficiency.

Protection category

Protection category IP44 through inlet and outlet-side installation in a duct system which prevents the ingress of rainwater.

Description RRK

Casing

All components made of corrosion-resistant and impact-resistant plastic. Six built-in guide blades additionally increase the level of efficiency. Colour: Silver-grey.

Power control

From 0 – 100 % possible using electronic controller or step transformer (see table).

Electrical connection

Terminal box (IP44) on outside of casing.

Impeller

Centrifugal, with backward curved blades made of plastic. Dynamically balanced as a unit. Low-noise, high level of efficiency.

Protection category

IP44

Description SVR

Casing

Flat casing in compact design made of galvanised steel sheet. Connectors and lip seal on inlet and outlet side for standard duct Ø.

The retractable motor-impeller unit allows inspection and cleaning without dismantling components. The swivelling range must be considered for the inspection opening.

Power control

From 0 – 100 % possible using electronic controller or step transformer (see table).

Electrical connection

Terminal box (IP54) mounted to external cable.

Impeller

Energy-saving centrifugal impeller with backward curved blades made of high-quality plastic. Dynamically balanced for low-noise operation.

Protection category

IP44 with connected duct system.

Type	Ref. no.	Flow rate Free blowing	Rated speed	Sound press. case radiation	Power consum.	Power consump.		Wiring diagram	Max air flow temp.		Wgt net aprx.	Transformer speed controller 5-step	Electronic ³⁾ Speed controller, cont. var. flush-mount. / surf-mount.		
						at rated voltage	with control		at rated voltage	with control			Type	Ref. no.	Type
		V m ³ /h	min ⁻¹	dB(A) in 1 m	W	A	A	No.	+ °C	+ °C	kg	Type	Ref. no.	Type	Ref. no.
Type RR, Single-phase alternating current, 230 V, 50 Hz, Capacitor motor, IP44 (Type RR 200 B, IP33)															
RR 200 A ¹⁾	05658	960 ¹⁾ /760	2630 ¹⁾ /1980	43	129 ¹⁾ /85	0.57 ¹⁾ /0.38	0.57	934.1	60	60	4.2	TSW 1.5	01495	ESU 1 / ESA 1	00236 / 00238
RR 200 B	05659	980	2750	44	145	0.63	0.78	508	70	60	5.0	TSW 1.5	01495	ESU 1 / ESA 1	00236 / 00238
Type RRK, Single-phase alternating current, 230 V, 50 Hz, Capacitor motor, IP44															
RRK 200	05977	870	2370	38	95	0.41	0.41	508	70	60	3.4	TSW 1.5	01495	ESU 1 / ESA 1	00236 / 00238
Type SVR, Single-phase alternating current, 230 V, 50 Hz, Capacitor motor, IP33															
SVR 200 K	02673	980	2730	57	154	0.67	0.81	508	70	50	8.4	TSW 1.5	01495	ESU 1 / ESA 1	00236 / 00238

¹⁾ Type with high speed; with additional energy-saving level as standard (see performance diagram).

²⁾ Transformer control units must be provided in noise-relevant cases. Electronic phase angle control can cause disturbing magnetisation humming.

* See ErP product data sheet at www.HeliosSelect.de.

Performance curves RR 200 A

Frequency	Hz	Tot.	125	250	500	1k	2k	4k	8k
L _{WA} Radiation	dB(A)	50	31	40	46	46	40	38	31
L _{WA} Inlet side	dB(A)	74	61	68	69	64	66	64	56

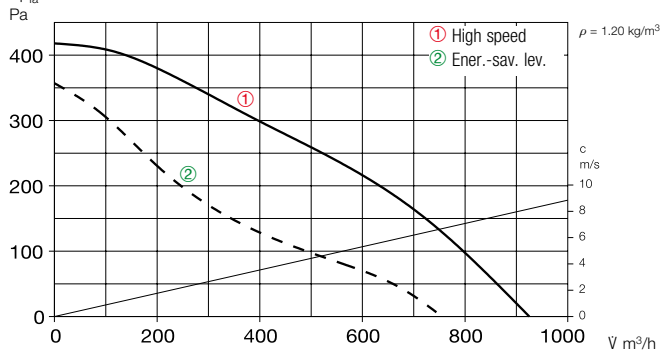

Performance curves RR 200 B

Frequency	Hz	Tot.	125	250	500	1k	2k	4k	8k
L _{WA} Radiation	dB(A)	52	34	41	46	48	44	44	35
L _{WA} Inlet side	dB(A)	74	62	67	69	66	63	62	57

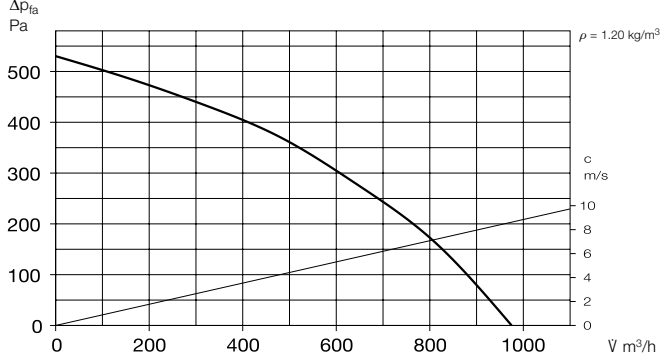

Performance curves RRK 200

Frequency	Hz	Tot.	125	250	500	1k	2k	4k	8k
L _{WA} Radiation	dB(A)	46	32	35	40	41	40	33	26
L _{WA} Inlet side	dB(A)	63	40	55	56	56	58	53	46

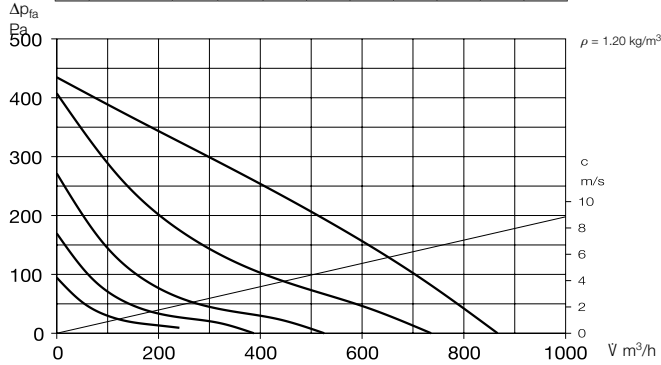

Performance curves SVR 200 K

Frequency	Hz	Tot.	125	250	500	1k	2k	4k	8k
L _{WA} Radiation	dB(A)	65	47	62	61	53	48	42	36
L _{WA} Inlet side	dB(A)	78	65	74	73	65	63	60	57
L _{WA} Outlet side	dB(A)	82	69	77	79	71	70	66	63

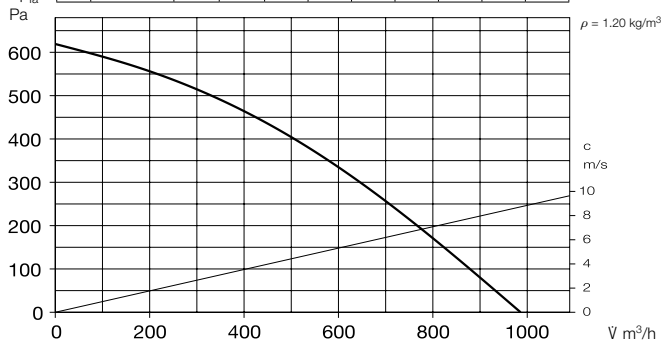

Accessories

Pipe clamp connectors

BM 200 Ref. no. 05078
For structure-borne noise-free connection of fan and piping and for suspension (1 set = 2 pcs). Mount ventilation duct and fan connector at a distance and fold sleeve over during installation.

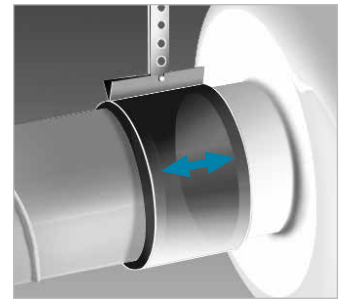

Mounting bracket for RR

MK 4 Ref. no. 05824
Mounting bracket for RRK
MK 2 Ref. no. 05822
Made of galvanised steel sheet.



External wall shutter

VK 200 Ref. no. 00758
Made of plastic, light grey.



External wall cover grille

RAG 200 Ref. no. 00750
Made of plastic, light grey.

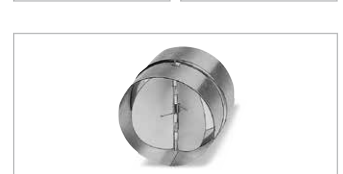

Protection grille

SGR 200 Ref. no. 05066
For inlet and outlet side installation.
Made of galvanised steel.



Duct shutter

RSK 200 Ref. no. 05074
Automatic, made of metal.



Flexible cross talk silencer

FSD 200 Ref. no. 00679
Made of aluminium pipe with double-sided plug-in connectors. Sound insulation lining 50 mm thick, installation length 1 m.



Air filter box

LFBR 200 Coarse 70%* 08579
LFBR 200 ePM1 50%* 08533
Air filter with large surface area, for installation in pipeline.



Electric heating element

EHR-R 1.2/200 1.2 kW No.09436
EHR-R 2/200 2.0 kW No.09437
EHR-R 5/200 5.0 kW No.08711
– with integrated temp. control
EHR-R 5/200 TR 5.0 kW No.05295
Room or duct sensor (TFK/TFR, Accessories) required.



Temperature control system for electric heating element

EHR-R
EHS Ref. no. 05002



Warm water heating element

WHR 200 Ref. no. 09482
Compact heat exchanger for installation in duct system.



Temperature control system for warm water heating element

WHST 300 T38 Ref. no. 08817

* See product page 476 for detailed description.

RR 250



Market-leading unit series with favourable price/performance ratio.
With energy-saving level as standard.

RRK 250



Alternative in corrosion-resistant and impact-resistant plastic casing.

Dimensions RR 250

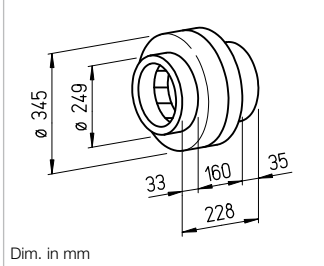

Dim. in mm

Dimensions RRK 250

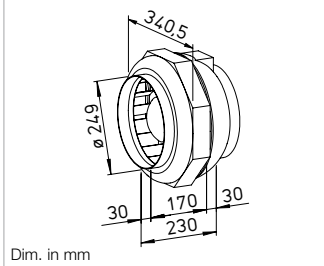

Dim. in mm

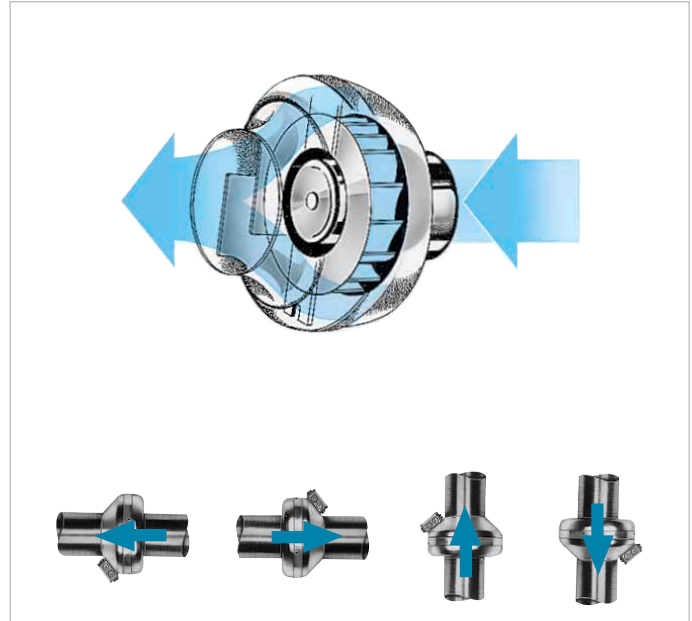

For the delivery of medium and small air volumes against high resistances.

Specifically designed for direct insertion in duct systems. High pressure performance for overcoming friction losses, deflection losses and aggregate resistances. For various applications in commercial, industrial and residential areas.

Special features

- Low space requirement and minimal installation costs due to linear throughflow.
- No need for elaborate deflectors.
- Connectors on inlet and outlet side correspond to standard duct Ø.
- Performance adjustment through 100% speed control.
- Can be used in any position.
- Wide range of accessories.
- Aerodynamically optimised casing design.

Common features

Motor

Enclosed, ball bearing mounted external rotor motor with humidity protection, insulation class F, for continuous operation, maintenance-free and radio interference-free.

Motor protection

Through built-in thermal contacts wired in series to the winding, automatic deactivation and reactivation after cooling.

Description RR

Casing

Made of galvanised steel sheet, robust for harsh operating conditions. Inlet and outlet side connection dimensions correspond to standard duct Ø.

Power control

From 0 – 100% using electronic controller or step transformer (see table).
Two level operation for type RR 250 A possible using type DS 2/2 (accessories).
DS 2/2 Ref. no. 01267

Electrical connection

Terminal box (IP54) on outside of casing.

Impeller

Centrifugal, with backward curved blades made of plastic. Directly pressed on motor and dynamically balanced as a unit. Low-noise, high level of efficiency.

Protection category

Protection category IP44 through inlet and outlet-side installation in a duct system which prevents the ingress of rainwater.

Description RRK

Casing

All components made of corrosion-resistant and impact-resistant plastic. Six built-in guide blades additionally increase the level of efficiency. Colour: Silver-grey.

Power control

From 0 – 100 % possible using electronic controller or step transformer (see table).

Electrical connection

Terminal box (IP44) on outside of casing.

Impeller

Centrifugal, with backward curved blades made of plastic. Directly pressed on motor and dynamically balanced as a unit. Low-noise, high level of efficiency.

Protection category

IP44

Installation

No restrictions in any position (horizontal, vertical, diagonal) through corresponding installation for supply or extract ventilation. Installation in duct system, preferably away from the room to be ventilated for less noise.

Noise

The total level and range are specified above the performance diagram for

- Case-radiated sound power
- Inlet/outlet side sound power in dB(A).
- The case-radiated noise and inlet/outlet side air noise as sound pressure at 1 m (free field conditions) are also specified in the type table.

Type	Ref. no.	Flow rate	Rated speed	Sound press.	Power consum.	Power consum.	Wiring diagram	Max air flow temp.		Wgt net aprx.	Transformer speed controller 5-step	Electronic [®] Speed controller, cont. var. flush-mount. / surf-mount.		
		Free blowing		case radiation	consum.	with control		at rated voltage	with control			at rated voltage	with control	Type
		V m³/h	min⁻¹	dB(A) in 1 m	W	A	No.	+ °C	+ °C	kg	Type	Ref. no.	Type	Ref. no.
Type RR, Single-phase alternating current, 230 V, 50 Hz, Capacitor motor, IP44 (Type RR 250 C, IP33)														
RR 250 A ¹⁾	05652	950 ¹⁾ /740	2650 ¹⁾ /2030	42	129 ¹⁾ /85	0.57 ¹⁾ /0.38	0.57	934.1	60	60	4.2	TSW 1.5 01495	ESU 1 / ESA 1	00236 / 00238
RR 250 C	05660	970	2750	45	145	0.63	0.78	508	70	60	5.0	TSW 1.5 01495	ESU 1 / ESA 1	00236 / 00238
Type RRK, Single-phase alternating current, 230 V, 50 Hz, Capacitor motor, IP44														
RRK 250	05978	910	2360	38	98	0.43	0.43	508	70	60	3.4	TSW 1.5 01495	ESU 1 / ESA 1	00236 / 00238

¹⁾ Type with high speed; with additional energy-saving level as standard (see performance diagram).

* Transformer control units must be provided in noise-relevant cases. Electronic phase angle control can cause disturbing magnetisation humming.

Performance curves RR 250 A

Frequency	Hz	Tot.	125	250	500	1k	2k	4k	8k
L _{WA} Radiation	dB(A)	49	29	40	45	42	41	38	31
L _{WA} Inlet side	dB(A)	75	63	68	67	69	68	66	57

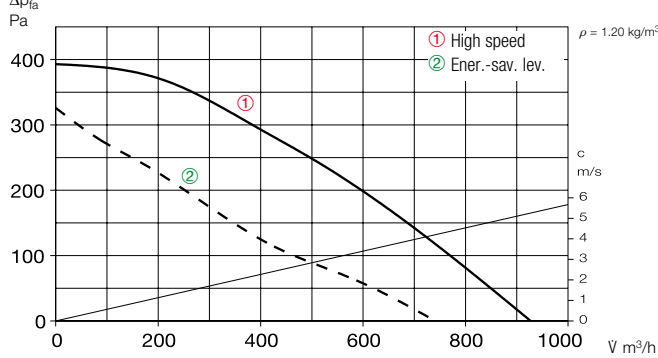

Performance curves RR 250 C

Frequency	Hz	Tot.	125	250	500	1k	2k	4k	8k
L _{WA} Radiation	dB(A)	53	31	42	46	49	46	43	38
L _{WA} Inlet side	dB(A)	75	60	67	67	70	66	64	66

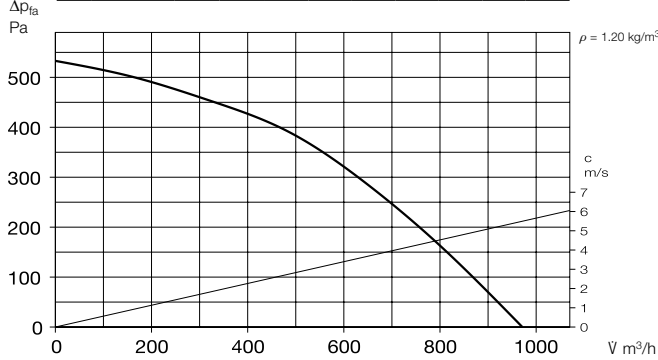

Performance curves RRK 250

Frequency	Hz	Tot.	125	250	500	1k	2k	4k	8k
L _{WA} Radiation	dB(A)	46	32	35	40	41	40	33	26
L _{WA} Inlet side	dB(A)	63	40	55	56	56	58	53	46

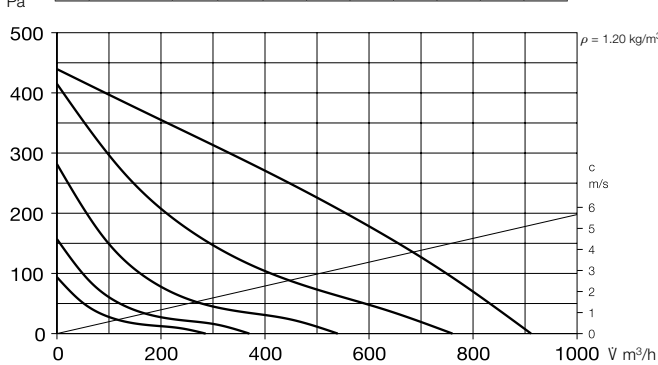

References	Page
Techn. description	352
Selection table	353
Planning information	10 ff.
Modular system	350

Other accessories	Page
Filter, heating elements and silencers	473 ff.
Temperature control systems for heating elements	479, 483 ff.
Flexible ventilation ducts, ventilation grilles, fittings, roof outlets	553 ff.
Disc valves	574 ff.
Speed controllers, controllers and switches	591 ff.

Accessories

Pipe clamp connectors

BM 250 Ref. no. 05079
For structure-borne noise-free connection of fan and piping and for suspension (1 set = 2 pcs). Mount ventilation duct and fan connector at a distance and fold sleeve over during installation.

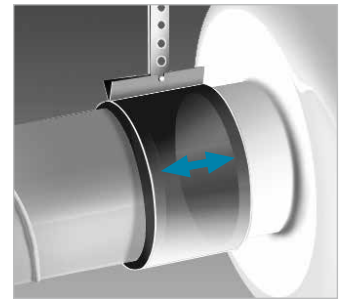

Mounting bracket for RR

MK 4 Ref. no. 05824

Mounting bracket for RRK

MK 2 Ref. no. 05822

Made of galvanised steel sheet.



External wall shutter

VK 250 Ref. no. 00759

Automatic made of plastic, light grey.



External wall cover grille

RAG 250 Ref. no. 00751

Made of plastic, light grey.



Protection grille

SGR 250 Ref. no. 05067

For inlet and outlet side installation. Made of galvanised steel.



Duct shutter

RSK 250 Ref. no. 05673

Automatic, made of metal.



Flexible cross talk silencer

FSD 250 Ref. no. 0680

Made of aluminium pipe with double-sided plug-in connectors. Sound insulation lining 50 mm thick, installation length 1 m.



Air filter box

LFBR 250 Coarse 70%* 08580

LFBR 250 ePM1 50%* 08534

Air filter with large surface area, for installation in pipeline.



Electric heating element

EHR-R 6/250 6.0 kWNo.08712

- with integrated temp. control

EHR-R 6/250 TR 6.0 kWNo.05296

Room or duct sensor (TFK/TFR, Accessories) required.



Temperature control system for electric heating element

EHR-R

EHS Ref. no. 05002



Warm water heating element

WHR 250 Ref. no. 09483

Compact heat exchanger for installation in duct system.



Temperature control system for warm water heating element

WHS HE Ref. no. 08319

* See product page 476 for detailed description.

RR 315



Market-leading unit series with favourable price/performance ratio.

RRK 315



Alternative in corrosion-resistant and impact-resistant plastic casing.

Dimensions RR 315

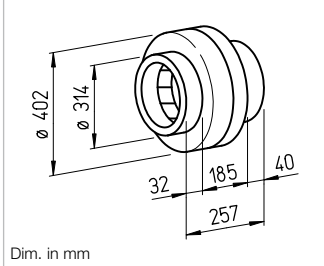

Dim. in mm

Dimensions RRK 315

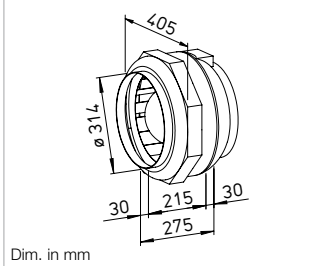

Dim. in mm

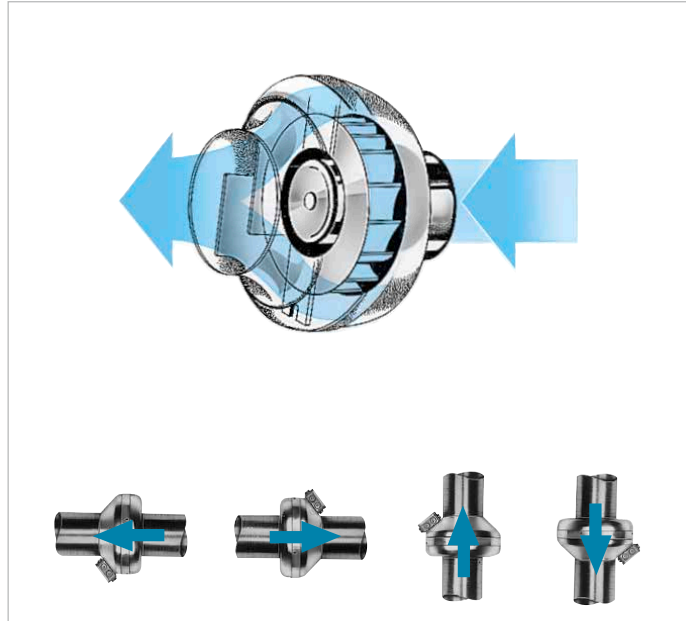

For the delivery of medium and small air volumes against high resistances.

Specifically designed for direct insertion in duct systems. High pressure performance for overcoming friction losses, deflection losses and aggregate resistances. For various applications in commercial, industrial and residential areas.

Special features

- Low space requirement and minimal installation costs due to linear throughflow.
- No need for elaborate deflectors.
- Connectors on inlet and outlet side correspond to standard duct Ø.
- Performance adjustment through 100% speed control.
- Can be used in any position.
- Wide range of accessories.
- Aerodynamically optimised casing design.

Common features

Motor

Enclosed, ball bearing mounted external rotor motor with humidity protection, insulation class F, for continuous operation, maintenance-free and radio interference-free.

Motor protection

Through built-in thermal contacts wired in series to the winding, automatic deactivation and reactivation after cooling.

Description RR

Casing

Made of galvanised steel sheet, robust for harsh operating conditions. Inlet and outlet side connection dimensions correspond to standard duct Ø.

Power control

From 0 – 100 % possible using electronic controller or step transformer (see table).

Electrical connection

Terminal box (IP54) on outside of casing.

Impeller

Centrifugal, with backward curved blades made of plastic. Directly pressed on motor and dynamically balanced as a unit. Low-noise, high level of efficiency.

Protection category

Protection category IP44 through inlet and outlet-side installation in a duct system which prevents the ingress of rainwater.

Description RRK

Casing

All components made of corrosion-resistant and impact-resistant plastic. Six built-in guide blades additionally increase the level of efficiency. Colour: Silver-grey.

Electrical connection

Terminal box (IP44) on outside of casing.

Power control

From 0 – 100 % possible using electronic controller or step transformer (see table).

Impeller

Centrifugal, with backward curved blades made of steel sheet. Directly pressed on motor and dynamically balanced as a unit. Low-noise, high level of efficiency.

Protection category

IP44

Installation

No restrictions in any position (horizontal, vertical, diagonal) through corresponding installation for supply or extract ventilation. Installation in duct system, preferably away from the room to be ventilated for less noise.

Noise

The total level and range are specified above the performance diagram for

- Case-radiated sound power
- Inlet/outlet side sound power in dB(A).
- The case-radiated noise and inlet/outlet side air noise as sound pressure at 1 m (free field conditions) are also specified in the type table.

Type	Ref. no.	Flow rate	Rated speed	Sound press.	Power consum.	Power consump.	Wiring diagram	Max air flow temp.		Wgt net aprx.	Transformer speed controller 5-step	Electronic ⁹ Speed controller, cont. var. flush-mount. / surf-mount.			
		Free blowing		case radiation	consum.	at rated voltage		with control	at rated voltage			with control	Type	Ref. no.	Type
		V m³/h	min⁻¹	dB(A) in 1 m	W	A	A	No.	+ °C	+ °C	kg	Type	Ref. no.	Type	Ref. no.
Type RR, Single-phase alternating current, 230 V, 50 Hz, Capacitor motor, IP44															
RR 315	05920	1260	2660	46	200	0.87	0.97	508	70	60	6.1	TSW 1.5	01495	ESU 3 / ESA 3	00237 / 00239
Type RRK, Single-phase alternating current, 230 V, 50 Hz, Capacitor motor, IP44															
RRK 315	05979	1080	2690	48	170	0.75	0.97	508	70	60	5.7	TSW 1.5	01495	ESU 3 / ESA 3	00237 / 00239

* Transformer control units must be provided in noise-relevant cases. Electronic phase angle control can cause disturbing magnetisation humming.

Performance curves RR 315

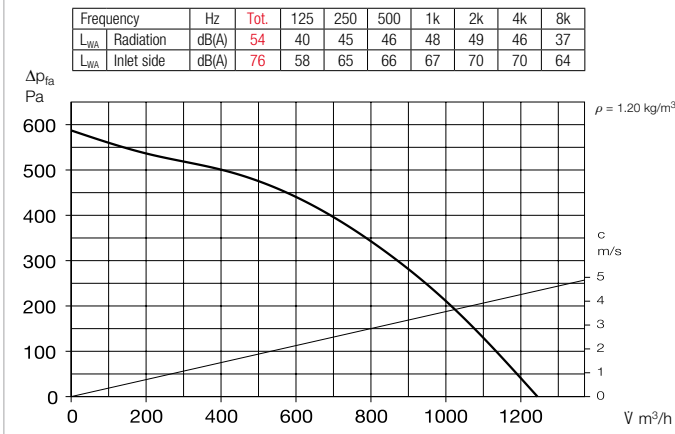

Performance curves RRK 315

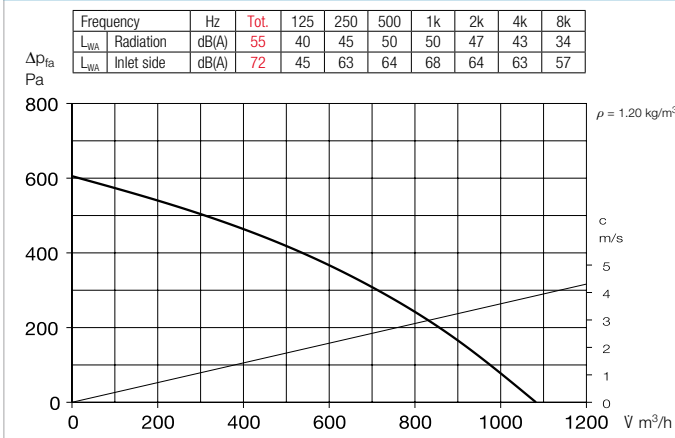

References	Page
Techn. description	352
Selection table	353
Planning information	10 ff.
Modular system	350

Other accessories	Page
Filter, heating elements and silencers	473 ff.
Temperature control systems for heating elements	479, 483 ff.
Flexible ventilation ducts, ventilation grilles, fittings, roof outlets	553 ff.
Disc valves	574 ff.
Speed controllers, controllers and switches	591 ff.

Accessories

Pipe clamp connectors
BM 315 Ref. no. 05080
For structure-borne noise-free connection of fan and piping and for suspension (1 set = 2 pcs). Mount ventilation duct and fan connector at a distance and fold sleeve over during installation.

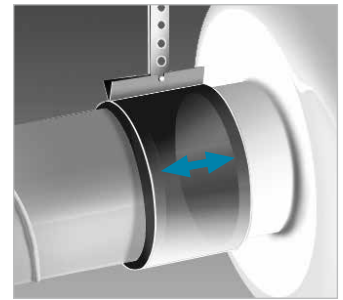

Mounting bracket for RR
MK 4 Ref. no. 05824
Mounting bracket for RRK
MK 3 Ref. no. 05823
Made of galvanised steel sheet.



External wall shutter
VK 315 Ref. no. 00760
Automatic made of plastic, light grey.



External wall cover grille
RAG 315 Ref. no. 00752
Made of plastic, light grey.



Protection grille
SGR 315 Ref. no. 05068
For inlet and outlet side installation. Made of galvanised steel.



Duct shutter
RSK 315 Ref. no. 5674
Automatic, made of metal.



Flexible cross talk silencer
FSD 315 Ref. no. 00681
Made of aluminium pipe with double-sided plug-in connectors. Sound insulation lining 50 mm thick, installation length 1 m.



Air filter box
LFBR 315 Coarse 70%* 08581
LFBR 315 ePM1 50%* 08535
Air filter with large surface area, for installation in pipeline.



Electric heating element
EHR-R 6/315 6.0 kW No. 08713
– with integrated temp. control
EHR-R 6/315 TR 6.0 kW No. 05301
Room or duct sensor (TFK/TFR, Accessories) required.



Temperature control system for electric heating element
EHR-R
EHS Ref. no. 05002



Warm water heating element
WHR 315 Ref. no. 09484
Compact heat exchanger for installation in duct system.



Temperature control system for warm water heating element
WHS HE Ref. no. 08319

* See product page 476 for detailed description.

Acoustic Line from Helios. Ventilation could not be quieter.



Two powerful series: Helios SilentBox® and SlimVent.

Acoustic Line centrifugal circular duct fans are characterised by the lowest noise levels and thus they are also suitable for noise sensitive environments. This is achieved by using particularly low-noise high performance impellers and the casing which was designed as a silencer.

The 50 mm thick mineral wool lining ensures that the casing radiation and ventilation noise are kept to a minimum. The retractable motor-impeller unit also offers maximum convenience for inspection and cleaning.

Helios SilentBox SB
 Ø 125 to 400 mm
 V̇ = 230 – 4560 m³/h

High volume output and pressure performance with ideal sound values make Helios SilentBox centrifugal circular duct fans the best solution for extract air and intake air systems with particular noise level requirements.

The sound-insulated casing ensures virtually silent operation and it is designed for installation in any position.

Helios SlimVent SVS
 Ø 125 to 315 mm
 V̇ = 400 – 1940 m³/h

Helios SlimVent centrifugal circular duct fans are only slightly higher than the duct diameter and they allow easy and space-saving installation in any position.

System resistances and longer duct sections are not restrictions due to the high pressure rates. The use of energy-saving centrifugal impellers also ensures highly energy-efficient operation.



■ Acoustic Line

Energy-efficient
 EC version



402ff

■ Acoustic Line

Standard AC types

416ff

SB EC 125



Virtually silent with high volume output and pressure performance. Ideal for cleaning and inspection.



SVS EC 125



Lowest installation height. Ideal for limited installation spaces. With sound-insulating mineral wool lining for particularly low-noise operation.



Dimensions SB EC 125

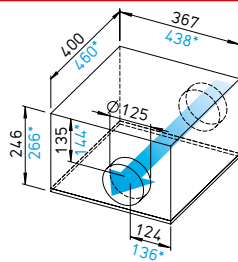

Dim. in mm

SB EC 125 A, *SB EC 125 B

Dimensions SVS EC 125

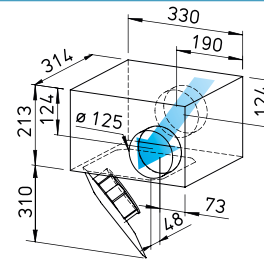

Dim. in mm

Common features SilentBox SB EC and SlimVent SVS EC

Installation

No restrictions in any position (horizontal, vertical, diagonal) through corresponding installation for supply or extract ventilation. Mounting bracket included in delivery.

Drive

Energy-saving, speed-controllable EC external rotor motor in protection category IP44 with the highest level of efficiency. Maintenance-free and radio interference-free, ball bearing mounted. Motor and impeller dynamically balanced for low-noise operation.

Power control

Continuously variable speed control with internal (delivery) or external potentiometer or continuously variable speed control with universal control system

(see table). Performance levels are shown in the performance curve as an example.

Motor protection

Integrated electronic temperature monitoring system for EC motor and electronics.

Noise

See page 409

Description SilentBox EC

Casing

Designed as a silencer. Equipped with abrasion-resistant, sound-absorbing mineral fibre boards (50 mm). Removable cover with locking clamp. Freely accessible fan. Removable motor-impeller unit, the removal area must be considered. Inlet and outlet side connectors with rubber lip seal corresponds to standard duct Ø. All parts made of galvanised steel sheet.

Impeller

With backward curved blades. Inlet via nozzle. SB EC 125 A forward curved impeller in aerodynamically optimised volute casing, galvanised steel sheet.

Electrical connection

Terminal box (IP54) mounted to external cable.

Protection category

IP44 (SB EC 125 A IP54) with connected duct system.

Description SlimVent SVS EC

Casing

Extremely flat casing with sound-insulating, over 50 mm thick mineral wool lining and glass fibre surface. The acoustic box placed in front of the fan wheel significantly reduces the inlet-side noises. The radiated noises are reduced to a lesser extent (see noise data above the

performance diagrams).

The retractable motor-impeller unit allows inspection and cleaning without dismantling the system components. The removal area of the motor-impeller unit must be considered.

Impeller

Energy-saving centrifugal impeller with backward curved blades made of high-quality plastic.

Electrical connection

Terminal box (IP54) mounted to external cable.

Protection category

IP44 with connected duct system.

Type	Ref. no.	Connection Ø	Flow rate Free blowing	Rated speed	Sound press. case radiation	Power consum.	Current consum.	Wiring diagram	Max. air flow temp.	Wgt net aprx.	Universal control system		Speed potentiometer flush-mount.		Speed potentiometer surf-mount.	
											Type	Ref. no.	Type	Ref. no.	Type	Ref. no.
Type SB EC, Single-phase alternating current, 230 V, 50/60 Hz, EC motor, IP54 (A), IP44 (B)																
SB EC 125 A	06132	125	520	2890	41	0.12	1.03	979	60	10.0	EUR EC ¹⁾²⁾	01347	PU 10 ¹⁾	01734	PA 10 ¹⁾	01735
SB EC 125 B	09624	125	530	3600	45	0.10	0.81	979	60	12.0	EUR EC ¹⁾²⁾	01347	PU 10 ¹⁾	01734	PA 10 ¹⁾	01735
Type SVS EC, Single-phase alternating current, 230 V, 50/60 Hz, EC motor, IP44																
SVS EC 125	00016	125	540	3530	53	0.10	0.82	979	60	6.2	EUR EC ¹⁾²⁾	01347	PU 10 ¹⁾	01734	PA 10 ¹⁾	01735

¹⁾ Multiple EC fans can normally be connected. ²⁾ alternative electronic diff. pressure/ temperature controller (EDR/ETR, No. 01437/01438) or three level speed switch (SU/SA, No. 04266/04267), see accessories.

Performance curves SB EC 125 A

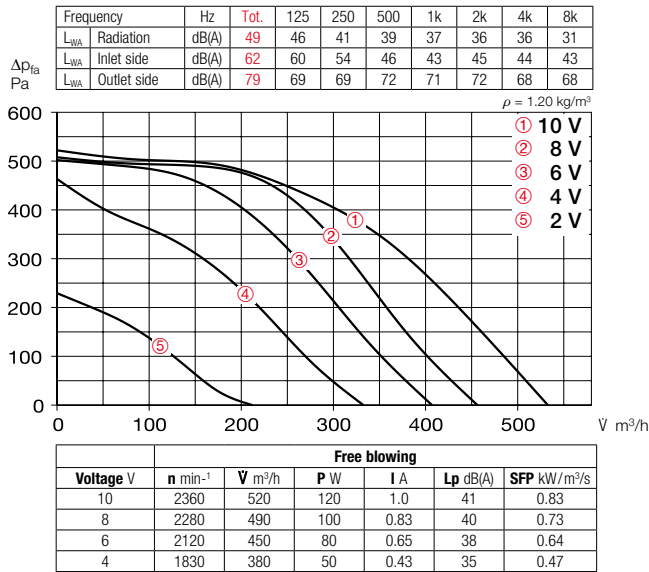

Performance curves SB EC 125 B

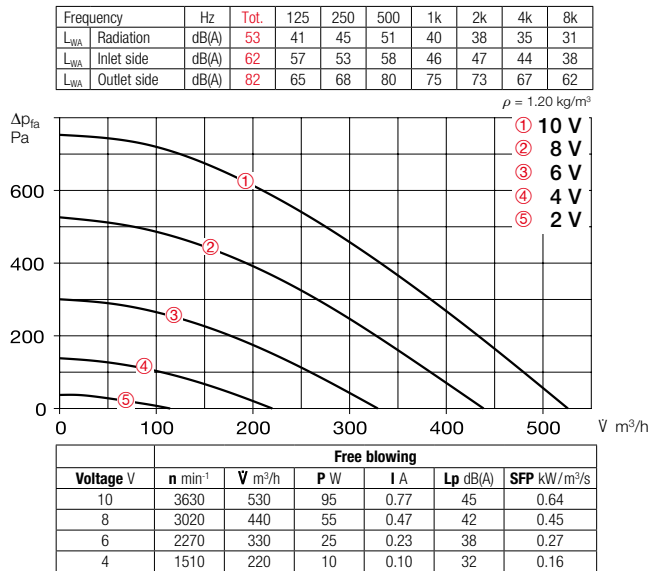

Performance curves SVS EC 125

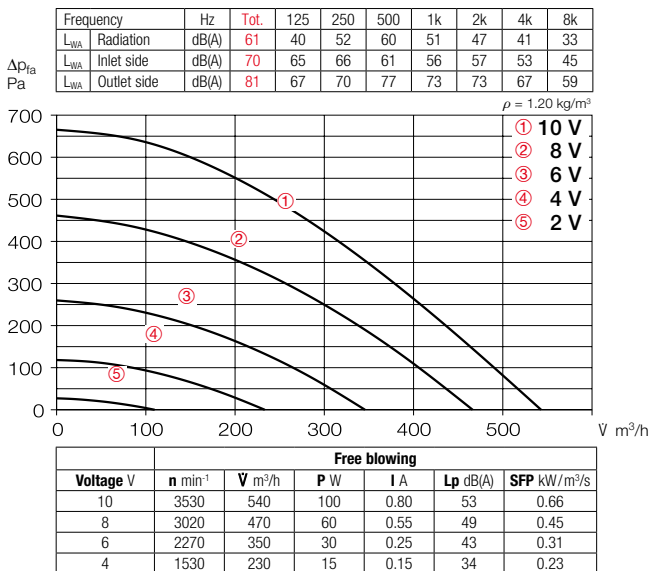

Accessories

Flexible connecting sleeve

FM 125 Ref. no. 01682
Includes 2 hose clamps; for installation between fan and duct system. Prevents structure-borne noise transmission and bridges installation tolerances.
2 pcs required for inlet and outlet side application.



External wall shutter

VK 125 Ref. no. 00857
Automatic made of plastic, white.



External wall cover grille

G 160 Ref. no. 00893
Made of plastic, white.



Protection grille

SGR 125 Ref. no. 05064
For inlet and outlet side installation. Made of powder-coated steel wire.



Duct shutter

RSKK 125 Ref. no. 05107
Automatic, made of plastic.



Flexible cross talk silencer

FSD 125 Ref. no. 00677
Made of aluminium pipe with double-sided plug-in connectors. Sound insulation lining 50 mm thick, installation length 1 m.



Air filter box

LFBR 125 Coarse 70%* 08577
LFBR 125 ePM1 50%* 08531
Air filter with large surface area, for installation in pipeline.



Electric heating element

EHR-R 0.8/125 0.8 kW No. 08709
EHR-R 1.2/125 1.2 kW No. 09433
- with integrated temp. control
EHR-R 0.8/125 TR 0.8 kW No. 05293
Room or duct sensor (TFK/TFR, Accessories) required.



Temperature control system for electric heating element

EHR-R
EHS Ref. no. 05002



Warm water heating element

WHR 125 Ref. no. 09480
Compact heat exchanger for installation in duct system.



Temperature control system for warm water heating element

WHST 300 T38 No. 08817



* See product page 476 for detailed description.

SB EC 160



Virtually silent with high volume output and pressure performance. Ideal for cleaning and inspection.



SVS EC 160



Lowest installation height. Ideal for limited installation spaces. With sound-insulating mineral wool lining for particularly low-noise operation.



Dimensions SB EC 160

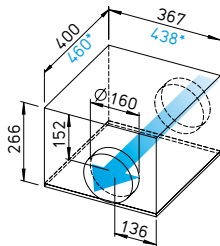

Dim. in mm

SB EC 160 A, *SB EC 160 B

Dimensions SVS EC 160

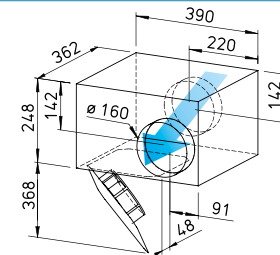

Dim. in mm

Common features SilentBox SB EC and SlimVent SVS EC

Installation

See page 402.

Drive

Energy-saving, speed-controllable EC external rotor motor in protection category IP44 with the highest level of efficiency. Maintenance-free and radio interference-free, ball bearing mounted. Motor and impeller dynamically balanced for low-noise operation.

Power control

Continuously variable speed control with internal (delivery) or external potentiometer or continuously variable speed control with universal control system (see table). Performance levels are shown in the performance curve as an example.

Motor protection

Integrated electronic temperature monitoring system for EC motor and electronics.

Noise

See page 409.

Description SilentBox EC

Casing

Designed as a silencer. Equipped with abrasion-resistant, sound-absorbing mineral fibre boards (50 mm). Removable cover with locking clamp. Freely accessible fan. Removable motor-impeller unit, the removal area must be considered. Inlet and outlet side connectors with rubber lip seal corresponds to standard duct Ø. All parts made of galvanised steel sheet.

Impeller

With backward curved blades.

Inlet via nozzle. SB EC 125 A forward curved impeller in aerodynamically optimised volute casing, galvanised steel sheet.

Electrical connection

Terminal box (IP54) mounted to external cable.

Protection category

IP44 (SB EC 160 A IP54) with connected duct system.

Description SlimVent SVS EC

Casing

Extremely flat casing with sound-insulating, over 50 mm thick mineral wool lining and glass fibre surface. The acoustic box placed in front of the fan wheel significantly reduces the inlet-side noises. The radiated noises are reduced to a lesser extent (see noise data above the performance diagrams).

The retractable motor-impeller unit allows inspection and cleaning without dismantling the system components. The removal area of the motor-impeller unit must be considered.

Impeller

Energy-saving centrifugal impeller with backward curved blades made of high-quality plastic.

Electrical connection

Terminal box (IP54) mounted to external cable.

Protection category

IP44 with connected duct system.

Type	Ref. no.	Connection Ø	Flow rate Free blowing	Rated speed	Sound press. case radiation	Power consum.	Current consum.	Wiring diagram	Max. air flow temp.	Wgt net aprx.	Universal control system		Speed potentiometer			
											Type	Ref. no.	Type	Ref. no.	Type	Ref. no.
		mm	∇ m³/h	min ⁻¹	dB(A) in 1 m	kW	A	No.	+ °C	kg	Type	Ref. no.	Type	Ref. no.	Type	Ref. no.
Type SB EC, Single-phase alternating current, 230 V, 50/60 Hz, EC motor, IP54 (A), IP44 (B)																
SB EC 160 A	06136	160	580	2630	41	0.12	1.02	979	60	10.0	EUR EC ¹⁾²⁾	01347	PU 10 ¹⁾	01734	PA 10 ¹⁾	01735
SB EC 160 B	09625	160	590	3610	46	0.10	0.81	979	60	12.0	EUR EC ¹⁾²⁾	01347	PU 10 ¹⁾	01734	PA 10 ¹⁾	01735
Type SVS EC, Single-phase alternating current, 230 V, 50/60 Hz, EC motor, IP44																
SVS EC 160 A ³⁾	00017	160	570	3610	51	0.10	0.80	979	60	8.0	EUR EC ¹⁾²⁾	01347	PU 10 ¹⁾	01734	PA 10 ¹⁾	01735
SVS EC 160 B	00018	160	780	2920	52	0.12	0.97	979	60	7.5	EUR EC ¹⁾²⁾	01347	PU 10 ¹⁾	01734	PA 10 ¹⁾	01735

¹⁾ Multiple EC fans can normally be connected. ²⁾ alternative electronic diff. pressure/ temperature controller (EDR/VETR, No. 01437/01438) or three level speed switch (SU/SA, No. 04266/04267), see accessories. ³⁾ Performance diagram at www.HeliosSelect.de.

Performance curves SB EC 160 A

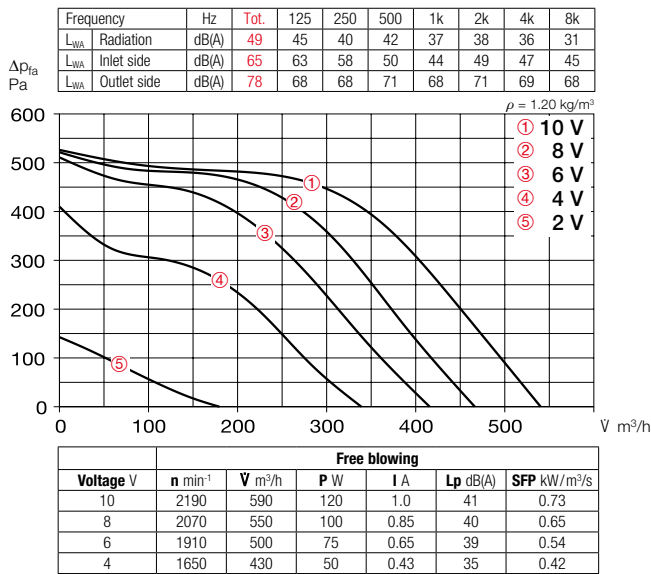

Performance curves SB EC 160 B

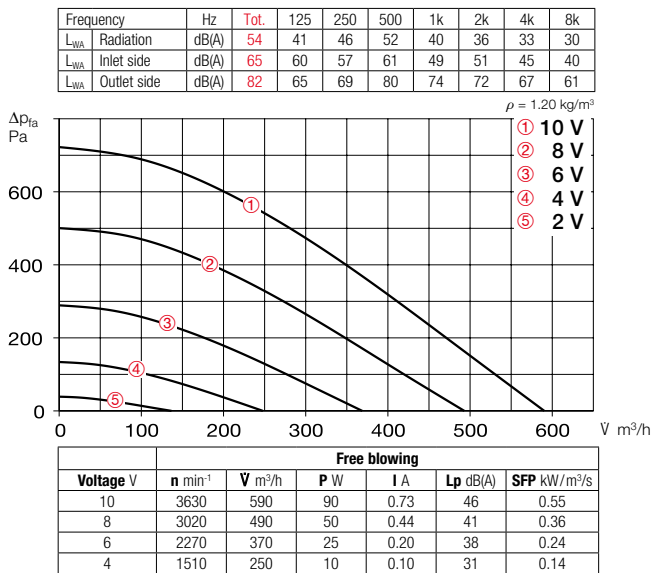

Performance curves SVS EC 160 B

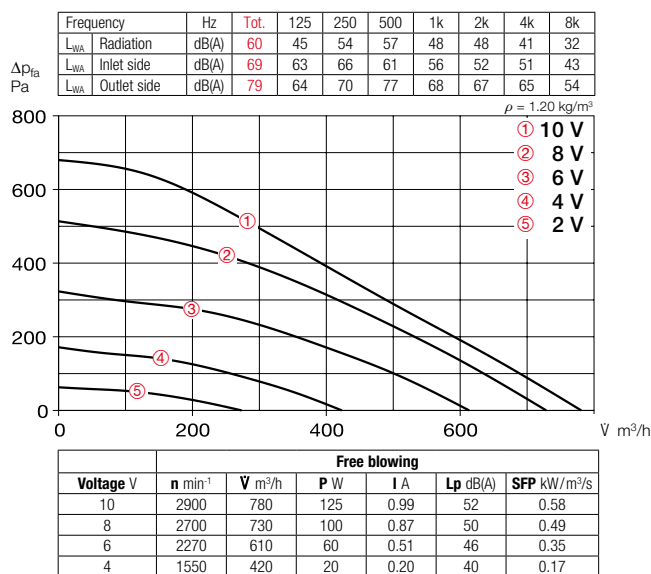

Accessories

Flexible connecting sleeve
FM 160 Ref. no. 01684
 Includes 2 hose clamps; for installation between fan and duct system. Prevents structure-borne noise transmission and bridges installation tolerances.
 2 pcs required for inlet and outlet side application.



External wall shutter
VK 160 Ref. no. 00892
 Automatic made of plastic, white.



External wall cover grille
G 160 Ref. no. 00893
 Made of plastic, white.



Protection grille
SGR 160 Ref. no. 05069
 For inlet and outlet side installation. Made of galvanised steel.



Duct shutter
RSK 160 Ref. no. 05669
 Automatic, made of metal.



Flexible cross talk silencer
FSD 160 Ref. no. 00678
 Made of aluminium pipe with double-sided plug-in connectors. Sound insulation lining 50 mm thick, installation length 1 m.



Air filter box
LFBR 160 Coarse 70%* 08578
LFBR 160 ePM1 50%* 08532
 Air filter with large surface area, for installation in pipeline.



Electric heating element
EHR-R 1.2/160 1.2 kW No. 09434
EHR-R 2.4/160 2.4 kW No. 09435
EHR-R 5/160 5.0 kW No. 08710
 – with integrated temp. control
EHR-R 2.4/160 TR 2.4 kW No. 05294
 Room or duct sensor (TFK/TFR, Accessories) required.



Temperature control system for electric heating element
EHR-R
EHS Ref. no. 05002



Warm water heating element
WHR 160 Ref. no. 09481
 Compact heat exchanger for installation in duct system.



Temperature control system for warm water heating element
WHST 300 T38 No. 08817

* See product page 476 for detailed description.

SB EC 200



Virtually silent with high volume output and pressure performance. Ideal for cleaning and inspection.



SVS EC 200



Lowest installation height. Ideal for limited installation spaces. With sound-insulating mineral wool lining for particularly low-noise operation.



Dimensions SB EC 200

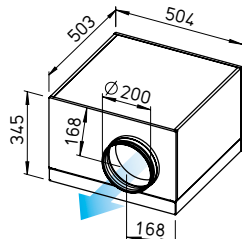

Dim. in mm

Dimensions SVS EC 200

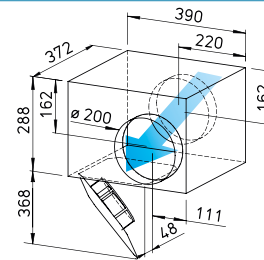

Dim. in mm

Common features SilentBox SB EC and SlimVent SVS EC

Installation

No restrictions in any position (horizontal, vertical, diagonal) through corresponding installation for supply or extract ventilation. Mounting bracket included in delivery.

Drive

Energy-saving, speed-controllable EC external rotor motor in protection category IP44 with the highest level of efficiency. Maintenance-free and radio interference-free, ball bearing mounted. Motor and impeller dynamically balanced for low-noise operation.

Power control

Continuously variable speed control with internal (delivery) or external potentiometer or conti-

nuously variable speed control with universal control system (see table). Performance levels are shown in the performance curve as an example.

Motor protection

Integrated electronic temperature monitoring system for EC motor and electronics.

Noise

See page 409.

Description SilentBox EC

Casing

Designed as a silencer. Equipped with abrasion-resistant, sound-absorbing mineral fibre boards (50 mm). Removable cover with locking clamp. Freely accessible fan. Removable motor-impeller unit, the removal area must be considered. Inlet and outlet side connectors with

rubber lip seal corresponds to standard duct Ø. All parts made of galvanised steel sheet.

Impeller

With backward curved blades. Inlet via nozzle.

Electrical connection

Terminal box (IP54) mounted to external cable.

Protection category

IP44 with connected duct system.

Description SlimVent SVS EC

Casing

Extremely flat casing with sound-insulating, over 50 mm thick mineral wool lining and glass fibre surface. The acoustic box placed in front of the fan wheel significantly reduces the inlet-side noises. The radiated

noises are reduced to a lesser extent (see noise data above the performance diagrams).

The retractable motor-impeller unit allows inspection and cleaning without dismantling the system components. The removal area of the motor-impeller unit must be considered.

Impeller

Energy-saving centrifugal impeller with backward curved blades made of high-quality plastic.

Electrical connection

Terminal box (IP54) mounted to external cable.

Protection category

IP44 with connected duct system.

Type	Ref. no.	Connection Ø	Flow rate Free blowing	Rated speed	Sound press. case radiation	Power consum.	Current consum.	Wiring diagram	Max. air flow temp.	Wgt net aprx.	Universal control system		Speed potentiometer			
											Type	Ref. no.	Type	Ref. no.		
			mm	m³/h	min ⁻¹	dB(A) in 1 m	kW	A	No.	+ °C	kg	Type	Ref. no.	Type	Ref. no.	
Type SB EC, Single-phase alternating current, 230 V, 50/60 Hz, EC motor, IP54 (A), IP44 (B)																
SB EC 200 A	06138	200	900	2830	39	0.12	1.00	979	60	17	EUR EC ¹⁾²⁾	01347	PU 10 ¹⁾	01734	PA 10 ¹⁾	01735
SB EC 200 B	09626	200	970	2890	42	0.15	1.20	979	60	17	EUR EC ¹⁾²⁾	01347	PU 10 ¹⁾	01734	PA 10 ¹⁾	01735
Type SVS EC, Single-phase alternating current, 230 V, 50/60 Hz, EC motor, IP44																
SVS EC 200 A ³⁾	03390	200	910	2780	49	0.12	1.02	979	60	8.1	EUR EC ¹⁾²⁾	01347	PU 10 ¹⁾	01734	PA 10 ¹⁾	01735
SVS EC 200 B	00019	200	1010	2880	52	0.15	1.22	979	60	8.3	EUR EC ¹⁾²⁾	01347	PU 10 ¹⁾	01734	PA 10 ¹⁾	01735

¹⁾ Multiple EC fans can normally be connected. ²⁾ alternative electronic diff. pressure/ temperature controller (EDR/VETR, No. 01437/01438) or three level speed switch (SU/SA, No. 04266/04267), see accessories.

³⁾ Performance diagram at www.HeliosSelect.de.

Performance curves SB EC 200 A

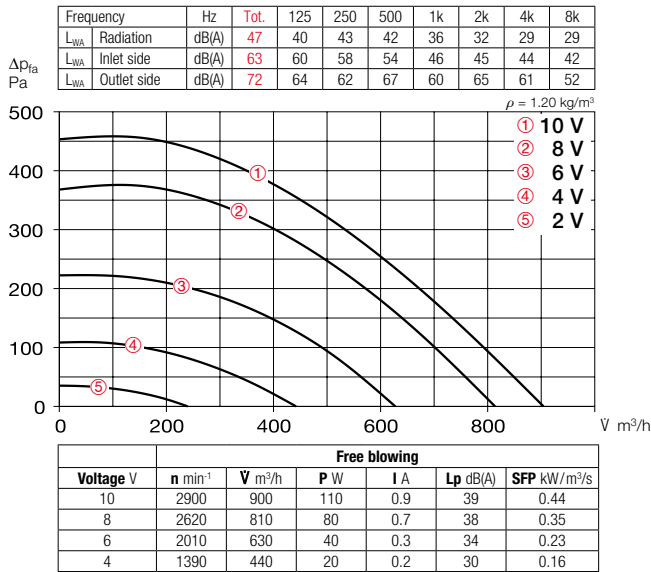

Performance curves SB EC 200 B

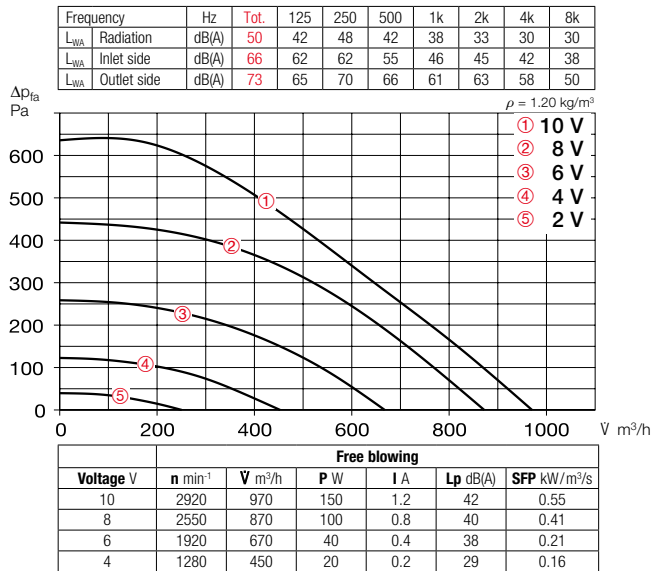

Performance curves SVS EC 200 B

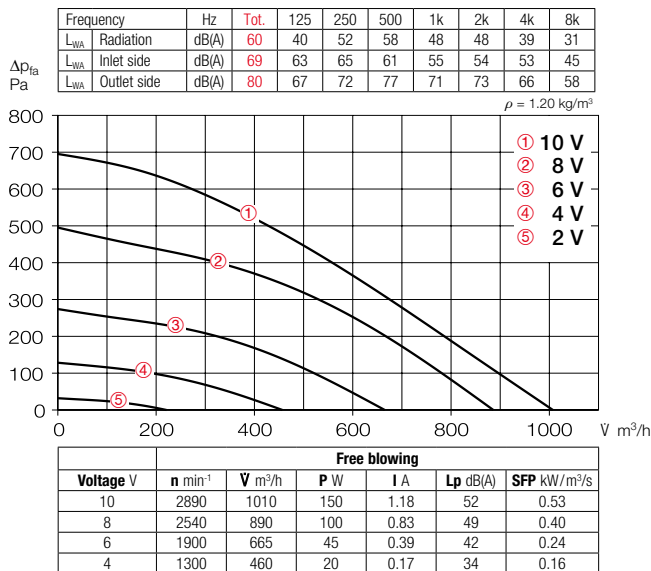

Accessories

Flexible connecting sleeve

FM 200 Ref. no. 01670
Includes 2 hose clamps; for installation between fan and duct system. Prevents structure-borne noise transmission and bridges installation tolerances. 2 pcs required for inlet and outlet side application.



External wall shutter

VK 200 Ref. no. 00758
Made of plastic, light grey.



External wall cover grille

RAG 200 Ref. no. 00750
For placement in front of air inlet and outlet openings in facades. Made of plastic, light grey.



Protection grille

SGR 200 Ref. no. 05066
For inlet and outlet side installation. Made of galvanised steel.



Duct shutter

RSK 200 Ref. no. 05074
Automatic, made of metal.



Flexible cross talk silencer

FSD 200 Ref. no. 00679
Made of aluminium pipe with double-sided plug-in connectors. Sound insulation lining 50 mm thick, installation length 1 m.



Air filter box

LFBR 200 Coarse 70%* 08579
LFBR 200 ePM1 50%* 08533
Air filter with large surface area, for installation in pipeline.

Electric heating element

EHR-R 1.2/200 1.2 kW No. 09436
EHR-R 2/200 2.0 kW No. 09437
EHR-R 5/200 5.0 kW No. 08711
– with integrated temp. control
EHR-R 5/200 TR 5.0 kW No. 05295
Room or duct sensor (TFK/TFR, Accessories) required.



Temperature control system for electric heating element

EHR-R
EHS Ref. no. 05002



Warm water heating element

WHR 200 Ref. no. 09482
Compact heat exchanger for installation in duct system.



Temperature control system for warm water heating element

WHST 300 T38 No. 08817



* See product page 476 for detailed description.

SB EC 250



Virtually silent with high volume output and pressure performance. Ideal for cleaning and inspection.



SVS EC 250



Lowest installation height. Ideal for limited installation spaces. With sound-insulating mineral wool lining for particularly low-noise operation.



Dimensions SB EC 250

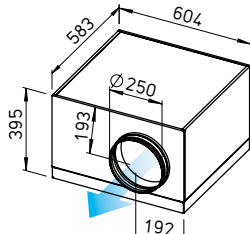

Dim. in mm

Dimensions SVS EC 250

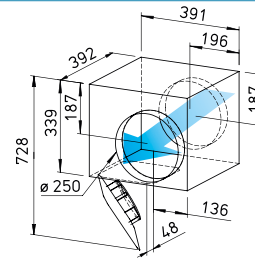

Dim. in mm

Common features SilentBox SB EC and SlimVent SVS EC

Installation

No restrictions in any position (horizontal, vertical, diagonal) through corresponding installation for supply or extract ventilation. Mounting bracket included in delivery.

Drive

Energy-saving, speed-controllable EC external rotor motor in protection category IP44 with the highest level of efficiency. Maintenance-free and radio interference-free, ball bearing mounted. Motor and impeller dynamically balanced for low-noise operation.

Power control

Continuously variable speed control with internal (delivery) or external potentiometer or continuously variable speed control with

universal control system (see table). Performance levels are shown in the performance curve as an example.

Motor protection

Integrated electronic temperature monitoring system for EC motor and electronics.

Description SilentBox EC

Casing

Designed as a silencer. Equipped with abrasion-resistant, sound-absorbing mineral fibre boards (50 mm). Removable cover with locking clamp. Freely accessible fan. Removable motor-impeller unit, the removal area must be considered. Inlet and outlet side connectors with rubber lip seal corresponds to standard duct Ø. All parts made of galvanised steel sheet.

Impeller

With backward curved blades. Inlet via nozzle.

Electrical connection

Terminal box (IP54) mounted to external cable.

Protection category

IP44 with connected duct system.

Description SlimVent SVS EC

Casing

Extremely flat casing with sound-insulating, over 50 mm thick mineral wool lining and glass fibre surface. The acoustic box placed in front of the fan wheel significantly reduces the inlet-side noises. The radiated noises are reduced to a lesser extent (see noise data above the performance diagrams).

The retractable motor-impeller unit allows inspection and cleaning without dismantling the system components. The removal area of the motor-impeller unit must be considered.

Impeller

Energy-saving centrifugal impeller with backward curved blades made of high-quality plastic.

Electrical connection

Terminal box (IP54) mounted to external cable.

Protection category

IP44 with connected duct system.

Type	Ref. no.	Connection Ø	Flow rate Free blowing	Rated speed	Sound press. case radiation	Power consum.	Current consum.	Wiring diagram	Max. air flow temp.	Wgt net aprx.	Universal control system		Speed potentiometer			
											Type	Ref. no.	Type	Ref. no.	Type	Ref. no.
		mm	l/s	min ⁻¹	dB(A) in 1 m	kW	A	No.	+ °C	kg	Type	Ref. no.	Type	Ref. no.	Type	Ref. no.
Type SB EC, Single-phase alternating current, 230 V, 50/60 Hz, EC motor, IP44																
SB EC 250	09627	250	1190	2790	42	0.15	1.18	979	60	23	EUR EC ¹⁾²⁾	01347	PU 10 ¹⁾	01734	PA 10 ¹⁾	01735
Type SVS EC, Single-phase alternating current, 230 V, 50/60 Hz, EC motor, IP44																
SVS EC 250	06125	250	1210	2920	46	0.15	1.21	979	60	9.6	EUR EC ¹⁾²⁾	01347	PU 10 ¹⁾	01734	PA 10 ¹⁾	01735

¹⁾ Multiple EC fans can normally be connected. ²⁾ alternative electronic diff. pressure/ temperature controller (EDR/VETR, No. 01437/01438) or three level speed switch (SU/SA, No. 04266/04267), see accessories.

Performance curves SB EC 250

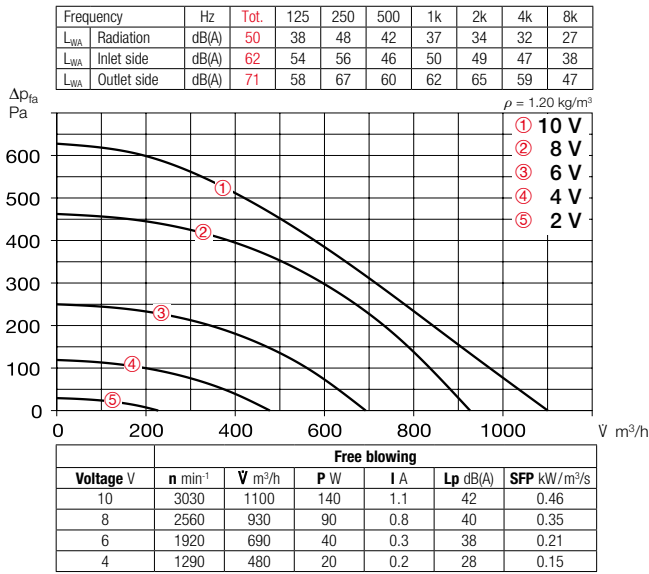

Performance curves SVS EC 250

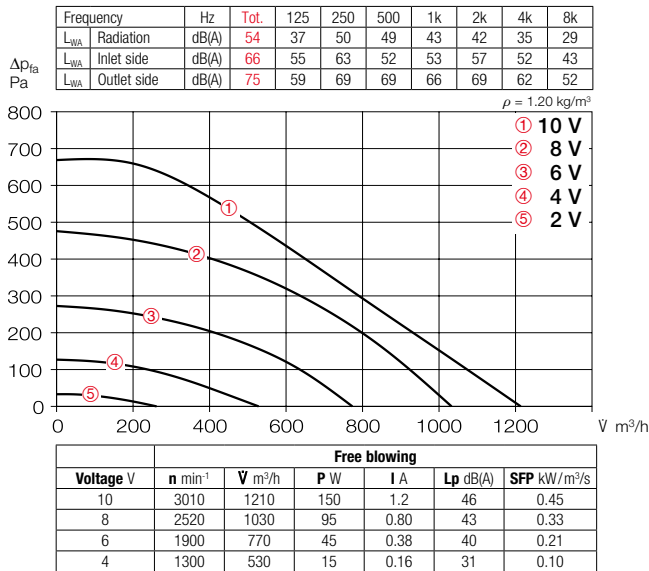

Noise

The total level and range are specified above the performance diagram for:

- Case-radiated sound power.
- Inlet side sound power
- Outlet side sound power.

The case-radiated noise as sound pressure at 1 m (free field conditions) is also specified in the type table and the table below the performance curve.

Accessory details Page

Filters, heating elements and silencers	473 ff.
Temperature control systems for heating elements	479, 483 ff.
Flexible ventilation ducts, ventilation grilles, fittings, roof outlets	553 ff.
Disc valves	574 ff.
Universal control system, electronic controllers, speed potentiometer	605 ff.

Accessories

Flexible connecting sleeve

FM 250 Ref. no. 01672

Includes 2 hose clamps; for installation between fan and duct system. Prevents structure-borne noise transmission and bridges installation tolerances.

2 pcs required for inlet and outlet side application.



External wall shutter

VK 250 Ref. no. 00759

Automatic made of plastic, light grey.



External wall cover grille

RAG 250 Ref. no. 00751

For placement in front of air inlet and outlet openings in facades.

Made of plastic, light grey.



Protection grille

SGR 250 Ref. no. 05067

For inlet and outlet side installation. Made of galvanised steel.



Duct shutter

RSK 250 Ref. no. 05673

Automatic, made of metal.



Flexible cross talk silencer

FSD 250 Ref. no. 00680

Made of aluminium pipe with double-sided plug-in connectors. Sound insulation lining 50 mm thick, installation length 1 m.



Air filter box

LFBR 250 Coarse 70%* 08580

LFBR 250 ePM1 50%* 08534

Air filter with large surface area, for installation in pipeline.



Electric heating element

EHR-R 6/250 6.0 kW No. 08712

– with integrated temp. control

EHR-R 6/250 TR 6.0 kW No. 05296

Room or duct sensor (TFK/TFR, Accessories) required.



Temperature control system for electric heating element

EHR-R

EHS

Ref. no. 05002

Warm water heating element

WHR 250 Ref. no. 09483

Compact heat exchanger for installation in duct system.



Temperature control system for warm water heating element

WHS HE Ref. no. 08319



* See product page 476 for detailed description.

SB EC 315



Virtually silent with high volume output and pressure performance. Ideal for cleaning and inspection.



SVS EC 315



Lowest installation height. Ideal for limited installation spaces. With sound-insulating mineral wool lining for particularly low-noise operation.



Dimensions SB EC 315

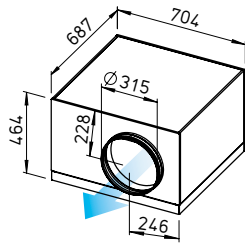

Dim. in mm

Dimensions SVS EC 315

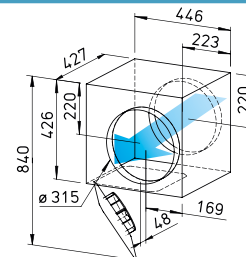

Dim. in mm

Common features SilentBox SB EC and SlimVent SVS EC

Installation

No restrictions in any position (horizontal, vertical, diagonal) through corresponding installation for supply or extract ventilation. Mounting bracket included in delivery.

Drive

Energy-saving, speed-controllable EC external rotor motor in protection category IP44 with the highest level of efficiency. Maintenance-free and radio interference-free, ball bearing mounted. Motor and impeller dynamically balanced for low-noise operation.

Power control

Continuously variable speed control with internal (delivery) or external potentiometer or conti-

nuously variable speed control with universal control system (see table). Performance levels are shown in the performance curve as an example.

Motor protection

Integrated electronic temperature monitoring system for EC motor and electronics.

Noise

See page 409.

Description SilentBox EC

Casing

Designed as a silencer. Equipped with abrasion-resistant, sound-absorbing mineral fibre boards (50 mm). Removable cover with locking clamp. Freely accessible fan. Removable motor-impeller unit, the removal area must be considered. Inlet and outlet side connectors with

rubber lip seal corresponds to standard duct Ø. All parts made of galvanised steel sheet.

Impeller

With backward curved blades. Inlet via nozzle.

Electrical connection

Terminal box (IP54) mounted to external cable (aprx. 60 cm long).

Protection category

IP54 with connected duct system.

Description SlimVent SVS EC

Casing

Extremely flat casing with sound-insulating, over 50 mm thick mineral wool lining and glass fibre surface. The acoustic box placed in front of the fan wheel significantly reduces the inlet-side noises. The radiated

noises are reduced to a lesser extent (see noise data above the performance diagrams).

The retractable motor-impeller unit allows inspection and cleaning without dismantling the system components. The removal area of the motor-impeller unit must be considered.

Impeller

Energy-saving centrifugal impeller with backward curved blades made of high-quality plastic.

Electrical connection

Terminal box (IP54) mounted to external cable.

Protection category

IP44 with connected duct system.

Type	Ref. no.	Connection Ø	Flow rate Free blowing	Rated speed	Sound press. case radiation	Power consum.	Current consum.	Wiring diagram	Max. air flow temp.	Wgt net aprx.	Universal control system		Speed potentiometer			
											Type	Ref. no.	Type	Ref. no.		
			mm	m³/h	min ⁻¹	dB(A) in 1 m	kW	A	No.	+ °C	kg	Type	Ref. no.	Type	Ref. no.	
Type SB EC, Single-phase alternating current, 230 V, 50/60 Hz, EC motor, IP54																
SB EC 315 A	06157	315	2490	1660	49	0.36	1.56	979	60	35	EUR EC ¹⁾²⁾	01347	PU 10 ¹⁾	01734	PA 10 ¹⁾	01735
SB EC 315 B	09628	315	3280	2210	53	0.85	3.73	979	60	38	EUR EC ¹⁾²⁾	01347	PU 10 ¹⁾	01734	PA 10 ¹⁾	01735
Type SVS EC, Single-phase alternating current, 230 V, 50/60 Hz, EC motor, IP44																
SVS EC 315 A	06126	315	1690	2330	50	0.21	1.66	979	60	16.5	EUR EC ¹⁾²⁾	01347	PU 10 ¹⁾	01734	PA 10 ¹⁾	01735
SVS EC 315 B ³⁾	00667	315	1940	2880	52	0.32	2.29	979	60	16.1	EUR EC ¹⁾²⁾	01347	PU 10 ¹⁾	01734	PA 10 ¹⁾	01735

¹⁾ Multiple EC fans can normally be connected. ²⁾ alternative electronic diff. pressure/ temperature controller (EDR/ETR, No. 01437/01438) or three level speed switch (SU/SA, No. 04266/04267), see accessories. ³⁾ Performance diagram at www.HeliosSelect.de.

Performance curves SB EC 315 A

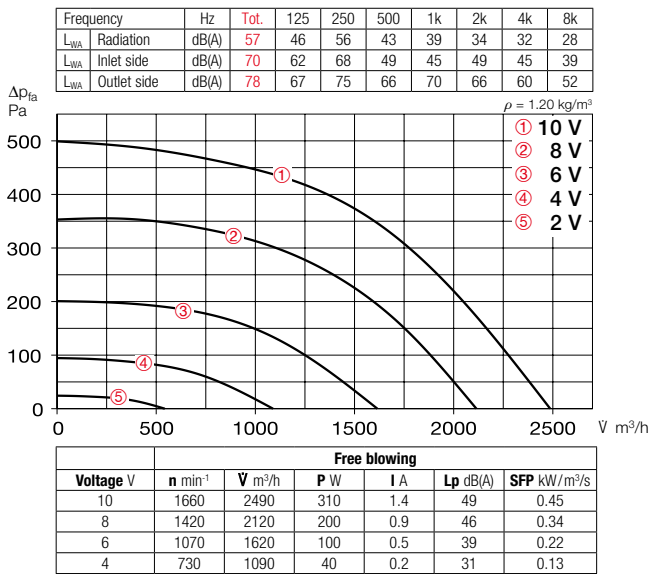

Performance curves SB EC 315 B

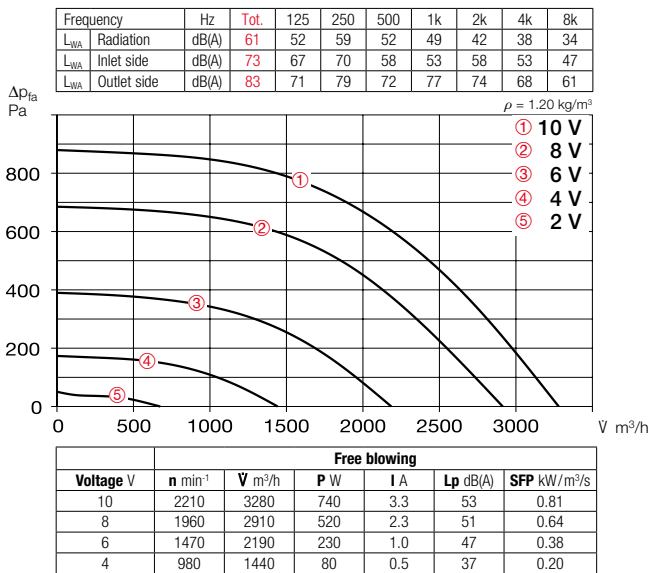

Performance curves SVS EC 315 A

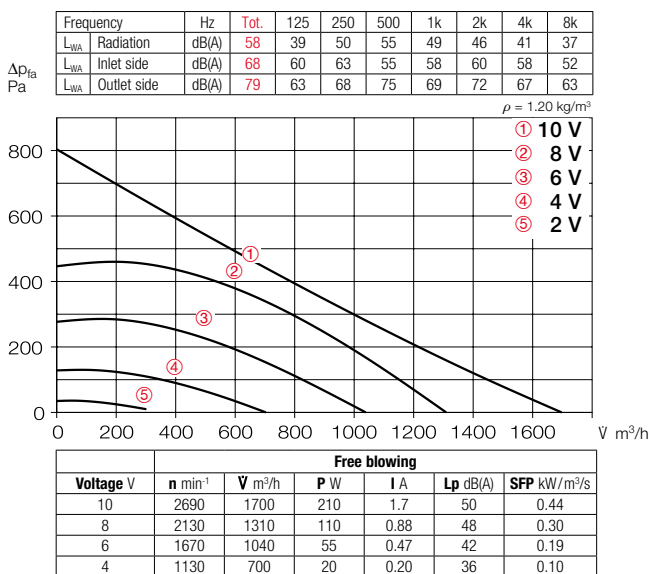

Accessories

Flexible connecting sleeve

FM 315 Ref. no. 01674

Includes 2 hose clamps; for installation between fan and duct system. Prevents structure-borne noise transmission and bridges installation tolerances.

2 pcs required for inlet and outlet side application.

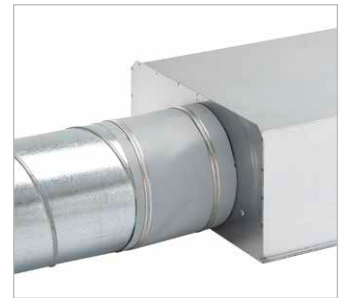

External wall shutter

VK 315 Ref. no. 00760

Automatic made of plastic, light grey.



External wall cover grille

RAG 315 Ref. no. 00752

For placement in front of air inlet and outlet openings in facades.

Made of plastic, light grey.



Protection grille

SGR 315 Ref. no. 05068

For inlet and outlet side installation. Made of galvanised steel.



Duct shutter

RSK 315 Ref. no. 05674

Automatic, made of metal.



Flexible cross talk silencer

FSD 315 Ref. no. 00681

Made of aluminium pipe with double-sided plug-in connectors. Sound insulation lining 50 mm thick, installation length 1 m.



Air filter box

LFBR 315 Coarse 70%* 08581

LFBR 315 ePM1 50%* 08535

Air filter with large surface area, for installation in pipeline.



Electric heating element

EHR-R 6/315 6.0 kWNo. 08713

- with integrated temp. control

EHR-R 6/315 TR 6.0 kWNo. 05301

Room or duct sensor (TFK/TFR, Accessories) required.



Temperature control system for electric heating element

EHR-R

EHS Ref. no. 05002



Warm water heating element

WHR 315 Ref. no. 09484

Compact heat exchanger for installation in duct system.



Temperature control system for warm water heating element

WHS HE Ref. no. 08319

* See product page 476 for detailed description.

SB EC 355



Virtually silent with high volume output and pressure performance. Ideal for cleaning and inspection.



Dimensions SB EC 355

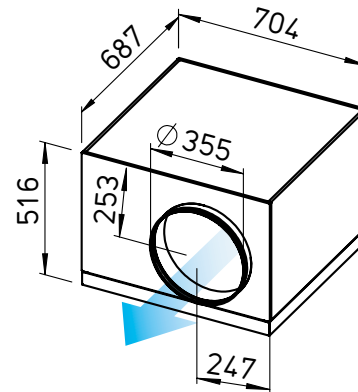

Dim. in mm

■ **Casing**

Designed as a silencer. Equipped with abrasion-resistant, sound-absorbing mineral fibre boards (50 mm). Removable cover with locking clamp. Freely accessible fan. Removable motor-impeller unit, the removal area must be considered. Inlet and outlet side connectors with rubber lip seal corresponds to standard duct Ø. All parts made of galvanised steel sheet.

■ **Impeller**

With backward curved blades. Inlet via nozzle.

■ **Drive**

Energy-saving, speed-controllable EC external rotor motor in protection category IP44 with the highest level of efficiency. Maintenance-free and radio interference-free, ball bearing mounted. Motor and impeller dynamically balanced for low-noise operation.

■ **Motor protection**

Integrated electronic temperature monitoring system for EC motor and electronics.

■ **Power control**

Continuously variable speed control with internal (delivery) or external potentiometer or continuously variable speed control with universal control system (see table). Performance levels are shown in the performance curve as an example.

■ **Electrical connection**

Terminal box (IP54) mounted to external cable (aprx. 60 cm long).

■ **Protection category**

IP44 with connected duct system.

■ **Installation**

No restrictions in any position (horizontal, vertical, diagonal) through corresponding installation for supply or extract ventilation. Mounting bracket included in delivery.

■ **Noise**

The total level and range are specified above the performance diagram for:

- Case-radiated sound power
- Inlet side sound power
- Outlet side sound power.

The case-radiated noise as sound pressure at 1 m (free field conditions) is also specified in the type table and the table below the performance curve.

Type	Ref. no.	Connection Ø	Flow rate Free blowing	Rated speed	Sound press. case radiation	Power consum.	Current consum.	Wiring diagram	Max. air flow temp.	Wgt net aprx.	Universal control system		Speed potentiometer			
											Type	Ref. no.	Type	Ref. no.	Type	Ref. no.
		mm	m³/h	min ⁻¹	dB(A) in 1 m	kW	A	No.	+ °C	kg	Type	Ref. no.	Type	Ref. no.	Type	Ref. no.
Type SB EC, Single-phase alternating current, 230 V, 50/60 Hz, EC motor, IP54																
SB EC 355	06139	355	2710	1630	53	0.36	1.56	979	60	38	EUR EC ¹⁾²⁾	01347	PU 10 ¹⁾	01734	PA 10 ¹⁾	01735

¹⁾ Multiple EC fans can normally be connected. ²⁾ alternative electronic diff. pressure/ temperature controller (EDR/VETR, No. 01437/01438) or three level speed switch (SU/SA, No. 04266/04267), see accessories.

Performance curves SB EC 355

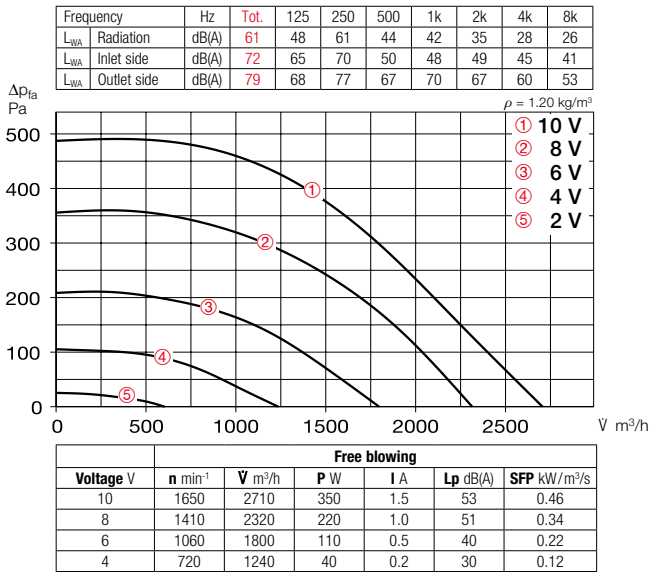

Accessory details Page

Filters, heating elements and silencers	473 ff.
Temperature control systems for heating elements	479, 483 ff.
Flexible ventilation ducts, ventilation grilles, fittings, roof outlets	553 ff.
Disc valves	574 ff.
Universal control system, electronic controllers, speed potentiometer	605 ff.

Accessories

Flexible connecting sleeve

FM 355 Ref. no. 01675
Includes 2 hose clamps; for installation between fan and duct system. Prevents structure-borne noise transmission and bridges installation tolerances. 2 pcs required for inlet and outlet side application.

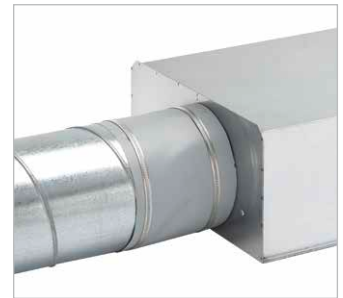

External wall shutter

VK 355 Ref. no. 00761
Automatic made of plastic, light grey.



External wall cover grille

RAG 355 Ref. no. 00753
For placement in front of air inlet and outlet openings in facades. Made of plastic, light grey.



Duct shutter

RSK 355 Ref. no. 05650
Automatic, made of metal.



Flexible cross talk silencer

FSD 355 Ref. no. 00682
Made of aluminium pipe with double-sided plug-in connectors. Sound insulation lining 50 mm thick, installation length 1 m.



Air filter box

LFBR 355 Coarse 70%* 08583
LFBR 355 ePM1 50%* 08536
Air filter with large surface area and absorption capacity for installation in pipeline. Connections with double lip seal, matched to standard.



Electric heating element

EHR-R 355 9.0 kWNo. 08656
– with integrated temp. control
EHR-R 9/355 TR 9.0 kWNo. 05297
Room or duct sensor (TFK/TFR, Accessories) required.



Temperature control system for electric heating element

EHR-R
EHSD 16 Ref. no. 05003



Warm water heating element

WHR 355 Ref. no. 08790
Compact heat exchanger for installation in duct system.



Temperature control system for warm water heating element

WHS HE Ref. no. 08319



* See product page 476 for detailed description.

SB EC 400



Virtually silent with high volume output and pressure performance. Ideal for cleaning and inspection.



Dimensions SB EC 400

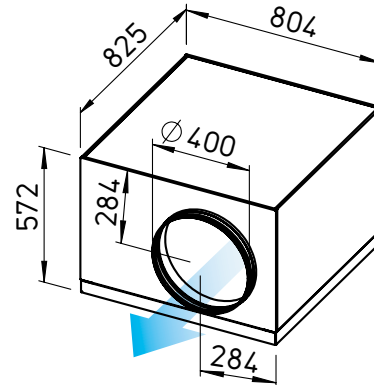

Dim. in mm

■ **Casing**

Designed as a silencer. Equipped with abrasion-resistant, sound-absorbing mineral fibre boards (50 mm). Removable cover with locking clamp. Freely accessible fan. Removable motor-impeller unit, the removal area must be considered. Inlet and outlet side connectors with rubber lip seal corresponds to standard duct Ø. All parts made of galvanised steel sheet.

■ **Impeller**

With backward curved blades. Inlet via nozzle.

■ **Drive**

Energy-saving, speed-controllable EC external rotor motor in protection category IP44 with the highest level of efficiency. Maintenance-free and radio interference-free, ball bearing mounted. Motor and impeller dynamically balanced for low-noise operation.

■ **Motor protection**

Integrated electronic temperature monitoring system for EC motor and electronics.

■ **Power control**

Continuously variable speed control with internal (delivery) or external potentiometer or continuously variable speed control with universal control system (see table). Performance levels are shown in the performance curve as an example.

■ **Electrical connection**

Terminal box (IP54) mounted to external cable (aprx. 60 cm long).

■ **Protection category**

IP44 with connected duct system.

■ **Installation**

No restrictions in any position (horizontal, vertical, diagonal) through corresponding installation for supply or extract ventilation. Mounting bracket included in delivery.

■ **Noise**

The total level and range are specified above the performance diagram for:

- Case-radiated sound power
- Inlet side sound power
- Outlet side sound power.

The case-radiated noise as sound pressure at 1 m (free field conditions) is also specified in the type table and the table below the performance curve.

Type	Ref. no.	Connection Ø	Flow rate Free blowing	Rated speed	Sound press. case radiation	Power consum.	Current consum.	Wiring diagram	Max. air flow temp.	Wgt net aprx.	Universal control system		Speed potentiometer			
											Type	Ref. no.	Type	Ref. no.	Type	Ref. no.
		mm	∇ m³/h	min ⁻¹	dB(A) in 1 m	kW	A	No.	+ °C	kg	Type	Ref. no.	Type	Ref. no.	Type	Ref. no.
Type SB EC, Single-phase alternating current, 230 V, 50/60 Hz, EC motor, IP54																
SB EC 400 A	06140	400	2980	1640	51	0.36	1.59	979	60	52	EUR EC ¹⁾²⁾	01347	PU 10 ¹⁾	01734	PA 10 ¹⁾	01735
SB EC 400 B	09629	400	4570	1510	58	0.80	3.49	979	60	55	EUR EC ¹⁾²⁾	01347	PU 10 ¹⁾	01734	PA 10 ¹⁾	01735

¹⁾ Multiple EC fans can normally be connected. ²⁾ alternative electronic diff. pressure/ temperature controller (EDR/ETR, No. 01437/01438) or three level speed switch (SU/SA, No. 04266/04267), see accessories.

Performance curves SB EC 400 A

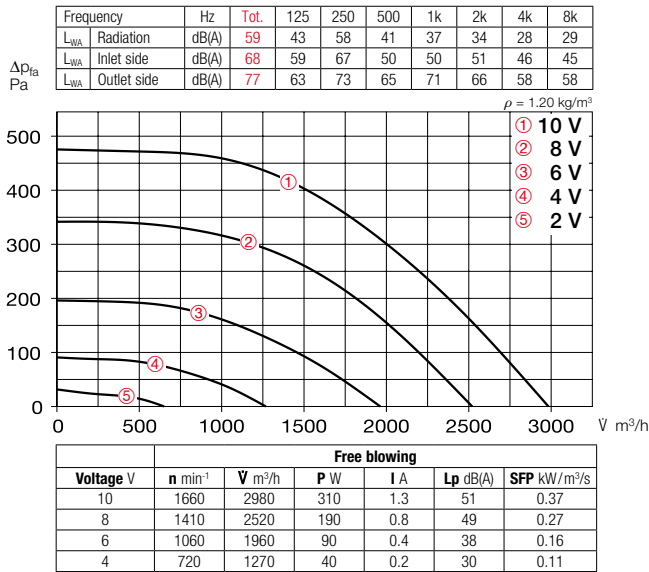

Performance curves SB EC 400 B

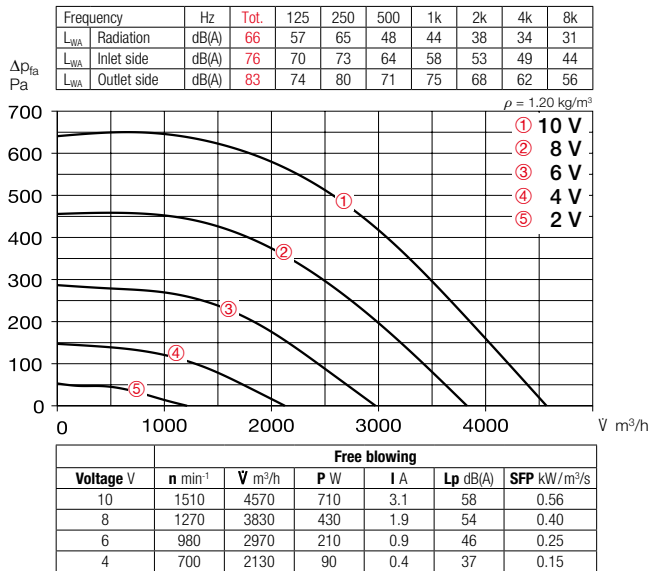

Accessory details Page

Filters, heating elements and silencers	473 ff.
Temperature control systems for heating elements	479, 483 ff.
Flexible ventilation ducts, ventilation grilles, fittings, roof outlets	553 ff.
Disc valves	574 ff.
Universal control system, electronic controllers, speed potentiometer	605 ff.

Accessories

Flexible connecting sleeve FM 400 Ref. no. 01676
Includes 2 hose clamps; for installation between fan and duct system. Prevents structure-borne noise transmission and bridges installation tolerances. 2 pcs required for inlet and outlet side application.



External wall shutter VK 400 Ref. no. 00762
Automatic made of plastic, light grey.



External wall cover grille RAG 400 Ref. no. 00754
For placement in front of air inlet and outlet openings in facades. Made of plastic, light grey.



Duct shutter RSK 400 Ref. no. 05651
Automatic, made of metal.



Flexible cross talk silencer FSD 400 Ref. no. 00683
Made of aluminium pipe with double-sided plug-in connectors. Sound insulation lining 50 mm thick, installation length 1 m.



Air filter box LFBR 400 Coarse 70%* 08582
LFBR 400 ePM1 50%* 08537
Air filter with large surface area and absorption capacity for installation in pipeline. Connections with double lip seal, matched to standard.



Electric heating element EHR-R 9/400 9.0 kW No. 08657
- with integrated temp. control
EHR-R 9/400 TR 9.0 kW No. 05299
Room or duct sensor (TFK/TFR, Accessories) required.



Temperature control system for electric heating element EHR-R
EHSD 16 Ref. no. 05003



Warm water heating element WHR 400 Ref. no. 09524
Compact heat exchanger for installation in duct system.



Temperature control system for warm water heating element WHS HE Ref. no. 08319



* See product page 476 for detailed description.

SB 125



Efficiency class

D SB + accessories*

Virtually silent with high volume output and pressure performance. Ideal for cleaning and inspection.

SVS 125



Efficiency class

C SVS + accessories*

Lowest installation height. Ideal for limited installation spaces. With sound-insulating mineral wool lining for particularly low-noise operation.

Dimensions SB 125

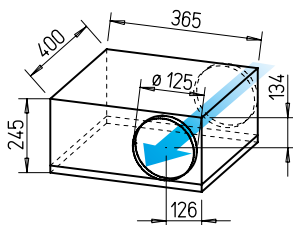

Dim. in mm

Dimensions SVS 125

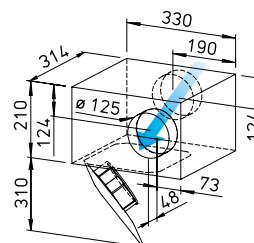

Dim. in mm

Common features SB and SVS

Installation

No restrictions in any position (horizontal, vertical, diagonal) through corresponding installation for supply or extract ventilation (exception: SVS must not be installed with the retractable motor-impeller unit upward).

Motor

Enclosed, ball bearing mounted external rotor motor with humidity protection, insulation class F, for continuous operation, maintenance-free and radio interference-free.

Description SilentBox

Casing

Designed as a silencer. Equipped with abrasion-resistant, sound-absorbing mineral fibre boards (50 mm). Removable cover with locking clamp.

Freely accessible fan and casing spiral. Retractable motor and impeller. Inlet and outlet side connectors with rubber lip seal corresponds to standard duct Ø. All parts made of galvanised steel sheet.

Impeller

Low-noise forward curved impeller in aerodynamically optimised volute casing, made of galvanised steel sheet. Inlet via nozzle.

Electrical connection

Terminal box (IP54) mounted to external cable (aprx. 60 cm long).

Motor protection

Through built-in thermal contacts wired in series to the winding, automatic deactivation and reactivation after cooling.

Power control

From 0 – 100 % possible using electronic controller or step transformer (see table).

Protection category

IP44

Description SlimVent SVS

Casing

Extremely flat casing with sound-insulating, over 50 mm thick mineral wool lining and glass fibre surface. The acoustic box placed in front of the fan wheel significantly reduces the inlet-side noises. The radiated noises are reduced to a lesser extent (see noise data above the performance diagrams).

The retractable motor-impeller unit allows inspection and cleaning without dismantling the system components. The removal area of the motor-impeller

unit must be considered.

Impeller

Energy-saving centrifugal impeller with backward curved blades made of high-quality plastic. Dynamically balanced for low-noise operation.

Electrical connection

Terminal box (IP54) mounted to external cable.

Motor protection

Through built-in thermal contacts wired in series to the winding, automatic deactivation and reactivation after cooling.

Power control

From 0 – 100 % possible using electronic controller or step transformer (see table) or two level operation with type DS 2/2 (accessories).

DS 2/2 Ref. no. 01267

Type	Ref. no.	Flow rate Free blowing	Rated speed	Sound press. case radiation	Power consum.	Power consum. at rated voltage	Power consum. with control	Wiring diagram	Max air flow temp.		Wgt net aprx.	Transformer speed controller 5-step		Electronic ²⁾ Speed control., cont. var. flush-mount. / surf-mount.	
									at rated voltage	with control		Type	Ref. no.	Type	Ref. no.
		V m ³ /h	min ⁻¹	db(A) in 1m	W	A	A	No.	+ °C	+ °C	kg	Type	Ref. no.	Type	Ref. no.
Type SB, Single-phase alternating current, 230 V, 50 Hz, Capacitor motor, IP44															
SB 125 A	09506	230	1130	28	61	0.27	0.27	508	80	80	12.0	TSW 0.3	03608	ESU 1/ESA 1	00236/00238
SB 125 C	09562	440	1850	37	122	0.53	0.53	508	65	65	12.0	TSW 1.5	01495	ESU 1/ESA 1	00236/00238
Type SVS, Single-phase alternating current, 230 V, 50 Hz, Capacitor motor, IP33															
SVS 125 B	00130	400/270 ¹⁾	2570/1710 ¹⁾	45/36 ¹⁾	61/45 ¹⁾	0.27/0.20 ¹⁾	0.26 ¹⁾	934.1	60	60	5.9	TSW 1.5	01495	ESU 1/ESA 1	00236/00238

¹⁾ Values refer to the two performance levels (see performance diagram). ²⁾ Transformer control units must be provided in noise-relevant cases. Electronic phase angle control can cause disturbing magnetisation humming. *See ErP product data sheet at www.HeliosSelect.de.

Performance curves SB 125 A

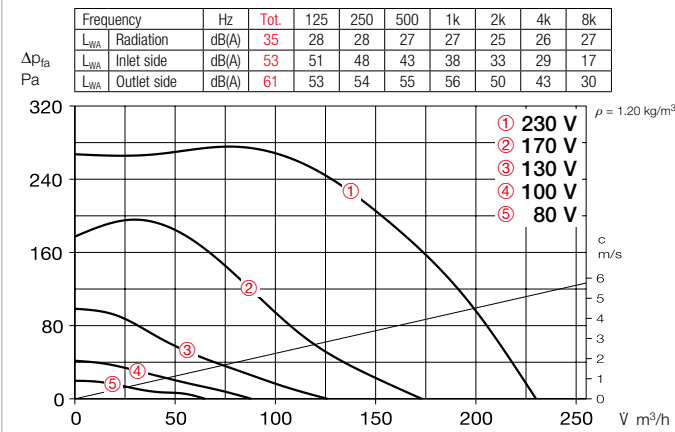

Performance curves SB 125 C

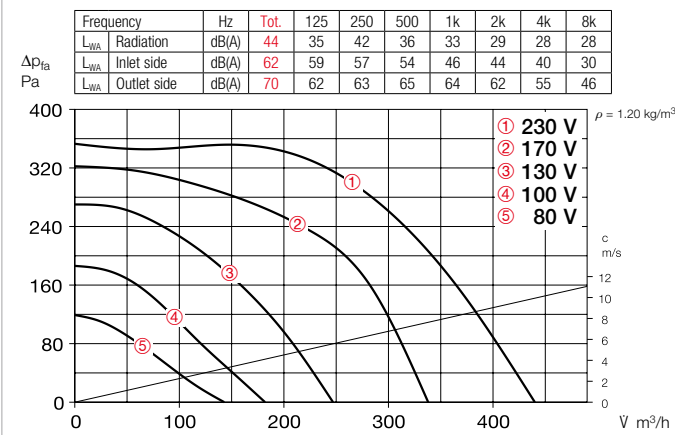

Performance curves SVS 125 B

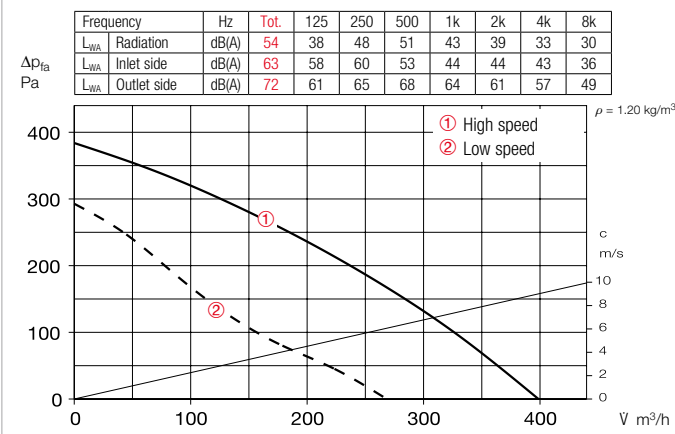

Protection category

IP44 with connected duct system.

Noise

The total level and range are specified above the performance diagram for

- Case-radiated sound power.
- Inlet/outlet side sound power in dB(A).
- The case-radiated noise as sound pressure at 1 m (free field conditions) are also specified in the type table.

Accessory details Page

Filters, heating elements and silencers	473 ff.
Temperature control systems for heating elements	479, 483 ff.
Flexible ventilation ducts, ventilation grilles, fittings, roof outlets	553 ff.
Disc valves	574 ff.
Universal control system, electronic controllers, speed potentiometer	605 ff.

Accessories

Flexible connecting sleeve

FM 125 Ref. no. 01682

Includes 2 hose clamps; for installation between fan and duct system. Prevents structure-borne noise transmission and bridges installation tolerances.

2 pcs required for inlet and outlet side application.



External wall shutter

VK 125 Ref. no. 00857

Automatic made of plastic, white.



External wall cover grille

G 160 Ref. no. 00893

Made of plastic, white.



Protection grille

SGR 125 Ref. no. 05064

For inlet and outlet side installation. Made of powder-coated steel wire.



Duct shutter

RSKK 125 Ref. no. 05107

Automatic, made of plastic.



Flexible cross talk silencer

FSD 125 Ref. no. 00677

Made of aluminium pipe with double-sided plug-in connectors. Sound insulation lining 50 mm thick, installation length 1 m.



Air filter box

LFBR 125 Coarse 70%* 08577

LFBR 125 ePM1 50%* 08531

Air filter with large surface area, for installation in pipeline.



Electric heating element

EHR-R 0.8/125 0.8 kW No. 08709

EHR-R 1.2/125 1.2 kW No. 09433

– with integrated temp. control

EHR-R 0.8/125 TR 0.8 kW No. 05293

Room or duct sensor (TFK/TFR, Accessories) required.



Temperature control system for electric heating element

EHR-R

EHS Ref. no. 05002



Warm water heating element

WHR 125 Ref. no. 09480

Compact heat exchanger for installation in duct system.



Temperature control system for warm water heating element

WHST 300 T38 No. 08817



* See product page 476 for detailed description.

SB 160



Efficiency class

D SB + accessories*

Virtually silent with high volume output and pressure performance. Ideal for cleaning and inspection.

Dimensions SB 160

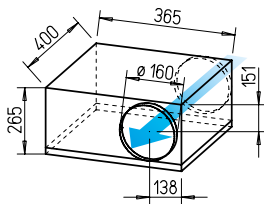

Dim. in mm

Common features SB and SVS

- Installation see page 416.
- Motor see page 416.
- Noise see page 417.

Description SilentBox

■ **Casing**
Designed as a silencer. Equipped with abrasion-resistant, sound-absorbing mineral fibre boards (50 mm). Removable cover with locking clamp. Freely accessible fan. Removable motor-impeller unit, the removal area must be considered. Inlet and outlet side connectors with rubber lip seal corresponds to standard duct Ø. All parts made of galvanised steel sheet.

- **Impeller**
Low-noise forward curved impeller in aerodynamically optimised volute casing, made of galvanised steel sheet. Inlet via nozzle.
- **Electrical connection**
Terminal box (IP54) mounted to external cable (aprx. 60 cm long).
- **Motor protection**
Through built-in thermal contacts wired in series to the winding, which automatically activated and deactivate again after cooling.
- **Power control**
From 0 – 100 % possible using electronic controller or step transformer (see table).
- **Protection category**
IP44

SVS 160



Efficiency class

C SVS 160 L + accessories*

Lowest installation height. Ideal for limited installation spaces. With sound-insulating mineral wool lining for particularly low-noise operation.

Dimensions SVS 160

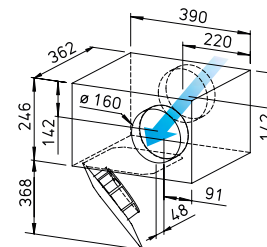

Dim. in mm

Description SlimVent SVS

- **Casing**
Extremely flat casing with sound-insulating, over 50 mm thick mineral wool lining and glass fibre surface. The acoustic box placed in front of the fan wheel significantly reduces the inlet-side noises. The radiated noises are reduced to a lesser extent (see noise data above the performance diagrams).
- The retractable motor-impeller unit allows inspection and cleaning without dismantling the system components. The removal area of the motor-impeller unit must be considered.
- **Impeller**
Energy-saving centrifugal impeller with backward curved blades made of high-quality plastic. Dy-

namically balanced for low-noise operation.

- **Electrical connection**
Terminal box (IP54) mounted to external cable.
- **Motor protection**
Through built-in thermal contacts wired in series to the winding, automatic deactivation and reactivation after cooling.
- **Power control**
From 0 – 100 % possible using electronic controller or step transformer (see table) or two level operation with type DS 2/2 (accessories).
DS 2/2 Ref. no. 01267
- **Protection category**
IP44 with connected duct system.

Type	Ref. no.	Flow rate Free blowing	Rated speed	Sound press. case radiation	Power consum.	Power consum. at rated voltage	Power consum. with control	Wiring diagram	Max air flow temp. at rated voltage	Wgt net aprx.	Transformer speed controller 5-step	Electronic ²⁾ Speed controll., cont. var. flush-mount. / surf-mount.			
												Type	Ref. no.	Type	Ref. no.
		V m ³ /h	min ⁻¹	db(A) in 1m	W	A	A	No.	+ °C	+ °C	kg	Type	Ref. no.	Type	Ref. no.
Type SB, Single-phase alternating current, 230 V, 50 Hz, Capacitor motor, IP44 (B), IP33 (D)															
SB 160 B	09508	360	1650	36	105	0.46	0.46	508	65	65	13.0	TSW 1.5	01495	ESU1 / ESA 1	00236 / 00238
SB 160 D	09563	580	2220	43	164	0.72	0.72	508	60	60	10.3	TSW 1.5	01495	ESU1 / ESA 1	00236 / 00238
Type SVS, Single-phase alternating current, 230 V, 50 Hz, Capacitor motor, IP33															
SVS 160 K	00131	440/300 ¹⁾	2560/1730 ¹⁾	44/35 ¹⁾	61/45 ¹⁾	0.26/0.20 ¹⁾	0.26 ¹⁾	934.1	60	60	7.6	TSW 1.5	01495	ESU1 / ESA 1	00236 / 00238
SVS 160 L	02653	670/390 ¹⁾	2520/1530 ¹⁾	50/39 ¹⁾	108/69 ¹⁾	0.47/0.30 ¹⁾	0.45 ¹⁾	934.1	60	60	7.8	TSW 1.5	01495	ESU1 / ESA 1	00236 / 00238

¹⁾ Values refer to the two performance levels (see performance diagram). ²⁾ Transformer control units must be provided in noise-relevant cases. Electronic phase angle control can cause disturbing magnetisation humming. * See ErP product data sheet at www.HeliosSelect.de.

Performance curves SB 160 B

Frequency	Hz	Tot.	125	250	500	1k	2k	4k	8k
L _{WA} Radiation		dB(A)	43	40	39	34	28	27	27
L _{WA} Inlet side		dB(A)	61	59	56	50	44	39	26
L _{WA} Outlet side		dB(A)	68	61	61	62	61	58	44

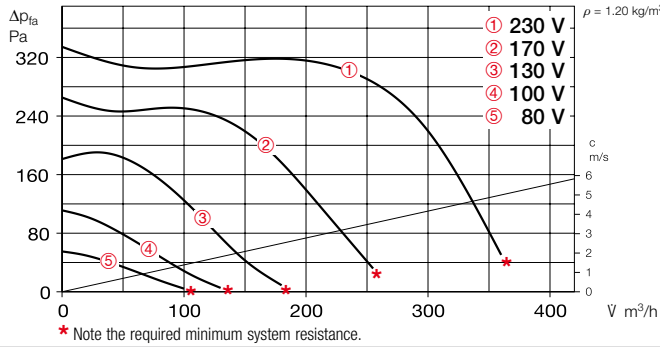

Performance curves SB 160 D

Frequency	Hz	Tot.	125	250	500	1k	2k	4k	8k
L _{WA} Radiation		dB(A)	50	47	44	41	34	30	28
L _{WA} Inlet side		dB(A)	67	65	60	53	44	46	45
L _{WA} Outlet side		dB(A)	79	68	71	72	69	69	69

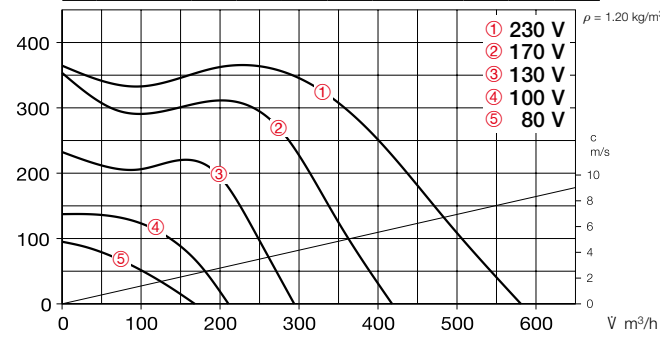

Performance curves SVS 160 K

Frequency	Hz	Tot.	250	500	1k	2k	4k	8k	
L _{WA} Radiation		dB(A)	52	38	47	50	40	37	31
L _{WA} Inlet side		dB(A)	63	58	61	50	40	45	38
L _{WA} Outlet side		dB(A)	70	60	66	65	59	56	48

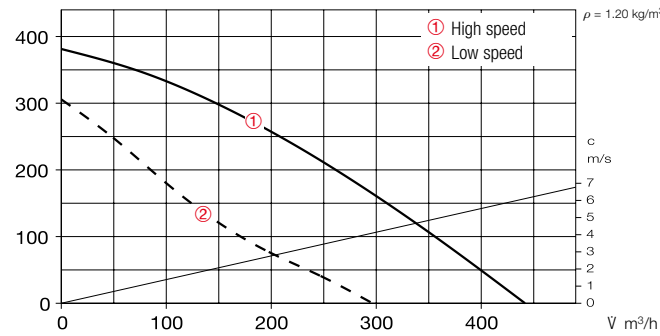

Performance curves SVS 160 L

Frequency	Hz	Tot.	125	250	500	1k	2k	4k	8k
L _{WA} Radiation		dB(A)	58	40	53	55	46	44	38
L _{WA} Inlet side		dB(A)	66	60	64	58	50	47	35
L _{WA} Outlet side		dB(A)	75	62	67	73	66	63	51

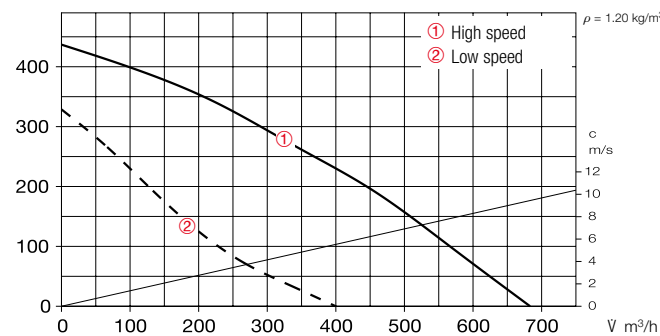

Accessories

Flexible connecting sleeve

FM 160 Ref. no. 01684
Includes 2 hose clamps; for installation between fan and duct system. Prevents structure-borne noise transmission and bridges installation tolerances. 2 pcs required for inlet and outlet side application.



External wall shutter

VK 160 Ref. no. 00892
Automatic made of plastic, white.



External wall cover grille

G 160 Ref. no. 00893
Made of plastic, white.



Protection grille

SGR 160 Ref. no. 05069
For inlet and outlet side installation. Made of galvanised steel.



Duct shutter

RSK 160 Ref. no. 05669
Automatic, made of metal.



Flexible cross talk silencer

FSD 160 Ref. no. 00678
Made of aluminium pipe with double-sided plug-in connectors. Sound insulation lining 50 mm thick, installation length 1 m.



Air filter box

LFBR 160 Coarse 70%* 08578
LFBR 160 ePM1 50%* 08532
Air filter with large surface area, for installation in pipeline.

Electric heating element

EHR-R 1.2/160 1.2 kWNo. 09434
EHR-R 2.4/160 2.4 kWNo. 09435
EHR-R 5/160 5.0 kWNo. 08710
– with integrated temp. control
EHR-R 2.4/160 TR 2.4 kWNo. 05294
Room or duct sensor (TFK/TFR, Accessories) required.



Temperature control system for electric heating element

EHR-R
EHS Ref. no. 05002

Warm water heating element

WHR 160 Ref. no. 09481
Compact heat exchanger for installation in duct system.



Temperature control system for warm water heating element

WHST 300 T38 No. 08817



* See product page 476 for detailed description.

SB 200



Efficiency class

B SB 200 C + accessories*

Virtually silent with high volume output and pressure performance. Ideal for cleaning and inspection.

SVS 200



Lowest installation height. Ideal for limited installation spaces. With sound-insulating mineral wool lining for particularly low-noise operation.

Dimensions SB 200

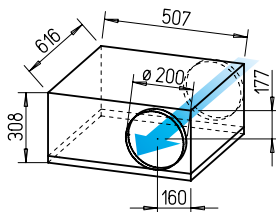

Dim. in mm

Dimensions SVS 200

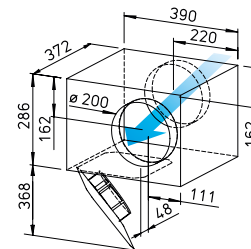

Dim. in mm

Common features SB and SVS

Installation

No restrictions in any position (horizontal, vertical, diagonal) through corresponding installation for supply or extract ventilation (exception: SVS must not be installed with the retractable motor-impeller unit upward).

Motor

Enclosed, ball bearing mounted external rotor motor with humidity protection, insulation class F, for continuous operation, maintenance-free and radio interference-free.

Description SilentBox

Casing

Designed as a silencer. Equipped with abrasion-resistant, sound-absorbing mineral fibre boards (50 mm). Removable cover with locking clamp. Freely accessible

fan. Removable motor-impeller unit, the removal area must be considered. Inlet and outlet side connectors with rubber lip seal corresponds to standard duct Ø. All parts made of galvanised steel sheet.

Impeller

With backward curved blades made of high-quality plastic. Inlet via nozzle.

Electrical connection

Terminal box (IP54) mounted to external cable (aprx. 60 cm long).

Motor protection

Through built-in thermal contacts wired in series to the winding, which automatically activated and deactivate again after cooling.

Power control

From 0 – 100 % possible using electronic controller or step

transformer (see table).

Protection category IP44.

Description SlimVent SVS

Casing

Extremely flat casing with sound-insulating, over 50 mm thick mineral wool lining and glass fibre surface. The acoustic box placed in front of the fan wheel significantly reduces the inlet-side noises. The radiated noises are reduced to a lesser extent (see noise data above the performance diagrams).

The retractable motor-impeller unit allows inspection and cleaning without dismantling the system components. The removal area of the motor-impeller unit must be considered.

Impeller

Energy-saving centrifugal impeller with backward curved blades made of high-quality plastic. Dynamically balanced for low-noise operation.

Electrical connection

Terminal box (IP54) mounted to external cable.

Motor protection

Through built-in thermal contacts wired in series to the winding, automatic deactivation and reactivation after cooling.

Power control

From 0 – 100 % using electronic controller or step transformer (see table).

Protection category

IP44 with connected duct system.

Type	Ref. no.	Flow rate Free blowing	Rated speed	Sound press. case radiation	Power consum.	Power consump.		Wiring diagram	Max air flow temp.		Wgt net aprx.	Transformer speed controller 5-step		Electronic ¹⁾ Speed controll., cont. var. flush-mount. / surf-mount.	
						at rated voltage	with control		at rated voltage	with control		Type	Ref. no.	Type	Ref. no.
		V m ³ /h	min ⁻¹	db(A) in 1m	W	A	A	No.	+ °C	+ °C	kg	Type	Ref. no.	Type	Ref. no.
Type SB, SB, Single-phase alternating current, 230 V, 50 Hz, Capacitor motor, IP33															
SB 200 C	09510	810	2520	44	105	0.46	0.46	508	70	70	19.0	TSW 1.5	01495	ESU1/ESA 1	00236/00238
SB 200 D	09564	1030	2700	48	160	0.69	0.83	508	70	50	19.7	TSW 1.5	01495	ESU1/ESA 1	00236/00238
Type SVS, Single-phase alternating current, 230 V, 50 Hz, Capacitor motor, IP33															
SVS 200 K	00132	940	2710	55	163	0.71	0.83	508	70	50	9.2	TSW 1.5	01495	ESU1/ESA 1	00236/00238

¹⁾ Transformer control units must be provided in noise-relevant cases. Electronic phase angle control can cause disturbing magnetisation humming.

* See ErP product data sheet at www.HeliosSelect.de.

Performance curves SB 200 C

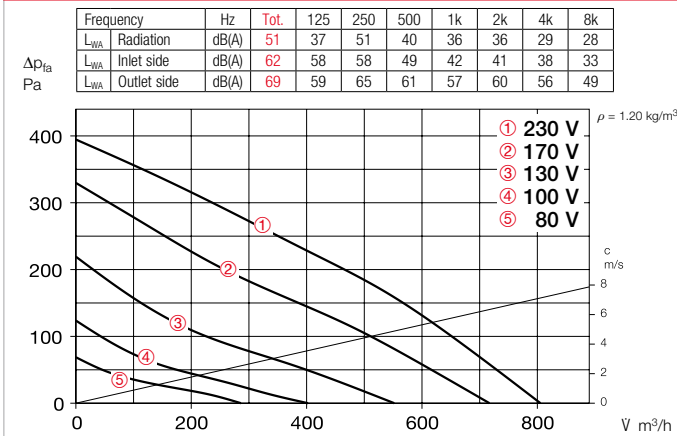

Performance curves SB 200 D

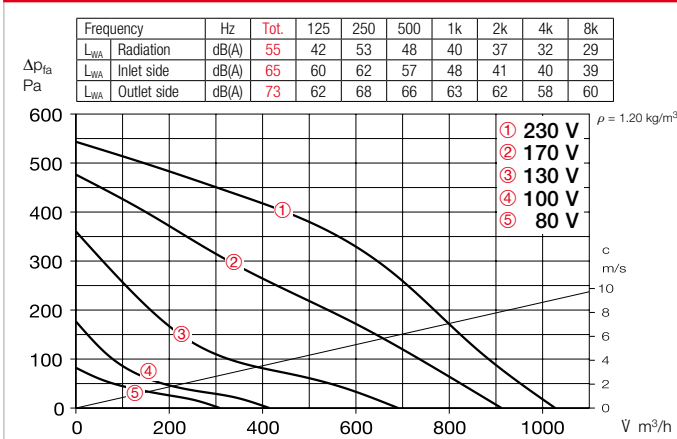

Performance curves SVS 200 K

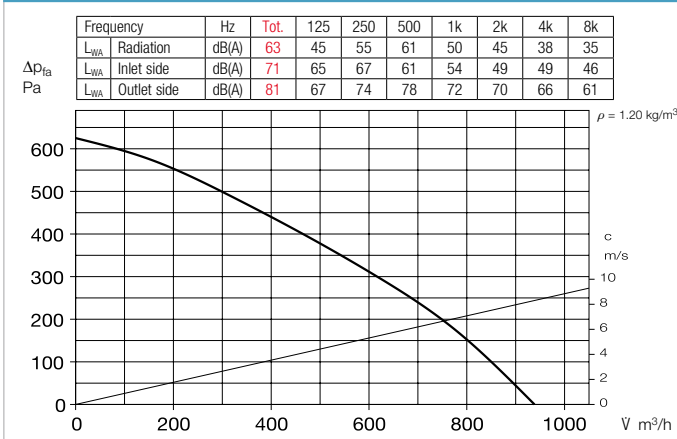

Noise

- The total level and range are specified above the performance diagram for
- Case-radiated sound power.
 - Inlet/outlet side sound power in dB(A).
 - The case-radiated noise as sound pressure at 1 m (free field conditions) are also specified in the type table.

Accessory details Page

Filters, heating elements and silencers	473 ff.
Temperature control systems for heating elements	479, 483 ff.
Flexible ventilation ducts, ventilation grilles, fittings, roof outlets	553 ff.
Disc valves	574 ff.
Universal control system, electronic controllers, speed potentiometer	605 ff.

References Page

Techn. description	352
Selection table	353
Planning information	10 ff.
Modular system	350

Accessories

Flexible connecting sleeve

FM 200 Ref. no. 01670

Includes 2 hose clamps; for installation between fan and duct system. Prevents structure-borne noise transmission and bridges installation tolerances.

2 pcs required for inlet and outlet side application.

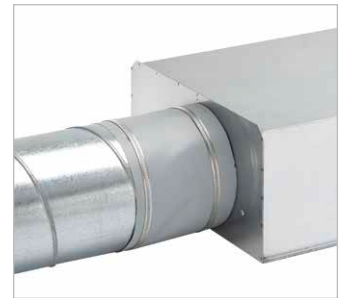

External wall shutter

VK 200 Ref. no. 00758

Automatic made of plastic, light grey.



External wall cover grille

RAG 200 Ref. no. 00750

For placement in front of air inlet and outlet openings in facades.

Made of plastic, light grey.



Protection grille

SGR 200 Ref. no. 05066

For inlet and outlet side installation. Made of galvanised steel.



Duct shutter

RSK 200 Ref. no. 05074

Automatic, made of metal.



Flexible cross talk silencer

FSD 200 Ref. no. 00679

Made of aluminium pipe with double-sided plug-in connectors. Sound insulation lining 50 mm thick, installation length 1 m.



Air filter box

LFBR 200 Coarse 70%* 08579

LFBR 200 ePM1 50%* 08533

Air filter with large surface area, for installation in pipeline.

Electric heating element

EHR-R 1.2/200 1.2 kWNo. 09436

EHR-R 2/200 2.0 kWNo. 09437

EHR-R 5/200 5.0 kWNo. 08711

– with integrated temp. control

EHR-R 5/200 TR 5.0 kWNo. 05295

Room or duct sensor (TFK/TFR, Accessories) required.



Temperature control system for electric heating element EHR-R

EHS Ref. no. 05002



Warm water heating element

WHR 200 Ref. no. 09482

Compact heat exchanger for installation in duct system.



Temperature control system for warm water heating element

WHST 300 T38 No. 08817

* See product page 476 for detailed description.

SB 250 C



Efficiency class

C SB + accessories*

Virtually silent with high volume output and pressure performance. Ideal for cleaning and inspection.

SB 250 E



Lowest installation height. Ideal for limited installation spaces. With sound-insulating mineral wool lining for particularly low-noise operation.

Dimensions SB 250 C

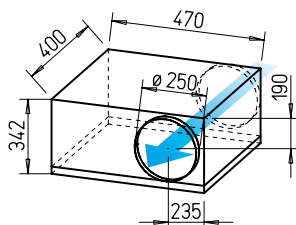

Dim. in mm

Dimensions SB 250 E

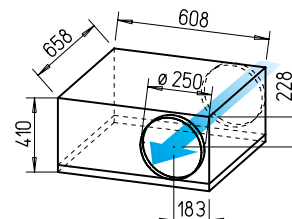

Dim. in mm

Common features SB 250 C and E

Installation

No restrictions in any position (horizontal, vertical, diagonal) through corresponding installation for supply or extract ventilation.

Motor

Enclosed, ball bearing mounted external rotor motor with humidity protection, insulation class F, for continuous operation, maintenance-free and radio interference-free.

Motor protection

Through built-in thermal contacts wired in series to the winding, which automatically activated and deactivate again after cooling.

Power control

From 0 – 100 % possible using electronic controller or step transformer (see table).

Electrical connection

Terminal box (IP54) mounted to external cable (aprx. 60 cm long).

Protection category IP44.

Description SB 250 C

Casing

Designed as a silencer. Equipped with abrasion-resistant, sound-absorbing mineral fibre boards (50 mm). Removable cover with locking clamp. Freely accessible fan. Removable motor-impeller unit, the removal area must be considered. Inlet and outlet side connectors with rubber lip seal corresponds to standard duct Ø. All parts made of galvanised steel sheet.

Impeller

Forward curved impeller in aerodynamically optimised volute casing, made of galvanised steel sheet. Inlet via nozzle.

Description SB 250 E

Casing

Designed as a silencer. Equipped with abrasion-resistant, sound-absorbing mineral fibre boards (50 mm). Removable cover with locking clamp. Freely accessible fan. Removable motor-impeller unit. Inlet and outlet side connectors with rubber lip seal corresponds to standard duct Ø. All parts made of galvanised steel sheet.

Impeller

With backward curved blades made of high-quality plastic. Dynamically balanced for low-noise operation. Inlet via nozzle.

Reference	Page
Techn. description	352
Selection table	353
Planning information	10 ff.
Modular system	350

Type	Ref. no.	Flow rate	Rated speed	Sound press. case radiation	Power consum.	Power consump. at rated voltage	Power consump. with control	Wiring diagram	Max air flow temp. at rated voltage	Wgt net aprx.	Transformer speed controller 5-step	Electronic ¹⁾ Speed controll., cont. var. flush-mount. / surf-mount.
		V m ³ /h	min ⁻¹	db(A) in 1m	W	A	A	No.	+ °C	kg	Type Ref. no.	Type Ref. no.
Type SB, Single-phase alternating current, 230 V, 50 Hz, Capacitor motor, IP44 (C), IP33 (E)												
SB 250 C	09512	960	2120	43	255	1.13	1.13	508	50	18.0	TSW 1.5 01495	ESU3/ESA 3 00237/00239
SB 250 E	09565	1080	2690	45	165	0.71	0.86	508	70	33.4	TSW 1.5 01495	ESU1/ESA 1 00236/00238

¹⁾ Transformer control units must be provided in noise-relevant cases. Electronic phase angle control can cause disturbing magnetisation humming.

* See ErP product data sheet at www.HeliosSelect.de.

Performance curves SB 250 C

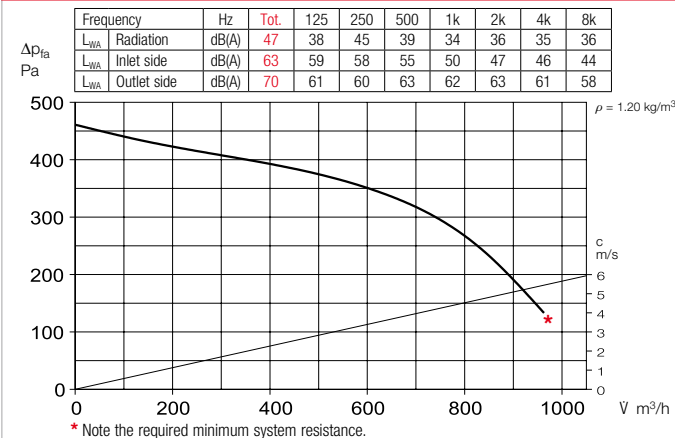

Performance curves SB 250 E

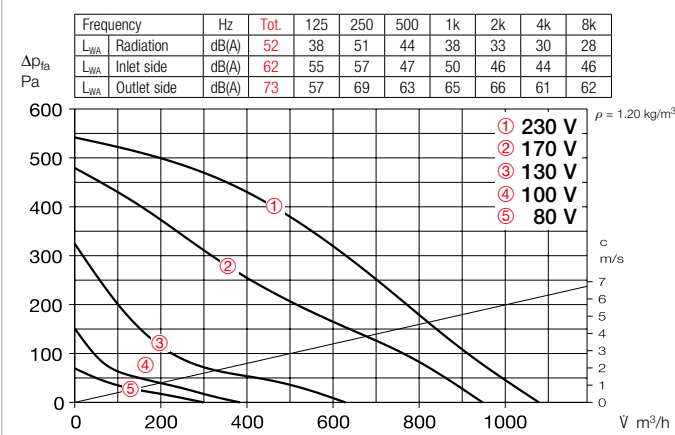

Noise

- The total level and range are specified above the performance diagram for
- Case-radiated sound power.
 - Inlet/outlet side sound power in dB(A).
 - The case-radiated noise as sound pressure at 1 m (free field conditions) are also specified in the type table.

Accessory details Page

Filters, heating elements and silencers	473 ff.
Temperature control systems for heating elements	479, 483 ff.
Flexible ventilation ducts, ventilation grilles, fittings, roof outlets	553 ff.
Disc valves	574 ff.
Universal control system, electronic controllers, speed potentiometer	605 ff.

Accessories

Flexible connecting sleeve

FM 250 Ref. no. 01672
Includes 2 hose clamps; for installation between fan and duct system. Prevents structure-borne noise transmission and bridges installation tolerances. 2 pcs required for inlet and outlet side application.

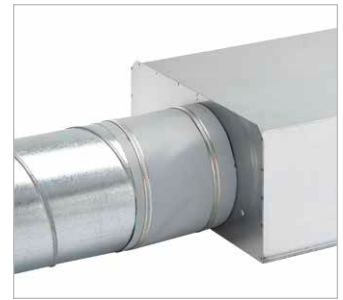

External wall shutter

VK 250 Ref. no. 00759
Automatic made of plastic, light grey.



External wall cover grille

RAG 250 Ref. no. 00751
For placement in front of air inlet and outlet openings in facades. Made of plastic, light grey.



Protection grille

SGR 250 Ref. no. 05067
For inlet and outlet side installation. Made of galvanised steel.



Duct shutter

RSK 250 Ref. no. 05673
Automatic, made of metal.



Flexible cross talk silencer

FSD 250 Ref. no. 00680
Made of aluminium pipe with double-sided plug-in connectors. Sound insulation lining 50 mm thick, installation length 1 m.



Air filter box

LFBR 250 Coarse 70%* 08580
LFBR 250 ePM1 50%* 08534
Air filter with large surface area, for installation in pipeline.

Electric heating element

EHR-R 6/250 6.0 kW No. 08712
– with integrated temp. control
EHR-R 6/250 TR 6.0 kW No. 05296
Room or duct sensor (TFK/TFR, Accessories) required.



Temperature control system for electric heating element EHR-R

EHS Ref. no. 05002



Warm water heating element

WHR 250 Ref. no. 09483
Compact heat exchanger for installation in duct system.



Temperature control system for warm water heating element WHS HE

Ref. no. 08319



* See product page 476 for detailed description.

SBD 315



Virtually silent with high volume output and pressure performance. Ideal for cleaning and inspection.

Dimensions SBD 315

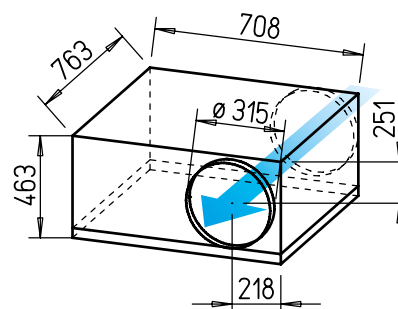

Dim. in mm

■ **Casing**

Designed as a silencer. Equipped with abrasion-resistant, sound-absorbing mineral fibre boards (50 mm). Removable cover with locking clamp. Freely accessible fan. Removable motor-impeller unit. Inlet and outlet side connectors with rubber lip seal corresponds to standard duct Ø. All parts made of galvanised steel sheet.

■ **Impeller**

With backward curved blades made of high-quality plastic. Dynamically balanced for low-noise operation. Inlet via nozzle.

■ **Motor**

Enclosed, ball bearing mounted external rotor motor with humidity protection, insulation class F, for continuous operation, maintenance-free and radio interference-free.

■ **Motor protection**

With external thermal contacts on the terminal block, which must be wired to the motor protection circuit breaker (see type table).

■ **Power control**

Possible through voltage reduction using 5-step transformer or electronic (continuously variable).

■ **Electrical connection**

Terminal box (IP54) mounted to external cable (ca. 60 cm long).

■ **Protection category**

IP54.

■ **Installation**

No restrictions in any position (horizontal, vertical, diagonal) through corresponding installation for supply or extract ventilation.

■ **Noise**

The total level and range are specified above the performance diagram for

- Case-radiated sound power
- Inlet/outlet side sound power in dB(A).
- The case-radiated noise as sound pressure at 1 m (free field conditions) are also specified in the type table.

Type	Ref. no.	Flow rate Free blowing V m³/h	Rated speed min ⁻¹	Sound press. case radiation db(A) in 1m	Power consum.	Power consum. at rated voltage A	Power consum. with control A	Wiring diagram No.	Max air flow temp.		Weight net approx. kg	Speed controller 5-step			
									at rated voltage + °C	with control + °C		without motor prot. circ. breaker Type	Ref. no.	with motor prot. circ. breaker Type	Ref. no.
Type SBD, Three-phase current motor, 230/400 V, 50 Hz, IP54															
SBD 315 A	09718	2200	1350	47	215	0.73/0.42	0.44	860	60	60	46.0	TSW 0.8¹⁾	01500	RDS 1	01314

¹⁾ Motor protection circuit breaker required, Type MD, No. 05849, see accessories.

Performance curves SBD 315 A

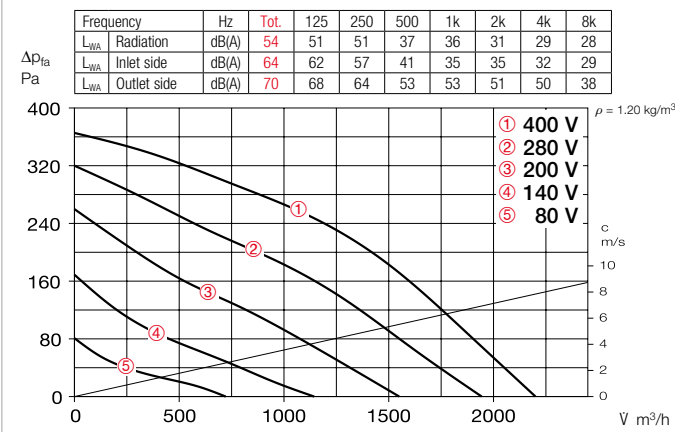

Accessory details Page

Filters, heating elements and silencers	473 ff.
Temperature control systems for heating elements	479, 483 ff.
Flexible ventilation ducts, ventilation grilles, fittings, roof outlets	553 ff.
Disc valves	574 ff.
Universal control system, electronic controllers, speed potentiometer	605 ff.

Accessories

Flexible connecting sleeve

FM 315 Ref. no. 01674
Includes 2 hose clamps; for installation between fan and duct system. Prevents structure-borne noise transmission and bridges installation tolerances.
2 pcs required for inlet and outlet side application.

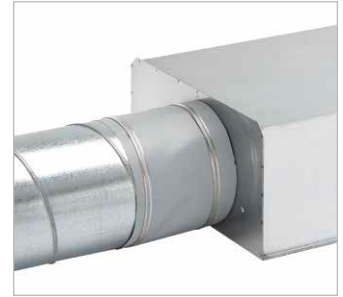

External wall shutter

VK 315 Ref. no. 00760
Automatic made of plastic, light grey.



External wall cover grille

RAG 315 Ref. no. 00752
For placement in front of air inlet and outlet openings in facades. Made of plastic, light grey.



Protection grille

SGR 315 Ref. no. 05068
For inlet and outlet side installation. Made of galvanised steel.



Duct shutter

RSK 315 Ref. no. 05674
Automatic, made of metal.



Flexible cross talk silencer

FSD 315 Ref. no. 00681
Made of aluminium pipe with double-sided plug-in connectors. Sound insulation lining 50 mm thick, installation length 1 m.



Air filter box

LFBR 315 Coarse 70%* 08581
LFBR 315 ePM1 50%* 08535
Air filter with large surface area, for installation in pipeline.

Electric heating element

EHR-R 6/315 6.0 kWNo. 08713
– with integrated temp. control
EHR-R 6/315 TR 6.0 kWNo. 05301
Room or duct sensor (TFK/TFR, Accessories) required.



Temperature control system for electric heating element

EHR-R
EHS Ref. no. 05002



Warm water heating element

WHR 315 Ref. no. 09484
Compact heat exchanger for installation in duct system.



Temperature control system for warm water heating element

WHS HE Ref. no. 08319



* See product page 476 for detailed description.

Helios rectangular duct fans. Perfect system solutions.

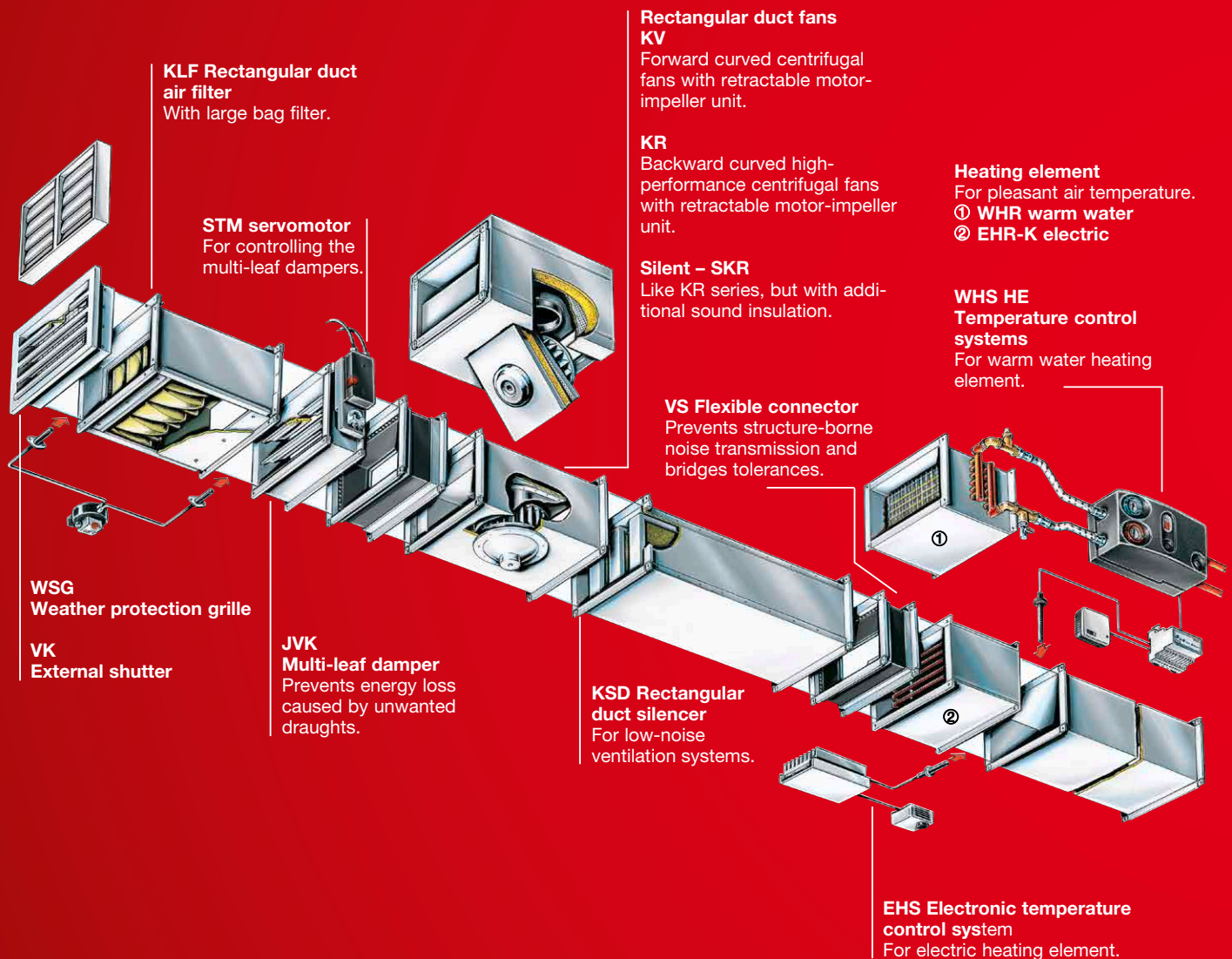

Helios rectangular duct fans are the ideal solution for the reliable supply and extract ventilation of industrial and commercial applications. The compact design promises minimal space requirement

and shows its advantages in combination with numerous accessory components, such as the warm water and electric heating elements, filters or silencers. This system diversity means

the right solution can always be found for your construction project.

■ Fresh air boxes

Efficient EC version.

With electric heating
 Ø 125 – 250 mm
 30 x 20 cm

With warm water heating
 40 x 20 cm, 50 x 30 cm,
 60 x 35 cm, 80 x 50 cm



332ff

■ Backward curved InlineVent rectangular duct fans KR

Energy-efficient EC version.

Ø 180 – 560 mm
 30 x 15 cm – 100 x 50 cm
 V = 660 – 14 410 m³/h



444ff

■ Backward curved InlineVent rectangular duct fans KR

Standard AC version.

Ø 180 – 560 mm
 30 x 15 cm – 80 x 50 cm
 V = 540 – 11 970 m³/h



460ff

■ Centrifugal rectangular duct fans

Product-specific information, Selection table.

428f

■ Forward curved InlineVent rectangular duct fans KV

Standard AC version.

Ø 200 – 400 mm
 40 x 20 cm – 80 x 50 cm
 V = 920 – 7620 m³/h



Also available in version:



430ff

■ Sound-insulated rectangular duct fans, backward curved, Acoustic Line SKR

Energy-efficient EC version.

Ø 315 – 560 mm
 50 x 25 cm – 100 x 50 cm
 V = 1180 – 13 700 m³/h



448ff

■ Sound-insulated rectangular duct fans, backward curved, Acoustic Line SKR

Standard AC version.

Ø 355 – 560 mm
 60 x 35 cm – 80 x 50 cm
 V = 2800 – 8050 m³/h



464ff

■ Accessories

For InlineVent rectangular duct fans.

472

This information supplements the “General technical information” and the information on the product pages.

■ **Installation position, installation, condensate outlets**

Installation possible in any position, but only with the inspection cover to the bottom or side for KR types. The swivelling range must be kept clear and access for inspection and cleaning must be unhindered.

In case of condensation (e.g. in case of intermittent operation, air flow with high moisture and varying temperatures), the unit must be installed so that condensate can drain downwards without restriction. Corresponding holes must be made in the fan casing, if necessary. If necessary, the pipeline or duct system must be insulated so that condensation is prevented.

■ **Structure-borne noise transmission**

to buildings and duct systems must be prevented. The fan must not be rigidly connected to the duct system. Accessory VS provided for this purpose.

■ **Explosion-proof types**

With regard to the operating conditions and standards, reference is made to the information in “Planning information Explosion protection”. The explosion-proof types correspond to unit group II, category 2G for operation in zones 1 and 2 in accordance with Directive 2014/34/EU (ATEX).

The KVD Ex motors are equipped with PTC thermistors (for direct winding temperature monitoring) as standard. Their connection leads must be led to the terminal board and connected to the motor protection trigger unit MSA.

With this equipment, the KVD explosion-proof fans are also approved for speed control. The transformer control units TSD or TSSD can be used for this purpose; a minimum voltage of 100 V must always be maintained. Electronic speed control or control using a frequency inverter is not permitted.

■ **Drive-Impeller**

External rotor motors located in the air flow in protection category IP44 and IP54 are used for all AC types.

They correspond to DIN EN 60034/VDE 0530 and DIN EN 60335-1/VDE 0700-1 and they are in ISO class F with additional humidity protection. The EC types are equipped with especially energy-saving, speed-

controllable EC external rotor motors in protection category IP44 or IP54 for the lowest operating costs.

All motors are maintenance-free and radio interference-free and they are suitable for continuous and normal operation.

The ball bearings have a sufficient lubricant supply for their service life.

The centrifugal impellers are pressed on the motor body, i.e. fixed to it, and dynamically balanced as a unit according to DIN ISO 21940-11 – quality grade 6.3.

■ **Power control**

All InlineVent AC rectangular duct fans can be controlled from 0 – 100% through voltage reduction. As a result, the output can be set to the desired volume. One or more fans (until the max. rated current is reached) can be operated with the offered speed controls. The dimensioning must be based on a 10% reserve. Control is possible for 3-types using a frequency inverter with integrated sine filter.

All EC types have continuously variable speed control via speed potentiometer. Control is also possible via three level switch or continuously variable via universal control system or electronic differential pressure/temperature controller.

The performance levels are shown on the performance curve as examples.

■ **Air flow direction**

The air flow direction cannot be changed for centrifugal fans; but it can be set by the corresponding positioning. The correct motor rotation direction and air flow direction is marked by arrows and must be checked during commissioning.

■ **Incorrect direction of rotation**

Operation in the incorrect direction of rotation overloads the AC motor and causes the thermal contacts to respond. Typical concomitant features include virtually non-existent flow rate, vibration and abnormal noise.

■ **Air flow temperature**

All units can be used in the range from –40 °C to at least +60 °C, Types KV Ex from –20 °C to +40 °C.

The upper limit value is type-specific and can be found in the table on the product page.

The types and their features

■ **KV**

Centrifugal rectangular duct fans with forward curved impeller blades. Retractable motor-impeller unit. Low-noise impeller in volute casing for high delivery pressures.

V = 920 – 7620 m³/h.
Compact, flat design for versatile use in extract air and intake air systems in commercial and industrial buildings.



■ **KR and KR EC**

With backward curved impeller blades, optionally with energy-saving EC drive technology. High-performance centrifugal impellers with high level of efficiency. Retractable motor-impeller unit.

V = 540 – 13 480 m³/h.
For the delivery of larger volume flows in extract air and intake air systems. Non-critical for the delivery of contaminated air.



■ **SKR and SKR EC**

For noise-critical systems. Backward curved high-performance centrifugal impellers in sound-insulated casing, optionally with energy-saving EC drive technology. Performance characteristics like KR.

V = 1270 – 13 480 m³/h.
The use of rectangular duct silencers (KLF, Accessories) is recommended for the further reduction of inlet and outlet side air noise. Application in extract and intake air systems with specific noise level requirements.



By combining the parameters of static pressure increase ΔP_{fa} , case-radiated noise and inlet side air noise as sound pressure at

4 m (free field conditions), the following table facilitates the selection of rectangular duct fans.

Type	Sound pre. radiation	Sound pre. inlet side	Flow rate V m ³ /h depending on static pressure												
	L _{PA} dB(A)	L _{PA} dB(A)	(ΔP _{fa}) in Pa												
	at 4 m dist.	at 4 m dist.	0	50	100	150	200	250	300	350	400	500	600	700	800
KV – with forward curved impellers															
KVW 200/4/40/20	37	49	920	890	850	800	750	40							
KVD 200/4/40/20	36	50	1130	1030	930	830	710								
KVD 225/4/50/25	43	52	1920	1820	1710	1590	1460	1290	1040						
KVD 355/6/70/40	42	53			4970	4680	4380	4060	3680	3190					
KVD 400/6/80/50	45	60	7620	7320	7020	6710	6390	6060	5690	5290	4800	1460			

Type	Sound pre. radiation	Sound pre. inlet side	Flow rate V m ³ /h depending on static pressure												
	L _{PA} dB(A)	L _{PA} dB(A)	(ΔP _{fa}) in Pa												
	at 4 m dist.	at 4 m dist.	0	50	100	150	200	250	300	350	400	500	600	700	800
KR EC – with backward curved impellers / SKR EC – with sound-insulated casing															
KRW EC 180/30/15	41	57	720	680	650	620	580	530	490	450	390	280	130		
KRW EC 225/40/20	41	52	1200	1120	1040	980	920	860	790	730	670	520	360		
KRW EC 315/50/25 A	35	49	1210	1130	1060	990	920	860	790	730	660	510	340		
KRW EC 315/50/25 B	44	57	2250	2130	2010	1910	1800	1680	1580	1470	1350	1140	920	730	510
KRW EC 355/60/30	46	59	2960	2860	2750	2620	2460	2300	2100	1910	1670	1090			
KRW EC 400/60/35	49	62	4100	4020	3930	3840	3750	3640	3540	3430	3310	3050	2770	2470	2120
KRW EC 450/70/40	48	61	5570	5360	5150	4940	4760	4570	4350	4100	3860	3280	2460		
KRD EC 355/60/30	56	66	4380	4310	4250	4190	4120	4040	3960	3880	3800	3630	3410	3200	2940
KRD EC 400/60/35	53	65	4580	4500	4420	4340	4250	4170	4080	3990	3890	3700	3500	3290	3060
KRD EC 450/70/40	54	64	7520	7390	7260	7120	6970	6800	6610	6380	6140	5600	5100	4600	4130
KRD EC 500/80/50 A	47	60	7990	7730	7450	7150	6850	6520	6160	5820	5460	4620	3680	840	
KRD EC 500/80/50 B	51	63	9080	8910	8720	8520	8290	8020	7710	7380	7040	6300	5530	4780	3930
KRD EC 560/100/50 A	50	60	9370	9210	9040	8870	8690	8480	8210	7890	7580	6900	6070	5350	4440
KRD EC 560/100/50 B	56	63	13480	13220	12970	12720	12460	12210	11960	11710	11460	10880	10290	9660	8910
SKRW EC 315/50/25 A	29	40	1270	1170	1090	990	900	830	760	670	580	380	70		
SKRW EC 315/50/25 B	36	47	2170	2050	1960	1870	1760	1640	1530	1400	1250	980	760	570	400
SKRW EC 355/60/30	43	53	3860	3760	3660	3550	3450	3360	3270	3160	3050	2840	2580	2270	1830
SKRW EC 400/60/35	42	56	3960	3880	3790	3700	3610	3510	3400	3290	3180	2920	2610	2260	1740
SKRW EC 450/70/40	46	56	5390	5190	4990	4780	4540	4300	4070	3830	3580	2980	2130		
SKRD EC 355/60/30	46	55	4340	4260	4180	4090	4010	3920	3830	3740	3650	3450	3240	3020	2770
SKRD EC 400/60/35	46	57	4580	4500	4420	4340	4250	4170	4080	3990	3890	3700	3500	3290	3060
SKRD EC 450/70/40 A	49	59	7460	7320	7190	7040	6870	6670	6460	6230	5990	5500	5020	4570	4080
SKRD EC 500/80/50 A	45	53	7990	7730	7450	7150	6850	6520	6160	5820	5460	4620	3680	840	
SKRD EC 500/80/50 B	48	55	8760	8570	8380	8170	7940	7670	7380	7090	6790	6130	5350	4530	3390
SKRD EC 560/100/50 A	47	51	9370	9210	9040	8870	8690	8480	8210	7890	7580	6900	6070	5350	4440
SKRD EC 560/100/50 B	52	58	13480	13220	12970	12720	12460	12210	11960	11710	11460	10880	10290	9660	8910

Type	Sound pre. radiation	Sound pre. inlet side	Flow rate V m ³ /h depending on static pressure												
	L _{PA} dB(A)	L _{PA} dB(A)	(ΔP _{fa}) in Pa												
	at 4 m dist.	at 4 m dist.	0	50	100	150	200	250	300	350	400	500	600	700	800
KR – with backward curved impellers / SKR – with sound-insulated casing															
KRW 180/2/30/15	37	51	540	480	420	360	280	210	110						
KRW 225/2/40/20	40	52	1020	920	820	700	590	490	380	260	100				
KRW 225/2/50/25	45	52	1160	1100	1040	990	910	850	780	690	610	340	60		
KRW 355/4/60/35	42	55	3600	3370	3130	2900	2590	2090	1330	570					
KRW 400/4/70/40	44	54	4970	4710	4400	4110	3730	3320	2750	2090	1160				
KRW 450/4/70/40	51	59	6650	6360	6010	5710	5430	5120	4730	4280	3850	2290			
KRW 500/4/80/50	52	62	9700	9380	9040	8670	8310	7920	7460	6890	6260	4590	2290		
KRD 355/4/60/35	37	50	2840	2640	2410	2110	1860	1510	1050	450					
KRD 450/4/70/40	47	57	5830	5570	5320	5060	4810	4550	4230	3930	3610	2840	1840		
KRD 500/4/80/50 A	52	58	8430	8120	7810	7490	7110	6670	6300	5870	5420	4530	3560	1330	
KRD 560/6/80/50	41	53	7460	6940	6300	5630	5110	4290	3490	2410	400				
KRD 560/4/80/50	55	66	11970	11630	11260	10870	10480	10080	9640	9140	8620	7230	5470	2920	840
SKRW 355/4/60/35	39	49	3580	3350	3070	2830	2450	1880	110						
SKRW 400/4/70/40	42	49	4940	4540	4230	3830	3470	3040	2460	1670	780				
SKRD 355/4/60/35	34	43	2800	2510	2270	2030	1670	1300	650	140					
SKRD 450/4/70/40	46	52	5430	5230	5000	4770	4520	4240	4000	3640	3290	2380	860		
SKRD 500/6/70/40	36	48	4620	4230	3800	3480	2980	2490	1490						
SKRD 500/4/80/50	48	54	8050	7830	7520	7060	6650	6210	5820	5450	5040	4150	2560	690	
SKRD 560/6/80/50	36	46	7600	6990	6220	5630	5040	4280	3220	1810	400				

Rectangular duct fans

KV 200



Efficiency class

D

KWV 200/4/40/20 + accessories*

Dimensions KV 200

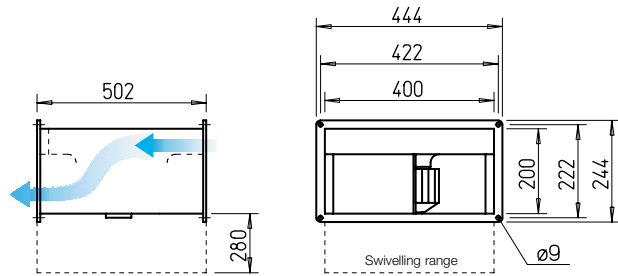

Dim. in mm

Centrifugal rectangular duct fans with forward curved impeller blades. Retractable motor-impeller unit.

- Low-noise impeller in optimised volute casing for high delivery pressures.
- Compact, flat design for versatile use in extract air and intake air systems in commercial and industrial buildings.

Description

■ Casing

Double-sided standardised rectangular duct flange profiles, made of galvanised steel sheet, space-saving design.

- Particularly easy to service (cleaning) due to retractable motor-impeller unit.

■ Impeller

Forward curved impeller made of galvanised steel, good level of efficiency, low noise, aerodynamically optimised volute casing; inlet via nozzle.

■ Drive

Through maintenance-free external rotor motor on which the impeller is mounted. Closed design, IP44. Winding with moisture proof coating. Ball bearing mounted, radio interference-free. Dynamic balancing and flexible motor mount for low-vibration and low-noise operation.

■ Electrical connection

Terminal box (IP55 for 3~ or 44 for 1~ types) mounted to external cable.

■ Motor protection

Type KWV through thermal contacts connected in series with the winding, automatically resets. Type KVD through built-in thermal contacts which must be connected to a motor protection circuit breaker.

■ Power control

Possible through voltage reduction by means of 5-step transformer or electronic (continuously variable) controller. The performances at corresponding voltages are shown in the performance diagram.

■ Noise

The total level and range are specified above the performance diagram for:

- Case-radiated sound power
- Inlet side sound power
- Outlet side sound power

The inlet side sound power level is also specified above the control voltages in the performance diagram.

- The case-radiated noise as sound pressure at 4 m (free field conditions) is also specified in the type table.

■ Installation

Installation possible in any position. Note accessibility/swivelling range.

■ Reference

Page

Selection table	429
Techn. description	428
Planning information	10 ff.
Modular system	426

Type	Ref. no.	Flow rate max.	Rated speed	Sound press. case-radiation	Power consumption		Wiring diagram	Max. air flow temperature at		Wgt net aprx.	Speed controller 5-step				Motor protection circuit breaker for connection of built-in thermal contacts	
					Rat. vol.	Control		without motor prot. circ. brea.	with motor prot. circ. brea.		Type	Ref. no.	Type	Ref. no.	Type	Ref. no.
Alternating current, 230 V, 50 Hz, Capacitor motor, protection category IP4																
KWV 200/4/40/20	05675	925	810	37	0.21	0.95	0508	40	40	11	TSW 1.5	01495	—	—	—	—
Three-phase current motor, 230/400 V, 50 Hz, protection category IP4																
KVD 200/4/40/20	05676	1130	1260	36	0.25	0.82/0.47	0860	70	70	8.6	TSD 0.8	01347	RDS 1	01314	MD	05849

* See ErP product data sheet at www.HeliosSelect.de.

Performance curves KVV 200/4/40/20

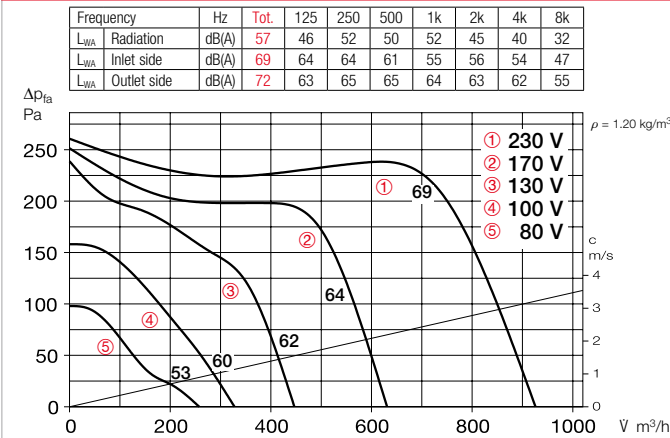

Performance curves KVD 200/4/40/20

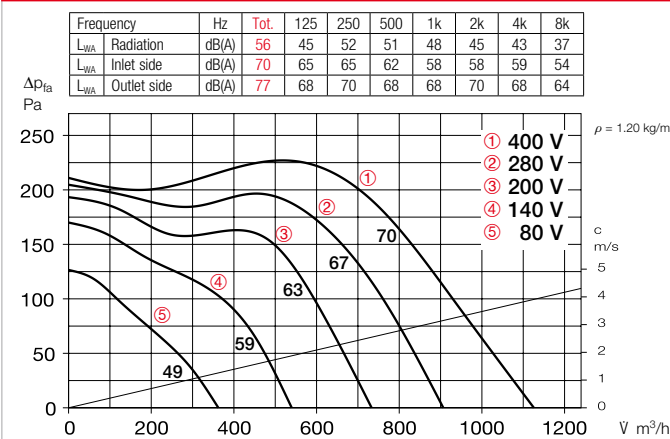

Accessory details Page

Shutters and weather prot. grille	472, 553 ff.
Filters, heating elements and silencers	473 ff.
Temperature control systems for heating elements	479, 484 f.
Speed controllers and motor protection circuit breakers	591 ff.

Accessories

External wall shutter
VK 40/20 Ref. no. 00874
 Automatic overpressure shutter made of light grey plastic.



Weather protection grille
WSG 40/20 Ref. no. 00109
 Stable construction made of extruded aluminium profiles, natural colour anodised.



Multi-leaf damper for rectangular duct installation
JVK 40/20 Ref. no. 06910
 Frame casing with double-sided flanges, positioning mechanism outside of air flow. Electrical drive see STM, Accessories.



Fitting
FSK 40/20 Ref. no. 00832
 For cost-effective integration of rectangular duct fans in round duct systems with Ø 200 mm.



Flexible connector
VS 40/20 Ref. no. 05694
 Flexible rectangular duct connector with double-sided flange frame.



Counter flange
GF 40/20 Ref. no. 06919
 Flange frame made of galvanised steel sheet for connection to the rectangular duct.



Rectangular duct silencer
KSD 40/20 Ref. no. 08728
 For outlet and inlet side insertion in the rectangular duct system.



Rectangular duct air filter
KLF 40/20 Coarse 70%* 08720
KLF 40/20 ePM1 50%* 08644
 With large bag filter. Galvanised steel sheet casing with double-sided flanges.



Electric heating element
EHR-K 6/40/20 No. 08702
EHR-K 15/40/20 No. 08703
 Closed tubular heating element in galvanised steel sheet casing with double-sided connection flanges.



Temperature control system for electric heating element
EHSD 16 Ref. no. 05003



Warm water heating element
WHR 2/40/20 No. 08782
WHR 4/40/20 No. 08783
 For installation in rectangular duct system.



Temperature control system for warm water heating element
WHS HE Ref. no. 08319



* See product page 477 for detailed description.

KV 225



Also available in version:

Dimensions KV 225

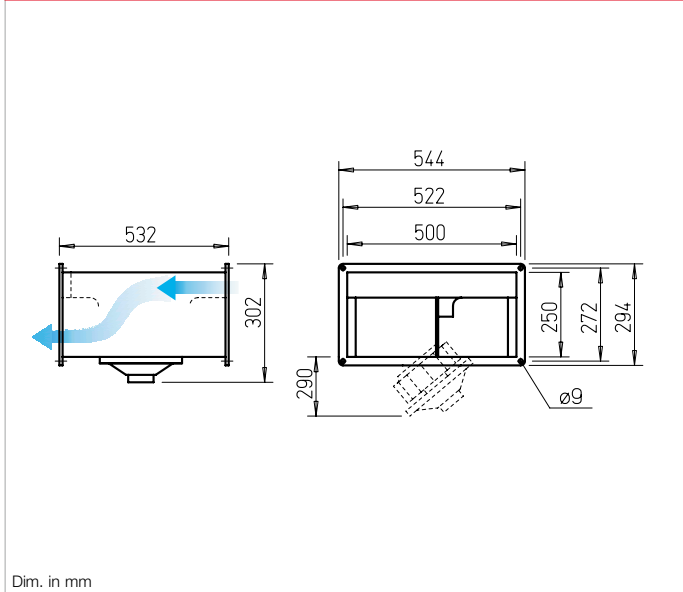

Dim. in mm

Centrifugal rectangular duct fans with forward curved impeller blades. Retractable motor-impeller unit.

- Low-noise impeller in optimised volute casing for high delivery pressures.
- Compact, flat design for versatile use in extract air and intake air systems in commercial and industrial buildings.

Description

- **Casing**
Double-sided standardised rectangular duct flange profiles, made of galvanised steel sheet, space-saving design.
- Particularly easy to service (cleaning) due to retractable motor-impeller unit.
- **Impeller**
Forward curved impeller made of galvanised steel, good level of efficiency, low noise, aerodynamically optimised volute casing; inlet via nozzle.

- **Drive**
Through maintenance-free external rotor motor on which the impeller is mounted. Closed design, IP44. Winding with moisture proof coating. Ball bearing mounted, radio interference-free. Dynamic balancing and flexible motor mount for low-vibration and low-noise operation.
- **Electrical connection**
Terminal box (IP55 for 3~ or 44 for 1~ types) mounted to external cable.
- **Motor protection**
Through built-in thermal contacts which must be connected to a motor protection circuit breaker.
- **Power control**
Possible through voltage reduction by means of 5-step transformer or electronic (continuously variable) controller. The performances at corresponding voltages are shown in the performance diagram.

- **Noise**
The total level and range are specified above the performance diagram for:
 - Case-radiated sound power
 - Inlet side sound power
 - Outlet side sound power
 The inlet side sound power level is also specified above the control voltages in the performance diagram.
 - The case-radiated noise as sound pressure at 4 m (free field conditions) is also specified in the type table.
- **Installation**
Installation possible in any position. Note accessibility/swivelling range.
- **Explosion-proof design**
Thermal motor protection through integrated PTC thermistors which must be connected to a tripping unit MSA. Also approved for speed control, whereby the minimum voltage of 100 V must be respected.

Reference	Page
Selection table	429
Techn. description	428
Planning information	10 ff.
Modular system	426

Type	Ref. no.	Flow rate max.	Rated speed	Sound press. case-radiation	Power consumption	Wiring diagram	Max. air flow temperature at		Wgt net aprx.	Speed controller 5-step				Motor protection circuit breaker for connection of built-in thermal contacts		
		V m³/h	min⁻¹	dB(A) in 4 m	kW	A	No.	Rat. vol.		Control	kg	without motor prot. circ. brea.	with motor prot. circ. brea.	Type	Ref. no.	Type
Three-phase current motor, 230/400 V, 50 Hz, protection category IP44																
KVD 225/4/50/25	05679	1950	1270	43	0.54	1.6/0.93	0860	45	45	17	TSD 1.5	01501	RDS 2	01315	MD	05849
Ex Ex Explosion-proof, II 2G Ex h IIB T3 Gb, Motor Ex e, three-phase current 400 V, 50 Hz, protection category IP44																
KVD 225/4/50/25 Ex	06810	1900	1280	43	0.53	0.92	0899	40	40	17	TSD 1.5	01501	—	—	MSA	01289

Performance curves KVD 225/4/50/25

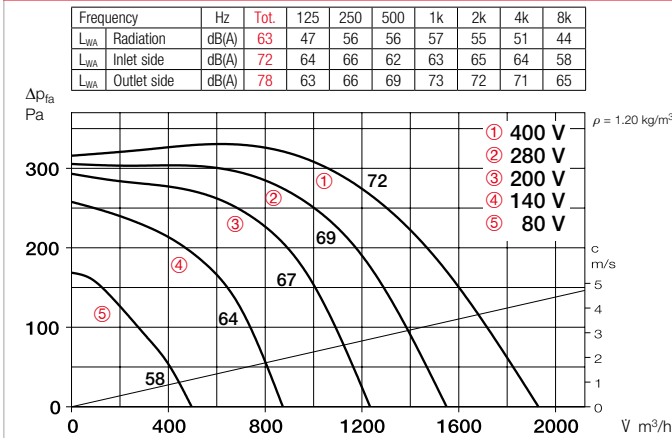

Performance curves KVD 225/4/50/25 Ex

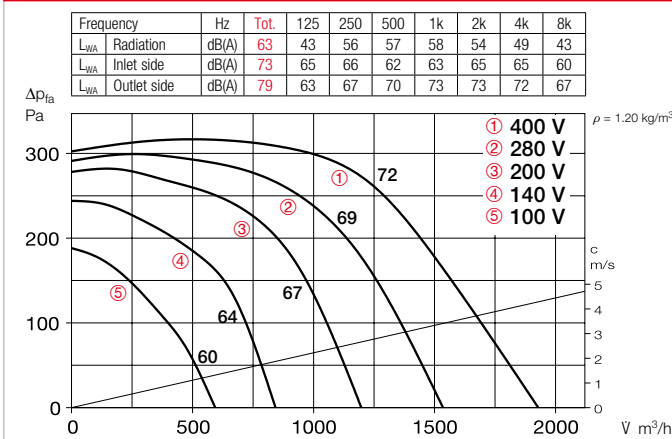

Accessory details Page

Shutters and weather prot. grille	472, 553 ff.
Filters, heating elements and silencers	473 ff.
Temperature control systems for heating elements	479, 484 f.
Speed controllers and motor protection circuit breakers	591 ff.

Accessories

External wall shutter

VK 50/25 Ref. no. 00875
 Automatic overpressure shutter made of light grey plastic.



Weather protection grille

WSG 50/25 Ref. no. 00110
 Stable construction made of extruded aluminium profiles, natural colour anodised.



Multi-leaf damper for rectangular duct installation

JVK 50/25 Ref. no. 06911
 Frame casing with double-sided flanges, positioning mechanism outside of air flow. Electrical drive see STM, Accessories.



Fitting

FSK 50/25 Ref. no. 00833
 For cost-effective integration of rectangular duct fans in round duct systems with Ø 250 mm.



Flexible connector

VS 50/25 Ref. no. 05695
 Flexible rectangular duct connector with double-sided flange frame.
– for explosion-proof fans
VS 50/25 Ex No. 00265



Counter flange

GF 50/25 Ref. no. 06920
 Flange frame made of galvanised steel sheet for connection to the rectangular duct.



Rectangular duct silencer

KSD 50/25-30 No. 08729
 For outlet and inlet side insertion in the rectangular duct system.



Rectangular duct air filter

KLF 50/25-30 Coarse 70%* 08721
KLF 50/25-30 ePM1 50%* 08645
 With large bag filter. Galvanised steel sheet casing with double-sided flanges.



Electric heating element¹⁾

EHR-K 8/50/25-30 No. 08704
EHR-K 24/50/25-30 No. 08705
 Closed tubular heating element in galvanised steel sheet casing with double-sided connection flanges.



Temperature control system for electric heating element¹⁾

EHSD 16 Ref. no. 05003



Warm water heating element

WHR 2/50/25-30 No. 08784
WHR 4/50/25-30 No. 08785
 For installation in rectangular duct system.



Temperature control system for warm water heating element

WHS HE Ref. no. 08319



* See product page 477 for detailed description.
¹⁾ Cannot be used for explosion-proof version.

KV 250



Dimensions KV 250

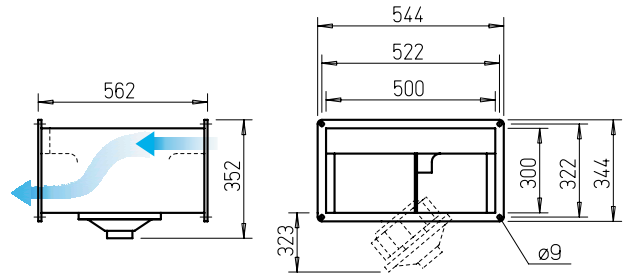

Dim. in mm

Centrifugal rectangular duct fans with forward curved impeller blades. Retractable motor-impeller unit.

- Low-noise impeller in optimised volute casing for high delivery pressures.
- Compact, flat design for versatile use in extract air and intake air systems in commercial and industrial buildings.

Description

- **Casing**
Double-sided standardised rectangular duct flange profiles, made of galvanised steel sheet, space-saving design.
- Particularly easy to service (cleaning) due to retractable motor-impeller unit.
- **Impeller**
Forward curved impeller made of galvanised steel, good level of efficiency, low noise, aerodynamically optimised volute casing; inlet via nozzle.

■ **Drive**

Through maintenance-free external rotor motor on which the impeller is mounted. Closed design, IP44. Winding with moisture proof coating. Ball bearing mounted, radio interference-free. Dynamic balancing and flexible motor mount for low-vibration and low-noise operation.

■ **Electrical connection**

Terminal box (IP65) mounted to external cable.

■ **Motor protection**

Through built-in thermal contacts which must be connected to a motor protection circuit breaker.

■ **Power control**

Possible through voltage reduction by means of 5-step transformer or electronic (continuously variable) controller. The performances at corresponding voltages are shown in the performance diagram.

■ **Noise**

The total level and range are specified above the performance diagram for:

- Case-radiated sound power
- Inlet side sound power
- Outlet side sound power

The inlet side sound power level is also specified above the control voltages in the performance diagram.

- The case-radiated noise as sound pressure at 4 m (free field conditions) is also specified in the type table.

■ **Installation**

Installation possible in any position. Note accessibility/swivelling range.

■ **Explosion-proof design**

Thermal motor protection through integrated PTC thermistors which must be connected to a tripping unit MSA. Also approved for speed control, whereby the minimum voltage of 100 V must be respected.

Reference	Page
Selection table	429
Techn. description	428
Planning information	10 ff.
Modular system	426

Type	Ref. no.	Flow rate max.	Rated speed	Sound press. case-radiation	Power consumption		Wiring diagram	Max. air flow temperature at		Wgt net aprx. kg	Speed controller 5-step without motor prot. circ. brea.		Speed controller 5-step with motor prot. circ. brea.		Motor protection circuit breaker for connection of built-in thermal contacts	
		V m³/h	min ⁻¹	dB(A) in 4 m	kW	A	No.	Rat. vol. + °C	Control + °C		Type	Ref. no.	Type	Ref. no.	Type	Ref. no.
Explosion-proof, II 2G Ex h IIB T3 Gb, Motor Ex e, three-phase current 400 V, 50 Hz, protection category IP44																
KVD 250/4/50/30 Ex	06811	2300	1240	42	0.74	1.5	0899	40	40	21	TSD 1.5	01501	—	—	MSA	01289

Performance curves KVD 250/4/50/30 Ex

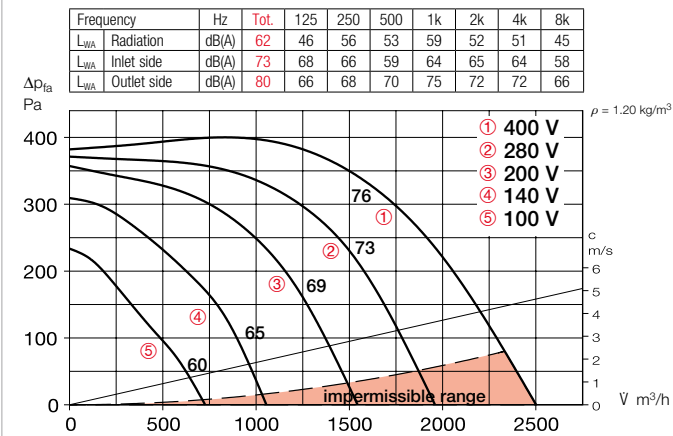

Accessory details Page

Shutters and weather prot. grille	472, 553 ff.
Filters, heating elements and silencers	473 ff.
Temperature control systems for heating elements	479, 484 f.
Speed controllers and motor protection circuit breakers	591 ff.

Accessories

External wall shutter

VK 50/30 Ref. no. 00876
 Automatic overpressure shutter made of light grey plastic.



Weather protection grille

WSG 50/30 Ref. no. 00111
 Stable construction made of extruded aluminium profiles, natural colour anodised.



Multi-leaf damper for rectangular duct installation

JVK 50/30 Ref. no. 06912
 Frame casing with double-sided flanges, positioning mechanism outside of air flow. Electrical drive see STM, Accessories.



Fitting

FSK 50/30 Ref. no. 00837
 For cost-effective integration of rectangular duct fans in round duct systems with Ø 315 mm.



Flexible connector

VS 50/30 Ex Ref. no. 00266
 Flexible rectangular duct connector with double-sided flange frame.



Counter flange

GF 50/30 Ref. no. 06921
 Flange frame made of galvanised steel sheet for connection to the rectangular duct.



Rectangular duct silencer

KSD 50/25-30 No. 08729
 For outlet and inlet side insertion in the rectangular duct system.



Rectangular duct air filter

KLF 50/25-30 Coarse 70%* 08721
KLF 50/25-30 ePM1 50%* 08645
 With large bag filter. Galvanised steel sheet casing with double-sided flanges.



Warm water heating element

WHR 2/50/25-30 No. 08784
WHR 4/50/25-30 No. 08785
 For installation in rectangular duct system.



Temperature control system for warm water heating element

WHS HE Ref. no. 08319



* See product page 477 for detailed description.

KV 280



Dimensions KV 280

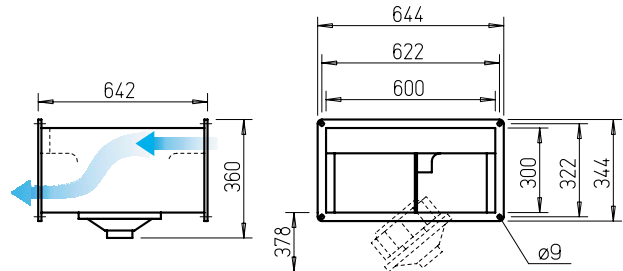

Dim. in mm

Centrifugal rectangular duct fans with forward curved impeller blades. Retractable motor-impeller unit.

- Low-noise impeller in optimised volute casing for high delivery pressures.
- Compact, flat design for versatile use in extract air and intake air systems in commercial and industrial buildings.

Description

- **Casing**
Double-sided standardised rectangular duct flange profiles, made of galvanised steel sheet, space-saving design.
- Particularly easy to service (cleaning) due to retractable motor-impeller unit.
- **Impeller**
Forward curved impeller made of galvanised steel, good level of efficiency, low noise, aerodynamically optimised volute casing; inlet via nozzle.

■ **Drive**

Through maintenance-free external rotor motor on which the impeller is mounted. Closed design, IP44. Winding with moisture proof coating. Ball bearing mounted, radio interference-free. Dynamic balancing and flexible motor mount for low-vibration and low-noise operation.

■ **Electrical connection**

Terminal box (IP65) mounted to external cable.

■ **Motor protection**

Through built-in thermal contacts which must be connected to a motor protection circuit breaker.

■ **Power control**

Possible through voltage reduction by means of 5-step transformer or electronic (continuously variable) controller. The performances at corresponding voltages are shown in the performance diagram.

■ **Noise**

The total level and range are specified above the performance diagram for:

- Case-radiated sound power
- Inlet side sound power
- Outlet side sound power

The inlet side sound power level is also specified above the control voltages in the performance diagram.

- The case-radiated noise as sound pressure at 4 m (free field conditions) is also specified in the type table.

■ **Installation**

Installation possible in any position. Note accessibility/swivelling range.

■ **Explosion-proof design**

Thermal motor protection through integrated PTC thermistors which must be connected to a tripping unit MSA. Also approved for speed control, whereby the minimum voltage of 100 V must be respected.

Reference	Page
Selection table	429
Techn. description	428
Planning information	10 ff.
Modular system	426

Type	Ref. no.	Flow rate max.	Rated speed	Sound press. case-radiation	Power consumption		Wiring diagram	Max. air flow temperature at		Wgt net aprx.	Speed controller 5-step without motor prot. circ. brea.		Speed controller 5-step with motor prot. circ. brea.		Motor protection circuit breaker for connection of built-in thermal contacts	
		V m³/h	min ⁻¹	dB(A) in 4 m	kW	A	No.	Rat. vol. + °C	Control + °C	kg	Type	Ref. no.	Type	Ref. no.	Type	Ref. no.
Explosion-proof, II 2G Ex h IIB T3 Gb, Motor Ex e, three-phase current 230/400 V, 50 Hz, protection category IP44																
KVD 280/4/60/30 Ex	06812	3450	1340	47	1.45	2.9	0899	40	40	34	TSD 5.5	01503	—	—	MSA	01289

Performance curves KVD 280/4/60/30 Ex

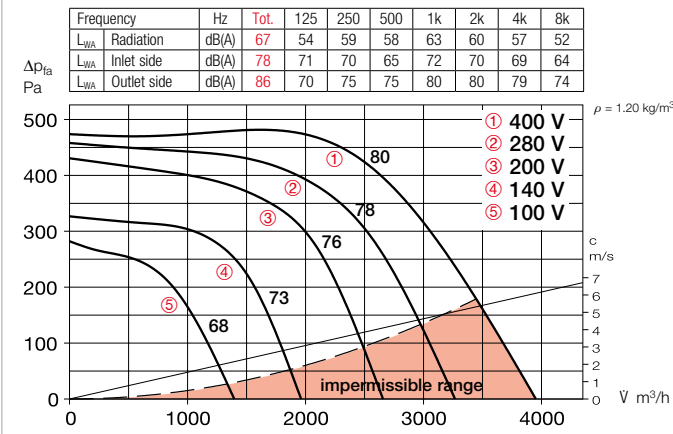

Accessory details Page

Shutters and weather prot. grille	472, 553 ff.
Filters, heating elements and silencers	473 ff.
Temperature control systems for heating elements	479, 484 f.
Speed controllers and motor protection circuit breakers	591 ff.

Accessories

External wall shutter

VK 60/30 Ref. no. 00877

Automatic overpressure shutter made of light grey plastic.



Weather protection grille

WSG 60/30 No. 00112

Stable construction made of extruded aluminium profiles, natural colour anodised.



Multi-leaf damper for rectangular duct installation

JVK 60/30 Ref. no. 06913

Frame casing with double-sided flanges, positioning mechanism outside of air flow. Electrical drive see STM, Accessories.



Fitting

FSK 60/30 Ref. no. 00834

For cost-effective integration of rectangular duct fans in round duct systems with Ø 315 mm.



Flexible connector

VS 60/30 Ex No. 00267

Flexible rectangular duct connector with double-sided flange frame.



Counter flange

GF 60/30 Ref. no. 06922

Flange frame made of galvanised steel sheet for connection to the rectangular duct.



Rectangular duct silencer

KSD 60/30-35 No. 08730

For outlet and inlet side insertion in the rectangular duct system.



Rectangular duct air filter

KLF 60/30-35 Coarse 70%* 08722

KLF 60/30-35 ePM2.5 65%* 08646

With large bag filter. Galvanised steel sheet casing with double-sided flanges.



Warm water heating element

WHR 2/60/30-35 No. 08786

WHR 4/60/30-35 No. 08787

For installation in rectangular duct system.



Temperature control system

for warm water heating element

WHS HE¹⁾ Ref. no. 08319

¹⁾ With heat output reduced to 2200 l/h for Type WHR 4/60/30-35.



* See product page 477 for detailed description.

KV 315



Dimensions KV 315

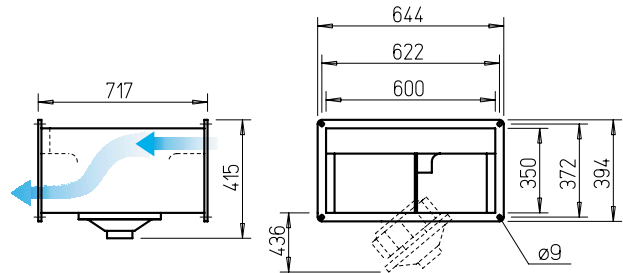

Dim. in mm

Centrifugal rectangular duct fans with forward curved impeller blades. Retractable motor-impeller unit.

- Low-noise impeller in optimised volute casing for high delivery pressures.
- Compact, flat design for versatile use in extract air and intake air systems in commercial and industrial buildings.

Description

- **Casing**
Double-sided standardised rectangular duct flange profiles, made of galvanised steel sheet, space-saving design.
- Particularly easy to service (cleaning) due to retractable motor-impeller unit.
- **Impeller**
Forward curved impeller made of galvanised steel, good level of efficiency, low noise, aerodynamically optimised volute casing; inlet via nozzle.

■ **Drive**

Through maintenance-free external rotor motor on which the impeller is mounted. Closed design, IP44. Winding with moisture proof coating. Ball bearing mounted, radio interference-free. Dynamic balancing and flexible motor mount for low-vibration and low-noise operation.

■ **Electrical connection**

Terminal box (IP65) mounted to external cable.

■ **Motor protection**

Through built-in thermal contacts which must be connected to a motor protection circuit breaker.

■ **Power control**

Possible through voltage reduction by means of 5-step transformer or electronic (continuously variable) controller. The performances at corresponding voltages are shown in the performance diagram.

■ **Noise**

The total level and range are specified above the performance diagram for:

- Case-radiated sound power
- Inlet side sound power
- Outlet side sound power

The inlet side sound power level is also specified above the control voltages in the performance diagram.

- The case-radiated noise as sound pressure at 4 m (free field conditions) is also specified in the type table.

■ **Installation**

Installation possible in any position. Note accessibility/swivelling range.

■ **Explosion-proof design**

Thermal motor protection through integrated PTC thermistors which must be connected to a tripping unit MSA. Also approved for speed control, whereby the minimum voltage of 100 V must be respected.

■ **Reference**

Page

Selection table	429
Techn. description	428
Planning information	10 ff.
Modular system	426

Type	Ref. no.	Flow rate max.	Rated speed	Sound press. case-radiation	Power consumption		Wiring diagram	Max. air flow temperature at		Wgt net aprx.	Speed controller 5-step				Motor protection circuit breaker for connection of built-in thermal contacts	
		⋅ m³/h	min ⁻¹	dB(A) in 4 m	kW	A	No.	Rat. vol. + °C	Control + °C		kg	Type	Ref. no.	Type	Ref. no.	Type
Explosion-proof, II 2G Ex h IIB T3 Gb, Motor Ex e, three-phase current 230/400 V, 50 Hz, protection category IP44																
KVD 315/4/60/35 Ex	06813	4200	1370	48	2.0	4.0	0899	40	40	42	TSD 5.5	01503	—	—	MSA	01289

Performance curves KVD 315/4/60/35 Ex

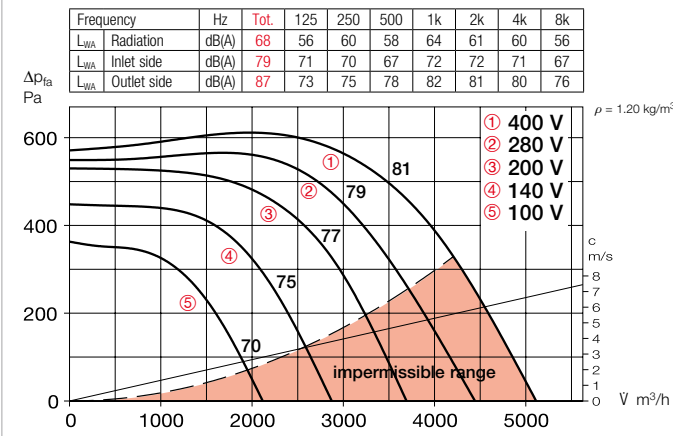

Accessory details Page

Shutters and weather prot. grille	472, 553 ff.
Filters, heating elements and silencers	473 ff.
Temperature control systems for heating elements	479, 484 f.
Speed controllers and motor protection circuit breakers	591 ff.

Accessories

External wall shutter

VK 60/35 Ref. no. 00878
 Automatic overpressure shutter made of light grey plastic.



Weather protection grille

WSG 60/35 No. 00113
 Stable construction made of extruded aluminium profiles, natural colour anodised.



Multi-leaf damper for rectangular duct installation

JVK 60/35 Ref. no. 06914
 Frame casing with double-sided flanges, positioning mechanism outside of air flow. Electrical drive see STM, Accessories.



Fitting

FSK 60/35 Ref. no. 00835
 For cost-effective integration of rectangular duct fans in round duct systems with Ø 355 mm.



Flexible connector

VS 60/35 Ex No. 00268
 Flexible rectangular duct connector with double-sided flange frame.



Counter flange

GF 60/35 Ref. no. 06923
 Flange frame made of galvanised steel sheet for connection to the rectangular duct.



Rectangular duct silencer

KSD 60/30-35 No. 08730
 For outlet and inlet side insertion in the rectangular duct system.



Rectangular duct air filter

KLF 60/30-35 Coarse 70%* 08722
KLF 60/30-35 ePM2.5 65%* 08646
 With large bag filter. Galvanised steel sheet casing with double-sided flanges.



Warm water heating element

WHR 2/60/30-35 No. 08786
WHR 4/60/30-35 No. 08787
 For installation in rectangular duct system.



Temperature control system for warm water heating element

WHS HE¹⁾ Ref. no. 08319

¹⁾ With heat output reduced to 2200 l/h for Type WHR 4/60/30-35.



* See product page 477 for detailed description.

KV 355



Also available in version:



Dimensions KV 355

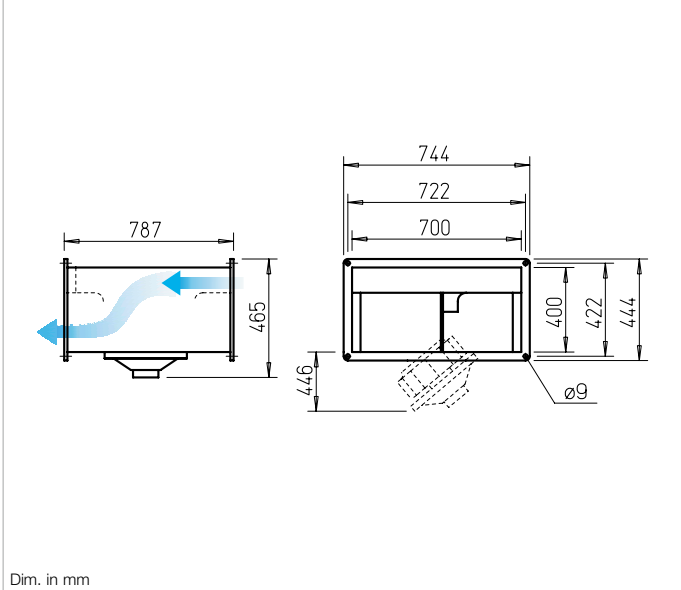

Dim. in mm

Centrifugal rectangular duct fans with forward curved impeller blades. Retractable motor-impeller unit.

- Low-noise impeller in optimised volute casing for high delivery pressures.
- Compact, flat design for versatile use in extract air and intake air systems in commercial and industrial buildings.

Description

- **Casing**
Double-sided standardised rectangular duct flange profiles, made of galvanised steel sheet, space-saving design.
- Particularly easy to service (cleaning) due to retractable motor-impeller unit.
- **Impeller**
Forward curved impeller made of galvanised steel, good level of efficiency, low noise, aerodynamically optimised volute casing; inlet via nozzle.

- **Drive**
Through maintenance-free external rotor motor on which the impeller is mounted. Closed design, IP44. Winding with moisture proof coating. Ball bearing mounted, radio interference-free. Dynamic balancing and flexible motor mount for low-vibration and low-noise operation.

- **Electrical connection**
Terminal box (IP55 for 3~ or IP65 for explosion-proof types) mounted to external cable.

- **Motor protection**
Through built-in thermal contacts which must be connected to a motor protection circuit breaker.

- **Power control**
Possible through voltage reduction by means of 5-step transformer or electronic (continuously variable) controller. The performances at corresponding voltages are shown in the performance diagram.

- **Noise**
The total level and range are specified above the performance diagram for:

- Case-radiated sound power
 - Inlet side sound power
 - Outlet side sound power
- The inlet side sound power level is also specified above the control voltages in the performance diagram.
- The case-radiated noise as sound pressure at 4 m (free field conditions) is also specified in the type table.

- **Installation**
Installation possible in any position. Note accessibility/swivelling range.

- **Explosion-proof design**
Thermal motor protection through integrated PTC thermistors which must be connected to a tripping unit MSA. Also approved for speed control, whereby the minimum voltage of 100 V must be respected.

Reference	Page
Selection table	429
Techn. description	428
Planning information	10 ff.
Modular system	426

Type	Ref. no.	Flow rate max.	Rated speed	Sound press. case-radiation	Power consumption		Wiring diagram	Max. air flow temperature at		Wgt net aprx.	Speed controller 5-step				Motor protection circuit breaker for connection of built-in thermal contacts		
		V m³/h	min⁻¹	dB(A) in 4 m	kW	A		No.	Rat. vol. + °C		Control + °C	kg	without motor prot. circ. brea.	with motor prot. circ. brea.	Type	Ref. no.	Type
Three-phase current motor, 230/400 V, 50 Hz, protection category IP44																	
KVD 355/6/70/40	05688	5000	830	42	1.53	5.5/3.2	0860	60	60	54	TSD 5.5	01503	RDS 4	01316	MD	05849	
Ex Ex Explosion-proof, II 2G Ex h IIB T3 Gb, Motor Ex e, three-phase current 230/400 V, 50 Hz, protection category IP44																	
KVD 355/6/70/40 Ex	06814	4800	800	48	1.40	2.4	0899	40	40	49	TSD 3.0	01502	—	—	MSA	01289	

Performance curves KVD 355/6/70/40

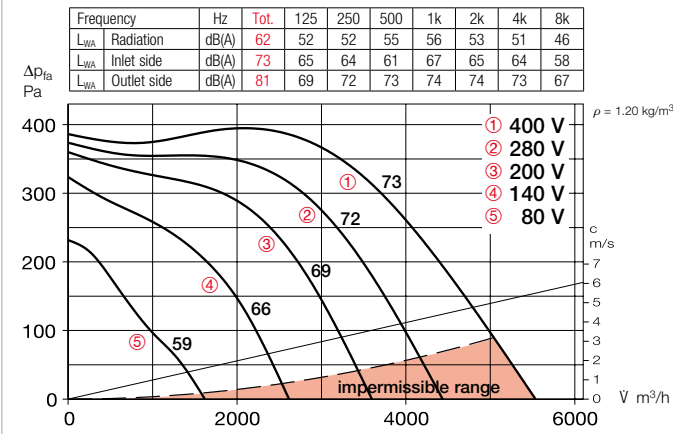

Performance curves KVD 355/6/70/40 Ex

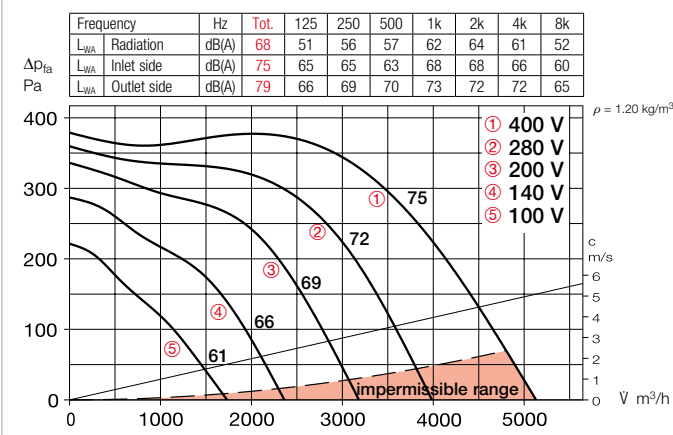

Accessories

External wall shutter

VK 70/40 Ref. no. 00879
 Automatic overpressure shutter made of light grey plastic.



Weather protection grille

WSG 70/40 No. 00114
 Stable construction made of extruded aluminium profiles, natural colour anodised.



Multi-leaf damper for rectangular duct installation

JVK 70/40 Ref. no. 06915
 Frame casing with double-sided flanges, positioning mechanism outside of air flow. Electrical drive see STM, Accessories.



Fitting

FSK 70/40 Ref. no. 00840
 For cost-effective integration of rectangular duct fans in round duct systems with Ø 400 mm.



Flexible connector

VS 70/40 Ref. no. 05699
 Flexible rectangular duct connector with double-sided flange frame.
– for explosion-proof fans
VS 70/40 Ex No. 00269



Counter flange

GF 70/40 Ref. no. 06924
 Flange frame made of galvanised steel sheet for connection to the rectangular duct.



Rectangular duct silencer

KSD 70/40 Ref. no. 08731
 For outlet and inlet side insertion in the rectangular duct system.



Rectangular duct air filter

KLF 70/40 Coarse 70%* 08723
KLF 70/40 ePM1 50%* 08647
 With large bag filter. Galvanised steel sheet casing with double-sided flanges.



Warm water heating element

WHR 2/70/40 No. 08788
WHR 4/70/40 No. 08789
 For installation in rectangular duct system.



Temperature control system for warm water heating element

WHS HE¹⁾ Ref. no. 08319

¹⁾ With heat output reduced to 2200 l/h for Type WHR 4/70/40.



* See product page 477 for detailed description.

Accessory details Page

Shutters and weather prot. grille	472, 553 ff.
Filters, heating elements and silencers	473 ff.
Temperature control systems for heating elements	479, 484 f.
Speed controllers and motor protection circuit breakers	591 ff.

KV 400



Dimensions KV 400

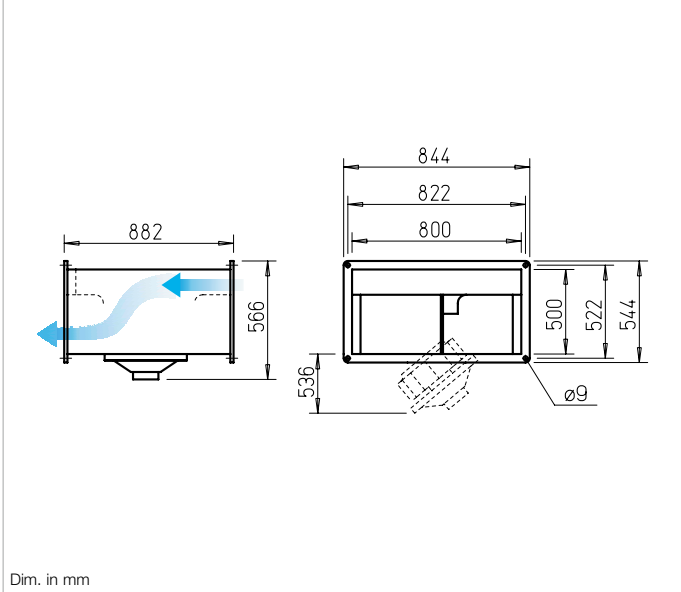

Dim. in mm

Centrifugal rectangular duct fans with forward curved impeller blades. Retractable motor-impeller unit.

- Low-noise impeller in optimised volute casing for high delivery pressures.
- Compact, flat design for versatile use in extract air and intake air systems in commercial and industrial buildings.

Description

- **Casing**
Double-sided standardised rectangular duct flange profiles, made of galvanised steel sheet, space-saving design.
- Particularly easy to service (cleaning) due to retractable motor-impeller unit.
- **Impeller**
Forward curved impeller made of galvanised steel, good level of efficiency, low noise, aerodynamically optimised volute casing; inlet via nozzle.

■ **Drive**

Through maintenance-free external rotor motor on which the impeller is mounted. Closed design, IP44. Winding with moisture proof coating. Ball bearing mounted, radio interference-free. Dynamic balancing and flexible motor mount for low-vibration and low-noise operation.

■ **Electrical connection**

Terminal box (IP55) mounted to external cable.

■ **Motor protection**

Through built-in thermal contacts which must be connected to a motor protection circuit breaker.

■ **Power control**

Possible through voltage reduction by means of 5-step transformer or electronic (continuously variable) controller. The performances at corresponding voltages are shown in the performance diagram.

■ **Noise**

The total level and range are specified above the performance diagram for:

- Case-radiated sound power
- Inlet side sound power
- Outlet side sound power

The inlet side sound power level is also specified above the control voltages in the performance diagram.

- The case-radiated noise as sound pressure at 4 m (free field conditions) is also specified in the type table.

■ **Installation**

Installation possible in any position. Note accessibility/swivelling range.

Reference	Page
Selection table	429
Techn. description	428
Planning information	10 ff.
Modular system	426

Type	Ref. no.	Flow rate max.	Rated speed	Sound press. case-radiation	Power consumption		Wiring diagram	Max. air flow temperature at		Wgt net aprx.	Speed controller 5-step				Motor protection circuit breaker for connection of built-in thermal contacts		
					kW	A		Rat. vol.	Control		kg	Type	Ref. no.	Type	Ref. no.	Type	Ref. no.
		∇ m³/h	min ⁻¹	dB(A) in 4 m			No.	+ °C	+ °C								
Three-phase current motor, 230/400 V, 50 Hz, protection category IP4																	
KVD 400/6/80/50	05691	7600	860	45	2.81	9.1/5.3	0860	60	60	70	TSD 7.0	01504	RDS 7.0	01578	MD		05849

Performance curves KVD 400/6/80/50

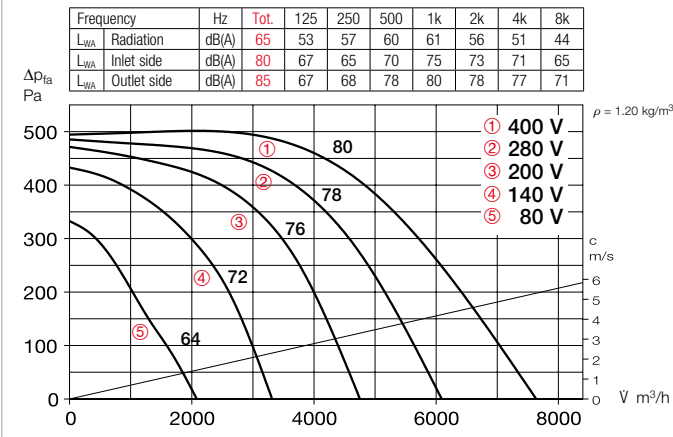

■ Accessories

External wall shutter

VK 80/50 Ref. no. 00880
 Automatic overpressure shutter made of light grey plastic.



Weather protection grille

WSG 80/50 No. 00115
 Stable construction made of extruded aluminium profiles, natural colour anodised.



Multi-leaf damper for rectangular duct installation

JVK 80/50 Ref. no. 06916
 Frame casing with double-sided flanges, positioning mechanism outside of air flow. Electrical drive see STM, Accessories.



Fitting

FSK 80/50 Ref. no. 00842
 For cost-effective integration of rectangular duct fans in round duct systems with Ø 500 mm.



Flexible connector

VS 80/50 Ref. no. 05700
 Flexible rectangular duct connector with double-sided flange frame.



Counter flange

GF 80/50 Ref. no. 06925
 Flange frame made of galvanised steel sheet for connection to the rectangular duct.



Rectangular duct silencer

KSD 80/50 Ref. no. 08732
 For outlet and inlet side insertion in the rectangular duct system.



Rectangular duct air filter

KLF 80/50 Coarse 70%* 08670
KLF 80/50 ePM1 50%* 08654
 With large bag filter. Galvanised steel sheet casing with double-sided flanges.



Warm water heating element

WHR 2/80/50 No. 08795
WHR 4/80/50 No. 08796
 For installation in rectangular duct system.



* See product page 477 for detailed description.

■ **Accessory details** Page

Shutters and weather prot. grille	472, 553 ff.
Filters, heating elements and silencers	473 ff.
Speed controllers and motor protection circuit breakers	591 ff.

KR EC 180



(Fig. similar)

Designed for the delivery of contaminated air.



Dimensions KR EC 180

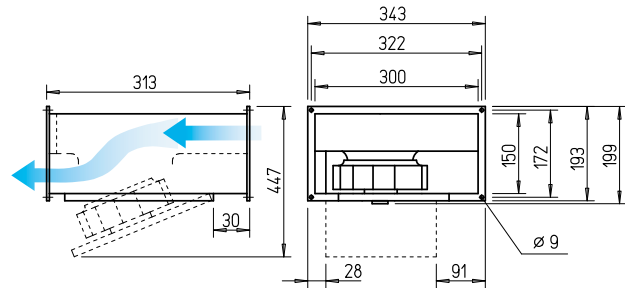

Dim. in mm

Centrifugal EC rectangular duct fans with backward curved impeller blades. Retractable motor-impeller unit.

- Highly efficient EC motor for the lowest operating costs.
- High-performance impellers with high efficiency.
- Use in extract air and intake air systems for the delivery of larger volume flows.
- Non-critical for the delivery of contaminated air.

Special features

- High-pressure and high-volume centrifugal fan with high efficiency.
- Particularly easy to service (cleaning) due to retractable motor-impeller unit.
- Easily accessible for cleaning and thus designed for the delivery of contaminated air.
- Compact design, low space requirement, linear rectangular duct throughflow.

Description

- **Casing**
Made of galvanised steel sheet. Double-sided rectangular duct flange profiles (20 mm) for installation in rectangular duct system.
- **Impeller**
Centrifugal, with backward curved blades made of plastic. Aerodynamically optimised, inlet via nozzle.
- **Drive**
Energy-saving, speed-controllable external rotor EC motor in protection category IP44 with the highest level of efficiency. Maintenance-free and radio interference-free, ball bearing mounted. Motor and impeller dynamically balanced.
- **Motor protection**
Integrated electronic temperature monitoring system for EC motor and electronics.
- **Power control**
Continuously variable speed control with potentiometer or continuously variable speed regulation with universal control system (see table). Performance levels are shown in the performance curve as an example.

■ **Electrical connection**

Terminal box (IP54) mounted to external cable.

■ **Installation**

Installation possible in any position. Note accessibility/swivelling range.

■ **Noise**

The total level and range are specified above the performance diagram for:

- Case-radiated sound power
- Inlet side sound power
- Outlet side sound power.

The case-radiated noise as sound pressure at 4 m (free field conditions) is also specified in the type table and in the table below the performance curve.

Reference	Page
Selection table	429
Techn. description	428
Planning information	10 ff.
Modular system	426

Type	Ref. no.	Flow rate Free blowing	Rated speed	Sound press. case-radiation	Power consum.	Current consum.	Wiring diagram	Max. air flow temp.	Wgt net aprx.	Universal control system		Speed potentiometer		
										Type	Ref. no.	Type	Ref. no.	
Alternating current, 1~, 230 V, 50/60 Hz, EC motor, protection category IP44														
KRW EC 180/30/15	08168	720	3560	41	0.10	0.82	979	60	5.2	EUR EC ¹⁾ 01347	PU 10 ¹⁾	01734	PA 10 ¹⁾	01735

¹⁾ Multiple EC fans can normally be connected. ²⁾ alternative electronic diff. pressure/ temperature controller (EDR/ETR, No. 01437/01438) or three level speed switch (SU/SA, No. 04266/04267), see Accessories.

Performance curves KRW EC 180/30/15

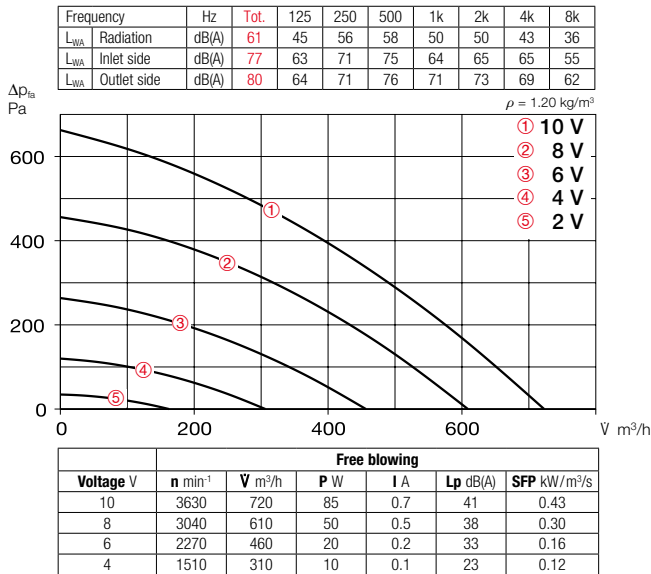

■ Accessories

External wall shutter

VK 30/15 Ref. no. 00735
 Automatic overpressure shutter made of light grey plastic.



Weather protection grille

WSG 30/15 Ref. no. 00108
 Stable construction made of extruded aluminium profiles, natural colour anodised.



Multi-leaf damper for rectangular duct installation

JVK 30/15 Ref. no. 06927
 Frame casing with double-sided flanges, positioning mechanism outside of air flow. Electrical drive see STM, Accessories.



Fitting

FSK 30/15 Ref. no. 00831
 For cost-effective integration of rectangular duct fans in round duct systems with Ø 160 mm.



Flexible connector

VS 30/15 Ref. no. 06928
 Flexible rectangular duct connector with double-sided flange frame.



Counter flange

GF 30/15 Ref. no. 06918
 Flange frame made of galvanised steel sheet for connection to the rectangular duct.



■ **Accessory details** Page

Shutters and weather prot. grille	472, 553 ff.
Filters, heating elements and silencers	473 ff.
Universal control system, electronic controllers, speed potentiometer	605 ff.

KR EC 225



(Fig. similar)

Designed for the delivery of contaminated air.



Dimensions KR EC 225

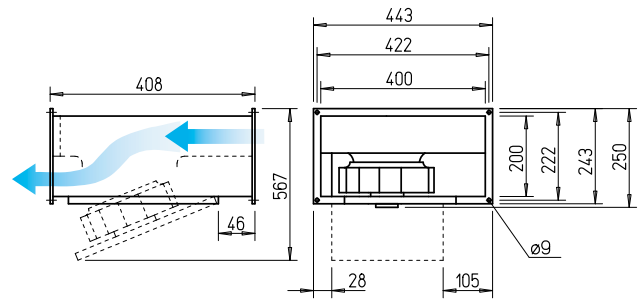

Dim. in mm

Centrifugal EC rectangular duct fans with backward curved impeller blades. Retractable motor-impeller unit.

- Highly efficient EC motor for the lowest operating costs.
- High-performance impellers with high efficiency.
- Use in extract air and intake air systems for the delivery of larger volume flows.
- Non-critical for the delivery of contaminated air.

Special features

- High-pressure and high-volume centrifugal fan with high efficiency.
- Particularly easy to service (cleaning) due to retractable motor-impeller unit.
- Easily accessible for cleaning and thus designed for the delivery of contaminated air.
- Compact design, low space requirement, linear rectangular duct throughflow.

Description

- **Casing**
Made of galvanised steel sheet. Double-sided rectangular duct flange profiles (20 mm) for installation in rectangular duct system.
- **Impeller**
Centrifugal, with backward curved blades made of plastic. Aerodynamically optimised, inlet via nozzle.
- **Drive**
Energy-saving, speed-controllable external rotor EC motor in protection category IP44 with the highest level of efficiency. Maintenance-free and radio interference-free, ball bearing mounted. Motor and impeller dynamically balanced.
- **Motor protection**
Integrated electronic temperature monitoring system for EC motor and electronics.
- **Power control**
Continuously variable speed control with potentiometer or continuously variable speed regulation with universal control system (see table). Performance levels are shown in the performance curve as an example.

■ **Electrical connection**

Terminal box (IP54) mounted to external cable.

■ **Installation**

Installation possible in any position. Note accessibility/swivelling range.

■ **Noise**

The total level and range are specified above the performance diagram for:

- Case-radiated sound power
- Inlet side sound power
- Outlet side sound power.

The case-radiated noise as sound pressure at 4 m (free field conditions) is also specified in the type table and in the table below the performance curve.

■ **Reference**

Page

Selection table	429
Techn. description	428
Planning information	10 ff.
Modular system	426

Type	Ref. no.	Flow rate Free blowing	Rated speed	Sound press. case-radiation	Power consum.	Current consum.	Wiring diagram	Max. air flow temp.	Wgt net aprx.	Universal control system		Speed potentiometer			
										Type	Ref. no.	flush-mount.	Ref. no.	surface-mount.	Ref. no.
		V m³/h	min ⁻¹	dB(A) in 4 m	kW	A	No.	+ °C	kg	Type	Ref. no.	Type	Ref. no.	Type	Ref. no.
Alternating current, 1~, 230 V, 50/60 Hz, EC motor, protection category IP44															
KRW EC 225/40/20	08169	1200	2820	41	0.15	1.19	979	60	8.1	EUR EC ¹⁾ 01347	PU 10 ¹⁾	01734	PA 10 ¹⁾	01735	

¹⁾ Multiple EC fans can normally be connected. ²⁾ alternative electronic diff. pressure/ temperature controller (EDR/ETR, No. 01437/01438) or three level speed switch (SU/SA, No. 04266/04267), see Accessories.

Performance curves KRW EC 225/40/20

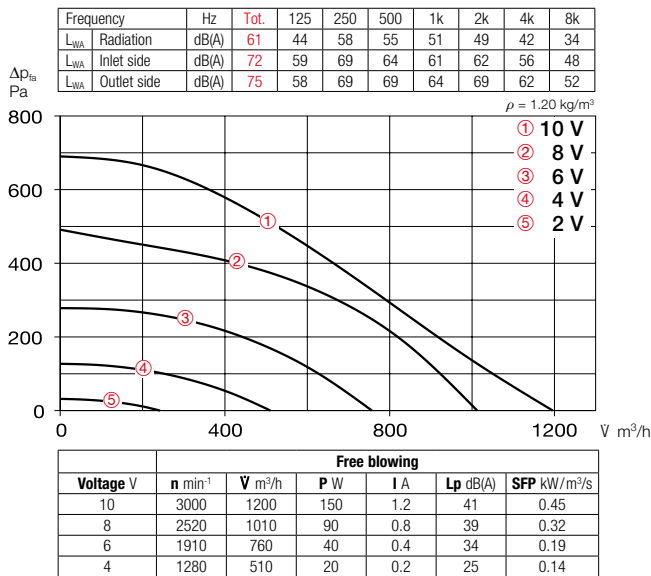

Accessory details Page

Shutters and weather prot. grille	472, 553 ff.
Filters, heating elements and silencers	473 ff.
Temperature control systems for heating elements	479, 484 ff.
Universal control system, electronic controllers, speed potentiometer	605 ff.

Accessories

External wall shutter

VK 40/20 Ref. no. 00874

Automatic overpressure shutter made of light grey plastic.



Weather protection grille

WSG 40/20 Ref. no. 00109

Stable construction made of extruded aluminium profiles, natural colour anodised.



Multi-leaf damper for rectangular duct installation

JVK 40/20 Ref. no. 06910

Frame casing with double-sided flanges, positioning mechanism outside of air flow. Electrical drive see STM, Accessories.



Fitting

FSK 40/20 Ref. no. 00832

For cost-effective integration of rectangular duct fans in round duct systems with Ø 200 mm.



Flexible connector

VS 40/20 Ref. no. 05694

Flexible rectangular duct connector with double-sided flange frame.



Counter flange

GF 40/20 Ref. no. 06919

Flange frame made of galvanised steel sheet for connection to the rectangular duct.



Rectangular duct silencer

KSD 40/20 Ref. no. 08728

For outlet and inlet side insertion in the rectangular duct system.



Rectangular duct air filter

KLF 40/20 Coarse 70%* 08720

KLF 40/20 ePM1 50%* 08644

With large bag filter. Galvanised steel sheet casing with double-sided flanges.



Electric heating element

EHR-K 6/40/20 Ref. no. 08702

EHR-K 15/40/20 Ref. no. 08703

Closed tubular heating element in galvanised steel sheet casing with double-sided connection flanges.



Temperature control system for electric heating element

EHSD 16 Ref. no. 05003



Warm water heating element

WHR 2/40/20 Ref. no. 08782

WHR 4/40/20 Ref. no. 08783

For installation in rectangular duct system.



Temperature control system for warm water heating element

WHS HE Ref. no. 08319



* See product page 477 for detailed description.

KR EC 315



(Fig. similar)

Designed for the delivery of contaminated air.



SKR EC 315 – sound-insulated



Lowest noise levels for inlet side and case radiation with high performance density. Use in extract air and intake air systems with specific noise level requirements.



Dimensions KR EC 315

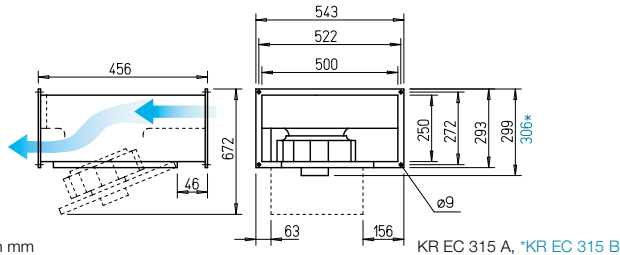

Dim. in mm

KR EC 315 A, *KR EC 315 B

Dimensions SKR EC 315 – sound-insulated

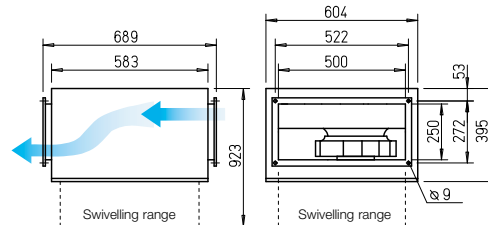

Dim. in mm

Features KR EC and SKR EC

- Highly efficient EC motor for the lowest operating costs.
- High-pressure and high-volume centrifugal fan with high efficiency.
- Particularly easy to service (cleaning) due to retractable motor-impeller unit.
- Easily accessible for cleaning and thus designed for the delivery of contaminated air.
- Linear throughflow.
- Compact design, convenient installation.

Description

Casing KR EC
Made of galvanised steel sheet. Double-sided rectangular duct flange profiles (20 mm) for installation in rectangular duct system.

Casing SKR EC
Like above, but with additional sound insulation cladding made of 50 mm thick mineral fibre boards. With a sound absorbing lining on the inside.

Special features SKR EC

- Lowest noise levels for inlet side and case radiation with high performance density.

Common features KR EC and SKR EC

Impeller
Centrifugal, with backward curved blades (315 A made of plastic and 315 B made of galvanised steel sheet). Aerodynamically optimised, inlet via nozzle.

- Drive**
Energy-saving, speed-control-lable external rotor EC motor in protection category IP44 with the highest level of efficiency. Maintenance-free and radio interference-free, ball bearing mounted. Motor and impeller dynamically balanced.
- Motor protection**
Integrated electronic temperature monitoring system for EC motor and electronics.
- Power control**
Continuously variable speed control with potentiometer or continuously variable speed regulation with universal control system (see table). Performance levels are shown in the performance curve as an example.
- Electrical connection**
Terminal box (IP54) mounted to external cable.
- Installation**
Installation possible in any position. Note accessibility/swivel angle.
- Noise**
The total level and range are specified above the performance diagram for:
 - Case-radiated sound power
 - Inlet side sound power
 - Outlet side sound power.
 The case-radiated noise as sound pressure at 4 m (free field conditions) is also specified in the type table and in the table below the performance curve.

Type	Ref. no.	Flow rate Free blowing	Rated speed	Sound press. case-radiation	Power consum.	Current consum.	Wiring diagram	Max. air flow temp.	Wgt net aprx.	Universal control system		Speed potentiometer		
										flush-mount.	surface-mount.			
		V m³/h	min⁻¹	dB(A) in 4 m	kW	A	No.	+ °C	kg	Type	Ref. no.	Type	Ref. no.	
Alternating current, 1~, 230 V, 50/60 Hz, EC motor, protection category IP44														
KRW EC 315/50/25 A	08170	1210	2740	35	0.15	1.17	979	60	11.0	EUR EC ¹⁾²⁾ 01347	PU 10 ¹⁾	01734	PA 10 ¹⁾	01735
KRW EC 315/50/25 B	07589	2250	2830	44	0.35	2.67	979	60	12.0	EUR EC ¹⁾²⁾ 01347	PU 10 ¹⁾	01734	PA 10 ¹⁾	01735
Sound-insulated SKR EC – Alternating current, 1~, 230 V, 50/60 Hz, EC motor, protection category IP44														
SKRW EC 315/50/25 A	07588	1270	2750	29	0.15	1.23	979	60	24.4	EUR EC ¹⁾²⁾ 01347	PU 10 ¹⁾	01734	PA 10 ¹⁾	01735
Sound-insulated SKR EC – Alternating current, 1~, 230 V, 50/60 Hz, EC motor, protection category IP44														
SKRW EC 315/50/25 B ³⁾	08182	2170	2850	36	0.35	2.71	979	60	25.3	EUR EC ¹⁾²⁾ 01347	PU 10 ¹⁾	01734	PA 10 ¹⁾	01735

¹⁾ Multiple EC fans can normally be connected. ²⁾ alternative electronic diff. pressure/ temperature controller (EDR/ETR, No. 01437/01438) or three level speed switch (SU/SA, No. 04266/04267), see Accessories. ³⁾ Performance diagram at www.HeliosSelect.de.

Performance curves KRW EC 315/50/25 A

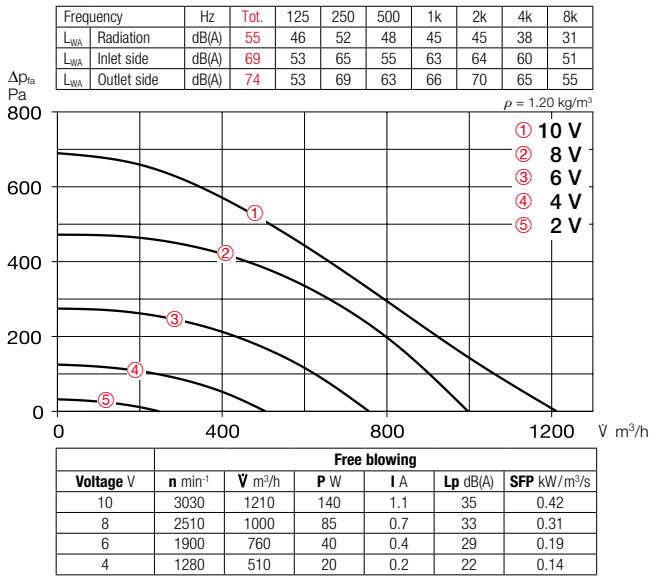

Performance curves KRW EC 315/50/25 B

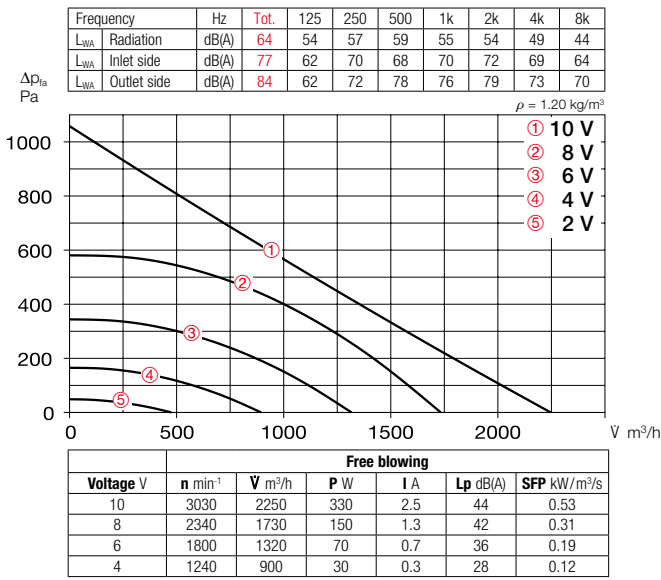

Performance curves SKRW EC 315/50/25 A

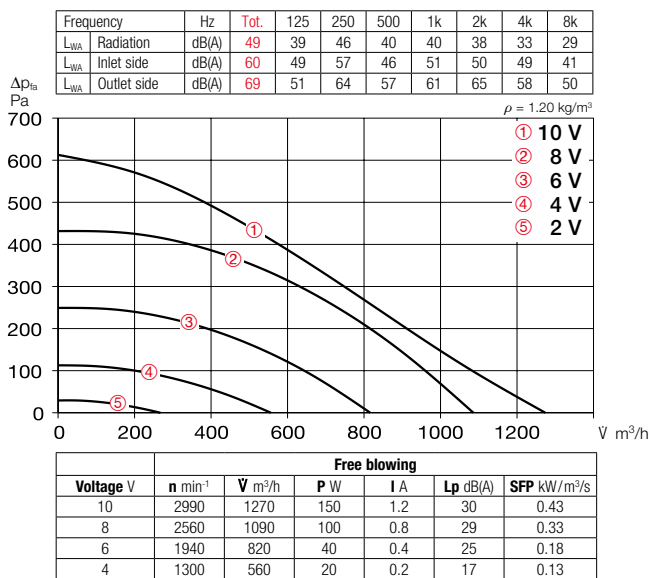

Accessories

External wall shutter
VK 50/25 Ref. no. 00875
 Automatic overpressure shutter made of light grey plastic.

Weather protection grille
WSG 50/25 Ref. no. 00110
 Stable construction made of extruded aluminium profiles, natural colour anodised.

Multi-leaf damper for rectangular duct installation
JVK 50/25 Ref. no. 06911
 Frame casing with double-sided flanges, positioning mechanism outside of air flow. Electrical drive see STM, Accessories.

Fitting
FSK 50/25 Ref. no. 00833
 For cost-effective integration of rectangular duct fans in round duct systems with Ø 250 mm.

Flexible connector
VS 50/25 Ref. no. 05695
 Flexible rectangular duct connector with double-sided flange frame.

Counter flange
GF 50/25 Ref. no. 06920
 Flange frame made of galvanised steel sheet for connection to the rectangular duct.

Rectangular duct silencer
KSD 50/25-30 Ref. no. 08729
 For outlet and inlet side insertion in the rectangular duct system.

Rectangular duct air filter
KLF 50/25-30 Coarse 70%* 08721
KLF 50/25-30 ePM1 50%* 08645
 With large bag filter. Galvanised steel sheet casing with double-sided flanges.

Electric heating element
EHR-K 8/50/25-30 No. 08704
EHR-K 24/50/25-30 No. 08705
 Closed tubular heating element in galvanised steel sheet casing with double-sided connection flanges.

Temperature control system for electric heating element
EHSD 16 Ref. no. 05003

Warm water heating element
WHR 2/50/25-30 No. 08784
WHR 4/50/25-30 No. 08785
 For installation in rectangular duct system.

Temperature control system for warm water heating element
WHS HE Ref. no. 08319

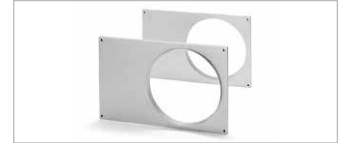

EC rectangular duct fans

* See product page 477 for detailed description.

KR EC 355



(Fig. similar)

Designed for the delivery of contaminated air.



SKR EC 355 – sound-insulated



Lowest noise levels for inlet side and case radiation with high performance density. Use in extract air and intake air systems with specific noise level requirements.



Dimensions KR EC 355

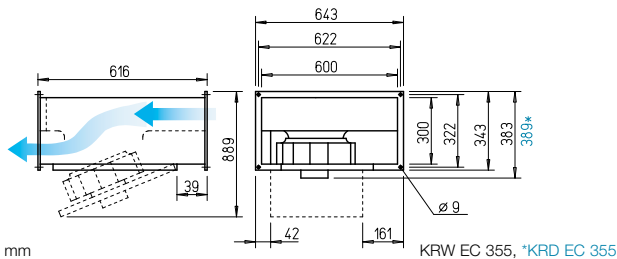

Dim. in mm

KRW EC 355, *KRD EC 355

Dimensions SKR EC 355 – sound-insulated

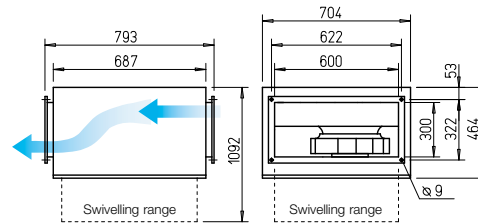

Dim. in mm

Features KR EC and SKR EC

- Highly efficient EC motor for the lowest operating costs.
- High-pressure and high-volume centrifugal fan with high efficiency.
- Particularly easy to service (cleaning) due to retractable motor-impeller unit.
- Easily accessible for cleaning and thus designed for the delivery of contaminated air.
- Linear throughflow.
- Compact design, convenient installation.

Description

- Casing KR EC**
Made of galvanised steel sheet. Double-sided rectangular duct flange profiles (20 mm) for installation in rectangular duct system.
- Casing SKR EC**
Like above, but with additional sound insulation cladding made of 50 mm thick mineral fibre boards. With a sound absorbing lining on the inside.

Special features SKR EC

- Lowest noise levels for inlet side and case radiation with high performance density.

Common features KR EC and SKR EC

- Impeller**
Centrifugal, with backward curved blades made of aluminium. Aerodynamically optimised, inlet via nozzle.

Drive

Energy-saving, speed-controlable external rotor EC motor in protection category IP44 with the highest level of efficiency. Maintenance-free and radio interference-free, ball bearing mounted. Motor and impeller dynamically balanced.

Motor protection

Integrated electronic temperature monitoring system for EC motor and electronics.

Power control

Continuously variable speed control with potentiometer or continuously variable speed regulation with universal control system (see table). Performance levels are shown in the performance curve as an example.

Electrical connection

Terminal box (IP54) mounted to external cable.

Installation

Installation possible in any position. Note accessibility/swivel angle.

Noise

The total level and range are specified above the performance diagram for:
 Case-radiated sound power
 Inlet side sound power
 Outlet side sound power.
 The case-radiated noise as sound pressure at 4 m (free field conditions) is also specified in the type table and in the table below the performance curve.

Type	Ref. no.	Flow rate Free blowing	Rated speed	Sound press. case- radiation	Power consum.	Current consum.	Wiring diagram	Max. air flow temp.	Wgt net aprx.	Universal control system		Speed potentiometer		
										Type	Ref. no.	Type	Ref. no.	
Alternating current, 1~, 230 V, 50/60 Hz, EC motor, protection category IP44														
KRW EC 355/60/30	08171	2960	1620	46	0.37	1.61	979	60	20.8	EUR EC ²⁾ 01347	PU 10 ¹⁾	01734	PA 10 ¹⁾	01735
Three-phase current, 3~, 400 V, 50/60 Hz, EC motor, protection category IP44														
KRD EC 355/60/30	07590	4380	2500	56	1.30	2.01	1479	60	23.3	EUR EC ²⁾ 01347	PU 10 ¹⁾	01734	PA 10 ¹⁾	01735
Sound-insulated SKR EC – Alternating current, 1~, 230 V, 50/60 Hz, EC motor, protection category IP44														
SKRW EC 355/60/30 ³⁾	08176	3860	2210	43	0.90	3.92	979	60	40.0	EUR EC ²⁾ 01347	PU 10 ¹⁾	01734	PA 10 ¹⁾	01735
Sound-insulated SKR EC – Three-phase current, 3~, 400 V, 50/60 Hz, EC motor, protection category IP44														
SKRD EC 355/60/30	08296	4340	2510	46	1.26	1.96	1479	60	40.0	EUR EC ²⁾ 01347	PU 10 ¹⁾	01734	PA 10 ¹⁾	01735

¹⁾ Multiple EC fans can normally be connected. ²⁾ alternative electronic diff. pressure/ temperature controller (EDR/ETR, No. 01437/01438) or three level speed switch (SU/SA, No. 04266/04267), see Accessories. ³⁾ Performance diagram at www.HeliosSelect.de.

Performance curves KRW EC 355/60/30

Frequency	Hz	Tot.	125	250	500	1k	2k	4k	8k	
L _{WA} Radiation		dB(A)	66	51	64	56	57	52	44	37
L _{WA} Inlet side		dB(A)	79	65	77	68	66	68	63	55
L _{WA} Outlet side		dB(A)	83	66	80	73	76	75	69	60

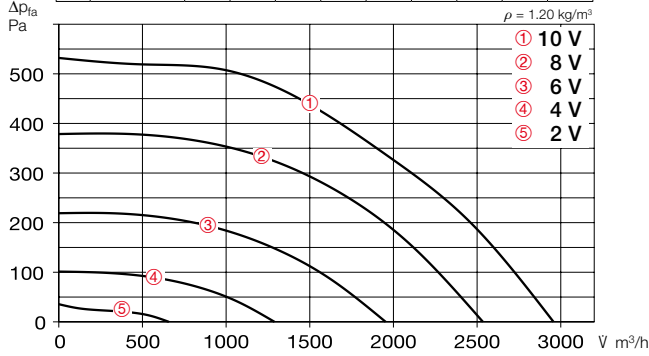

Free blowing						
Voltage V	n min ⁻¹	V m³/h	P W	I A	Lp dB(A)	SFP kW/m³/s
10	1660	2960	310	1.4	46	0.38
8	1410	2530	190	0.9	41	0.27
6	1070	1960	90	0.4	35	0.17
4	730	1290	40	0.2	25	0.11

Performance curves KRD EC 355/60/30

Frequency	Hz	Tot.	125	250	500	1k	2k	4k	8k	
L _{WA} Radiation		dB(A)	76	61	71	69	71	65	58	57
L _{WA} Inlet side		dB(A)	86	74	79	80	79	80	76	69
L _{WA} Outlet side		dB(A)	94	75	87	87	88	89	82	75

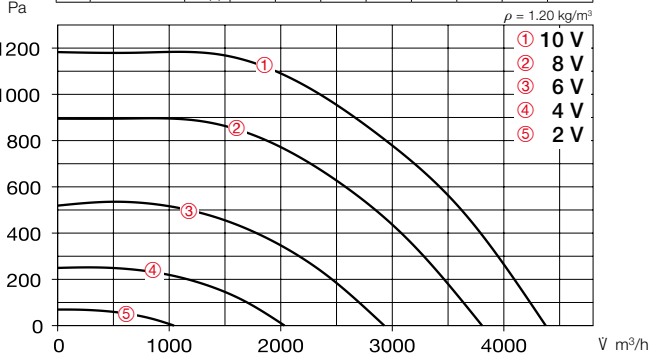

Free blowing						
Voltage V	n min ⁻¹	V m³/h	P W	I A	Lp dB(A)	SFP kW/m³/s
10	2500	4380	990	1.6	56	0.81
8	2180	3810	660	1.1	53	0.62
6	1670	2930	310	0.6	47	0.38
4	1150	2040	120	0.3	38	0.21

Performance curves SKRD EC 355/60/30

Frequency	Hz	Tot.	125	250	500	1k	2k	4k	8k	
L _{WA} Radiation		dB(A)	66	57	63	56	58	49	44	41
L _{WA} Inlet side		dB(A)	75	67	72	66	63	65	60	56
L _{WA} Outlet side		dB(A)	86	70	79	76	81	80	74	67

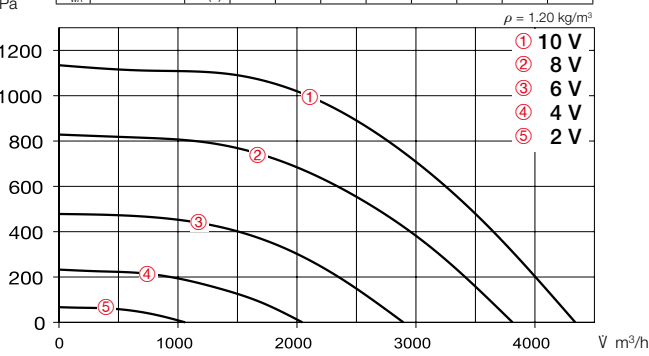

Free blowing						
Voltage V	n min ⁻¹	V m³/h	P W	I A	Lp dB(A)	SFP kW/m³/s
10	2500	4340	980	1.5	46	0.81
8	2175	3810	660	1.0	43	0.62
6	1660	2890	310	0.5	39	0.39
4	1145	2050	120	0.3	31	0.21

Accessories

External wall shutter

VK 60/30 Ref. no. 00877
 Automatic overpressure shutter made of light grey plastic.



Weather protection grille

WSG 60/30 Ref. no. 00112
 Stable construction made of extruded aluminium profiles, natural colour anodised.



Multi-leaf damper for rectangular duct installation

JVK 60/30 Ref. no. 06913
 Frame casing with double-sided flanges, positioning mechanism outside of air flow. Electrical drive see STM, Accessories.



Fitting

FSK 60/30 Ref. no. 00834
 For cost-effective integration of rectangular duct fans in round duct systems with Ø 315 mm.



Flexible connector

VS 60/30 Ref. no. 05697
 Flexible rectangular duct connector with double-sided flange frame.



Counter flange

GF 60/30 Ref. no. 06922
 Flange frame made of galvanised steel sheet for connection to the rectangular duct.



Rectangular duct silencer

KSD 60/30-35 Ref. no. 08730
 For outlet and inlet side insertion in the rectangular duct system.



Rectangular duct air filter

KLF 60/30-35 Coarse 70%* 08722
KLF 60/30-35 ePM2.5 65%* 08646
 With large bag filter. Galvanised steel sheet casing with double-sided flanges.



Electric heating element

EHR-K 15/60/30-35 No. 08706
EHR-K 30/60/30-35 No. 08707
 Closed tubular heating element in galvanised steel sheet casing with double-sided connection flanges.



Temperature control system for electric heating element

EHSD 16 Ref. no. 05003



Warm water heating element

WHR 2/60/30-35 No. 08786
WHR 4/60/30-35 No. 08787
 For installation in rectangular duct system.



Temperature control system for warm water heating element

WHS HE¹⁾ Ref. no. 08319

¹⁾ With heat output reduced to 2200 l/h for Type WHR 4/60/30-35.



* See product page 477 for detailed description.

KR EC 400



(Fig. similar)

Designed for the delivery of contaminated air.



SKR EC 400 – sound-insulated



Lowest noise levels for inlet side and case radiation with high performance density. Use in extract air and intake air systems with specific noise level requirements.



Dimensions KR EC 400

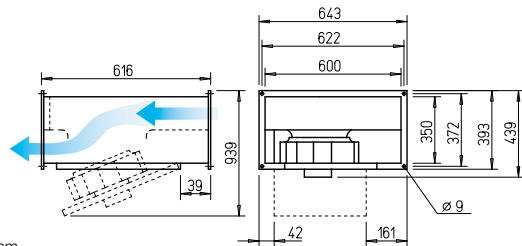

Dim. in mm

Dimensions SKR EC 400 – sound-insulated

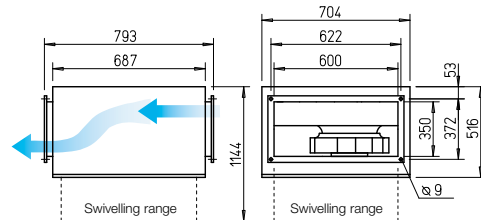

Dim. in mm

Features KR EC and SKR EC

- Highly efficient EC motor for the lowest operating costs.
- High-pressure and high-volume centrifugal fan with high efficiency.
- Particularly easy to service (cleaning) due to retractable motor-impeller unit.
- Easily accessible for cleaning and thus designed for the delivery of contaminated air.
- Linear throughflow.
- Compact design, convenient installation.

Description

- Casing KR EC**
Made of galvanised steel sheet. Double-sided rectangular duct flange profiles (20 mm) for installation in rectangular duct system.
- Casing SKR EC**
Like above, but with additional sound insulation cladding made of 50 mm thick mineral fibre boards. With a sound absorbing lining on the inside.

Special features SKR EC

- Lowest noise levels for inlet side and case radiation with high performance density.

Common features KR EC and SKR EC

- Impeller**
Centrifugal, with backward curved blades made of aluminium. Aerodynamically optimised, inlet via nozzle.

Drive

Energy-saving, speed-control-lable external rotor EC motor in protection category IP44 with the highest level of efficiency. Maintenance-free and radio interference-free, ball bearing mounted. Motor and impeller dynamically balanced.

Motor protection

Integrated electronic temperature monitoring system for EC motor and electronics.

Power control

Continuously variable speed control with potentiometer or continuously variable speed regulation with universal control system (see table). Performance levels are shown in the performance curve as an example.

Electrical connection

Terminal box (IP54) mounted to external cable.

Installation

Installation possible in any position. Note accessibility/swivel angle.

Noise

The total level and range are specified above the performance diagram for:

- Case-radiated sound power
- Inlet side sound power
- Outlet side sound power.

The case-radiated noise as sound pressure at 4 m (free field conditions) is also specified in the type table and in the table below the performance curve.

Type	Ref. no.	Flow rate Free blowing	Rated speed	Sound press. case-radiation	Power consum.	Current consum.	Wiring diagram	Max. air flow temp.	Wgt net aprx.	Universal control system		Speed potentiometer		
										Type	Ref. no.	Type	Ref. no.	
Alternating current, 1~, 230 V, 50/60 Hz, EC motor, protection category IP44														
KRW EC 400/60/35	08172	4100	2210	49	0.92	4.03	979	60	24.5	EUR EC ¹⁾²⁾ 01347	PU 10 ¹⁾	01734	PA 10 ¹⁾	01735
Three-phase current, 3~, 400 V, 50/60 Hz, EC motor, protection category IP44														
KRD EC 400/60/35	07591	4580	2510	53	1.30	2.01	1479	60	24.4	EUR EC ¹⁾²⁾ 01347	PU 10 ¹⁾	01734	PA 10 ¹⁾	01735
Sound-insulated SKR EC – Alternating current, 1~, 230 V, 50/60 Hz, EC motor, protection category IP44														
SKREW EC 400/60/35 ³⁾	08177	3960	2210	42	0.91	3.96	979	60	42.0	EUR EC ¹⁾²⁾ 01347	PU 10 ¹⁾	01734	PA 10 ¹⁾	01735
Sound-insulated SKR EC – Three-phase current, 3~, 400 V, 50/60 Hz, EC motor, protection category IP44														
SKRD EC 400/60/35	08297	4580	2510	46	1.27	1.98	1479	60	42.0	EUR EC ¹⁾²⁾ 01347	PU 10 ¹⁾	01734	PA 10 ¹⁾	01735

¹⁾ Multiple EC fans can normally be connected. ²⁾ alternative electronic diff. pressure/ temperature controller (EDR/ETR, No. 01437/01438) or three level speed switch (SU/SA, No. 04266/04267), see Accessories. ³⁾ Performance diagram at www.HellosSelect.de.

Performance curves KRW EC 400/60/35

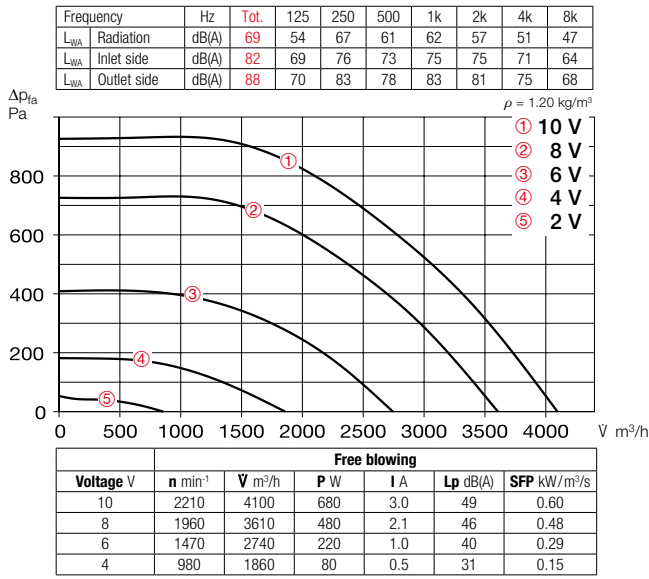

Performance curves KRD EC 400/60/35

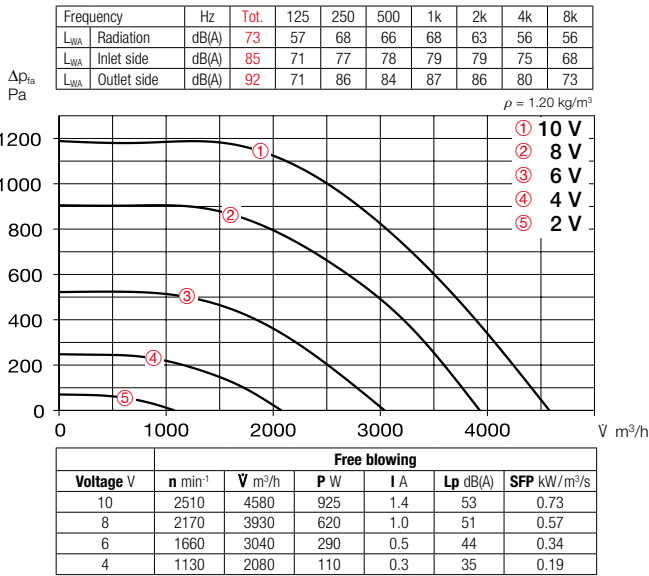

Performance curves SKRD EC 400/60/35

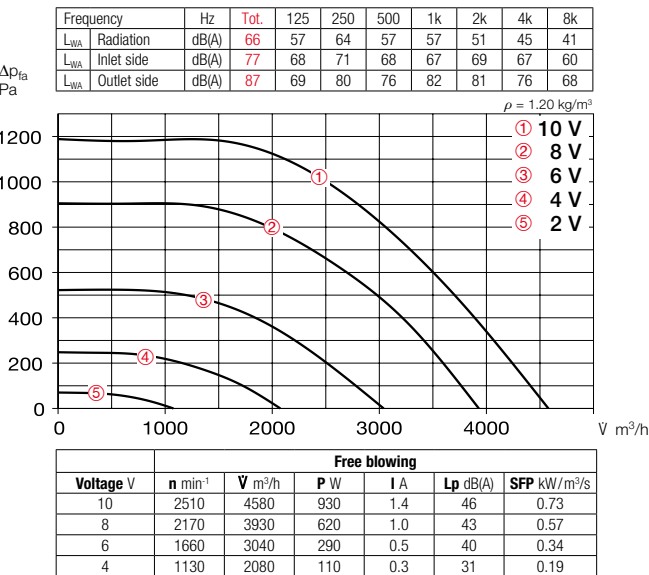

Accessories

External wall shutter
VK 60/35 Ref. no. 00878
 Automatic overpressure shutter made of light grey plastic.

Weather protection grille
WSG 60/35 Ref. no. 00113
 Stable construction made of extruded aluminium profiles, natural colour anodised.

Multi-leaf damper for rectangular duct installation
JVK 60/35 Ref. no. 06914
 Frame casing with double-sided flanges, positioning mechanism outside of air flow. Electrical drive see STM, Accessories.

Fitting
FSK 60/35 Ref. no. 00835
 For cost-effective integration of rectangular duct fans in round duct systems with Ø 355 mm.

Flexible connector
VS 60/35 Ref. no. 05698
 Flexible rectangular duct connector with double-sided flange frame.

Counter flange
GF 60/35 Ref. no. 06923
 Flange frame made of galvanised steel sheet for connection to the rectangular duct.

Rectangular duct silencer
KSD 60/30-35 Ref. no. 08730
 For outlet and inlet side insertion in the rectangular duct system.

Rectangular duct air filter
KLF 60/30-35 Coarse 70%* 08722
KLF 60/30-35 ePM2.5 65%* 08646
 With large bag filter. Galvanised steel sheet casing with double-sided flanges.

Electric heating element
EHR-K 15/60/30-35 No. 08706
EHR-K 30/60/30-35 No. 08707
 Closed tubular heating element in galvanised steel sheet casing with double-sided connection flanges.

Temperature control system for electric heating element
EHSD 16 Ref. no. 05003

Warm water heating element
WHR 2/60/30-35 No. 08786
WHR 4/60/30-35 No. 08787
 For installation in rectangular duct system.

Temperature control system for warm water heating element
WHS HE¹⁾ Ref. no. 08319

¹⁾ With heat output reduced to 2200 l/h for Type WHR 4/60/30-35.

* See product page 477 for detailed description.



KR EC 450



Designed for the delivery of contaminated air.



SKR EC 450 – sound-insulated



Lowest noise levels for inlet side and case radiation with high performance density. Use in extract air and intake air systems with specific noise level requirements.



Dimensions KR EC 450

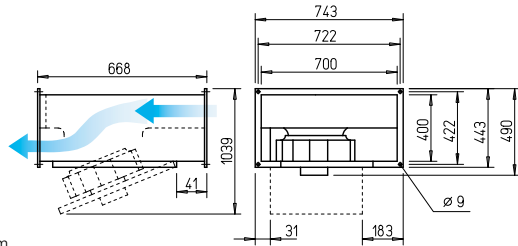

Dim. in mm

Dimensions SKR EC 450 – sound-insulated

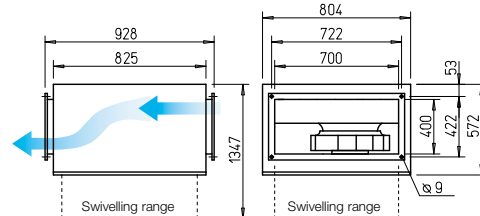

Dim. in mm

Features KR EC and SKR EC

- Highly efficient EC motor for the lowest operating costs.
- High-pressure and high-volume centrifugal fan with high efficiency.
- Particularly easy to service (cleaning) due to retractable motor-impeller unit.
- Easily accessible for cleaning and thus designed for the delivery of contaminated air.
- Linear throughflow.
- Compact design, convenient installation.

Description

- Casing KR EC**
Made of galvanised steel sheet. Double-sided rectangular duct flange profiles (20 mm) for installation in rectangular duct system.
- Casing SKR EC**
Like above, but with additional sound insulation cladding made of 50 mm thick mineral fibre boards. With a sound absorbing lining on the inside.

Special features SKR EC

- Lowest noise levels for inlet side and case radiation with high performance density.

Common features KR EC and SKR EC

- Impeller**
Centrifugal, with backward curved blades made of aluminium. Aerodynamically optimised, inlet via nozzle.

Drive

Energy-saving, speed-controllable external rotor EC motor in protection category IP44 with the highest level of efficiency. Maintenance-free and radio interference-free, ball bearing mounted. Motor and impeller dynamically balanced.

Electrical connection

Terminal box (IP54) mounted to external cable.

Installation

Installation possible in any position. Note accessibility/swivel angle.

Noise

The total level and range are specified above the performance diagram for:

- Case-radiated sound power
- Inlet side sound power
- Outlet side sound power.

The case-radiated noise as sound pressure at 4 m (free field conditions) is also specified in the type table and in the table below the performance curve.

Motor protection

Integrated electronic temperature monitoring system for EC motor and electronics.

Power control

Continuously variable speed control with potentiometer or continuously variable speed regulation with universal control system (see table). Performance levels are shown in the performance curve as an example.

Type	Ref. no.	Flow rate Free blowing	Rated speed	Sound press. case-radiation	Power consum.	Current consum.	Wiring diagram	Max. air flow temp.	Wgt net aprx.	Universal control system		Speed potentiometer		
										Type	Ref. no.	Type	Ref. no.	
Alternating current, 1~, 230 V, 50/60 Hz, EC motor, protection category IP44														
KRW EC 450/70/40	06127	5570	1500	48	0.86	3.80	979	60	37.0	EUR EC ¹⁾²⁾ 01347	PU 10 ¹⁾	01734	PA 10 ¹⁾	01735
Three-phase current, 3~, 400 V, 50/60 Hz, EC motor, protection category IP44														
KRD EC 450/70/40	08173	7520	1920	54	1.82	2.81	1479	60	38.2	EUR EC ¹⁾²⁾ 01347	PU 10 ¹⁾	01734	PA 10 ¹⁾	01735
Sound-insulated SKR EC – Alternating current, 1~, 230 V, 50/60 Hz, EC motor, protection category IP44														
SKRW EC 450/70/40 ³⁾	06129	5390	1510	46	0.84	3.70	979	60	56.0	EUR EC ¹⁾²⁾ 01347	PU 10 ¹⁾	01734	PA 10 ¹⁾	01735
Sound-insulated SKR EC – Three-phase current, 3~, 400 V, 50/60 Hz, EC motor, protection category IP44														
SKRD EC 450/70/40 A	08178	7460	1940	49	1.81	2.81	1479	60	57.2	EUR EC ¹⁾²⁾ 01347	PU 10 ¹⁾	01734	PA 10 ¹⁾	01735

¹⁾ Multiple EC fans can normally be connected. ²⁾ alternative electronic diff. pressure/ temperature controller (EDR/ETR, No. 01437/01438) or three level speed switch (SU/SA, No. 04266/04267), see Accessories. ³⁾ Performance diagram at www.HellosSelect.de.

Performance curves KRW EC 450/70/40

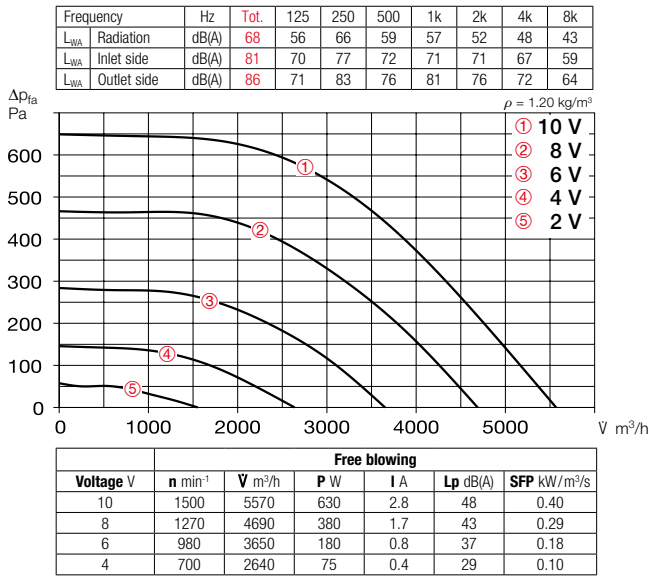

Performance curves KRD EC 450/70/40

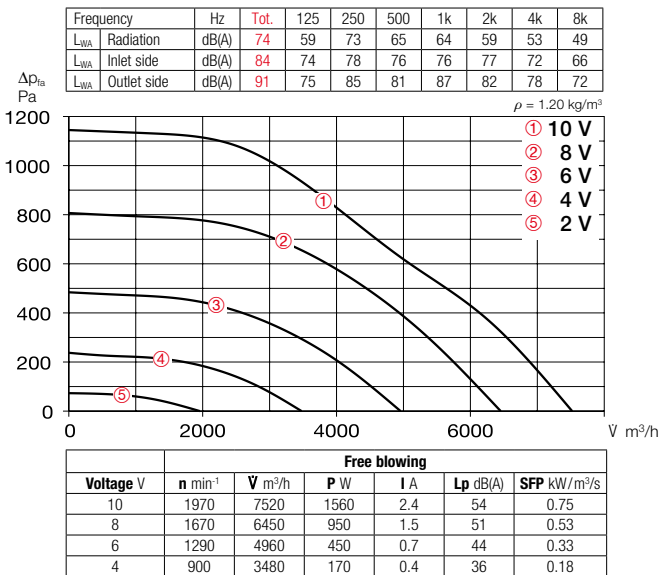

Performance curves SKRD EC 450/70/40 A

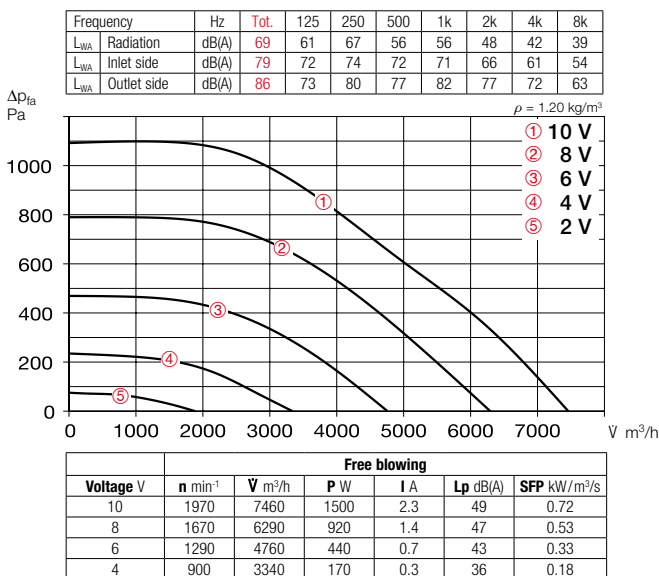

Accessories

External wall shutter

VK 70/40 Ref. no. 00879
 Automatic overpressure shutter made of light grey plastic.



Weather protection grille

WSG 70/40 Ref. no. 00114
 Stable construction made of extruded aluminium profiles, natural colour anodised.



Multi-leaf damper for rectangular duct installation

JVK 70/40 Ref. no. 06915
 Frame casing with double-sided flanges, positioning mechanism outside of air flow. Electrical drive see STM, Accessories.



Fitting

FSK 70/40 Ref. no. 00840
 For cost-effective integration of rectangular duct fans in round duct systems with Ø 400 mm.



Flexible connector

VS 70/40 Ref. no. 05699
 Flexible rectangular duct connector with double-sided flange frame.



Counter flange

GF 70/40 Ref. no. 06924
 Flange frame made of galvanised steel sheet for connection to the rectangular duct.



Rectangular duct silencer

KSD 70/40 Ref. no. 08731
 For outlet and inlet side insertion in the rectangular duct system.



Rectangular duct air filter

KLF 70/40 Coarse 70%* 08723
KLF 70/40 ePM1 50%* 08647
 With large bag filter. Galvanised steel sheet casing with double-sided flanges.



Warm water heating element

WHR 2/70/40 Ref. no. 08788
WHR 4/70/40 Ref. no. 08789
 For installation in rectangular duct system.



Temperature control system

for warm water heating element
WHS HE¹⁾ Ref. no. 08319

¹⁾ With heat output reduced to 2200 l/h for Type WHR 4/70/40.



Accessory details Page

Shutters and weather prot. grille	472, 553 ff.
Filters, heating elements and silencers	473 ff.
Temperature control systems for heating elements	479, 484 f
Universal control system, electronic controllers, speed potentiometer	605 ff.

* See product page 477 for detailed description.

KR EC 500



Designed for the delivery of contaminated air.



SKR EC 500 – sound-insulated



Lowest noise levels for inlet side and case radiation with high performance density. Use in extract air and intake air systems with specific noise level requirements.



Dimensions KR EC 500

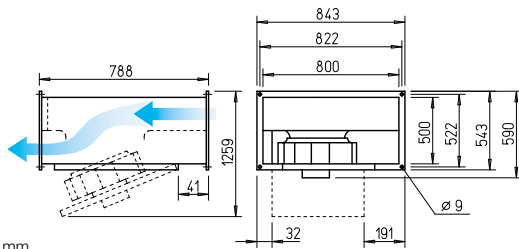

Dim. in mm

Dimensions SKR EC 500 – sound-insulated

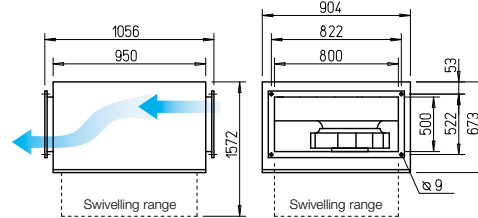

Dim. in mm

Features KR EC and SKR EC

- Highly efficient EC motor for the lowest operating costs.
- High-pressure and high-volume centrifugal fan with high efficiency.
- Particularly easy to service (cleaning) due to retractable motor-impeller unit.
- Easily accessible for cleaning and thus designed for the delivery of contaminated air.
- Linear throughflow.
- Compact design, convenient installation.

Description

- **Casing KR EC**
Made of galvanised steel sheet. Double-sided rectangular duct flange profiles (20 mm) for installation in rectangular duct system.

- **Casing SKR EC**
Like above, but with additional sound insulation cladding made of 50 mm thick mineral fibre boards. With a sound absorbing lining on the inside.

Special features SKR EC

- Lowest noise levels for inlet side and case radiation with high performance density.

Common features KR EC and SKR EC

- **Impeller**
Centrifugal, with backward curved blades made of aluminium. Aerodynamically optimised, inlet via nozzle.

■ **Drive**

Energy-saving, speed-controllable external rotor EC motor in protection category IP44 with the highest level of efficiency. Maintenance-free and radio interference-free, ball bearing mounted. Motor and impeller dynamically balanced.

■ **Motor protection**

Integrated electronic temperature monitoring system for EC motor and electronics.

■ **Power control**

Continuously variable speed control with potentiometer or continuously variable speed regulation with universal control system (see table). Performance levels are shown in the performance curve as an example.

■ **Electrical connection**

Terminal box (IP54) mounted to external cable.

■ **Installation**

Installation possible in any position. Note accessibility/swivel angle.

■ **Noise**

The total level and range are specified above the performance diagram for:

- Case-radiated sound power
- Inlet side sound power
- Outlet side sound power.

The case-radiated noise as sound pressure at 4 m (free field conditions) is also specified in the type table and in the table below the performance curve.

Type	Ref. no.	Flow rate Free blowing	Rated speed	Sound press. case-radiation	Power consum.	Current consum.	Wiring diagram	Max. air flow temp.	Wgt net aprx.	Universal control system		Speed potentiometer		
										Type	Ref. no.	Type	Ref. no.	
Three-phase current, 3~, 400 V, 50/60 Hz, EC motor, protection category IP44														
KRD EC 500/80/50 A	08174	7990	1350	47	1.24	1.92	1479	60	50.5	EUR EC ¹⁾²⁾ 01347	PU 10 ¹⁾ 01734	PA 10 ¹⁾ 01735		
KRD EC 500/80/50 B ³⁾	06128	9080	1550	51	1.81	2.79	1479	60	50.5	EUR EC ¹⁾²⁾ 01347	PU 10 ¹⁾ 01734	PA 10 ¹⁾ 01735		
Sound-insulated SKR EC – Three-phase current, 3~, 400 V, 50/60 Hz, EC motor, protection category IP44														
SKRD EC 500/80/50 A	08299	7990	1350	45	1.22	1.88	1479	60	73.5	EUR EC ¹⁾²⁾ 01347	PU 10 ¹⁾ 01734	PA 10 ¹⁾ 01735		
SKRD EC 500/80/50 B	08179	8760	1540	48	1.82	2.81	1479	60	73.5	EUR EC ¹⁾²⁾ 01347	PU 10 ¹⁾ 01734	PA 10 ¹⁾ 01735		

¹⁾ Multiple EC fans can normally be connected. ²⁾ alternative electronic diff. pressure/ temperature controller (EDR/ETR, No. 01437/01438) or three level speed switch (SU/SA, No. 04266/04267), see Accessories. ³⁾ Performance diagram at www.HeliosSelect.de.

Performance curves KRD EC 500/80/50 A

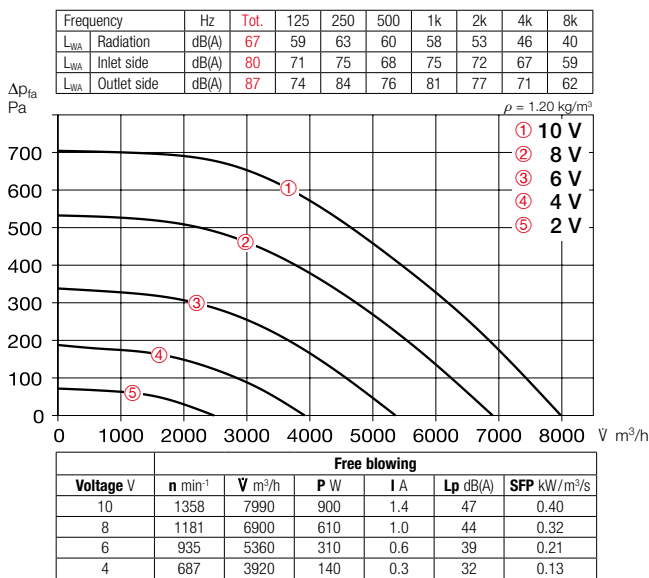

Performance curves SKRD EC 500/80/50 A

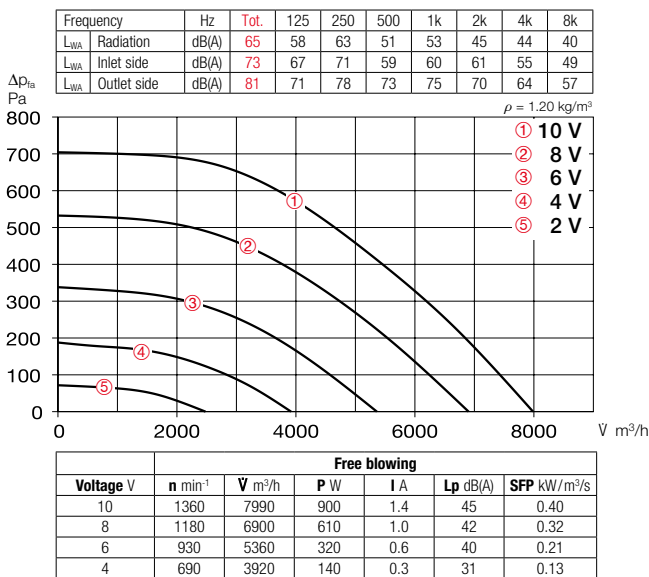

Performance curves SKRD EC 500/80/50 B

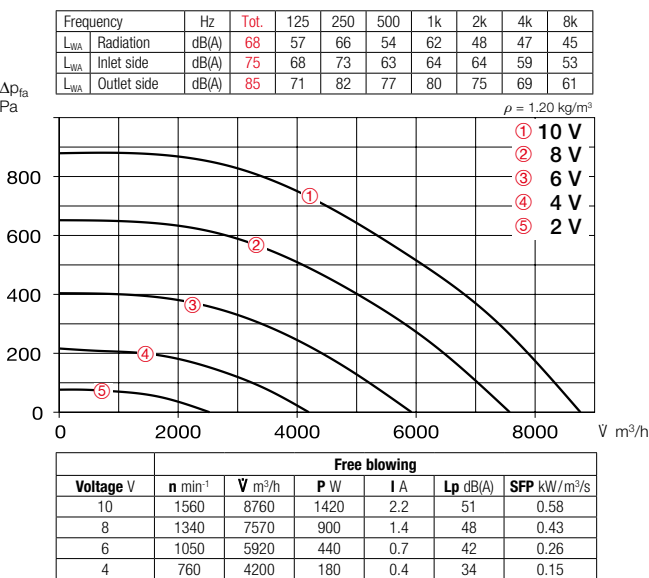

Accessories

External wall shutter
VK 80/50 Ref. no. 00880
 Automatic overpressure shutter made of light grey plastic.



Weather protection grille
WSG 80/50 Ref. no. 00115
 Stable construction made of extruded aluminium profiles, natural colour anodised.



Multi-leaf damper for rectangular duct installation
JVK 80/50 Ref. no. 06916
 Frame casing with double-sided flanges, positioning mechanism outside of air flow. Electrical drive see STM, Accessories.



Fitting
FSK 80/50 Ref. no. 00842
 For cost-effective integration of rectangular duct fans in round duct systems with Ø 500 mm.



Flexible connector
VS 80/50 Ref. no. 05700
 Flexible rectangular duct connector with double-sided flange frame.



Counter flange
GF 80/50 Ref. no. 06925
 Flange frame made of galvanised steel sheet for connection to the rectangular duct.



Rectangular duct silencer
KSD 80/50 Ref. no. 08732
 For outlet and inlet side insertion in the rectangular duct system.



Rectangular duct air filter
KLF 80/50 Coarse 70%* 08670
KLF 80/50 ePM1 50%* 08654
 With large bag filter. Galvanised steel sheet casing with double-sided flanges.



Warm water heating element
WHR 2/80/50 Ref. no. 08795
WHR 4/80/50 Ref. no. 08796
 For installation in rectangular duct system.



Accessory details Page

Shutters and weather prot. grille	472, 553 ff.
Filters, heating elements and silencers	473 ff.
Universal control system, electronic controllers, speed potentiometer	605 ff.

* See product page 477 for detailed description.

KR EC 560



Note: Fig. similar. Use two safety arms.
Designed for the delivery of contaminated air.



SKR EC 560 – sound-insulated



Lowest noise levels for inlet side and case radiation with high performance density. Use in extract air and intake air systems with specific noise level requirements.



Dimensions KR EC 560

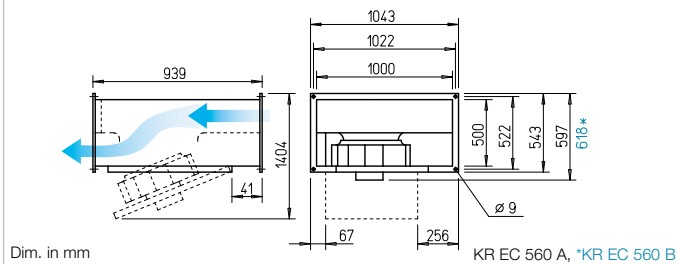

Dimensions SKR EC 560 – sound-insulated

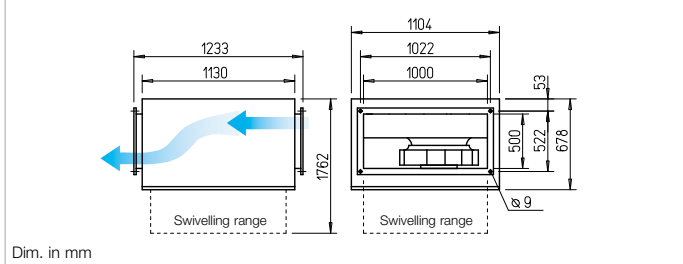

Features KR EC and SKR EC

- Highly efficient EC motor for the lowest operating costs.
- High-pressure and high-volume centrifugal fan with high efficiency.
- Particularly easy to service (cleaning) due to retractable motor-impeller unit.
- Easily accessible for cleaning and thus designed for the delivery of contaminated air.
- Linear throughflow.
- Compact design, convenient installation.

Description

- **Casing KR EC**
Made of galvanised steel sheet. Double-sided rectangular duct flange profiles (20 mm) for installation in rectangular duct system.

- **Casing SKR EC**
Like above, but with additional sound insulation cladding made of 50 mm thick mineral fibre boards. With a sound absorbing lining on the inside.

Special features SKR EC

- Lowest noise levels for inlet side and case radiation with high performance density.

Common features KR EC and SKR EC

- **Impeller**
Centrifugal, with backward curved blades (560 A made of aluminium and 560 B made of plastic). Aerodynamically optimised, inlet via nozzle.

- **Drive**
Energy-saving, speed-controllable external rotor EC motor in protection category IP44 (KRD EC 560/100/50 B and SKRD EC 560/100/50 B IP54) with highest level of efficiency. Ball bearing mounted, radio interference-free. Motor and impeller dynamically balanced.
- **Motor protection**
Integrated electronic temperature monitoring system for EC motor and electronics.
- **Power control**
Continuously variable speed control with potentiometer or continuously variable speed regulation with universal control system (see table). Performance levels are shown in the performance curve as an example.
- **Electrical connection**
Terminal box (IP54) mounted to external cable.
- **Installation**
Installation possible in any position. Note accessibility/swivel angle.
- **Noise**
The total level and range are specified above the performance diagram for:
 - Case-radiated sound power
 - Inlet side sound power
 - Outlet side sound power.
 The case-radiated noise as sound pressure at 4 m (free field conditions) is also specified in the type table and in the table below the performance curve.

Type	Ref. no.	Flow rate Free blowing	Rated speed	Sound press. case-radiation	Power con-sum.	Current con-sum.	Prot. cat.	Wiring diagram	Max. air flow temp.	Wgt net aprx.	Universal control system		Speed potentiometer		
											Type	Ref. no.	Type	Ref. no.	Type
Three-phase current, 3~, 400 V, 50/60 Hz, EC motor															
KRD EC 560/100/50 A	08167	9370	1540	50	1.81	2.80	IP44	1479	60	68.5	EUR EC ¹⁾²⁾ 01347	PU 10 ¹⁾ 01734	PA 10 ¹⁾ 01735		
KRD EC 560/100/50 B	08175	13480	1620	56	3.42	5.20	IP54	1005	60	81.0	EUR EC ¹⁾²⁾ 01347	PU 10 ¹⁾ 01734	PA 10 ¹⁾ 01735		
Sound-insulated SKR EC – Three-phase current, 3~, 400 V, 50/60 Hz, EC motor															
SKRD EC 560/100/50 A ³⁾	06130	9370	1540	47	1.81	2.80	IP44	1479	60	92.5	EUR EC ¹⁾²⁾ 01347	PU 10 ¹⁾ 01734	PA 10 ¹⁾ 01735		
SKRD EC 560/100/50 B	08180	13480	1620	52	3.29	5.10	IP54	1005	60	106.5	EUR EC ¹⁾²⁾ 01347	PU 10 ¹⁾ 01734	PA 10 ¹⁾ 01735		

¹⁾ Multiple EC fans can normally be connected. ²⁾ alternative electronic diff. pressure/ temperature controller (EDR/ETR, No. 01437/01438) or three level speed switch (SU/SA, No. 04266/04267), see Accessories. ³⁾ Performance diagram at www.HeliosSelect.de.

Performance curves KRD EC 560/100/50 A

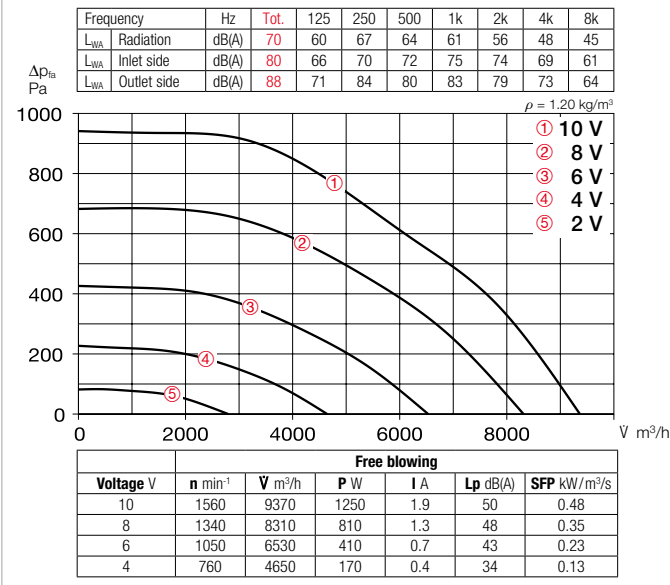

Performance curves KRD EC 560/100/50 B

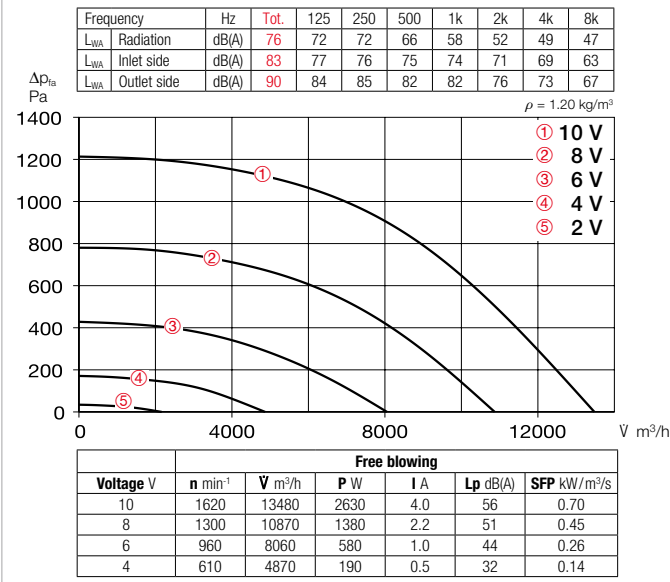

Performance curves SKRD EC 560/100/50 B

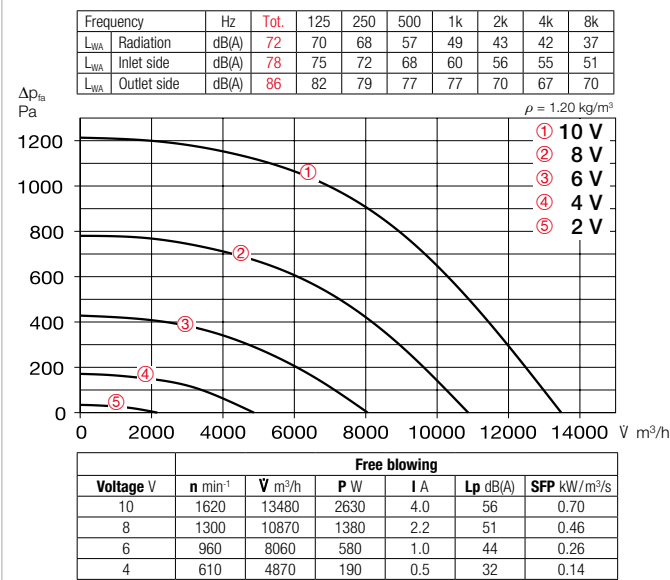

Accessories

External wall shutter
VK 100/50 Ref. no. 00881
 Automatic overpressure shutter made of light grey plastic.



Weather protection grille
WSG 100/50 Ref. no. 00116
 Stable construction made of extruded aluminium profiles, natural colour anodised.



Multi-leaf damper for rectangular duct installation
JVK 100/50 Ref. no. 06917
 Frame casing with double-sided flanges, positioning mechanism outside of air flow. Electrical drive see STM, Accessories.



Fitting
FSK 100/50 Ref. no. 00843
 For cost-effective integration of rectangular duct fans in round duct systems with Ø 500 mm.



Flexible connector
VS 100/50 Ref. no. 05701
 Flexible rectangular duct connector with double-sided flange frame.



Counter flange
GF 100/50 Ref. no. 06926
 Flange frame made of galvanised steel sheet for connection to the rectangular duct.



Rectangular duct silencer
KSD 100/50 Ref. no. 08733
 For outlet and inlet side insertion in the rectangular duct system.



Rectangular duct air filter
KLF 100/50 Coarse 70%* 08671
KLF 100/50 ePM2.5 65%* 08655
 With large bag filter. Galvanised steel sheet casing with double-sided flanges.



Warm water heating element
WHR 2/100/50 Ref. no. 08797
WHR 4/100/50 Ref. no. 08798
 For installation in rectangular duct system.



Accessory details Page

Shutters and weather prot. grille	472, 553 ff.
Filters, heating elements and silencers	473 ff.
Universal control system, electronic controllers, speed potentiometer	605 ff.

* See product page 477 for detailed description.

KR 180



Designed for the delivery of contaminated air.

KR 225



Designed for the delivery of contaminated air.

Dimensions KR 180

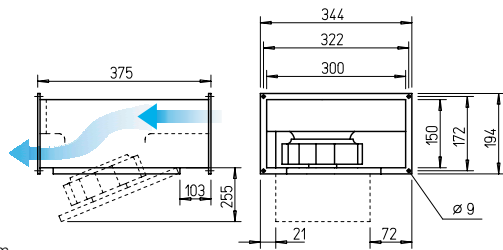

Dim. in mm

Dimensions KR 225

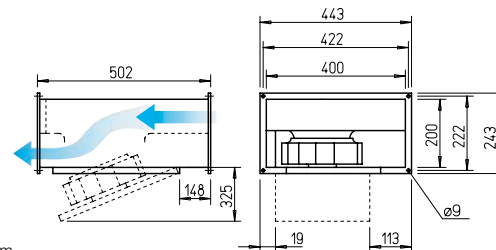

Dim. in mm

Centrifugal EC rectangular duct fans with backward curved impeller blades. Retractable motor-impeller unit.

- High-performance impellers with high efficiency.
- Use in extract air and intake air systems for the delivery of larger volume flows.
- Non-critical for the delivery of contaminated air.

Special features

- High-pressure and high-volume centrifugal fan with high efficiency.
- Particularly easy to service (cleaning) due to retractable motor-impeller unit.
- Easily accessible for cleaning and thus designed for the delivery of contaminated air.
- Compact design, low space requirement, linear rectangular duct throughflow.

Description

- **Casing**
Made of galvanised steel sheet. Double-sided rectangular duct flange profiles (20 mm) for installation in rectangular duct system.
- **Impeller**
Centrifugal, with backward curved blades made of plastic and galvanised steel. Aerodynamically optimised, inlet via nozzle.
- **Drive**
Through maintenance-free external rotor motor on which the impeller is mounted. Closed design. Protection category IP44. Winding with moisture proof coating. Ball bearing mounted, radio interference-free. Motor and impeller dynamically balanced.

■ **Motor protection**

Through built-in thermal contacts wired in series to the winding, automatically resetting.

■ **Power control**

Through voltage reduction using 5-step transformer or electronically (continuously variable). The performances at corresponding voltages are shown in the performance diagram.

■ **Electrical connection**

Terminal box (IP54) mounted to external cable.

■ **Installation**

Installation possible in any position. Note accessibility/swivelling range.

■ **Noise**

The total level and range are specified above the performance diagram for:

- Case-radiated sound power
 - Inlet side sound power
 - Outlet side sound power
- The inlet side sound power level is also specified above the control voltages in the performance diagram.
- The case-radiated noise as sound pressure at 4 m (free field conditions) is also specified in the type table.

Reference	Page
Selection table	429
Techn. description	428
Planning information	10 ff.
Modular system	426

Type	Ref. no.	Flow rate Free blowing	Rated speed	Sound press. case-radiation	Power consumption		Wiring diagram	Max. air flow temp. at		Wgt net approx.	Speed controller					
					kW	A		Rat. vol.	Control		kg	Transformer 5-step	surface-mount., electronic	flush-mount., electronic		
		V m³/h	min⁻¹	dB(A) in 4 m			No.	+ °C	+ °C		Type	Ref. no.	Type	Ref. no.	Type	Ref. no.
Single-phase alternating current, Capacitor motor, 230 V, 50 Hz, protection category IP44																
KRW 180/2/30/15	08885	540	2460	37	0.06	0.35	508	70	70	5.5	TSW 1.5	01495	ESA 1	00238	ESU 1	00236
KRW 225/2/40/20	08886	1020	2530	40	0.12	0.46	508	70	70	9.8	TSW 1.5	01495	ESA 1	00238	ESU 1	00236

Performance curves KRW 180/2/30/15

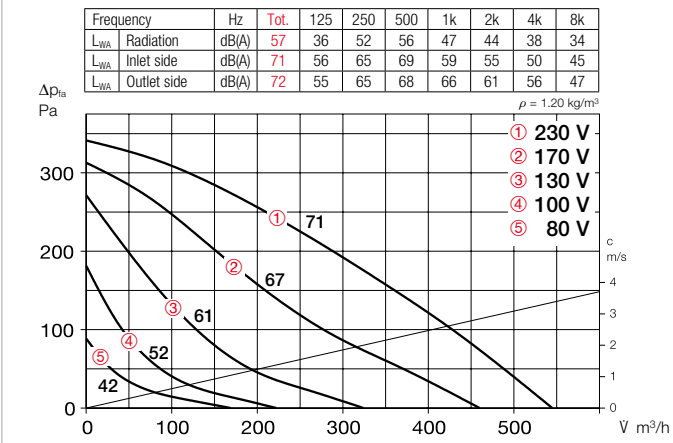

Performance curves KRW 225/2/40/20

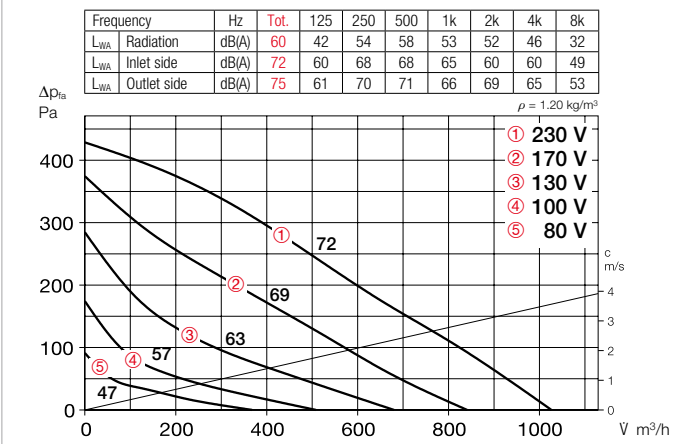

Accessory details Page

Shutters and weather prot. grille	472, 553 ff.
Filters, heating elements and silencers	473 ff.
Temperature control systems for heating elements	479, 484 f.
Speed controllers and motor protection circuit breakers	591 ff.

Accessories

External wall shutter

VK 30/15 Ref. no. 00735
VK 40/20 Ref. no. 00874

Automatic overpressure shutter made of light grey plastic.

Weather protection grille

WSG 30/15 Ref. no. 00108
WSG 40/20 Ref. no. 00109

Stable construction made of extruded aluminium profiles.

Multi-leaf damper for rectangular duct installation

JVK 30/15 Ref. no. 06927
JVK 40/20 Ref. no. 06910

With double-sided flanges. electrical drive see STM, Accessories.

Fitting

FSK 30/15 Ref. no. 00831
FSK 40/20 Ref. no. 00832

For integration of rectangular duct fans in round duct systems with Ø 160 or 200 mm.

Flexible connector

VS 30/15 Ref. no. 06928
VS 40/20 Ref. no. 05694

Flexible rectangular duct connector with double-sided flange frame.

Counter flange

GF 30/15 Ref. no. 06918
GF 40/20 Ref. no. 06919

Flange frame made of galvanised steel sheet for connection to the rectangular duct.

Rectangular duct silencer

KSD 40/20 Ref. no. 08728
For outlet and inlet side insertion in the rectangular duct system.

Rectangular duct air filter

KLF 40/20 Coarse 70%* 08720
KLF 40/20 ePM1 50%* 08644

With large bag filter. Galvanised steel sheet casing with double-sided flanges.

Electric heating element

EHR-K 6/40/20 No. 08702
EHR-K 15/40/20 No. 08703

Closed tubular heating element in galvanised steel sheet casing with double-sided connection flanges.

Temperature control system for electric heating element

EHSD 16 Ref. no. 05003

Warm water heating element

WHR 2/40/20 Ref. no. 08782
WHR 4/40/20 Ref. no. 08783

For installation in rectangular duct system.

Temperature control system for warm water heating element

WHS HE Ref. no. 08319



Rectangular duct fans

* See product page 477 for detailed description.

KR 225



Designed for the delivery of contaminated air.

Dimensions KR 225

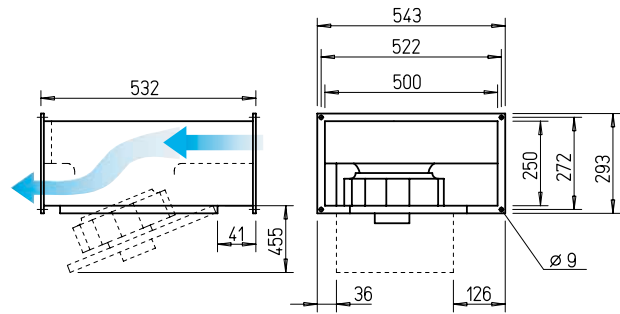

Dim. in mm

Radial rectangular duct fans with backward curved impeller blades. Retractable motor-impeller unit.

- High-performance impellers with high efficiency.
- Use in extract air and intake air systems for the delivery of larger volume flows.
- Non-critical for the delivery of contaminated air.

Special features

- High-pressure and high-volume centrifugal fan with high efficiency.
- Particularly easy to service (cleaning) due to retractable motor-impeller unit.
- Easily accessible for cleaning and thus designed for the delivery of contaminated air.
- Linear throughflow.
- Compact design, convenient installation.

Description

- **Casing**
Made of galvanised steel sheet. Double-sided rectangular duct flange profiles (20 mm) for installation in rectangular duct system.
- **Impeller**
Centrifugal, with backward curved blades made of plastic. Aerodynamically optimised, inlet via nozzle.
- **Drive**
Through maintenance-free external rotor motor on which the impeller is mounted. Closed design. Protection category IP44. Winding with moisture proof coating. Ball bearing mounted, radio interference-free. Motor and impeller dynamically balanced.
- **Motor protection**
Through built-in thermal contacts wired in series to the winding, automatically resetting.
- **Power control**
Through voltage reduction using 5-step transformer or electronically (continuously variable). The performances at corresponding voltages are shown in the performance diagram.

■ **Electrical connection**

Terminal box (IP54) mounted to external cable.

■ **Installation**

Note accessibility/swivel angle. May only be installed with the inspection panel at the bottom or at the side.

■ **Noise**

The total level and range are specified above the performance diagram for:

- Case-radiated sound power
- Inlet side sound power
- Outlet side sound power

The inlet side sound power level is also specified above the control voltages in the performance diagram.

- The case-radiated noise as sound pressure at 4 m (free field conditions) is also specified in the type table.

■ **Reference**

Page

Selection table	429
Techn. description	428
Planning information	10 ff.
Modular system	426

Type	Ref. no.	Flow rate Free blowing	Rated speed	Sound press. case-radiation	Power consumption		Wiring diagram	Max. air flow temp. at		Wgt net aprx.	Speed controller					
					kW	A		Rat. vol.	Control		Transformer 5-step	surface-mount., electronic	flush-mount., elec- tronic			
		V m³/h	min ⁻¹	dB(A) in 4 m			No.	+ °C	+ °C	kg	Type	Ref. no.	Type	Ref. no.	Type	Ref. no.
Single-phase alternating current, Capacitor motor, 230 V, 50 Hz, protection category IP44																
KRW 225/2/50/25	08873	1160	2680	45	0.17	0.73	508	70	60	15.0	TSW 1.5	01495	ESA 1	00238	ESU 1	00236

Performance curves KRW 225/2/50/25

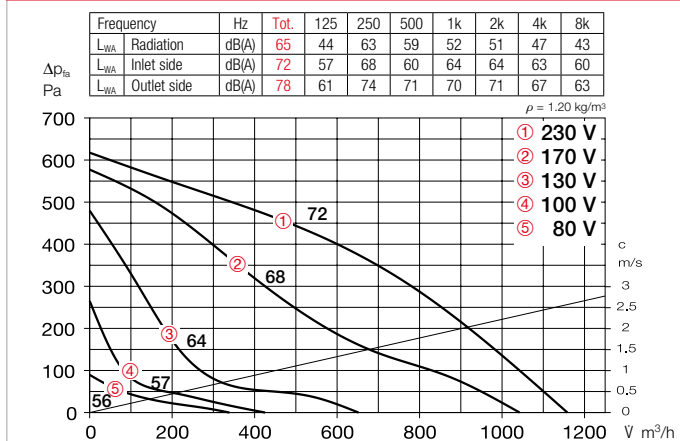

Accessory details Page

Shutters and weather prot. grille	472, 553 ff.
Filters, heating elements and silencers	473 ff.
Temperature control systems for heating elements	479, 484 f.
Speed controllers and motor protection circuit breakers	591 ff.

Accessories

External wall shutter

VK 50/25 Ref. no. 00875

Automatic overpressure shutter made of light grey plastic.



Weather protection grille

WSG 50/25 Ref. no. 00110

Stable construction made of extruded aluminium profiles, natural colour anodised.



Multi-leaf damper for rectangular duct installation

JVK 50/25 Ref. no. 06911

Frame casing with double-sided flanges, positioning mechanism outside of air flow. Electrical drive see STM, Accessories.



Fitting

FSK 50/25 Ref. no. 00833

For integration of rectangular duct fans in round duct systems with Ø 250 mm.



Flexible connector

VS 50/25 Ref. no. 05695

Flexible rectangular duct connector with double-sided flange frame.



Counter flange

GF 50/25 Ref. no. 06920

Flange frame made of galvanised steel sheet for connection to the rectangular duct.



Rectangular duct silencer

KSD 50/25-30 Ref. no. 08729

For outlet and inlet side insertion in the rectangular duct system.



Rectangular duct air filter

KLF 50/25-30 Coarse 70%* 08721

KLF 50/25-30 ePM1 50%* 08645

With large bag filter. Galvanised steel sheet casing with double-sided flanges.



Electric heating element

EHR-K 8/50/25-30 No. 08704

EHR-K 24/50/25-30 No. 08705

Closed tubular heating element in galvanised steel sheet casing with double-sided connection flanges.



Temperature control system for electric heating element

EHSD 16 Ref. no. 05003



Warm water heating element

WHR 2/50/25-30 No. 08784

WHR 4/50/25-30 No. 08785

For installation in rectangular duct system.



Temperature control system for warm water heating element

WHS HE Ref. no. 08319



* See product page 477 for detailed description.

KR 355



Designed for the delivery of contaminated air.

SKR 355 – sound-insulated



Lowest noise levels for inlet side and case radiation with high performance density. Use in extract air and intake air systems with specific noise level requirements.

Dimensions KR 355

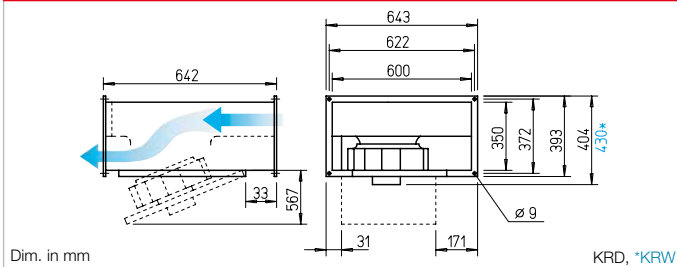

Dimensions SKR 355 – sound-insulated

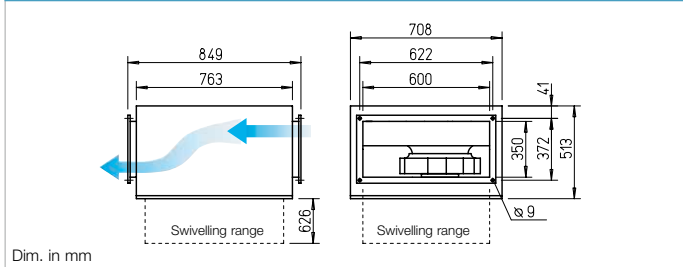

Features KR and SKR

- High-pressure and high-volume centrifugal fan with high efficiency.
- Particularly easy to service (cleaning) due to retractable motor-impeller unit.
- Easily accessible for cleaning and thus designed for the delivery of contaminated air.
- Linear throughflow.
- Compact design, convenient installation.

Special features SKR

- Lowest noise levels for inlet side and case radiation with high performance density.

Description

- **Casing KR**
Made of galvanised steel sheet. Double-sided rectangular duct flange profiles (20 mm) for installation in rectangular duct system.
- **Casing SKR**
Like above, but with additional sound insulation cladding made of 50 mm thick mineral fibre boards. With a sound absorbing lining on the inside.

Common features KR and SKR

- **Impeller**
Centrifugal, with backward curved blades made of plastic. Aerodynamically optimised, inlet via nozzle.

■ **Drive**

Through maintenance-free external rotor motor on which the impeller is mounted. Closed design, protection category IP54. Winding with moisture proof coating. Ball bearing mounted, radio interference-free. Motor and impeller dynamically balanced.

■ **Motor protection**

Through built-in thermal contacts via triggering device (Accessories).

■ **Power control**

Through voltage reduction using 5-step transformer or electronically (continuously variable). The performances at corresponding voltages are shown in the performance diagram.

■ **Electrical connection**

Terminal box (IP54) mounted to external cable.

■ **Installation**

Installation possible in any position. Note accessibility/swivelling range.

■ **Noise**

The total level and range are specified above the performance diagram for:

- Case-radiated sound power
- Inlet side sound power
- Outlet side sound power

The inlet side sound power level is also specified above the control voltages in the performance diagram.

- The case-radiated noise as sound pressure at 4 m (free field conditions) is also specified in the type table.

Type	Ref. no.	Flow rate	Rated speed	Sound press.	Power consumption		Wiring diagram	Max. air flow temp. at		Wgt net aprx.	Speed controller 5-step with motor protection circuit breaker		Motor protection circuit breaker for connection of built-in thermal contacts	
		Free blowing		case-radiation	kW	A		Rat. vol.	Control		kg	Type	Ref. no.	Type
		∑ m³/h	min ⁻¹	dB(A) in 4 m			No.	+ °C	+ °C		Type	Ref. no.	Type	Ref. no.
Single-phase alternating current, 230 V, 50 Hz, Capacitor motor, protection category IP54														
KRW 355/4/60/35	08692	3600	1390	42	0.37	1.90	536.1	60	60	28.4	MWS 3	01948	MW	01579
Three-phase current motor, 230/400 V, 50 Hz, protection category IP54														
KRD 355/4/60/35	08584	2840	1330	37	0.25	0.80/0.46	860	60	60	27.2	RDS 1	01314	MD	05849
Sound-insulated SKR – Single-phase alternating current, 230 V, 50 Hz, Capacitor motor, protection category IP54														
SKRW 355/4/60/35	08681	3580	1400	39	0.35	1.82	536.1	60	60	48.8	MWS 3	01948	MW	01579
Sound-insulated SKR – Three-phase current motor, 230/400 V, 50 Hz, protection category IP54														
SKRD 355/4/60/35	08181	2800	1330	34	0.24	0.78/0.45	860	60	60	49.0	RDS 1	01314	MD	05849

Performance curves KRW 355/4/60/35

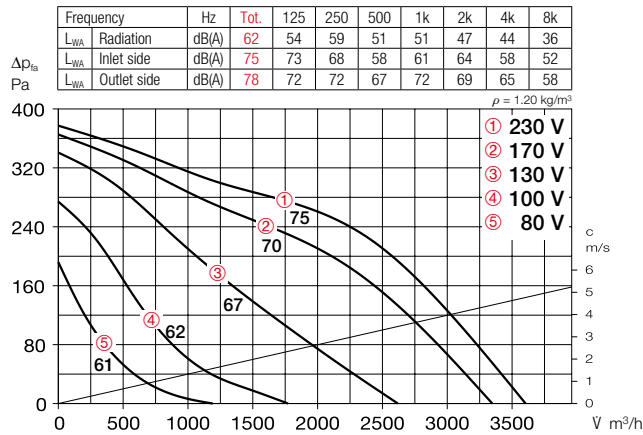

Performance curves KRD 355/4/60/35

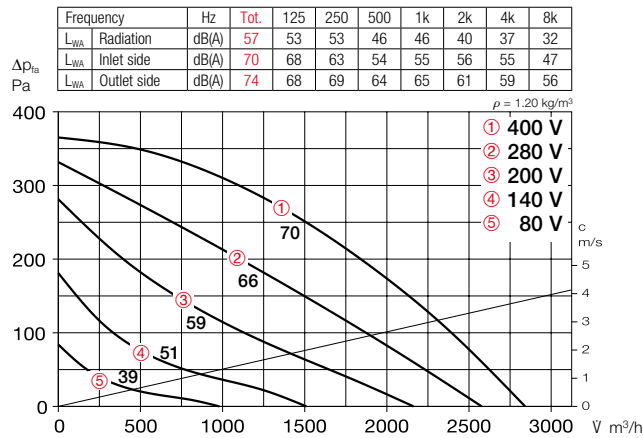

Performance curves SKRW 355/4/60/35

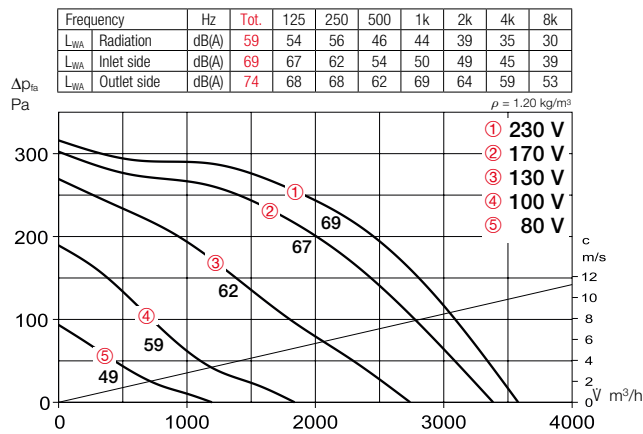

Performance curves SKRD 355/4/60/35

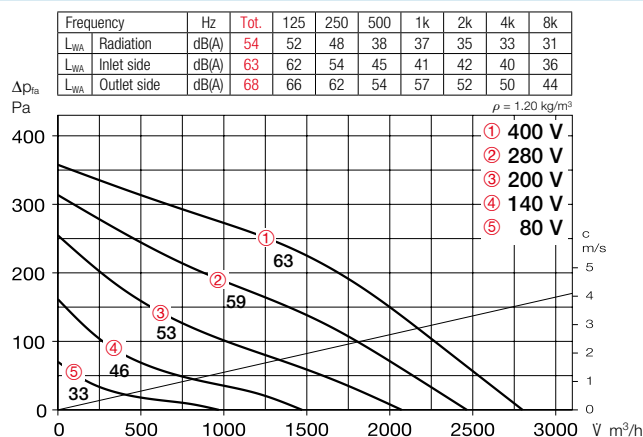

Accessories

External wall shutter
VK 60/35 Ref. no. 00878
 Automatic overpressure shutter made of light grey plastic.



Weather protection grille
WSG 60/35 Ref. no. 00113
 Stable construction made of extruded aluminium profiles, natural colour anodised.



Multi-leaf damper for rectangular duct installation
JVK 60/35 Ref. no. 06914
 Frame casing with double-sided flanges, positioning mechanism outside of air flow. Electrical drive see STM, Accessories.



Fitting
FSK 60/35 Ref. no. 00835
 For cost-effective integration of rectangular duct fans in round duct systems with Ø 355 mm.



Flexible connector
VS 60/35 Ref. no. 05698
 Flexible rectangular duct connector with double-sided flange frame.



Counter flange
GF 60/35 Ref. no. 06923
 Flange frame made of galvanised steel sheet for connection to the rectangular duct.



Rectangular duct silencer
KSD 60/30-35 Ref. no. 08730
 For outlet and inlet side insertion in the rectangular duct system.



Rectangular duct air filter
KLF 60/30-35 Coarse 70%* 08722
KLF 60/30-35 ePM2.5 65%* 08646
 With large bag filter. Galvanised steel sheet casing with double-sided flanges.



Electric heating element
EHR-K 15/60/30-35 No. 08706
EHR-K 30/60/30-35 No. 08707
 Closed tubular heating element in galvanised steel sheet casing with double-sided connection flanges.



Temperature control system for electric heating element
EHSD 16 Ref. no. 05003



Warm water heating element
WHR 2/60/30-35 No. 08786
WHR 4/60/30-35 No. 08787
 For installation in rectangular duct system.



Temperature control system for warm water heating element
WHS HE¹⁾ Ref. no. 08319



¹⁾ With heat output reduced to 2200 l/h for Type WHR 4/60/30-35.

* See product page 477 for detailed description.

KR 400/450/500



Designed for the delivery of contaminated air.

SKR 400/450/500 – sound-insulated



Lowest noise levels for inlet side and case radiation with high performance density. Use in extract air and intake air systems with specific noise level requirements.

Dimensions KR 400/450/500

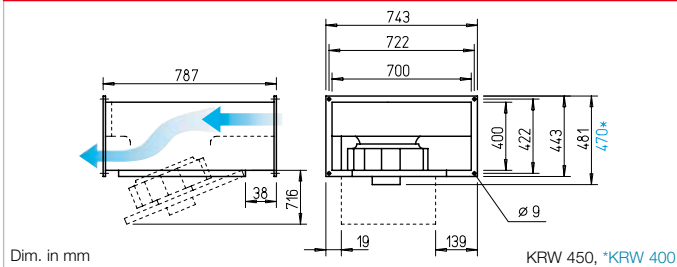

Dimensions SKR 400/450/500 – sound-insulated

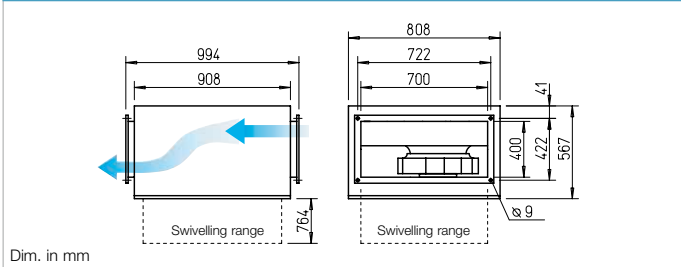

Features KR and SKR

- High-pressure and high-volume centrifugal fan with high efficiency.
- Particularly easy to service (cleaning) due to retractable motor-impeller unit.
- Easily accessible for cleaning and thus designed for the delivery of contaminated air.
- Linear throughflow.
- Compact design, convenient installation.

Description

- Casing KR**
Made of galvanised steel sheet. Double-sided rectangular duct flange profiles (20 mm) for installation in rectangular duct system.
- Casing SKR**
Like above, but with additional sound insulation cladding made of 50 mm thick mineral fibre boards. With a sound absorbing lining on the inside.

Special features SKR

- Lowest noise levels for inlet side and case radiation with high performance density.

Common features KR and SKR

- Impeller**
Centrifugal, with backward curved blades made of plastic. Aerodynamically optimised, inlet via nozzle.

Drive

Through maintenance-free external rotor motor on which the impeller is mounted. Closed design, protection category IP54. Winding with moisture proof coating. Ball bearing mounted, radio interference-free. Motor and impeller dynamically balanced.

Motor protection

Through built-in thermal contacts via triggering device (Accessories).

Power control

Through voltage reduction using 5-step transformer or electronically (continuously variable). The performances at corresponding voltages are shown in the performance diagram.

Electrical connection

Terminal box (IP54) mounted to external cable.

Installation

Installation possible in any position. Note accessibility/swivelling range.

Noise

The total level and range are specified above the performance diagram for:

- Case-radiated sound power
- Inlet side sound power
- Outlet side sound power. The inlet side sound power level is also specified above the control voltages in the performance diagram.
- The case-radiated noise as sound pressure at 4 m (free field conditions) is also specified in the type table.

Type	Ref. no.	Flow rate Free blowing	Rated speed	Sound press. case-radiation	Power consumption	Wiring diagram	Max. air flow temp. at	Wgt net appr.	Speed controller 5-step with motor protection circuit breaker	Motor protection circuit breaker for connection of built-in thermal contacts				
		V m³/h	min⁻¹	dB(A) in 4 m	kW	A	Rat. vol. + °C	Control + °C	kg	Type	Ref. no.	Type	Ref. no.	
Single-phase alternating current, 230 V, 50 Hz, Capacitor motor, protection category IP54														
KRW 400/4/70/40	06150	4970	1320	44	0.57	2.60	536.1	60	60	39.0	MWS 5	01949	MW	01579
KRW 450/4/70/40	06151	6650	1390	51	1.04	4.80	536.1	60	60	38.7	MWS 7.5	01950	MW	01579
Three-phase current motor, 230/400 V, 50 Hz, protection category IP54														
KRD 450/4/70/40 ¹⁾	08694	5830	1430	47	0.82	2.80/1.60	860	60	40	48.5	RDS 4	01316	MD	05849
Sound-insulated SKR – Single-phase alternating current, 230 V, 50 Hz, Capacitor motor, protection category IP54														
SKRW 400/4/70/40	06143	4940	1330	42	0.53	2.40	536.1	60	60	62.0	MWS 5	01949	MW	01579
Sound-insulated SKR – Three-phase current motor, 230/400 V, 50 Hz, protection category IP54														
SKRD 450/4/70/40	08196	5430	1430	46	0.82	2.70/1.60	860	60	40	69.3	RDS 4	01316	MD	05849
SKRD 500/6/70/40 ¹⁾	08197	4620	920	36	0.40	1.40/0.82	860	60	60	64.1	RDS 2	01315	MD	05849

1) Performance diagram at www.HeliosSelect.de. 2) Dimensional drawing at www.HeliosSelect.de.

Performance curves KRW 400/4/70/40

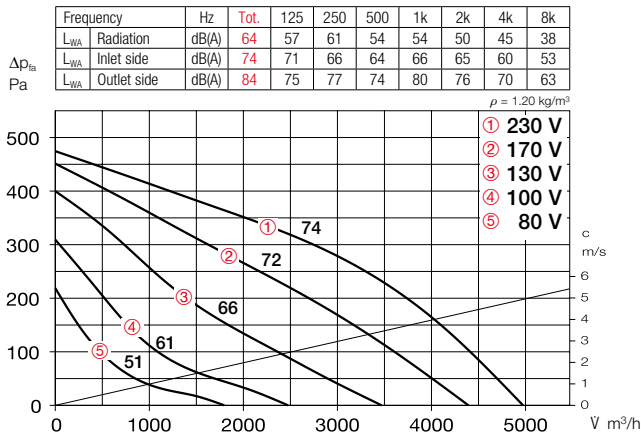

Performance curves KRW 450/4/70/40

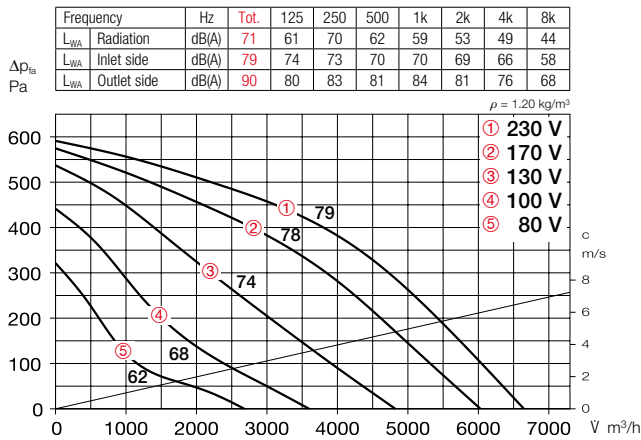

Performance curves SKRW 400/4/70/40

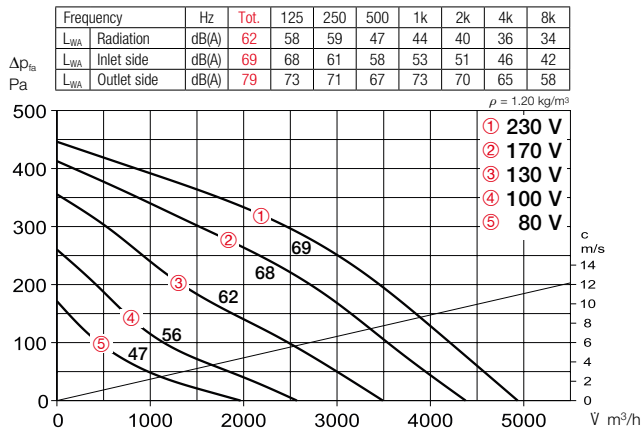

Performance curves SKRD 450/4/70/40

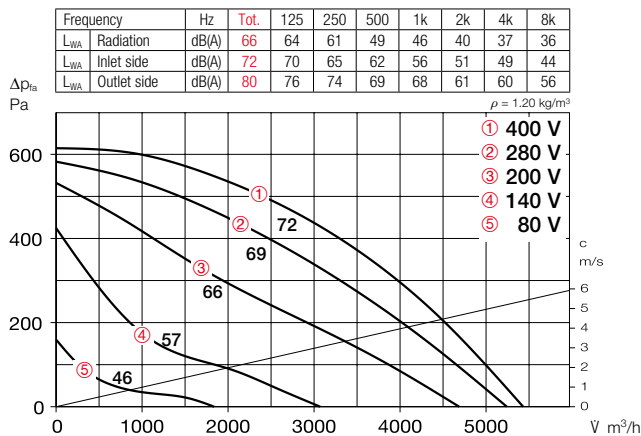

Accessories

External wall shutter
VK 70/40 Ref. no. 00879
 Automatic overpressure shutter made of light grey plastic.

Weather protection grille
WSG 70/40 Ref. no. 00114
 Stable construction made of extruded aluminium profiles, natural colour anodised.

Multi-leaf damper for rectangular duct installation
JVK 70/40 Ref. no. 06915
 Frame casing with double-sided flanges, positioning mechanism outside of air flow. Electrical drive see STM, Accessories.

Fitting
FSK 70/40 Ref. no. 00840
 For cost-effective integration of rectangular duct fans in round duct systems with Ø 400 mm.

Flexible connector
VS 70/40 Ref. no. 05699
 Flexible rectangular duct connector with double-sided flange frame.

Counter flange
GF 70/40 Ref. no. 06924
 Flange frame made of galvanised steel sheet for connection to the rectangular duct.

Rectangular duct silencer
KSD 70/40 Ref. no. 08731
 For outlet and inlet side insertion in the rectangular duct system.

Rectangular duct air filter
KLF 70/40 Coarse 70%* 08723
KLF 70/40 ePM1 50%* 08647
 With large bag filter. Galvanised steel sheet casing with double-sided flanges.

Warm water heating element
WHR 2/70/40 Ref. no. 08788
WHR 4/70/40 Ref. no. 08789
 For installation in rectangular duct system.

Temperature control system for warm water heating element
WHS HE¹⁾ Ref. no. 08319
¹⁾ With heat output reduced to 2200 l/h for Type WHR 4/70/40.



Rectangular duct fans

Accessory details	Page
Shutters and weather prot. grille	472, 553 ff.
Filters, heating elements and silencers	473 ff.
Temperature control systems for heating elements	479, 484 f.
Speed controllers and motor protection circuit breakers	591 ff.

* See product page 477 for detailed description.

KR 500



Designed for the delivery of contaminated air.

SKR 500 – sound-insulated



Lowest noise levels for inlet side and case radiation with high performance density. Use in extract air and intake air systems with specific noise level requirements.

Dimensions KR 500

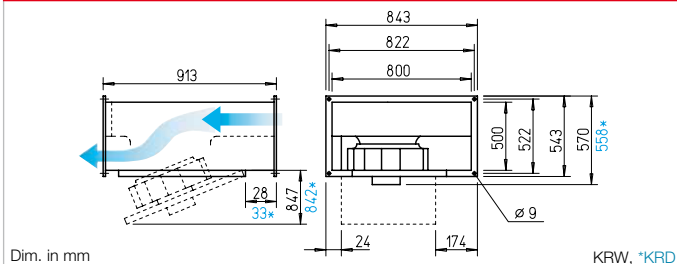

Dimensions SKR 500 – sound-insulated

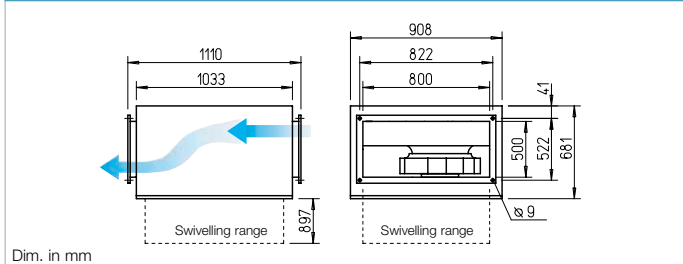

Features KR and SKR

- High-pressure and high-volume centrifugal fan with high efficiency.
- Particularly easy to service (cleaning) due to retractable motor-impeller unit.
- Easily accessible for cleaning and thus designed for the delivery of contaminated air.
- Linear throughflow.
- Compact design, convenient installation.

Special features SKR

- Lowest noise levels for inlet side and case radiation with high performance density.

Description

■ **Casing KR**
Made of galvanised steel sheet. Double-sided rectangular duct flange profiles (20 mm) for installation in rectangular duct system.

■ **Casing SKR**
Like above, but with additional sound insulation cladding made of 50 mm thick mineral fibre boards. With a sound absorbing lining on the inside.

Common features KR and SKR

■ **Impeller**
Centrifugal, with backward curved blades made of plastic. Aerodynamically optimised, inlet via nozzle.

■ **Drive**

Through maintenance-free external rotor motor on which the impeller is mounted. Closed design, protection category IP54. Winding with moisture proof coating. Ball bearing mounted, radio interference-free. Motor and impeller dynamically balanced.

■ **Motor protection**

Through built-in thermal contacts via triggering device (Accessories).

■ **Power control**

Through voltage reduction using 5-step transformer or electronically (continuously variable). The performances at corresponding voltages are shown in the performance diagram.

■ **Electrical connection**

Terminal box (IP54) mounted to external cable.

■ **Installation**

Installation possible in any position. Note accessibility/swivelling range.

■ **Noise**

The total level and range are specified above the performance diagram for:

- Case-radiated sound power
- Inlet side sound power
- Outlet side sound power

The inlet side sound power level is also specified above the control voltages in the performance diagram.

- The case-radiated noise as sound pressure at 4 m (free field conditions) is also specified in the type table.

Type	Ref. no.	Flow rate	Rated speed	Sound press. case-radiation	Power consumption		Wiring diagram	Max. air flow temp. at		Wgt net appr.	Speed controller 5-step with motor protection circuit breaker		Motor protection circuit breaker for connection of built-in thermal contacts	
		V m³/h	min⁻¹	dB(A) in 4 m	kW	A		Rat. vol.	Control		kg	Type	Ref. no.	Type
Single-phase alternating current, 230 V, 50 Hz, Capacitor motor, protection category IP54														
KRW 500/4/80/50	06152	9700	1370	52	1.55	6.80	536.1	60	60	66.9	MWS 10	01946	MW	01579
Three-phase current motor, 230/400 V, 50 Hz, protection category IP54														
KRD 500/4/80/50 A	08643	8430	1360	52	1.21	4.70/2.70	860	60	60	64.2	RDS 7	01578	MD	05849
Sound-insulated SKR – Three-phase current motor, 230/400 V, 50 Hz, protection category IP54														
SKRD 500/4/80/50	08198	8050	1360	48	1.19	4.60/2.70	860	60	60	89.2	RDS 7	01578	MD	05849

Performance curves KRW 500/4/80/50

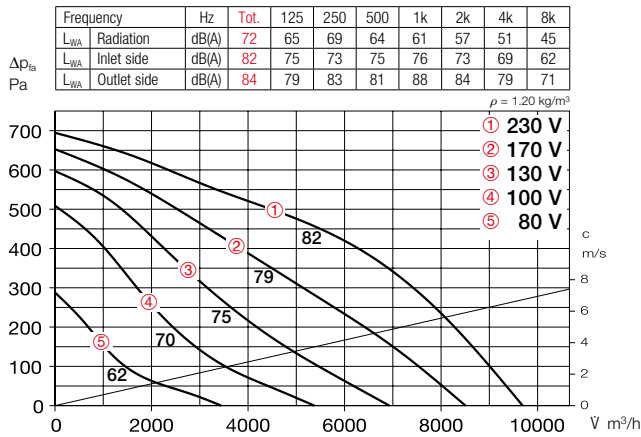

Performance curves KRD 500/4/80/50 A

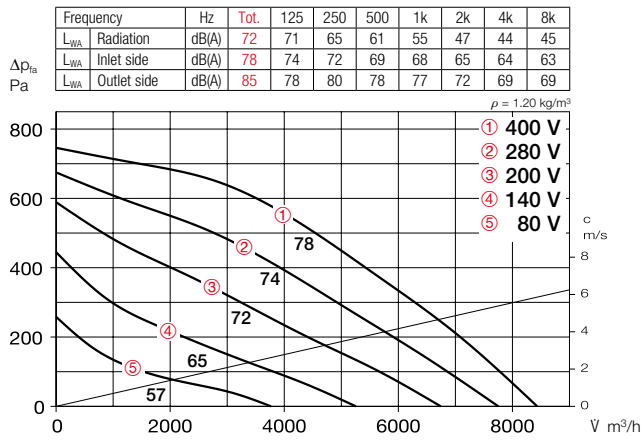

Performance curves SKRD 500/4/80/50

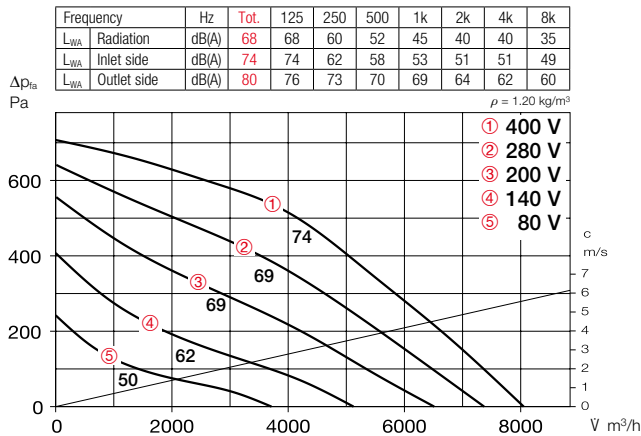

Accessories

External wall shutter
VK 80/50 Ref. no. 00880
 Automatic overpressure shutter made of light grey plastic.



Weather protection grille
WSG 80/50 Ref. no. 00115
 Stable construction made of extruded aluminium profiles, natural colour anodised.



Multi-leaf damper for rectangular duct installation
JVK 80/50 Ref. no. 06916
 Frame casing with double-sided flanges, positioning mechanism outside of air flow. Electrical drive see STM, Accessories.



Fitting
FSK 80/50 Ref. no. 00842
 For cost-effective integration of rectangular duct fans in round duct systems with Ø 500 mm.



Flexible connector
VS 80/50 Ref. no. 05700
 Flexible rectangular duct connector with double-sided flange frame.



Counter flange
GF 80/50 Ref. no. 06925
 Flange frame made of galvanised steel sheet for connection to the rectangular duct.



Rectangular duct silencer
KSD 80/50 Ref. no. 08732
 For outlet and inlet side insertion in the rectangular duct system.



Rectangular duct air filter
KLF 80/50 Coarse 70%* 08670
KLF 80/50 ePM1 50%* 08654
 With large bag filter. Galvanised steel sheet casing with double-sided flanges.



Warm water heating element
WHR 2/80/50 Ref. no. 08795
WHR 4/80/50 Ref. no. 08796
 For installation in rectangular duct system.



Accessory details Page

Shutters and weather prot. grille	472, 553 ff.
Filters, heating elements and silencers	473 ff.
Speed controllers and motor protection circuit breakers	591 ff.

* See product page 477 for detailed description.

KR 560



Designed for the delivery of contaminated air.

SKR 560 – sound-insulated



Lowest noise levels for inlet side and case radiation with high performance density. Use in extract air and intake air systems with specific noise level requirements.

Dimensions KR 560

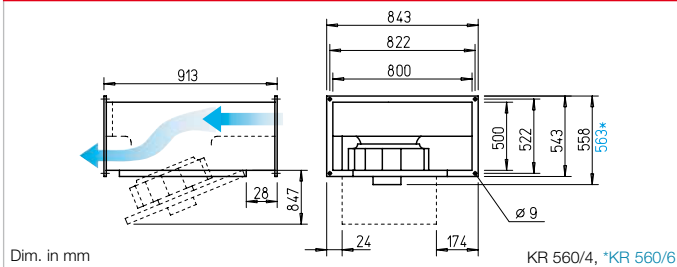

Dimensions SKR 560 – sound-insulated

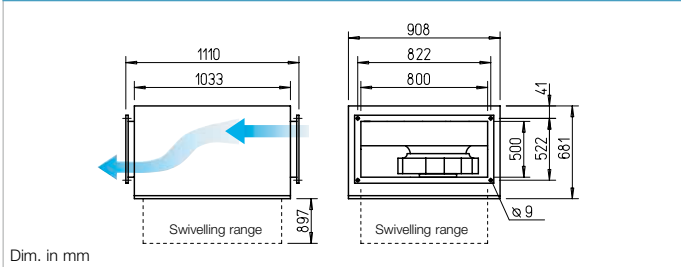

Features KR and SKR

- High-pressure and high-volume centrifugal fan with high efficiency.
- Particularly easy to service (cleaning) due to retractable motor-impeller unit.
- Easily accessible for cleaning and thus designed for the delivery of contaminated air.
- Linear throughflow.
- Compact design, convenient installation.

Special features SKR

- Lowest noise levels for inlet side and case radiation with high performance density.

Description

■ **Casing KR**
Made of galvanised steel sheet. Double-sided rectangular duct flange profiles (20 mm) for installation in rectangular duct system.

■ **Casing SKR**
Like above, but with additional sound insulation cladding made of 50 mm thick mineral fibre boards. With a sound absorbing lining on the inside.

Common features KR and SKR

■ **Impeller**
Centrifugal, with backward curved blades made of plastic. Aerodynamically optimised, inlet via nozzle.

■ **Drive**

Through maintenance-free external rotor motor on which the impeller is mounted. Closed design, protection category IP54. Winding with moisture proof coating. Ball bearing mounted, radio interference-free. Motor and impeller dynamically balanced.

■ **Motor protection**

Through built-in thermal contacts via triggering device (Accessories).

■ **Power control**

Through voltage reduction using 5-step transformer or electronically (continuously variable). The performances at corresponding voltages are shown in the performance diagram.

■ **Electrical connection**

Terminal box (IP54) mounted to external cable.

■ **Installation**

Installation possible in any position. Note accessibility/swivelling range.

■ **Noise**

The total level and range are specified above the performance diagram for:

- Case-radiated sound power
 - Inlet side sound power
 - Outlet side sound power
- The inlet side sound power level is also specified above the control voltages in the performance diagram.
- The case-radiated noise as sound pressure at 4 m (free field conditions) is also specified in the type table.

Type	Ref. no.	Flow rate	Rated speed	Sound press. case-radiation	Power consumption		Wiring diagram	Max. air flow temp. at		Wgt net appr.	Speed controller 5-step with motor protection circuit breaker		Motor protection circuit breaker for connection of built-in thermal contacts	
		Free blowing	min ⁻¹	dB(A) in 4 m	kW	A		Rat. vol.	Control		kg	Type	Ref. no.	Type
Three-phase current motor, 230/400 V, 50 Hz, protection category IP54														
KRD 560/6/80/50	08842	7460	880	41	0.64	2.50/1.40	860	60	60	61.9	RDS 2	01315	MD	05849
KRD 560/4/80/50	06147	11970	1350	55	2.33	7.80/4.50	860	45	45	64.1	RDS 7	01578	MD	05849
Sound-insulated SKR – Three-phase current motor, 230/400 V, 50 Hz, protection category IP54														
SKRD 560/6/80/50	08199	7600	880	36	0.66	2.50/1.50	860	60	60	86.9	RDS 2	01315	MD	05849

Performance curves KRD 560/6/80/50

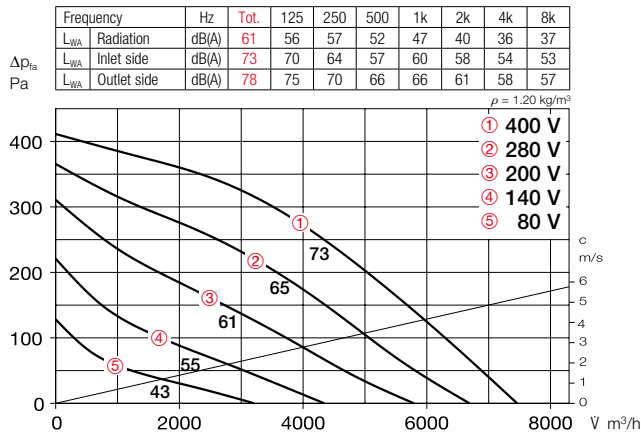

Performance curves KRD 560/4/80/50

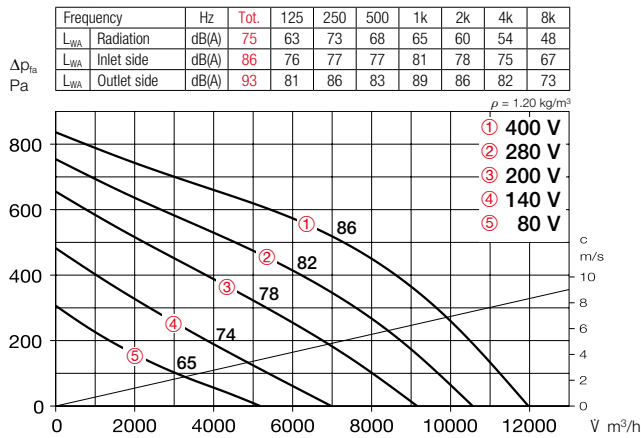

Performance curves SKRD 560/6/80/50

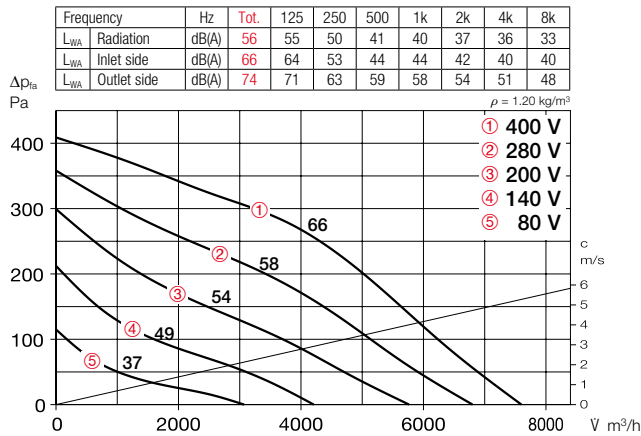

Accessories

External wall shutter
VK 80/50 Ref. no. 00880
 Automatic overpressure shutter made of light grey plastic.



Weather protection grille
WSG 80/50 Ref. no. 00115
 Stable construction made of extruded aluminium profiles, natural colour anodised.



Multi-leaf damper for rectangular duct installation
JVK 80/50 Ref. no. 06916
 Frame casing with double-sided flanges, positioning mechanism outside of air flow. Electrical drive see STM, Accessories.



Fitting
FSK 80/50 Ref. no. 00842
 For cost-effective integration of rectangular duct fans in round duct systems with Ø 500 mm.



Flexible connector
VS 80/50 Ref. no. 05700
 Flexible rectangular duct connector with double-sided flange frame.



Counter flange
GF 80/50 Ref. no. 06925
 Flange frame made of galvanised steel sheet for connection to the rectangular duct.



Rectangular duct silencer
KSD 80/50 Ref. no. 08732
 For outlet and inlet side insertion in the rectangular duct system.



Rectangular duct air filter
KLF 80/50 Coarse 70%* 08670
KLF 80/50 ePM1 50%* 08654
 With large bag filter. Galvanised steel sheet casing with double-sided flanges.



Warm water heating element
WHR 2/80/50 Ref. no. 08795
WHR 4/80/50 Ref. no. 08796
 For installation in rectangular duct system.



* See product page 477 for detailed description.

Accessory details	Page
Shutters and weather prot. grille	472, 553 ff.
Filters, heating elements and silencers	473 ff.
Speed controllers and motor protection circuit breakers	591 ff.

Reference	Page
Selection table	429
Techn. description	428
Planning information	10 ff.
Modular system	426

GF and VS

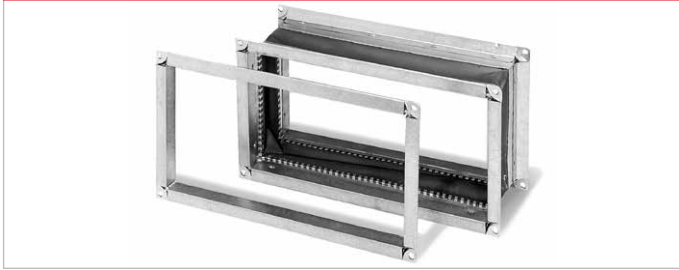

Dimensions GF and VS

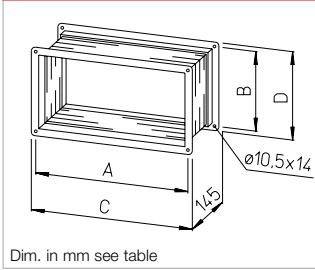

■ **Counter flange GF**

Flange frame made of galvanized steel sheet, which is dimensionally matched to the rectangular duct fans and their accessories, for rectangular duct connection.

■ **Connector VS**

Flexible rectangular duct connection with double-sided flange frame made of galvanized steel sheet and circumferential sealing lip; tightness according to VDI 3803, temperature resistance -10 °C to +80 °C. Central part made of elastic sleeve made of fabric. Dimensionally matched to the rectangular duct fans. In order to prevent structure-borne noise transmission and to compensate for installation tolerances, the connectors are mounted on the inlet side and outlet side between the fan and air duct.

Types VS Ex are available for explosion-proof rectangular duct fans.

Counter flange GF		Connector VS		Connector for explosion-proof fans		Compat. w/ fan rect. duct NS mm i.L.	Dimensions in mm				kW	
Type	Ref. no.	Type	Ref. no.	Type	Ref. no.		A	B	C	D	GF	VS
GF 30/15	06918	VS 30/15	06928	–	–	300 x 150	320	170	340	190	0.7	1.8
GF 40/20	06919	VS 40/20	05694	–	–	400 x 200	420	220	440	240	0.8	2.3
GF 50/25	06920	VS 50/25	05695	VS 50/25 Ex	00265	500 x 250	520	270	540	290	0.9	2.8
GF 50/30	06921	VS 50/30	05696	VS 50/30 Ex	00266	500 x 300	520	320	540	340	1.0	2.9
GF 60/30	06922	VS 60/30	05697	VS 60/30 Ex	00267	600 x 300	620	320	640	340	1.1	3.2
GF 60/35	06923	VS 60/35	05698	VS 60/35 Ex	00268	600 x 350	620	370	640	390	1.1	3.4
GF 70/40	06924	VS 70/40	05699	VS 70/40 Ex	00269	700 x 400	720	420	740	440	1.2	3.7
GF 80/50	06925	VS 80/50	05700	–	–	800 x 500	820	520	840	540	1.5	4.5
GF 100/50	06926	VS 100/50	05701	–	–	1000 x 500	1020	520	1040	540	1.7	5.0

JVK



Dimensions JVK

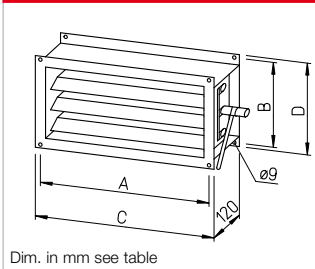

■ **Multi-leaf dampers JVK**

Frame casing with double-sided connection flanges made of galvanized steel sheet. Dimensionally matched to the rectangular duct fans. Blades designed as hollow parts. Axles mounted in plastic, synchronously adjustable with external adjusting lever. Adjusting mechanism also outside of the air flow and thus protected against malfunctions due to contamination. The multi-leaf dampers cause an additional pressure loss, which must be considered when dimensioning the system and can be seen in the adjacent diagram. Note the blade position. Only install with horizontal blade position.

Type	Ref. no.	Compat. w/ fan rect. duct NS mm i.L.	Rect. duct fan Ø mm	Dimensions in mm				Weight aprx. kg
				A	B	C	D	
JVK 30/15	06927	300 x 150	180	320	170	340	190	3.5
JVK 40/20	06910	400 x 200	200–250	420	220	440	240	4.0
JVK 50/25	06911	500 x 250	315	520	270	540	290	5.0
JVK 50/30	06912	500 x 300	250	520	320	540	340	6.0
JVK 60/30	06913	600 x 300	285	620	320	640	340	7.0
JVK 60/35	06914	600 x 350	315–400	620	370	640	390	7.2
JVK 70/40	06915	700 x 400	355–450	720	420	740	440	9.0
JVK 80/50	06916	800 x 500	400–500	820	520	840	540	11.7
JVK 100/50	06917	1000 x 500	450–630	1020	520	1040	540	13.5

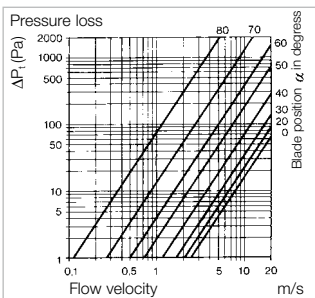

■ **Technical data**

Supply voltage	100–240 VAC
Frequency	50/60 Hz
Torque	10 Nm
Rotation angle	0 to 95°
Operation	2.5 W
Runtime (open/closed)	150 s
Clockwise/anticlockwise	switchable
Ambient temp.	-30 to +50 °C
Protection category	IP54
Protection class	II
Dim. mm	W 80 x H 124 x D 62
Weight approx.	0.75 kg
Wiring diagram no.	1087

STM 10 / STM 2P



■ **Accessories**

Shutter servomotor

STM 10 230 V Ref. no. 08791
Shutter servomotor for the electrical opening and closing of the shutters JVK. Installation in any position by attaching the terminal connections (for Ø 8–26 or □ 8–26 mm) and fixation with enclosed anti-twist catch. Shutter position adjustment possible by pressing the gear disengaging button. Two-position control with signal contacts in positions “open” and “closed”. Shutter position indicated on scale (0–95°).

Auxiliary switch

STM 2P Ref. no. 08794
The shutter servomotor STM 10 230 V can also be operated with an auxiliary switch module. Two adjustable micro switches indicate the switch position. The adjustable angle positions can be changed. Position indication via adjusting ring (mechanical, attachable).

Flexible and versatile. Helios components for air treatment.



Helios air treatment components provide for clean, warm and calm air – whether it be in round duct or rectangular duct ventilation systems.

The extensive range includes all sizes and capacities, perfectly tailored to Helios ventilation systems.

This provides the necessary flexibility for planning and installation.

■ Air filters

For wall and ceiling installation in various filter classes.

For installation in rectangular duct systems with double-sided connection flanges as well as air filter boxes in common standard pipe diameters.

474ff

■ Heating elements and temperature control systems

For a pleasant room air temperature, in finely graduated performance ranges.

Available in electric or warm water designs.

477ff

■ Silencers

In all sizes and designs, for installation in rectangular duct or round duct systems.

Made of galvanised steel sheet or flexible aluminium pipe.

486ff

Air filters for wall and ceiling installation LF



■ **Easy to install elements for effective solutions.**
The planned introduction of outside air is essential for efficient ventilation according to applicable regulations in most cases. The cleaning of supply air can now be regarded as an “absolute necessity”. Helios offers simple and effective elements for various installations.

■ **Accessories for air filters**
Complete installation set for monitoring pressure loss and thus the contamination of air filters. Suitable for DDC applications due to the gold-plated connection contacts. Applicable in measurement range 50–500 Pa, for ambient temperatures from –20 to + 85 °C and air flow temperatures from –20 to +85 °C.

Differential pressure switch
DDS Ref. no. 00445

■ **LF series**
For wall and ceiling installation
Elegant covering of ventilation openings. Volumetric flow rate from 200 to 4000 m³/h.



■ **LFBR**
Filter box for round duct connection
Installation in round duct system, for standard pipes from 100 to 400 mm Ø. Volumetric flow rate from 100 to 4000 m³/h.

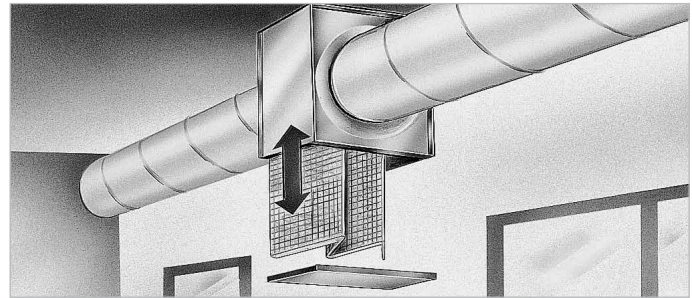

■ **KLF**
Rectangular duct air filter
For direct installation in the rectangular duct system. Dimensionally matched to rectangular duct fans. Volumetric flow rate up to 5000 m³/h.

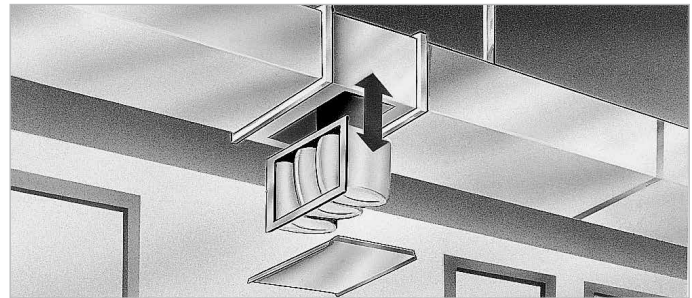

Air filter LF for wall and ceiling installation

■ Particularly suitable for the elegant coverage of fan and rectangular duct openings in walls and ceilings. Frame and fixed grille made of high-quality plastic, light grey. Full-surface filter mat through-flow. Large dimensioning reduces pressure loss and increases dust absorption.

■ **Filter mat** made of renewable synthetic fibre, class ISO Coarse 30% (G2), thermally bonded, 100 g/m², fire behaviour according to DIN 53438: F1. Dust absorption: 380 g/m².

■ **Installation** Dowel fix in any position via four concealed holes in the frame.

■ **Cleaning** Depending on the system, filter replacement is required if the initial pressure loss is exceeded by around 1.5-2 times. Remove filter mat after loosening the grille and clean both parts (e.g. in soap solution). Then replace and fix with the four plastic nuts.

■ **Replacement filter mats** In case of signs of degradation, which can occur after frequent cleaning, the filter mat must be replaced with a new one. See table for order information. Delivered in shipping units with 5 pcs each.

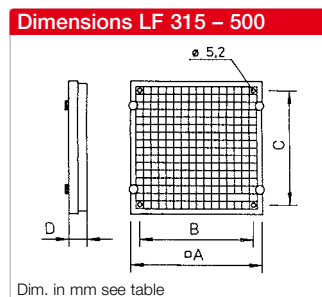
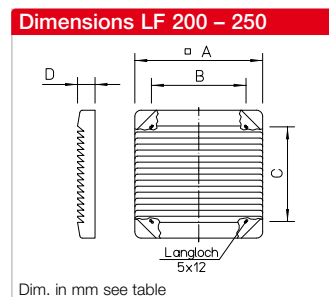
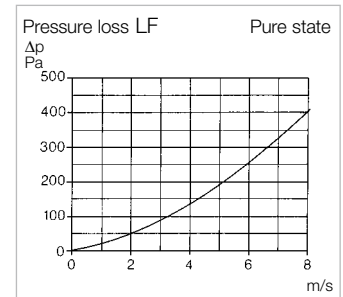

■ **Pressure loss**
Air filters create resistance according to the diagram above. This must be taken into account for fan dimensioning.

Type	Ref. no.	Compatible with fan nominal size	Maximum coverable opening	Dimensions				Weight aprx. kg	Replacement filter mats (shipping unit = 5 pcs)	
				A	B	C	D		Type	Ref. no.
LF 200*	00743	200	∅ 200	287	210	210	39.0	0.80	ELF 200*	00737
LF 250*	00744	250/280	∅ 300	337	240	240	39.0	1.00	ELF 250*	00738
LF 315*	00745	315	330 x 300	390	343	317	39.0	0.85	ELF 315*	00739
LF 355*	00746	355	380 x 350	440	393	367	39.0	0.95	ELF 355*	00740
LF 400*	00747	400	355 x 400	490	443	417	31.5	1.85	ELF 400*	00741
LF 500*	00748	450/500	475 x 450	540	493	467	31.5	2.25	ELF 500*	00742

*ISO Coarse 30% (G2)

KLF G4¹⁾, filter class ISO Coarse 70% (G4)

KLF F7^{2) 3)}, filter class ISO ePM₁ 50% (F7) and ISO ePM_{2.5} 65% (F7)

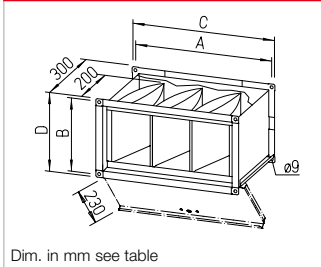
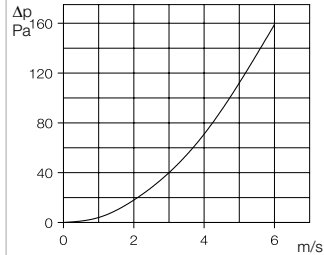
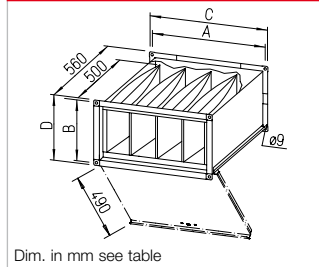
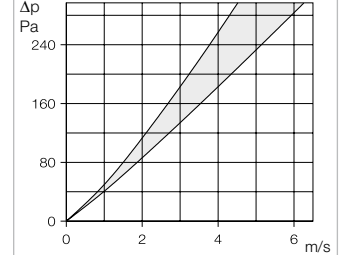
Dimensions KLF G4¹⁾

Pressure loss KLF G4¹⁾ Pure state

Dimensions KLF F7^{2) 3)}

Pressure loss KLF F7^{2) 3)} Pure state

Rectangular duct filter KLF

Air filter with double-sided connection flanges for installation in rectangular duct system.

■ Casing

Made of galvanised steel sheet. Hinged or removable cover using quick-release catches for filter removal.

■ Bag filter-cartridge

Filter frame in galvanised steel sheet. Large filter bags for high dust absorption.

Types KLF G4¹⁾ with filter class ISO Coarse 70% (G4), made of renewable synthetic fibre, heavily reinforced, 190 g/m². DIN 53438 F1, self-extinguishing. Dust absorption: 354 g/m².

Types KLF F7^{2) 3)} with filter class ISO ePM₁ 50% (F7) and ISO ePM_{2.5} 65% (F7), made of synthetic plastic, DIN 53438 F1, self-extinguishing. Dust absorption: 88.6 g/m².

■ Reference

The integration of air filters in class ISO ePM₁ 50% (F7) and ISO ePM_{2.5} 65% (F7) and differential pressure switches DDS (Ref. no. 00445) in intake air systems fulfils the requirements of VDI 6022.

■ Installation

Can be installed horizontally and vertically (air direction from top to bottom) in rectangular duct systems.

Allow clearance according to the specified dimension for filter removal. When space is limited, the cover can be removed without tools and with an opening angle > 45°.

■ Cleaning

Depending on the system, filter replacement is required if the initial pressure loss is exceeded by around 1.5-2 times.

The filter frame can be easily removed when the casing cover is open. Insert filter frame using guide after cleaning or replacement; the filter frame will be automatically pressed firmly against the casing seal by closing the cover.

■ Replacement filter cartridges

In case of signs of degradation, cleaning, the filter cartridge must be replaced with a new one. See table for order information.

■ Pressure loss

Air filters create resistance according to the diagrams above; the grey shaded area shows the resistances of the different sizes. These must be taken into account for fan dimensioning.

■ Accessories

Differential pressure switch

DDS Ref. no. 00445
Complete installation set for monitoring air filters.
Measurement range: 50–500 Pa.

Type	Ref. no.	Compatible w/ rect. duct fan NS cm	Dimensions				Weight aprx. kg	Replacement filter cartridges (shipping unit = 2 pcs)	
			A	B	C	D		Type	Ref. no.
Rectangular duct air filter KLF G4¹⁾, filter class ISO Coarse 70% (G4)									
KLF 40/20 Coarse 70%	08720	40/20	420	220	440	240	4.5	EKLF 40/20 Coarse 70%	08724
KLF 50/25-30 Coarse 70%	08721	50/25-30	520	270/320	540	340	6.0	EKLF 50/25-30 Coarse 70%	08725
KLF 60/30-35 Coarse 70%	08722	60/30-35	620	320/370	640	390	7.0	EKLF 60/30-35 Coarse 70%	08726
KLF 70/40 Coarse 70%	08723	70/40	720	420	740	440	8.5	EKLF 70/40 Coarse 70%	08727
KLF 80/50 Coarse 70%	08670	80/50	820	520	840	540	13.0	EKLF 80/50 Coarse 70%	08673
KLF 100/50 Coarse 70%	08671	100/50	1020	520	1040	540	15.0	EKLF 100/50 Coarse 70%	08674
Rectangular duct air filter KLF F7^{2) 3)}, filter class ISO ePM₁ 50% (F7) and ISO ePM_{2.5} 65% (F7)									
KLF 40/20 ePM1 50%	08644	40/20	420	220	440	240	6.5	EKLF 40/20 ePM1 50%	08635
KLF 50/25-30 ePM1 50%	08645	50/25-30	520	270/320	540	340	8.5	EKLF 50/25-30 ePM1 50%	08636
KLF 60/30-35 ePM2.5 65%	08646	60/30-35	620	320/370	640	390	10.5	EKLF 60/30-35 ePM2.5 65%	08637
KLF 70/40 ePM1 50%	08647	70/40	720	420	740	440	13.5	EKLF 70/40 ePM1 50%	08638
KLF 80/50 ePM1 50%	08654	80/50	820	520	840	540	20.5	EKLF 80/50 ePM1 50%	08639
KLF 100/50 ePM2.5 65%	08655	100/50	1020	520	1040	540	24.0	EKLF 100/50 ePM2.5 65%	08659

¹⁾ ISO Coarse 70%

²⁾ ISO ePM₁ 50%

³⁾ ISO ePM_{2.5} 65%

LFBR G4¹⁾, filter class ISO Coarse 70% (G4)



LFBR F7²⁾, filter class ISO ePM₁ 50% (F7)



Dimensions LFBR G4¹⁾

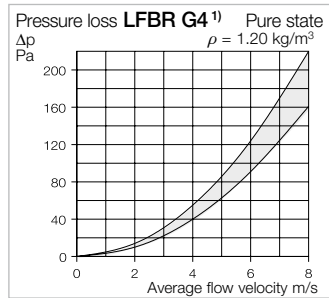
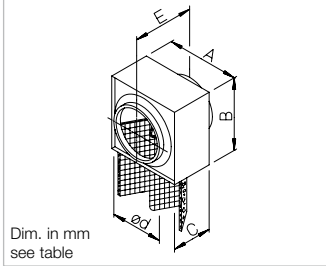

Dimensions LFBR F7²⁾

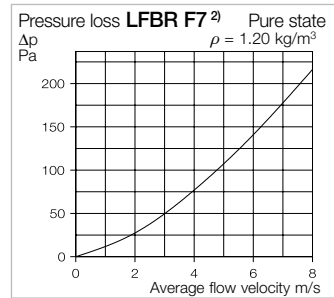
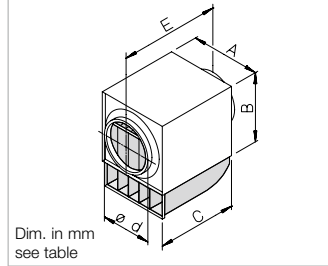

Air filter box LFBR

- **For installation in ventilation system duct system.** Connections with double lip seal, compatible with standard duct diameters.
- **Casing**
Made of galvanised steel sheet. Removable cover for filter removal with locking clamp.

- **Filter**
For types LFBR G4¹⁾ made of renewable synthetic fibre, class ISO Coarse 70% (G4). Temp.-resistant up to +100 °C. Fire behaviour according to DIN 53438 F1, self-extinguishing. Regeneration ability: 10–15x. Dust absorption: 122 g/m².
For types LFBR F7²⁾ bag filter, class ISO ePM₁ 50% (F7), made of synthetic plastic, 64 g/m². Dust absorption: 88.6 g/m².

- **Installation**
In any position. Allow clearance according to dimension B for filter removal.
- **Cleaning**
Depending on the system, filter replacement is required if the initial pressure loss is exceeded by around 1.5-2 times. Remove filter element after removing the casing cover.

- **Replacement air filter**
In case of signs of degradation, which can occur after frequent cleaning, the filter mat must be replaced with a new one.
- **Pressure loss**
Air filters create resistance according to the diagrams above; the grey shaded area shows the resistances of the different sizes. These must be taken into account for fan dimensioning.

■ **Accessories**

Differential pressure switch DDS Ref. no. 00445
Complete installation set for monitoring air filters.
Measurement range: 50–500 Pa.

■ **Reference**

The integration of air filters in class ISO ePM₁ 50% (F7) and differential pressure switches DDS (Ref. no. 00445) in intake air systems fulfils the requirements of VDI 6022.

Type	Ref. no.	Connection Ø d	Dimensions in mm				Weight aprx. kg	Replacement air filter (shipping unit = 5 pcs)	
			A	B	C	D		Type	Ref. no.
Air filter box LFBR G4¹⁾, filter class ISO Coarse 70% (G4)									
LFBR 100 Coarse 70%	08576	100	205	170	120	227	1.5	ELFBR 100 Coarse 70%	08585
LFBR 125 Coarse 70%	08577	125	215	205	140	252	1.8	ELFBR 125 Coarse 70%	08586
LFBR 160 Coarse 70%	08578	160	265	235	155	267	2.4	ELFBR 160 Coarse 70%	08587
LFBR 200 Coarse 70%	08579	200	315	275	180	302	3.0	ELFBR 200 Coarse 70%	08588
LFBR 250 Coarse 70%	08580	250	365	325	230	352	4.2	ELFBR 250 Coarse 70%	08589
LFBR 315 Coarse 70%	08581	315	425	390	330	452	7.5	ELFBR 315 Coarse 70%	08590
LFBR 355 Coarse 70%	08583	355	515	495	455	587	12.0	ELFBR 355 Coarse 70%	08592
LFBR 400 Coarse 70%	08582	400	515	495	455	587	12.0	ELFBR 400 Coarse 70%	08591
Air filter box LFBR F7²⁾, filter class ISO ePM₁ 50% (F7)									
(shipping unit = 2 pcs)									
LFBR 100 ePM ₁ 50%	08530	100	204	204	400	480	3.5	ELFBR 100 ePM ₁ 50%	08300
LFBR 125 ePM ₁ 50%	08531	125	204	204	400	480	3.5	ELFBR 125 ePM ₁ 50%	08301
LFBR 160 ePM ₁ 50%	08532	160	294	295	400	480	4.3	ELFBR 160 ePM ₁ 50%	08302
LFBR 200 ePM ₁ 50%	08533	200	294	295	400	480	4.3	ELFBR 200 ePM ₁ 50%	08303
LFBR 250 ePM ₁ 50%	08534	250	424	385	480	600	5.2	ELFBR 250 ePM ₁ 50%	08304
LFBR 315 ePM ₁ 50%	08535	315	424	385	480	600	5.2	ELFBR 315 ePM ₁ 50%	08305
LFBR 355 ePM ₁ 50%	08536	355	504	505	600	720	6.6	ELFBR 355 ePM ₁ 50%	08306
LFBR 400 ePM ₁ 50%	08537	400	504	505	600	720	6.6	ELFBR 400 ePM ₁ 50%	08307

¹⁾ ISO Coarse 70% ²⁾ ISO ePM₁ 50%

EHR-K

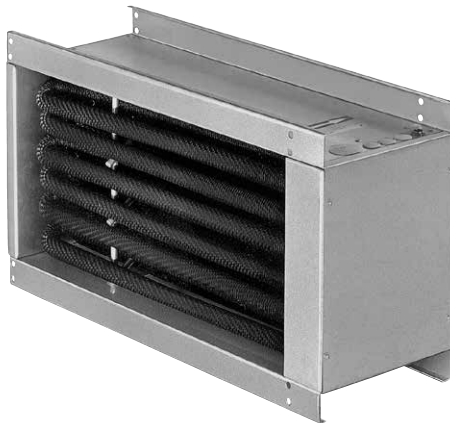

Dimensions EHR-K

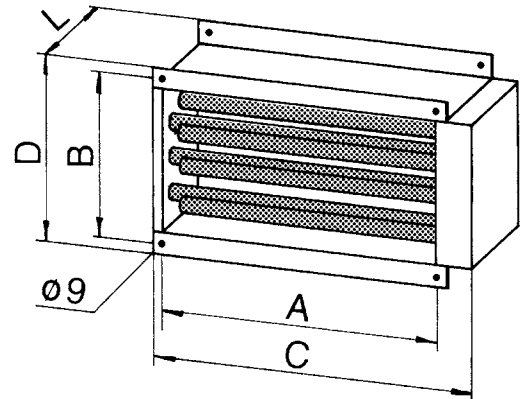

Dim. in mm see table

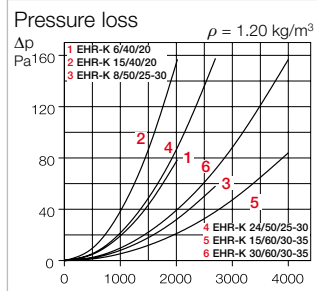
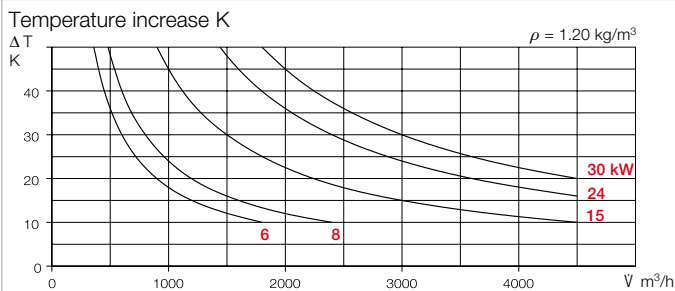

Electric heating element EHR-K

- Closed tubular heating element in galvanised steel sheet casing with double-sided connection flanges for installation in duct system.

Tubular heating element with low surface temperature wired to external terminal box, switchable in several groups.

Equipped with an automatically resetting temperature limiter (activation temperature 90 °C) and a manually resettable temperature limiter (activation temperature 120 °C).

■ Reference

DIN VDE 0100-420 must be observed on site; suitable air flow monitoring and electrical locking must be provided.

■ Installation instructions

- Install the heating element in the flow direction downstream of the fan. In case of installation upstream of the fan, ensure that the air flow temperature at the fan does not exceed its maximum permissible temperature. A duct piece of at least 1 m in length must be installed between the fan and the heating element. The minimum heating element air volume must be maintained. The heating element must be connected so that operation is only possible when the fan is activated. If the temperature monitor is triggered, the heating element must deactivate automatically. The heating elements can be operated in groups by using appropriate wiring, so that the reduction of heat output is possible.

■ Selection and operation

- Heating elements create additional pressure loss which must be taken into account for overall system dimensioning. An air flow temperature increase depends on the volume flow and heat output (see diagrams above). In order to prevent unwanted temperature monitor deactivation, the minimum air flow rate (see table) must be maintained.

■ Accessories

Electronic temperature control system

EHS See type table
Controls the heat output of the heating element depending on the difference between the setpoint and actual value for supply air temperature, which serves as a reference variable.

Duct sensor (Accessory for EHS)

TFK Ref. no. 05005
Temperature sensor for detecting the air temperature in air ducts.

Room sensor (Accessory for EHS)

TFR Ref. no. 05006
Temperature sensor with integrated setpoint adjuster for surface mounting. Also suitable simply as a temperature sensor or simply as a setpoint adjuster.

Type	Ref. no.	Power	Switch groups	Current consumption	Min. volume flow	Compat. with rect. duct fan	Connect. Wiring diagram ¹⁾	Dimensions					Weight approx.	Compatible temperature control system		
								A	B	C	D	L		Type	Ref. no.	
		kW	x kW	A	m³/h	NG cm	No.	A	B	C	D	L	kg	Type	Ref. no.	
3-, 400																
EHR-K	6/40/20	08702	6	2 x 3	8.7	430	40/20	361.4	423	223	550	250	200	7.3	EHSD 16	05003
EHR-K	15/40/20	08703	15	5 x 3	21.7	430	40/20	366.4	423	223	550	250	320	13.3	EHSD 16	05003
EHR-K	8/50/25-30	08704	8	2 x 4	11.3	680	50/25-30	362.4	523	273/323	650	350	200	9.2	EHSD 16	05003
EHR-K	24/50/25-30	08705	24	6 x 4	33.9	680	50/25-30	364.4	523	273/323	650	350	250	17.2	EHSD 30	05004
EHR-K	15/60/30-35	08706	15	3 x 5	20.9	980	60/30-35	365.4	623	323/373	750	400	200	12.9	EHSD 16	05003
EHR-K	30/60/30-35	08707	30	6 x 5	41.7	980	60/30-35	363.4	623	323/373	750	400	200	19.3	EHSD 30	05004

¹⁾ Principle connection for all types No. 476.2.

EHR-R



Dimensions EHR-R

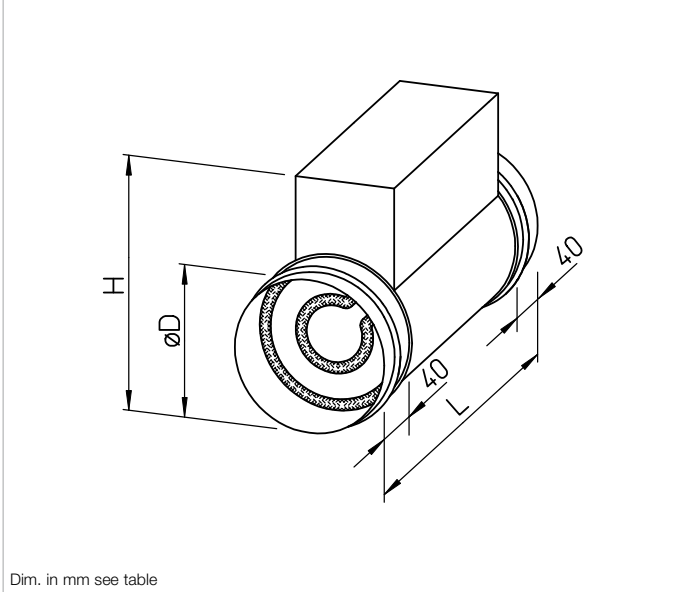

Dim. in mm see table

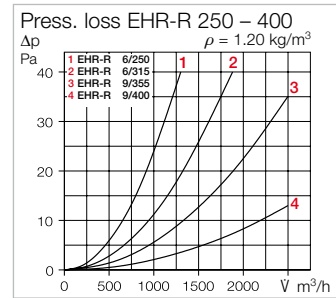
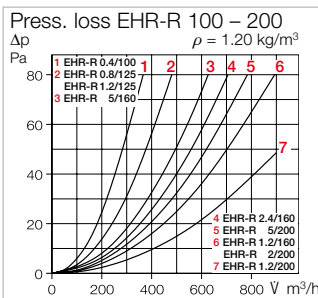
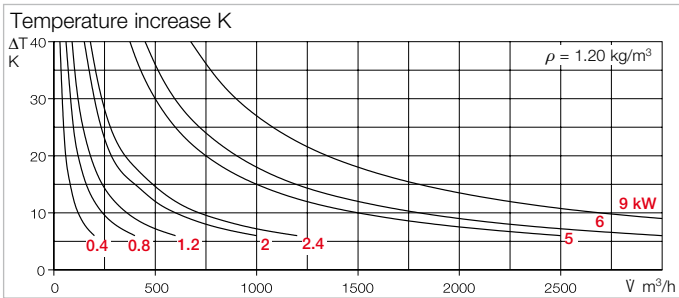

Electric heating element EHR-R
 Closed tubular heating element-made of stainless steel with low surface temperature. Duct casing with terminal box made of galvanised steel sheet for installation in commercial pipe systems. Equipped with an automatically resetting temperature limiter (activation temperature 50 °C) and a manually resettable temperature limiter (activation temperature 120 °C).

Installation instructions
 Install the heating element in the

flow direction downstream of the fan. In case of installation upstream of the fan, ensure that the air flow temperature at the fan does not exceed its maximum permissible temperature. A duct piece of at least 1 m in length must be installed between the fan and the heating element. The minimum heating element air volume must be maintained. The heating element must be connected so that operation is only possible when the fan is activated. If the temperature monitor is triggered, the

heating element must deactivate automatically. The heating elements can be operated in groups by using appropriate wiring, so that the reduction of heat output is possible.

Selection and operation
 Heating elements create additional pressure loss which must be taken into account for overall system dimensioning. An air flow temperature increase depends on the volume flow and heat output (see diagrams). In

order to prevent unwanted temperature monitor deactivation, the minimum air flow rate (see table) must be maintained.

Accessories

Electronic temperature control system
EHS see type table
 Controls the heat output of the heating element depending on the difference between the setpoint and actual value for supply air temperature, which serves as a reference variable.

Duct sensor (Accessory for EHS)
TFK Ref. no. 05005
 Temperature sensor for detecting the air temperature in air ducts.

Room sensor (Accessory for EHS)
TFR Ref. no. 05006
 Temperature sensor with integrated setpoint adjuster for surface mounting. Also suitable simply as a temperature sensor or simply as a setpoint adjuster.

Reference
 DIN VDE 0100-420 must be observed on site; suitable air flow monitoring and electrical locking must be provided.

Accessories	Page
Electronic temperature control system EHS	479

Type	Ref. no.	Power	Switching groups no.	Current consum.	Min. volume flow	Compat. with fan	Wiring diagram ¹⁾	Dimensions			Weight approx.	Compatible temperature control system	
								Ø D	H	L		Type	Ref. no.
1-, 230 V													
EHR-R 0.4/100	08708	0.4	1 x 0.4	1.7	45	100	813	100	185	325	2.0	EHS	05002
EHR-R 0.8/125	08709	0.4	1 x 0.4	1.7	45	100	813	100	185	325	2.0	EHS	05002
EHR-R 1.2/125	09433	1.2	1 x 1.2	5.2	70	125	813	125	225	325	2.4	EHS	05002
EHR-R 1.2/160	09434	1.2	1 x 1.2	5.2	110	160	813	160	260	380	2.6	EHS	05002
EHR-R 2.4/160	09435	2.4	1 x 2.4	10.4	110	160	814	160	260	380	3.0	EHS	05002
EHR-R 1.2/200	09436	1.2	1 x 1.2	5.2	180	200	813	200	300	380	2.8	EHS	05002
EHR-R 2/200	09437	2.0	1 x 2.0	8.7	180	200	813	200	300	380	3.2	EHS	05002
2-, 400 V													
EHR-R 5/160	08710	5.0	1 x 5.0 parallel	12.5	110	160	815	160	260	380	4.0	EHS	05002
EHR-R 5/200	08711	5.0	1 x 5.0 parallel	12.5	180	200	815	200	300	380	4.6	EHS	05002
EHR-R 6/250	08712	6.0	1 x 6.0 parallel	15.0	270	250	815	250	350	380	7.3	EHS	05002
EHR-R 6/315	08713	6.0	1 x 6.0 parallel	15.0	420	315	815	315	415	380	9.2	EHS	05002
3-, 400 V													
EHR-R 9/355	08656	9.0	1 x 9.0 in Δ	13.0	550	355	816	355	455	380	12.5	EHS 16	05003
EHR-R 9/400	08657	9.0	1 x 9.0 in Δ	13.0	680	400	816	400	500	380	13.1	EHS 16	05003

¹⁾ Principle connection for all types No. 476.2.



Electronic temperature control system EHS for electric heating elements

- Electronic temperature control system for controlling electric heating elements in rectangular ducts or round ducts in ventilation systems. The heat output of the heating element is controlled depending on the difference between the setpoint and actual value for supply air temperature, which serves as a reference variable.
- The controllers are continuously variable through time-proportional pulse width control. The ratio between activation time and deactivation time is adjusted to the existing power requirement. The max. switching cycles per time unit stipulated by the electricity suppliers are thus maintained even for high switching capacities.

- Contactless power switching via electronic power switch.
- Control using setpoint adjuster (internal or external, room sensor TFR) or using external control signal 0 – 10 V DC (only for EHSD types).

■ Application

- The controllers are suitable for constant supply air control and constant room control. In case of rapid temperature changes in the supply air, a PI control behaviour is achieved; in case of slow changes in room air, the control behaviour corresponds to a P-controller. Automatic night-time reduction can be achieved using an external, on-site timer.
- An air flow monitoring system is also stipulated for safety reasons.

Flow monitor, electronic

SWE Ref. no. 00065
– mechanical, from NW 315

SWT Ref. no. 00080
see product page.

Electronic temperature controller for electric heating elements up to 3.6 kW (230 V) / 6.4 kW (400 V)

EHS Ref. no. 05002

Temperature-controlled, semi-conductor-controlled controller. Elegant, white plastic casing for wall installation. Constant supply air or room control via built-in temperature sensor for temperature detection at the installation location. Can be switched to external duct sensors or room sensors (TFK or TFR, Accessories). Has a minimum and maximum limit for the supply air temperature.
Measurement range 0 – 30 °C
Voltage 230 V, 1~ / 400 V, 2~ (automatic detection)

Load capacity 16 A
Protection category IP20
Dim. in mm H 150 x W 94 x D 43
Weight approx. 0.3 kg
Wiring diagram no. 531.1

Electronic temperature controller for electric heating elements up to 17 kW

EHSD 16 Ref. no. 05003

Temp.-controlled, semi-conductor-controlled controller. Robust aluminium casing for wall or switch cabinet installation. Constant supply air or room control via external duct or room sensor (TFK/TFKB or TFR, Accessories). Remote control possible via external setpoint adjuster TFR or external control voltage 0 – 10 V DC.

Voltage 400 V, 3~
Load capacity 25 A
Protection category IP40
Dim. in mm H 207 x W 160 x D 95
Weight approx. 1.7 kg
Wiring diagram no. 550.2

Electronic temperature controller for electric heating elements up to 34 kW

EHSD 30 Ref. no. 05004

Design like EHSD 16; but max. power 34 kW. The total heat output is divided into a controlled portion (max. 17 kW) and a basic output portion (17 kW). If the heat output requirement of approx. 17 kW is exceeded, the basic output of 17 kW will be permanently activated using the provided switch contactor. The remaining heat output will be temperature-controlled.

Voltage 400 V, 3~
Load capacity 25 A
Protection category IP40
Dim. in mm H 207 x W 160 x D 95
Weight approx. 1.7 kg
Switching relay Voltage 230 V~
Current max. 5 A
Switch contactor Volt. 400 V, 3~
Current max. 25 A
Wiring diagram no. 550.2

■ Other access. for EHSD

Duct temperature sensor for limiting function.

TFKB Ref. no. 05009

■ Reference

Integration in the system control required on site must be carried out according to the specified wiring diagrams.

Installation diagram EHR

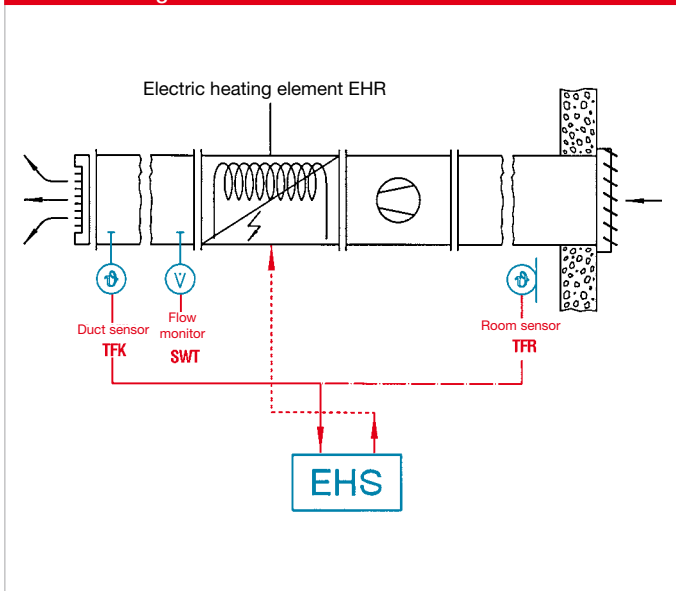

TFK



Duct sensor (Accessory for EHS)

TFK Ref. no. 05005

Temperature sensor for detecting the air temperature in air ducts with installation kit for installation in duct wall.

Temperature range 0 – 30 °C
Protection category IP20
Length intern./extern. 130 / 50 mm
Ø 10 mm
Weight approx. 0.1 kg

TFR



Room sensor (Access. for EHS)

TFR Ref. no. 05006

Temperature sensor with integrated setpoint adjuster for surface mounting. Also suitable simply as a temperature sensor or simply as a setpoint adjuster. Elegant plastic casing.

Temperature range 0 – 30 °C
Protection category IP20
Dim. in mm H 86 x W 86 x D 30
Weight approx. 0.1 kg

EHR-R TR



Dimensions EHR-R TR

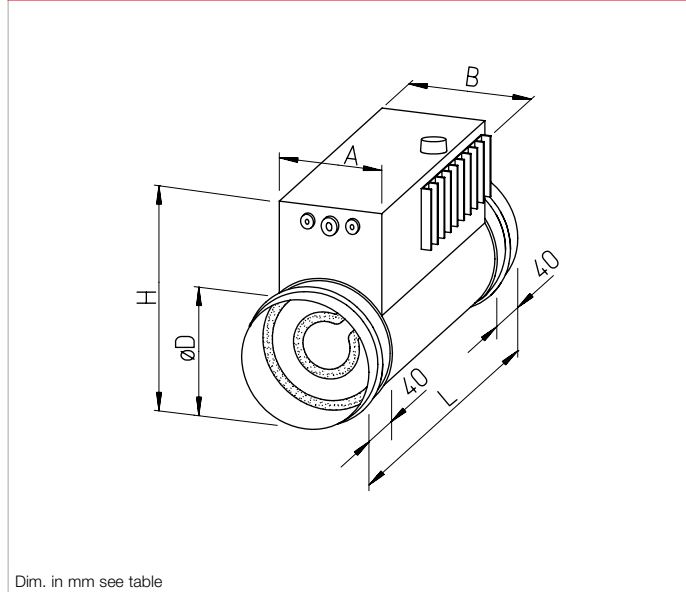

Dim. in mm see table

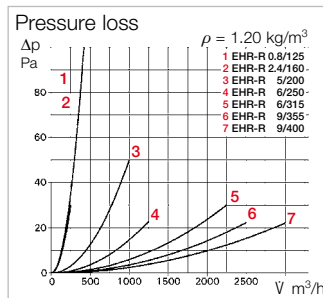
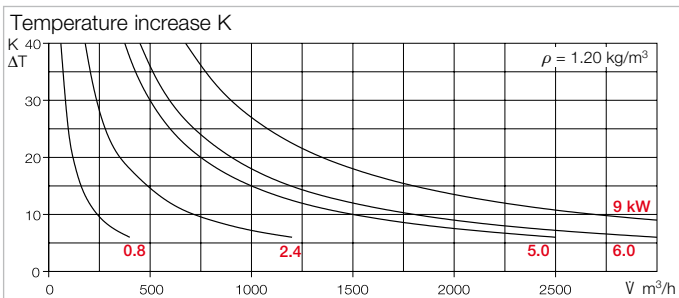

Electric heating element EHR-R TR with integrated temperature control. The convenient and easy to install solution for wherever there is a need for constant supply air or room temperature. Electric heating elements EHR-R TR have integrated temperature control and they can be installed in any position in the duct system. Installation is very easy and space-saving.

Heating element

□ Closed tubular heating element made of stainless steel with low surface temperature. Duct casing with terminal box made of galvanised steel sheet and integrated temperature control for installation in commercial pipe systems.

Equipped with an automatically resetting temperature limiter (activation temperature 50 °C) and a manually resettable temperature limiter (activation temperature 120 °C).

Temperature control

□ Constant supply air temperature control by connecting a duct sensor (TFK, Accessories). Setpoint setting (0 – 30 °C) via potentiometer on outside of unit. Room air temperature control by connecting a room sensor (TFR,

Accessories); optional setpoint setting via room sensor TFR or potentiometer. Automatic detection of supply voltage 230 V or 400 V.

Load capacity 16 A
Protection category IP20

□ The controllers are continuously variable through time-proportional pulse width control. The ratio between activation time and deactivation time is adjusted to the existing power requirement. The max. switching cycles per time unit stipulated by the electricity suppliers are thus maintained even for high switching capacities.

Application

□ EHR-R TR are suitable for constant supply air control and constant room control. In case of rapid temperature changes in the supply air, a PI control behaviour is achieved; in case of slow changes in room air, the control behaviour corresponds to a P-controller.

□ An air flow monitoring system is also stipulated for safety reasons.

Flow monitor

– electronic

SWE Ref. no. 00065

– mechanical, from NW 315

SWT Ref. no. 00080

see product page.

Installation instructions

□ See description EHR-R, page 478.

Selection and operation

□ Heating elements create additional pressure loss which must be taken into account for overall system dimensioning. An air flow temperature increase depends on the volume flow and heat output (see diagrams on the right).

In order to prevent unwanted temperature monitor deactivation, the minimum air flow rate (see table) must be maintained.

Accessories

Duct sensor

TFK Ref. no. 05005
Temperature sensor for detecting the air temperature in air ducts.

Room sensor

TFR Ref. no. 05006
Temperature sensor with integrated setpoint adjuster for surface mounting. Also suitable simply as a temperature sensor or simply as a setpoint adjuster.

Type	Ref. no.	Power kW	Switch. groups no. x kW	Curr. con- sump. A	Minimum volume flow m³/h	Compat. with fan NS mm	Wiring diagram No.	Dimensions					Weight approx. kg
								Ø D mm	H mm	L mm	A mm	B mm	
1~, 230 V													
EHR-R 0.8/125 TR	05293	0.8	1 x 0.8	3.5	70	125	799.1	125	225	325	125	145	2.6
EHR-R 2.4/160 TR	05294	2.4	2 x 1.2	10.4	110	160	799.1	160	260	380	150	170	3.4
2~, 400 V													
EHR-R 5/200 TR	05295	5.0	2 x 2.5	12.5	180	200	800.1	200	300	380	150	170	4.4
EHR-R 6/250 TR	05296	6.0	2 x 3.0	15	270	250	800.1	250	350	380	150	170	4.8
EHR-R 6/315 TR	05301	6.0	2 x 3.0	15	420	315	800.1	315	415	380	150	170	6.4
3~, 400 V													
EHR-R 9/355 TR	05297	9.0	3 x 3.0	13	550	355	801.1	355	455	380	150	182	8.5
EHR-R 9/400 TR	05299	9.0	3 x 3.0	13	680	400	801.1	400	500	380	150	182	8.9

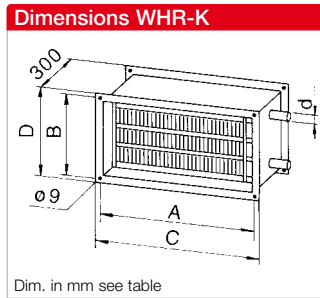

Warm water heating element for connection to rectangular ventilation ducts.
Dimensionally matched to the Helios rectangular duct fans. Casing made of galvanised steel sheet, double-sided flanges. Air heater with aluminium blades, offset copper pipes.
Operating temp. t_{max} 120 °C.
Max. operating pressure 8 bar.
Water connection pipes with external thread.
With drain/vent valve.

Installation instructions

Install the heating element in the flow direction downstream of the fan. In case of installation upstream of the fan, ensure that the air flow temperature at the fan does not exceed its maximum permissible temperature.

In order to protect against contamination and to prevent a drop in performance, the installation of an air filter KLF is recommended.

A duct piece of at least 1 m in length must be installed between the fan and the heating element, so that a uniform flow is achieved. When installing a heating element, make sure that drainage and venting is ensured. Attention: Frost protection should be provided on site.

Selection

The effective temperature increase results from the parameters: Volume throughput, element output and flow temperature.

These parameters can be determined using the adjacent diagrams (in steps a - c).

The heat outputs are also specified in the type table for some volume parameters. When selecting a fan (volume determination), the pressure loss of the heating element, which is shown in the diagrams, must be taken into account (figure d).

Determination of press. loss

The diagrams above show the pressure loss depending on the volume flow for the respective heating element.

Accessories Page

Temperature control system WHS HE	484 f.
--------------------------------------	--------

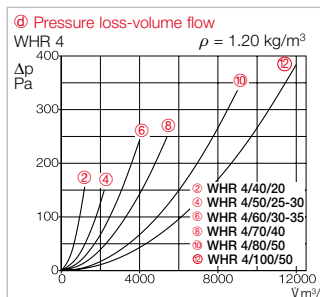
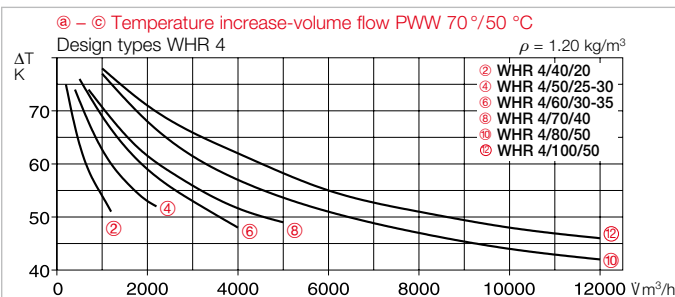
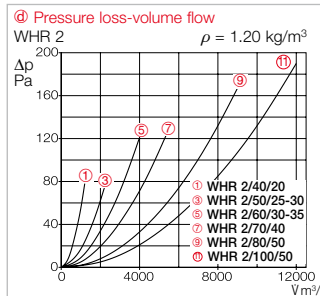
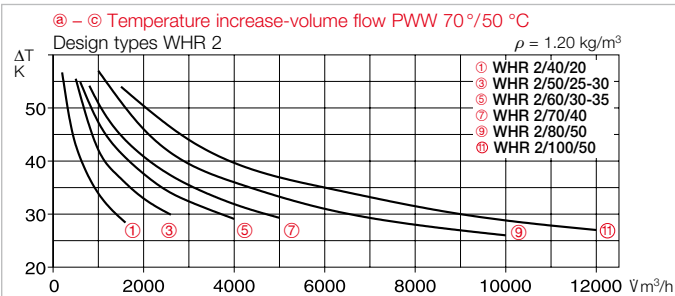

a Temperature increase

Determination: $\Delta T = \vartheta_i - \vartheta_a$ [K]
 ΔT : Air temperature difference [K]
 ϑ_i : Air temp., air heater outlet [°C]
 ϑ_a : Air temp., air heater inlet [°C]

b Volume throughput

Given by fan performance curve, whereby system resistances and heating element pressure loss (figure d) must be taken into account.

c Determination of heat output

$$Q_H = \frac{V \cdot \Delta T \cdot c_{pL} \cdot \rho_L}{3600} \text{ [kW]}$$

V: Volume flow [m³/h]
 ΔT : Air temperature difference [K]
 c_{pL} : Specific heat capacity of the air (1.0) [kJ/kg K]
 ρ_L : Air density (1.2) [kg/m³]

d Determination of press. loss

The diagrams above show the pressure loss depending on the volume flow for the respective heating element.

Type	Ref. no.	Compat. with fan	Air-side data				Water-side data ¹⁾		Dimensions				Weight	Compatible temperature control system			
			Heat output	ΔT air	at V	Pressure loss	at water volume	A	B	C	D	Connection		Type	Ref. no.		
		NG cm	kW ¹⁾	kW ²⁾	K ¹⁾	K ²⁾	m³/h	Δp_w kPa	l/h	mm	mm	mm	mm	Ø	ca. kg		
WHR 2/40/20	08782	40/20	14	7.7	32	18	1200	10	610	420	220	450	250	3/4	7.0	WHS HE	08319
WHR 4/40/20	08783	40/20	22	12.6	51	29	1200	7	980	420	220	450	250	3/4	7.3	WHS HE	08319
WHR 2/50/25-30	08784	50/25-30	24	14	33	18	2200	7	1050	520	270/320	550	350	3/4	9.3	WHS HE	08319
WHR 4/50/25-30	08785	50/25-30	38	21	52	28	2200	5	1680	520	270/320	550	350	1	11.1	WHS HE	08319
WHR 2/60/30-35	08786	60/30-35	32	18	34	19	2600	8	1420	620	320/370	650	400	3/4	11.2	WHS HE	08319
WHR 4/60/30-35	08787	60/30-35	51	30	55	32	2600	7	2270	620	320/370	650	400	1	14.0	WHS HE ⁴⁾	08319
WHR 2/70/40	08788	70/40	50	28	30	17	4500	6	2200	720	420	750	450	1	17.0	WHS HE	08319
WHR 4/70/40	08789	70/40	81	44	50	27	4500	4	3570	720	420	750	450	1	17.0	-	-
WHR 2/80/50	08795	80/50	82	46	28	16	8000	11	3630	820	520	850	550	1	15.0	-	-
WHR 4/80/50	08796	80/50	138	80	48	28	8000	15	6110	820	520	850	550	1	20.0	-	-
WHR 2/100/50	08797	100/50	104	59	29	18	10000	19	4630	1020	520	1050	550	1	18.0	-	-
WHR 4/100/50	08798	100/50	172	99	48	28	10000	14	7640	1020	520	1050	550	1	24.0	-	-

The values apply for supply air temperature 0 °C and flow/return temperatures: 1) 90/70 °C, 2) 60/40 °C, 3) 3/4" = 19.05 mm, 1" = 25.4 mm, external thread. 4) with reduced heat output to approx. 2200 l/h.

WHR-R



Dimensions WHR-R

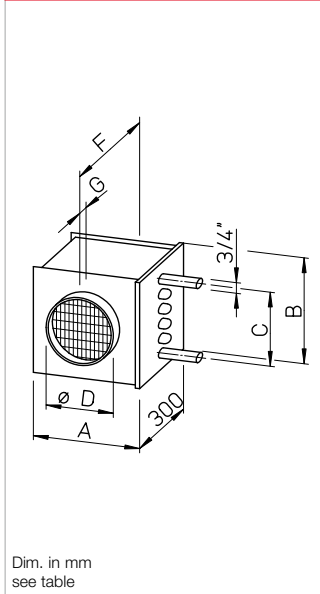

Warm water heating element for installation in vent. ducts.
Dimensionally matched to the Helios round duct fans. Casing made of galvanised steel sheet. Double-sided connections with rubber lip seal for standard ducts. Air heater with aluminium blades, pressed onto copper pipes.
Operating temp. t_{max} 100 °C. Operating pressure max. 8 bar.
Water connection pipes with external thread. Two inspection covers on water connection side for easy cleaning. With drain/vent valve.

Installation instructions
Install the heating element in the flow direction downstream of the fan. In case of installation upstream of the fan, ensure that the air flow temperature at the fan does not exceed its maximum permissible temperature. In order to protect against contamination and to prevent a drop in performance, the installation of an air filter LFBR is recommended. A duct piece of at least 1 m in length must be installed between the fan and the heating element, so that a uniform flow is achieved. When installing a heating element, make sure that drainage and venting is ensured. Attention: Frost protection should be provided on site.

Selection
The effective temperature increase results from the parameters: Volume throughput, element output and flow temperature. These parameters can be determined using the adjacent diagrams (in steps a - c). The heat outputs are also specified in the type table for some volume parameters. When selecting a fan (volume determination), the pressure loss of the heating element, which is shown in the diagrams, must be taken into account (figure d).

d Determination of press. loss
The diagrams above show the pressure loss depending on volume flow for the respective heating element.

Accessories	Page
Temperature control system WHST, WHS HE	483 f.

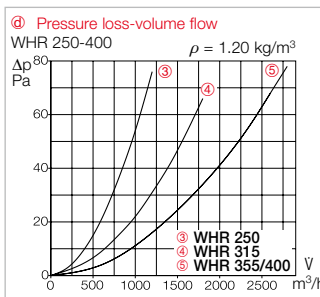
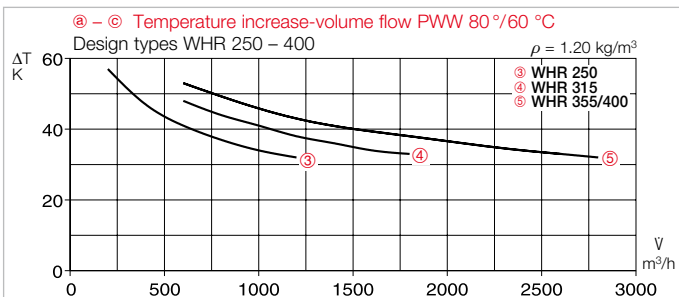
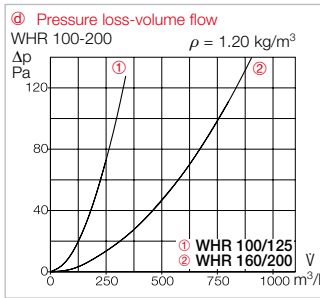
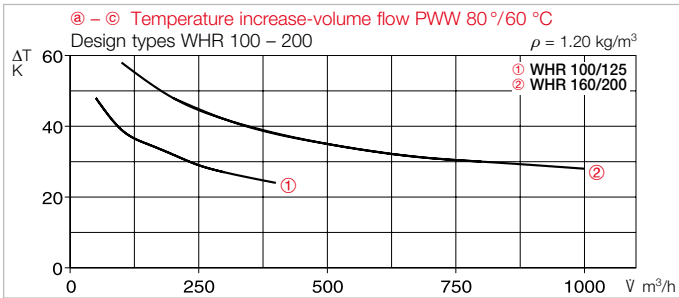

a Temperature increase
Determination: $\Delta T = \vartheta_i - \vartheta_a$ [K]
 ΔT : Air temperature difference [K]
 ϑ_i : Air temp., air heater outlet [°C]
 ϑ_a : Air temp., air heater inlet [°C]

b Volume throughput
Given by fan performance curve, whereby system resistances and heating element pressure loss (figure d) must be taken into account.

c Determination of heat output
$$Q_H = \frac{V \cdot \Delta T \cdot c_{pL} \cdot \rho_L}{3600} \text{ [kW]}$$

V: Volume flow [m³/h]
 ΔT : Air temperature difference [K]
 c_{pL} : Specific heat capacity of the air (1.0) [kJ/kg K]
 ρ_L : Air density (1.2) [kg/m³]

Type	Ref. no.	Compat. with duct Ø mm	Air-side data					Water-side data ¹⁾		Dimensions						Connection d ²⁾	Weight ca. kg	Compatible temperature control system Type Ref. no.
			Heat output kW ¹⁾	kW ²⁾	Δ T air K ¹⁾	K ²⁾	at V m³/h	Pressure loss Δ p _s kPa	at water volume l/h	A mm	B mm	C mm	Ø D mm	G mm	F mm			
WHR 100	09479	100	1.9	0.9	35	17	150	1	84	161	180	140	100	45	387	3/4	3.2	WHST 300 T38 ³⁾ 08817
WHR 125	09480	125	2.6	1.1	29	13	250	2	115	161	180	140	125	45	387	3/4	3.2	WHST 300 T38 ³⁾ 08817
WHR 160	09481	160	5.5	3.1	38	22	400	11	245	236	255	215	160	45	387	3/4	4.9	WHST 300 T38 ³⁾ 08817
WHR 200	09482	200	7.2	4.1	33	19	600	17	317	236	255	215	200	45	387	3/4	4.9	WHST 300 T38 ³⁾ 08817
WHR 250	09483	250	10.7	6	37	21	800	8	470	311	330	290	250	65	427	3/4	6.9	WHS HE 08319
WHR 315	09484	315	18.3	10.4	36.2	21	1400	9	810	396	405	365	315	56	410	3/4	9.0	WHS HE 08319
WHR 355	08790	355	24.5	14	38	21.6	1800	9	1080	461	480	420	355	56	410	3/4	12.5	WHS HE 08319
WHR 400	09524	400	26.2	15	36	21	2000	11	1060	461	480	420	400	71	440	3/4	12.5	WHS HE 08319

The values apply for supply air temperature 0 °C and flow/return temperatures: 1) 90/70 °C, 2) 60/40 °C.
4) Alternative WHST 300 T50, see p 163 (Ref. no. 08820).

3) 3/4" = 19.05 mm, 1" = 25.4 mm, external thread.

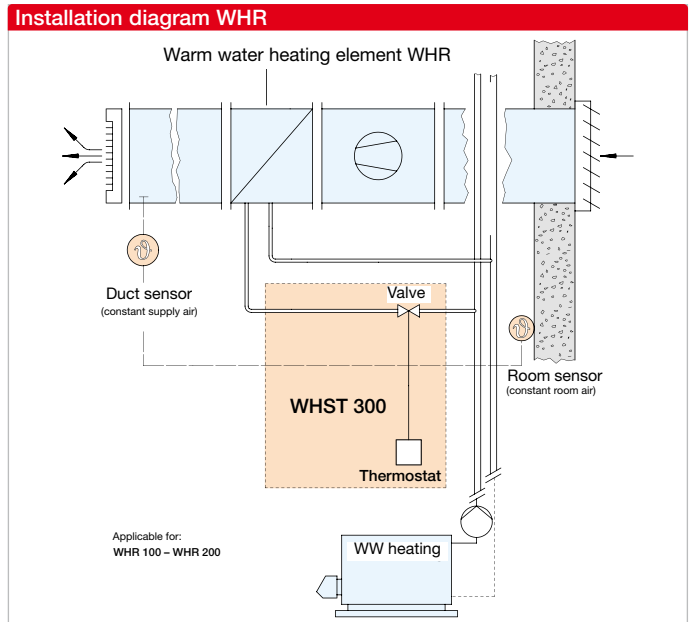

Air temperature control WHST 300 T38 for warm water heating elements.

- For the air heating control of warm water heating elements with smaller outputs up to approx. 5.5 kW and flow rates up to 300 l/h.
- Ideal addition for ventilation units with heat recovery and PWW post-heater as well as for warm water heating elements WHR 100 up to WHR 200.
- Simple, cost-effective and quick-to-install solution.

■ Description/Application

- WHST 300 T38 consists of a thermostat with remote adjustment and remote sensor and it is suitable for systems where the water pressure of the heating circuit can provide this application. The proportional controller, which works like a conventional heating valve and without auxiliary electrical energy, is continuously variable and changes the temperature by varying the heating water flow rate.

■ Control options

- Control options by changing the heating water flow rate:
- **Constant supply air temperature control** by positioning the capillary tube sensor in the air flow.
 - **Constant room air temperature control** by positioning the capillary tube sensor in the room.
 - **Optional limitation of the temperature range** by defining a minimum and maximum value.
 - **Frost protection position** reacts at +8 °C.

■ Scope of delivery

- Complete set, includes
- Thermostat for room installation
 - Straight-way valve
 - Set piston
 - Capillary tube remote sensor
 - Mounting material

■ Installation instructions

- The capillary tube should be laid so that it is not kinked or flattened. For a constant room temperature, the remote sensor should be installed at a point in the room where the desired temperature conditions prevail.

■ Design

- The WHST 300 T38 control can be used for heating elements up to 300 l/h water flow rate. The pressure loss to be overcome for dimensioning the on-site pump results from the sum of Δp heating element, Δp valve (see diagram) and Δp duct system.

■ Technical data

Type	WHST 300 T38
Ref. no.	08817
Max. operating pressure	10 bar
Max. operating temperature	120 °C
Connection DN 20	3/4"
Max. flow rate	300 l/h
Differential pressure influence	0.4 K/0.5 bar
Setpoint range (thermostat)	8–38 °C
Dimensions in mm	
– Thermostat	W 80 x H 80 x D 50
– Remote sensor	W 35 x H 85 x D 30
Connection thread DN 20	G 3/4"
Capillary tube length	5 m
Weight (complete)	0.5 kg

Valve pressure loss

*Valve position

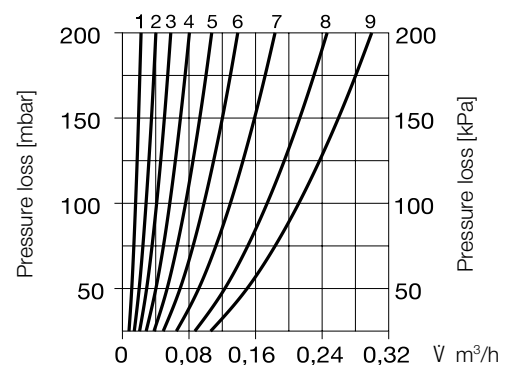

* Note: The valve is delivered ex works in position 9. It can be variably adjusted between 1 and 9 to optimise the control behaviour for smaller water volumes.

■ Reference

Air temp. control for warm water heating element WHR. For constant supply air temp. in the range from 20–50 °C
WHST 300 T50
(see page 163) No. 08820

WHS HE

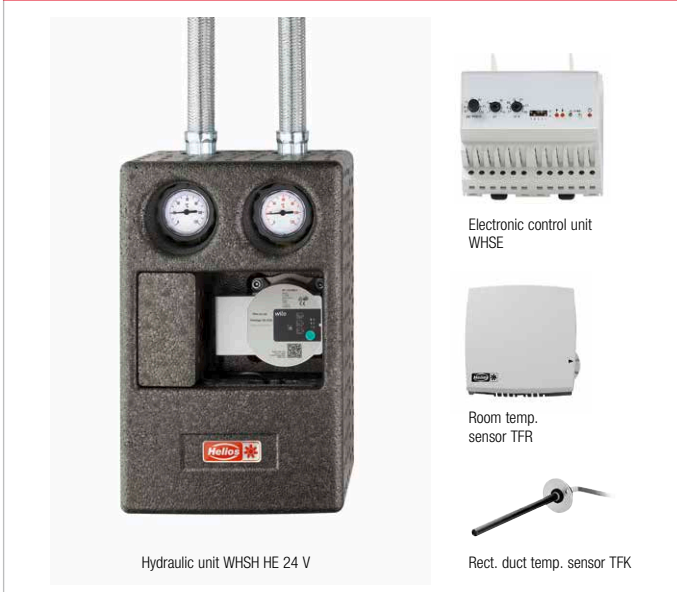

Dimensions WHS HE

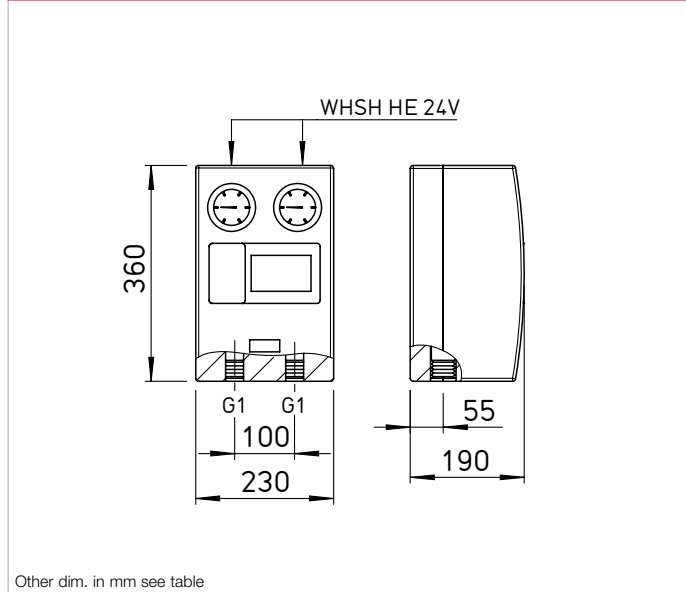

Air temperature control WHS HE for warm water heating elements

- For the air heating control of warm water heating elements with a maximum output of approx. 70 kW and a flow rate between 200 and 2200 l/h.
- Compatible with the Helios heating elements WHR-R 250 – 400 and WHR-K up to 2200 l/h.
- Complete system with multiple control options and matched components.
- **Application**
 - Connection to existing heating circuits to supply e.g. a separate section. For creating a separate heating circuit using the integrated pump.
 - The hydraulic assembly WSH HE 24 V is used to operate a heating circuit in combination

with Helios warm water heating elements. The flow temperature to the heating element is controlled using a 3-way valve, which is operated by a 24 V electric servomotor.

- Delivered as a ready-to-connect, easy-to-install set. With premounted, thermally insulated hydraulic unit.
- **Control options**
 - Constant supply air temperature control using duct sensor TFK.
 - Constant room temperature control using external room sensor TFR.
 - Constant room temperature control with minimum limit for supply air temperature through the room and duct sensors.
 - Frost protection for all three variants by using a second duct sensor TFK.
 - WHS HE also offers the option

of setpoint control e.g. for night and weekend deactivation as well as the connection of additional sensors or setpoint adjusters.

■ **Scope of delivery/Description**

- Hydraulic unit WSH HE 24 V with:
 - Electronic circulating pump with automatic ventilation function, 2 m connection cable.
 - Flow/return shut-off valves with integrated temperature display.
 - 24 Volt servomotor with end switch, manual operation possible. Connection cable (2.2 m).
 - Three-way valve.
 - Thermal cladding made of EPP foam.
 - Sealing kit and two flexible reinforced hoses DN 25

(stainl. steel, 50 cm long) for element-side connection.
– Reduction nipple, 3/4" – 1".

- Electronic control unit WHSE, for switch cabinet installation. Functions:
 - Setpoint temp. specification for operation with constant supply air temperature.
 - Cascade factor setting.
 - Minimum limit.
 - Setting/selection of control modes.
 - Operating display.
 - Frost protection: Alarm and reset.
 - Servomotor operating display.
 - Potential-free output for alarm 24 V and 230 V circuit.
- Two temperature sensors TFK for rectangular duct installation.
- One room temperature sensor TFR.

Installation diagram WHS HE

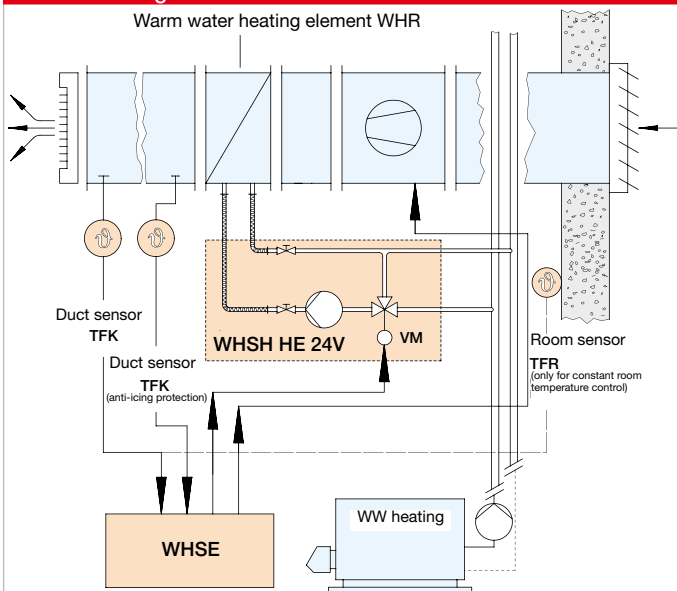

Type	WHS HE
Ref. no	08319
Max. operating pressure	6 bar
Max. operating temperature	120 °C
KVS value	5.1
Min. / Max. flow rate	200 ¹⁾ – 2200 l/h
Differential pressure influence	0.1 – 0.7 K / 0.5 bar
Setpoint range (thermostat)	7 – 28 °C
Ambient temperature (control electronics)	0 – 50 °C
Protection category (control electronics)	IP20
Power consumption – Pump	3 ... 45 W
– Servomotor	2.5 W
– Control electronics	5 W
Voltage – Pump / control electronics	230~ V / 50 Hz
– Servomotor	24~ V / 50/60 Hz
Wiring diagram no.	953
Dimensions in mm	See dimensional drawing
– Hydraulic unit ²⁾	H 80 x W 100 x D 85
– Room sensor TFR	H 80 x W 85 x D 30
– Duct sensor TFK	130/50 ²⁾ , Ø 10
Weight approx. kg	9.0

¹⁾ Low water flow rates can cause control problems. ²⁾ Length internal/external.
³⁾ One-off orders of WHS HE system components upon request.

Application example

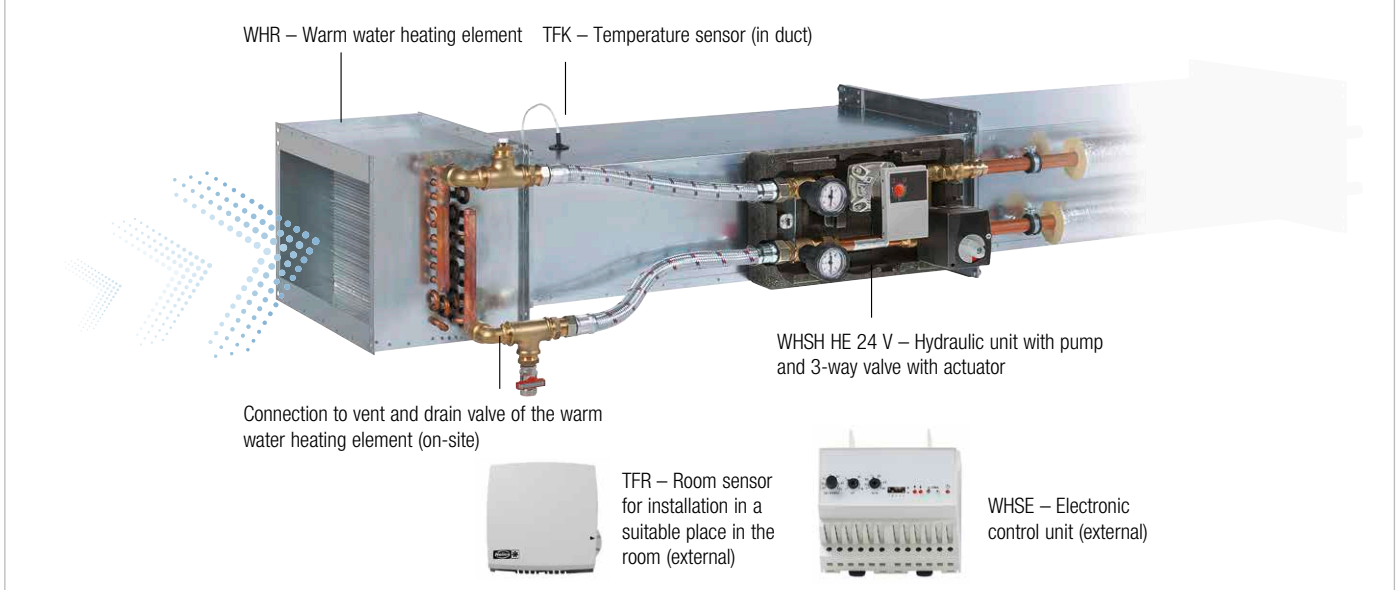

Installation instructions

The heating element WHR and duct sensor TFK must be attached on the air-side in the duct system downstream of the fan. The hydraulic unit WHSH HE 24 V must be fixed independently and securely. Expansion forces or the dead weight of the duct system must not burden the connections. The vent valve must be attached at the highest point and the drain valve must be attached at the lowest point of the circuit. The electronic control unit WHSE (IP 20) can be installed in the switch cabinet on DIN profile rails.

Design

- 1 Selection of the desired PWW heating element using the air volume flow, the design (duct dimensions) and the required heat output
 - WHR-R, round ducts p. 482
 - WHR-K, rect. ducts p. 481
- 2 Determination of the pressure loss of the on-site duct system.
- 3 Addition of losses from all components:

$$\Delta p_{\text{Total}} = \Delta p_{\text{heating element}} + \Delta p_{\text{duct system}} + \Delta p_{\text{WHS HE}}$$
- 4 Setting the required differential pressure Δp_{Total} at the rotary knob on the circulating pump.

Diagram

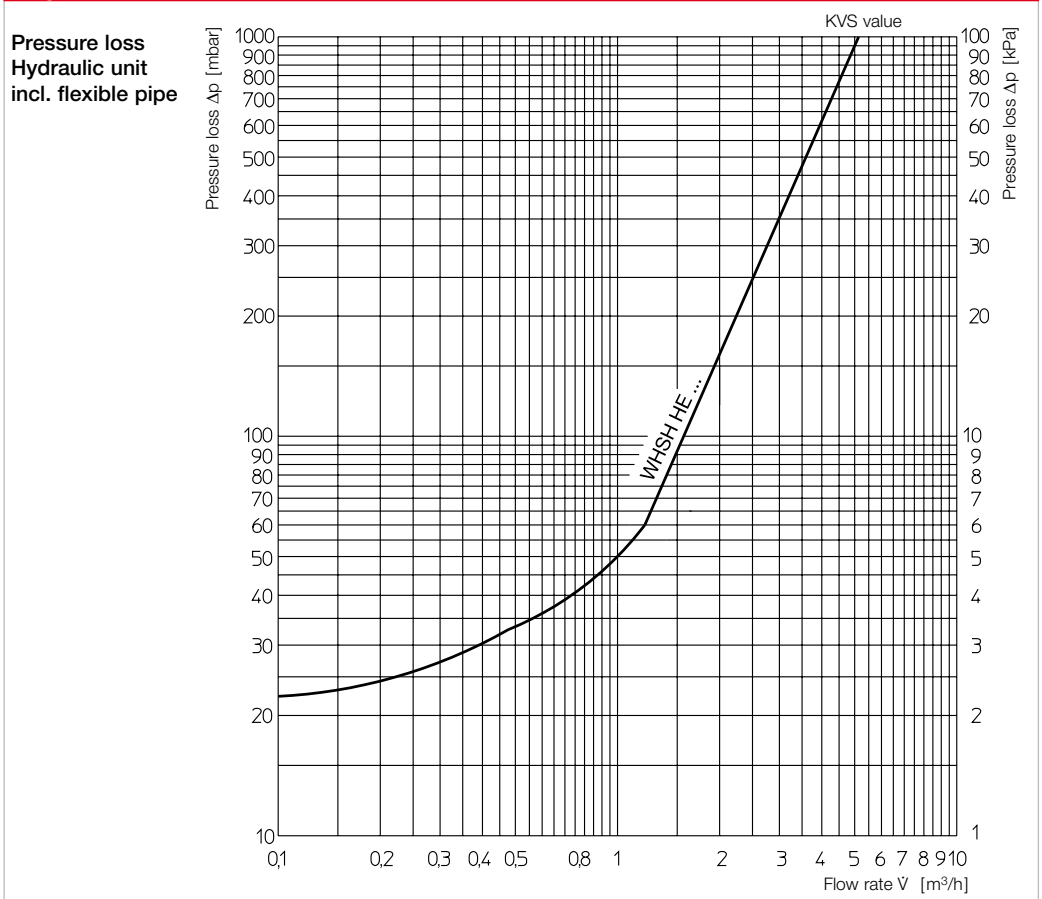

Char. curve Diff. press. – Variable

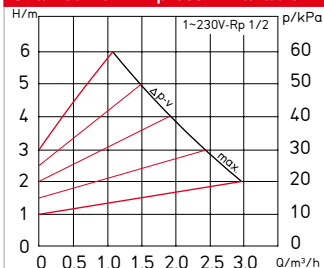

Char. curve Diff. press. – Constant

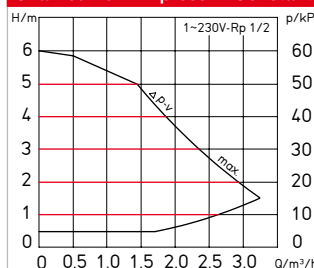

Reference

Other hydraulic units

– for KWL units with PWW post-heater WHSH HE 24 V (0-10 V) Ref. no.08318 **163**

– for ALB EC WW WHSH HE 24 V (0-10 V) Ref. no.08318 **343 ff.**

General information

■ If the fan noise emission exceeds an acceptable level, passive noise reduction measures must be taken. For this purpose, silencers can be used according to the absorption principle. This silencer type ensures good sound insulation with low pressure losses.

Helios offers silencers which are optimally adapted to the Helios fans. Round duct and rectangular duct silencers are available in corresponding casing shapes. Of course, all silencer types can also be used with fans of other brands.

Helios silencers have casings made of galvanised steel sheet and they are provided with baffles made of high-quality mineral wool, which are covered with an abrasion-resistant fleece against the air flow.

**Technical information
Sound insulation**

■ The measure for sound insulation is insertion loss according to DIN EN ISO 14163. It shows the reduction in noise level in a round duct or rectangular duct piece with and without silencers determined by a comparison measurement.

For the measurement without silencers, a sound-reflecting piece is used instead. This determines the insertion loss:

$$D_b = L_o - L_m \text{ dB}$$

L_o : Level without silencer
 L_m : Level with silencer

Since the effects of a silencer are highly dependent on the frequency, the insertion loss depending on frequency is specified.

The damping of low frequency noises requires more damper volume than the damping of high frequency noises and is therefore associated with higher costs.

For these reasons, a knowledge of the fan noise spectrum (octave and third octave spectrum) is required for the selection of a silencer. When acoustically assessing a ventilation system, it should be noted that other system components, such as bends, cross-section changes

and branches also have a sound-insulating effect.

More detailed information can be found in VDI Guideline 2081 – noise generation and noise reduction in air-conditioning systems.

The lower limit for system noise emission is determined by the generation of flow noise in the silencer and in the system components. These increase significantly with increasing flow velocity. Therefore, the flow velocities should be kept as low as possible.

■ **Quick selection of a silencer**

An average insulation measurement is specified in the type table (red column far right) for the simple selection of round duct and rectangular duct silencers. This value should be deducted from the fan sound power level ($L_{WA \text{ tot.}}$). The result is the fan sound power level reduced by the sound insulation ($L_{WA \text{ reduc.}}$).

This selection method, which shows differences compared to the frequency band calculation, is based on rounding. A calculation according to the octave band (see adjacent example) produces more accurate values.

■ **Example:**
Available: Fan type VARD 225/2
Selected: Duct silencer RSD 225/600 (installation length = 600 mm)

Fan sound power level
 $L_{WA \text{ tot.}} = 81 \text{ dB(A)}$
Average silencer insulation measurement
minus = 15 dB(A)
= Reduced sound power level
 $L_{WA \text{ reduc.}} = 66 \text{ dB(A)}$

■ **Terms**
 $L_{WA \text{ tot.}}$ = Fan sound power level in dB(A) (from table above performance diagram).

Average insulation measurement = Derived damping capacity of the silencer in dB(A) (from red column in silencer type table).

$L_{WA \text{ reduc.}}$ = Sound power level reduced by silencer insertion in dB(A).

Sound level calculation

■ In order to calculate the sound level after insertion of a silencer, the insulation loss by frequency band must be deducted from the fan band level and the total sound level can then be calculated. This is normally done in octave bands. Multiple silencers with the same diameter can be arranged one behind the other for larger insertion losses. The example below explains the procedure. Given task: Noise reduction of fan type VARD 225/2 (2800 min⁻¹) using silencers RSD 225/600 (basic length 2).

	Octave mid-frequency Hz							dB(A)
	125	250	500	1000	2000	4000	8000	
A-weighted octave level $L_{WA, \text{Oct}}$ of fan VARD 225/2	51	62	74	76	76	72	63	
A-weighted total sound power level L_{WA}	$L_{WA} = 81 \text{ dB(A)}$							
Insertion loss of silencer D_b RSD 225/600 (2 x basic length)	4	10	17	27	25	17	14	
A-weighted octave level $L_{WA, \text{Oct}}$ of fan with silencer	47	52	57	49	51	55	49	
A-weighted total sound power level L_{WA}^* of fan with silencer	$L_{WA}^* = 10 \cdot \lg (10^{47 \cdot 0.1} + 10^{52 \cdot 0.1} + 10^{57 \cdot 0.1} + 10^{49 \cdot 0.1} + 10^{51 \cdot 0.1} + 10^{55 \cdot 0.1} + 10^{49 \cdot 0.1}) = 61 \text{ dB(A)}$							
Associated A-weighted sound pressure level at 1 m distance	$L_{pA}^* = 53 \text{ dB(A)}$							

KSD



Dimensions KSD

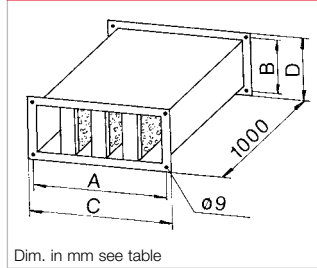

Dim. in mm see table

Pressure loss KSD

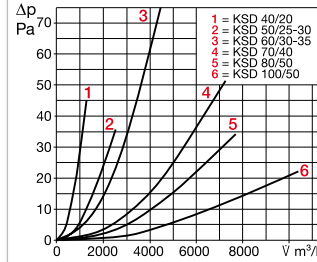

Rectangular duct silencer KSD

Design – Installation

Casing made of galvanised steel sheet, with connection flanges, dimensionally matched to the rectangular duct fans, for insertion on the inlet and outlet side of the rectangular duct system. The silencers upstream or downstream of the fan must be provided with a flexible connector (VS or VS Ex) to the further duct system to prevent structure-borne noise transmission.

Pressure loss

Rectangular duct silencers cause flow resistances (adjacent diagram) which must be taken into account for the design. These values apply for uniform flows. In case of non-uniform flows (e.g. for the outflow from rectangular duct fans), a straight duct piece at least 1 m in length must be used or allow for higher resistances.

Reference	Page
Selection - noise calculation	486

Type	Ref. no.	Nom. duct size in cm	No. links	Dimensions in mm				Weight approx. kg	Insulation loss D_e dB at Hz						Average loss	
				A	B	C	D		125	250	500	1000	2000	4000		8000
KSD 40/20	08728	40/20	3	420	220	443	240	13	8	11	23	31	31	26	18	17
KSD 50/25-30	08729	50/25-30	3	520	270/320	540	340	16.5	6	9	19	25	25	20	15	14
KSD 60/30-35	08730	60/30-35	4	620	320/370	640	390	20	7	10	21	28	28	23	16	12
KSD 70/40	08731	70/40	4	720	420	740	440	25	6	8	18	24	24	20	14	12
KSD 80/50	08732	80/50	5	820	520	840	540	31	7	9	19	26	26	21	15	14
KSD 100/50	08733	100/50	5	1020	520	1040	540	35	5	7	16	21	21	17	12	11

FSD



Dimensions FSD

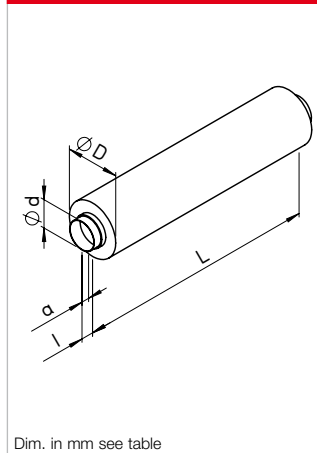

Dim. in mm see table

Flexible cross talk silencer FSD

Design – Installation

Robust design made of flexible aluminium duct. Perforated inner lining with resin-bonded sound insulation lining approx. 50 mm thick. Double-sided connectors, which can be inserted in the duct or connected to the fan or duct using a pipe clamp connector BM. The flexible design facilitates installation.

Pressure loss

Four times the friction resistance is taken into account for the system calculation.

Type	Ref. no.	Dimensions in mm					Insertion loss dB at Hz				Weight aprx. kg	Average loss
		L	Ø D	Ø d	a	l	250	500	1000	2000		
FSD 100	00676	1000	212	100	34	54	16	25	42	50	1.3	21
FSD 125	00677	1000	236	125	34	54	13	22	39	42	1.7	18
FSD 160	00678	1000	262	160	34	54	10	21	39	30	1.9	16
FSD 200	00679	1000	312	200	34	54	8	16	32	22	2.4	12
FSD 250	00680	1000	367	250	34	54	8	16	32	15	3	12
FSD 315	00681	1000	412	315	39	59	6	12	25	11	3.4	9
FSD 355	00682	1000	462	355	39	59	6	10	25	10	3.8	8
FSD 400	00683	1000	512	400	39	59	6	10	20	9	4.3	8

Reference	Page
Selection - noise calculation	486

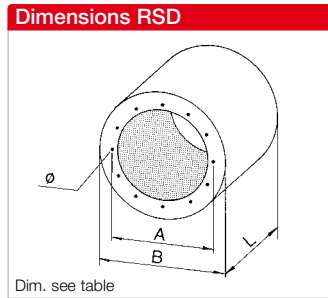

- **Insertion loss**
 Multiple silencers with the same diameter can be arranged one behind the other for larger insertion losses.
- **Pressure losses**
 The flow resistances of the RSD silencer are very low. Twice the friction resistance is taken into account for the system calculation.

■ **Design – Installation**
 Casing made of galvanised steel sheet. Lining with high-quality mineral wool, which is equipped with a fleece on the flow side for protection against abrasion. The dimensions and fixing holes of all sizes are based on the standard fan diameter (R 20). The fixing holes correspond to DIN 24155, p. 2.

Reference	Page
Selection - noise calculation	486

Type Nominal Ø	Ref. no.	Basic length	Dimensions in mm				Weight approx. kg	Insertion loss D _s dB								Average loss
			L	A	B	Hole Ø		125	250	500	1000	2000	4000	8000		
RSD 225/300	08734	1	300	259	404	6 x M 6	7	2	5	9	14	13	8	6	8	
RSD 225/600	08735	2	600	259	404	6 x M 6	12	4	10	17	27	25	17	14	15	
RSD 225/900	08736	3	900	259	404	6 x M 6	17	7	13	25	33	31	20	16	20	
RSD 250/300	08737	1	300	286	404	6 x M 6	7	3	5	8	8	9	7	5	8	
RSD 250/600	08738	2	600	286	404	6 x M 6	12	5	10	16	24	19	14	10	15	
RSD 250/900	08739	3	900	286	404	6 x M 6	16	6	12	22	28	21	15	11	18	
RSD 280/400	08740	1	400	322	454	8 x M 8	10	4	5	8	14	9	8	6	8	
RSD 280/800	08741	2	800	322	454	8 x M 8	18	7	9	16	28	18	17	14	14	
RSD 280/1200	08742	3	1200	322	454	8 x M 8	25	9	12	23	37	23	20	16	18	
RSD 315/400	08743	1	400	356	504	8 x M 8	11	3	3	7	13	8	7	5	5	
RSD 315/800	08744	2	800	356	504	8 x M 8	19	6	8	14	26	16	12	9	12	
RSD 315/1200	08745	3	1200	356	504	8 x M 8	28	9	12	21	36	18	17	14	18	
RSD 355/400	08746	1	400	395	564	8 x M 8	13	3	4	7	11	7	6	4	6	
RSD 355/800	08747	2	800	395	564	8 x M 8	23	6	7	13	22	14	12	8	11	
RSD 355/1200	08748	3	1200	395	564	8 x M 8	33	8	11	17	29	18	15	10	17	
RSD 400/400	08749	1	400	438	564	12 x M 8	12	3	4	6	9	7	5	3	6	
RSD 400/800	08750	2	800	438	564	12 x M 8	21	6	6	12	18	13	12	8	9	
RSD 400/1200	08751	3	1200	438	564	12 x M 8	30	7	10	14	22	18	13	9	15	
RSD 450/400	08752	1	400	487	634	12 x M 8	17	4	5	8	10	8	7	5	8	
RSD 450/800	08753	2	800	487	634	12 x M 8	27	6	7	13	18	13	12	9	11	
RSD 450/1200	08754	3	1200	487	634	12 x M 8	38	8	10	18	23	17	14	10	15	
RSD 500/600	08755	1	600	541	714	12 x M 8	27	4	5	9	11	9	9	6	8	
RSD 500/900	08756	2	900	541	714	12 x M 8	36	6	8	14	16	13	13	9	12	
RSD 500/1200	08757	3	1200	541	714	12 x M 8	45	8	11	22	24	17	16	12	17	
RSD 560/600	08758	1	600	605	804	8 x M 10	32	3	5	9	9	8	8	6	8	
RSD 560/1200	08759	2	1200	605	804	8 x M 10	52	6	10	19	19	16	13	10	15	
RSD 630/600	08760	1	600	674	900	8 x M 10	44	3	5	8	8	8	7	5	8	
RSD 630/1200	08761	2	1200	674	900	8 x M 10	68	5	10	16	15	15	11	8	15	
RSD 710/600	08762	1	600	751	1000	8 x M 10	51	3	5	7	7	7	6	4	8	
RSD 710/1200	08763	2	1200	751	1000	8 x M 10	80	5	10	14	13	13	10	7	15	
RSD 800/600	08764	1	600	837	1100	12 x M 10	57	2	5	7	6	6	5	4	8	
RSD 800/1200	08765	2	1200	837	1100	12 x M 10	88	5	9	13	11	11	9	6	14	
RSD 900/900	08766	1	900	934	1220	12 x M 10	82	2	4	10	9	6	5	4	6	
RSD 900/1800	08767	2	1800	934	1220	12 x M 10	135	4	9	21	17	13	9	8	14	
RSD 1000/900	08768	1	900	1043	1350	12 x M 10	96	2	4	8	7	5	4	3	6	
RSD 1000/1800	08769	2	1800	1043	1350	12 x M 10	157	4	7	16	14	10	7	6	11	
RSD 1120/900	08770	1	900	1174	1350	12 x M 10	81	2	3	7	6	4	3	3	5	
RSD 1120/1800	08771	2	1800	1174	1350	12 x M 10	136	3	6	14	11	8	6	5	9	
RSD 1250/900	08772	1	900	1311	1460	12 x M 10	86	1	2	5	4	3	2	2	3	
RSD 1250/1800	08773	2	1800	1311	1460	12 x M 10	146	2	4	11	9	7	5	4	6	

Firmly at the top. Helios roof fans.



**GERMAN
DESIGN
AWARD
WINNER
2021**



- EC roof fans, diagonal outlet, DV EC



498ff

Over 150 types in horizontal and vertical outlet designs with AC and efficient EC technology, in explosion-proof, T120 and smoke extraction versions and with volume flows from 540 to 70 000 m³/h – individual solutions are offered for every construction project.

- EC roof fans, horizontal and vertical outlet, RD and VD



504ff

- AC roof fans, horizontal and vertical outlet, also in T120 and explosion-proof versions, RD and VD



526ff

- Smoke extraction roof fans B VDD

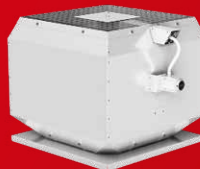

See TGA catalogue
Ref. no. 86979



- Accessories

For roof fans.



550ff

Roof fans



DV EC



This information supplements the "General technical information" and the information on the product page.

Series DV EC

Diagonal outlet centrifugal fans for exhaust air operation. With EC drive technology for energy-saving application and the lowest operating costs.

■ Design

Extremely weather-resistant EC roof fan in plastic design for an extensive area of application. Aerodynamically designed plastic casing made of grey polypropylene with diagonal air outlet direction. Air flow temperatures from -30 to +60 °C.

■ Drive

Energy-efficient EC external rotor motor in protection category IP54. Optimised efficiency, even with speed control for the lowest operating costs. Continuously variable speed control. Maintenance-free and radio interference-free, ball bearing mounted.

■ Impellers

Diagonal impeller made of aluminium, the motor-impeller unit is dynamically balanced for low-noise operation.

■ Contact protection

All units are delivered with an air outlet side protection grille according to DIN EN ISO 13857 as standard. If the system does not provide protection against touching rotating parts on the inlet side, a protection grille should also be attached here (Accessories).

■ Air flow temperatures

Air flow temperatures from -30 to +60 °C.

Power control
DV EC Pro

■ Ideal as a central exhaust air fan for multi-floor residential construction according to DIN 18017-3.

■ A complete central ventilation system according to DIN 18017-3 with demand-controlled ventilation can be constructed in combination with additional components (Accessories).

■ Integrated pressure control for volume flow stabilisation in the connected rooms through automatic speed adjustment with consistently good efficiency.

■ Integrated pressure sensor 0–300 Pa.

■ Short amortisation period due to high energy savings.

■ Operating data adjustment on the 4 potentiometers integrated in the control system for adjusting the desired operating point on site.

■ Integrated serial bus interface (RS 485) for connection to a PC/laptop in conjunction with the interface (Accessories).

Power control
DV EC Eco

■ All EC types have continuously variable speed control via potentiometer, universal control system or electronic differential pressure/temperature controller (in combination with the mains adapter NG 24, Accessories). Performance levels are shown on the performance curve as examples. Suitable control units can be found in the type table. Further information can be found in the "General technical information".

■ Electrical connection

Standard operating switch (protection category IP65) mounted on the outside of the casing. Connection voltage 1~, 230 V, 50 Hz.

■ Motor protection

Integrated electronic temperature monitoring system for EC motor and electronics.

■ Base formation, installation, delivery

The units are delivered ready for installation in individual shipping boxes or crates. The fans are quick and easy to install; they are equally suitable for mounting on flat, pitched, single pitch, saw-tooth, sloping, trapezoidal or arched roofs. In general, the roof bases must always be designed so that the fan base plate lies flat and horizontal.

We recommend the use of the flat roof base, sloping roof base or corrugated roof base offered in the accessories range. These bases reduce the costs for planning, design and installation to a minimum.

The bases can also be created on site e.g. from concrete, wood, bricks or the like. A horizontal and flat surface is just as indispensable as a proper seal with the roof edge. Once positioned, the base plate is fastened to the base with 4 screws.

Helios flat roof bases and base silencers NS 180–450 mm have a hinge mechanism which is beneficial when it comes to cleaning and inspection. With regard to on-site bases, spacers should be used to compensate for any unevenness.

A gap between the base plate and base should be sealed with elastic tape or similar material. Once the screws have been evenly tightened, check the

■ Noise

Further information can be found on the product pages and the "General technical information".

Reference	Page
Planning information, acoustics, explos. protection	10 ff.
General techn. information, power control	15 ff.

RD EC



VD EC



Series RD EC

Horizontal outlet EC centrifugal fans for exhaust air operation with efficiency-optimised aluminium casing and newly developed high-performance centrifugal impeller.

Series VD EC

Vertical outlet EC roof fan with efficiency-optimised aluminium casing and newly developed high-performance centrifugal impeller.

Common features RD EC and VD EC

■ Design

Robust and weather-resistant design. Motor support plate and base plate with inlet nozzle made of galvanised steel. Casing made of sea water-resistant aluminium with integrated tamper protection. Base plate made of galvanised steel sheet with inlet nozzle made of aluminium for all explosion-proof types. Smooth running due to vibration-damping motor suspension. Flat design.

■ Drive

External rotor motors in protection category IP44, IP54, IP4X and insulation class F according to DIN EN 60034 / VDE 0530 and DIN EN 60335-1 / VDE 0700-1 are used for the EC types. The winding is also protected against moisture. The maintenance-free ball bearings have a lubricant supply for a period of approx. 30000 operating hours. Motor and impeller dynamically balanced as a unit according to DIN ISO 21940-11, quality grade 6.3 for low-vibration operation.

■ Impellers

High-performance centrifugal impellers with backward curved blades made of plastic, steel sheet or aluminium. Dynamically balanced according to DIN ISO 21940-11 – quality grade 6.3.

■ Contact protection

All units are delivered with an air outlet side protection grille according to DIN EN ISO 13857 as standard. If the system does not provide protection against touching rotating parts on the inlet side, a protection grille should also be attached here (Accessories).

■ Air flow temperatures

The range of application for EC types is up to +60 °C.

■ Power control

All EC types have continuously variable speed control via internal (delivery) or external potentiometer, universal control system or electronic differential pressure/temperature controller (in combination with the mains adapter NG24, Accessories). Performance levels are shown on the performance curve as examples. Suitable control units can be found in the type table. Further information can be found in the "General technical information".

■ Electrical connection

ND 180 – 250 to external terminal box in protection category IP65. ND 315 – 630 to external terminal box and isolator switch in protection category IP65.

■ Motor protection

Integrated electronic temperature monitoring system for EC motor and electronics.

■ Installation

The roof fans must be installed horizontally. In case of sloping roofs, a corresponding base formation must be used to prevent water ingress.

■ Delivery

Units are ready-for-connection, fully pre-assembled in the shipping box / wooden crate. Simple positioning with standard crane hook from ND 450 upwards.

■ Noise

Further information can be found on the product pages and the "General technical information".

Reference	Page
Planning information, acoustics, explos. protection	10 ff.
General techn. information, power control	15 ff.

RD



Also available
in version:



VD



Also available
in version:



Common features
RD, VD and VD T120

■ **Design**

Robust and weather-resistant design. Motor support plate and base plate with inlet nozzle made of galvanised steel. Casing made of sea water-resistant aluminium with integrated tamper protection. Base plate made of galvanised steel sheet with inlet nozzle made of aluminium for all explosion-proof types. Smooth running due to vibration-damping motor suspension. Flat design.

■ **Drive**

Speed-controllable external rotor motors located inside the air flow in closed design and protection category IP44 or IP54 and insulation class F according to DIN EN 60034 / VDE 0530 and DIN EN 60335-1 / VDE 0700-1 are used for the AC types. The winding is also protected against moisture. The maintenance-free ball bearings have a lubricant supply for a period of approx. 30000 operating hours. Motor and impeller dynamically balanced as a unit according to DIN ISO 21940-11, quality grade 6.3 for low-vibration operation.

■ **Impellers**

High-performance centrifugal impellers with backward curved blades made of galvanised steel sheet, plastic or aluminium. Dynamically balanced according to DIN ISO 21940-11 – quality grade 6.3.

■ **Contact protection**

All units are delivered with an air outlet side protection grille according to DIN EN ISO 13857 as standard. If the system does not provide protection against touching rotating parts on the inlet side, a protection grille should also be attached here (Accessories).

■ **Air flow temperatures**

The units can be used in the range from -20 °C to $+70\text{ °C}$. The upper limit value is type-specific and can be found in the table on the product page. If the fan is speed-controllable, this value should be reduced by approx. 10 °C . Explosion-proof types are approved up to max. $+40\text{ °C}$. VD T120: The units can be used in the range from -30 °C up to max. $+120\text{ °C}$. Compliant with VDI 2052.

■ **Power control**

Further information can be found on the product pages and the “General technical information”. The voltage-controllable types can be identified by a value in the column “Current consumption with control”.

■ **Electrical connection**

The supply line can be connected from below via a cable opening in the base plate or from above (via the roof). The connection to the external terminal box or isolator switch must be carried out without dismantling other parts in accordance with the provided wiring diagram.

■ **Motor protection**

Further information can be found on the product pages and the “General technical information”.

■ **Incorrect direction of rotation**

The units are only suitable for exhaust air operation. Operation in the incorrect direction of rotation overloads the motor and causes the thermal contacts or PTC thermistor to respond. Typical concomitant features include virtually non-existent flow rate, vibration and abnormal noise.

■ **Installation**

The roof fans must be installed horizontally. In case of sloping roofs, a corresponding base formation must be used to prevent water ingress. See series DV EC for delivery and base formation.

■ **Explosion protection**

The explosion-proof types correspond to unit group II, category 3 G for use in zone 2 in accordance with Directive 2014/34/EU.

The explosion-proof types $\text{Ø } 315$ to $\text{Ø } 560$ correspond to unit group II, category 2G for use in zone 1 in accordance with Directive 2014/34/EU.

The EU declaration of conformity provided with each fan certifies the design according to DIN EN 60079-0 / VDE 0170-1 and DIN EN 60079-7 / VDE 0170-6. The protection category corresponds to Ex e 2G.

The temperature class is noted on the type page. The external terminal box also corresponds to Ex e 2G.

See “Planning information Explosion protection” and “General technical information” for further information.

In accordance with EU Directive 2014/34/EU, larger air gaps are required, which can lead to a performance reduction of up to 10 %.

■ **Noise**

Further information can be found on the product pages and the “General technical information”.

Reference	Page
Planning information, acoustics, explos. protection	10 ff.
General techn. information, power control	15 ff.

By combining the parameters of static pressure increase Δp_{fa} , speed min^{-1} and inlet side air noise as sound pressure at

4 m (free field conditions), the following table facilitates the selection of EC roof fans.

	Speed	Sound press. inlet side	Flow rate \dot{V} m ³ /h depending on static pressure = N / m^2 = freely available pressure																	
	min^{-1}	L_{pA} dB(A)	(Δp_{fa}) in Pa																	
		at 4 m dist.	0	50	100	150	200	250	300	350	400	450								
Type DV EC																				
DV EC 200	1810	50	2010	1830	1660	1480	1270	1030	720	350										
DV EC 250	1640	55	3700	3480	3210	2930	2700	2420	2090	1690	1240	240								
DV EC 400 A	1020	48	4070	3660	3220	2720	2200	1610	980											
DV EC 400 B	1425	60	5650	5470	5100	4760	4480	4150	3800	3440	3000	1870								

	Speed	Sound press. inlet side	Flow rate \dot{V} m ³ /h depending on static pressure = N / m^2 = freely available pressure																		
	min^{-1}	L_{pA} dB(A)	(Δp_{fa}) in Pa																		
		at 4 m dist.	0	50	100	150	200	300	400	500	600	700	800	1000							
Type RD EC																					
RDW EC 180	3360	57	670	650	620	600	570	500	410	260											
RDW EC 200	2650	57	1180	1120	1040	950	870	670	500	310											
RDW EC 225 A	2550	52	1310	1250	1160	1080	1000	810	600	370	160										
RDW EC 225 B	3020	60	1500	1440	1380	1330	1270	1150	1010	850	550										
RDW EC 250	2705	61	1890	1840	1790	1730	1660	1510	1330	1140	920	600									
RDW EC 315	1650	55	3460	3330	3190	3030	2840	2440	1730	80											
RDD EC 315	1700	55	3450	3320	3190	3060	2910	2540	2000	910											
RDW EC 355	1700	59	5370	5190	5030	4870	4690	4280	3850	3260	2260										
RDD EC 355	1750	60	5310	5160	5000	4820	4650	4300	3870	3350	2610	280									
RDW EC 400	1500	60	6710	6520	6310	6100	5850	5350	4730	3980	2470										
RDD EC 400	1500	60	6420	6250	6080	5870	5660	5180	4600	3800	2360										
RDW EC 450	1300	60	8020	7760	7480	7180	6870	6260	5490	4390	840										
RDD EC 450 A	1425	63	8740	8520	8280	8030	7770	7240	6570	5800	4780	2300									
RDD EC 450 B	1800	69	10730	10540	10360	10160	9970	9560	9120	8690	8230	7680	7100	5380							
RDD EC 500 A	1400	65	12680	12370	12070	11770	11470	10750	10010	9160	8130	6820	4350								
RDD EC 500 B	1550	68	13550	13280	13000	12720	12420	11820	11220	10540	9740	8920	7960	3940							
RDD EC 560	1100	63	14020	13660	13280	12880	12460	11490	10450	9010	6900	380									
RDD EC 630	940	67	17680	17240	16750	16180	15590	14380	12860	10560	5580										

	Speed	Sound press. inlet side	Flow rate \dot{V} m ³ /h depending on static pressure = N / m^2 = freely available pressure																			
	min^{-1}	L_{pA} dB(A)	(Δp_{fa}) in Pa																			
		at 4 m dist.	0	50	100	150	200	300	400	500	600	700	800	1000								
Type VD EC																						
VDW EC 180	3330	54	670	640	610	570	540	460	370	210												
VDW EC 200	2670	55	1150	1070	1000	920	850	680	500	320	0											
VDW EC 225 A	2500	53	1260	1200	1120	1050	960	780	580	350	150											
VDW EC 225 B	3015	58	1430	1380	1320	1270	1200	1080	930	730	380											
VDW EC 250	2740	59	1820	1770	1720	1670	1600	1450	1280	1080	860	530										
VDW EC 315	1650	55	3440	3310	3170	3020	2860	2400	1630	180												
VDD EC 315	1700	55	3420	3290	3170	3040	2880	2480	1900	720												
VDW EC 355	1700	58	5070	4920	4780	4630	4470	4090	3570	2940	1870											
VDD EC 355	1750	59	5020	4890	4750	4610	4460	4120	3700	3100	2200	790										
VDW EC 400	1500	60	6180	6010	5820	5620	5400	4880	4230	3380	1630											
VDD EC 400	1500	59	6040	5870	5680	5450	5220	4770	4130	3300	1590											
VDW EC 450	1300	59	7350	7110	6870	6630	6330	5580	4640	3090	570											
VDD EC 450 A	1425	62	7990	7780	7560	7340	7090	6490	5810	4840	3360	1030										
VDD EC 450 B	1800	68	9940	9780	9620	9450	9270	8850	8420	7950	7390	6720	5850	3400								
VDD EC 500 A	1400	65	11100	10860	10620	10370	10100	9490	8760	7900	6730	5070	2620									
VDD EC 500 B	1550	68	11890	11690	11490	11270	11020	10480	9960	9310	8530	7630	6390	2100								
VDD EC 560	1100	62	12380	12050	11730	11380	10990	10050	9000	7390	4560	410										
VDD EC 630	940	67	15910	15500	15070	14570	14000	12710	11070	8370	2510											

Roof fans RD and VD

Selection table



By combining the parameters of static pressure increase Δp_{ra} , speed min^{-1} and inlet side air noise as sound pressure at

4 m (free field conditions), the following table facilitates the selection of AC roof fans.

Type	Speed	Sound press. inlet side	Flow rate $V \text{ m}^3/\text{h}$ depending on static pressure = N / m^2 = freely available pressure																
	min^{-1}	$L_{pA} \text{ dB(A)}$	(Δp_{ra}) in Pa																
		at 4 m dist.	0	50	100	150	200	250	300	400	500	600	800	1000	1200				
Type RD																			
RDW 180/2	2295	41	550	490	440	360	290	200	120										
RDW 200/2	2430	48	1060	990	930	840	770	670	580	310									
RDW 200/4	1375	36	550	430	290														
RDW 225/2	2635	52	1310	1250	1200	1130	1060	990	930	760	520	90							
RDW 225/4	1340	36	650	550	410	30													
RDW 250/4	1340	38	920	800	630	440													
RDW 315/4	1385	46	2900	2720	2550	2330	2090	1830	1380										
RDD 315/4	1385	46	2890	2700	2510	2280	2060	1760	1290										
RDW 355/4	1400	46	4450	4260	4030	3790	3560	3280	2890	1870									
RDD 355/4	1350	46	4470	4230	4000	3700	3410	3120	2740	1650									
RDW 400/4	1405	51	6150	5920	5690	5450	5180	4910	4640	3970	2910	650							
RDD 400/4	1375	50	5950	5690	5430	5130	4850	4580	4230	3340	2050	310							
RDD 400/6	905	41	4030	3600	3180	2650	1910	420											
RDW 450/4	1385	54	8630	8340	8060	7770	7500	7200	6880	6220	5360	4240							
RDD 450/4	1400	54	8630	8380	8120	7840	7550	7270	6990	6280	5540	4400							
RDD 450/6	905	45	5830	5430	4910	4410	3780	2910	1530										
RDD 500/4	1340	56	12060	11710	11360	11000	10660	10310	9920	9140	8150	6980	3810						
RDD 500/6	885	47	8300	7750	7200	6670	5970	4990	3930	870									
RDD 560/4	1380	61	15660	15360	15040	14690	14320	13940	13570	12780	11960	11040	8810	5350	1220				
RDD 560/6	920	52	9820	9390	8960	8520	8100	7650	7130	5860	270								
RDD 630/6	930	59	15770	15200	14520	13870	13280	12580	11990	10460	8520	830							
RDD 710/6	968	63	26070	25460	24830	24150	23460	22790	22100	20390	18330	15660	6860						
Type VD																			
VDW 180/2	2315	40	540	500	430	360	290	200	110										
VDW 200/2	2430	48	1000	940	870	790	700	610	500	240									
VDW 200/4	1375	32	530	420	250														
VDW 225/2	2635	51	1290	1240	1170	1100	1030	950	880	680	410	70							
VDW 225/4	1340	37	640	540	370	30													
VDW 250/4	1340	38	900	780	610	380													
VDW 315/4	1385	46	2850	2670	2480	2290	2050	1720	1200	150									
VDD 315/4	1385	45	2870	2680	2500	2270	2020	1660	1130										
VDW 355/4	1400	46	4290	4100	3880	3660	3390	3090	2710	1690	230								
VDD 355/4	1350	46	4280	4050	3830	3600	3300	2990	2550	1470	120								
VDW 400/4	1405	51	5820	5610	5370	5110	4850	4600	4290	3480	2300	760							
VDD 400/4	1375	49	5590	5340	5100	4830	4530	4190	3820	2940	1600	390							
VDD 400/6	905	41	3760	3440	2970	2380	1590	590											
VDW 450/4	1385	53	7740	7520	7290	7030	6760	6450	6110	5390	4360	3000							
VDD 450/4	1400	53	7870	7640	7400	7140	6890	6630	6280	5560	4400	3170							
VDD 450/6	905	44	5210	4860	4390	3840	3150	2200	1100										
VDD 500/4	1340	56	10550	10280	10000	9690	9380	9080	8740	7940	7040	5880	2780						
VDD 500/6	885	47	7240	6760	6290	5710	5090	4310	3220	760									
VDD 560/4	1380	62	14060	13760	13450	13100	12720	12370	12050	11270	10440	9530	7400	4730	1480				
VDD 560/6	920	52	9240	8760	8350	7950	7500	7010	6450	4860	970								
VDD 630/6	930	58	14430	13780	13240	12670	12020	11390	10780	9110	6440	1100							
VDD 710/6	968	62	23760	23210	22630	21980	21260	20470	19700	17940	15800	13000	5000						

By combining the parameters of static pressure increase Δp_{ra} , speed min^{-1} and inlet side air noise as sound pressure at

4 m (free field conditions), the following table facilitates the selection of Ex and T120 roof fans.

	Speed	Sound press. inlet side	Flow rate $V \text{ m}^3/\text{h}$ depending on static pressure = N / m^2 = freely available pressure															
	min^{-1}	$L_{PA} \text{ dB(A)}$	(Δp_{ra}) in Pa															
		at 4 m dist.	0	50	100	150	200	250	300	400	500	600	700	800	900			
Type RD Ex																		
RDD 200/4 Ex	1465	41	600	510	380	60												
RDD 225/4 Ex	1445	43	850	760	620	400	0											
RDD 250/4 Ex	1400	46	1350	1230	1070	850	500											
RDD 315/4 Ex	1390	52	2890	2740	2590	2380	2180	1880	1450									
RDD 355/4 Ex	1345	58	4350	4120	3890	3660	3430	3130	2750	1600								
RDD 400/4 Ex	1395	63	6030	5860	5670	5440	5220	4980	4700	3970	2860	630						
RDD 400/6 Ex	930	52	3840	3500	3170	2760	2330	200										
RDD 450/4 Ex	1405	65	8580	8360	8120	7880	7620	7370	7120	6520	5780	4840	2710					
RDD 450/6 Ex	870	55	5640	5140	4650	4150	3560	2670	890									
RDD 500/4 Ex	1420	69	10310	9920	9560	9230	8920	8620	8320	7720	7060	6250	5170	1090				
RDD 500/6 Ex	840	58	6540	5850	5290	4580	3950	3300	690									
RDD 560/6 Ex	865	62	9420	8820	8330	7830	7320	6690	6080	3470								
RDD 630/6 Ex	905	68	16480	15930	15400	14850	14260	13600	12840	11110	8670	4340						
Type VD Ex			0	50	100	150	200	250	300	400	500	600	700	800	900			
VDD 200/4 Ex	1465	39	580	480	360	90												
VDD 225/4 Ex	1450	41	810	700	600	340												
VDD 250/4 Ex	1400	45	1280	1150	980	740	400											
VDD 315/4 Ex	1390	51	2760	2620	2470	2280	2030	1740	1310	70								
VDD 355/4 Ex	1350	57	4310	4120	3910	3630	3400	3060	2720	1590	230							
VDD 400/4 Ex	1375	62	5640	5460	5260	5050	4840	4580	4280	3560	2380	750						
VDD 400/6 Ex	930	52	3620	3300	2960	2480	1910	380										
VDD 450/4 Ex	1405	65	7920	7720	7500	7240	6980	6720	6390	5670	4720	3460	1870	240				
VDD 450/6 Ex	875	54	5170	4810	4350	3810	2990	1900	820									
VDD 500/4 Ex	1405	67	9360	9090	8810	8500	8190	7880	7580	6900	6170	5330	4130	990	0			
VDD 500/6 Ex	840	56	5850	5330	4830	4200	3530	2610	1230									
VDD 560/6 Ex	860	60	8460	7920	7480	7040	6580	5950	5210	1780								
VDD 630/6 Ex	910	67	14690	14220	13700	13140	12610	11920	11140	9280	6180	2670	180					

	Speed	Sound press. inlet side	Flow rate $V \text{ m}^3/\text{h}$ depending on static pressure = N / m^2 = freely available pressure															
	min^{-1}	$L_{PA} \text{ dB(A)}$	(Δp_{ra}) in Pa															
		at 4 m dist.	0	50	100	150	200	250	300	400	500	600	800	1000	1200			
Type VD T120																		
VDD 315/4 T120	1450	53	3362	3215	3053	2871	2664	2419	2116	887								
VDD 355/4 T120	1400	55	4540	4385	4217	4035	3834	3610	3352	2657								
VDD 400/4 T120	1400	54	6747	6557	6352	6129	5884	5614	5310	4568	3528	1698						
VDD 400/6 T120	967	46	4531	4232	3887	3475	2947	2155										
VDD 450/4 T120	1355	60	9479	9292	9093	8877	8643	8387	8103	7423	6501	5098						
VDD 450/6 T120	940	53	6398	6105	5762	5348	4824	4111	3038									
VDD 500/4 T120	1465	61	14001	13762	13514	13256	12987	12704	12406	11748	10971	9994	6202					
VDD 500/6 T120	945	52	9405	9038	8621	8131	7527	6719	5461	796								
VDD 560/4 T120	1480	63	16172	15942	15697	15435	15154	14853	14530	13809	12985	12061	9961	7462	2671			
VDD 560/6 T120	965	52	12200	11821	11403	10937	10408	9792	9049	6780	1699							
VDD 630/6 T120	985	63	19467	19039	18588	18110	17598	17043	16435	14976	12873	8159						
VDD 710/6 T120	985	62	24470	23974	23442	22870	22251	21580	20848	19169	17125	14600	6879					

Helios roof fans – versatile all-rounders.



Cafeterias and recreation rooms

Series VD:

The vertical discharge series VD is the perfect partner for various applications in residential, commercial and public buildings. Especially in highly frequented areas, VD demonstrates its advantages and it can be ideally integrated in a comprehensive Helios ventilation system.

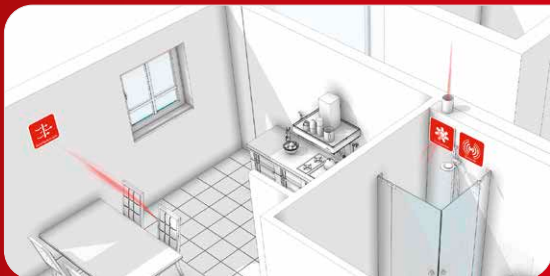

Apartment buildings

Series RD:

The roof fans in series RD discharge horizontally and they are also characterised by extremely flexible applications. Ideal for residential buildings, workplaces or public buildings.



Commercial kitchens and production halls

Series VD T120:

Specialising in increased temperatures, the series VD T120 is predestined for areas with high levels of waste heat and for air flow temperatures of up to 120 °C. The exhaust air is extracted directly at its source, safely and hygienically due to the motor located outside of the air flow.



Shopping centres

Series B VD F400/F600:

Developed to withstand the most extreme conditions, the series B VD F400/F600 are invaluable lifesavers in case of fire. Thanks to their dual functionality, they can be used for everyday ventilation, e.g. in assembly areas and sales outlets, in addition to smoke extraction.



Fuel depots

Series RD / VD Ex:

Whether it is fuel depots, battery production or other potentially explosive atmospheres: The RD / VD Ex roof fans are reliable solutions thanks to the explosion protection – even in highly sensitive fuel depots.

Centrifugal roof fan RD, horizontal outlet.

Favourable price/performance ratio. Horizontal outlet roof fan with efficiency-optimised aluminium casing and newly developed high-performance centrifugal impeller.

EC roof fans DV, diagonal outlet.

With energy-saving EC drive technology for the lowest operating costs. Extremely weather-resistant in plastic design. Optionally available in Pro version with integrated pressure control for volume flow stabilisation (no Figure).

Centrifugal roof fans VD, vertical outlet.

Favourable price/performance ratio. Vertical outlet roof fan with efficiency-optimised aluminium casing or casing made of galvanised steel sheet and newly developed high-performance centrifugal impeller.

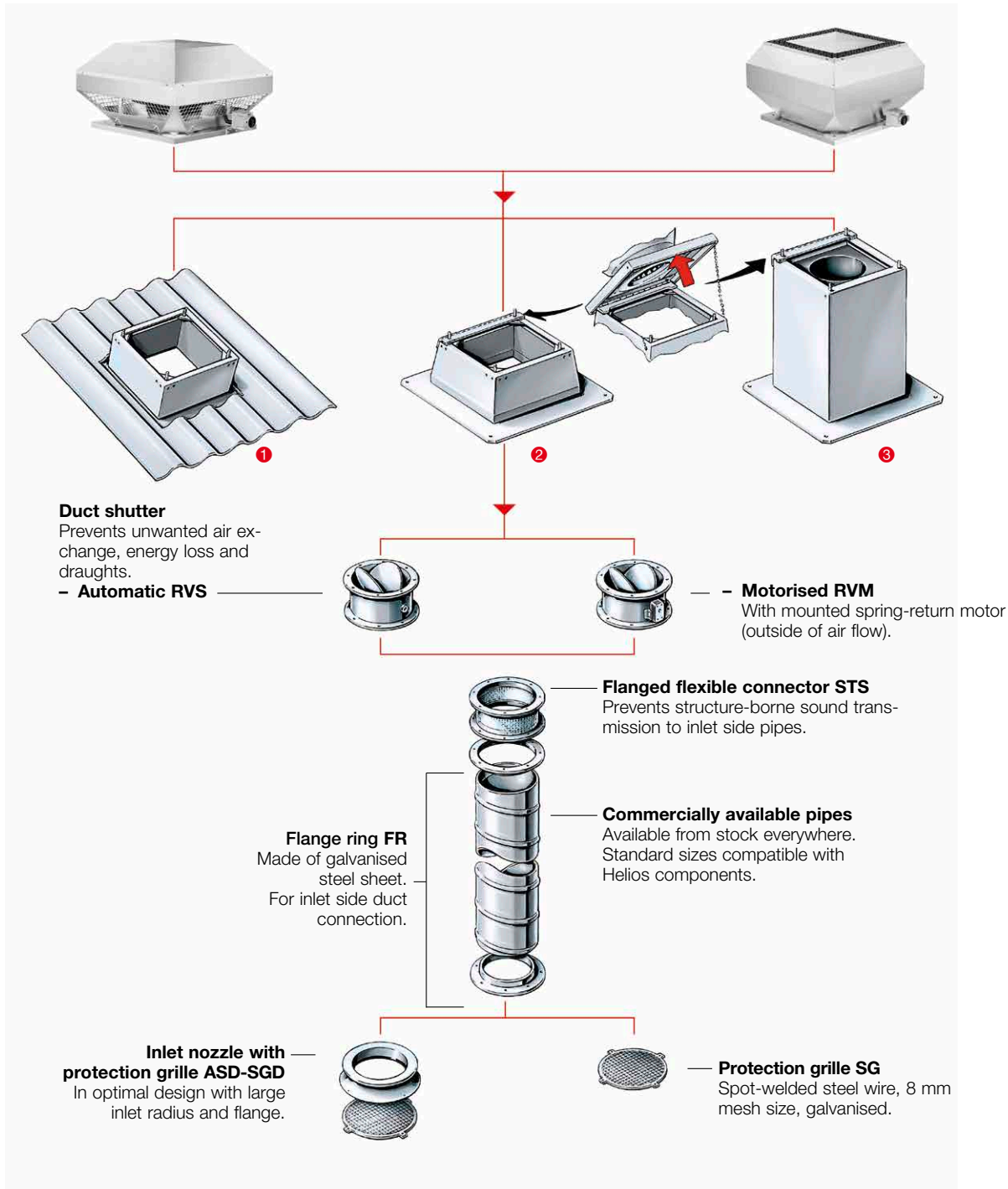

1 Corrugated roof base WDS

For the installation of roof fans and ventilation hoods on corrugated roofs. Weather-resistant and non-corrosive made of glass fibre reinforced polyester.

Pitched roof base SDS

For the installation of roof fans/ventilation hoods on pitched or trapezoidal roofs. Sound and heat insulated lining on the inside.

2 Flat roof base FDS

For the cost-effective and efficient installation of roof fans and ventilation hoods on flat roofs. In corrosion-resistant GFK version or made of galvanised steel sheet. NS 180 to 450 mm with hinged mechanism for easy inspection and cleaning.

3 Base silencer SSD

For inlet side noise reduction. All metal parts made of galvanised steel sheet. Incl. fixing screws, rubber profile and seal between the base and base plate. NS 180 to 450 mm with hinged mechanism and foam core with free cross-section. Allows access to the duct/shaft system.

DV EC 200



Dimensions DV EC 200

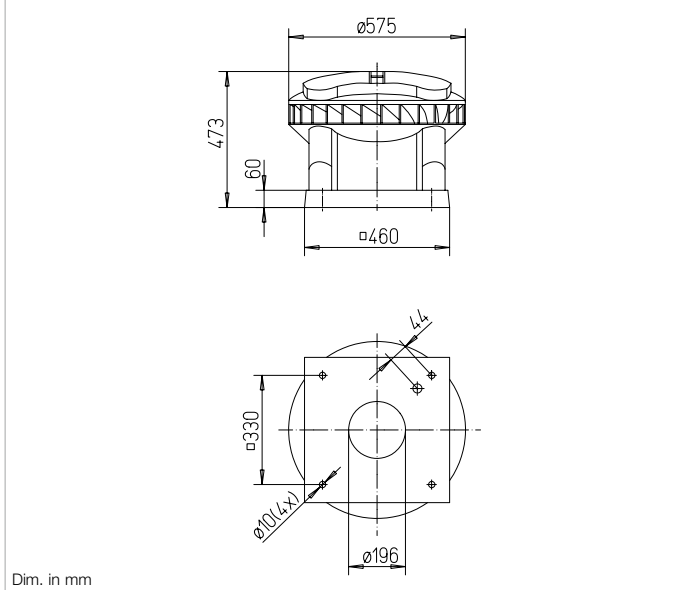

Dim. in mm

Extremely weather-resistant EC roof fan in plastic design for an extensive range of applications, diagonal outlet.

**Common features
 DV EC Pro and DV EC Eco**

- Casing**
 Aerodynamically designed plastic casing made of grey polypropylene with diagonal air outlet direction. Air flow temperatures from -30 to +60 °C.
- Impeller**
 Diagonal impeller made of aluminium, the motor impeller unit is dynamically balanced for low-noise operation.
- Drive**
 Energy-efficient EC external rotor motor in protection category IP54. Optimised efficiency even with speed control for low operating costs. Continuously variable speed control. Maintenance-free and radio interference-free, ball bearing mounted.
- Motor protection**
 Integrated electronic temperature monitoring system for EC motor and electronics.

- Electrical connection**
 Standard operating switch (protection category IP65) mounted on the outside of the casing. Connection voltage 1~, 230 V, 50 Hz.
- Installation**
 Horizontal alignment on the roof. In case of sloping roofs, a corresponding base formation must be used to prevent water ingress. A range of accessories facilitates the installation of the fan in the building duct system.
- Noise**
 The total level and range are specified above the performance diagram for:

 - Inlet side sound power
 - Outlet side sound power.

The case-radiated noise as sound pressure at 4 m (free field conditions) is also specified in the type table and the table below the performance curve.

PRO

**Description
 DV EC Pro**

- Power control**

 - Ideal as a central exhaust air fan for multi-floor residential construction in accordance with DIN 18017-3.
 - When combined with other components (accessories), a complete central ventilation system in accordance with DIN 18017-3 can be created with demand-driven ventilation.
 - Integrated pressure control for constant volume flow control in the connected rooms through automatic speed adjustment at almost constantly high efficiency.
 - Integrated pressure sensor 0–300 Pa.
 - Short amortisation period due to high energy saving.
 - Operating data setting at the 4 potentiometers integrated in the control system to set the desired operating point on site.
 - Integrated serial bus interface (RS 485) for connection to a PC/laptop in connection with the interface (accessories).

ECO

**Description
 DV EC Eco**

- Power control**

 - Continuously variable speed control with speed potentiometer PU/PA 10 (accessories, see type table).
 - When combined with the universal control system EUR EC or electronic pressure/temperature controllers EDR/ETR (accessories, see type table), the fan can be used for the continuously variable control of differential pressure, differential temperature or flow velocity. Performance levels are shown in the performance curve as an example.

Type	Ref. no.	Maximum speed approx.	Flow rate Free blowing	Noise sound press.	Power consumption at maximum speed		Wiring diagram	Max. air flow-temp.	Wgt net aprx.	Universal control system		Speed potentiometer			
					kW	A				Type	Ref. no.	Type	Ref. no.	Type	Ref. no.
		min ⁻¹	V m ³ /h	dB(A) in 4 m	kW	A	No.	+ °C	kg	Type	Ref. no.	Type	Ref. no.	Type	Ref. no.
PRO Type DV EC Pro, Single-phase alternating current, 230 V, 50/60 Hz, EC motor, IP54															
DV EC 200 Pro	08385	1810	2010	52	0.18	1.38	863.1	60	17.0	–	–	–	–	–	–
ECO Type DV EC Eco, Single-phase alternating current, 230 V, 50/60 Hz, EC motor, IP54															
DV EC 200 Eco	08320	1810	2010	52	0.18	1.38	991	60	17.0	EUR EC ¹⁾²⁾	01347	PU 10 ³⁾	01734	PA 10 ³⁾	01735

1) Multiple EC fans can normally be connected.

2) Alternative elec. pressure/temp. controller (EDR/ETR, no. 01437/01438) in combination with mains adapter NG 24, no. 01439, see accessories.

Performance curves DV EC 200

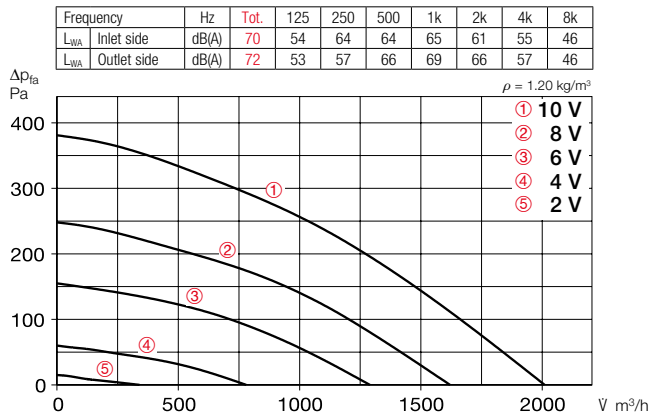

Free blowing						
Voltage V	n min ⁻¹	V m ³ /h	P W	I A	Lp dB(A)	SFP kW/m ³ /s
10	1810	2010	180	1.38	52	—
8	1480	1620	108	0.90	47	—
6	1200	1290	60	0.54	41	—
4	720	780	21	0.20	31	—

Accessory details Page

Roof install. accessories	550 f.
Ventilation grilles	552 ff.
Exhaust air elements	566 ff.
Intake air elements	578 ff.
Fire protection systems	582 ff.
Universal control systems, electronic controllers, speed potentiometer	605 ff.

Accessories for all types

Base silencer
SSD 200 Ref. no. 05290
With hinge mechanism for easy inspection and cleaning.

Flange connection plate
FAP 200 Ref. no. 08382
Made of galvanised steel sheet. Allows the connection of the duct system and accessories to the roof fans DV EC if no base silencer SSD is used.

Flat roof base
FDS 200 Ref. no. 01378
With hinge mechanism for easy inspection and cleaning.

Counter flange
DFR 200 Ref. no. 01201
Made of galvanised steel sheet, for inlet-side duct connection.

Flanged flexible connector
DSTS 200 Ref. no. 01218
For the prevention of structure-borne noise transmission to inlet-side ducts. Flanges made of galvanised steel sheet.

Duct shutter
DRVS 200 Ref. no. 02591
Automatic, made of galvanised steel sheet. Prevents cold draughts when the fan is at a standstill. For vertical throughflow from bottom to top.

Accessories for DV EC Pro

Interface
ZLS-IF Ref. no. 08391
Interface for commissioning or controlling the fan in combination with a PC/Laptop via a USB port. The software can be downloaded and installed free of charge.

Electronic timer module
ZLS-ZU 31 Ref. no. 08388
Allows the parallel operation of max. 31 DV EC roof fans. The rocker switch is used to enable the DV EC fans. The day and night switchover takes place via the settings in the display. Incl. main switch. 230 V, 50 Hz.

Accessories for DV EC Eco

Universal control system
EUR EC Ref. no. 01347
For the continuously variable control or regulation of single and three-phase EC fans with a setpoint of 0–10 V DC.

Speed potentiometer
PU/PA 10 See type table
For the direct control/setpoint setting of EC fans with a potentiometer input.



	Timer for controlling max. 31 fans	
Type		Ref. no.
ZLS-ZU 31		08388
—		—

³⁾ W/o LED supply.

DV EC 250



Dimensions DV EC 250

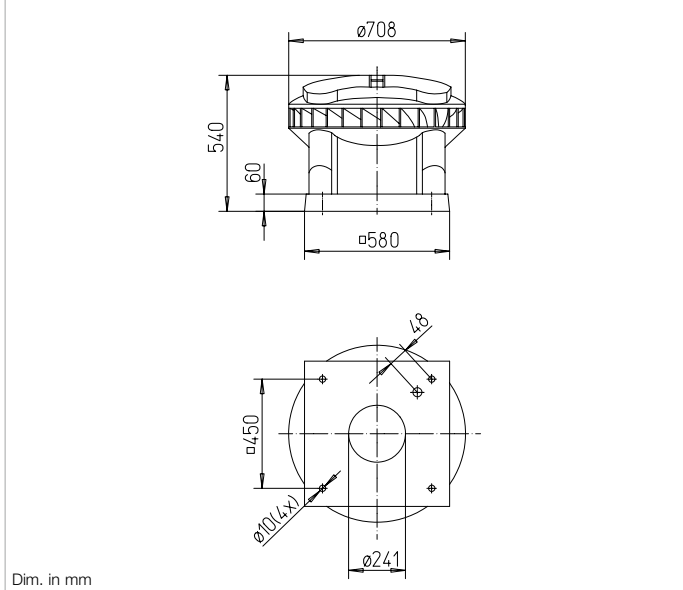

Dim. in mm

Extremely weather-resistant EC roof fan in plastic design for an extensive range of applications, diagonal outlet.

Common features
 DV EC Pro and DV EC Eco

- **Casing**
 Aerodynamically designed plastic casing made of grey polypropylene with diagonal air outlet direction. Air flow temperatures from -30 to +60 °C.
- **Impeller**
 Diagonal impeller made of aluminium, the motor impeller unit is dynamically balanced for low-noise operation.
- **Drive**
 Energy-efficient EC external rotor motor in protection category IP54. Optimised efficiency even with speed control for low operating costs. Continuously variable speed control. Maintenance-free and radio interference-free, ball bearing mounted.
- **Motor protection**
 Integrated electronic temperature monitoring system for EC motor and electronics.

- **Electrical connection**
 Standard operating switch (protection category IP65) mounted on the outside of the casing. Connection voltage 1~, 230 V, 50 Hz.
- **Installation**
 Horizontal alignment on the roof. In case of sloping roofs, a corresponding base formation must be used to prevent water ingress. A range of accessories facilitates the installation of the fan in the building duct system.
- **Noise**
 The total level and range are specified above the performance diagram for:
 - Inlet side sound power
 - Outlet side sound power.
 The case-radiated noise as sound pressure at 4 m (free field conditions) is also specified in the type table and the table below the performance curve.

PRO

Description
 DV EC Pro

- **Power control**
 - Ideal as a central exhaust air fan for multi-floor residential construction in accordance with DIN 18017-3.
 - When combined with other components (accessories), a complete central ventilation system in accordance with DIN 18017-3 can be created with demand-driven ventilation.
 - Integrated pressure control for constant volume flow control in the connected rooms through automatic speed adjustment at almost constantly high efficiency.
 - Integrated pressure sensor 0–300 Pa.
 - Short amortisation period due to high energy saving.
 - Operating data setting at the 4 potentiometers integrated in the control system to set the desired operating point on site.
 - Integrated serial bus interface (RS 485) for connection to a PC/laptop in connection with the interface (accessories).

ECO

Description
 DV EC Eco

- **Power control**
 - Continuously variable speed control with speed potentiometer PU/PA 10 (accessories, see type table).
 - When combined with the universal control system EUR EC or electronic pressure/temperature controllers EDR/ETR (accessories, see type table), the fan can be used for the continuously variable control of differential pressure, differential temperature or flow velocity. Performance levels are shown in the performance curve as an example.

Type	Ref. no.	Maximum speed approx.	Flow rate Free blowing	Noise sound press.	Power consumption at maximum speed		Wiring diagram	Max. air flow-temp.	Wgt net aprx.	Universal control system		Speed potentiometer				
					kW	A				Type	Ref. no.	Type	Ref. no.	Type	Ref. no.	
		min ⁻¹	V m ³ /h	dB(A) in 4 m			No.	+ °C	kg							
PRO Type DV EC Pro, Single-phase alternating current, 230 V, 50/60 Hz, EC motor, IP54																
DV EC 250 Pro	08386	1640	3700	60	0.41	1.78	863.1	60	23.0	–	–	–	–	–	–	–
ECO Type DV EC Eco, Single-phase alternating current, 230 V, 50/60 Hz, EC motor, IP54																
DV EC 250 Eco	08322	1640	3700	60	0.41	1.78	991	60	23.0	EUR EC ¹⁾²⁾	01347	PU 10 ³⁾	01734	PA 10 ³⁾	01735	

1) Multiple EC fans can normally be connected.

2) Alternative elec. pressure/temp. controller (EDR/ETR, no. 01437/01438) in combination with mains adapter NG 24, no. 01439, see accessories.

Performance curves DV EC 250

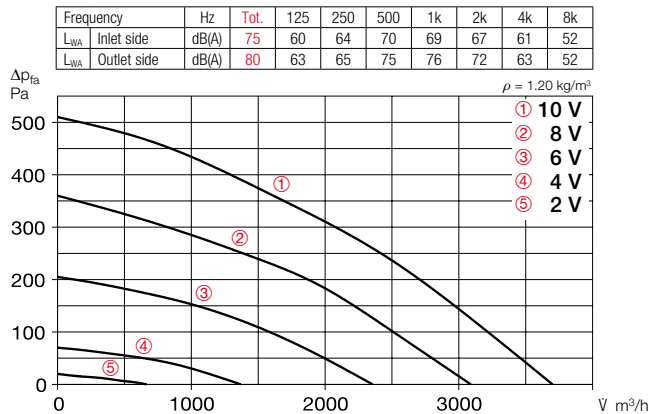

Free blowing						
Voltage V	n min ⁻¹	V m ³ /h	P W	I A	Lp dB(A)	SFP kW/m ³ /s
10	1640	3700	412	1.78	60	—
8	1380	3100	264	1.14	55	—
6	1100	2350	138	0.60	49	—
4	650	1370	40	0.20	36	—

Accessory details Page

Roof install. accessories	550 f.
Ventilation grilles	552 ff.
Exhaust air elements	566 ff.
Intake air elements	578 ff.
Fire protection systems	582 ff.
Universal control systems, electronic controllers, speed potentiometer	605 ff.

Accessories for all types

Base silencer
SSD 250 Ref. no. 05292
With hinge mechanism for easy inspection and cleaning.

Flange connection plate
FAP 250 Ref. no. 08383
Made of galvanised steel sheet. Allows the connection of the duct system and accessories to the roof fans DV EC if no base silencer SSD is used.

Flat roof base
FDS 250 Ref. no. 01379
With hinge mechanism for easy inspection and cleaning.

Counter flange
FR 250 Ref. no. 01203
Made of galvanised steel sheet, for inlet-side duct connection.

Flanged flexible connector
STS 250 Ref. no. 01220
For the prevention of structure-borne noise transmission to inlet-side ducts. Flanges made of galvanised steel sheet.

Duct shutter
RVS 250 Ref. no. 02592
Automatic, made of galvanised steel sheet, shutters made of aluminium. Prevents cold draughts when the fan is at a standstill. For vertical throughflow from bottom to top.

Accessories for DV EC Pro

Interface
ZLS-IF Ref. no. 08391
Interface for commissioning or controlling the fan in combination with a PC/Laptop via a USB port. The software can be downloaded and installed free of charge.

Electronic timer module
ZLS-ZU 31 Ref. no. 08388
Allows the parallel operation of max. 31 DV EC roof fans. The rocker switch is used to enable the DV EC fans. The day and night switchover takes place via the settings in the display. Incl. main switch. 230 V, 50 Hz.

Accessories for DV EC Eco

Universal control system
EUR EC Ref. no. 01347
For the continuously variable control or regulation of single and three-phase EC fans with a setpoint of 0–10 V DC.

Speed potentiometer
PU/PA 10 See type table
For the direct control/setpoint setting of EC fans with a potentiometer input.



	Timer for controlling max. 31 fans	
Type		Ref. no.
ZLS-ZU 31		08388
—		—

3) W/o LED supply.

DV EC 400



Dimensions DV EC 400

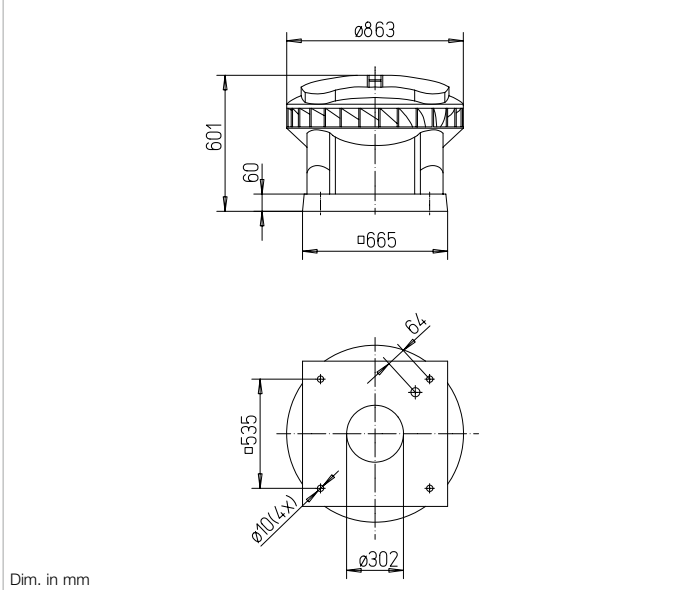

Dim. in mm

Extremely weather-resistant EC roof fan in plastic design for an extensive range of applications, diagonal outlet.

**Common features
 DV EC Pro and DV EC Eco**

- **Casing**
 Aerodynamically designed plastic casing made of grey polypropylene with diagonal air outlet direction. Air flow temperatures from -30 to +60 °C.
- **Impeller**
 Diagonal impeller made of aluminium, the motor impeller unit is dynamically balanced for low-noise operation.
- **Drive**
 Energy-efficient EC external rotor motor in protection category IP54. Optimised efficiency even with speed control for low operating costs. Continuously variable speed control. Maintenance-free and radio interference-free, ball bearing mounted.
- **Motor protection**
 Integrated electronic temperature monitoring system for EC motor and electronics.

- **Electrical connection**
 Standard operating switch (protection category IP65) mounted on the outside of the casing. Connection voltage 1~, 230 V, 50 Hz.
- **Installation**
 Horizontal alignment on the roof. In case of sloping roofs, a corresponding base formation must be used to prevent water ingress. A range of accessories facilitates the installation of the fan in the building duct system.
- **Noise**
 The total level and range are specified above the performance diagram for:
 Inlet side sound power
 Outlet side sound power.
 The case-radiated noise as sound pressure at 4 m (free field conditions) is also specified in the type table and the table below the performance curve.

PRO

**Description
 DV EC Pro**

- **Power control**
 - Ideal as a central exhaust air fan for multi-floor residential construction in accordance with DIN 18017-3.
 - When combined with other components (accessories), a complete central ventilation system in accordance with DIN 18017-3 can be created with demand-driven ventilation.
 - Integrated pressure control for constant volume flow control in the connected rooms through automatic speed adjustment at almost constantly high efficiency.
 - Integrated pressure sensor 0–300 Pa.
 - Short amortisation period due to high energy saving.
 - Operating data setting at the 4 potentiometers integrated in the control system to set the desired operating point on site.
 - Integrated serial bus interface (RS 485) for connection to a PC/laptop in connection with the interface (accessories).

ECO

**Description
 DV EC Eco**

- **Power control**
 - Continuously variable speed control with speed potentiometer PU/PA 10 (accessories, see type table).
 - When combined with the universal control system EUR EC or electronic pressure/temperature controllers EDR/ETR (accessories, see type table), the fan can be used for the continuously variable control of differential pressure, differential temperature or flow velocity. Performance levels are shown in the performance curve as an example.

Type	Ref. no.	Maximum speed approx.	Flow rate Free blowing	Noise sound press.	Power consumption at maximum speed		Wiring diagram	Max. air flow-temp.	Wgt net appr.	Universal control system		Speed potentiometer			
					kW	A				Type	Ref. no.	Type	Ref. no.		
		min ⁻¹	m ³ /h	dB(A) in 4 m	kW	A	No.	+ °C	kg	Type	Ref. no.	Type	Ref. no.		
PRO Type DV EC Pro, Single-phase alternating current, 230 V, 50/60 Hz, EC motor, IP54															
DV EC 400 A Pro	08387	1020	4070	51	0.30	1.33	863.1	60	33.0	–	–	–	–	–	
DV EC 400 B Pro	08389	1425	5650	65	0.75	3.32	863.1	60	35.0	–	–	–	–	–	
ECO Type DV EC Eco, Single-phase alternating current, 230 V, 50/60 Hz, EC motor, IP54															
DV EC 400 A Eco	08324	1020	4070	51	0.30	1.33	991	60	33.0	EUR EC ¹⁾²⁾	01347	PU 10 ³⁾	01734	PA 10 ³⁾	01735
DV EC 400 B Eco	08326	1425	5650	65	0.75	3.32	991	60	35.0	EUR EC ¹⁾²⁾	01347	PU 10 ³⁾	01734	PA 10 ³⁾	01735

1) Multiple EC fans can normally be connected.

2) Alternative elec. pressure/temp. controller (EDR/ETR, no. 01437/01438) in combination with mains adapter NG 24, no. 01439, see accessories.

Performance curves DV EC 400 A

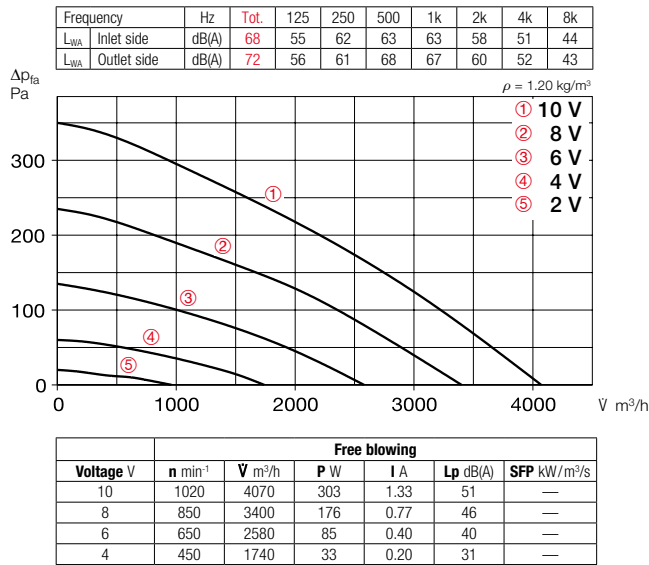

Performance curves DV EC 400 B

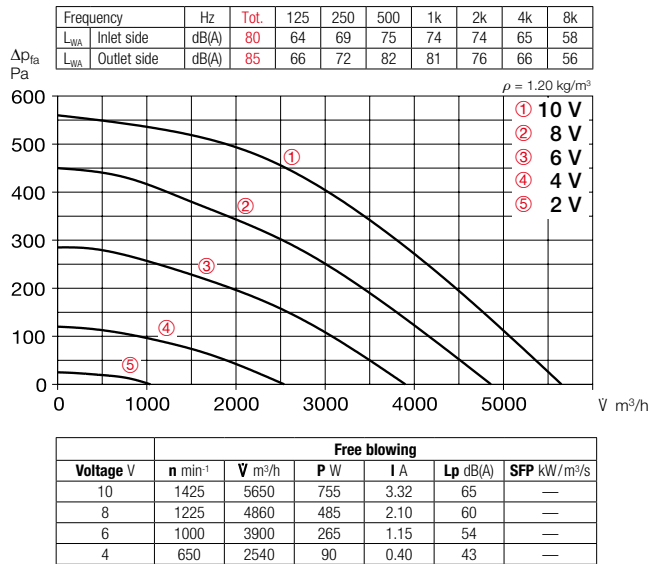

Accessory details	Page
Roof install. accessories	550 f.
Ventilation grilles	552 ff.
Exhaust air elements	566 ff.
Intake air elements	578 ff.
Fire protection systems	582 ff.
Universal control systems, electronic controllers, speed potentiometer	605 ff.

Accessories for all types

Base silencer
SSD 400 Ref. no. 05291
With hinge mechanism for easy inspection and cleaning.

Flange connection plate
FAP 400 Ref. no. 08384
Made of galvanised steel sheet. Allows the connection of the duct system and accessories to the roof fans DV EC if no base silencer SSD is used.

Flat roof base
FDS 400 Ref. no. 01380
With hinge mechanism for easy inspection and cleaning.

Counter flange
FR 400 Ref. no. 01206
Made of galvanised steel sheet, for inlet-side duct connection.

Flanged flexible connector
STS 400 Ref. no. 01223
For the prevention of structure-borne noise transmission to inlet-side ducts. Flanges made of galvanised steel sheet.

Duct shutter
RVS 400 Ref. no. 02596
Automatic, made of galvanised steel sheet, shutters made of aluminium. Prevents cold draughts when the fan is at a standstill. For vertical throughflow from bottom to top.

Accessories for DV EC Pro

Interface
ZLS-IF Ref. no. 08391
Interface for commissioning or controlling the fan in combination with a PC/Laptop via a USB port. The software can be downloaded and installed free of charge.

Electronic timer module
ZLS-ZU 31 Ref. no. 08388
Allows the parallel operation of max. 31 DV EC roof fans. The rocker switch is used to enable the DV EC fans. The day and night switchover takes place via the settings in the display. Incl. main switch. 230 V, 50 Hz.

Accessories for DV EC Eco

Universal control system
EUR EC Ref. no. 01347
For the continuously variable control or regulation of single and three-phase EC fans with a setpoint of 0–10 V DC.

Speed potentiometer
PU/PA 10 See type table
For the direct control/setpoint setting of EC fans with a potentiometer input.



EC roof fans

Timer for controlling max. 31 fans	
Type	Ref. no.
ZLS-ZU 31	08388
ZLS-ZU 31	08388
—	—
—	—

³⁾ W/o LED supply.

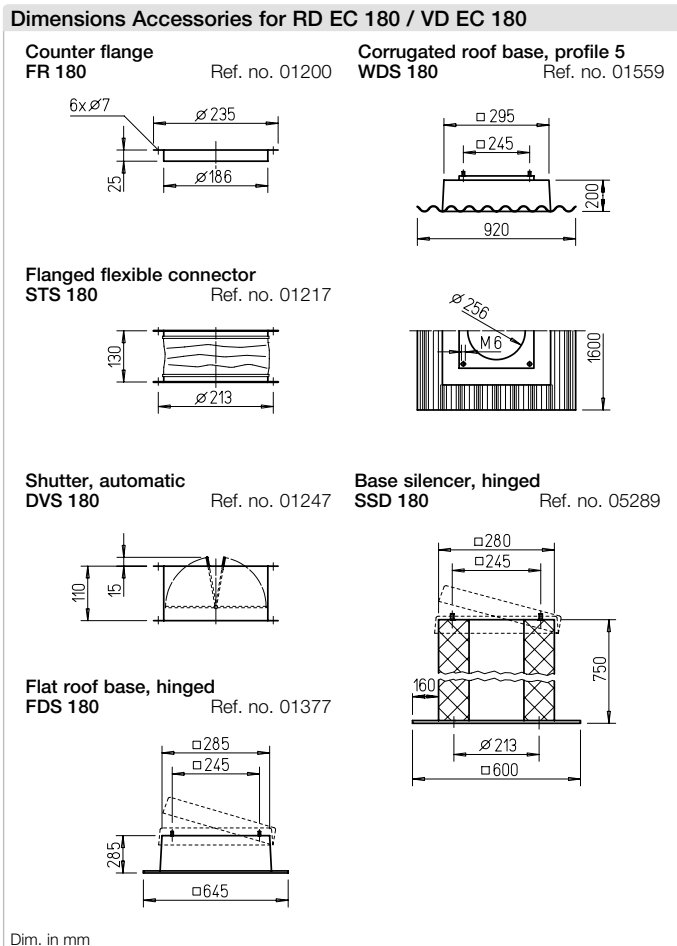
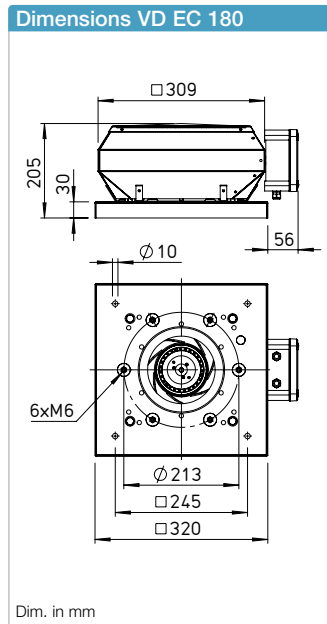
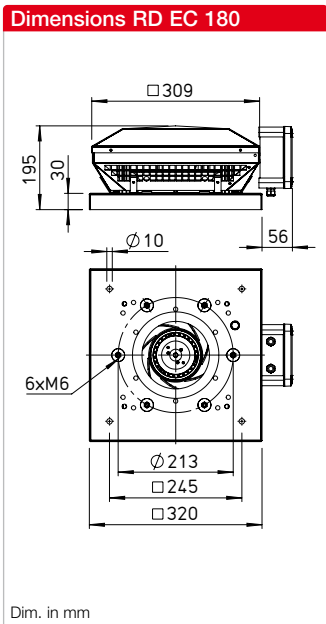

Description RD EC

Horizontal outlet EC roof fan with efficiency-optimised aluminium casing and newly developed high-performance centrifugal impeller.

Description VD EC

Vertical outlet EC roof fan with efficiency-optimised aluminium casing and newly developed high-performance centrifugal impeller.

Common features RD EC and VD EC

Casing
 Made of sea water-resistant aluminium with integrated tamper protection. Motor support plate and base plate with inlet nozzle made of galvanised steel. Base plate with threaded screws for attachment of inlet-side accessories (hole pattern according to DIN 24155).

Impeller
 High-performance centrifugal impeller with backward curved blades made of plastic. Dynamically balanced according to DIN ISO 21940-11 – quality grade 6.3.

Drive
 Energy-saving, speed-controllable EC external rotor motor with the highest level of efficiency. Maintenance-free and radio interference-free, ball bearing mounted.

Motor protection
 Integrated electronic temperature monitoring system for EC motor and electronics.

Electrical connection
 ND 180 – 250 to external terminal box in protection category IP65.

Protection grille
 On outlet side as standard according to DIN EN ISO 13857.

Power control
 Continuously variable speed control via internal (delivery) or external potentiometer or continuously variable speed control with universal control system.

Delivery

Units are ready-for-connection, fully pre-assembled in the shipping box /wooden crate.

Noise

The total level and range are specified above the performance diagram for:

- Inlet side sound power
 - Outlet side sound power.
- The case-radiated noise as sound pressure at 4 m (free field conditions) is also specified in the type table and the table below the performance curve.

References	Page
Planning information	10 ff.
Technical description	491 f.
Selection table	493 f.
Accessories, details	550 f.
Universal control systems, electronic controllers, speed potentiometer	605 ff.

Performance curves RDW EC 180

Frequency	Hz	Tot.	125	250	500	1k	2k	4k	8k
L _{WA} Inlet side		dB(A) 72	54	60	64	66	67	64	58
L _{WA} Outlet side		dB(A) 75	56	64	66	69	70	67	62

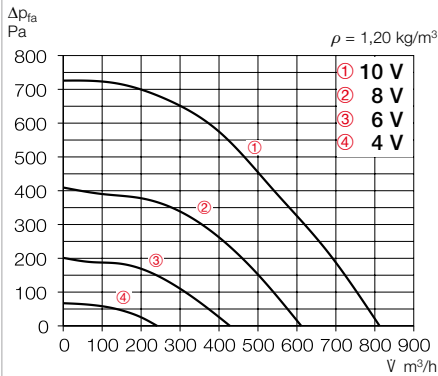

Free blowing						
Voltage V	n min ⁻¹	V m ³ /h	P W	I A	Lp dB(A)	SFP kW/m ³ /s
10	3962	812	138	1.19	60	0.61
8	2967	611	63	0.55	53	0.37
6	2077	428	25	0.22	43	0.21
4	1199	241	7	0.08	30	0.11

Type	Ref. no.	Speed	Flow rate Free blowing	Noise sound pressure	Power consumption	Current consump.		Wiring diagram	Max. air flow temp.		Wgt net	Speed potentiometer			
						at rated voltage	with control		at rated voltage	with control		Flush-mounted		Surf.-mounted	
		min ⁻¹	m ³ /h	dB(A) in 4 m	W	A	A	No.	°C	°C	kg	Type	Ref. no.	Type	Ref. no.
Single phase alternating current, 1~, 230 V, 50 Hz, EC motor, protection category IP44															
RDW EC 180	07125	3820	810	58	150	1.24	1.24	1149	50	–	4.9	PU 10	01734	PA 10	01735

Performance curves VDW EC 180

Frequency	Hz	Tot.	125	250	500	1k	2k	4k	8k
L _{WA} Inlet side		dB(A) 70	52	58	62	64	65	62	56
L _{WA} Outlet side		dB(A) 73	54	62	64	67	68	65	60

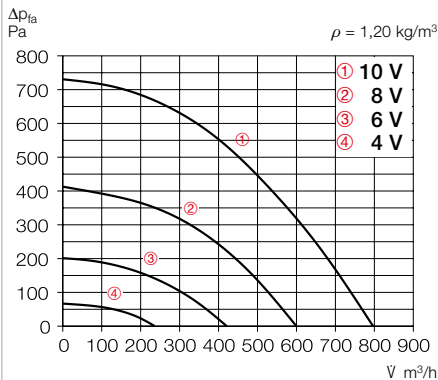

Free blowing						
Voltage V	n min ⁻¹	V m ³ /h	P W	I A	Lp dB(A)	SFP kW/m ³ /s
10	3952	797	139	1.17	58	0.62
8	2967	600	62	0.55	51	0.37
6	2077	421	24	0.22	41	0.21
4	1195	236	7	0.08	28	0.11

Type	Ref. no.	Speed	Flow rate Free blowing	Noise sound pressure	Power consumption	Current consump.		Wiring diagram	Max. air flow temp.		Wgt net	Speed potentiometer			
						at rated voltage	with control		at rated voltage	with control		Flush-mounted		Surf.-mounted	
		min ⁻¹	m ³ /h	dB(A) in 4 m	W	A	A	No.	°C	°C	kg	Type	Ref. no.	Type	Ref. no.
Single phase alternating current, 1~, 230 V, 50 Hz, EC motor, protection category IP44															
VDW EC 180	07123	3870	795	56	150	1.24	1.24	1149	50	–	5.2	PU 10	01734	PA 10	01735

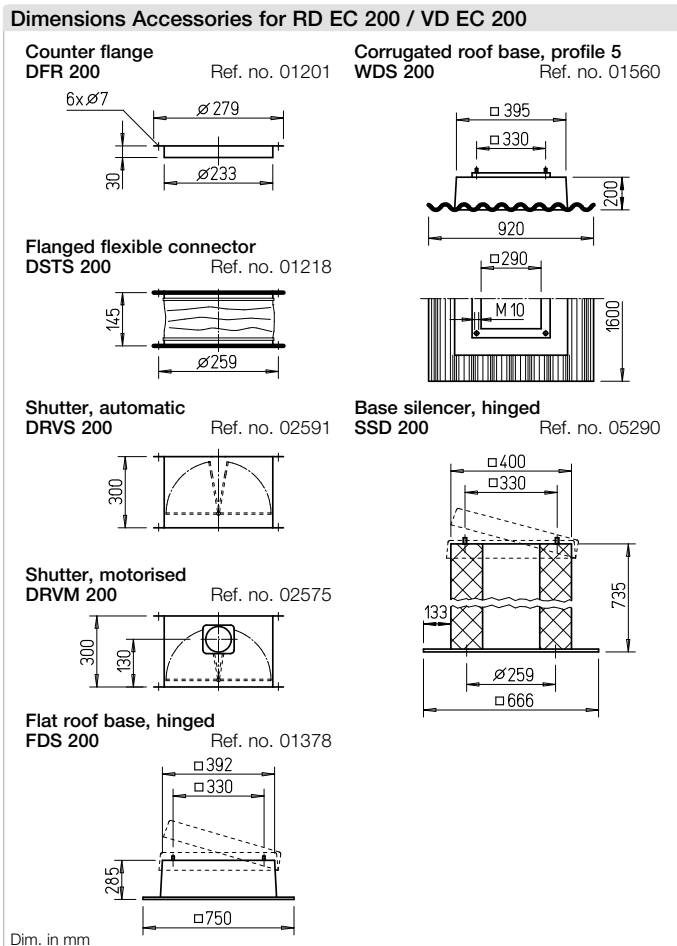
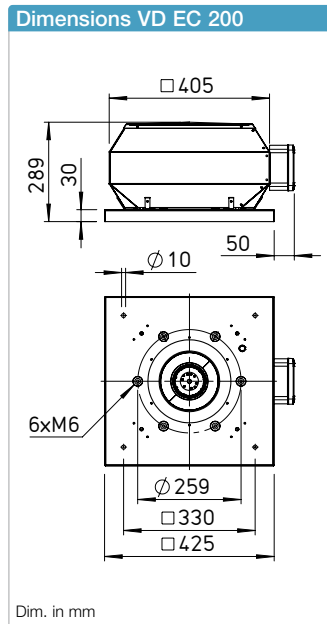
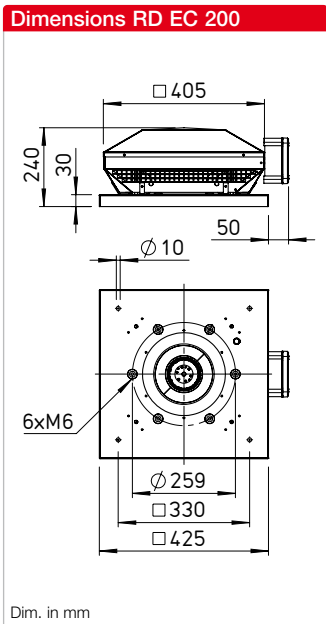

Description RD EC

Horizontal outlet EC roof fan with efficiency-optimised aluminium casing and newly developed high-performance centrifugal impeller.

Description VD EC

Vertical outlet EC roof fan with efficiency-optimised aluminium casing and newly developed high-performance centrifugal impeller.

Common features RD EC and VD EC

- **Casing**
 Made of sea water-resistant aluminium with integrated tamper protection. Motor support plate and base plate with inlet nozzle made of galvanised steel. Base plate with threaded screws for attachment of inlet-side accessories (hole pattern according to DIN 24155).

- **Impeller**
 High-performance centrifugal impeller with backward curved blades made of plastic. Dynamically balanced according to DIN ISO 21940-11 – quality grade 6.3.

- **Drive**
 Energy-saving, speed-controllable EC external rotor motor with the highest level of efficiency. Maintenance-free and radio interference-free, ball bearing mounted.

- **Motor protection**
 Integrated electronic temperature monitoring system for EC motor and electronics.

- **Electrical connection**
 ND 180 – 250 to external terminal box in protection category IP65.

- **Protection grille**
 On outlet side as standard according to DIN EN ISO 13857.

- **Power control**
 Continuously variable speed control via internal (delivery) or external potentiometer or continuously variable speed control with universal control system.

■ **Delivery**

Units are ready-for-connection, fully pre-assembled in the shipping box /wooden crate.

■ **Noise**

The total level and range are specified above the performance diagram for:

- Inlet side sound power
 - Outlet side sound power.
- The case-radiated noise as sound pressure at 4 m (free field conditions) is also specified in the type table and the table below the performance curve.

References	Page
Planning information	10 ff.
Technical description	491 f.
Selection table	493 f.
Accessories, details	550 f.
Universal control systems, electronic controllers, speed potentiometer	605 ff.

Performance curves RDW EC 200

Frequency	Hz	Tot.	125	250	500	1k	2k	4k	8k
L _{wa} Inlet side		dB(A) 71	43	64	65	65	63	61	57
L _{wa} Outlet side		dB(A) 74	45	67	67	68	66	65	61

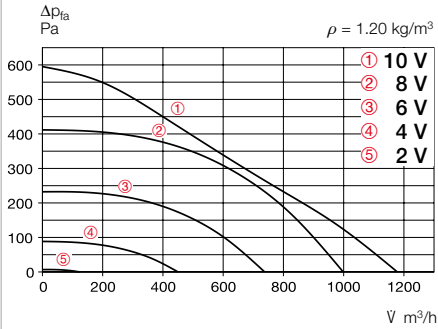

Free blowing						
Voltage V	n min ⁻¹	V m ³ /h	P W	I A	Lp dB(A)	SFP kW/m ³ /s
10	3000	1180	125	0.90	57	0.38
8	2545	1000	75	0.60	54	0.27
6	1925	740	35	0.27	48	0.17
4	1185	450	10	0.10	39	0.08

Type	Ref. no.	Speed	Flow rate Free blowing	Noise sound pressure	Power consumption	Current consump.		Wiring diagram	Max. air flow temp.		Wgt net	Speed potentiometer			
						at rated voltage	with control		at rated voltage	with control		Flush-mounted	Surf.-mounted		
		min ⁻¹	m ³ /h	dB(A) in 4 m	W	A	A	No.	°C	°C	kg	Type	Ref. no.	Type	Ref. no.
Single phase alternating current, 1~, 230 V, 50 Hz, EC motor, protection category IP44															
RDW EC 200	07195	2650	1180	56.5	129	0.93	0.93	1149	50	–	6.8	PU 10	01734	PA 10	01735

Performance curves VDW EC 200

Frequency	Hz	Tot.	125	250	500	1k	2k	4k	8k
L _{wa} Inlet side		dB(A) 69	52	58	64	63	61	61	52
L _{wa} Outlet side		dB(A) 72	56	65	67	64	64	63	55

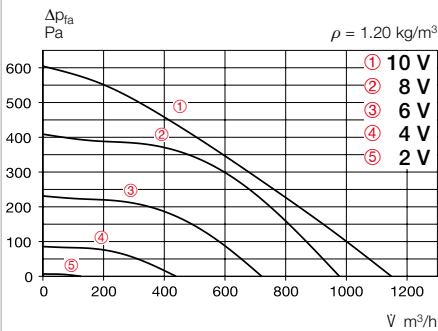

Free blowing						
Voltage V	n min ⁻¹	V m ³ /h	P W	I A	Lp dB(A)	SFP kW/m ³ /s
10	2960	1150	130	0.90	55	0.41
8	2520	975	80	0.60	52	0.30
6	1900	720	35	0.25	46	0.18
4	1170	440	10	0.09	36	0.08

Type	Ref. no.	Speed	Flow rate Free blowing	Noise sound pressure	Power consumption	Current consump.		Wiring diagram	Max. air flow temp.		Wgt net	Speed potentiometer			
						at rated voltage	with control		at rated voltage	with control		Flush-mounted	Surf.-mounted		
		min ⁻¹	m ³ /h	dB(A) in 4 m	W	A	A	No.	°C	°C	kg	Type	Ref. no.	Type	Ref. no.
Single phase alternating current, 1~, 230 V, 50 Hz, EC motor, protection category IP44															
VDW EC 200	07192	2670	1150	55	129	0.94	0.94	1149	50	–	7.4	PU 10	01734	PA 10	01735

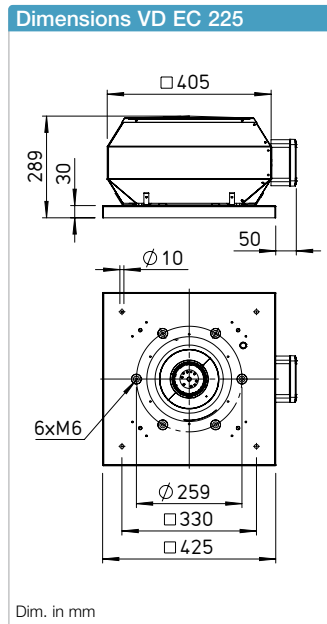
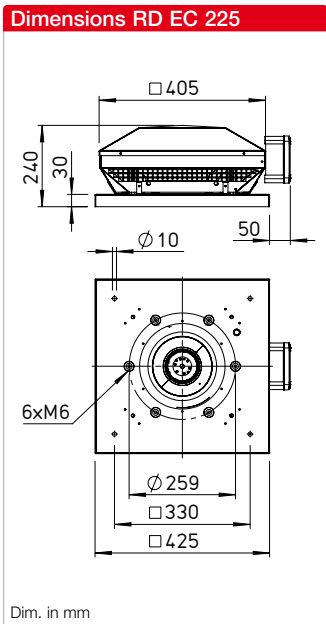

Dimensions Accessories for RD EC 225 / VD EC 225

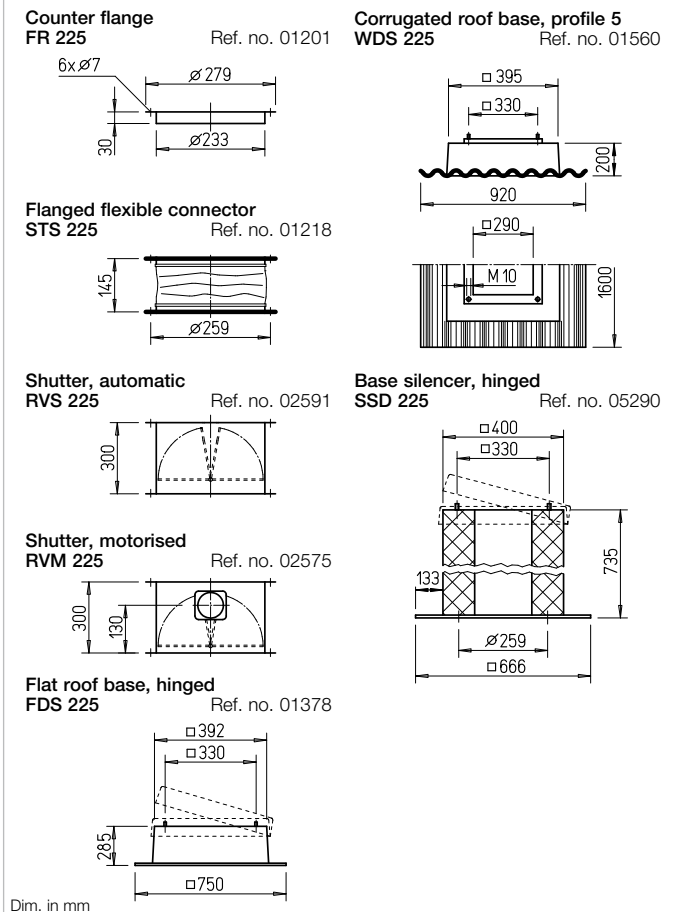

Description RD EC

Horizontal outlet EC roof fan with efficiency-optimised aluminium casing and newly developed high-performance centrifugal impeller.

Description VD EC

Vertical outlet EC roof fan with efficiency-optimised aluminium casing and newly developed high-performance centrifugal impeller.

Common features RD EC and VD EC

- **Casing**
 Made of sea water-resistant aluminium with integrated tamper protection. Motor support plate and base plate with inlet nozzle made of galvanised steel. Base plate with threaded screws for attachment of inlet-side accessories (hole pattern according to DIN 24155).

- **Impeller**
 High-performance centrifugal impeller with backward curved blades made of plastic. Dynamically balanced according to DIN ISO 21940-11 – quality grade 6.3.

- **Drive**
 Energy-saving, speed-controllable EC external rotor motor with the highest level of efficiency. Maintenance-free and radio interference-free, ball bearing mounted.

- **Motor protection**
 Integrated electronic temperature monitoring system for EC motor and electronics.

- **Electrical connection**
 ND 180 – 250 to external terminal box in protection category IP65.

- **Protection grille**
 On outlet side as standard according to DIN EN ISO 13857.

- **Power control**
 Continuously variable speed control via internal (delivery) or external potentiometer or continuously variable speed control with universal control system.

■ **Delivery**

Units are ready-for-connection, fully pre-assembled in the shipping box /wooden crate.

■ **Noise**

The total level and range are specified above the performance diagram for:

- Inlet side sound power
 - Outlet side sound power.
- The case-radiated noise as sound pressure at 4 m (free field conditions) is also specified in the type table and the table below the performance curve.

References	Page
Planning information	10 ff.
Technical description	491 f.
Selection table	493 f.
Accessories, details	550 f.
Universal control systems, electronic controllers, speed potentiometer	605 ff.

Performance curves RDW EC 225 A

Frequency	Hz	Tot.	125	250	500	1k	2k	4k	8k	
L _{WA} Inlet side		dB(A)	67	50	56	61	62	59	59	49
L _{WA} Outlet side		dB(A)	69	49	60	66	62	58	58	48

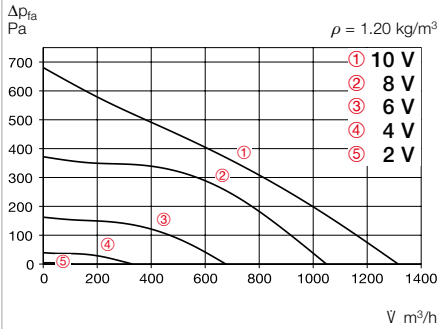

Free blowing						
Voltage V	n min ⁻¹	V m ³ /h	P W	I A	Lp dB(A)	SFP kW/m ³ /s
10	2700	1300	145	1.05	52	0.40
8	2160	1050	75	0.55	48	0.26
6	1430	680	25	0.20	39	0.13
4	720	330	5	0.05	28	0.05

Performance curves RDW EC 225 B

Frequency	Hz	Tot.	125	250	500	1k	2k	4k	8k	
L _{WA} Inlet side		dB(A)	75	49	66	69	68	67	67	64
L _{WA} Outlet side		dB(A)	77	55	69	70	70	70	69	66

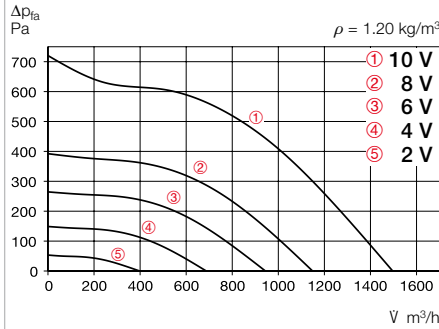

Free blowing						
Voltage V	n min ⁻¹	V m ³ /h	P W	I A	Lp dB(A)	SFP kW/m ³ /s
10	3020	1500	205	0.90	52	0.49
8	2350	1150	105	0.45	55	0.33
6	1940	945	65	0.30	51	0.25
4	1450	690	35	0.20	45	0.18

Type	Ref. no.	Speed	Flow rate Free blowing	Noise sound pressure	Power consumption	Current consump.		Wiring diagram	Max. air flow temp.		Wgt net	Speed potentiometer			
						at rated voltage	with control		at rated voltage	with control		Flush-mounted	Surf.-mounted		
		min ⁻¹	m ³ /h	dB(A) in 4 m	W	A	A	No.	°C	°C	kg	Type	Ref. no.	Type	Ref. no.
Single phase alternating current, 1~, 230 V, 50 Hz, EC motor, protection category IP44															
RDW EC 225 A	07262	2550	1310	52	163	1.14	1.14	1149	50	—	6.7	PU 10	01734	PA 10	01735
Single phase alternating current, 1~, 230 V, 50 Hz, EC motor, protection category IP54															
RDW EC 225 B	07243	3020	1500	60	246	1.06	1.06	1149	50	—	8	PU 10	01734	PA 10	01735

Performance curves VDW EC 225 A

Frequency	Hz	Tot.	125	250	500	1k	2k	4k	8k	
L _{WA} Inlet side		dB(A)	68	43	59	61	62	61	60	56
L _{WA} Outlet side		dB(A)	70	46	61	62	64	64	62	57

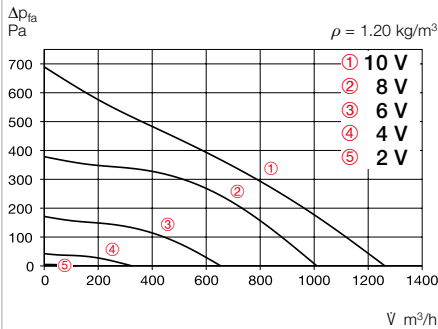

Free blowing						
Voltage V	n min ⁻¹	V m ³ /h	P W	I A	Lp dB(A)	SFP kW/m ³ /s
10	2690	1260	150	1.05	53	0.43
8	2160	1000	75	0.60	49	0.27
6	1430	650	25	0.20	40	0.14
4	720	330	5	0.05	27	0.05

Performance curves VDW EC 225 B

Frequency	Hz	Tot.	125	250	500	1k	2k	4k	8k	
L _{WA} Inlet side		dB(A)	74	47	65	68	67	67	66	62
L _{WA} Outlet side		dB(A)	75	50	66	68	69	68	67	63

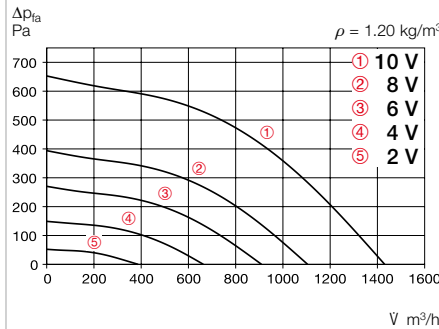

Free blowing						
Voltage V	n min ⁻¹	V m ³ /h	P W	I A	Lp dB(A)	SFP kW/m ³ /s
10	3020	1430	205	0.9	58	0.52
8	2350	1100	105	0.5	53	0.34
6	1950	910	65	0.3	49	0.26
4	1450	670	35	0.2	43	0.19

Type	Ref. no.	Speed	Flow rate Free blowing	Noise sound pressure	Power consumption	Current consump.		Wiring diagram	Max. air flow temp.		Wgt net	Speed potentiometer			
						at rated voltage	with control		at rated voltage	with control		Flush-mounted	Surf.-mounted		
		min ⁻¹	m ³ /h	dB(A) in 4 m	W	A	A	No.	°C	°C	kg	Type	Ref. no.	Type	Ref. no.
Single phase alternating current, 1~, 230 V, 50 Hz, EC motor, protection category IP44															
VDW EC 225 A	07241	2500	1260	53	161	1.14	1.14	1149	50	—	7.3	PU 10	01734	PA 10	01735
Single phase alternating current, 1~, 230 V, 50 Hz, EC motor, protection category IP54															
VDW EC 225 B	07240	3015	1430	58	244	1.06	1.06	1149	50	—	8.5	PU 10	01734	PA 10	01735

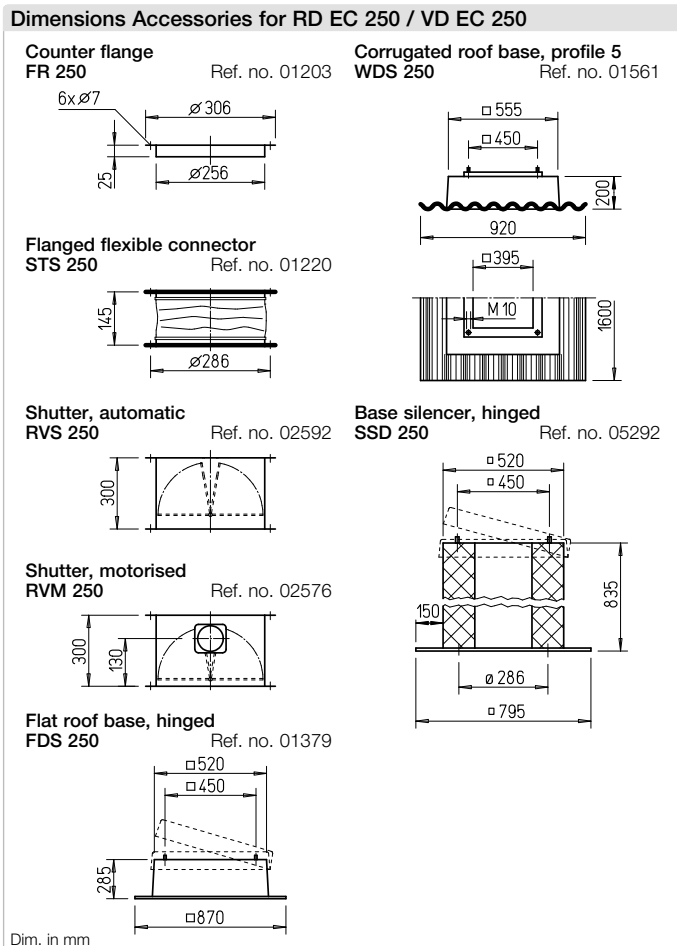
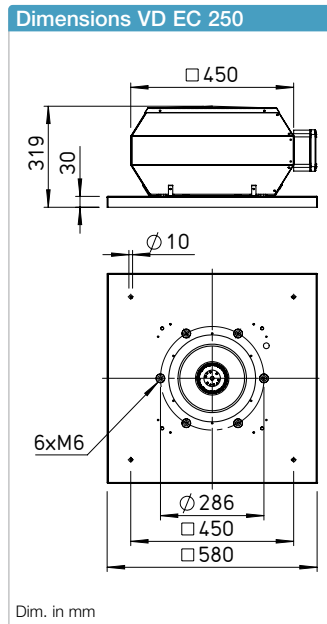
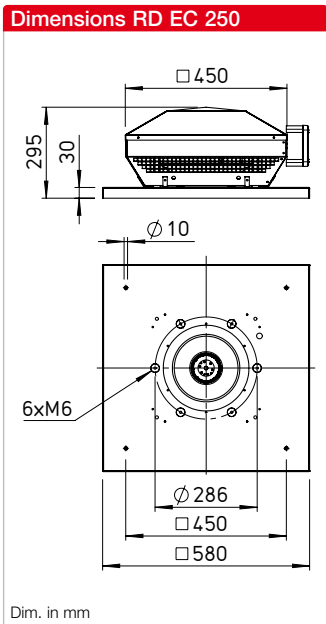

Description RD EC

Horizontal outlet EC roof fan with efficiency-optimised aluminium casing and newly developed high-performance centrifugal impeller.

Description VD EC

Vertical outlet EC roof fan with efficiency-optimised aluminium casing and newly developed high-performance centrifugal impeller.

Common features RD EC and VD EC

■ Casing
 Made of sea water-resistant aluminium with integrated tamper protection. Motor support plate and base plate with inlet nozzle made of galvanised steel. Base plate with threaded screws for attachment of inlet-side accessories (hole pattern according to DIN 24155).

■ Impeller
 High-performance centrifugal impeller with backward curved blades made of plastic. Dynamically balanced according to DIN ISO 21940-11 – quality grade 6.3.

■ Drive
 Energy-saving, speed-controllable EC external rotor motor with the highest level of efficiency. Maintenance-free and radio interference-free, ball bearing mounted.

■ Motor protection
 Integrated electronic temperature monitoring system for EC motor and electronics.

■ Electrical connection
 ND 180 – 250 to external terminal box in protection category IP65.

■ Protection grille
 On outlet side as standard according to DIN EN ISO 13857.

■ Power control
 Continuously variable speed control via internal (delivery) or external potentiometer or continuously variable speed control with universal control system.

■ Delivery
 Units are ready-for-connection, fully pre-assembled in the shipping box /wooden crate.

■ Noise
 The total level and range are specified above the performance diagram for:

- Inlet side sound power
- Outlet side sound power.

The case-radiated noise as sound pressure at 4 m (free field conditions) is also specified in the type table and the table below the performance curve.

References	Page
Planning information	10 ff.
Technical description	491 f.
Selection table	493 f.
Accessories, details	550 f.
Universal control systems, electronic controllers, speed potentiometer	605 ff.

Performance curves RDW EC 250

Frequency	Hz	Tot.	125	250	500	1k	2k	4k	8k
L _{WA} Inlet side	dB(A)	76	50	67	70	69	68	68	65
L _{WA} Outlet side	dB(A)	78	56	70	71	71	71	70	67

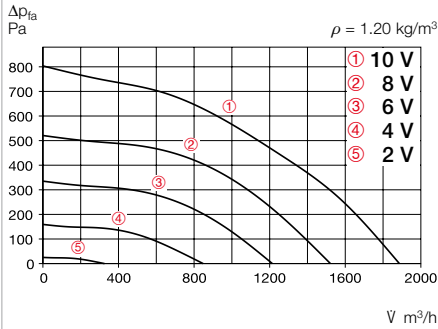

Free blowing						
Voltage V	n min ⁻¹	V m ³ /h	P W	I A	Lp dB(A)	SFP kW/m ³ /s
10	2870	1895	230	1.00	61	0.44
8	2300	1520	125	0.55	57	0.30
6	1840	1215	70	0.32	52	0.21
4	1290	860	30	0.15	45	0.13

Type	Ref. no.	Speed	Flow rate Free blowing	Noise sound pressure	Power con- sumption	Current consump.		Wiring diagram	Max. air flow temp.		Wgt net	Speed potentiometer			
						at rated voltage	with control		at rated voltage	with control		Flush-mounted		Surf.-mounted	
		min ⁻¹	m ³ /h	dB(A) in 4 m	W	A	A	No.	°C	°C	kg	Type	Ref. no.	Type	Ref. no.
Single phase alternating current, 1~, 230 V, 50 Hz, EC motor, protection category IP54															
RDW EC 250	07278	2705	1900	60.5	319	1.34	1.34	1149	50	–	11	PU 10	01734	PA 10	01735

Performance curves VDW EC 250

Frequency	Hz	Tot.	125	250	500	1k	2k	4k	8k
L _{WA} Inlet side	dB(A)	75	48	66	69	68	68	67	63
L _{WA} Outlet side	dB(A)	76	51	67	69	70	69	68	64

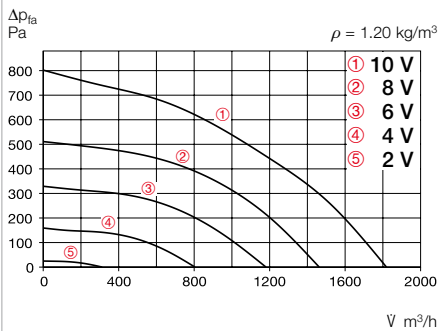

Free blowing						
Voltage V	n min ⁻¹	V m ³ /h	P W	I A	Lp dB(A)	SFP kW/m ³ /s
10	2860	1830	240	1.05	59	0.47
8	2300	1460	130	0.60	55	0.32
6	1840	1180	75	0.35	50	0.23
4	1280	810	30	0.20	43	0.13

Type	Ref. no.	Speed	Flow rate Free blowing	Noise sound pressure	Power con- sumption	Current consump.		Wiring diagram	Max. air flow temp.		Wgt net	Speed potentiometer			
						at rated voltage	with control		at rated voltage	with control		Flush-mounted		Surf.-mounted	
		min ⁻¹	m ³ /h	dB(A) in 4 m	W	A	A	No.	°C	°C	kg	Type	Ref. no.	Type	Ref. no.
Single phase alternating current, 1~, 230 V, 50 Hz, EC motor, protection category IP54															
VDW EC 250	07276	2740	1825	59	321	1.36	1.36	1149	50	–	11.5	PU 10	01734	PA 10	01735

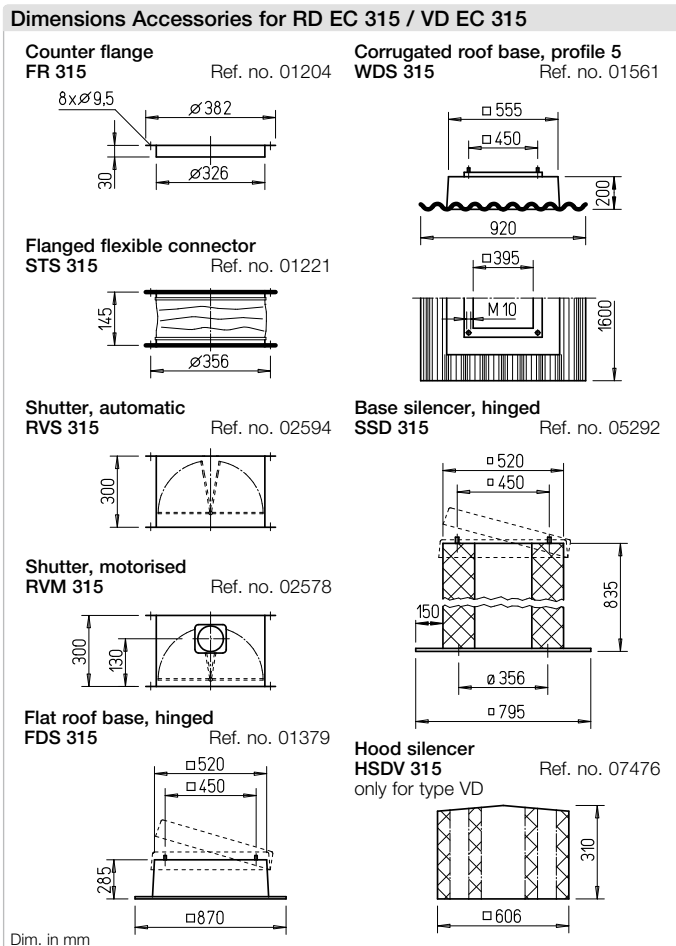
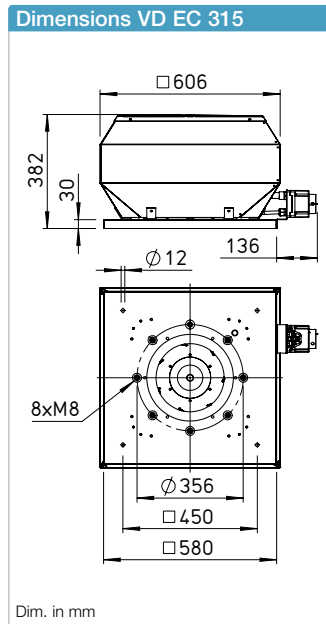
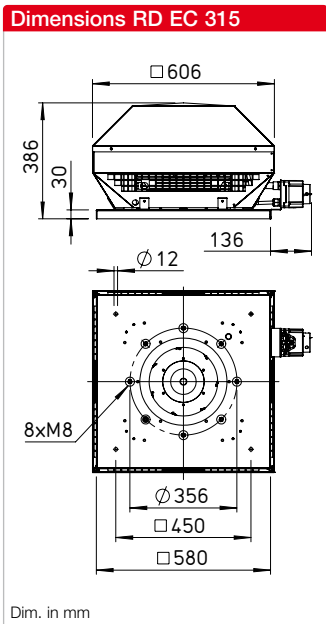

Description RD EC

Horizontal outlet EC roof fan with efficiency-optimised aluminium casing and newly developed high-performance centrifugal impeller.

Description VD EC

Vertical outlet EC roof fan with efficiency-optimised aluminium casing and newly developed high-performance centrifugal impeller.

Common features RD EC and VD EC

- **Casing**
Made of sea water-resistant aluminium with integrated tamper protection. Motor support plate and base plate with inlet nozzle made of galvanised steel. Base plate with threaded screws for attachment of inlet-side accessories (hole pattern according to DIN 24155).

- **Impeller**
High-performance centrifugal impeller with backward curved blades made of plastic. Dynamically balanced according to DIN ISO 21940-11 – quality grade 6.3.

- **Drive**
Energy-saving, speed-controllable EC external rotor motor with the highest level of efficiency. Maintenance-free and radio interference-free, ball bearing mounted.

- **Motor protection**
Integrated electronic temperature monitoring system for EC motor and electronics.

- **Electrical connection**
ND 315 – 630 to external terminal box and isolator in protection category IP65.

- **Protection grille**
On outlet side as standard according to DIN EN ISO 13857.

- **Power control**
Continuously variable speed control via internal (delivery) or external potentiometer or continuously variable speed control with universal control system.

■ **Delivery**

Units are ready-for-connection, fully pre-assembled in the shipping box /wooden crate.

■ **Noise**

The total level and range are specified above the performance diagram for:

- Inlet side sound power
 - Outlet side sound power.
- The case-radiated noise as sound pressure at 4 m (free field conditions) is also specified in the type table and the table below the performance curve.

References	Page
Planning information	10 ff.
Technical description	491 f.
Selection table	493 f.
Accessories, details	550 f.
Universal control systems, electronic controllers, speed potentiometer	605 ff.

Performance curves RDW EC 315

Frequency	Hz	Tot.	125	250	500	1k	2k	4k	8k	
L _{WA} Inlet side		dB(A)	70	58	62	64	62	63	62	51
L _{WA} Outlet side		dB(A)	72	59	66	67	66	62	54	50

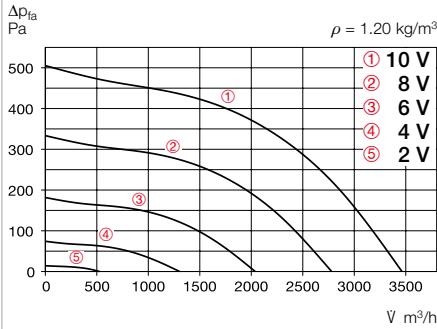

Free blowing						
Voltage V	n min ⁻¹	V m ³ /h	P W	I A	Lp dB(A)	SFP kW/m ³ /s
10	1641	3463	316	1.8	55	0.33
8	1325	2779	169	1.0	50	0.22
6	973	2039	72	0.5	44	0.13
4	621	1309	25	0.2	34	0.07

Performance curves RDD EC 315

Frequency	Hz	Tot.	125	250	500	1k	2k	4k	8k	
L _{WA} Inlet side		dB(A)	70	57	61	63	61	62	61	50
L _{WA} Outlet side		dB(A)	72	59	65	66	65	61	53	50

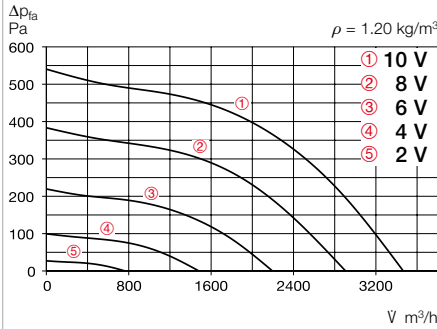

Free blowing						
Voltage V	n min ⁻¹	V m ³ /h	P W	I A	Lp dB(A)	SFP kW/m ³ /s
10	1700	3460	380	0.65	55	0.40
8	1430	2900	240	0.45	51	0.30
6	1040	2100	110	0.25	44	0.19
4	670	1350	45	0.15	35	0.12

Type	Ref. no.	Speed	Flow rate Free blowing	Noise sound pressure	Power consumption	Current consump.		Wiring diagram	Max. air flow temp.		Wgt net	Speed potentiometer			
						at rated voltage	with control		at rated voltage	with control		Flush-mounted	Surf.-mounted		
		min ⁻¹	m ³ /h	dB(A) in 4 m	W	A	A	No.	°C	°C	kg	Type	Ref. no.	Type	Ref. no.
Single phase alternating current, 1~, 230 V, 50 Hz, EC motor, protection category IP54															
RDW EC 315	07306	1650	3465	55	450	2	2	1149	40	—	18	PU 24	01736	PA 24	01737
Three phase current, 3~, 400 V, 50 Hz, EC motor, protection category IP54															
RDD EC 315	07314	1700	3484	54.5	460	1.0	0.9	1148	60	—	21.3	PU 24	01736	PA 24	01737

Performance curves VDW EC 315

Frequency	Hz	Tot.	125	250	500	1k	2k	4k	8k	
L _{WA} Inlet side		dB(A)	72	61	66	66	65	64	59	53
L _{WA} Outlet side		dB(A)	77	67	68	68	72	67	60	53

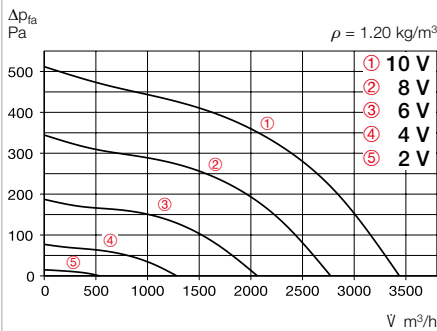

Free blowing						
Voltage V	n min ⁻¹	V m ³ /h	P W	I A	Lp dB(A)	SFP kW/m ³ /s
10	1645	3441	316	1.80	55	0.33
8	1329	2783	176	1.04	50	0.23
6	990	2060	76	0.48	44	0.13
4	612	1276	23	0.19	35	0.07

Performance curves VDD EC 315

Frequency	Hz	Tot.	125	250	500	1k	2k	4k	8k	
L _{WA} Inlet side		dB(A)	75	64	69	69	68	67	62	56
L _{WA} Outlet side		dB(A)	80	70	71	71	75	70	63	56

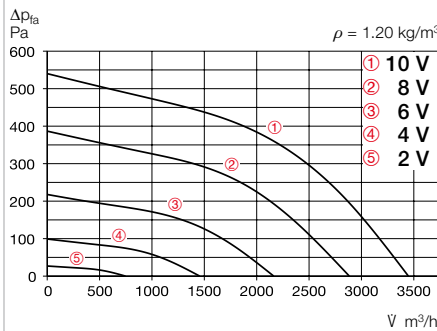

Free blowing						
Voltage V	n min ⁻¹	V m ³ /h	P W	I A	Lp dB(A)	SFP kW/m ³ /s
10	1700	3420	370	0.69	55	0.39
8	1430	2890	240	0.50	51	0.30
6	1040	2090	110	0.25	44	0.19
4	655	1320	45	0.15	35	0.12

Type	Ref. no.	Speed	Flow rate Free blowing	Noise sound pressure	Power consumption	Current consump.		Wiring diagram	Max. air flow temp.		Wgt net	Speed potentiometer			
						at rated voltage	with control		at rated voltage	with control		Flush-mounted	Surf.-mounted		
		min ⁻¹	m ³ /h	dB(A) in 4 m	W	A	A	No.	°C	°C	kg	Type	Ref. no.	Type	Ref. no.
Single phase alternating current, 1~, 230 V, 50 Hz, EC motor, protection category IP54															
VDW EC 315	07304	1650	3440	55	450	2	2	1149	40	—	17.2	PU 24	01736	PA 24	01737
Three phase current, 3~, 400 V, 50 Hz, EC motor, protection category IP54															
VDD EC 315	07312	1700	3453	54.5	460	1.0	0.9	1148	60	—	21.5	PU 24	01736	PA 24	01737

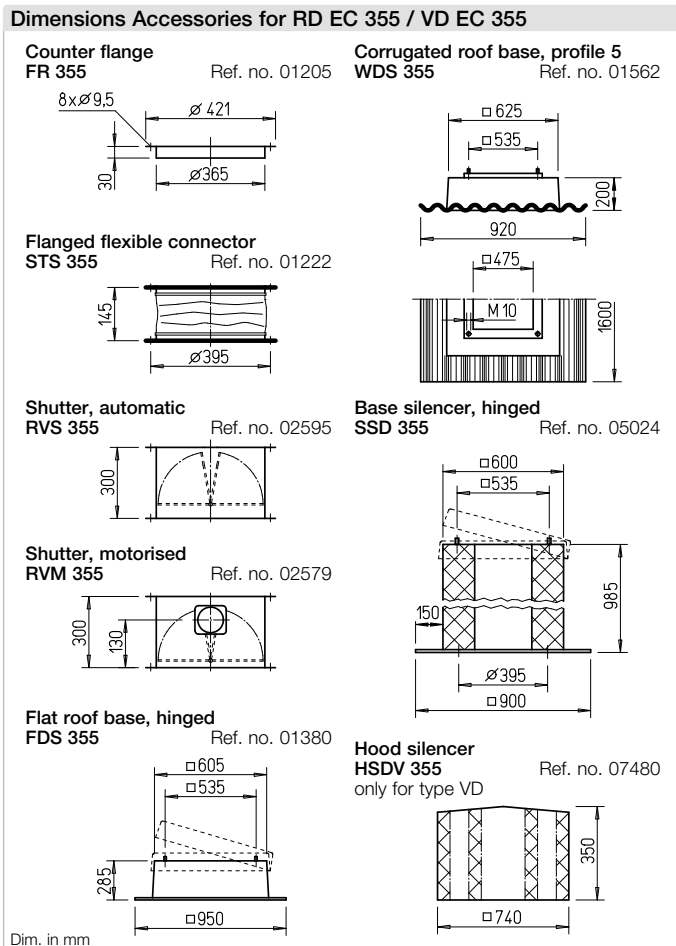
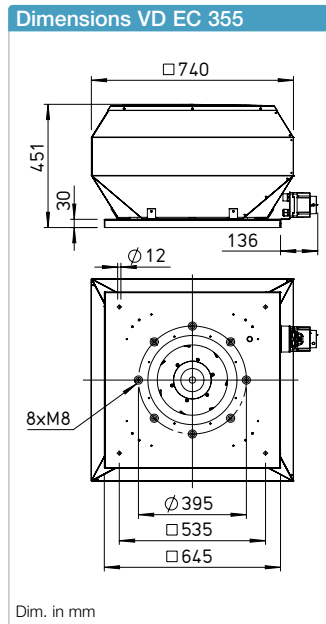
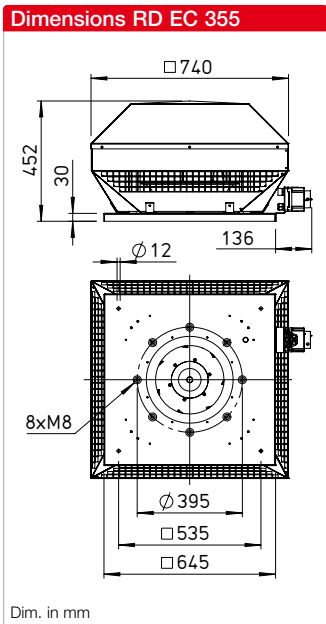

Description RD EC

Horizontal outlet EC roof fan with efficiency-optimised aluminium casing and newly developed high-performance centrifugal impeller.

Description VD EC

Vertical outlet EC roof fan with efficiency-optimised aluminium casing and newly developed high-performance centrifugal impeller.

Common features RD EC and VD EC

- **Casing**
Made of sea water-resistant aluminium with integrated tamper protection. Motor support plate and base plate with inlet nozzle made of galvanised steel. Base plate with threaded screws for attachment of inlet-side accessories (hole pattern according to DIN 24155).

- **Impeller**
High-performance centrifugal impeller with backward curved blades made of plastic. Dynamically balanced according to DIN ISO 21940-11 – quality grade 6.3.

- **Drive**
Energy-saving, speed-controllable EC external rotor motor with the highest level of efficiency. Maintenance-free and radio interference-free, ball bearing mounted.

- **Motor protection**
Integrated electronic temperature monitoring system for EC motor and electronics.

- **Electrical connection**
ND 315 – 630 to external terminal box and isolator in protection category IP65.

- **Protection grille**
On outlet side as standard according to DIN EN ISO 13857.

- **Power control**
Continuously variable speed control via internal (delivery) or external potentiometer or continuously variable speed control with universal control system.

■ **Delivery**

Units are ready-for-connection, fully pre-assembled in the shipping box /wooden crate.

■ **Noise**

The total level and range are specified above the performance diagram for:

- Inlet side sound power
 - Outlet side sound power.
- The case-radiated noise as sound pressure at 4 m (free field conditions) is also specified in the type table and the table below the performance curve.

References	Page
Planning information	10 ff.
Technical description	491 f.
Selection table	493 f.
Accessories, details	550 f.
Universal control systems, electronic controllers, speed potentiometer	605 ff.

Performance curves RDW EC 355

Frequency	Hz	Tot.	125	250	500	1k	2k	4k	8k
L _{WA} Inlet side	dB(A)	70	60	65	64	62	60	57	52
L _{WA} Outlet side	dB(A)	76	67	70	70	70	66	57	51

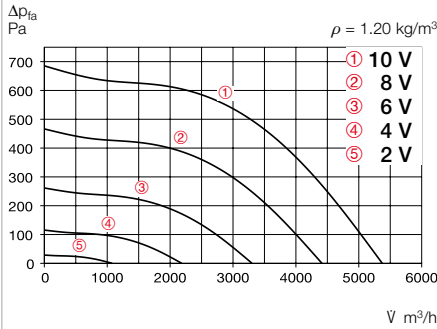

Free blowing						
Voltage V	n min ⁻¹	V m ³ /h	P W	I A	Lp dB(A)	SFP kW/m ³ /s
10	1700	5400	580	2.50	59	0.39
8	1400	4420	330	1.50	55	0.27
6	1050	3320	150	0.75	49	0.16
4	670	2170	60	0.45	40	0.10

Performance curves RDD EC 355

Frequency	Hz	Tot.	125	250	500	1k	2k	4k	8k
L _{WA} Inlet side	dB(A)	72	62	67	66	64	62	59	54
L _{WA} Outlet side	dB(A)	77	68	71	71	71	67	58	52

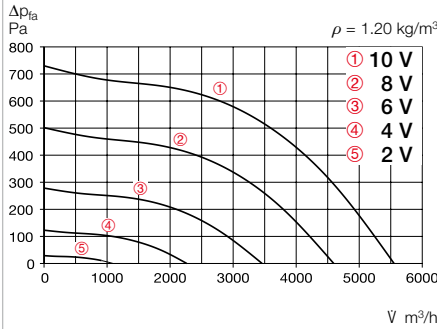

Free blowing						
Voltage V	n min ⁻¹	V m ³ /h	P W	I A	Lp dB(A)	SFP kW/m ³ /s
10	1750	5340	670	1.20	60	0.45
8	1450	4420	410	0.75	56	0.33
6	1060	3200	175	0.35	50	0.20
4	670	2000	60	0.15	41	0.11

Type	Ref. no.	Speed	Flow rate Free blowing	Noise sound pressure	Power consumption	Current consump.		Wiring diagram	Max. air flow temp.		Wgt net	Speed potentiometer			
						at rated voltage	with control		at rated voltage	with control		Flush-mounted	Surf.-mounted		
		min ⁻¹	m ³ /h	dB(A) in 4 m	W	A	A	No.	°C	°C	kg	Type	Ref. no.	Type	Ref. no.
Single phase alternating current, 1~, 230 V, 50 Hz, EC motor, protection category IP55															
RDW EC 355	07333	1700	5400	58.5	810	3.47	3.47	1147	50	—	26.5	PU 24	01736	PA 24	01737
Three phase current, 3~, 400 V, 50 Hz, EC motor, protection category IP55															
RDD EC 355	07335	1750	5558	59.5	870	1.6	1.49	1148	60	—	28.5	PU 24	01736	PA 24	01737

Performance curves VDW EC 355

Frequency	Hz	Tot.	125	250	500	1k	2k	4k	8k
L _{WA} Inlet side	dB(A)	70	60	65	64	62	60	57	52
L _{WA} Outlet side	dB(A)	75	65	69	69	69	66	57	53

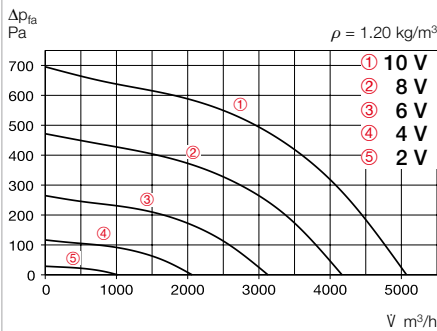

Free blowing						
Voltage V	n min ⁻¹	V m ³ /h	P W	I A	Lp dB(A)	SFP kW/m ³ /s
10	1700	5080	590	2.50	58	0.42
8	1400	4180	335	1.50	54	0.29
6	1050	3130	155	0.80	48	0.18
4	700	2070	60	0.50	40	0.10

Performance curves VDD EC 355

Frequency	Hz	Tot.	125	250	500	1k	2k	4k	8k
L _{WA} Inlet side	dB(A)	71	61	66	65	63	61	58	53
L _{WA} Outlet side	dB(A)	76	67	70	70	70	66	58	52

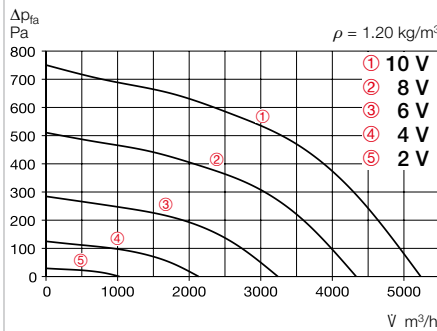

Free blowing						
Voltage V	n min ⁻¹	V m ³ /h	P W	I A	Lp dB(A)	SFP kW/m ³ /s
10	1750	5030	650	1.20	59	0.47
8	1460	4180	390	0.75	55	0.34
6	1070	3040	170	0.35	49	0.20
4	667	1900	60	0.15	39	0.11

Type	Ref. no.	Speed	Flow rate Free blowing	Noise sound pressure	Power consumption	Current consump.		Wiring diagram	Max. air flow temp.		Wgt net	Speed potentiometer			
						at rated voltage	with control		at rated voltage	with control		Flush-mounted	Surf.-mounted		
		min ⁻¹	m ³ /h	dB(A) in 4 m	W	A	A	No.	°C	°C	kg	Type	Ref. no.	Type	Ref. no.
Single phase alternating current, 1~, 230 V, 50 Hz, EC motor, protection category IP55															
VDW EC 355	07331	1700	5080	58	800	3.45	3.45	1147	50	—	27	PU 24	01736	PA 24	01737
Three phase current, 3~, 400 V, 50 Hz, EC motor, protection category IP55															
VDD EC 355	07334	1700	3425	59	835	1.45	1.45	1148	60	—	29	PU 24	01736	PA 24	01737

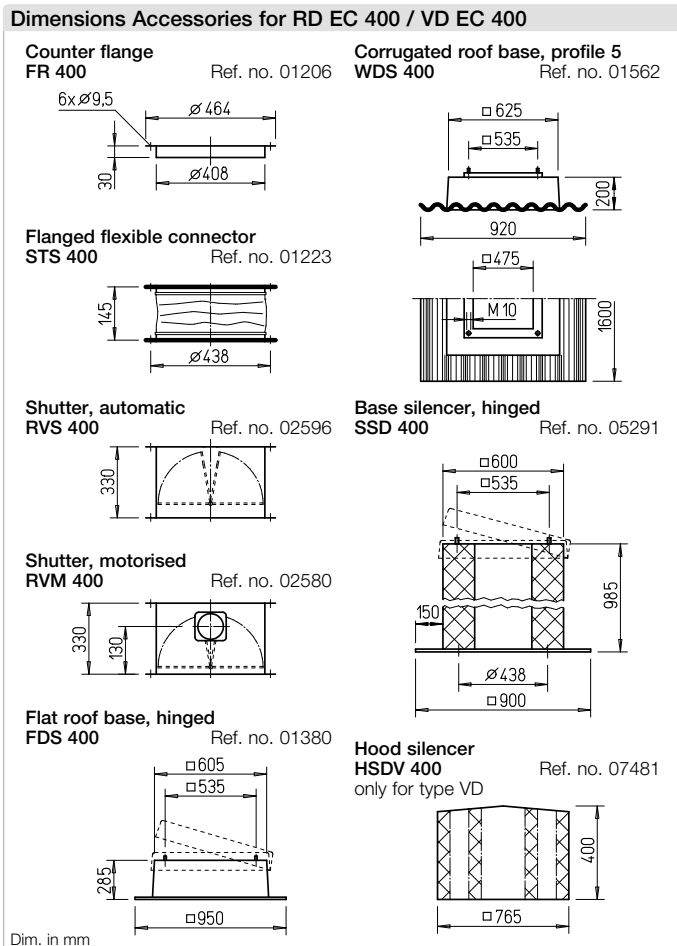
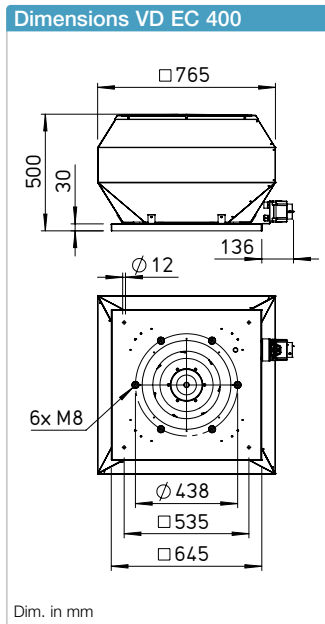
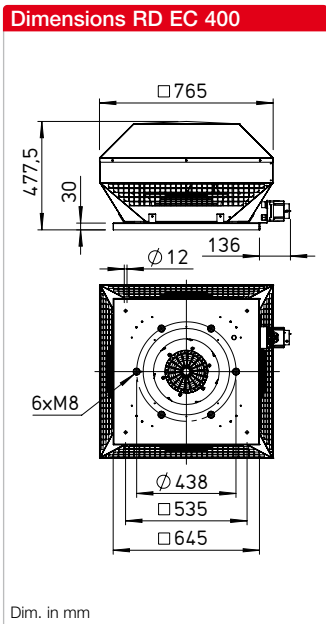

Description RD EC

Horizontal outlet EC roof fan with efficiency-optimised aluminium casing and newly developed high-performance centrifugal impeller.

Description VD EC

Vertical outlet EC roof fan with efficiency-optimised aluminium casing and newly developed high-performance centrifugal impeller.

Common features RD EC and VD EC

- **Casing**
 Made of sea water-resistant aluminium with integrated tamper protection. Motor support plate and base plate with inlet nozzle made of galvanised steel. Base plate with threaded screws for attachment of inlet-side accessories (hole pattern according to DIN 24155).

- **Impeller**
 High-performance centrifugal impeller with backward curved blades made of plastic. Dynamically balanced according to DIN ISO 21940-11 – quality grade 6.3.

- **Drive**
 Energy-saving, speed-controllable EC external rotor motor with the highest level of efficiency. Maintenance-free and radio interference-free, ball bearing mounted.

- **Motor protection**
 Integrated electronic temperature monitoring system for EC motor and electronics.

- **Electrical connection**
 ND 315 – 630 to external terminal box and isolator in protection category IP65.

- **Protection grille**
 On outlet side as standard according to DIN EN ISO 13857.

- **Power control**
 Continuously variable speed control via internal (delivery) or external potentiometer or continuously variable speed control with universal control system.

■ **Delivery**

Units are ready-for-connection, fully pre-assembled in the shipping box /wooden crate.

■ **Noise**

The total level and range are specified above the performance diagram for:

- Inlet side sound power
 - Outlet side sound power.
- The case-radiated noise as sound pressure at 4 m (free field conditions) is also specified in the type table and the table below the performance curve.

References	Page
Planning information	10 ff.
Technical description	491 f.
Selection table	493 f.
Accessories, details	550 f.
Universal control systems, electronic controllers, speed potentiometer	605 ff.

Performance curves RDW EC 400

Frequency	Hz	Tot.	125	250	500	1k	2k	4k	8k
L _{WA} Inlet side	dB(A)	72	62	66	67	64	63	57	53
L _{WA} Outlet side	dB(A)	77	68	71	71	71	67	60	53

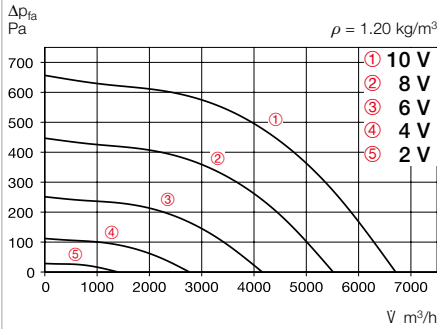

Free blowing						
Voltage V	n min ⁻¹	V m ³ /h	P W	I A	Lp dB(A)	SFP kW/m ³ /s
10	1500	6695	691	2.90	60	0.37
8	1237	5522	388	1.68	56	0.25
6	927	4168	173	0.83	50	0.15
4	617	2761	62	0.45	41	0.08

Performance curves RDD EC 400

Frequency	Hz	Tot.	125	250	500	1k	2k	4k	8k
L _{WA} Inlet side	dB(A)	72	62	66	67	64	63	57	53
L _{WA} Outlet side	dB(A)	77	68	71	71	71	67	60	53

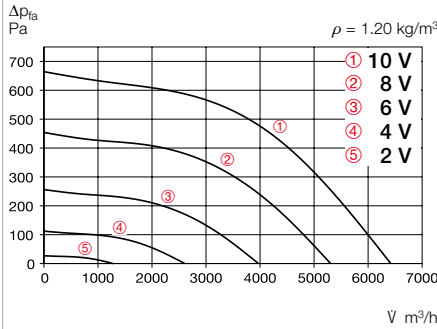

Free blowing						
Voltage V	n min ⁻¹	V m ³ /h	P W	I A	Lp dB(A)	SFP kW/m ³ /s
10	1500	6450	715	1.20	60	0.40
8	1250	5350	445	0.80	56	0.30
6	910	3910	210	0.45	50	0.19
4	580	2500	80	0.20	40	0.12

Type	Ref. no.	Speed	Flow rate Free blowing	Noise sound pressure	Power consumption	Current consump.		Wiring diagram	Max. air flow temp.		Wgt net	Speed potentiometer			
						at rated voltage	with control		at rated voltage	with control		Flush-mounted	Surf.-mounted		
		min ⁻¹	m ³ /h	dB(A) in 4 m	W	A	A	No.	°C	°C	kg	Type	Ref. no.	Type	Ref. no.
Single phase alternating current, 1~, 230 V, 50 Hz, EC motor, protection category IP54															
RDW EC 400	07365	1500	6695	59.5	1050	4.4	4.4	1147	40	—	28	PU 24	01736	PA 24	01737
Three phase current, 3~, 400 V, 50 Hz, EC motor, protection category IP54															
RDD EC 400	07369	1500	6421	59.5	950	1.6	1.7	1148	60	—	33	PU 24	01736	PA 24	01737

Performance curves VDW EC 400

Frequency	Hz	Tot.	125	250	500	1k	2k	4k	8k
L _{WA} Inlet side	dB(A)	73	63	67	68	65	64	58	54
L _{WA} Outlet side	dB(A)	77	64	72	71	71	67	61	55

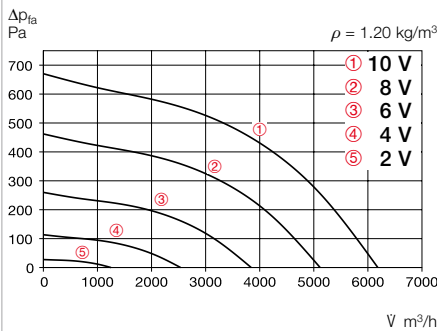

Free blowing						
Voltage V	n min ⁻¹	V m ³ /h	P W	I A	Lp dB(A)	SFP kW/m ³ /s
10	1499	6198	726	3.0	60	0.42
8	1246	5132	416	2.0	56	0.29
6	935	3859	187	1.0	50	0.17
4	619	2544	67	0.47	41	0.09

Performance curves VDD EC 400

Frequency	Hz	Tot.	125	250	500	1k	2k	4k	8k
L _{WA} Inlet side	dB(A)	71	60	65	65	64	63	58	52
L _{WA} Outlet side	dB(A)	76	66	67	67	71	66	59	52

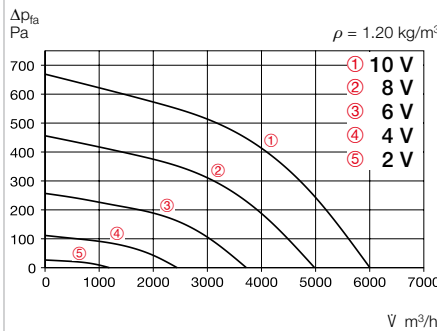

Free blowing						
Voltage V	n min ⁻¹	V m ³ /h	P W	I A	Lp dB(A)	SFP kW/m ³ /s
10	1500	6060	755	1.25	59	0.45
8	1250	5050	465	0.85	55	0.33
6	910	3680	220	0.45	49	0.22
4	580	2350	80	0.20	39	0.12

Type	Ref. no.	Speed	Flow rate Free blowing	Noise sound pressure	Power consumption	Current consump.		Wiring diagram	Max. air flow temp.		Wgt net	Speed potentiometer			
						at rated voltage	with control		at rated voltage	with control		Flush-mounted	Surf.-mounted		
		min ⁻¹	m ³ /h	dB(A) in 4 m	W	A	A	No.	°C	°C	kg	Type	Ref. no.	Type	Ref. no.
Single phase alternating current, 1~, 230 V, 50 Hz, EC motor, protection category IP54															
VDW EC 400	07364	1500	6200	59.5	1000	4.2	4.2	1147	40	—	33	PU 24	01736	PA 24	01737
Three phase current, 3~, 400 V, 50 Hz, EC motor, protection category IP54															
VDD EC 400	07368	1500	6022	58.5	950	1.7	1.7	1148	60	—	33	PU 24	01736	PA 24	01737

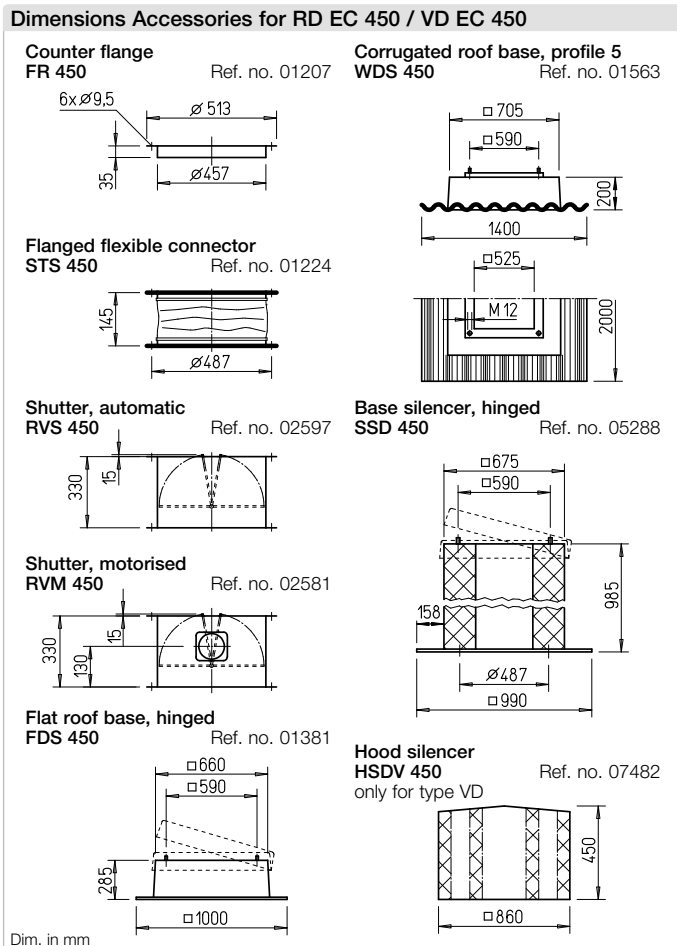
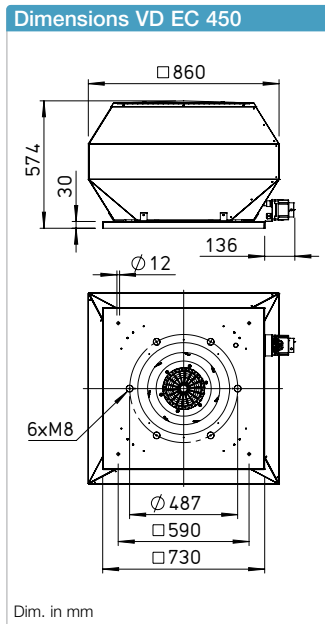
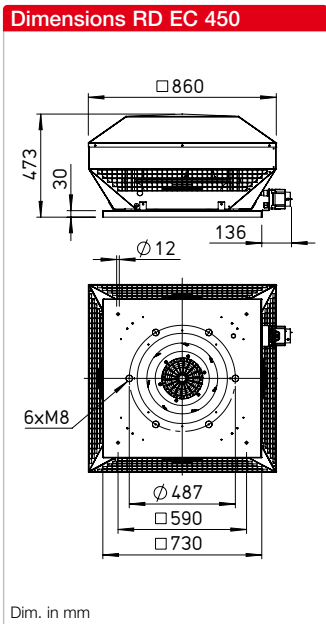

Description RD EC

Horizontal outlet EC roof fan with efficiency-optimised aluminium casing and newly developed high-performance centrifugal impeller.

Description VD EC

Vertical outlet EC roof fan with efficiency-optimised aluminium casing and newly developed high-performance centrifugal impeller.

Common features RD EC and VD EC

- **Casing**
 Made of sea water-resistant aluminium with integrated tamper protection. Motor support plate and base plate with inlet nozzle made of galvanised steel. Base plate with threaded screws for attachment of inlet-side accessories (hole pattern according to DIN 24155).

- **Impeller**
 High-performance centrifugal impeller with backward curved blades made of plastic. Dynamically balanced according to DIN ISO 21940-11 – quality grade 6.3.

- **Drive**
 Energy-saving, speed-controllable EC external rotor motor with the highest level of efficiency. Maintenance-free and radio interference-free, ball bearing mounted.

- **Motor protection**
 Integrated electronic temperature monitoring system for EC motor and electronics.

- **Electrical connection**
 ND 315 – 630 to external terminal box and isolator in protection category IP65.

- **Protection grille**
 On outlet side as standard according to DIN EN ISO 13857.

- **Power control**
 Continuously variable speed control via internal (delivery) or external potentiometer or continuously variable speed control with universal control system.

■ **Delivery**

Units are ready-for-connection, fully pre-assembled in the shipping box /wooden crate.

■ **Noise**

The total level and range are specified above the performance diagram for:

- Inlet side sound power
 - Outlet side sound power.
- The case-radiated noise as sound pressure at 4 m (free field conditions) is also specified in the type table and the table below the performance curve.

References	Page
Planning information	10 ff.
Technical description	491 f.
Selection table	493 f.
Accessories, details	550 f.
Universal control systems, electronic controllers, speed potentiometer	605 ff.

Performance curves RDW EC 450

Frequency	Hz	Tot.	125	250	500	1k	2k	4k	8k	
L _{WA} Inlet side		dB(A)	72	61	66	66	65	64	59	53
L _{WA} Outlet side		dB(A)	77	67	68	68	72	67	60	53

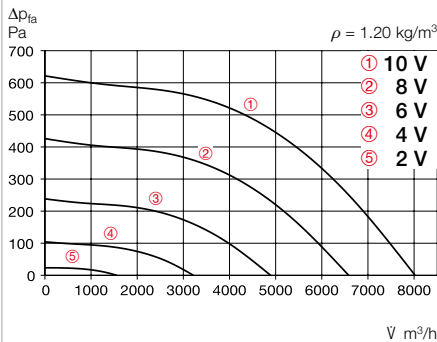

Free blowing						
Voltage V	n min ⁻¹	V m ³ /h	P W	I A	Lp dB(A)	SFP kW/m ³ /s
10	1300	8042	738	3.10	60	0.33
8	1074	6595	421	1.80	56	0.23
6	802	4891	191	0.91	50	0.14
4	535	3221	70	0.51	37	0.08

Performance curves RDD EC 450 A

Frequency	Hz	Tot.	125	250	500	1k	2k	4k	8k	
L _{WA} Inlet side		dB(A)	75	64	69	69	68	67	62	56
L _{WA} Outlet side		dB(A)	80	70	71	71	75	70	63	56

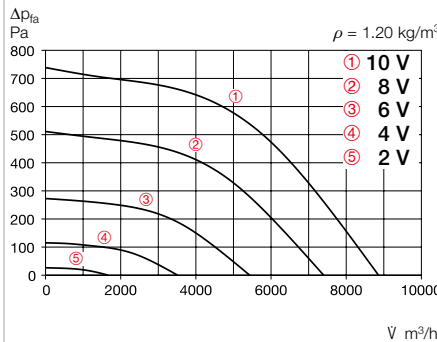

Free blowing						
Voltage V	n min ⁻¹	V m ³ /h	P W	I A	Lp dB(A)	SFP kW/m ³ /s
10	1430	8760	980	1.60	63	0.40
8	1190	7230	590	1.05	59	0.29
6	870	5360	265	0.50	52	0.18
4	550	3380	90	0.20	42	0.10

Performance curves RDD EC 450 B

Frequency	Hz	Tot.	125	250	500	1k	2k	4k	8k	
L _{WA} Inlet side		dB(A)	81	70	75	75	74	73	68	62
L _{WA} Outlet side		dB(A)	86	76	77	77	81	76	69	62

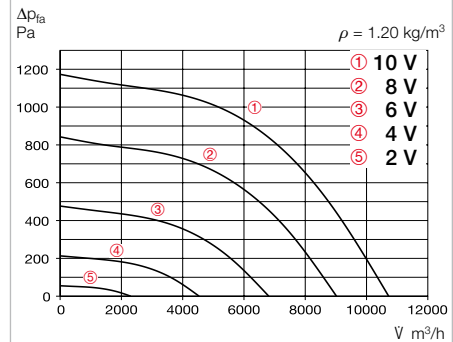

Free blowing						
Voltage V	n min ⁻¹	V m ³ /h	P W	I A	Lp dB(A)	SFP kW/m ³ /s
10	1800	10760	2015	2.95	69	0.67
8	1490	8960	1180	1.80	65	0.48
6	1100	6430	525	0.92	58	0.29
4	700	4115	180	0.35	48	0.16

Type	Ref. no.	Speed	Flow rate Free blowing	Noise sound pressure	Power consumption	Current consump.		Wiring diagram	Max. air flow temp.	Wgt net	Speed potentiometer				
						at rated voltage	with control				Flush-mounted	Surf.-mounted			
		min ⁻¹	m ³ /h	dB(A) in 4 m	W	A	A	No.	°C	°C	kg	Type	Ref. no.	Type	Ref. no.
Single phase alternating current, 1~, 230 V, 50 Hz, EC motor, protection category IP54															
RDW EC 450	07397	1300	8050	59.5	110	4.9	4.9	1147	40	—	39	PU 24	01736	PA 24	01737
Three phase current, 3~, 400 V, 50 Hz, EC motor, protection category IP54															
RDD EC 450 A	07382	1425	8865	62.5	1400	2.2	2.4	1148	45	—	39	PU 24	01736	PA 24	01737
RDD EC 450 B	07395	1800	10736	68.5	2810	4.3	4.2	1148	60	—	45	PU 24	01736	PA 24	01737

Performance curves VDW EC 450

Frequency	Hz	Tot.	125	250	500	1k	2k	4k	8k	
L _{WA} Inlet side		dB(A)	70	59	64	64	63	62	57	51
L _{WA} Outlet side		dB(A)	76	67	68	68	72	67	60	53

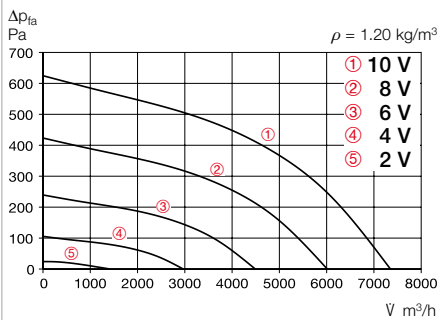

Free blowing						
Voltage V	n min ⁻¹	V m ³ /h	P W	I A	Lp dB(A)	SFP kW/m ³ /s
10	1300	7354	862	4.0	59	0.42
8	1068	6018	487	2.0	55	0.29
6	802	4493	217	1.0	49	0.17
4	533	2966	78	0.5	36	0.10

Performance curves VDD EC 450 A

Frequency	Hz	Tot.	125	250	500	1k	2k	4k	8k	
L _{WA} Inlet side		dB(A)	73	62	67	67	66	65	60	54
L _{WA} Outlet side		dB(A)	79	70	71	71	75	70	63	56

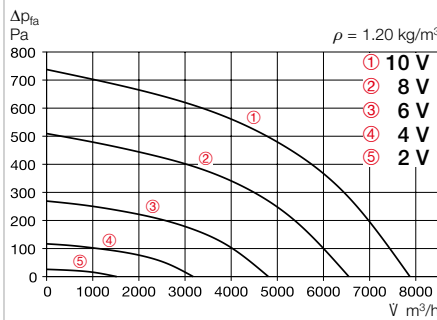

Free blowing						
Voltage V	n min ⁻¹	V m ³ /h	P W	I A	Lp dB(A)	SFP kW/m ³ /s
10	1430	7990	1130	1.80	62	0.51
8	1190	6690	670	1.15	58	0.36
6	870	4850	290	0.55	51	0.22
4	550	3090	95	0.20	42	0.11

Performance curves VDD EC 450 B

Frequency	Hz	Tot.	125	250	500	1k	2k	4k	8k	
L _{WA} Inlet side		dB(A)	79	68	73	73	72	71	66	60
L _{WA} Outlet side		dB(A)	85	76	77	77	81	76	69	62

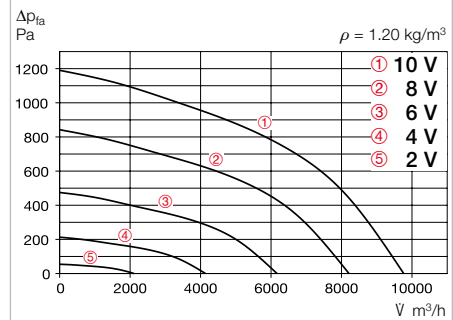

Free blowing						
Voltage V	n min ⁻¹	V m ³ /h	P W	I A	Lp dB(A)	SFP kW/m ³ /s
10	1800	9960	2250	3.3	68	0.81
8	1500	8110	1330	2.0	64	0.59
6	1090	5980	570	0.95	57	0.34
4	690	3780	190	0.38	47	0.18

Type	Ref. no.	Speed	Flow rate Free blowing	Noise sound pressure	Power consumption	Current consump.		Wiring diagram	Max. air flow temp.	Wgt net	Speed potentiometer				
						at rated voltage	with control				Flush-mounted	Surf.-mounted			
		min ⁻¹	m ³ /h	dB(A) in 4 m	W	A	A	No.	°C	°C	kg	Type	Ref. no.	Type	Ref. no.
Single phase alternating current, 1~, 230 V, 50 Hz, EC motor, protection category IP54															
VDW EC 450	07396	1300	7355	59	1120	4.7	4.7	1147	40	—	41	PU 24	01736	PA 24	01737
Three phase current, 3~, 400 V, 50 Hz, EC motor, protection category IP54															
VDD EC 450 A	07381	1410	7883	62	1450	2.2	2.3	1148	45	—	41	PU 24	01736	PA 24	01737
VDD EC 450 B	07392	1800	9771	68	2800	4.3	4.2	1148	60	—	47	PU 24	01736	PA 24	01737

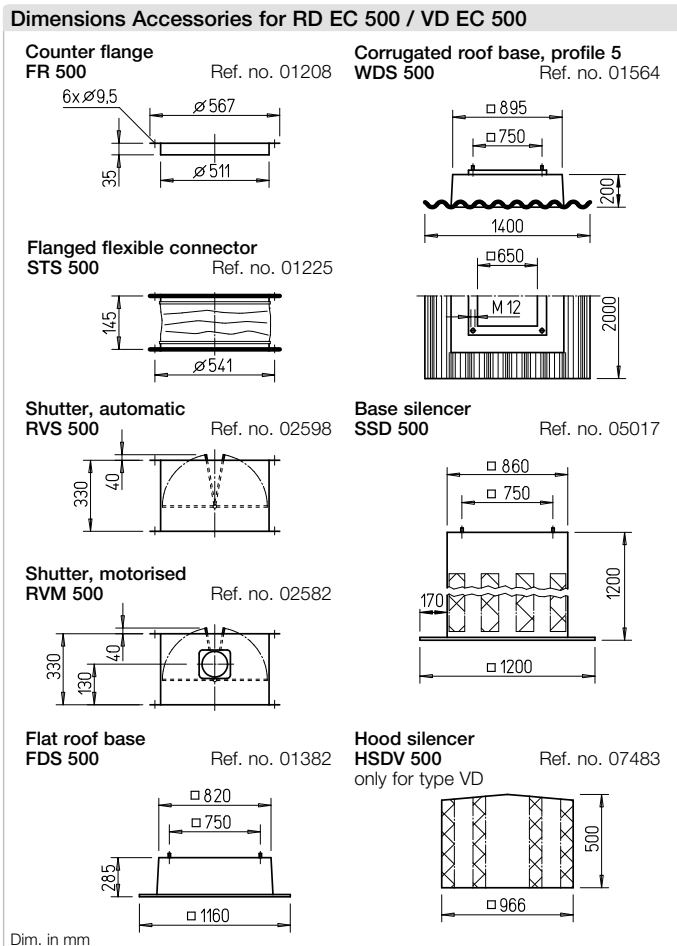
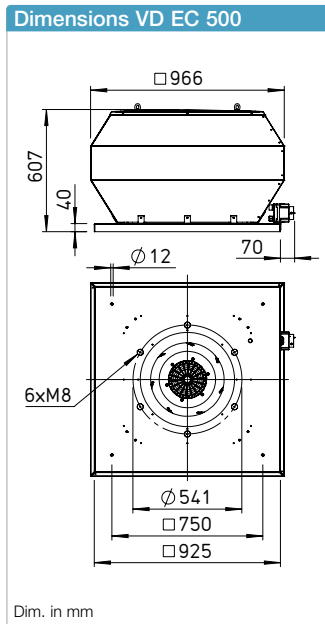
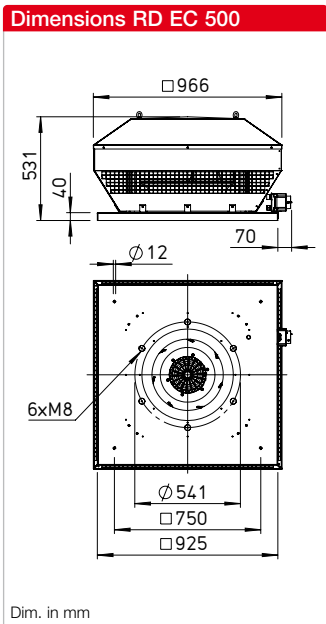

Description RD EC

Horizontal outlet EC roof fan with efficiency-optimised aluminium casing and newly developed high-performance centrifugal impeller.

Description VD EC

Vertical outlet EC roof fan with efficiency-optimised aluminium casing and newly developed high-performance centrifugal impeller.

Common features RD EC and VD EC

- **Casing**
 Made of sea water-resistant aluminium with integrated tamper protection. Motor support plate and base plate with inlet nozzle made of galvanised steel. Base plate with threaded screws for attachment of inlet-side accessories (hole pattern according to DIN 24155).

- **Impeller**
 High-performance centrifugal impeller with backward curved blades made of plastic. Dynamically balanced according to DIN ISO 21940-11 – quality grade 6.3.

- **Drive**
 Energy-saving, speed-controllable EC external rotor motor with the highest level of efficiency. Maintenance-free and radio interference-free, ball bearing mounted.

- **Motor protection**
 Integrated electronic temperature monitoring system for EC motor and electronics.

- **Electrical connection**
 ND 315 – 630 to external terminal box and isolator in protection category IP65.

- **Protection grille**
 On outlet side as standard according to DIN EN ISO 13857.

- **Power control**
 Continuously variable speed control via internal (delivery) or external potentiometer or continuously variable speed control with universal control system.

■ **Delivery**

Units are ready-for-connection, fully pre-assembled in the shipping box /wooden crate.

■ **Noise**

The total level and range are specified above the performance diagram for:

- Inlet side sound power
 - Outlet side sound power.
- The case-radiated noise as sound pressure at 4 m (free field conditions) is also specified in the type table and the table below the performance curve.

References	Page
Planning information	10 ff.
Technical description	491 f.
Selection table	493 f.
Accessories, details	550 f.
Universal control systems, electronic controllers, speed potentiometer	605 ff.

Performance curves RDD EC 500 A

Frequency	Hz	Tot.	125	250	500	1k	2k	4k	8k	
L _{WA} Inlet side		dB(A)	76	64	70	70	69	68	63	59
L _{WA} Outlet side		dB(A)	82	70	76	77	76	72	64	58

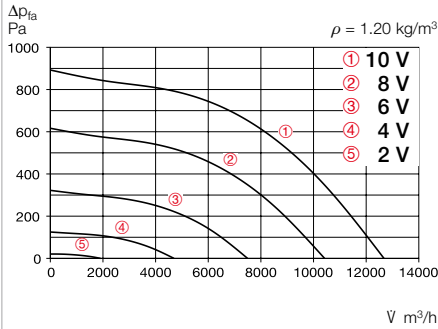

Free blowing						
Voltage V	n min ⁻¹	V m ³ /h	P W	I A	Lp dB(A)	SFP kW/m ³ /s
10	1400	12650	1760	2.70	65	0.50
8	1160	10400	1030	1.65	61	0.36
6	840	7480	450	0.85	54	0.22
4	530	4690	160	0.35	44	0.12

Performance curves RDD EC 500 B

Frequency	Hz	Tot.	125	250	500	1k	2k	4k	8k	
L _{WA} Inlet side		dB(A)	80	68	74	74	73	72	67	63
L _{WA} Outlet side		dB(A)	85	73	79	80	79	75	67	61

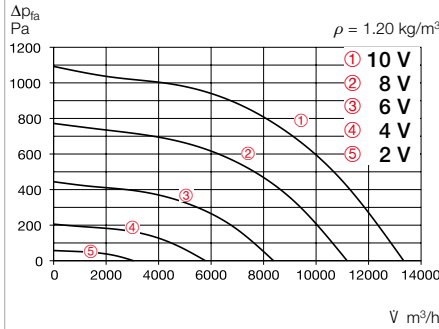

Free blowing						
Voltage V	n min ⁻¹	V m ³ /h	P W	I A	Lp dB(A)	SFP kW/m ³ /s
10	1550	13530	2430	3.55	68	0.65
8	1280	11040	1370	2.05	64	0.45
6	920	7910	560	0.97	57	0.25
4	560	4810	165	0.35	46	0.12

Type	Ref. no.	Speed	Flow rate Free blowing	Noise sound pressure	Power consumption	Current consump.		Wiring diagram	Max. air flow temp.		Wgt net	Speed potentiometer			
						at rated voltage	with control		at rated voltage	with control		Flush-mounted	Surf.-mounted		
		min ⁻¹	m ³ /h	dB(A) in 4 m	W	A	A	No.	°C	°C	kg	Type	Ref. no.	Type	Ref. no.
Three phase current, 3~, 400 V, 50 Hz, EC motor, protection category IP54															
RDD EC 500 A	07425	1400	12411	64.5	2410	3.7	3.7	1148	50	—	63	PU 24	01736	PA 24	01737
RDD EC 500 B	07417	1550	13333	67.5	3200	4.9	4.8	1148	50	—	67	PU 24	01736	PA 24	01737

Performance curves VDD EC 500 A

Frequency	Hz	Tot.	125	250	500	1k	2k	4k	8k	
L _{WA} Inlet side		dB(A)	76	67	71	69	69	66	62	58
L _{WA} Outlet side		dB(A)	82	71	75	76	74	69	61	

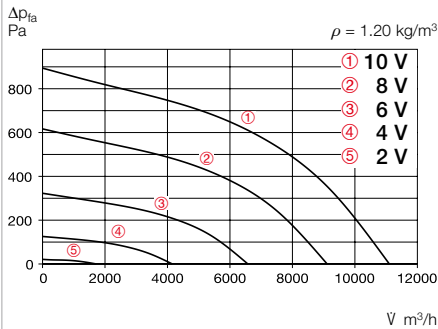

Free blowing						
Voltage V	n min ⁻¹	V m ³ /h	P W	I A	Lp dB(A)	SFP kW/m ³ /s
10	1400	11100	1910	2.90	65	0.62
8	1160	9120	1135	1.80	61	0.45
6	840	6585	480	0.90	54	0.26
4	530	4160	170	0.35	44	0.15

Performance curves VDD EC 500 B

Frequency	Hz	Tot.	125	250	500	1k	2k	4k	8k	
L _{WA} Inlet side		dB(A)	79	70	76	77	76	72	64	58
L _{WA} Outlet side		dB(A)	85	74	78	79	77	72	64	

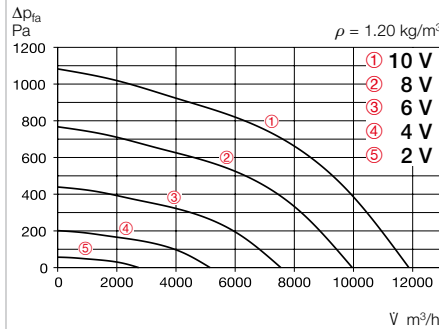

Free blowing						
Voltage V	n min ⁻¹	V m ³ /h	P W	I A	Lp dB(A)	SFP kW/m ³ /s
10	1550	11905	2575	3.80	68	0.78
8	1280	9820	1460	2.20	64	0.54
6	920	6990	595	1.00	57	0.31
4	560	4270	170	0.35	46	0.14

Type	Ref. no.	Speed	Flow rate Free blowing	Noise sound pressure	Power consumption	Current consump.		Wiring diagram	Max. air flow temp.		Wgt net	Speed potentiometer			
						at rated voltage	with control		at rated voltage	with control		Flush-mounted	Surf.-mounted		
		min ⁻¹	m ³ /h	dB(A) in 4 m	W	A	A	No.	°C	°C	kg	Type	Ref. no.	Type	Ref. no.
Three phase current, 3~, 400 V, 50 Hz, EC motor, protection category IP54															
VDD EC 500 A	07424	1400	11042	65	2400	3.7	3.7	1148	50	—	65	PU 24	01736	PA 24	01737
VDD EC 500 B	07415	1550	11870	68	3180	4.9	4.7	1148	50	—	69	PU 24	01736	PA 24	01737

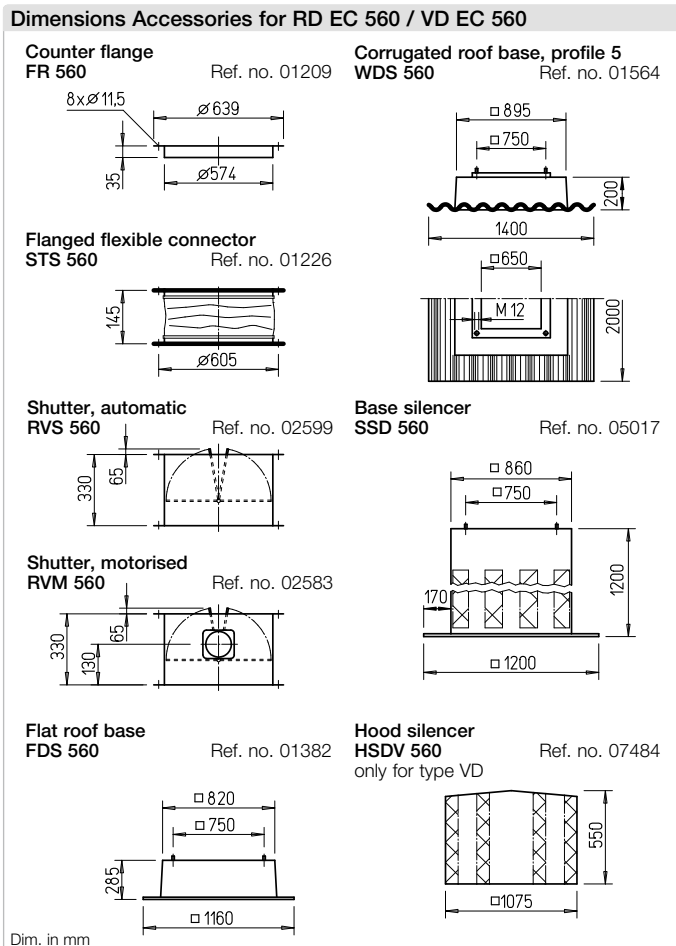
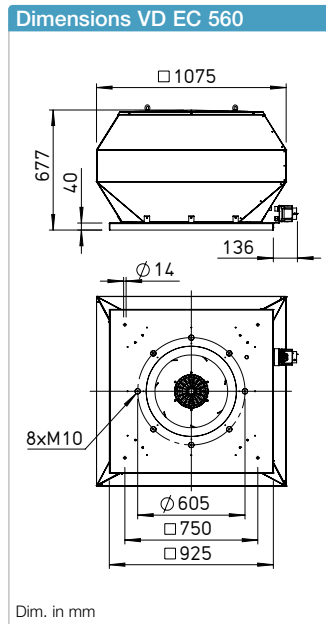
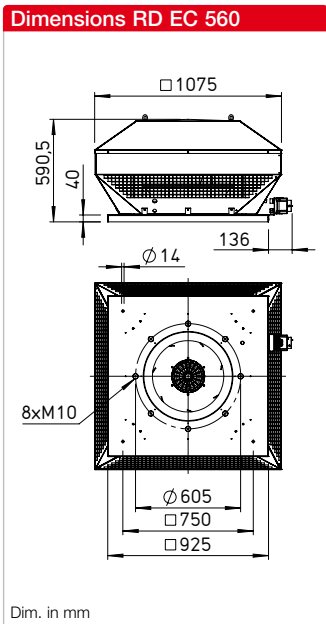

Description RD EC

Horizontal outlet EC roof fan with efficiency-optimised aluminium casing and newly developed high-performance centrifugal impeller.

Description VD EC

Vertical outlet EC roof fan with efficiency-optimised aluminium casing and newly developed high-performance centrifugal impeller.

Common features RD EC and VD EC

- **Casing**
 Made of sea water-resistant aluminium with integrated tamper protection. Motor support plate and base plate with inlet nozzle made of galvanised steel. Base plate with threaded screws for attachment of inlet-side accessories (hole pattern according to DIN 24155).

- **Impeller**
 High-performance centrifugal impeller with backward curved blades made of plastic. Dynamically balanced according to DIN ISO 21940-11 – quality grade 6.3.

- **Drive**
 Energy-saving, speed-controllable EC external rotor motor with the highest level of efficiency. Maintenance-free and radio interference-free, ball bearing mounted.

- **Motor protection**
 Integrated electronic temperature monitoring system for EC motor and electronics.

- **Electrical connection**
 ND 315 – 630 to external terminal box and isolator in protection category IP65.

- **Protection grille**
 On outlet side as standard according to DIN EN ISO 13857.

- **Power control**
 Continuously variable speed control via internal (delivery) or external potentiometer or continuously variable speed control with universal control system.

■ **Delivery**

Units are ready-for-connection, fully pre-assembled in the shipping box /wooden crate.

■ **Noise**

The total level and range are specified above the performance diagram for:

- Inlet side sound power
 - Outlet side sound power.
- The case-radiated noise as sound pressure at 4 m (free field conditions) is also specified in the type table and the table below the performance curve.

References	Page
Planning information	10 ff.
Technical description	491 f.
Selection table	493 f.
Accessories, details	550 f.
Universal control systems, electronic controllers, speed potentiometer	605 ff.

Performance curves RDD EC 560

Frequency	Hz	Tot.	125	250	500	1k	2k	4k	8k	
L _{WA} Inlet side		dB(A)	75	64	66	67	68	67	63	56
L _{WA} Outlet side		dB(A)	80	68	71	73	74	71	64	55

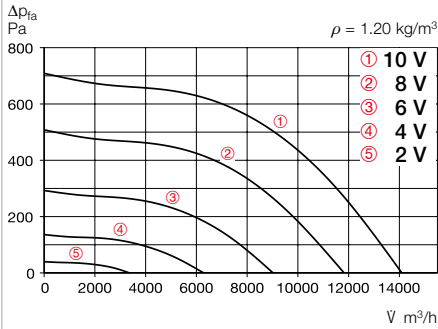

Free blowing						
Voltage V	n min ⁻¹	V m ³ /h	P W	I A	Lp dB(A)	SFP kW/m ³ /s
10	1100	14050	1790	2.70	63	0.46
8	920	11480	1050	1.67	59	0.33
6	670	8340	450	0.81	52	0.19
4	430	5380	150	0.32	42	0.10

Type	Ref. no.	Speed	Flow rate Free blowing	Noise sound pressure	Power consumption	Current consump.		Wiring diagram	Max. air flow temp.		Wgt net	Speed potentiometer			
						at rated voltage	with control		at rated voltage	with control		Flush-mounted		Surf.-mounted	
		min ⁻¹	m ³ /h	dB(A) in 4 m	W	A	A	No.	°C	°C	kg	Type	Ref. no.	Type	Ref. no.
Three phase current, 3~, 400 V, 50 Hz, EC motor, protection category IP54															
RDD EC 560	07435	1100	14091	62.5	2390	3.7	3.7	1148	60	–	70	PU 24	01736	PA 24	01737

Performance curves VDD EC 560

Frequency	Hz	Tot.	125	250	500	1k	2k	4k	8k	
L _{WA} Inlet side		dB(A)	75	65	67	68	69	68	64	57
L _{WA} Outlet side		dB(A)	79	68	72	74	73	69	65	58

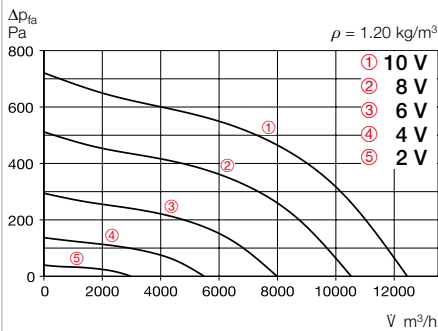

Free blowing						
Voltage V	n min ⁻¹	V m ³ /h	P W	I A	Lp dB(A)	SFP kW/m ³ /s
10	1100	12380	1925	2.90	62	0.56
8	915	10325	1120	1.80	58	0.39
6	670	7480	480	0.87	51	0.23
4	420	4750	150	0.35	41	0.11

Type	Ref. no.	Speed	Flow rate Free blowing	Noise sound pressure	Power consumption	Current consump.		Wiring diagram	Max. air flow temp.		Wgt net	Speed potentiometer			
						at rated voltage	with control		at rated voltage	with control		Flush-mounted		Surf.-mounted	
		min ⁻¹	m ³ /h	dB(A) in 4 m	W	A	A	No.	°C	°C	kg	Type	Ref. no.	Type	Ref. no.
Three phase current, 3~, 400 V, 50 Hz, EC motor, protection category IP54															
VDD EC 560	07433	1100	12465	62	2400	3.7	3.7	1148	60	–	75	PU 24	01736	PA 24	01737

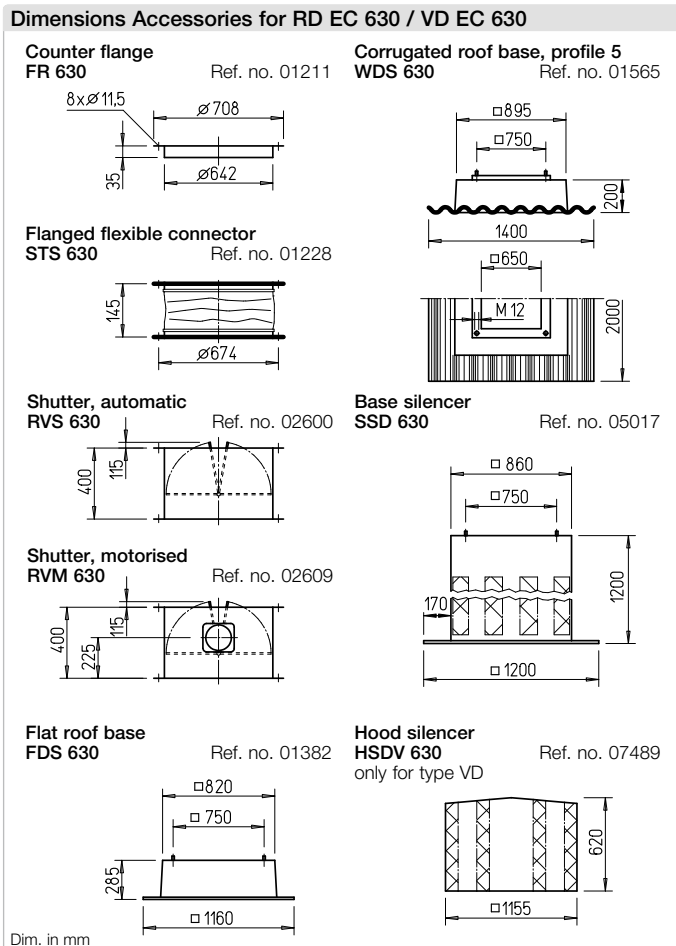
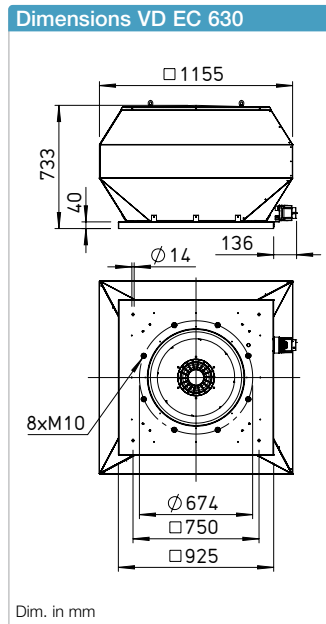
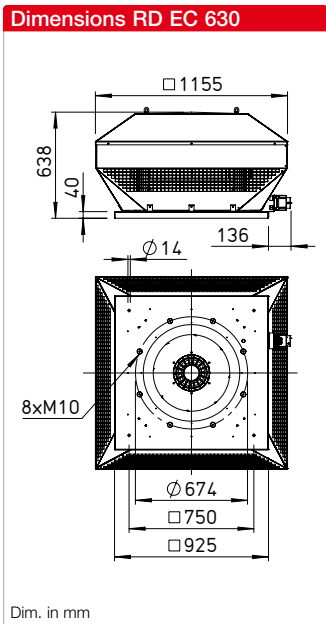

Description RD EC

Horizontal outlet EC roof fan with efficiency-optimised aluminium casing and newly developed high-performance centrifugal impeller.

Description VD EC

Vertical outlet EC roof fan with efficiency-optimised aluminium casing and newly developed high-performance centrifugal impeller.

Common features RD EC and VD EC

- **Casing**
Made of sea water-resistant aluminium with integrated tamper protection. Motor support plate and base plate with inlet nozzle made of galvanised steel. Base plate with threaded screws for attachment of inlet-side accessories (hole pattern according to DIN 24155).

- **Impeller**
High-performance centrifugal impeller with backward curved blades made of plastic. Dynamically balanced according to DIN ISO 21940-11 – quality grade 6.3.

- **Drive**
Energy-saving, speed-controllable EC external rotor motor with the highest level of efficiency. Maintenance-free and radio interference-free, ball bearing mounted.

- **Motor protection**
Integrated electronic temperature monitoring system for EC motor and electronics.

- **Electrical connection**
ND 315 – 630 to external terminal box and isolator in protection category IP65.

- **Protection grille**
On outlet side as standard according to DIN EN ISO 13857.

- **Power control**
Continuously variable speed control via internal (delivery) or external potentiometer or continuously variable speed control with universal control system.

■ **Delivery**

Units are ready-for-connection, fully pre-assembled in the shipping box /wooden crate.

■ **Noise**

The total level and range are specified above the performance diagram for:

- Inlet side sound power
 - Outlet side sound power.
- The case-radiated noise as sound pressure at 4 m (free field conditions) is also specified in the type table and the table below the performance curve.

References	Page
Planning information	10 ff.
Technical description	491 f.
Selection table	493 f.
Accessories, details	550 f.
Universal control systems, electronic controllers, speed potentiometer	605 ff.

Performance curves RDD EC 630

Frequency	Hz	Tot.	125	250	500	1k	2k	4k	8k	
L _{WA} Inlet side		dB(A)	80	63	70	74	75	73	71	62
L _{WA} Outlet side		dB(A)	84	68	73	80	79	75	69	63

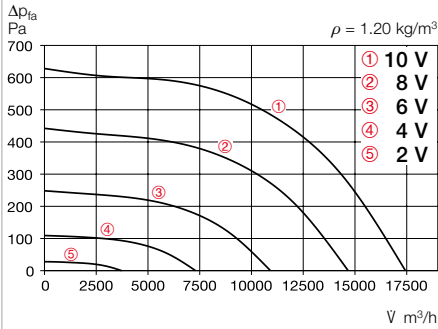

Free blowing						
Voltage V	n min ⁻¹	V m ³ /h	P W	I A	Lp dB(A)	SFP kW/m ³ /s
10	940	17710	2150	3.20	67	0.44
8	780	14650	1250	1.95	63	0.31
6	570	10580	490	0.90	56	0.17
4	350	6660	140	0.30	46	0.08

Type	Ref. no.	Speed	Flow rate Free blowing	Noise sound pressure	Power consumption	Current consump.		Wiring diagram	Max. air flow temp.		Wgt net	Speed potentiometer			
						at rated voltage	with control		at rated voltage	with control		Flush-mounted		Surf.-mounted	
		min ⁻¹	m ³ /h	dB(A) in 4 m	W	A	A	No.	°C	°C	kg	Type	Ref. no.	Type	Ref. no.
Three phase current, 3~, 400 V, 50 Hz, EC motor, protection category IP54															
RDD EC 630	07455	940	17457	67	2730	4.2	4.3	1148	60	–	87	PU 24	01736	PA 24	01737

Performance curves VDD EC 630

Frequency	Hz	Tot.	125	250	500	1k	2k	4k	8k	
L _{WA} Inlet side		dB(A)	80	63	70	74	75	73	71	62
L _{WA} Outlet side		dB(A)	84	68	73	80	79	75	69	63

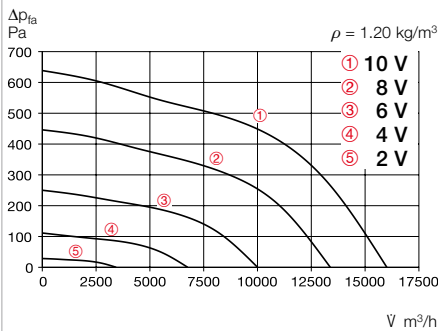

Free blowing						
Voltage V	n min ⁻¹	V m ³ /h	P W	I A	Lp dB(A)	SFP kW/m ³ /s
10	940	16000	2380	3.55	67	0.54
8	780	13180	1370	2.15	63	0.37
6	570	9530	540	0.95	56	0.20
4	350	5890	150	0.32	46	0.09

Type	Ref. no.	Speed	Flow rate Free blowing	Noise sound pressure	Power consumption	Current consump.		Wiring diagram	Max. air flow temp.		Wgt net	Speed potentiometer			
						at rated voltage	with control		at rated voltage	with control		Flush-mounted		Surf.-mounted	
		min ⁻¹	m ³ /h	dB(A) in 4 m	W	A	A	No.	°C	°C	kg	Type	Ref. no.	Type	Ref. no.
Three phase current, 3~, 400 V, 50 Hz, EC motor, protection category IP54															
VDD EC 630	07451	940	16013	66.5	2700	4.2	4.2	1148	60	–	90	PU 24	01736	PA 24	01737

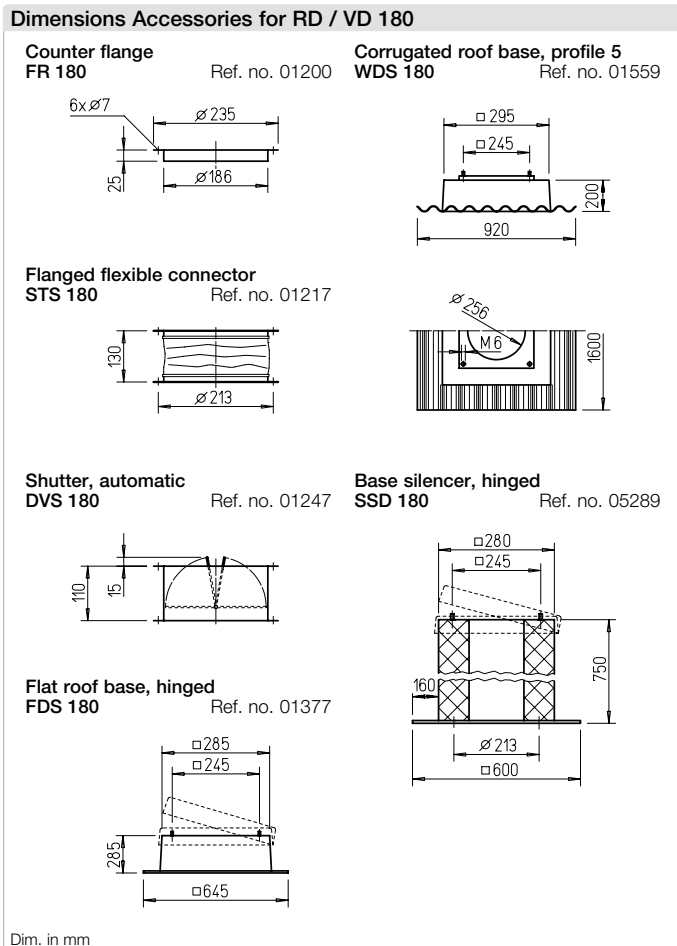
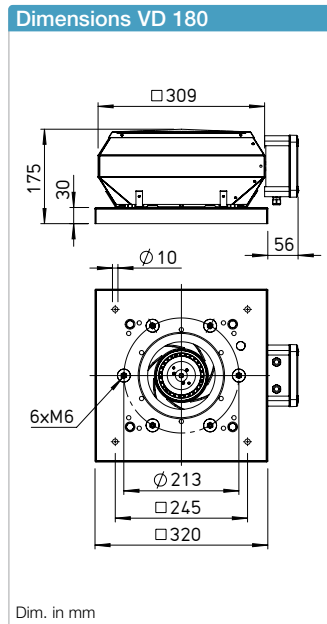
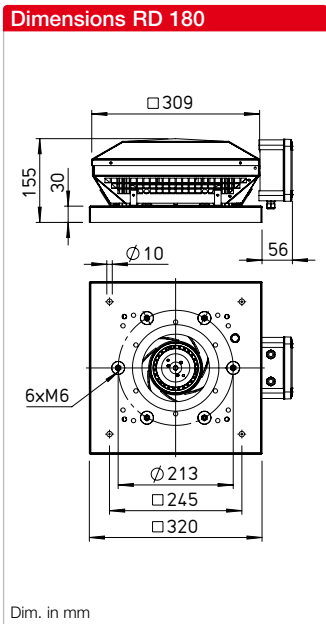

Description RD

Horizontal outlet roof fan with efficiency-optimised aluminium casing and newly developed high-performance centrifugal impeller.

Description VD

Vertical outlet roof fan with efficiency-optimised aluminium casing and newly developed high-performance centrifugal impeller.

Description of all series

Casing
 Casing made of sea water-resistant aluminium with integrated tamper protection. Motor support plate and base plate with inlet nozzle made of galvanised steel. Base plate with threaded screws for attachment of inlet-side accessories (hole pattern according to DIN 24155).

Impeller
 High-performance centrifugal impeller with backward curved blades made of plastic. Dynamically balanced according to DIN ISO 21940-11 – quality grade 6.3.

Drive
 Speed-controllable external rotor motor in closed design (IP44). Ball bearing mounted with moisture protection. Maintenance-free and radio interference-free.

Motor protection
 Through built-in thermal contacts which are wired in series to the winding and automatically deactivate and reactivate after cooling when the motor temperature is too high.

Electrical connection
 To external terminal box in protection category IP65. Isolator switch is optionally available (see Accessories).

Protection grille
 On the outlet side as standard according to DIN EN ISO 13857.

Power control
 All types have continuously variable speed control in the range from 0 – 100 % through electronic speed controllers or five-step control units. Assignment see type table.

Delivery
 Units are ready-for-connection, fully pre-assembled in the shipping box.

Noise
 The total level and range are specified above the performance diagram for:
 Inlet side sound power
 Outlet side sound power.
 The horizontally case-radiated noise as sound pressure at 4 m (free field conditions) is also specified in the type table.

References	Page
Planning information	10 ff.
Technical description	491 f.
Selection table	494 f.
Accessories, details	550 f.
Speed controllers, controllers and switches	591 ff.

Performance curves RDW 180/2

Frequency	Hz	Tot.	125	250	500	1k	2k	4k	8k	
L _{wa} Inlet side		dB(A)	61	37	48	53	56	55	54	44
L _{wa} Outlet side		dB(A)	65	38	52	58	62	57	54	45

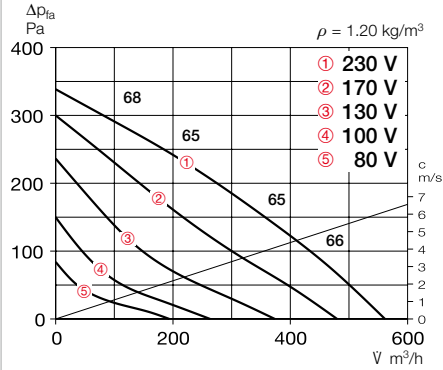

Type	Ref. no.	Speed	Flow rate Free blowing	Noise sound pressure	Power consump.	Current consump. at rated voltage	Current consump. with control	Wiring diagram	Max. air flow temp. at rated voltage	Max. air flow temp. with control	Weight net	Motor protection circuit breaker	Speed controller 5-step
		min ⁻¹	m ³ /h	dB(A) in 4 m	W	A	A	No.	°C	°C	kg	Type	Ref. no.
Single phase alternating current, 1~, 230 V, 50 Hz, Capacitor motor, protection category IP44													
RDW 180/2	07122	2320	566	46	58	0.25	0.25	923	70	70	4.6	—	TSW 1.5 01495

Performance curves VDW 180/2

Frequency	Hz	Tot.	125	250	500	1k	2k	4k	8k	
L _{wa} Inlet side		dB(A)	60	36	47	52	55	54	53	43
L _{wa} Outlet side		dB(A)	63	38	51	56	59	57	52	43

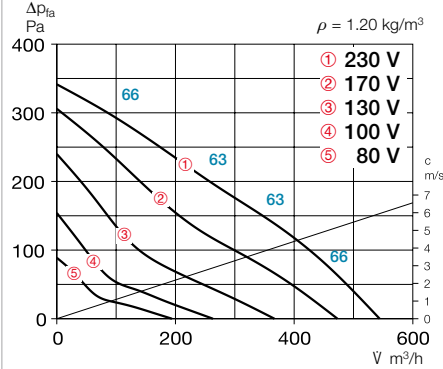

Type	Ref. no.	Speed	Flow rate Free blowing	Noise sound pressure	Power consump.	Current consump. at rated voltage	Current consump. with control	Wiring diagram	Max. air flow temp. at rated voltage	Max. air flow temp. with control	Weight net	Motor protection circuit breaker	Speed controller 5-step
		min ⁻¹	m ³ /h	dB(A) in 4 m	W	A	A	No.	°C	°C	kg	Type	Ref. no.
Single phase alternating current, 1~, 230 V, 50 Hz, Capacitor motor, protection category IP44													
VDW 180/2	07120	2320	545	46	56	0.25	0.25	923	70	70	4.6	—	TSW 1.5 01495

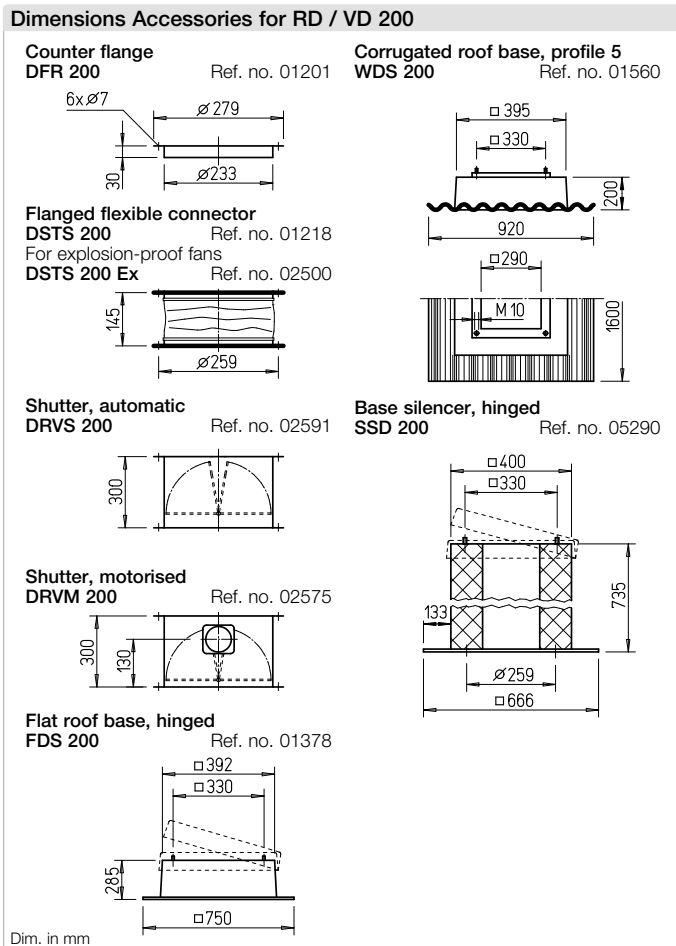
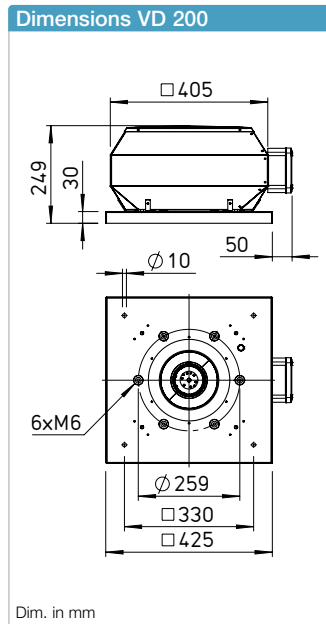
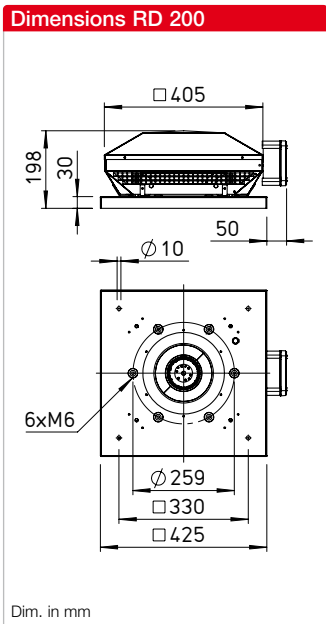

Description RD

Horizontal outlet roof fan with efficiency-optimised aluminium casing and newly developed high-performance centrifugal impeller.

Description VD

Vertical outlet roof fan with efficiency-optimised aluminium casing and newly developed high-performance centrifugal impeller.

Description of all series

- **Casing**
 Casing made of sea water-resistant aluminium with integrated tamper protection. Motor support plate and base plate with inlet nozzle made of galvanised steel (explosion-proof version inlet nozzle made of aluminium). Base plate with threaded screws for attachment of inlet-side accessories (hole pattern according to DIN 24155).

- **Impeller**
 High-performance centrifugal impeller with backward curved blades made of galvanised steel sheet (explosion-proof version made of aluminium). Dynamically balanced according to DIN ISO 21940-11 – quality grade 6.3.

- **Drive**
 Speed-controllable external rotor motor in closed design (IP44). Ball bearing mounted with moisture protection. Maintenance-free and radio interference-free.

- **Motor protection**
 Through built-in thermal contacts which are wired in series to the winding and automatically deactivate and reactivate after cooling when the motor temperature is too high. Explosion-proof version with thermal motor protection through built-in PTC thermistors.

- **Electrical connection**
 To external terminal box in protection category IP65. Isolator switch is optionally available (see Accessories).

- **Protection grille**
 On the outlet side as standard according to DIN EN ISO 13857.
- **Power control**
 All types have continuously variable speed control in the range from 0 – 100 % through electronic speed controllers (except for explosion-proof version) or five-step control units. Assignment see type table.
- **Delivery**
 Units are ready-for-connection, fully pre-assembled in the shipping box.
- **Noise**
 The total level and range are specified above the performance diagram for:
 Inlet side sound power
 Outlet side sound power.
 The horizontally case-radiated noise as sound pressure at 4 m (free field conditions) is also specified in the type table.

References	Page
Planning information	10 ff.
Technical description	492 f.
Selection table	494 f.
Accessories, details	550 f.
Speed controllers, controllers and switches	591 ff.

Performance curves RDW 200/2

Frequency	Hz	Tot.	125	250	500	1k	2k	4k	8k
L _{WA} Inlet side	dB(A)	68	44	57	61	63	60	60	57
L _{WA} Outlet side	dB(A)	71	45	62	66	65	62	62	58

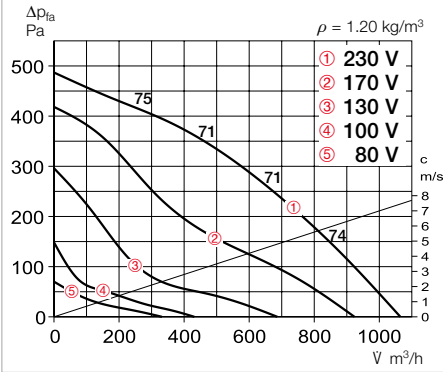

Performance curves RDW 200/4

Frequency	Hz	Tot.	125	250	500	1k	2k	4k	8k
L _{WA} Inlet side	dB(A)	56	32	45	49	51	48	48	45
L _{WA} Outlet side	dB(A)	59	33	50	54	53	50	50	46

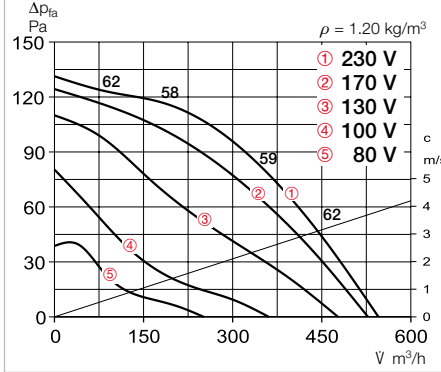

Type	Ref. no.	Speed	Flow rate Free blowing	Noise sound pressure	Power consump.	Current consump.		Wiring diagram	Max. air flow temp.		Weight net	Motor protection circuit breaker		Speed controller 5-step	
						at rated voltage	with control		at rated voltage	with control		Type	Ref. no.	Type	Ref. no.
Single phase alternating current, 1~, 230 V, 50 Hz, Capacitor motor, protection category IP44															
RDW 200/4	07177	1375	545	42	34	0.16	0.16	923	70	70	7.3	—	—	TSW 1.5	01495
RDW 200/2	07176	2430	1070	54	125	0.56	0.56	923	70	70	7.5	—	—	TSW 1.5	01495
Ex Ex Explosion-proof, II 3G Ex h IIB + H ₂ T3 Gc, Motor Ex nA, Three phase current, 3~, 400 V, 50 Hz, Protection category IP44															
RDD 200/4 Ex ¹⁾	07191	1465	610	41	80	0.37	0.37	1156	40	40	9.5	MSA	01289	TSD 0.8	01500

¹⁾ Performance diagram at www.HeliosSelect.de.

Performance curves VDW 200/2

Frequency	Hz	Tot.	125	250	500	1k	2k	4k	8k
L _{WA} Inlet side	dB(A)	68	43	58	60	63	61	60	56
L _{WA} Outlet side	dB(A)	70	46	63	64	63	62	61	58

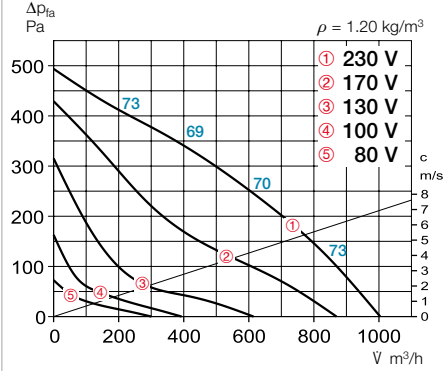

Performance curves VDW 200/4

Frequency	Hz	Tot.	125	250	500	1k	2k	4k	8k
L _{WA} Inlet side	dB(A)	52	35	41	47	46	44	44	35
L _{WA} Outlet side	dB(A)	54	38	47	49	46	46	45	37

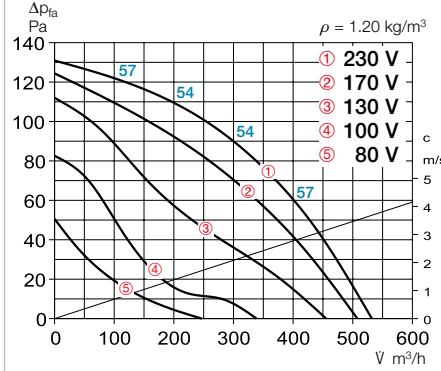

Type	Ref. no.	Speed	Flow rate Free blowing	Noise sound pressure	Power consump.	Current consump.		Wiring diagram	Max. air flow temp.		Weight net	Motor protection circuit breaker		Speed controller 5-step	
						at rated voltage	with control		at rated voltage	with control		Type	Ref. no.	Type	Ref. no.
Single phase alternating current, 1~, 230 V, 50 Hz, Capacitor motor, protection category IP44															
VDW 200/4	07134	1375	535	37	34	0.16	0.16	923	70	70	7.2	—	—	TSW 1.5	01495
VDW 200/2	07126	2430	1000	53	125	0.56	0.56	923	70	70	7.8	—	—	TSW 1.5	01495
Ex Ex Explosion-proof, II 3G Ex h IIB + H ₂ T3 Gc, Motor Ex nA, Three phase current, 3~, 400 V, 50 Hz, Protection category IP44															
VDD 200/4 Ex ¹⁾	07178	1465	580	39	80	0.38	0.38	1156	40	40	9.5	MSA	01289	TSD 0.8	01500

¹⁾ Performance diagram at www.HeliosSelect.de.

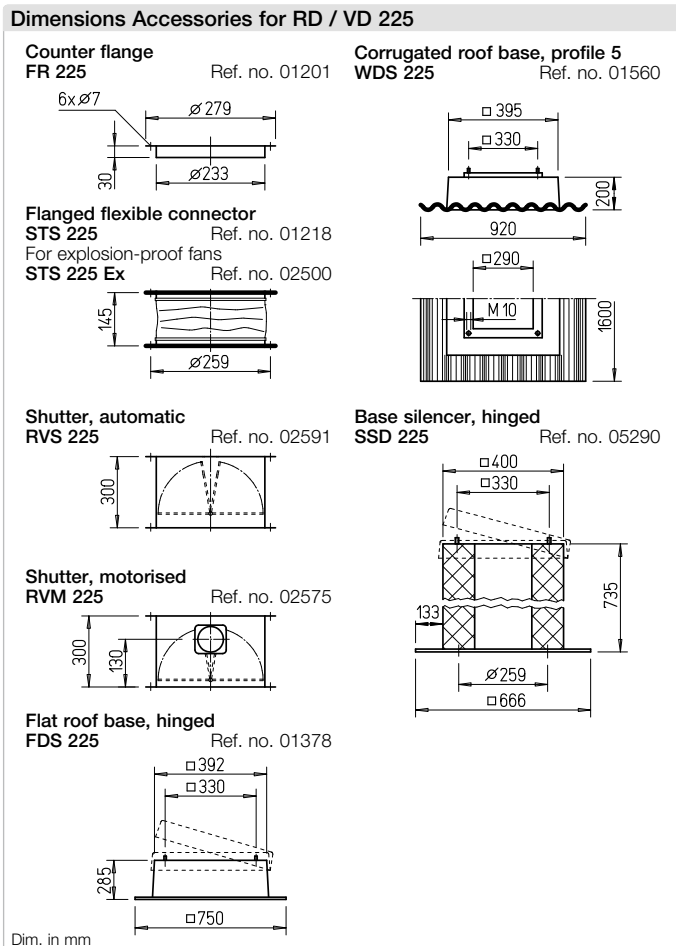
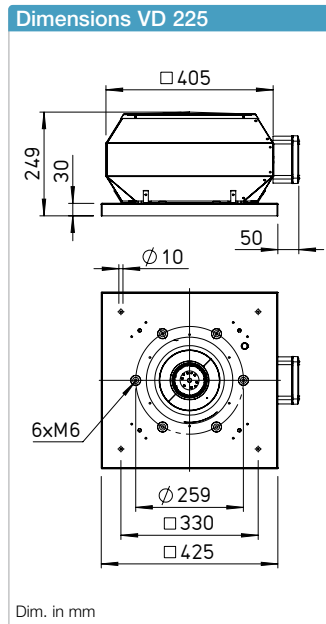
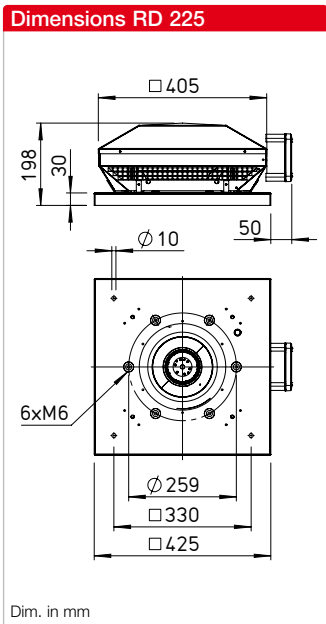

Description RD

Horizontal outlet roof fan with efficiency-optimised aluminium casing and newly developed high-performance centrifugal impeller.

Description VD

Vertical outlet roof fan with efficiency-optimised aluminium casing and newly developed high-performance centrifugal impeller.

Description of all series

- **Casing**
 Casing made of sea water-resistant aluminium with integrated tamper protection. Motor support plate and base plate with inlet nozzle made of galvanised steel (explosion-proof version inlet nozzle made of aluminium). Base plate with threaded screws for attachment of inlet-side accessories (hole pattern according to DIN 24155).

- **Impeller**
 High-performance centrifugal impeller with backward curved blades made of galvanised steel sheet (explosion-proof version made of aluminium). Dynamically balanced according to DIN ISO 21940-11 – quality grade 6.3.

- **Drive**
 Speed-controllable external rotor motor in closed design (IP44). Ball bearing mounted with moisture protection. Maintenance-free and radio interference-free.

- **Motor protection**
 Through built-in thermal contacts which are wired in series to the winding and automatically deactivate and reactivate after cooling when the motor temperature is too high. Explosion-proof version with thermal motor protection through built-in PTC thermistors.

- **Electrical connection**
 To external terminal box in protection category IP65. Isolator switch is optionally available (see Accessories).

- **Protection grille**
 On the outlet side as standard according to DIN EN ISO 13857.
- **Power control**
 All types have continuously variable speed control in the range from 0 – 100 % through electronic speed controllers (except for explosion-proof version) or five-step control units. Assignment see type table.
- **Delivery**
 Units are ready-for-connection, fully pre-assembled in the shipping box.
- **Noise**
 The total level and range are specified above the performance diagram for:
 - Inlet side sound power
 - Outlet side sound power.
 The horizontally case-radiated noise as sound pressure at 4 m (free field conditions) is also specified in the type table.

References	Page
Planning information	10 ff.
Technical description	492 f.
Selection table	494 f.
Accessories, details	550 f.
Speed controllers, controllers and switches	591 ff.

Performance curves RDW 225/2

Frequency	Hz	Tot.	125	250	500	1k	2k	4k	8k
L _{WA} Inlet side	dB(A)	70	48	63	64	64	63	59	51
L _{WA} Outlet side	dB(A)	72	50	62	66	67	65	62	56

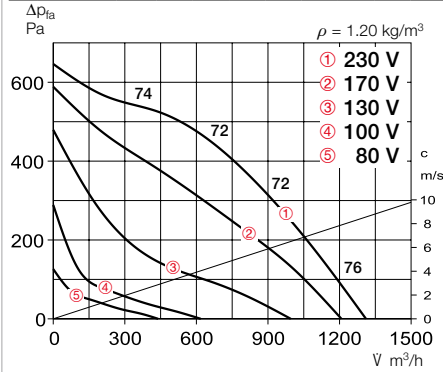

Performance curves RDW 225/4

Frequency	Hz	Tot.	125	250	500	1k	2k	4k	8k
L _{WA} Inlet side	dB(A)	56	37	49	53	54	52	49	43
L _{WA} Outlet side	dB(A)	59	37	49	53	54	52	49	43

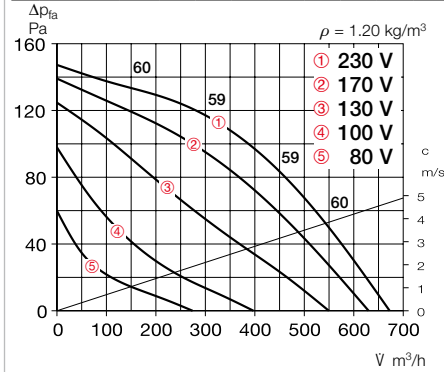

Type	Ref. no.	Speed	Flow rate Free blowing	Noise sound pressure	Power consump.	Current consump.		Wiring diagram	Max. air flow temp.		Weight net	Motor protection circuit breaker		Speed controller 5-step	
						at rated voltage	with control		at rated voltage	with control		Type	Ref. no.	Type	Ref. no.
Single phase alternating current, 1~, 230 V, 50 Hz, Capacitor motor, protection category IP44															
RDW 225/4	07235	1340	650	43	43	0.2	0.2	923	70	70	7.8	—	—	TSW 1.5	01495
RDW 225/2	07234	2635	1330	58	208	0.9	1.0	923	70	70	8.3	—	—	TSW 1.5	01495
Explosion-proof, II 3G Ex h IIB + H ₂ T3 Gc, Motor Ex nA, Three phase current, 3~, 400 V, 50 Hz, Protection category IP44															
RDD 225/4 Ex ¹⁾	07239	1445	845	43	100	0.37	0.37	1156	40	40	9.5	MSA	01289	TSD 0.8	01500

1) Performance diagram at www.HeliosSelect.de.

Performance curves VDW 225/2

Frequency	Hz	Tot.	125	250	500	1k	2k	4k	8k
L _{WA} Inlet side	dB(A)	69	47	62	63	63	62	58	50
L _{WA} Outlet side	dB(A)	71	49	61	65	66	64	61	55

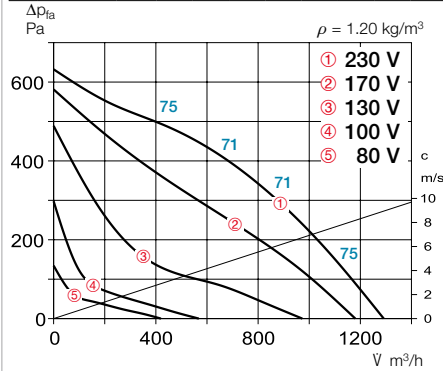

Performance curves VDW 225/4

Frequency	Hz	Tot.	125	250	500	1k	2k	4k	8k
L _{WA} Inlet side	dB(A)	56	34	49	50	50	49	45	37
L _{WA} Outlet side	dB(A)	58	36	48	52	53	51	48	42

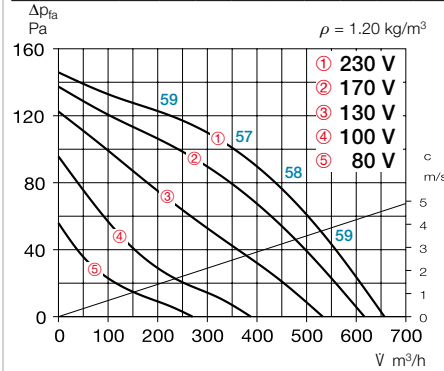

Type	Ref. no.	Speed	Flow rate Free blowing	Noise sound pressure	Power consump.	Current consump.		Wiring diagram	Max. air flow temp.		Weight net	Motor protection circuit breaker		Speed controller 5-step	
						at rated voltage	with control		at rated voltage	with control		Type	Ref. no.	Type	Ref. no.
Single phase alternating current, 1~, 230 V, 50 Hz, Capacitor motor, protection category IP44															
VDW 225/4	07221	1340	640	42	43	0.2	0.2	923	70	70	8.0	—	—	TSW 1.5	01495
VDW 225/2	07196	2635	1295	56	208	0.9	1.0	923	70	70	8.3	—	—	TSW 1.5	01495
Explosion-proof, II 3G Ex h IIB + H ₂ T3 Gc, Motor Ex nA, Three phase current, 3~, 400 V, 50 Hz, Protection category IP44															
VDD 225/4 Ex ¹⁾	07237	1450	810	41	100	0.37	0.37	1156	40	40	9.5	MSA	01289	TSD 0.8	01500

1) Performance diagram at www.HeliosSelect.de.

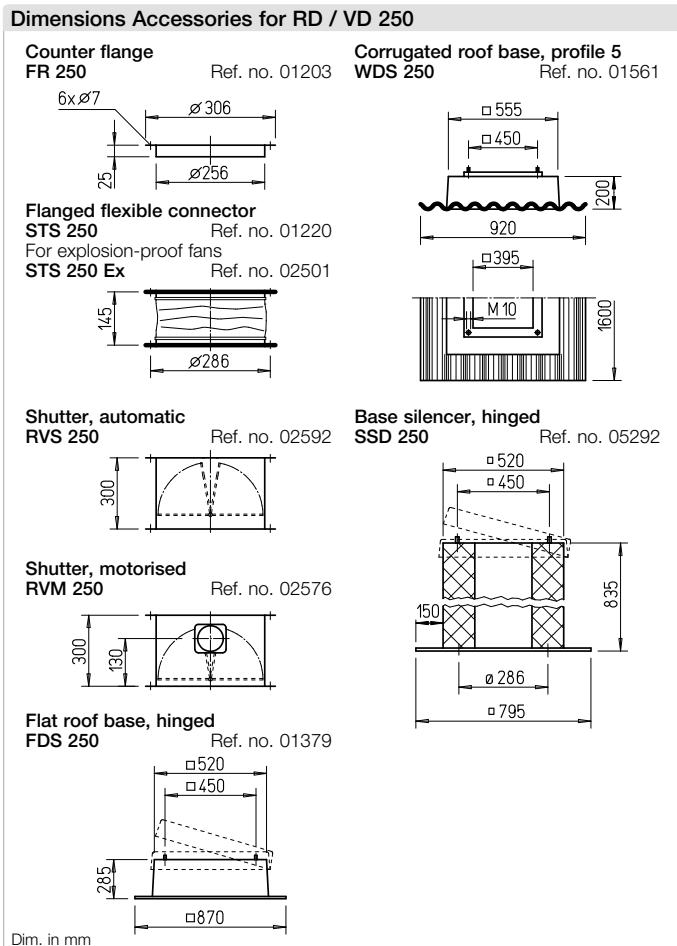
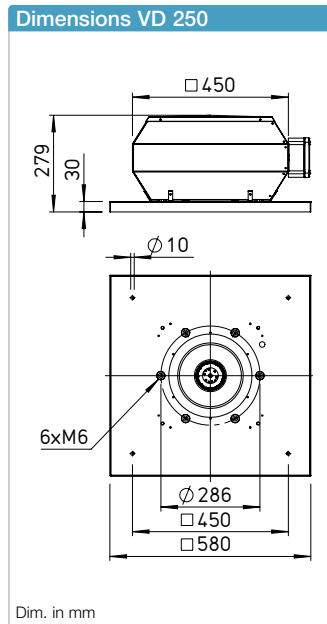
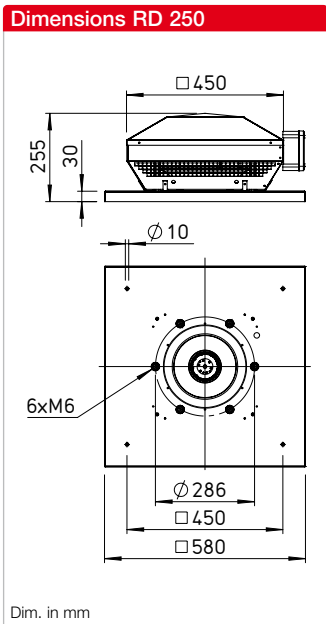

Description RD

Horizontal outlet roof fan with efficiency-optimised aluminium casing and newly developed high-performance centrifugal impeller.

Description VD

Vertical outlet roof fan with efficiency-optimised aluminium casing and newly developed high-performance centrifugal impeller.

Description of all series

- **Casing**
 Casing made of sea water-resistant aluminium with integrated tamper protection. Motor support plate and base plate with inlet nozzle made of galvanised steel (explosion-proof version inlet nozzle made of aluminium). Base plate with threaded screws for attachment of inlet-side accessories (hole pattern according to DIN 24155).

- **Impeller**
 High-performance centrifugal impeller with backward curved blades made of galvanised steel sheet (explosion-proof version made of aluminium). Dynamically balanced according to DIN ISO 21940-11 – quality grade 6.3.

- **Drive**
 Speed-controllable external rotor motor in closed design (IP44). Ball bearing mounted with moisture protection. Maintenance-free and radio interference-free.

- **Motor protection**
 Through built-in thermal contacts which are wired in series to the winding and automatically deactivate and reactivate after cooling when the motor temperature is too high. Explosion-proof version with thermal motor protection through built-in PTC thermistors.

- **Electrical connection**
 To external terminal box in protection category IP65. Isolator switch is optionally available (see Accessories).

- **Protection grille**
 On the outlet side as standard according to DIN EN ISO 13857.
- **Power control**
 All types have continuously variable speed control in the range from 0 – 100 % through electronic speed controllers (except for explosion-proof version) or five-step control units. Assignment see type table.
- **Delivery**
 Units are ready-for-connection, fully pre-assembled in the shipping box.
- **Noise**
 The total level and range are specified above the performance diagram for:
 Inlet side sound power
 Outlet side sound power.
 The horizontally case-radiated noise as sound pressure at 4 m (free field conditions) is also specified in the type table.

References	Page
Planning information	10 ff.
Technical description	492 f.
Selection table	494 f.
Accessories, details	550 f.
Speed controllers, controllers and switches	591 ff.

Performance curves RDW 250/4

Frequency	Hz	Tot.	125	250	500	1k	2k	4k	8k
L _{WA} Inlet side	dB(A)	58	46	48	52	52	50	50	41
L _{WA} Outlet side	dB(A)	61	50	52	55	54	54	52	44

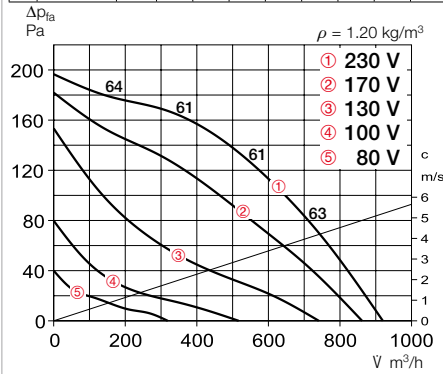

Type	Ref. no.	Speed	Flow rate Free blowing	Noise sound pressure	Power consump.	Current consump.		Wiring diagram	Max. air flow temp.		Weight net	Motor protection circuit breaker		Speed controller 5-step	
						at rated voltage	with control		at rated voltage	with control		Type	Ref. no.	Type	Ref. no.
Single phase alternating current, 1~, 230 V, 50 Hz, Capacitor motor, protection category IP44															
RDW 250/4	07264	1340	920	44	63	0.28	0.28	923	70	70	11.5	—	—	TSW 1.5	01495
Explosion-proof, II 3G Ex h IIB + H ₂ T3 Gc, Motor Ex nA, Three phase current, 3~, 400 V, 50 Hz, Protection category IP44															
RDD 250/4 Ex¹⁾	07273	1400	1350	46	130	0.38	0.38	1156	40	40	12.0	MSA	01289	TSD 0.8	01500

¹⁾ Performance diagram at www.HeliosSelect.de.

Performance curves VDW 250/4

Frequency	Hz	Tot.	125	250	500	1k	2k	4k	8k
L _{WA} Inlet side	dB(A)	58	40	49	51	52	51	51	39
L _{WA} Outlet side	dB(A)	60	47	52	54	53	52	52	44

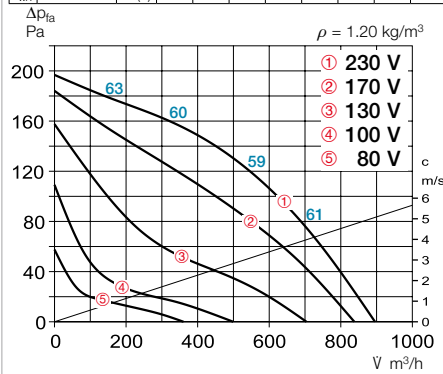

Type	Ref. no.	Speed	Flow rate Free blowing	Noise sound pressure	Power consump.	Current consump.		Wiring diagram	Max. air flow temp.		Weight net	Motor protection circuit breaker		Speed controller 5-step	
						at rated voltage	with control		at rated voltage	with control		Type	Ref. no.	Type	Ref. no.
Single phase alternating current, 1~, 230 V, 50 Hz, Capacitor motor, protection category IP44															
VDW 250/4	07244	1340	900	43	63	0.28	0.28	923	70	70	11.5	—	—	TSW 1.5	01495
Explosion-proof, II 3G Ex h IIB + H ₂ T3 Gc, Motor Ex nA, Three phase current, 3~, 400 V, 50 Hz, Protection category IP44															
VDD 250/4 Ex¹⁾	07265	1400	1280	45	120	0.37	0.37	1156	40	40	12.5	MSA	01289	TSD 0.8	01500

¹⁾ Performance diagram at www.HeliosSelect.de.



Impeller
 High-performance centrifugal impeller with backward curved blades made of plastic (T120 and explosion-proof version made of aluminium). Dynamically balanced according to DIN ISO 21940-11 – quality grade 6.3.

Drive
 Speed-controllable external rotor motor in closed design (IP54) (explosion-proof version in IP44). Flange motor with self-ventilation (T120 version) in IP54. Ball bearing mounted with moisture protection. Maintenance-free and radio interference-free.

Motor protection
 Through built-in thermal contacts or built-in PTC thermistors, which must be connected to a motor protection circuit breaker. Assignment see type table.

Electrical connection
 No dismantling of casing, to external isolator switch (explosion-proof version to terminal box) in protection category IP65.

Protection grille
 On the outlet side as standard according to DIN EN ISO 13857.

Power control

All 1~ types have continuously variable speed control in the range from 0 – 100 % through electronic speed controllers or five-step control units. All 3~ types have continuously variable speed control in the range 0 – 100 % with a frequency inverter with integrated, all-pole effective sine filter (except for explosion-proof version) or five-step control units. Assignment see type table.

Delivery
 Units are ready-for-connection, fully pre-assembled in the shipping box.

Noise
 The total level and range are specified above the performance diagram for:

- Inlet side sound power
 - Outlet side sound power.
- The horizontally case-radiated noise as sound pressure at 4 m (free field conditions) is also specified in the type table. Hood silencer see Accessories.

References	Page
Planning information	10 ff.
Technical description	492 f.
Selection table	494 f.
Accessories, details	550 f.
Speed controllers, controllers and switches	591 ff.

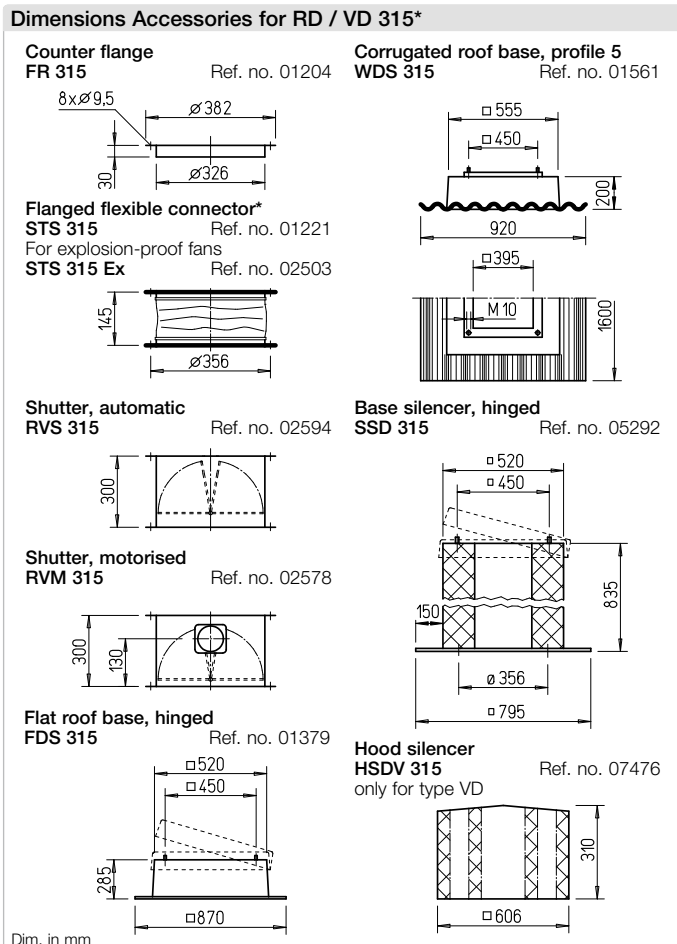
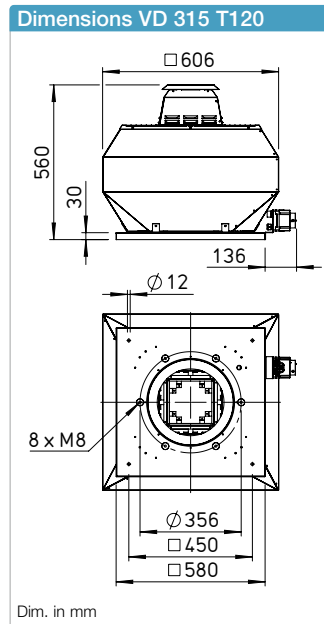
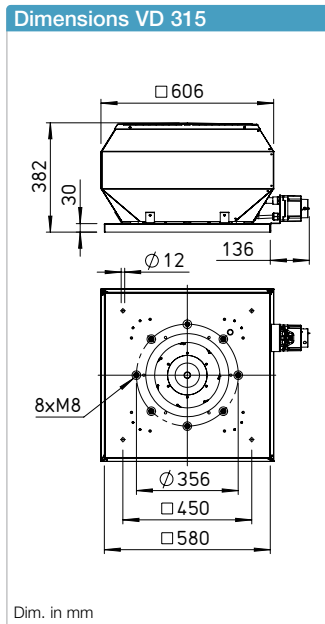
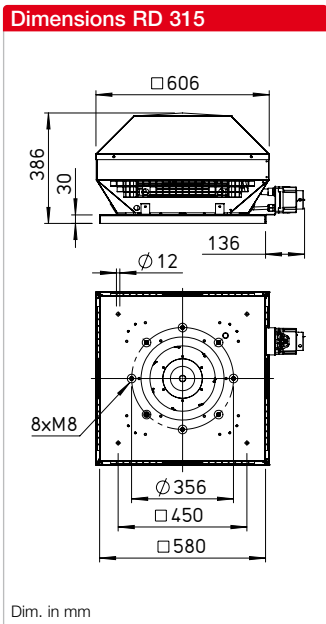

Description RD
 Horizontal outlet roof fan with efficiency-optimised aluminium casing and newly developed high-performance centrifugal impeller.

Description VD
 Vertical outlet roof fan with efficiency-optimised aluminium casing and newly developed high-performance centrifugal impeller.

Description VD T120
 Designed for the delivery of process air up to +120 °C. Enclosed motor located outside of the air flow. Compliant with VDI 2052.

Description of all series

Casing
 Casing made of sea water-resistant aluminium with integrated tamper protection. Motor support plate and base plate with inlet nozzle made of galvanised steel (explosion-proof version inlet nozzle made of aluminium). Base plate with threaded screws for attachment of inlet-side accessories (hole pattern according to DIN 24155).

* Accessories VD T120 see installation accessories p. 551 f. Other accessories upon request.

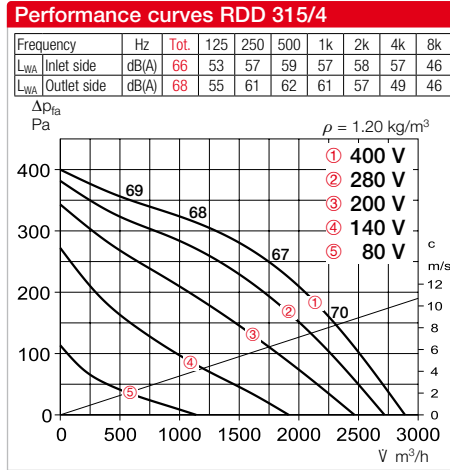
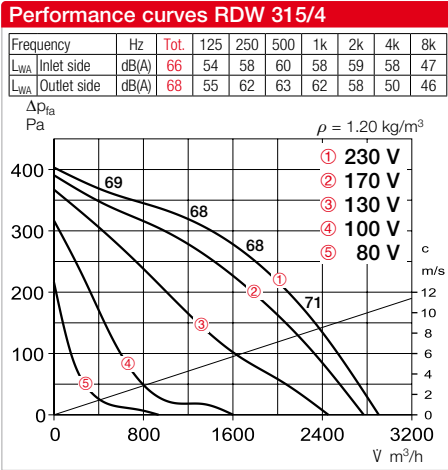

Type	Ref. no.	Speed	Flow rate Free blowing	Noise sound pressure	Power consump.	Current consump.		Wiring diagram	Max. air flow temp.		Weight net	Motor protection circuit breaker		Speed controller 5-step	
						at rated voltage	with control		at rated voltage	with control		Type	Ref. no.	Type	Ref. no.
		min ⁻¹	m ³ /h	dB(A) in 4 m	W	A	A	No.	°C	°C	kg	Type	Ref. no.	Type	Ref. no.
Single phase alternating current, 1~, 230 V, 50 Hz, Capacitor motor, protection category IP54															
RDW 315/4	07287	1385	2900	51	300	1.47	2.0	1128	60	60	16.0	MW	01579	MWS 3²⁾	01948
Three phase current, 3~, 400 V, 50 Hz, Squirrel-cage rotor, Protection category IP54															
RDD 315/4	07288	1385	2890	51	290	0.67	0.67	1129	60	60	19.0	MD	05849	RDS 1²⁾	01314
Ex Ex Explosion-proof, II 2G Ex h IIB + H₂ T3 Gb, Motor Ex e, Three phase current, 3~, 400 V, 50 Hz, Protection category IP44															
RDD 315/4 Ex¹⁾	07303	1390	2890	51.5	340	0.73	0.73	1157	40	40	19.0	MSA	01289	TSD 1.5	01501

1) Performance diagram at www.HeliosSelect.de.

2) Includes motor protection circuit breaker.

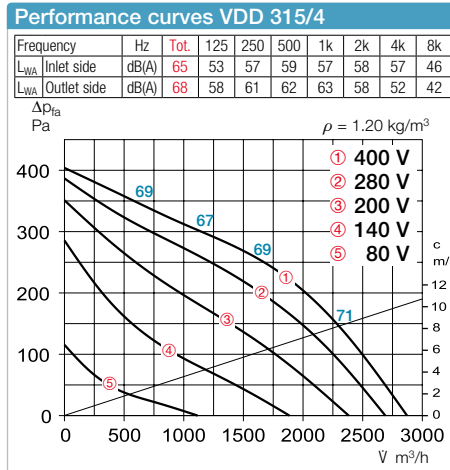
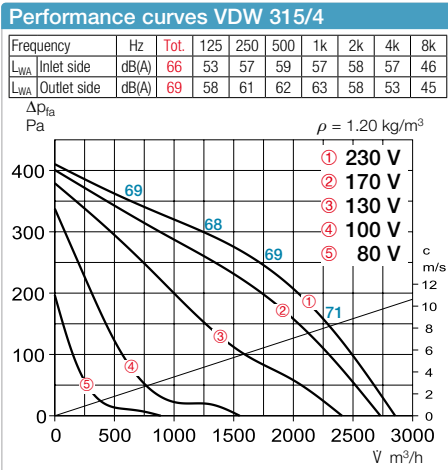

Type	Ref. no.	Speed	Flow rate Free blowing	Noise sound pressure	Power consump.	Current consump.		Wiring diagram	Max. air flow temp.		Weight net	Motor protection circuit breaker		Speed controller 5-step	
						at rated voltage	with control		at rated voltage	with control		Type	Ref. no.	Type	Ref. no.
		min ⁻¹	m ³ /h	dB(A) in 4 m	W	A	A	No.	°C	°C	kg	Type	Ref. no.	Type	Ref. no.
Single phase alternating current, 1~, 230 V, 50 Hz, Capacitor motor, protection category IP54															
VDW 315/4	07279	1385	2860	52	300	1.47	2.0	1128	60	50	21.0	MW	01579	MWS 3²⁾	01948
Three phase current, 3~, 400 V, 50 Hz, Squirrel-cage rotor, Protection category IP54															
VDD 315/4	07282	1385	2880	51	290	0.67	0.67	1129	60	60	20.0	MD	05849	RDS 1²⁾	01314
Ex Ex Explosion-proof, II 2G Ex h IIB + H₂ T3 Gb, Motor Ex e, Three phase current, 3~, 400 V, 50 Hz, Protection category IP44															
VDD 315/4 Ex¹⁾	07293	1390	2770	50.5	330	0.71	1.71	1157	40	40	19.5	MSA	01289	TSD 1.5	01501
T120 Three phase current, 3~, 400 V, 50 Hz, Squirrel-cage rotor, Protection category IP54															
VDD 315/4 T120¹⁾	07315	1450	3372	55	395	0.89	1.1	1264	120	100	25.0	MD	05849	RDS 2²⁾	01315

1) Performance diagram at www.HeliosSelect.de.

2) Includes motor protection circuit breaker.



Impeller
 High-performance centrifugal impeller with backward curved blades made of plastic (T120 and explosion-proof version made of aluminium). Dynamically balanced according to DIN ISO 21940-11 – quality grade 6.3.

Drive
 Speed-controllable external rotor motor in closed design (IP54) (explosion-proof version in IP44). Flange motor with self-ventilation (T120 version) in IP54. Ball bearing mounted with moisture protection. Maintenance-free and radio interference-free.

Motor protection
 Through built-in thermal contacts or built-in PTC thermistors, which must be connected to a motor protection circuit breaker. Assignment see type table.

Electrical connection
 No dismantling of casing, to external isolator switch (explosion-proof version to terminal box) in protection category IP65.

Protection grille
 On the outlet side as standard according to DIN EN ISO 13857.

Power control
 All 1~ types have continuously variable speed control in the range from 0 – 100 % through electronic speed controllers or five-step control units. All 3~ types have continuously variable speed control in the range 0 – 100 % with a frequency inverter with integrated, all-pole effective sine filter (except for explosion-proof version) or five-step control units. Assignment see type table.

Delivery
 Units are ready-for-connection, fully pre-assembled in the shipping box.

Noise
 The total level and range are specified above the performance diagram for:

- Inlet side sound power
 - Outlet side sound power.
- The horizontally case-radiated noise as sound pressure at 4 m (free field conditions) is also specified in the type table. Hood silencer see Accessories.

References	Page
Planning information	10 ff.
Technical description	492 f.
Selection table	494 f.
Accessories, details	550 f.
Speed controllers, controllers and switches	591 ff.

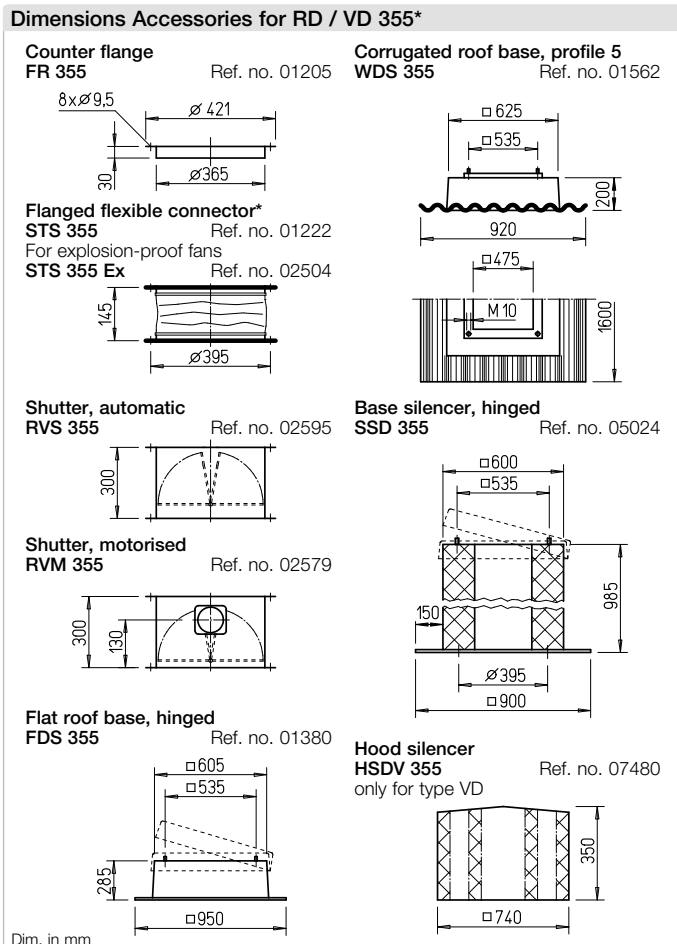
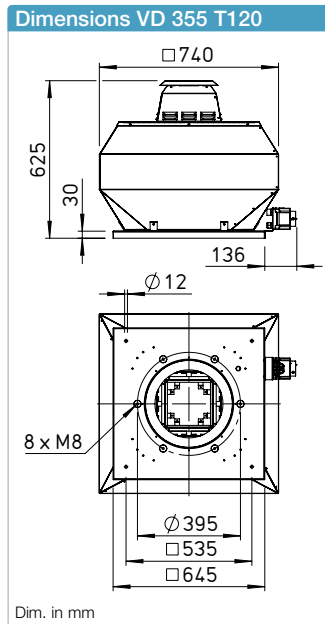
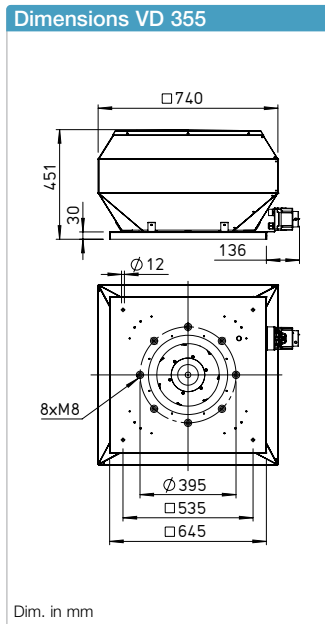
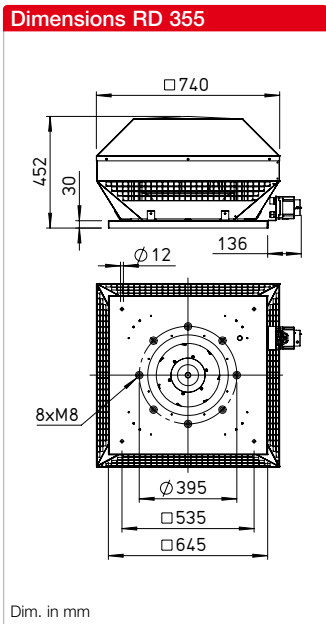

Description RD
 Horizontal outlet roof fan with efficiency-optimised aluminium casing and newly developed high-performance centrifugal impeller.

Description VD
 Vertical outlet roof fan with efficiency-optimised aluminium casing and newly developed high-performance centrifugal impeller.

Description VD T120
 Designed for the delivery of process air up to +120 °C. Enclosed motor located outside of the air flow. Compliant with VDI 2052.

Description of all series

Casing
 Casing made of sea water-resistant aluminium with integrated tamper protection. Motor support plate and base plate with inlet nozzle made of galvanised steel (explosion-proof version inlet nozzle made of aluminium). Base plate with threaded screws for attachment of inlet-side accessories (hole pattern according to DIN 24155).

* Accessories VD T120 see installation accessories p. 551 f. Other accessories upon request.

Performance curves RDW 355/4

Frequency	Hz	Tot.	125	250	500	1k	2k	4k	8k	
L _{WA} Inlet side		dB(A)	66	56	61	60	58	56	53	48
L _{WA} Outlet side		dB(A)	72	63	66	66	62	53	47	

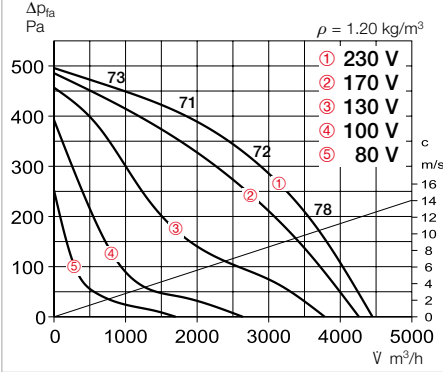

Performance curves RDD 355/4

Frequency	Hz	Tot.	125	250	500	1k	2k	4k	8k	
L _{WA} Inlet side		dB(A)	66	56	61	60	58	56	53	48
L _{WA} Outlet side		dB(A)	72	63	66	66	62	53	47	

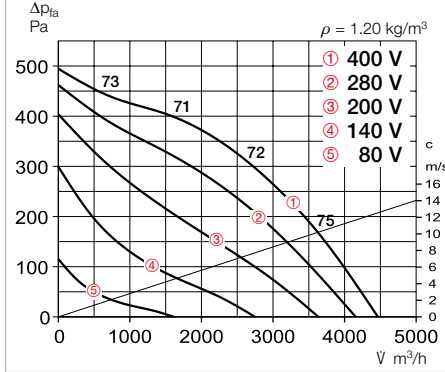

Type	Ref. no.	Speed	Flow rate Free blowing	Noise sound pressure	Power consump.	Current consump.		Wiring diagram	Max. air flow temp.		Weight net	Motor protection circuit breaker		Speed controller 5-step	
						at rated voltage	with control		at rated voltage	with control		Type	Ref. no.	Type	Ref. no.
		min ⁻¹	m ³ /h	dB(A) in 4 m	W	A	A	No.	°C	°C	kg	Type	Ref. no.	Type	Ref. no.
Single phase alternating current, 1~, 230 V, 50 Hz, Capacitor motor, protection category IP54															
RDW 355/4	07323	1400	4480	55	520	2.55	3.4	1128	70	55	27.0	MW	01579	MWS 5 ²⁾	01949
Three phase current, 3~, 400 V, 50 Hz, Squirrel-cage rotor, Protection category IP54															
RDD 355/4	07326	1350	4470	55	460	0.92	1.0	1129	60	60	25.0	MD	05849	RDS 2 ²⁾	01315
Ex Ex Explosion-proof, II 2G Ex h IIB + H₂ T3 Gb, Motor Ex e, Three phase current, 3~, 400 V, 50 Hz, Protection category IP44															
RDD 355/4 Ex ¹⁾	07329	1345	4345	58	540	1.21	1.21	1157	40	40	25.0	MSA	01289	TSD 3	01502

1) Performance diagram at www.HeliosSelect.de.

2) Includes motor protection circuit breaker.

Performance curves VDW 355/4

Frequency	Hz	Tot.	125	250	500	1k	2k	4k	8k	
L _{WA} Inlet side		dB(A)	66	56	61	60	58	56	53	48
L _{WA} Outlet side		dB(A)	71	61	65	65	62	53	49	

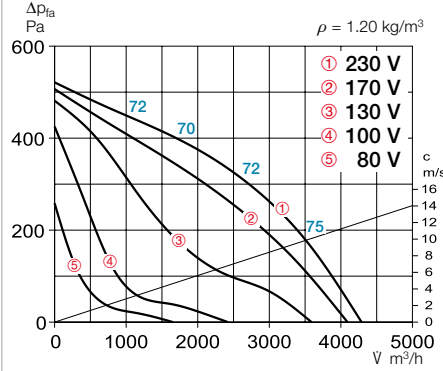

Performance curves VDD 355/4

Frequency	Hz	Tot.	125	250	500	1k	2k	4k	8k	
L _{WA} Inlet side		dB(A)	66	56	61	60	58	56	53	48
L _{WA} Outlet side		dB(A)	71	61	64	64	60	52	46	

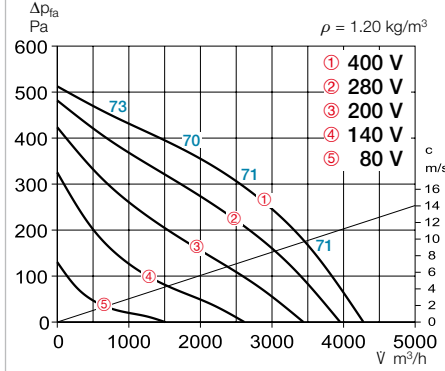

Type	Ref. no.	Speed	Flow rate Free blowing	Noise sound pressure	Power consump.	Current consump.		Wiring diagram	Max. air flow temp.		Weight net	Motor protection circuit breaker		Speed controller 5-step	
						at rated voltage	with control		at rated voltage	with control		Type	Ref. no.	Type	Ref. no.
		min ⁻¹	m ³ /h	dB(A) in 4 m	W	A	A	No.	°C	°C	kg	Type	Ref. no.	Type	Ref. no.
Single phase alternating current, 1~, 230 V, 50 Hz, Capacitor motor, protection category IP54															
VDW 355/4	07317	1400	4300	54	520	2.55	3.4	1128	60	55	27.0	MW	01579	MWS 5 ²⁾	01949
Three phase current, 3~, 400 V, 50 Hz, Squirrel-cage rotor, Protection category IP54															
VDD 355/4	07318	1350	4290	54	460	0.92	1.0	1129	60	60	25.5	MD	05849	RDS 2 ²⁾	01315
Ex Ex Explosion-proof, II 2G Ex h IIB + H₂ T3 Gb, Motor Ex e, Three phase current, 3~, 400 V, 50 Hz, Protection category IP44															
VDD 355/4 Ex ¹⁾	07327	1350	4320	57	520	1.17	1.17	1157	40	40	25.5	MSA	01289	TSD 3	01502
T120 Three phase current, 3~, 400 V, 50 Hz, Squirrel-cage rotor, Protection category IP54															
VDD 355/4 T120 ¹⁾	07336	1400	4597	58	584	1.3	1.4	1264	120	100	34.0	MD	05849	RDS 4 ²⁾	01316

1) Performance diagram at www.HeliosSelect.de.

2) Includes motor protection circuit breaker.



Impeller
 High-performance centrifugal impeller with backward curved blades made of plastic (T120 and explosion-proof version made of aluminium). Dynamically balanced according to DIN ISO 21940-11 – quality grade 6.3.

Drive
 Speed-controllable external rotor motor in closed design (IP54) (explosion-proof version in IP44). Flange motor with self-ventilation (T120 version) in IP54. Ball bearing mounted with moisture protection. Maintenance-free and radio interference-free.

Motor protection
 Through built-in thermal contacts or built-in PTC thermistors, which must be connected to a motor protection circuit breaker. Assignment see type table.

Electrical connection
 No dismantling of casing, to external isolator switch (explosion-proof version to terminal box) in protection category IP65.

Protection grille
 On the outlet side as standard according to DIN EN ISO 13857.

Power control

All 1~ types have continuously variable speed control in the range from 0 – 100 % through electronic speed controllers or five-step control units. All 3~ types have continuously variable speed control in the range 0 – 100 % with a frequency inverter with integrated, all-pole effective sine filter (except for explosion-proof version) or five-step control units. Assignment see type table.

Delivery
 Units are ready-for-connection, fully pre-assembled in the shipping box.

Noise
 The total level and range are specified above the performance diagram for:

- Inlet side sound power
 - Outlet side sound power.
- The horizontally case-radiated noise as sound pressure at 4 m (free field conditions) is also specified in the type table. Hood silencer see Accessories.

References	Page
Planning information	10 ff.
Technical description	492 f.
Selection table	494 f.
Accessories, details	550 f.
Speed controllers, controllers and switches	591 ff.

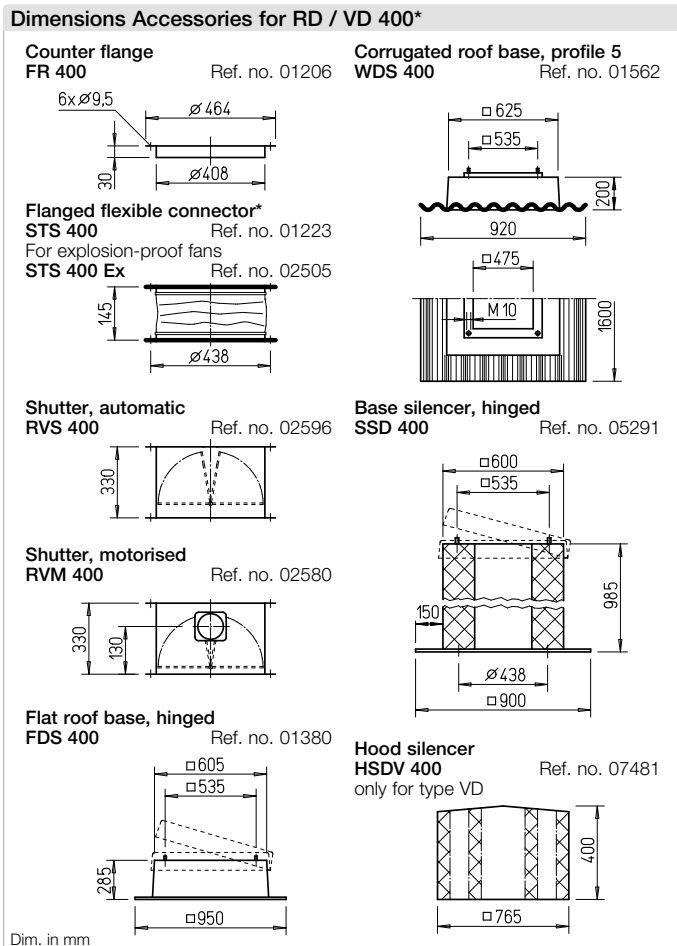
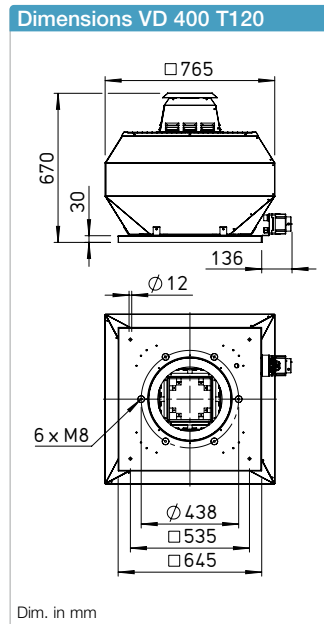
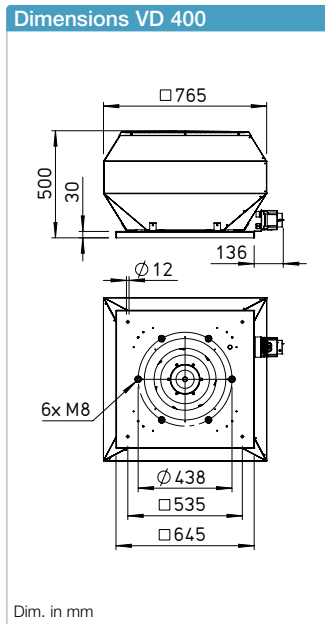
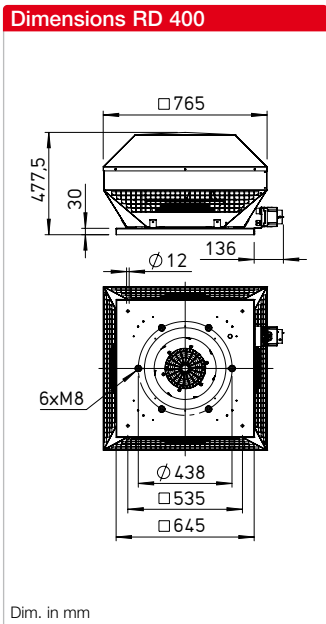

Description RD
 Horizontal outlet roof fan with efficiency-optimised aluminium casing and newly developed high-performance centrifugal impeller.

Description VD
 Vertical outlet roof fan with efficiency-optimised aluminium casing and newly developed high-performance centrifugal impeller.

Description VD T120
 Designed for the delivery of process air up to +120 °C. Enclosed motor located outside of the air flow. Compliant with VDI 2052.

Description of all series

Casing
 Casing made of sea water-resistant aluminium with integrated tamper protection. Motor support plate and base plate with inlet nozzle made of galvanised steel (explosion-proof version inlet nozzle made of aluminium). Base plate with threaded screws for attachment of inlet-side accessories (hole pattern according to DIN 24155).

* Accessories VD T120 see installation accessories p. 551 f. Other accessories upon request.

Performance curves RDW 400/4

Frequency	Hz	Tot.	125	250	500	1k	2k	4k	8k
L _{WA} Inlet side	dB(A)	71	61	65	66	63	62	56	52
L _{WA} Outlet side	dB(A)	76	55	62	62	60	60	50	39

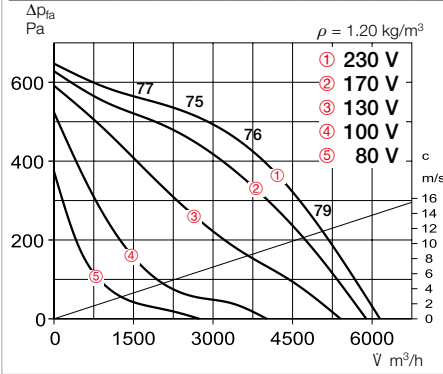

Performance curves RDD 400/4

Frequency	Hz	Tot.	125	250	500	1k	2k	4k	8k
L _{WA} Inlet side	dB(A)	70	60	64	65	62	61	55	51
L _{WA} Outlet side	dB(A)	75	55	62	62	62	59	50	39

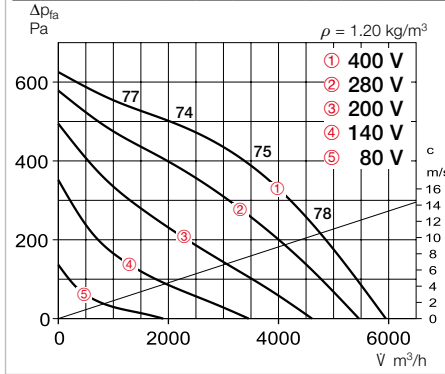

Performance curves RDD 400/6

Frequency	Hz	Tot.	125	250	500	1k	2k	4k	8k
L _{WA} Inlet side	dB(A)	61	51	55	56	53	52	46	42
L _{WA} Outlet side	dB(A)	66	55	62	62	62	59	50	39

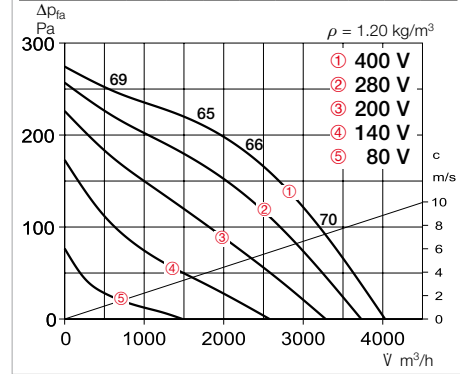

Type	Ref. no.	Speed	Flow rate Free blowing	Noise sound pressure	Power consump.	Current consump.		Wiring diagram	Max. air flow temp.		Weight net	Motor protection circuit breaker		Speed controller 5-step	
						at rated voltage	with control		at rated voltage	with control		Type	Ref. no.	Type	Ref. no.
		min ⁻¹	m ³ /h	dB(A) in 4 m	W	A	A	No.	°C	°C	kg	Type	Ref. no.	Type	Ref. no.
Single phase alternating current, 1~, 230 V, 50 Hz, Capacitor motor, protection category IP54															
RDW 400/4	07350	1405	6150	59	875	4.3	6.0	1128	60	40	33.0	MW	01579	MWS 7.5 ²⁾	01950
Three phase current, 3~, 400 V, 50 Hz, Squirrel-cage rotor, Protection category IP54															
RDD 400/6	07352	905	4030	49	260	0.6	0.6	1129	60	60	27.0	MD	05849	RDS 1 ²⁾	01314
RDD 400/4	07351	1375	5970	58	765	1.55	1.6	1129	60	55	27.0	MD	05849	RDS 2 ²⁾	01315
Ex Ex Explosion-proof, II 2G Ex h IIB + H₂ T3 Gb, Motor Ex e, Three phase current, 3~, 400 V, 50 Hz, Protection category IP44															
RDD 400/6 Ex ¹⁾	07363	930	3840	52	330	0.86	0.86	1157	40	40	24.0	MSA	01289	TSD 1.5	01501
RDD 400/4 Ex ¹⁾	07358	1395	6030	62.5	950	1.9	2.1	1157	40	40	33.0	MSA	01289	TSD 3.0	01502

1) Performance diagram at www.HeliosSelect.de.

2) Includes motor protection circuit breaker.

Performance curves VDW 400/4

Frequency	Hz	Tot.	125	250	500	1k	2k	4k	8k
L _{WA} Inlet side	dB(A)	71	61	65	66	63	62	56	52
L _{WA} Outlet side	dB(A)	76	63	71	70	70	66	60	54

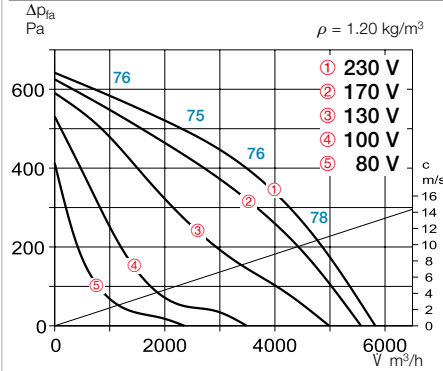

Performance curves VDD 400/4

Frequency	Hz	Tot.	125	250	500	1k	2k	4k	8k
L _{WA} Inlet side	dB(A)	69	59	63	64	61	60	54	50
L _{WA} Outlet side	dB(A)	74	61	69	68	68	64	58	52

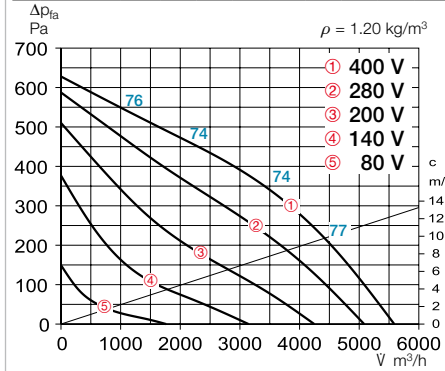

Performance curves VDD 400/6

Frequency	Hz	Tot.	125	250	500	1k	2k	4k	8k
L _{WA} Inlet side	dB(A)	61	51	55	56	53	52	46	42
L _{WA} Outlet side	dB(A)	66	53	61	60	60	56	50	44

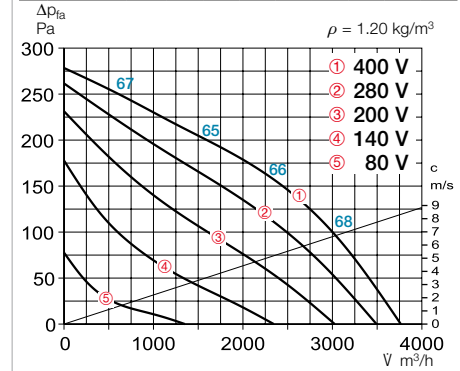

Type	Ref. no.	Speed	Flow rate Free blowing	Noise sound pressure	Power consump.	Current consump.		Wiring diagram	Max. air flow temp.		Weight net	Motor protection circuit breaker		Speed controller 5-step	
						at rated voltage	with control		at rated voltage	with control		Type	Ref. no.	Type	Ref. no.
		min ⁻¹	m ³ /h	dB(A) in 4 m	W	A	A	No.	°C	°C	kg	Type	Ref. no.	Type	Ref. no.
Single phase alternating current, 1~, 230 V, 50 Hz, Capacitor motor, protection category IP54															
VDW 400/4	07338	1405	5830	59	875	4.3	6.0	1128	60	40	33.0	MW	01579	MWS 7.5 ²⁾	01950
Three phase current, 3~, 400 V, 50 Hz, Squirrel-cage rotor, Protection category IP54															
VDD 400/6	07343	905	3780	49	260	0.6	0.6	1129	60	60	28.0	MD	05849	RDS 1 ²⁾	01314
VDD 400/4	07342	1375	5590	57	765	1.55	1.6	1129	60	55	29.5	MD	05849	RDS 2 ²⁾	01315
Ex Ex Explosion-proof, II 2G Ex h IIB + H₂ T3 Gb, Motor Ex e, Three phase current, 3~, 400 V, 50 Hz, Protection category IP44															
VDD 400/6 Ex ¹⁾	07359	930	3630	51.5	320	0.89	0.89	1157	40	40	25.0	MSA	01289	TSD 1.5	01501
VDD 400/4 Ex ¹⁾	07353	1375	5350	57	1000	2.1	2.2	1129	40	40	29.5	MSA	01289	TSD 3	01502
T120 Three phase current, 3~, 400 V, 50 Hz, Squirrel-cage rotor, Protection category IP54															
VDD 400/6 T120 ¹⁾	07366	967	4535	54	353	0.88	1.02	1264	120	100	36.0	MD	05849	TSD 1.5	01501
VDD 400/4 T120 ¹⁾	07370	1400	6824	62	1045	4.2	2.28	1264	120	100	36.0	MD	05849	TSD 5.5	01503

1) Performance diagram at www.HeliosSelect.de.

2) Includes motor protection circuit breaker.



Impeller
 High-performance centrifugal impeller with backward curved blades made of plastic (T120 and explosion-proof version made of aluminium). Dynamically balanced according to DIN ISO 21940-11 – quality grade 6.3.

Drive
 Speed-controllable external rotor motor in closed design (IP54) (explosion-proof version in IP44). Flange motor with self-ventilation (T120 version) in IP54. Ball bearing mounted with moisture protection. Maintenance-free and radio interference-free.

Motor protection
 Through built-in thermal contacts or built-in PTC thermistors, which must be connected to a motor protection circuit breaker. Assignment see type table.

Electrical connection
 No dismantling of casing, to external isolator switch (explosion-proof version to terminal box) in protection category IP65.

Protection grille
 On the outlet side as standard according to DIN EN ISO 13857.

Power control

All 1~ types have continuously variable speed control in the range from 0 – 100 % through electronic speed controllers or five-step control units. All 3~ types have continuously variable speed control in the range 0 – 100 % with a frequency inverter with integrated, all-pole effective sine filter (except for explosion-proof version) or five-step control units. Assignment see type table.

Delivery
 Units are ready-for-connection, fully pre-assembled in the shipping box. Easy positioning due to standard crane hook.

Noise
 The total level and range are specified above the performance diagram for:

- Inlet side sound power
- Outlet side sound power.

The horizontally case-radiated noise as sound pressure at 4 m (free field conditions) is also specified in the type table. Hood silencer see Accessories.

References	Page
Planning information	10 ff.
Technical description	492 f.
Selection table	494 f.
Accessories, details	550 f.
Speed controllers, controllers and switches	591 ff.

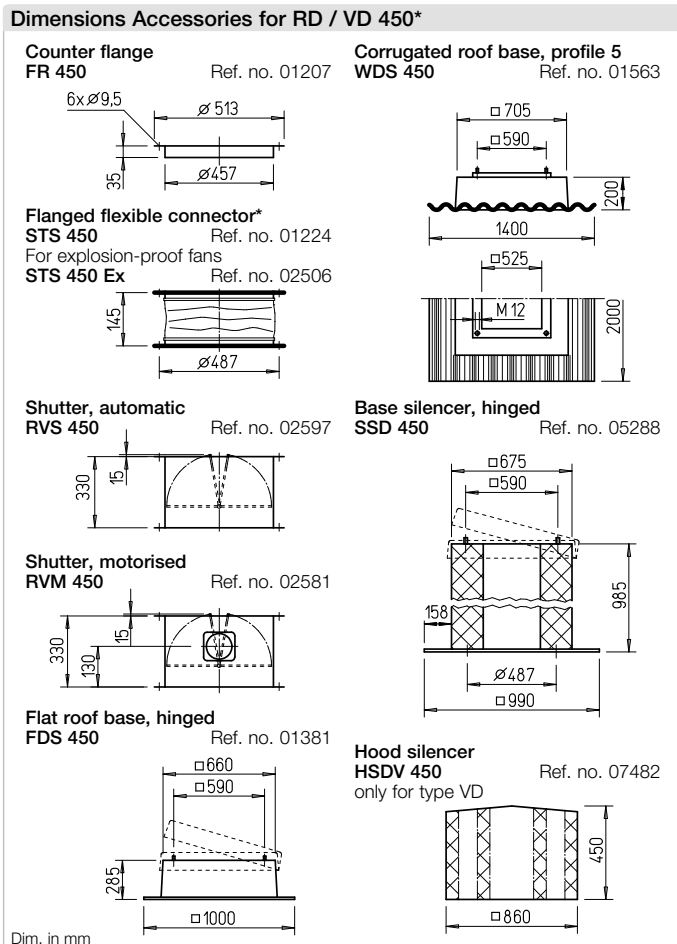
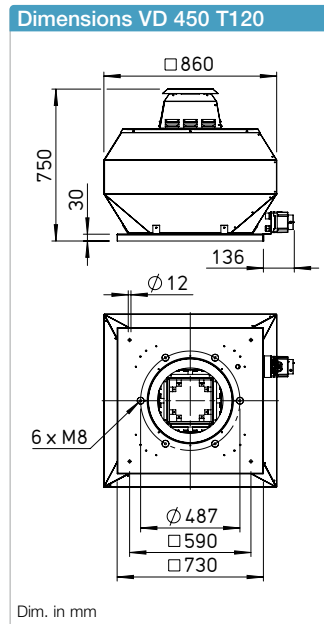
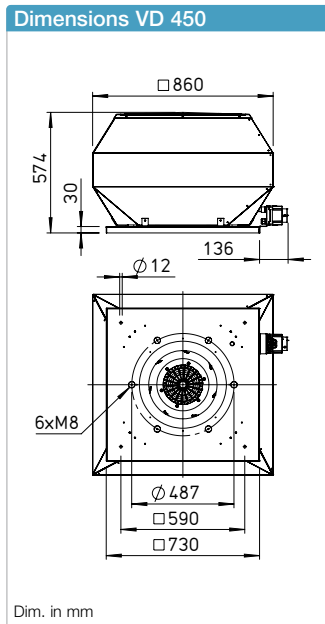
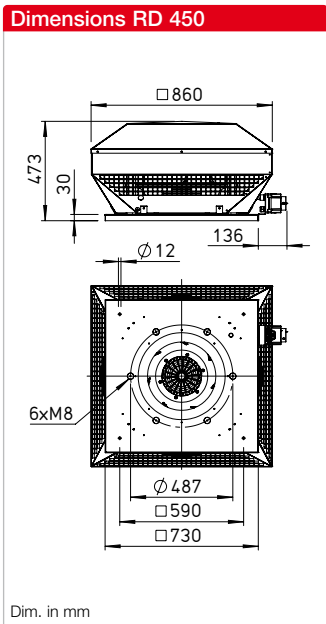

Description RD
 Horizontal outlet roof fan with efficiency-optimised aluminium casing and newly developed high-performance centrifugal impeller.

Description VD
 Vertical outlet roof fan with efficiency-optimised aluminium casing and newly developed high-performance centrifugal impeller.

Description VD T120
 Designed for the delivery of process air up to +120 °C. Enclosed motor located outside of the air flow. Compliant with VDI 2052.

Description of all series

Casing
 Casing made of sea water-resistant aluminium with integrated tamper protection. Motor support plate and base plate with inlet nozzle made of galvanised steel (explosion-proof version inlet nozzle made of aluminium). Base plate with threaded screws for attachment of inlet-side accessories (hole pattern according to DIN 24155).

* Accessories VD T120 see installation accessories p. 551 f. Other accessories upon request.

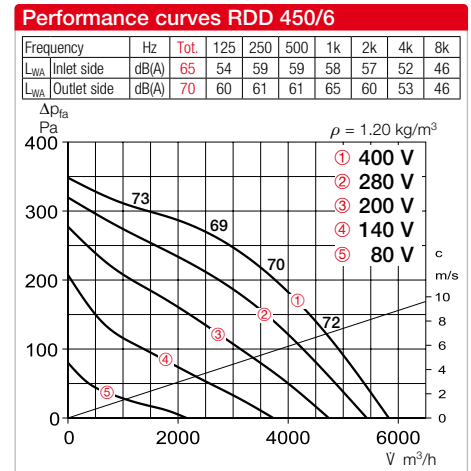
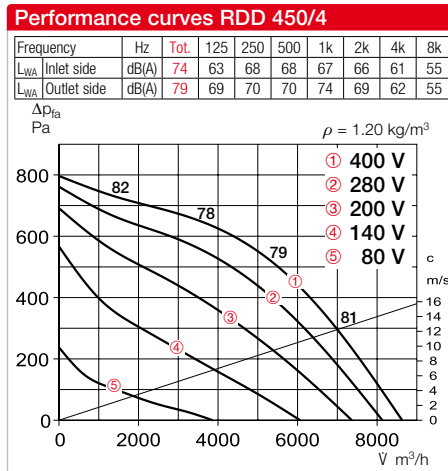
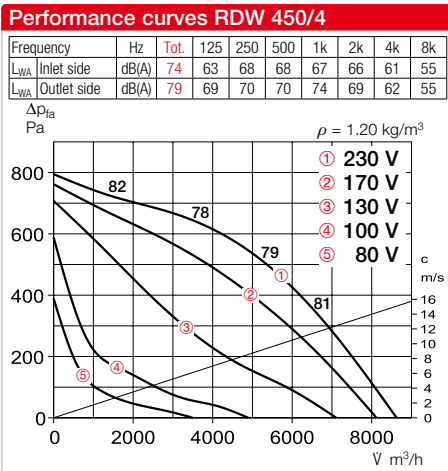

Type	Ref. no.	Speed	Flow rate Free blowing	Noise sound pressure	Power consump.	Current consump.		Wiring diagram	Max. air flow temp.		Weight net	Motor protection circuit breaker		Speed controller 5-step	
						at rated voltage	with control		at rated voltage	with control		Type	Ref. no.	Type	Ref. no.
		min ⁻¹	m ³ /h	dB(A) in 4 m	W	A	A	No.	°C	°C	kg	Type	Ref. no.	Type	Ref. no.
Single phase alternating current, 1~, 230 V, 50 Hz, Capacitor motor, protection category IP54															
RDW 450/4	07377	1385	8650	62	1470	6.6	8.7	1128	60	40	46.0	MW	01579	MWS 10 ²⁾	01946
Three phase current, 3~, 400 V, 50 Hz, Squirrel-cage rotor, Protection category IP54															
RDD 450/6	07385	905	5850	53	425	1.1	1.1	1129	60	60	39.0	MD	05849	RDS 2 ²⁾	01315
RDD 450/4	07384	1400	8650	62	1350	2.9	2.9	1129	60	60	45.0	MD	05849	RDS 4 ²⁾	01316
Ex Ex Explosion-proof, II 2G Ex h IIB + H₂ T3 Gb, Motor Ex e, Three phase current, 3~, 400 V, 50 Hz, Protection category IP44															
RDD 450/6 Ex ¹⁾	07391	870	5630	54.5	470	1.13	1.13	1129	60	60	39.0	MSA	01289	TSD 1.5	01501
RDD 450/4 Ex ¹⁾	07390	1405	8580	64.5	1620	3.3	3.66	1157	40	40	46.0	MSA	01289	TSD 5.5	01503

1) Performance diagram at www.HeliosSelect.de.

2) Includes motor protection circuit breaker.

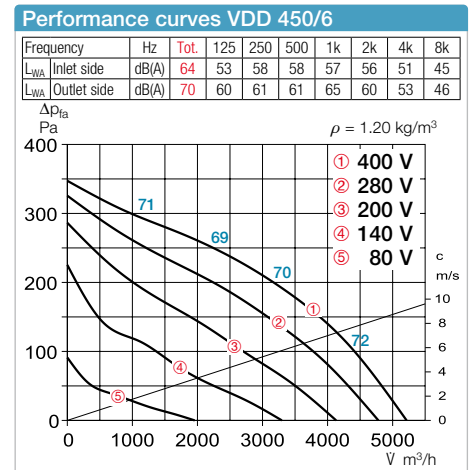
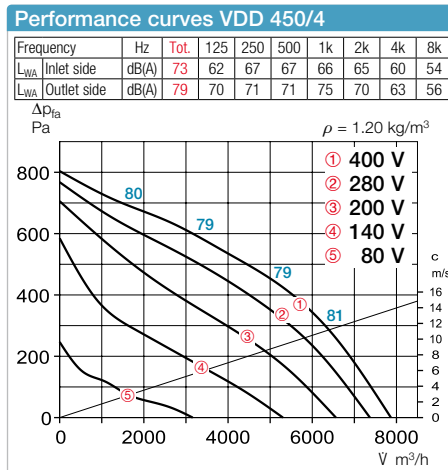
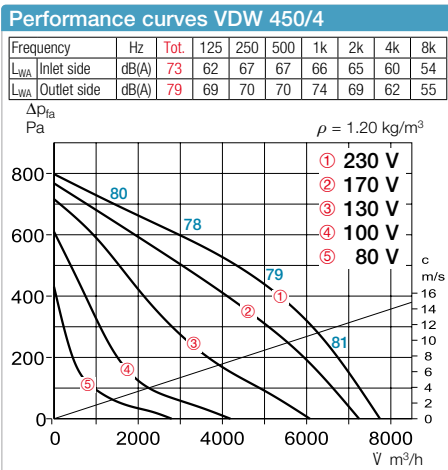

Type	Ref. no.	Speed	Flow rate Free blowing	Noise sound pressure	Power consump.	Current consump.		Wiring diagram	Max. air flow temp.		Weight net	Motor protection circuit breaker		Speed controller 5-step	
						at rated voltage	with control		at rated voltage	with control		Type	Ref. no.	Type	Ref. no.
		min ⁻¹	m ³ /h	dB(A) in 4 m	W	A	A	No.	°C	°C	kg	Type	Ref. no.	Type	Ref. no.
Single phase alternating current, 1~, 230 V, 50 Hz, Capacitor motor, protection category IP54															
VDW 450/4	07372	1385	7750	62	1470	6.6	8.7	1128	60	40	47.0	MW	01579	MWS 10 ²⁾	01946
Three phase current, 3~, 400 V, 50 Hz, Squirrel-cage rotor, Protection category IP54															
VDD 450/6	07380	905	5200	53	425	1.06	1.06	1129	60	60	40.0	MD	05849	RDS 2 ²⁾	01315
VDD 450/4	07379	1400	7900	62	1350	2.9	2.9	1129	60	60	47.0	MD	05849	RDS 4 ²⁾	01316
Ex Ex Explosion-proof, II 2G Ex h IIB + H₂ T3 Gb, Motor Ex e, Three phase current, 3~, 400 V, 50 Hz, Protection category IP44															
VDD 450/6 Ex ¹⁾	07387	875	5170	54	460	1.1	1.1	1157	40	40	40.0	MSA	01289	TSD 1.5	01501
VDD 450/4 Ex ¹⁾	07386	1405	7930	65	1570	3.3	3.66	1157	40	40	47.0	MSA	01289	TSD 5.5	01503
T120 Three phase current, 3~, 400 V, 50 Hz, Squirrel-cage rotor, Protection category IP54															
VDD 450/6 T120 ¹⁾	07399	940	6515	62	660	2.05	2.05	1264	90	—	54.0	MD	05849	RDS 4 ²⁾	01316
VDD 450/4 T120 ¹⁾	07398	1355	9792	69	1830	3.8	3.8	1264	80	—	60.0	MD	05849	RDS 7 ²⁾	01578

1) Performance diagram at www.HeliosSelect.de.

2) Includes motor protection circuit breaker.



Impeller
 High-performance centrifugal impeller with backward curved blades made of plastic (T120 and explosion-proof version made of aluminium). Dynamically balanced according to DIN ISO 21940-11 – quality grade 6.3.

Drive
 Speed-controllable external rotor motor in closed design (IP54) (explosion-proof version in IP44). Flange motor with self-ventilation (T120 version) in IP54/55. Ball bearing mounted with moisture protection. Maintenance-free and radio interference-free.

Motor protection
 Through built-in thermal contacts or built-in PTC thermistors, which must be connected to a motor protection circuit breaker. Assignment see type table.

Electrical connection
 No dismantling of casing, to external isolator switch (explosion-proof version to terminal box) in protection category IP65.

Protection grille
 On the outlet side as standard according to DIN EN ISO 13857.

Power control
 All types have continuously variable speed control in the range from 0 – 100 % with a frequency inverter with integrated, all-pole effective sine filter (except for explosion-proof version) or five-step control units (except for units with FU). Assignment see type table.

Delivery
 Units are ready-for-connection, fully pre-assembled in the shipping box. Easy positioning due to standard crane hook.

Noise
 The total level and range are specified above the performance diagram for:

- Inlet side sound power
- Outlet side sound power.

The horizontally case-radiated noise as sound pressure at 4 m (free field conditions) is also specified in the type table. Hood silencer see Accessories.

References	Page
Planning information	10 ff.
Technical description	492 f.
Selection table	494 f.
Accessories, details	550 f.
Speed controllers, controllers and switches	591 ff.

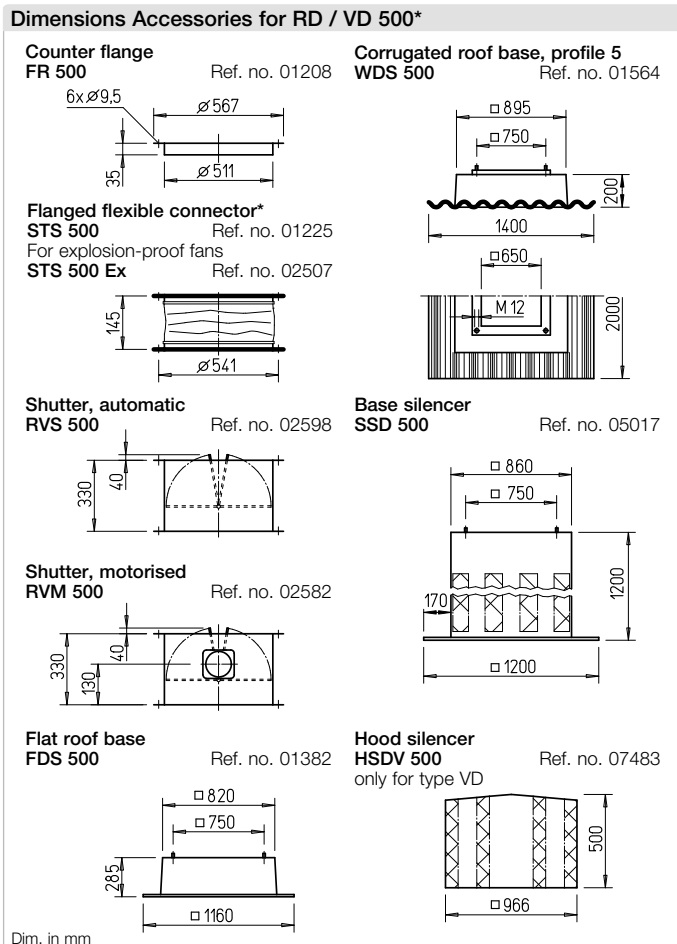
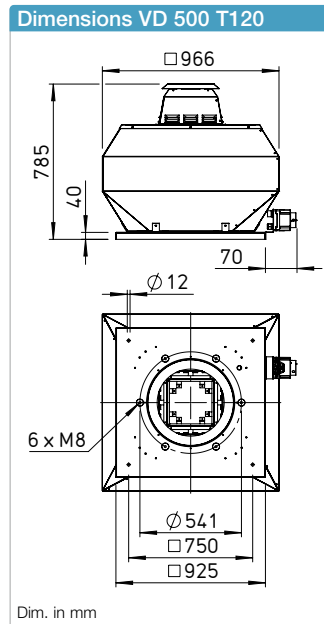
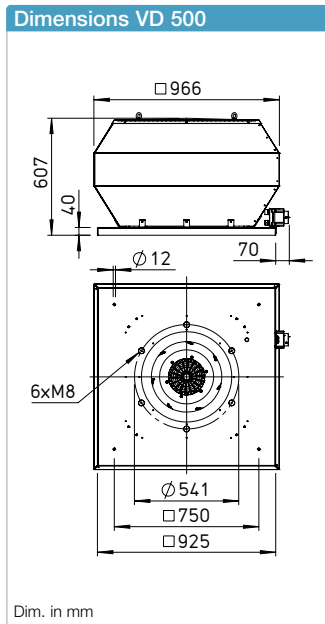
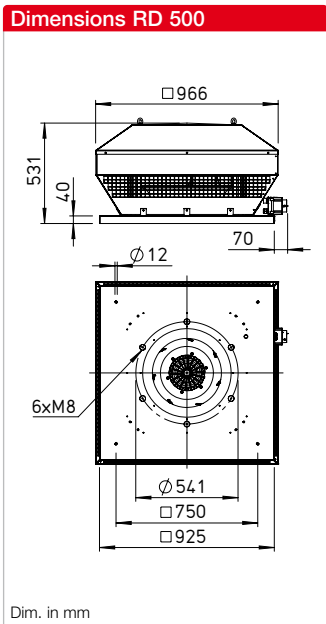

Description RD
 Horizontal outlet roof fan with efficiency-optimised aluminium casing and newly developed high-performance centrifugal impeller.

Description VD
 Vertical outlet roof fan with efficiency-optimised aluminium casing and newly developed high-performance centrifugal impeller.

Description VD T120
 Designed for the delivery of process air up to +120 °C. Enclosed motor located outside of the air flow. Compliant with VDI 2052.

Description of all series

Casing
 Casing made of sea water-resistant aluminium with integrated tamper protection. Motor support plate and base plate with inlet nozzle made of galvanised steel (explosion-proof version inlet nozzle made of aluminium). Base plate with threaded screws for attachment of inlet-side accessories (hole pattern according to DIN 24155).

* Accessories VD T120 see installation accessories p. 551 f. Other accessories upon request.

Performance curves RDD 500/4

Frequency	Hz	Tot.	125	250	500	1k	2k	4k	8k
L _{WA} Inlet side	dB(A)	76	67	71	69	66	62	58	
L _{WA} Outlet side	dB(A)	81	72	74	75	76	70	65	58

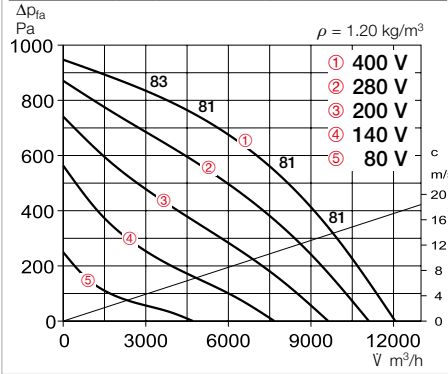

Performance curves RDD 500/6

Frequency	Hz	Tot.	125	250	500	1k	2k	4k	8k
L _{WA} Inlet side	dB(A)	67	58	62	60	60	57	53	49
L _{WA} Outlet side	dB(A)	72	63	65	66	67	61	56	49

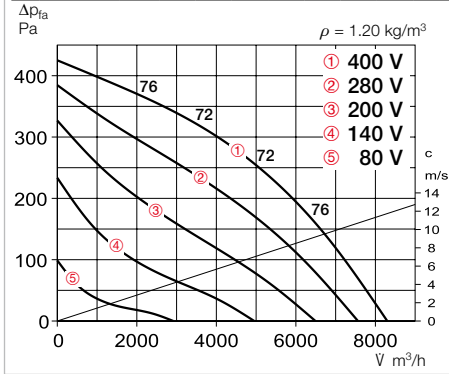

Type	Ref. no.	Speed	Flow rate Free blowing	Noise sound pressure	Power consump.	Current consump.		Wiring diagram	Max. air flow temp.		Weight net	Motor protection circuit breaker		Speed controller 5-step	
						at rated voltage	with control		at rated voltage	with control		Type	Ref. no.	Type	Ref. no.
Three phase current, 3~, 400 V, 50 Hz, Squirrel-cage rotor, Protection category IP54															
RDD 500/6	07410	885	8300	55	680	1.55	1.55	1129	50	50	55.0	MD	05849	RDS 2 ²⁾	01315
RDD 500/4	07409	1340	12100	64	2150	4.15	4.25	1129	55	50	58.0	MD	05849	RDS 7 ²⁾	01578
Ex Explosion-proof, II 2G Ex h IIB + Hz T3 Gb, Motor Ex e, Three phase current, 3~, 400 V, 50 Hz, Protection category IP44															
RDD 500/6 Ex ¹⁾	07414	840	6550	57.5	570	1.21	1.21	1157	40	40	51.0	MSA	01289	TSD 1.5	01501
RDD 500/4 Ex ¹⁾	07416	1420	13030	64	2250	4.5	5.8	—	40	40	58.0	MSA	01289	TSD 1.5	01501

1) Performance diagram at www.HeliosSelect.de.

2) Includes motor protection circuit breaker.

Performance curves VDD 500/4

Frequency	Hz	Tot.	125	250	500	1k	2k	4k	8k
L _{WA} Inlet side	dB(A)	76	67	71	69	66	62	58	
L _{WA} Outlet side	dB(A)	82	71	75	76	76	74	69	61

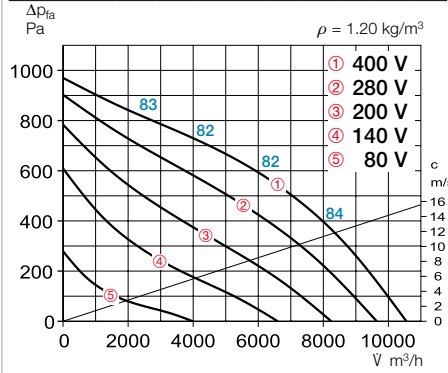

Performance curves VDD 500/6

Frequency	Hz	Tot.	125	250	500	1k	2k	4k	8k
L _{WA} Inlet side	dB(A)	67	58	62	60	60	57	53	49
L _{WA} Outlet side	dB(A)	73	62	66	67	67	65	60	52

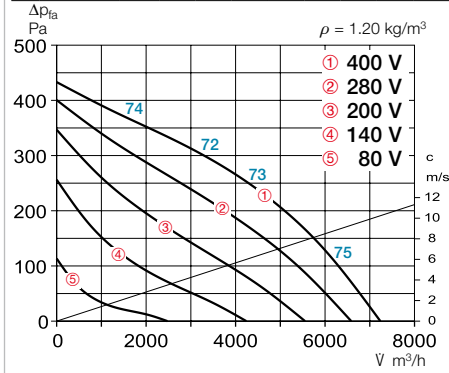

Type	Ref. no.	Speed	Flow rate Free blowing	Noise sound pressure	Power consump.	Current consump.		Wiring diagram	Max. air flow temp.		Weight net	Motor protection circuit breaker		Speed controller 5-step	
						at rated voltage	with control		at rated voltage	with control		Type	Ref. no.	Type	Ref. no.
Three phase current, 3~, 400 V, 50 Hz, Squirrel-cage rotor, Protection category IP54															
VDD 500/6	07402	885	7250	56	680	1.55	1.55	1129	50	50	56.0	MD	05849	RDS 2 ²⁾	01315
VDD 500/4	07401	1340	10550	65	2150	4.15	4.25	1129	55	50	65.0	MD	05849	RDS 7 ²⁾	01578
Ex Explosion-proof, II 2G Ex h IIB + Hz T3 Gb, Motor Ex e, Three phase current, 3~, 400 V, 50 Hz, Protection category IP44															
VDD 500/6 Ex ¹⁾	07412	840	5850	56	560	1.2	1.2	1157	40	40	53.0	MSA	01289	TSD 1.5	01501
VDD 500/4 Ex ¹⁾	07413	1405	9350	66.5	2250	4.3	5.1	1157	40	40	68.0	MSA	01289	TSD 7	01504
T120 Three phase current, 3~, 400 V, 50 Hz, Squirrel-cage rotor, Protection category IP54 or IP55*															
VDD 500/6 T120 ¹⁾	07419	945	9568	61	100	2.1	2.1	1264	100	—	62.0	MSA	01289	TSD 7	01504
VDD 500/4 T120 ¹⁾	07418	1465	14078	70	3060	5.8	5.8	1130	95	—	71.0	MSA	01289	—	—

1) Performance diagram at www.HeliosSelect.de.

2) Includes motor protection circuit breaker.



Impeller
 High-performance centrifugal impeller with backward curved blades made of aluminium. Dynamically balanced according to DIN ISO 21940-11 – quality grade 6.3.

Drive
 Speed-controllable external rotor motor in closed design (IP54) (explosion-proof version in IP44). Flange motor with self-ventilation (T120 version) in IP54/55. Ball bearing mounted with moisture-free and radio interference-free.

Motor protection
 Through built-in thermal contacts or built-in PTC thermistors, which must be connected to a motor protection circuit breaker. Assignment see type table.

Electrical connection
 No dismantling of casing, to external isolator switch (explosion-proof version to terminal box) in protection category IP65.

Protection grille
 On the outlet side as standard according to DIN EN ISO 13857.

Power control
 All types have continuously variable speed control in the range from 0 – 100 % with a frequency inverter with integrated, all-pole effective sine filter (except for explosion-proof version) or five-step control units (except for units with FU). Assignment see type table.

Delivery
 Units are ready-for-connection, fully pre-assembled in the shipping box. Easy positioning due to standard crane hook.

Noise
 The total level and range are specified above the performance diagram for:

- Inlet side sound power
 - Outlet side sound power.
- The horizontally case-radiated noise as sound pressure at 4 m (free field conditions) is also specified in the type table. Hood silencer see Accessories.

References	Page
Planning information	10 ff.
Technical description	492 f.
Selection table	494 f.
Accessories, details	550 f.
Speed controllers, controllers and switches	591 ff.

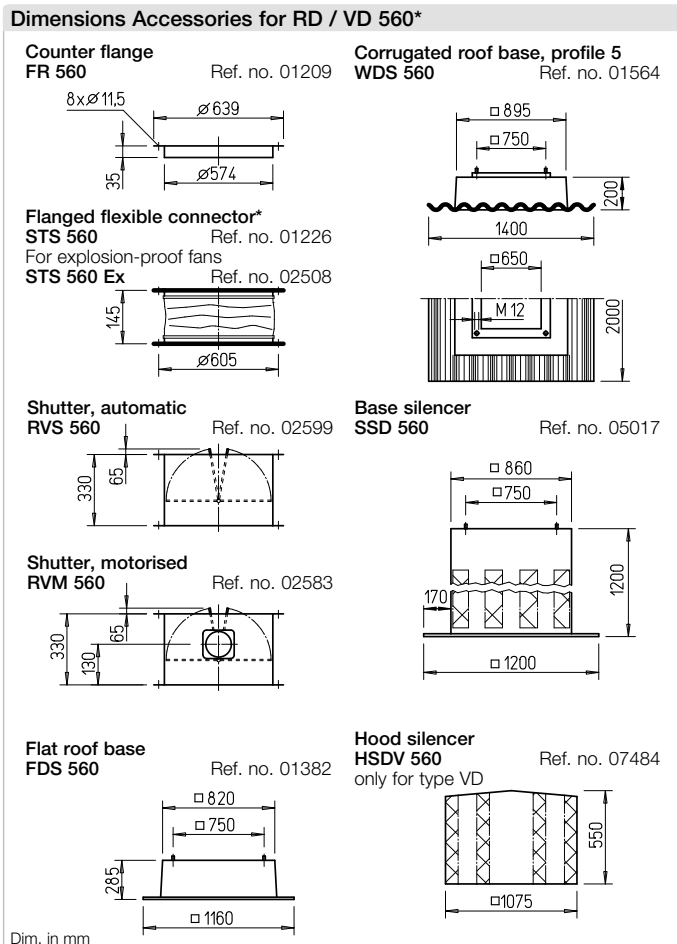
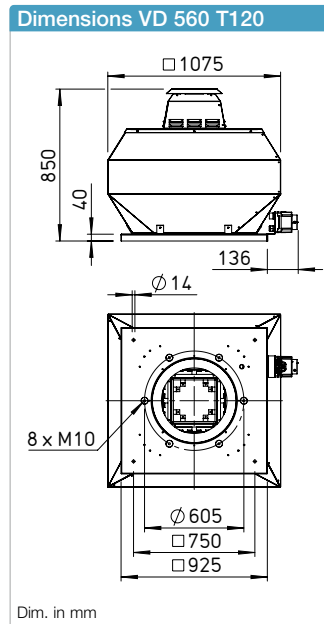
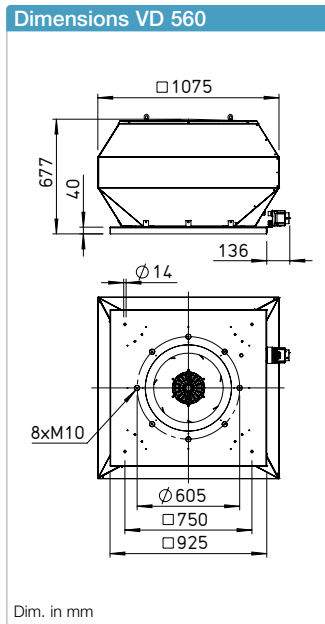
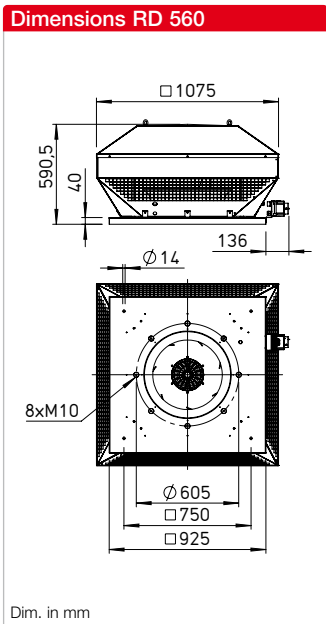

Description RD
 Horizontal outlet roof fan with efficiency-optimised aluminium casing and newly developed high-performance centrifugal impeller.

Description VD
 Vertical outlet roof fan with efficiency-optimised aluminium casing and newly developed high-performance centrifugal impeller.

Description VD T120
 Designed for the delivery of process air up to +120 °C. Enclosed motor located outside of the air flow. Compliant with VDI 2052.

Description of all series

Casing
 Casing made of sea water-resistant aluminium with integrated tamper protection. Motor support plate and base plate with inlet nozzle made of galvanised steel (explosion-proof version inlet nozzle made of aluminium). Base plate with threaded screws for attachment of inlet-side accessories (hole pattern according to DIN 24155).

* Accessories VD T120 see installation accessories p. 551 f. Other accessories upon request.

Performance curve RDD 560/4

Frequency	Hz	Tot.	125	250	500	1k	2k	4k	8k
L _{WA} Inlet side	dB(A)	81	70	72	73	74	73	69	62
L _{WA} Outlet side	dB(A)	86	74	77	79	80	77	70	61

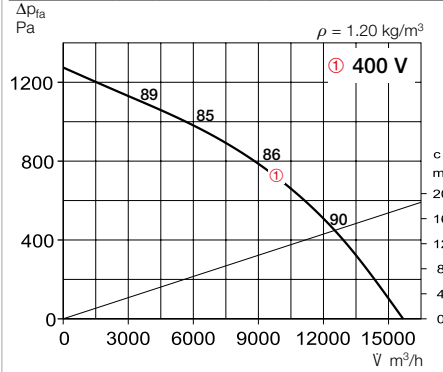

Performance curves RDD 560/6

Frequency	Hz	Tot.	125	250	500	1k	2k	4k	8k
L _{WA} Inlet side	dB(A)	72	62	64	65	66	65	61	54
L _{WA} Outlet side	dB(A)	77	66	69	71	72	69	62	53

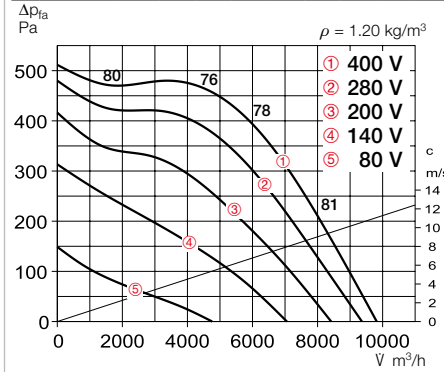

Type	Ref. no.	Speed	Flow rate Free blowing	Noise sound pressure	Power consump.	Current consump.		Wiring diagram	Max. air flow temp.		Weight net	Motor protection circuit breaker		Speed controller 5-step	
						at rated voltage	with control		at rated voltage	with control		Type	Ref. no.	Type	Ref. no.
Three phase current, 3~, 400 V, 50 Hz, Squirrel-cage rotor, Protection category IP54															
RDD 560/6	07429	920	9850	60	1180	3.2	3.2	1129	60	60	72.0	MD	05849	RDS 7 ²⁾	01578
RDD 560/4	07426	1380	15700	69	3610	6.4	7.8	1130	60	40	88.0	MD	05849	RDS 11 ²⁾	01332
Ex Explosion-proof, II 2G Ex h IIB + H ₂ T3 Gb, Motor Ex e, Three phase current, 3~, 400 V, 50 Hz, Protection category IP44															
RDD 560/6 Ex ¹⁾	07432	865	9410	61.5	1100	2.12	2.12	1157	40	40	67.0	MSA	01289	TSD 3	01502

1) Performance diagram at www.HeliosSelect.de.

2) Includes motor protection circuit breaker.

Performance curve VDD 560/4

Frequency	Hz	Tot.	125	250	500	1k	2k	4k	8k
L _{WA} Inlet side	dB(A)	82	71	73	74	75	74	70	63
L _{WA} Outlet side	dB(A)	86	75	79	81	80	76	72	65

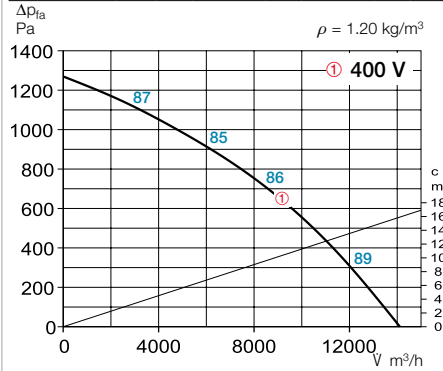

Performance curves VDD 560/6

Frequency	Hz	Tot.	125	250	500	1k	2k	4k	8k
L _{WA} Inlet side	dB(A)	72	61	63	64	65	64	60	53
L _{WA} Outlet side	dB(A)	77	66	70	72	71	67	63	56

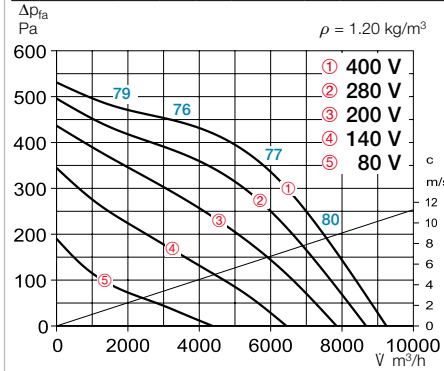

Type	Ref. no.	Speed	Flow rate Free blowing	Noise sound pressure	Power consump.	Current consump.		Wiring diagram	Max. air flow temp.		Weight net	Motor protection circuit breaker		Speed controller 5-step	
						at rated voltage	with control		at rated voltage	with control		Type	Ref. no.	Type	Ref. no.
Three phase current, 3~, 400 V, 50 Hz, Squirrel-cage rotor, Protection category IP54															
VDD 560/6	07422	920	9250	60	1180	3.2	3.2	1129	60	60	75.0	MD	05849	RDS 7 ²⁾	01578
VDD 560/4	07420	1385	14100	69	4430	6.4	—	1130	55	55	77.0	MD	05849	FU-BS 8.0	05461
Ex Explosion-proof, II 2G Ex h IIB + H ₂ T3 Gb, Motor Ex e, Three phase current, 3~, 400 V, 50 Hz, Protection category IP44															
VDD 560/6 Ex ¹⁾	07430	860	8455	60	1090	2.1	2.1	1157	40	40	70.0	MSA	01289	TSD 3	01502
T120 Three phase current, 3~, 400 V, 50 Hz, Squirrel-cage rotor, Protection category IP54 or IP55*															
VDD 560/6 T120 ¹⁾	07439	965	12323	60	1640	3.6	3.5	1264	120	100	92.0	MD	05849	RDS 7 ²⁾	01578
VDD 560/4 T120 ¹⁾	07436	1460	16224	69	5500	11.5	—	1130	120	100	102.0	MSA	01289	FU-BS 10	05462

1) Performance diagram at www.HeliosSelect.de.

2) Includes motor protection circuit breaker.



Impeller
 High-performance centrifugal impeller with backward curved blades made of aluminium. Dynamically balanced according to DIN ISO 21940-11 – quality grade 6.3.

Drive
 Speed-controllable external rotor motor in closed design (IP54) (explosion-proof version in IP44). Flange motor with self-ventilation (T120 version) in IP55. Ball bearing mounted with moisture protection. Maintenance-free and radio interference-free.

Motor protection
 Through built-in thermal contacts or built-in PTC thermistors, which must be connected to a motor protection circuit breaker. Assignment see type table.

Electrical connection
 No dismantling of casing, to external isolator switch (explosion-proof version to terminal box) in protection category IP65.

Protection grille
 On the outlet side as standard according to DIN EN ISO 13857.

Power control
 All types have continuously variable speed control in the range from 0 – 100 % with a frequency inverter with integrated, all-pole effective sine filter (except for explosion-proof version) or five-step control units (except for units with FU). Assignment see type table.

Delivery
 Units are ready-for-connection, fully pre-assembled in the shipping box. Easy positioning due to standard crane hook.

Noise
 The total level and range are specified above the performance diagram for:

- Inlet side sound power
- Outlet side sound power.

The horizontally case-radiated noise as sound pressure at 4 m (free field conditions) is also specified in the type table. Hood silencer see Accessories.

References	Page
Planning information	10 ff.
Technical description	492 f.
Selection table	494 f.
Accessories, details	550 f.
Speed controllers, controllers and switches	591 ff.

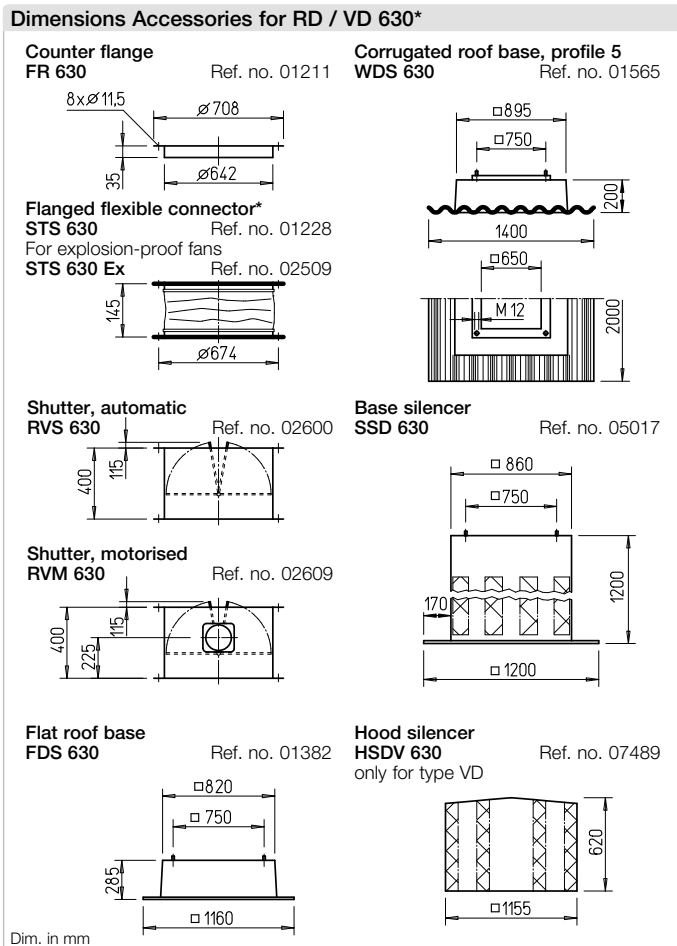
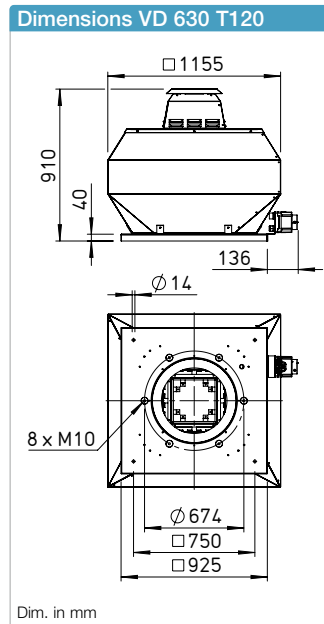
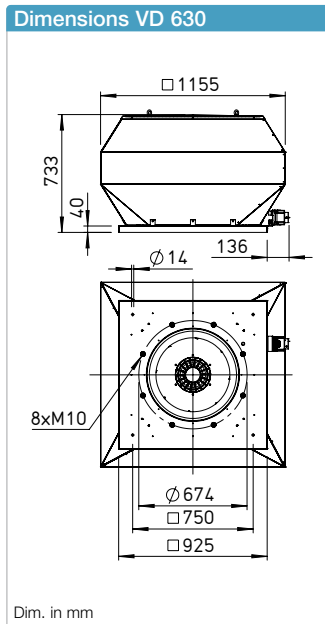
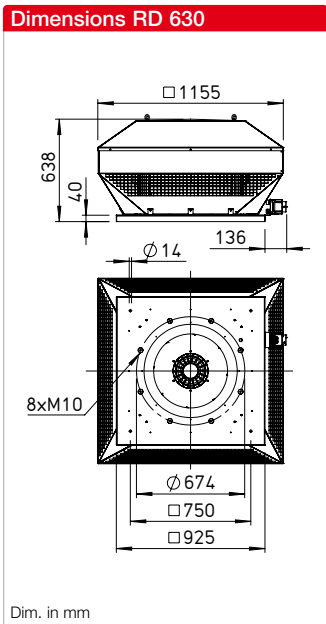

Description RD
 Horizontal outlet roof fan with efficiency-optimised aluminium casing and newly developed high-performance centrifugal impeller.

Description VD
 Vertical outlet roof fan with efficiency-optimised aluminium casing and newly developed high-performance centrifugal impeller.

Description VD T120
 Designed for the delivery of process air up to +120 °C. Enclosed motor located outside of the air flow. Compliant with VDI 2052.

Description of all series

Casing
 Casing made of sea water-resistant aluminium with integrated tamper protection. Motor support plate and base plate with inlet nozzle made of galvanised steel (explosion-proof version inlet nozzle made of aluminium). Base plate with threaded screws for attachment of inlet-side accessories (hole pattern according to DIN 24155).

* Accessories VD T120 see installation accessories p. 551 f. Other accessories upon request.

Performance curves RDD 630/6

Frequency	Hz	Tot.	125	250	500	1k	2k	4k	8k	
L _{WA} Inlet side		dB(A)	79	62	69	73	74	72	70	61
L _{WA} Outlet side		dB(A)	83	67	73	79	78	74	67	62

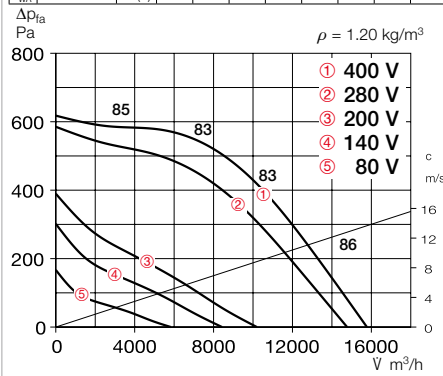

Type	Ref. no.	Speed	Flow rate Free blowing	Noise sound pressure	Power consump.	Current consump.		Wiring diagram	Max. air flow temp.		Weight net	Motor protection circuit breaker		Speed controller 5-step	
						at rated voltage	with control		at rated voltage	with control		Type	Ref. no.	Type	Ref. no.
Three phase current, 3~, 400 V, 50 Hz, Squirrel-cage rotor, Protection category IP54															
RDD 630/6	07447	875	16650	66	2380	4.7	5.2	1129	55	45	92.0	MD	05849	RDS 7²⁾	01578
Explosion-proof, II 3G Ex h IIB + H ₂ T3 Gc, Motor Ex nA, Three phase current, 3~, 400 V, 50 Hz, Protection category IP44															
RDD 630/6 Ex¹⁾	07450	905	16500	67.5	2690	5.4	5.6	1157	40	40	97.0	MSA	01289	TSD 7	01504

1) Performance diagram at www.HeliosSelect.de.

2) Includes motor protection circuit breaker.

Performance curves VDD 630/6

Frequency	Hz	Tot.	125	250	500	1k	2k	4k	8k
L _{WA} Inlet side		dB(A)	78	65	71	72	71	64	57
L _{WA} Outlet side		dB(A)	83	67	76	77	76	71	63

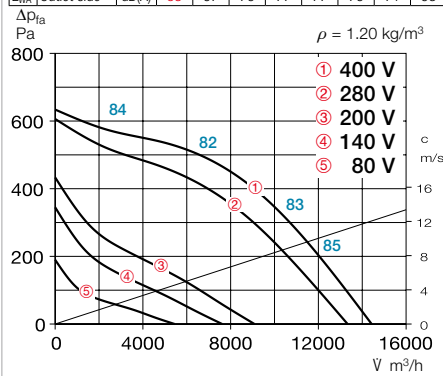

Type	Ref. no.	Speed	Flow rate Free blowing	Noise sound pressure	Power consump.	Current consump.		Wiring diagram	Max. air flow temp.		Weight net	Motor protection circuit breaker		Speed controller 5-step	
						at rated voltage	with control		at rated voltage	with control		Type	Ref. no.	Type	Ref. no.
Three phase current, 3~, 400 V, 50 Hz, Squirrel-cage rotor, Protection category IP54															
VDD 630/6	07441	930	14430	66	2130	4.6	4.95	1129	60	60	96.0	—	—	RDS 7²⁾	01578
Explosion-proof, II 3G Ex h IIB + H ₂ T3 Gc, Motor Ex nA, Three phase current, 3~, 400 V, 50 Hz, Protection category IP44															
VDD 630/6 Ex¹⁾	07448	910	14700	67	2660	5.3	5.5	1157	40	40	101.0	MSA	01289	TSD 7	01504
T120 Three phase current, 3~, 400 V, 50 Hz, Squirrel-cage rotor, Protection category IP55															
VDD 630/6 T120¹⁾	07456	985	19540	69	3160	7.5	7.5	1130	105	—	105.0	MSA	01289	FU-BS 10	05462

1) Performance diagram at www.HeliosSelect.de.

2) Includes motor protection circuit breaker.

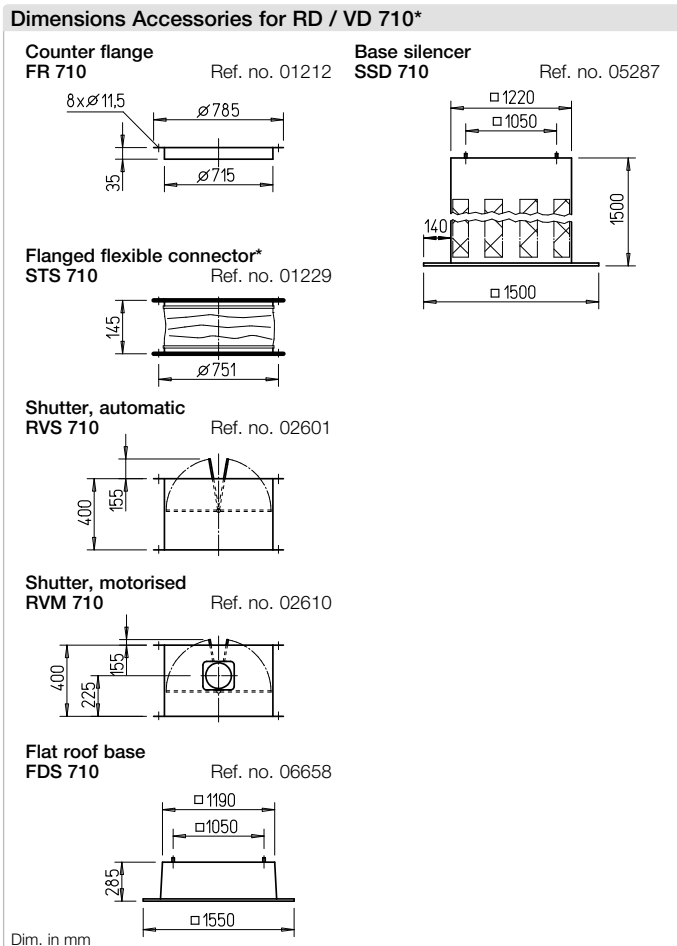
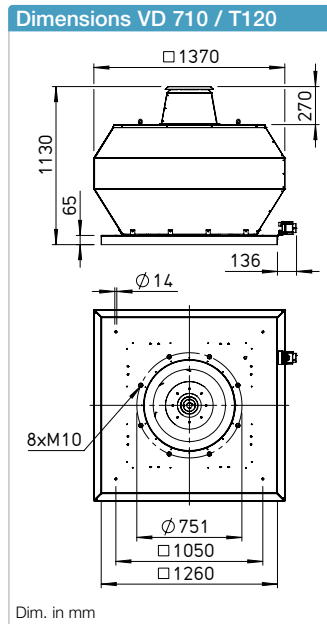
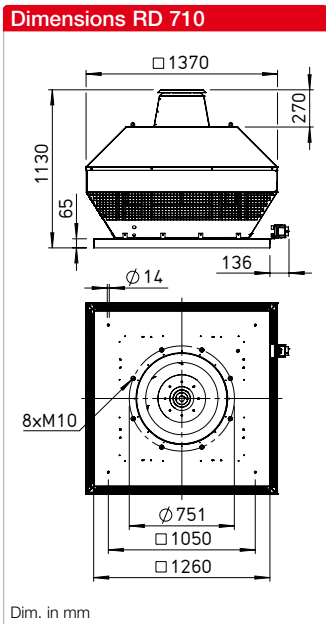

Description RD

Horizontal outlet roof fan with efficiency-optimised aluminium casing and newly developed high-performance centrifugal impeller.

Description VD

Vertical outlet roof fan with efficiency-optimised aluminium casing and newly developed high-performance centrifugal impeller.

Description VD T120

Designed for the delivery of process air up to +120 °C. Enclosed motor located outside of the air flow. Compliant with VDI 2052.

Description of all series

Casing

Casing made of sea water-resistant aluminium with integrated tamper protection. Motor support plate and base plate with inlet nozzle made of galvanised steel. Base plate with threaded screws for attachment of inlet-side accessories (hole pattern according to DIN 24155).

Impeller

High-performance centrifugal impeller with backward curved blades made of aluminium. Dynamically balanced according to DIN ISO 21940-11 – quality grade 6.3.

Drive

Speed-controllable IEC standard motor with self-ventilation in closed design IP55. Ball bearing mounted with moisture protection. Maintenance-free and radio interference-free.

Motor protection

Through built-in thermal contacts or built-in PTC thermistors, which must be connected to a motor protection circuit breaker. Assignment see type table.

Electrical connection

No dismantling of casing, to external isolator switch in protection category IP65.

Protection grille
 On the outlet side as standard according to DIN EN ISO 13857.

Power control
 All types have continuously variable speed control in the range from 0 – 100 % with a frequency inverter with integrated, all-pole effective sine filter.

Delivery
 Units are ready-for-connection, fully pre-assembled in the shipping box. Easy positioning due to standard crane hook.

Noise
 The total level and range are specified above the performance diagram for:

- Inlet side sound power
- Outlet side sound power.

The horizontally case-radiated noise as sound pressure at 4 m (free field conditions) is also specified in the type table.

References	Page
Planning information	10 ff.
Technical description	492 f.
Selection table	494 f.
Accessories, details	550 f.
Speed controllers, controllers and switches	591 ff.

* Accessories VD T120 see installation accessories p. 551 f. Other accessories upon request.

Performance curve RDD 710/6

Frequency	Hz	Tot.	125	250	500	1k	2k	4k	8k
L _{WA} Inlet side	dB(A)	83	72	75	75	76	78	72	63
L _{WA} Outlet side	dB(A)	87	72	75	75	76	78	72	63

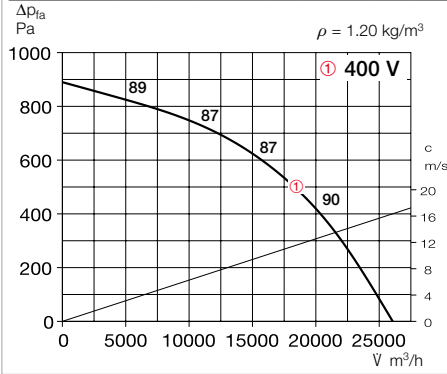

Type	Ref. no.	Speed	Flow rate Free blowing	Noise sound pressure	Power consump.	Current consump.		Wiring diagram	Max. air flow temp.		Weight net	Motor protection circuit breaker		Speed controller 5-step	
						at rated voltage	with control		at rated voltage	with control		Type	Ref. no.	Type	Ref. no.
Three phase current, 3~, 400 V, 50 Hz, Squirrel-cage rotor, Protection category IP54															
RDD 710/6															
	07460	980	26066	70	4300	9.4	—	1130	50	40	187.0	—	—	—	—

Performance curve VDD 710/6

Frequency	Hz	Tot.	125	250	500	1k	2k	4k	8k
L _{WA} Inlet side	dB(A)	82	71	74	74	75	77	71	62
L _{WA} Outlet side	dB(A)	86	74	76	79	80	81	73	65

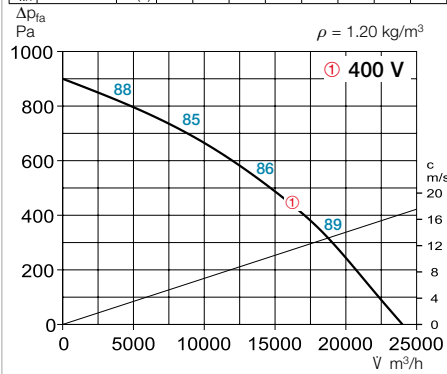

Type	Ref. no.	Speed	Flow rate Free blowing	Noise sound pressure	Power consump.	Current consump.		Wiring diagram	Max. air flow temp.		Weight net	Motor protection circuit breaker		Speed controller 5-step	
						at rated voltage	with control		at rated voltage	with control		Type	Ref. no.	Type	Ref. no.
Three phase current, 3~, 400 V, 50 Hz, Squirrel-cage rotor, Protection category IP54															
VDD 710/6															
T120 Three phase current, 3~, 400 V, 50 Hz, Squirrel-cage rotor, Protection category IP55															
VDD 710/6 T120 ¹⁾															
	07458	985	23800	69	4270	9.4	—	1130	60	—	185.0	MSA	01289	—	—
	07466	985	24536	69	4270	9.4	9.4	1130	106	—	185.0	MSA	01289	FU-BS 16	05463

¹⁾ Performance diagram at www.HeliosSelect.de.

HDH



■ **Roof ventilation hoods HDH**
For covering convection vents and supply air openings in the roof. Same design as horizontal outlet roof fans RD.
With regard to mechanical ventilation, the resulting flow losses must be taken into account (see diagrams).
Accessories same as roof fans.

Dimensions HDH

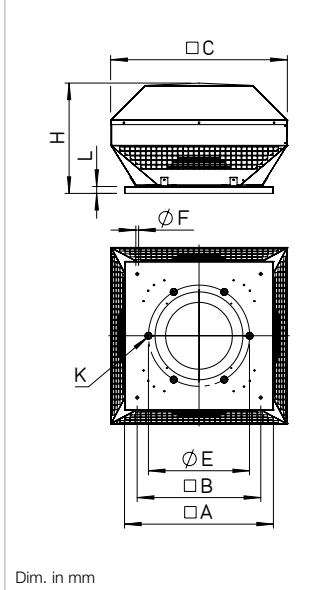

Supply air HDH 180 – 400

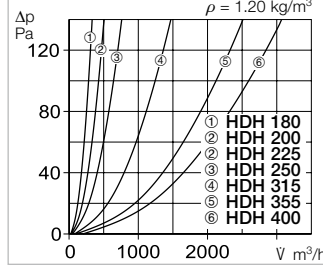

Supply air HDH 450 – 710

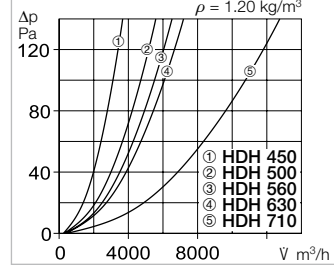

Exhaust air HDH 180 – 355

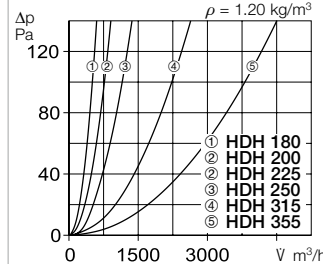

Exhaust air HDH 400 – 710

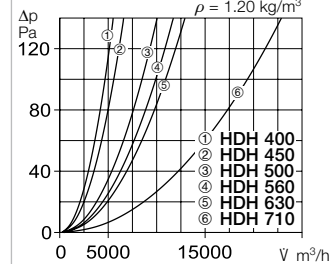

Type	Ref. no.	Nominal size	□ A	□ B	□ C	∅ E	∅ F	H	K	L	Weight net
		mm	mm	mm	mm	mm	mm	mm	mm	mm	approx. kg
HDH 180	07492	180	320	245	309	213	10	155	6 x M6	30	3.5
HDH 200	07493	200	425	330	405	259	10	198	6 x M6	30	5.0
HDH 225	07495	225	425	330	405	259	10	198	6 x M6	30	5.0
HDH 250	07496	250	580	450	450	286	10	255	6 x M6	30	8.0
HDH 315	07497	315	580	450	606	356	12	386	8 x M8	30	12.5
HDH 355	07498	355	645	535	740	395	12	452	8 x M8	30	17.5
HDH 400	07499	400	645	535	765	438	12	478	6 x M8	30	17.5
HDH 450	07491	450	730	590	860	487	12	473	6 x M8	30	26.0
HDH 500	07513	500	925	750	966	541	12	531	6 x M8	40	30.0
HDH 560	07517	560	925	750	1075	605	14	591	8 x M10	40	44.0
HDH 630	07518	630	925	750	1155	674	14	633	8 x M10	40	47.0
HDH 710	07519	710	1260	1050	1370	751	14	860	8 x M10	65	52.0

HSDV

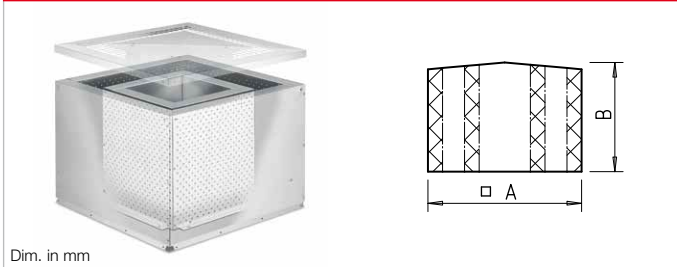

■ **Hood silencer HSDV for outlet side noise reduction**
Average insulation vale 8 dB. Available for series VD, nominal sizes 315 – 630.
The construction is placed on the

roof fan and it can also be retro-fitted without structural alteration. Can only be installed on series VD.

Type	Ref. no.	A	B
HSDV 315	07476	606	310
HSDV 355	07480	740	350
HSDV 400	07481	765	400
HSDV 450	07482	860	450
HSDV 500	07483	966	500
HSDV 560	07484	1075	550
HSDV 630	07489	1155	620

RS



■ **Isolator switch RS RS 3+1+2** Ref. no. 07536
– 3 main contacts
– 1 auxiliary contact
– 2 contacts for TB/TP

For fans with direct start-up. Plastic casing for surface-mounting. Locking options in "0 OFF" position.

■ **Technical data**
Voltage 400 V, 3~, 50/60 Hz
Operating current 20 A
Load capacity AC-23 B, 7.5 kW
Protection category IP 65
Protection class II
Operation Rotary drive
Temp. range –25 to +60 °C
Weight approx. 0.3 kg
Dim. mm W 90.5 x H 90.5 x D 102
Casing UV and weather-resistant
Wiring diagram no. 1131

FR / DFR

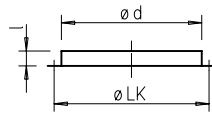

Dim. in mm

Also suitable for: T120

■ Flange ring FR

Made of galvanised steel sheet, for inlet side duct connection. Directly screwed to the fan base plate.

Dimensions according to DIN 24155, p. 2.

Type	Ref. no.	Ø LK	l	Ø d	Weight approx. kg
FR 180	01200	213	25	186	0.4
DFR 200	01201	259	30	233	0.5
FR 225	01201	259	30	233	0.5
FR 250	01203	286	25	256	0.6
FR 315	01204	356	30	326	0.9
FR 355	01205	395	30	365	1.1
FR 400	01206	438	30	408	1.2
FR 450	01207	487	35	457	1.8
FR 500	01208	541	35	511	1.8
FR 560	01209	605	35	574	2.0
FR 630	01211	674	35	642	2.2
FR 710	01212	751	35	715	3.3

STS / DSTS

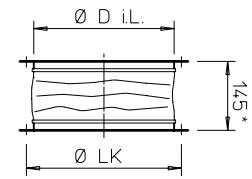

* Type STS 180 = 130 mm

Dim. in mm

Also suitable for: Ex

■ Flanged flexible connector STS

For the prevention of structure-borne sound transmission to inlet side pipes. Flange made of galvanised steel sheet. Elastic sleeve

made of PVC fabric. Use type STS Ex for explosion-proof fans. Directly screwed to the fan base plate. Flange dimensions according to DIN 24155, p. 2. Ambient temperature -30 °C to +80 °C.

Type	Ref. no.	Type*	Ref. no.	Ø D i.L.	Ø LK	Wgt approx. kg
STS 180	01217	—	—	183	213	0.9
DSTS 200	01218	DSTS 200 Ex	02500	229	259	1.1
STS 225	01218	STS 225 Ex	02500	229	259	1.1
STS 250	01220	STS 250 Ex	02501	252	286	1.3
STS 315	01221	STS 315 Ex	02503	322	356	1.8
STS 355	01222	STS 355 Ex	02504	358	395	2.1
STS 400	01223	STS 400 Ex	02505	404	438	2.5
STS 450	01224	STS 450 Ex	02506	453	487	3.8
STS 500	01225	STS 500 Ex	02507	507	541	3.4
STS 560	01226	STS 560 Ex	02508	570	605	4.5
STS 630	01228	STS 630 Ex	02509	638	674	4.6
STS 710	01229	—	—	711	751	7.0

* For explosion-proof fans.

RVS / DVS

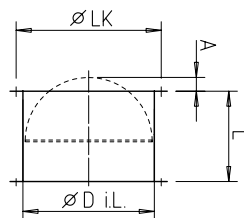

Dim. in mm

Also suitable for: T120

■ Automatic duct shutter with spring-return RVS¹⁾

For the prevention of cold draughts when the fan is at a standstill. For vertical throughflow from bottom to top (otherwise use type RVM). Automatic function through fan operation. Spring mechanism outside of the air flow. Locking force corresponds to fan power

and the installation position can be adjusted. Shutter and casing made of galvanised steel sheet, shutter made of aluminium for NS 225 – 560 mm. Directly screwed to the fan base plate. Double-sided flange. Holes pursuant to DIN 24155, p. 2. Ambient temp. -30 to +100 °C

Type	Ref. no.	Ø D i.L.	L	A	Ø LK	Weight approx. kg
DVS 180	01247	180	110	15	213	1.2
DRVS 200	02591	225	300	—	259	3.0
RVS 225	02591	225	300	—	259	3.0
RVS 250	02592	250	300	—	286	3.4
RVS 315	02594	315	300	—	356	4.3
RVS 355	02595	355	300	—	395	5.8
RVS 400	02596	400	330	—	438	7.2
RVS 450	02597	454	330	15	487	10.4
RVS 500	02598	504	330	40	541	11.7
RVS 560	02599	560	330	65	605	16.1
RVS 630	02600	630	400	115	674	19.5
RVS 710	02601	710	400	155	751	26.5

¹⁾ Pressure loss diagram see Page 556.

RVM / DRVM

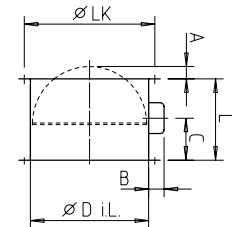

Dim. in mm

■ Motorised shutter RVM^{1) 2)}

Like RVS, but for vertical throughflow in any direction and with a mounted spring return motor (outside of air flow). Allows static ventilation when fan is at a standstill. Supply air control in combination with a roof ventilation hood. Elec. control parallel with fan; cable length 0.9 m, normally closed.

Ambient temp. -30 to +60 °C
Protection category IP54
Volt./Frequency 230 V AC, 50/60 Hz
Power consumption - up to Ø560/from Ø630 14 W/6.5 W
Shutter opening time, aprx. 75 sec.
Wiring diagram no. 380.1

Type	Ref. no.	Ø D i.L.	B	C	L	A	Ø LK	Wgt approx. kg
DRVM 200	02575	225	95	130	300	—	259	3.3
RVM 225	02575	225	95	130	300	—	259	3.3
RVM 250	02576	250	95	130	300	—	286	3.7
RVM 315	02578	315	95	130	300	—	356	4.6
RVM 355	02579	355	95	130	300	—	395	6.1
RVM 400	02580	400	95	130	330	—	438	7.5
RVM 450	02581	454	95	130	330	15	487	10.7
RVM 500	02582	504	95	130	330	40	541	12.0
RVM 560	02583	560	95	130	330	65	605	16.4
RVM 630	02609	630	150	225	400	115	674	21.0
RVM 710	02610	710	150	225	400	155	751	28.0

²⁾ Types DRVM/RVM not suitable for use in potentially explosive atmospheres.

FDS

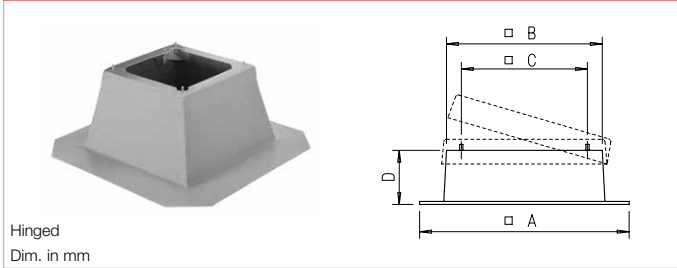

Hinged
Dim. in mm

■ Flat roof base FDS

For the placement of roof fans and ventilation hoods on flat roofs. Horizontal installation. Use of this base reduces costs and installation expenses to a minimum in comparison to handcrafted designs. Corrosion-resistant GFK version (NS 710 made of galvanised steel sheet) with abrasion-resistant, sound and heat insulation. Snow-safe base height.

■ Installation

Attach base above the roof opening (roof). Full roof coating over adhesive edge of the base and seal with bitumen fibre filler. Fixing screws, rubber profile and seal between base and base plate included in delivery.

Type	Ref. no.	A	B	C	D
FDS 180*	01377	645	285	245	285
FDS 200*	01378	750	392	330	285
FDS 225*	01378	750	392	330	285
FDS 250*	01379	870	520	450	285
FDS 315*	01379	870	520	450	285
FDS 355*	01380	950	605	535	285
FDS 400*	01380	950	605	535	285
FDS 450*	01381	1000	660	590	285
FDS 500	01381	1160	820	750	285
FDS 560	01382	1160	820	750	285
FDS 630	01382	1160	820	750	285
FDS 710	06658	1550	1190	1050	285

* With hinge mechanism for easy inspection and cleaning.

SSD

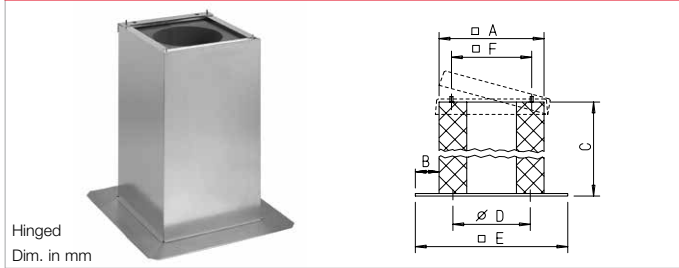

Hinged
Dim. in mm

■ Base silencer SSD for inlet-side sound insulation

Average insulation value 15 dB. All metal parts made of galvanised steel sheet. For installation on flat roofs in the same way as the flat roof base. Fixing screws, rubber profile and seal between base and base plate included in delivery. For NS 500–710: Sound insulation baffles with insulation board made

of non-combustible material, class A2, wrapped in glass fibre mat on both sides. NS 180–450: With hinge for folding the fan down for inspection purposes. Foam core with free cross-section allows access to the duct/shaft system. Base plate is equipped with threaded bushes (according to DIN 24155, p. 2) for the connection of inlet side accessories.

Type	Ref. no.	A	B	C	D	E	F
SSD 180*	05289	280	160	750	213	600	245
SSD 200*	05290	400	133	735	259	666	330
SSD 225*	05290	400	133	735	259	666	330
SSD 250*	05292	520	150	835	286	795	450
SSD 315*	05292	520	150	835	356	795	450
SSD 355*	05024	600	150	985	395	900	535
SSD 400*	05291	600	150	985	438	900	535
SSD 450*	05288	675	158	985	487	990	590
SSD 500	05017	860	170	1200	–	1200	750
SSD 560	05017	860	170	1200	–	1200	750
SSD 630	05017	860	170	1200	–	1200	750
SSD 710	05287	1220	140	1500	–	1500	1050

* With hinge mechanism for easy inspection and cleaning.

WDS

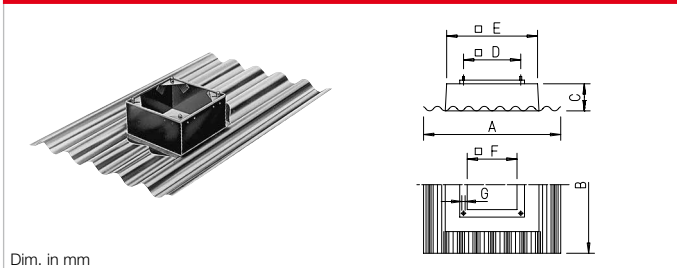

Dim. in mm

■ Corrugated roof base WDS

For the placement of roof fans and ventilation hoods on corrugated roofs. Weather-resistant and non-corrosive design made of glass-fibre reinforced polyester with a low deadweight. No risk of breakage during shipping and on the construction site. Low thermal transmittance value. Corrugation spacing 177 mm (profile no. 5). Use of this base costs for

planning, design and installation to a minimum. Rain drains on the front and back grooves between the square base and the corrugated plate allow installation of the corrugated roof plate regardless of the assembly direction. Screws, washers and rubber profile for attaching and sealing the fan-base plate included in the delivery.

Type	Ref. no.	A	B	C	D	E	F	G
WDS 180	01559	920	1600	200	245	295	Ø 256	M 6
WDS 200/225	01560	920	1600	200	330	395	290	M 10
WDS 250/315	01561	920	1600	200	450	555	395	M 10
WDS 355/400	01562	920	1600	200	535	625	475	M 10
WDS 450	01563	1400	2000	200	590	705	525	M 12
WDS 500/560	01564	1400	2000	200	750	895	650	M 12
WDS 630	01564	1400	2000	200	750	895	650	M 12

SDS

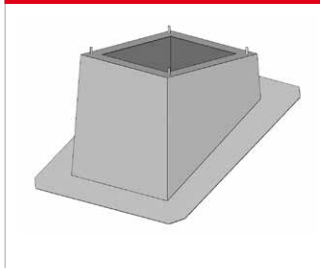

■ Pitched roof base SDS

For the placement of roof fans and ventilation hoods on pitched roofs with up to 45° inclination. Made of galvanised steel sheet, with sound and heat insulated 50 mm thick lining on the inside.

All SDS types are available upon request. Please specify the fan type or nominal size of the ventilation hood, roof inclination angle, brick type or, if applicable, the profile shape and height (for profile roofs) when ordering.

■ Installation

Attach base to roof construction. Seal against roofing with surrounding lead collar. Screws, washers and seal between base and fan/hood base plate included in the delivery.

■ References Page

All centrifugal roof fans do not have protection grilles on the inlet side. If the installation does not ensure protection against unintentional contact, the corresponding contact protection (grille type ASD-SGD or SG) must be attached. 269

■ Other accessories Page

Speed controllers, controllers and switches 591 ff.

Mechanical accessories for your individual building projects.



The development and production of accessory components which are optimally matched to the corresponding fan series are part of the company philosophy of Helios.

■ Shutters, grilles, wall and roof outlets

These Helios components impress with appealing designs, practical handling and robustness.

554^{ff}

■ Extract air, supply air, intake air elements and disc valves

The Helios range offers multiple design award-winning ventilation valves, extract air elements, attachment filter elements, disc valves for supply and extract air operation as well as inlet elements for the controlled supply of intake air.

566^{ff}

■ Fire protection systems and shutter elements

Helios offers various components in all required classifications and for various installation situations for the prevention of fire propagation to adjacent floors and rooms in multi-floor buildings.

582^{ff}



Special features

- Corrosion-free and weather-resistant. Long service life, all components made of break-resistant, UV-resistant plastic, light grey (type VK 160 in white).
- Resistant to aggressive air.
- Less dirt on the building wall due to straight flow through blades.
- Easy and quick to install.
- Flat design.
- Attractive design.
- Maximum flow velocity: Supply air = 6 m/s, extract air = 8 m/s.

■ **Automatic**

- Overpressure shutters in flat design for the external closure of extract air openings.
- Automatic function; opens and closes when fan is activated/deactivated.
- Installation on building wall using screws (four concealed fastenings in the corners).
- Delivered in individual shipping box.
- Nominal sizes 630 and 710 are provided with a centre bar and nominal sizes 800 and 900 are provided with two intermediate bars to increase stability. Accordingly, this results in multiple blade sections.

■ **Manually adjustable**

- For the closure of extract and supply air openings in external walls. Flat design. Suitable for reversible axial fans (supply and extract air) as throughflow possible in both directions.
- Rattle-free and tight closing as blades over centre bar are closed by spring force.
- Manual operation using drawcord via pulley.
- Delivery incl. cord protection tube, pulley and holdback hooks.
- Frame, blades with axles and adjustment slider made of UV-resistant, break-resistant plastic in light grey.
- The shutter has one blade section up to NS 500. In case of larger dimensions (see "Custom sizes"), there are multiple blade sections to increase stability. Each section must be operated with a separate drawcord.

■ **Electrically adjustable**

- External wall shutters for covering extract and supply air openings.
- Automatic function coupled with the fan control. Wired in such a way that the fan only starts up when the shutter is fully open.
- Fan and shutter controlled by on-site changeover switch. End switch in servomotor enables the fan circuit when fully open. Max. load 1 A (incl.). Auxiliary contactor required for higher load or three-phase current fans (contactor, Ref. no. 99611).
- In case of operation with speed controller, shutter control is required via an on-site relay.
- Delivered ready-for-connection with external cable (4 x 1.0 mm², approx. 1.5 m long). Connection according to wiring diagram no. 39 and 73.
- Waterproof interlocking casing in protection category IP46 made of plastic; including maintenance-free drive motor 230 V~, 50 Hz.
- Made of light grey plastic, rattle-free and tight closing.

■ **Pressure losses**

System resistances which are caused by individual components, such as e.g. shutters, must be taken into account for the fan design. The adjacent diagram shows the resistance depending on the flow velocity.

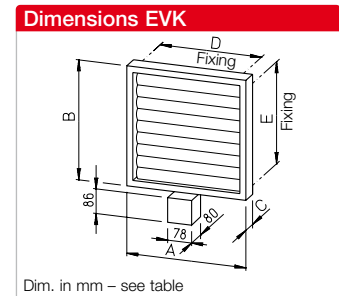
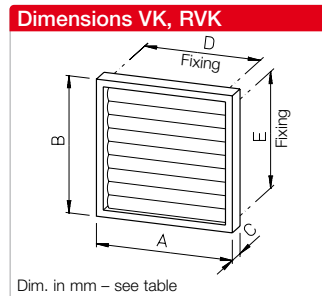
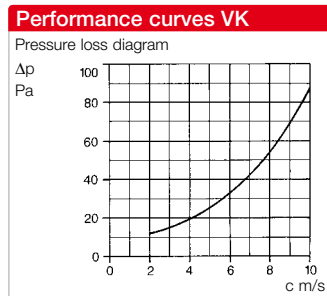

■ **Product range**

Automatic Type	Ref. no.	Manually adjustable Type	Ref. no.	Electrically controlled Type	Ref. no.	Compatible with fan NS mm	Dimensions				
							A mm	B mm	C mm	D mm	E mm
VK 160 ¹⁾	00892	—	—	1)	1)	150/160	190	190	25	131	131
VK 200	00758	RVK 200	00766	EVK 200	00774	180/200	240	240	28	193	167
VK 250	00759	RVK 250	00767	EVK 250	00775	225/250	290	290	28	243	217
VK 315	00760	RVK 315	00768	EVK 315	00776	280/315	340	340	28	293	267
VK 355	00761	RVK 355	00769	EVK 355	00777	355	390	390	28	343	317
VK 400	00762	RVK 400	00770	EVK 400	00778	400	440	440	28	393	367
VK 450	00763	RVK 450	00771	EVK 450	00779	450	490	490	30	443	417
VK 500	00764	RVK 500	00772	EVK 500	00780	500	540	540	30	493	467
VK 630	00836			EVK 630	00781	560/630	686	690	40	520	630
VK 710	00838			EVK 710	00784	710	785	785	40	771	685
VK 800	00839					800	876	885	40	862	785
VK 900	00841					900	1026	985	40	1012	885

■ **Accessories**

Fitting F allows the installation of this shutter (up to NS 710) on round ducts. Selection and description see page 562.

Larger dimensions upon request, see also custom sizes.

¹⁾ Description, design and dimensions of smaller shutters see following page.



- **Small automatic shutters made of plastic for Ø 100, 125 and 160 mm**
Overpressure shutters for the external closure of air outlet openings.
 - Compatible with small fan, extraction hood, tumble dryer outlets etc.
 - Made of UV-resistant, break-resistant plastic.
 - Attachment by conical plug-in connectors or dowels. Foam sealing strip included in delivery.

■ Product range

Type	Ref. no.	Col.	Open. Ø mm	Unit
VK 100	00757	White	100	1
VK 100 B	00765	Brown	100	1
VK 100 VE*	00885	White	100	24
VK 125	00857	White	120-125	1
VK 160	00892	White	150/160	1

* Economical bulk pack.



- **Small electrical shutters**
For covering supply and extract air openings in rooms of any kind.
 - Modern design, elegant even in sophisticatedly designed rooms. The view into dirty openings remains concealed, even when open.
 - Maximum flow velocity approx. 6 m/s.
 - Silent function with switching delay of approx. 60 s.
 - Control via on/off switch, fan preferably connected in parallel.

■ Product range

Type	Ref. no.	Open. Ø mm	Weight KG
EVK 100	00453	100	0.26
EVK 150	00251	150	0.44

Break-resistant plastic, alpine white.
Wiring diagram no. 479.
Voltage/Frequency 230 V~, 50/60 Hz.
Power consumption approx. 6 W.



- **Rectangular shutters**
In horizontal format for the closure of air outlet openings in external walls.
 - Dimensionally matched to the Helios rectangular duct fans.
 - Automatic function.
 - All parts made of high-quality plastic in light grey.
 - Attachment by dowels.
 - Maximum flow velocity = 8 m/s.

■ Product range

Type	Ref. no.	Rect. duct fan NS cm
VK 30/15	00735	30 x 15
VK 40/20	00874	40 x 20
VK 50/25	00875	50 x 25
VK 50/30	00876	50 x 30
VK 60/30	00877	60 x 30
VK 60/35	00878	60 x 35
VK 70/40	00879	70 x 40
VK 80/50	00880	80 x 50
VK 100/50	00881	100 x 50



- **Custom sizes**
The shutter types
 - automatic (overpressure)
 - manually adjustable
 - electrically controllable
 are also available in property-related custom sizes.
 - The dimensions are optional within a grid gradation of 50 mm. All rectangular vertical and horizontal formats as well as all square formats can be delivered. Production is made to order, exchange or return is excluded. Therefore, the dimensions must be precisely defined.
 - A vertical intermediate bar is used from a blade length of approx. 40 cm and a horizontal bar is used for vertical formats from 100 cm upwards to increase stability. Large shutter surfaces are delivered in segments, which must be mounted on a frame, for reasons of stability and shipping.
 - The maximum flow velocity for the standard design is 8 m/s.
 - All parts (frame, blades and their storage) made of high-quality, UV-resistant plastic in light grey.

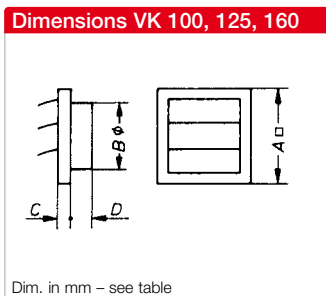

Dim. in mm – see table

Type	Dimensions in mm			
	A	Ø B	C	D
VK 100	140	98	15	28
VK 125	160	120-125	20	30
VK 160	190	145	25	35

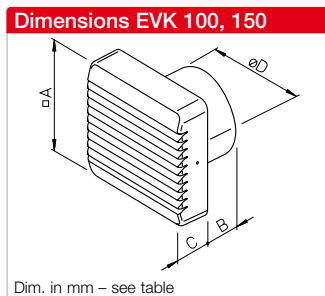

Dim. in mm – see table

Type	Dimensions in mm			
	□ A	B	C	Ø D
EVK 100	140	58	38.5	97
EVK 150	190	62	43	145

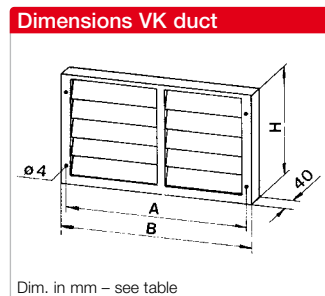

Dim. in mm – see table

Type	Dimensions in mm			Weight kg
	A	B	H	
VK 30/15	381	395	235	1.0
VK 40/20	473	485	285	1.3
VK 50/25	574	585	335	2.0
VK 50/30	574	585	385	2.2
VK 60/30	674	685	385	2.4
VK 60/35	674	685	435	2.6
VK 70/40	774	785	485	3.1
VK 80/50	864	876	585	4.4
VK 100/50	1162	1176	585	5.5

■ Reference

Operating temperature
EVK 100, EVK 150: 0 to +40 °C,
for all other plastic shutters:
-30 to +60 °C.



- **Airtight duct insertion shutter RVE**
Ideal for retrofitting through simple insertion into ventilation duct.
- Plastic ring with circumferential double lip seal and close-fitting rubber membrane which opens in case of underpressure or overpressure.
- Delivered with two membranes for flow velocities up to approx. 3.5 m/s or up to approx. 6 m/s.
- Place axis of rotation upright for horizontal flow.
- Temperature operating range -20 to +90 °C.



- **Duct shutters RSK**
Automatic shutters for insertion in the duct system.
- Prevents the outflow of warm air and the entry of unwanted draughts when fan is deactivated.
- Automatic function in underpressure and overpressure operation (rotatable installation position) through spring locking. Place axis of rotation upright for horizontal flow. In case of vertical flow, only functions in ascending air flow. Use types RVS, RVM to meet additional requirements and in case of difficult circumstances.



- **Automatic duct shutter with spring return**
Can be installed horizontally in any direction and vertically with throughflow from bottom to top. Shutter opening in flow direction; automatic function through fan operation. Spring mechanism outside of air flow. Locking force adjustable corresponding to fan power and installation position. Shutters and casing made of galvanised steel sheet, shutters made of aluminium for NS 225 – 560 mm. Double-sided flanges. Holes acc. to DIN 24155, p. 2.



- **Motorised duct shutter¹⁾**
Like RVS, but can be installed horizontally and vertically in any position and with mounted spring return motor (outside of air flow). Electr. control parallel with fan Ventilator; cable length 0.9 m, normally closed.

Type	Ref. no.	Dimensions in mm			Wgt. kg
		Ø D 1	Ø D 2	L	
RVE 80	02584	75	83	20	0.1
RVE 100	02587	95	103	20	0.1
RVE 125	02588	120	128	20	0.1
RVE 160	02589	155	163	20	0.2
RVE 200	02618	195	203	20	0.2

Type	Ref. no.	Dimensions in mm			Wgt. kg
		Ø D	L	S	
RSKK 100*	05106	97	57	2.0	0.1
RSKK 125*	05107	121	57	2.0	0.1
RSK 150	05073	149	100	1.25	0.5
RSK 160	05669	159	100	1.25	0.5
RSK 180	05662	170	70	0.5	0.3
RSK 200	05074	199	140	1.25	1.0
RSK 250	05673	248.5	140	1.25	1.2
RSK 315	05674	312.5	140	1.25	1.5
RSK 355	05650	352	160	0.75	1.3
RSK 400	05651	397	160	0.75	1.4

* made of plastic (temp. max. +70 °C).
Other types made of galvanised steel sheet, aluminium shutters, stainless steel spring.

Automatic		Motorised ¹⁾		Dimensions in mm						Weight
Type	Ref. no.	Type	Ref. no.	Ø D i.L.	A	B	C	L	Ø LK	aprx. kg
RVS 225	02591	RVM 225	02575	225	-	95	130	300	259	3.3
RVS 250	02592	RVM 250	02576	250	-	95	130	300	286	3.7
RVS 280	02593	RVM 280	02577	280	-	95	130	300	322	4.2
RVS 315	02594	RVM 315	02578	315	-	95	130	300	356	4.6
RVS 355	02595	RVM 355	02579	355	-	95	130	300	395	5.3
RVS 400	02596	RVM 400	02580	400	-	95	130	330	438	7.5
RVS 450	02597	RVM 450	02581	454	15	95	130	330	487	10.7
RVS 500	02598	RVM 500	02582	504	40	95	130	330	541	12.0
RVS 560	02599	RVM 560	02583	560	65	95	130	330	605	16.4
RVS 630	02600	RVM 630	02609	630	115	150	225	400	674	21.0
RVS 710	02601	RVM 710	02610	710	155	150	225	400	751	28.0
RVS 800	02602	RVM 800	02614	800	200	150	225	420	837	37.8
RVS 900	02603	RVM 900	02615	900	250	150	225	420	934	42.3
RVS 1000	02604	RVM 1000*	02616	1000	300	150	225	420	1043	47.8

¹⁾ Types RVM not for use in explosive atmospheres. * RVM 1000 only for horizontal throughflow.

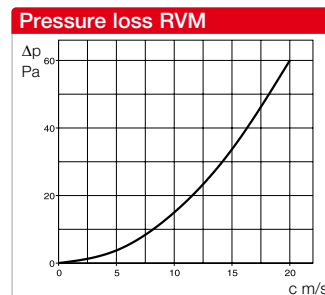
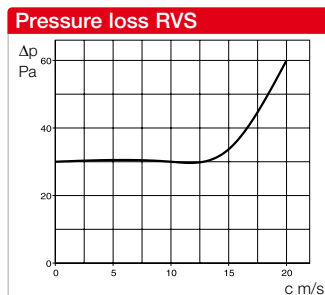
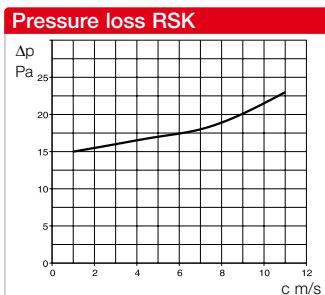
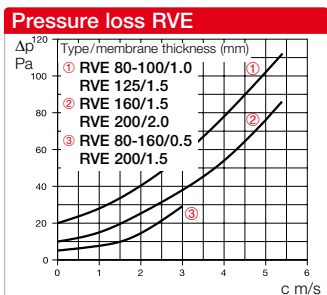
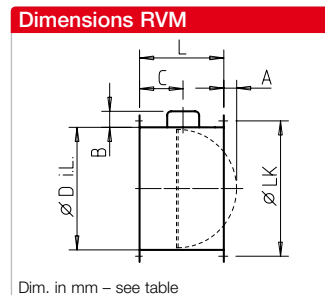
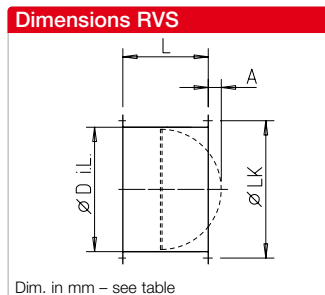
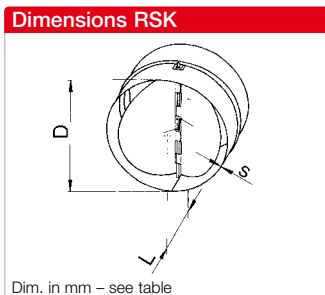
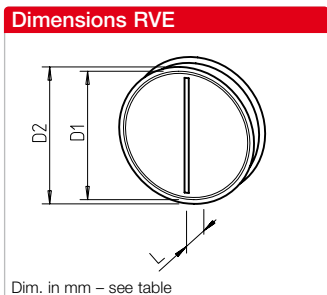

RAG



- **Rain-repellent grille RAG**
Plastic design for placement on air inlet and outlet openings in facades.
- Elegant finish in light grey colour tone, corrosion-resistant and weather-resistant, prevents the ingress of rain, snow and small animals.
- Frame with fixed blades made of UV-resistant, break-resistant plastic. Set-back mesh grille made of galvanised and plastic-coated steel. Mesh width 8 mm.
- Simple (can also be surface-mounted or integrated in facade cladding) installation with dowels. Can also be placed on round duct using fitting F (accessories, see product page).

Type	Ref. no.	up to fan NS mm	Dimensions in mm				Weight kg
			□ B	C	D	E	
RAG 200	00750	180/200	240	28	193	167	0.35
RAG 250	00751	225/250	290	28	243	217	0.45
RAG 315	00752	280/315	340	28	293	267	0.60
RAG 355	00753	355	390	28	343	317	0.75
RAG 400	00754	400	440	28	393	367	1.00
RAG 450	00755	450	490	30	443	417	1.35
RAG 500	00756	500	540	30	493	467	1.60

Dimensions RAG

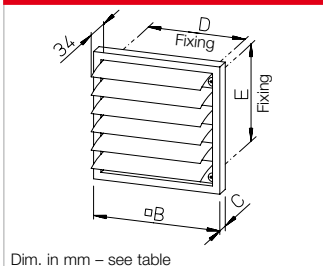

Pressure loss RAG

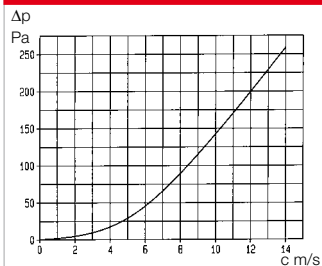

WSG



- **Weather protection grille WSG**
In square or rectangular horizontal format; for attachment on air inlet and outlet openings in facades.
- Architecturally attractive closing against rain, snow, animals and protection against contact and ingress. Can be attached on square, rectangular and round duct outlets.
- Robust design made of extruded aluminium profile, natural colour anodised.
- Installation: To be recessed into masonry or facade cladding.
- Fixed blades and set-back mesh grille made of galvanised steel wire. Mesh width: 16 mm.

- **The rectangular types**
are dimensionally matched to the Helios rectangular duct fans and thus can be inserted into the cross-section of the ventilation duct.

Type	Ref. no.	Compatible with		Dimensions in mm		Weight kg
		fan NS	openings mm i.L.	□ b	□ B	
WSG 200	00117	180/200	□ 200	195	271	0.8
WSG 250	00118	225/250	□ 250	245	321	1.0
WSG 315	00119	280/315	□ 315	310	386	1.5
WSG 355	00120	355	□ 355	350	426	2.0
WSG 400	00121	400	□ 400	395	471	2.5
WSG 450	00122	450	□ 450	445	521	3.0
WSG 500	00123	500	□ 500	495	571	3.5
WSG 630	00124	600/630	□ 630	625	701	4.0
WSG 710	00125	710	□ 710	705	781	4.5

Type	Ref. no.	Compatible with rect. duct NS i.L. mm	Dimensions in mm				Weight kg
			b	B	h	H	
WSG 30/15	00108	300 x 150	296	370	146	220	0.9
WSG 40/20	00109	400 x 200	396	470	196	270	1.2
WSG 50/25	00110	500 x 250	496	570	246	320	1.9
WSG 50/30	00111	500 x 300	496	570	296	370	2.0
WSG 60/30	00112	600 x 300	596	670	296	370	2.2
WSG 60/35	00113	600 x 350	596	670	346	420	2.4
WSG 70/40	00114	700 x 400	696	770	396	470	2.9
WSG 80/50	00115	800 x 500	796	870	496	570	4.0
WSG 100/50	00116	1000 x 500	996	1070	496	570	5.0

Dimensions WSG

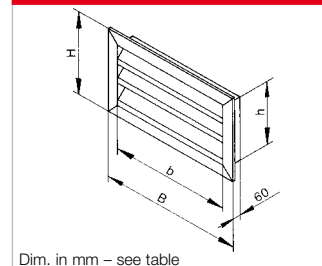

Pressure loss WSG

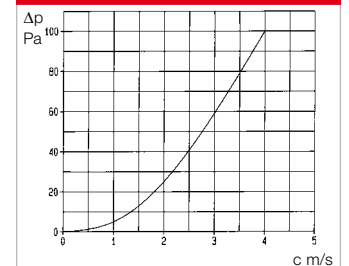

LGR



■ **Ventilation grille LGR**

Rectangular, with adjustable blades.

- For covering rectangular air inlet and outlet openings, preferably in flat rectangular ducts.
- Centrally adjustable blades allow the individual modification of the passage area and thus the alignment and adjustment of the volume flow.
- Corrosion-resistant design made of galvanised steel and white stove enamelling.
- Delivery incl. installation frame which provides universal installation possibilities. In case of installation in thin-walled ducts, attachment with four screws.

QVK



■ **Ventilation grille QVK**

Square, with adjustable blades.

- Can be used to cover supply and extract air openings with square cross-section.
- Centrally adjustable blades allow the individual modification of the passage area and thus the alignment and adjustment of the volume flow.
- Corrosion-resistant design made of galvanised steel and white stove enamelling.
- Delivery incl. plaster frame. Therefore suitable for flush-mounted wall installation and screw attachment without a frame.

G 200 – 500



■ **Ventilation grille G fixed**

For attachment to ventilation openings in ceilings and walls.

- Made of high-quality, UV-resistant and break-resistant plastic.
- Flat design. Simple attachment with dowels.
- Sight screening with appropriate installation.

■ **Product range**

Type	Ref. no.	Colour	Compatible w/ fan NS mm
G 200	00255	White	200
G 250	00256	White	250/280
G 315	00798	White	315
G 355	00799	White	355
G 400	00800	White	400
G 500	00801	Li. grey	450/500

G 100, 160



■ **Ventilation grille G fixed**

For covering and insertion in round ventilation openings.

- Made of high-quality, break-resistant plastic. Corrosion-resistant and thus ideally suitable for external and internal installation.
- Simple installation in round ducts due to rear conical plug-in connectors. Foam strip included in delivery for press-fit attachment. Fixed installation possible with four holes in the corners. When the grille is permanently mounted, the grille insert can be easily removed and replaced for cleaning.

■ **Product range**

Type	Ref. no.	Compatible with rect. duct opening mm i.L.
LGR 250/150	00927	228 x 128
LGR 450/150	00928	428 x 128
LGR 350/230	00929	328 x 208
LGR 450/230	00930	428 x 208

■ **Product range**

Type	Ref. no.	Applicable up to fan NS mm
QVK 200	00791	200
QVK 250	00792	250
QVK 315	00793	315
QVK 355	00794	355
QVK 400	00795	400

Dimensions G 200 and 250

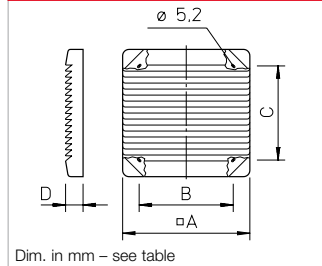

■ **Product range**

Type	Ref. no.	NW in mm	Colour	VE
G 100	00796	90/100	White	1
G 100 B	00782	90/100	Brown	1
G 100 VE*	00828	90/100	White	12
G 160	00893	150/160	White	1

* Cost-effective bulk pack.

Dimensions LGR

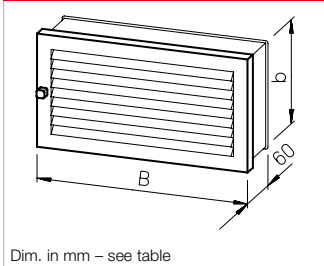

Type	Free cross-section cm ²	Dim. in mm		Wgt. kg
		B	b	
LGR 250/150	160	250	150	0.6
LGR 450/150	320	450	150	1.0
LGR 350/230	430	350	230	1.2
LGR 450/230	575	450	230	1.5

Dimensions QVK

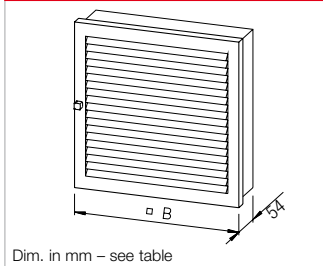

Type	Free cross-section cm ²	Dim. in mm B	Wgt. kg
QVK 200	320	□ 250	0.8
QVK 250	490	□ 300	1.0
QVK 315	680	□ 350	1.3
QVK 355	920	□ 400	1.8
QVK 400	1190	□ 450	3.2

Dimensions G 315 – 500

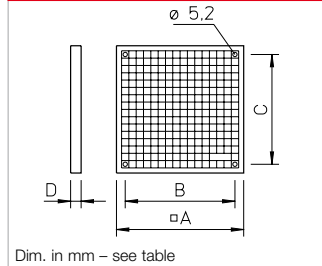

Type	Dimensions in mm					Wgt. kg
	□ A	B	C	D	∅	
G 200	287	210	210	39	5.2	0.7
G 250	337	240	240	39	5.2	0.9
G 315	340	300	300	22	5.2	0.4
G 355	390	350	350	22	5.2	0.4
G 400	440	400	400	22	5.2	0.6
G 500	540	490	465	30	5.2	1.8

Dimensions G 100 and 160

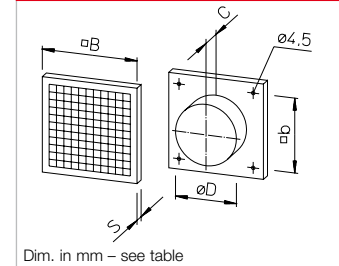

Type	Dimensions in mm					Wgt. kg
	□ b	□ B	C	S	∅ D	
G 100	90	140	28	15	100	0.8
G 160	130	190	40	24	150	0.3



Round facade grille
For the flush coverage of ventilation openings on the facade. Applicable for round intake and exhaust air ducts. Two holes in the duct connector enable secure fastening with screws to be provided by the customer. Stable aluminium construction. Fixed blades with stainless steel wire mesh grille behind them, mesh size 10 x 10 mm.

Product range

Type	Ref. no.	Weight in grammes
FGR 80	40195	100
FGR 100	40196	150
FGR 125	40197	180
FGR 160	40198	300
FGR 200	40199	400
FGR 250	40181	900
FGR 315	40182	1600

Type	Dimensions in mm			
	A	B	C	D
FGR 80	98	81	12	4
FGR 100	124	99	17	3
FGR 125	151	125	17	3
FGR 160	182	160	14	4
FGR 200	224	199	16	4
FGR 250	275	250	15	5
FGR 315	345	314	14	7

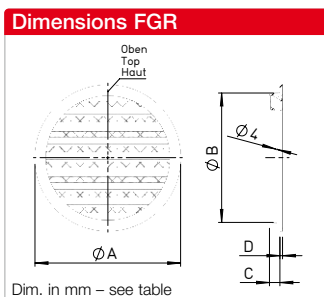

Ventilation grille LG
With diagonally positioned blades for covering round ventilation openings \varnothing 80, 100, 125 and 160 mm.

- High-quality and attractively designed covering.
- Diagonally positioned blades act as a sight screen (with appropriate installation).
- Made of corrosion-resistant die-cast aluminium, powder-coated, colour: white. LGK 80 made of high-quality, break-resistant plastic, colour: white.
- Simple installation in ducts due to rear plug-in connectors with clamp springs and sealing strip.

Product range

Type	Ref. no.	Weight in grammes
LGK 80*	00259	120
LGM 100	00254	300
LGM 125	00258	450
LGM 160	00261	750

* Made of plastic.

Type	Dimensions in mm			
	A	B	C	D
LGK 80	135	105	14	80
LGM 100	155	127	16	95
LGM 125	195	150	25	120
LGM 160	252	190	25	155

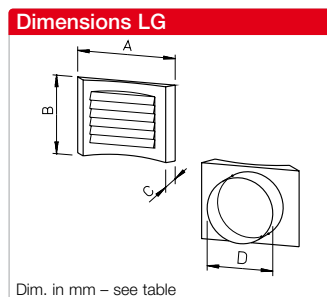

Door ventilation grille LTG
Fixed overflow grille for installation in door leaves.

- Pleasant and unobtrusive design. Made of high-quality break-resistant plastic, in light grey or brown.
- With wide circumferential edge and diagonally positioned blades, sight screening. Only 3 mm high.
- Two-part, telescopic. Installation: Insert both sides of each element into the recess and tighten against each other using the screws supplied.

Product range

Type	Ref. no.	Colour
LTGW	00246	White
LTGB	00247	Brown

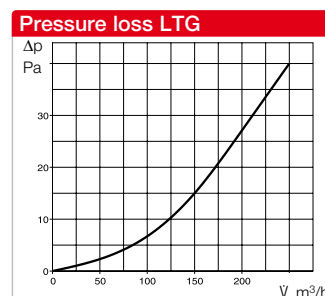
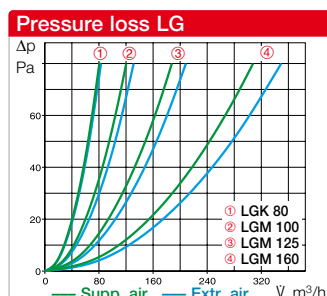
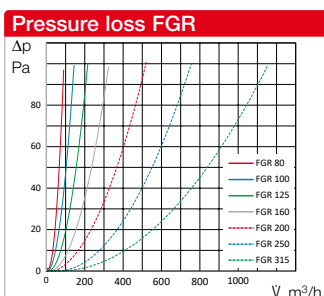
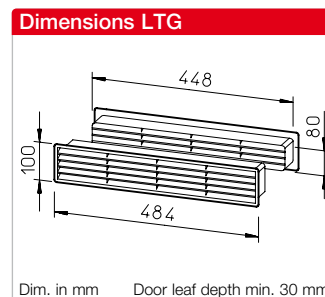

FDH



Roof hood DH with roof pan tiles FDP, UDP and pipe joints STV



Dimensions FDH

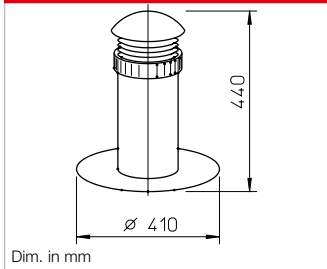

Dimensions DH + UDP

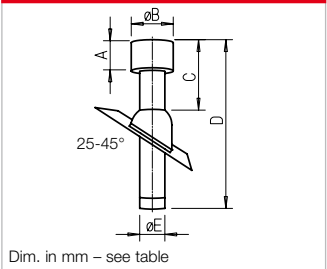

Dimensions DH + FDP

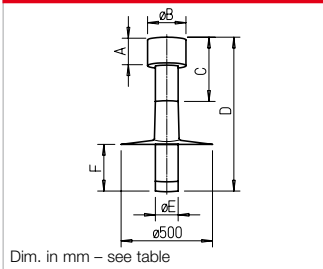

Pressure loss FDH

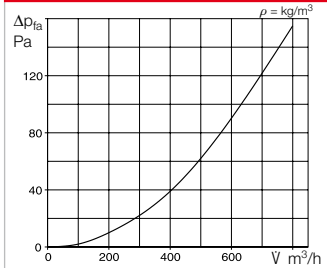

Pressure loss DH

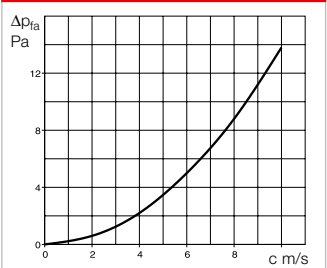

Flat roof hood FDH
 For the connection of ventilation ducts, up to NW 160, above the roof. Made of weather-resistant plastic with wide adhesive edge. cold and heat-resistant up to +200 °C. Removable hood head for inserting the supplied spacer band or insulation to be provided by the customer. The insulation prevents condensation.

FDH Ref. no. 01477

Roof hood DH
 The optimal ventilation solution without static pressure loss. Made of weather-resistant polypropylene, with driving rain-resistant, removable outlet hood. Connection to ventilation duct using pipe joint STV (accessories) which prevents the outlet of condensate at the connection point. The following roof pan tiles should be used for the installation of the roof hood:

- Universal roof pan tile UDP**
 Compatible with almost all tile types, in black or brick red. For roofs with slope angles of 25 – 45°.
- Flat roof pan tile FDP**
 Made of aluminium for flat roofs.

Product range: Order hoods, pan tiles, pipe joints separately.

ND mm	Roof hood*		Universal roof pan tile *, lead		Roof pan tile for flat roof, alum.		Pipe joint	
	Type	Ref. no.	Type	Ref. no.	Type	Ref. no.	Type	Ref. no.
100	DH 100 R	02014	UDP 100 R	02020	FDP 100	02024	STV 100	02026
	DH 100 S	02015	UDP 100 S	02021				
125	DH 125 R	02016	UDP 125 R	02020	FDP 125	02013	STV 125	02027
	DH 125 S	02017	UDP 125 S	02021				
160	DH 160 S	02019	UDP 160 S	02023	FDP 160	02025	STV 160	02028

* R = brick red, S = black.

Dimensions: Roof hood DH with roof pan tile UDP or FDP.

ND mm	Dimensions in mm					
	A	Ø B	C	D	Ø E	F
100	120	170	320	790	100	225
125	140	210	340	1020	125	255
160	180	265	365	935	160	345

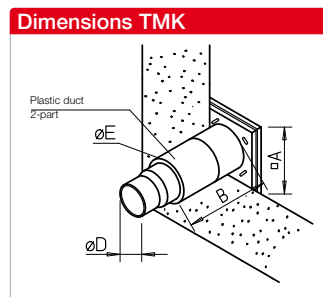
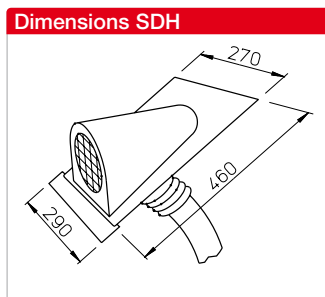
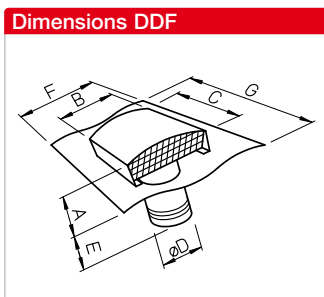
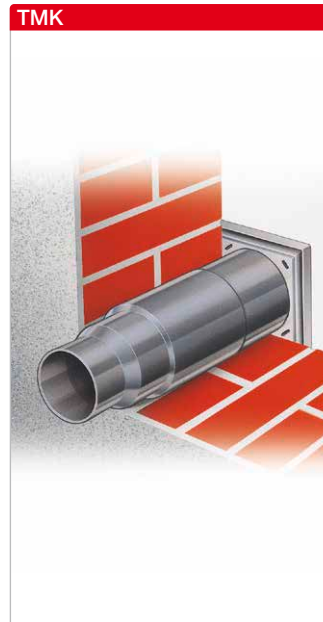
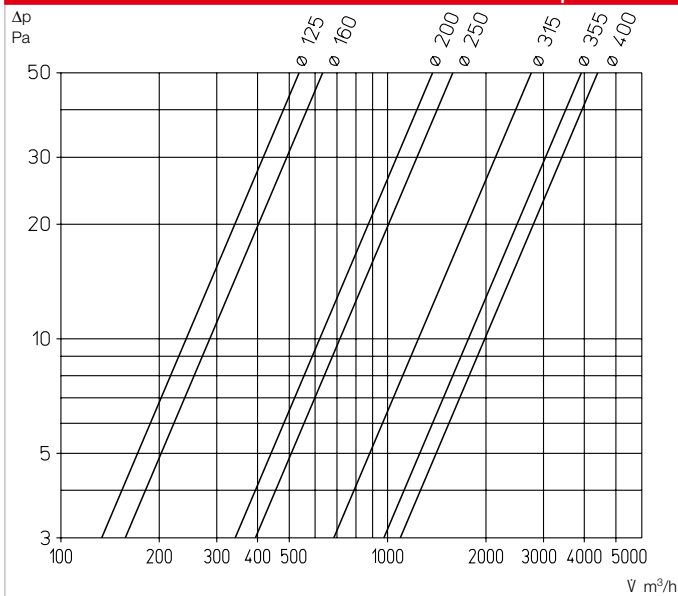
Performance curves Pressure loss DDF for extract air operation

■ Universal roof outlets

For air inlets/outlets or for the connection of ventilation ducts \varnothing 125–400 mm. Hoods available in brick red or slate grey. Can be adapted to all tile types and shapes on gable roofs due to the large, circumferential lead sheet flashing. Support plate for attachment and remaining parts made of galvanised steel sheet.

■ Gable roof hood SDH

Universal design suitable for almost all roof tile types. Can be adapted to different shapes due to the lead sheet edge. Hood and plate made of galvanised steel sheet. Flexible plastic bellows with step connectors for the connection of all duct \varnothing from 70 – 115 mm. Duct attachment with supplied hose clamp.

■ Telescopic wall kit

For supply and extract air ducting through walls. Two telescopic plastic ducts can be adjusted to the wall thickness. Optional external cover with automatic shutter or ventilation grille. Room-side connectors for connecting the pipe. Type TMK 125/150 with step connectors \varnothing 125, 150 and 160 mm. Type TMK 100 for duct \varnothing 100 mm.

■ Product range and dim.

Type	TMK 100	TMK 125/150
Ref. no.	00844	00845
Dim. A mm	140 □	190 □
B max.	500	500
\varnothing D	100	125/150/160
\varnothing E	108.5	155

■ Product range and dimensions DDF

Type ¹⁾	Ref. no.	Type ²⁾	Ref. no.	Dimensions in mm							Weight kg
				A	B	C	\varnothing D	E	F	G	
DDF 125	01964	DDF 125 G	01848	165	200	328	125	110	500	390	4
DDF 160	01965	DDF 160 G	01849	175	248	386	160	110	500	390	4
DDF 200	01966	DDF 200 G	01850	210	333	495	200	110	600	600	8
DDF 250	01967	DDF 250 G	01851	210	333	495	250	110	600	600	8
DDF 315	01968	DDF 315 G	01852	220	420	666	315	110	600	600	9
DDF 355	01969	DDF 355 G	01853	360	550	900	355	215	900	750	17
DDF 400	01970	DDF 400 G	01854	360	550	900	400	215	900	750	17

¹⁾ Hood painted brick red (RAL 8012).

²⁾ Hood painted slate grey (RAL 7024).

SDH Ref. no. 01476



■ **T-pieces**
made of steel sheet, galvanised.

Type	Ref. no.	Nominal Ø mm
TS 100	01479	100
TS 125	05720	125
TS 160	05805	160



■ **Duct connector**
made of steel sheet, galvanised.

Type	Ref. no.	Nominal Ø mm
RVB 80	05993	80
RVB 100	05994	100
RVB 125	05995	125
RVB 160	05987	160
RVB 200	05997	200
RVB 250	05998	250
RVB 315	05999	315
RVB 355	05991	355
RVB 400	05992	400



■ **Duct reductions**
made of galvanised steel sheet or plastic*.

Type	Ref. no.	Nominal Ø mm	Reduced Ø mm
RZ 100/80*	05223	100	80
RZ 125/100*	05222	125	100
RZ 160/125	05729	160	125
RZ 160/150*	07684	160	150
RZ 200/160	05710	200	160



■ **Hose clips**
Metal band with turnbuckle.
Delivered as a packaging unit with 10 pcs.

Type	Ref. no.	Nom. Ø mm
SCH 80/100	05722	80 – 115
SCH 125/160	05723	115 – 165
SCH 200	05724	165 – 215
SCH 250	05725	215 – 265
SCH 315/355	05727	265 – 375
SCH 400	05728	375 – 425



Fully flexible ventilation duct
Universally applicable for various industrial, commercial and residential building applications (e.g. for general air and air-conditioning technology, extract air ducts from extraction hoods, tumble dryers etc.).

- **Special features**
- Eliminates storage, shipping and volume problems.
 - One box approx. 60 cm in length contains 10 m duct.
 - Optimal in handling and processing.
 - Smallest poss. bending radius.
 - Superelastic, optionally rebendable, no material fatigue and no leakage.
 - Self-extinguishing in case of fire.

- **Design**
- Two-layer polyester film, aluminium-coated.
 - Integrated spring steel spiral for reinforcement.
 - No toxic gas release in case of fire.
 - Operating temp. from –20 to +100 °C.
 - Max. operating pressure: 2500 Pa
 - Max. permissible flow velocity: 20 m/s.

Type	Ref. no.	Nom. Ø mm	Internal Ø mm	Weight for 10 m	Shipping unit
ALF 80	05711	80	80	1.2	10 m
ALF 100	05712	100	102	1.4	10 m
ALF 125	05713	125	127	1.9	10 m
ALF 160	05757	160	160	2.5	10 m
ALF 200	05715	200	203	4.8	10 m
ALF 250	05716	250	254	5.3	10 m
ALF 315	05717	315	315	9.3	10 m
ALF 355	05758	355	356	9.7	10 m
ALF 400	05759	400	406	11.2	10 m

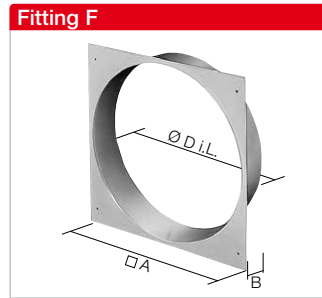

- **Fitting F**
For square shutters for transition to round.
- Application: This can be used for attaching shutters in series VK, RVK, EVK and RAG directly to round ducts or fan connectors (series HQ/HW).
 - Installation: The four holes in the corners correspond to the attachment points on the shutters. The round connector can be placed on the fan casing and attached using self-tapping screws.
 - Material: Galvanised steel sheet.

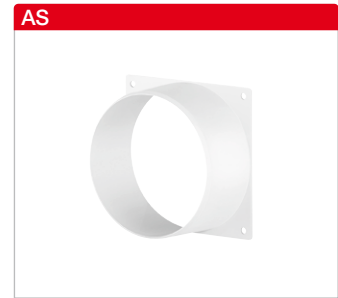

■ **Connectors AS**
With square flange plate (102 x 102 mm) and round connector (50 mm long), made of plastic. For attaching ducts (ND 100) on flat surfaces.

Type	Ref. no.
AS 100	05224

■ **Product range**

Type	Ref. no.	Shutter NS cm	Dim. in mm		
			A	B	ØD.i.L.
F 200	00804	20	240	55	210
F 250	00805	25	290	55	259
F 315	00807	30	340	55	324
F 355	00808	35	390	55	364
F 400	00809	40	440	55	409
F 450	00810	45	490	55	460
F 500	00811	50	540	55	510
F 560/630	00257	63	685	55	570
F 630 ¹⁾	00813	63	685	55	640
F 630 ²⁾	00826	63	685	55	634
F 710 ¹⁾	00824	71	785	55	717
F 710 ³⁾	00825	71	785	55	707

1) For Type HQ. 2) For Type HW.
3) For Type AVD DK.

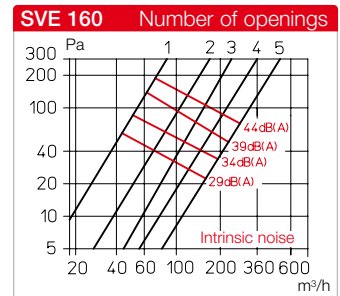
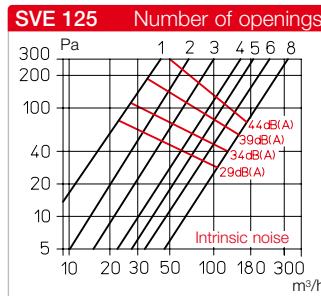
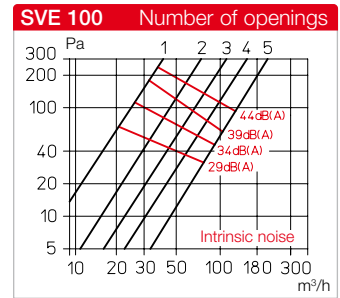
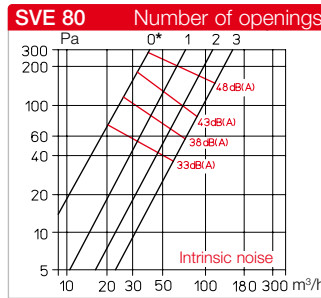

The innovative SVE elements solve two tasks cost-effectively:

- Volume flow adjustment and optimised distribution in central ventilation system duct networks.
- Sound level reduction through the absorption of flow and fan noises.

In order to increase sound level reduction, multiple elements can be connected in series. Two elements cause a doubling of the insertion loss.

■ Performance data and insertion loss

The diagrams provide an overview of air volumes and resistances with corresponding numbers of openings. The red lines and dB(A) values document the intrinsic element noise (L_{WA}). The sound power values are available in the installation and operating instructions above the frequency and as total levels (intrinsic noise of SVE elements). The values in the table specify the insertion loss D_e above the frequency.

■ Material

- Flame-resistant and mould-resistant foam.
- Meets the requirements of emission class M1.
- No noxious fume and toxic gas release in case of fire.
- Meets fire class B2 according to DIN 4102-1 and fire class D according to DIN EN 13501-1.

■ Advantages

- Cost-effective solution for preventing noise transmission to ventilation ducts or pipes.

- Simple installation through insertion into the duct system.
- Simple adjustment thanks to pre-punched openings.
- Minimisation of system construction costs through the use of cost-effective duct systems.
- Can be used with disc valves of any kind.
- Easy to clean with vacuum cleaner.

■ Delivery

Each element separately in poly-bag.

■ Installation

Insert SVE into the duct and prefix the disc valve or extract air element as a wall closure. Set the desired volume flow pursuant to the diagrams above by removing the elliptical cut-outs.

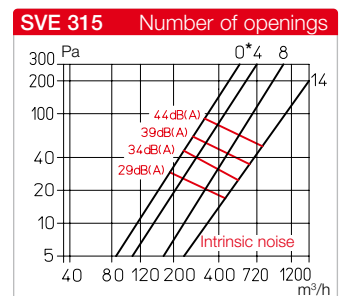
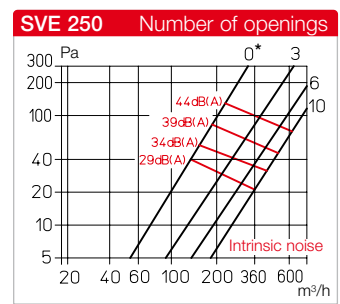
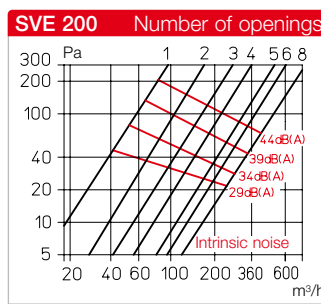

Order data						Insertion loss D_e dB at Hz							
Type	Ref. no.	for NW (mm)	Thick. in mm	Weight in g	Openings	125	250	500	1000	2000	4000	8000	
SVE 80	08309	80	50	32	0*	9.0	5.0	11.5	14.5	18.0	20.0	24.0	
					1	4.5	3.5	7.5	11.5	10.5	17.5	21.0	
					3	4.5	2.5	5.0	8.0	9.5	13.0	15.0	
SVE 100	08310	100	50	60	1	7.0	4.0	9.5	12.5	16.0	17.5	22.0	
					3	3.5	2.5	5.5	8.5	8.5	14.5	19.0	
					5	2.5	1.5	3.5	6.0	6.5	12.0	16.0	
SVE 125	08311	125	50	70	2	6.0	5.0	5.0	12.0	12.5	19.0	21.0	
					5	2.0	2.5	3.0	8.5	8.0	13.5	19.0	
					8	1.5	1.5	2.5	6.0	5.0	11.0	17.5	
SVE 160	08312	160	50	140	1	7.0	4.0	9.5	12.5	16.0	17.5	22.0	
					3	3.5	2.5	5.5	8.5	8.5	14.5	19.5	
					5	2.5	1.5	3.5	6.0	6.0	12.0	16.5	
SVE 200	08313	200	50	190	2	6.5	2.5	5.5	13.0	14.0	18.0	15.5	
					5	3.0	1.5	2.5	9.5	8.5	14.0	14.5	
					8	2.0	1.0	1.5	7.0	7.0	13.0	13.5	
SVE 250	08314	250	75	480	0*	4.0	3.0	7.0	13.0	18.0	18.0	17.0	
					5	2.0	2.0	5.0	9.0	13.0	15.0	15.0	
					10	2.0	1.0	3.0	7.0	11.0	14.0	13.0	
SVE 315	08315	315	75	690	0*	5.0	3.0	6.0	12.0	15.0	16.0	18.0	
					8	3.0	2.0	3.0	8.0	12.0	13.0	15.0	
					14	1.0	1.0	2.0	7.0	8.0	10.0	13.0	

* Minimum volume flow ensured by side recesses.

VKH



Dimensions VKH

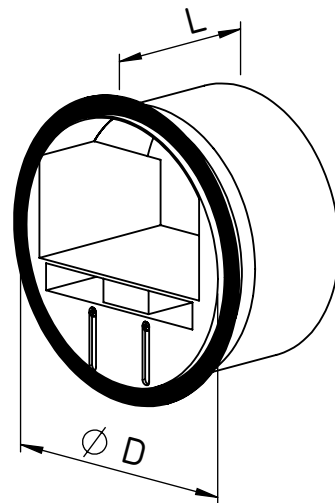

Dim. in mm – see table

The automatic volume flow stabilisers VKH are a convincing and cost-effective solution for ensuring a constant volume flow.

Application

Automatic volume flow stabiliser for insertion into ventilation ducts, duct fittings, in duct sections and in air inlets and outlets. The VKH stabilise the specified nominal output in a differential pressure range from approx. 50–250 Pa.

Advantages

- There is no need for calibration and adjustment on site; thus rapid commissioning of the ventilation system.
- Security in planning and facilitation in design.
- Guaranteed constant volume flow, even with low counterpressure.

- Simple volume flow adjustment by moving the adjustment unit. This does not affect the functionality of other system inlets and outlets.
- Automatic compensation for pressure fluctuations.
- Installation within seconds.
- Made of flame retardant plastic, class B1, DIN 4102-1.

Function

- In case of increasing pressure, the flow velocity will increase. The pressure against the control shutter reduces the opening cross-section and thus maintains the volume flow.
- In case of minimal static pressure, the control shutter will open to the full opening cross-section.
- The guide cylinder ensures the even movement of the shutter and thus controls the ratio of pressure to volume flow.

Installation

- Simple insertion into vertical or horizontal ducts with the matching standard diameter.
- The direction arrow for the flow direction must be observed.
- The precision fit and tightness to the inner duct circumference are ensured by the rubber seal ring.

Installation extract air Outlet = 1 x D

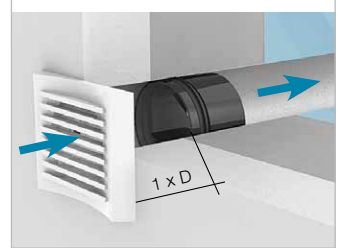

Installation supply air Outlet = 3 x D

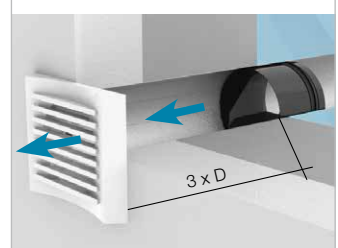

Product range	Dimensions in mm			Volume flow range m³/h
	Ø duct ND	Ø D	L	
VKH 80	80	76	55	15-50
VKH 100	100	96	70	15-100
VKH 125	125	120	86	100-180
VKH 150-160	150 - 160	146	91	180-300
VKH 200	200	190	91	300-500
VKH 250	250	245	127	500-700

Selection table m³/h	Ø 80	Ø 100	Ø 125	Ø 150 – 160	Ø 200	Ø 250
	15-50	80/15-50	100/15-50	125/15-50		
50-100		100/50-100	125/50-100	150-160/50-100		
100-180			125/100-180	150-160/100-180	200/100-180	
180-300				150-160/180-300	200/180-300	250/180-300
300-500					200/300-500	250/300-500
500-700						250/500-700

Design

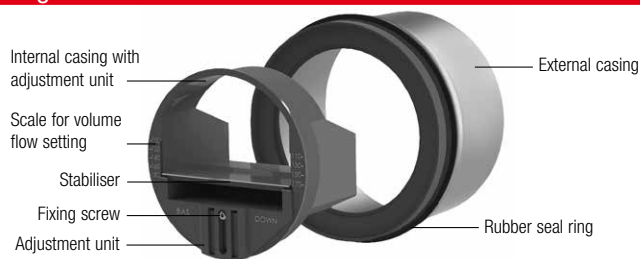

Ø 80 mm duct ND

Ref. no.	Type	Volume flow* m³/h	Noise L _w in dB(A) at			
			50 Pa	100 Pa	150 Pa	250 Pa
00001	VKH 80/15-50	15-50	25	29	32	35

* Tolerance range (50-250 Pa) for nominal volume flow +/- 10%.

Performance curves VKH 80

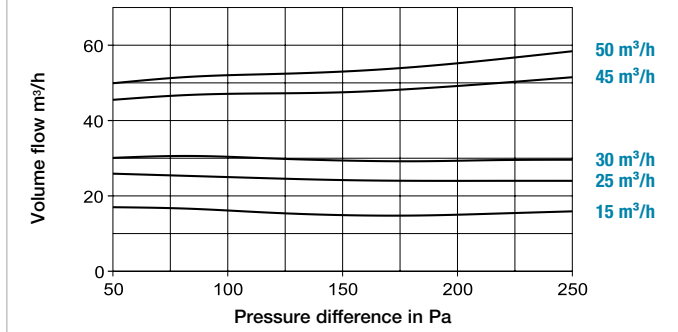

Ø 125 mm duct ND

Ref. no.	Type	Volume flow* m³/h	Noise L _w in dB(A) at			
			50 Pa	100 Pa	150 Pa	250 Pa
00004	VKH 125/15-50	15-50	25	29	32	35
00005	VKH 125/15-100	15-100	32	37	39	42
00006	VKH 125/100-180	100-180	30	37	39	42

* Tolerance range (50-250 Pa) for nominal volume flow +/- 10%.

Performance curves VKH 125

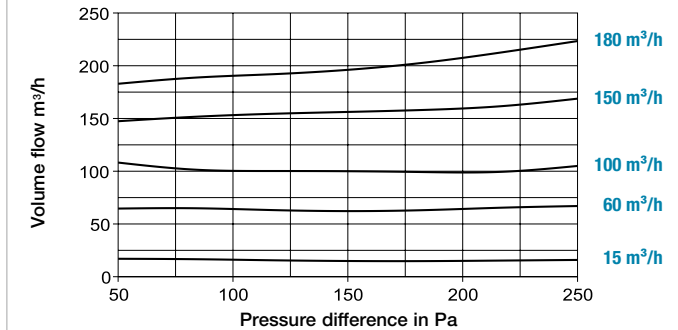

Ø 200 mm duct ND

Ref. no.	Type	Volume flow* m³/h	Noise L _w in dB(A) at			
			50 Pa	100 Pa	150 Pa	250 Pa
00010	VKH 200/100-180	100-180	30	37	39	42
00011	VKH 200/180-300	180-300	34	40	42	44
00012	VKH 200/300-500	300-500	35	40	44	47

* Tolerance range (50-250 Pa) for nominal volume flow +/- 10%.

Performance curves VKH 200

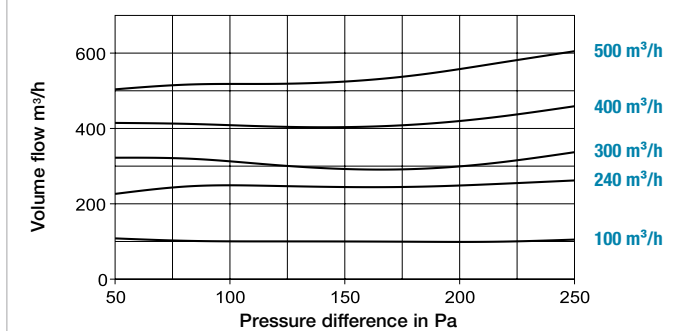

Ø 100 mm duct ND

Ref. no.	Type	Volume flow* m³/h	Noise L _w in dB(A) at			
			50 Pa	100 Pa	150 Pa	250 Pa
00002	VKH 100/15-50	15-50	25	29	32	35
00003	VKH 100/50-50	50-100	32	37	39	42

* Tolerance range (50-250 Pa) for nominal volume flow +/- 10%.

Performance curves VKH 100

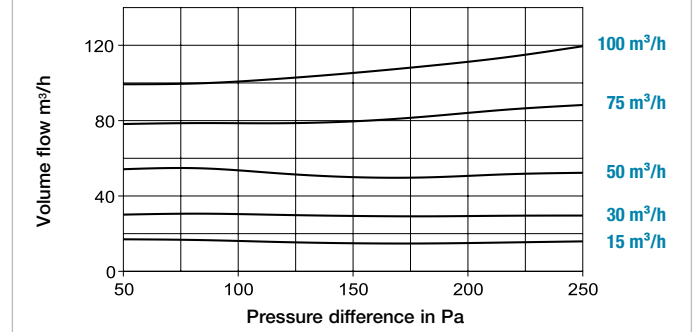

Ø 150-160 mm duct ND

Ref. no.	Type	Volume flow* m³/h	Noise L _w in dB(A) at			
			50 Pa	100 Pa	150 Pa	250 Pa
00007	VKH 150-160/50-100	50-100	32	37	39	42
00008	VKH 150-160/100-180	100-180	30	37	39	42
00009	VKH 150-160/180-300	180-300	34	40	42	44

* Tolerance range (50-250 Pa) for nominal volume flow +/- 10%.

Performance curves VKH 150-160

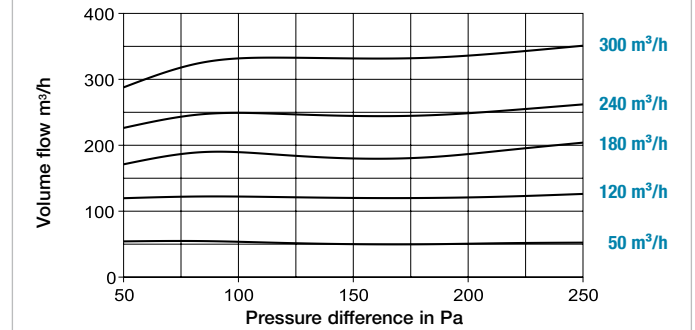

Ø 250 mm duct ND

Ref. no.	Type	Volume flow* m³/h	Noise L _w in dB(A) at			
			50 Pa	100 Pa	150 Pa	250 Pa
00013	VKH 250/180-300	180-300	30	37	39	42
00014	VKH 250/300-500	300-500	35	40	44	47
00015	VKH 250/500-700	500-700	36	40	46	49

* Tolerance range (50-250 Pa) for nominal volume flow +/- 10%.

Performance curves VKH 250

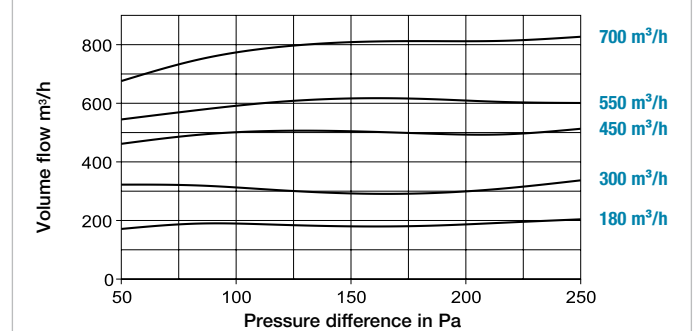

The ideal solution. For any type of room and application.



■ Extract air elements

Along with the fan, extract air elements form the basis for needs-optimised functionality in central ventilation systems.

Equipped with varying air volume flows or time, motion and humidity controls, the innovative extract air elements AE from Helios meet these requirements perfectly.

567^f

■ Filter elements, silencers

Attachment filter elements prevent grease and dust deposits on extract air elements and disc valves as well as inside the duct system.

Plug-in cross talk silencers reduce the noise level from the duct system and the cross talk from one residential unit to another.

570^f

■ Ventilation valves, disc valves

The multiple award-winning design ventilation valves DLV integrate elegantly and unobtrusively in any living environment.

Conventional disc valves for extract and supply air operation are ideal for various industrial and commercial applications.

572^f

■ Intake air elements

The planned, standard air inflow is best met with intake air elements.

The number, dimensioning and positioning of the elements should be determined so that the required regulated volumes can flow in without draughts.

In accordance with DIN 1946-6, it should be noted that a room underpressure of approx. 8 Pa in comparison to outside is not exceeded for the dimensioning of intake air elements.

578^f

Selection

Extract air elements only fulfil the required function optimally when they are matched to the task.

The following table should help you make the right choice of elements depending on the type of room and function.

There is a choice of elements with constant volume flow, with and without demand-controlled ventilation, with time, motion or humidity controls.

Bathroom		WC		Kitchen	
Type	Ref. no.	Type	Ref. no.	Type	Ref. no.
Volume flow stabilisation, self-regulating					
AE 45*	02031	AE 30*	02030	AE 75*	02033
Two volume flows, (demand-controlled and basic ventilation), volume flow stabilisation, self-regul.					
AE GB 20/75*	02036	AE GB 15/30*	02035	AE GB 45/120*	02038
With electr. time control and two volume flows (without volume flow stabilisation)					
AE GBE 30/60*	02047	AE GBE 15/30*	02044	AE GBE 45/120*	02048
With motion sensor, electr. time control and two volume flows					
		AE B 15/30*	02055	(without volume flow stabilisation)	
Humidity-controlled with variable, limited volume flow					
AE Hygro 10/45*	02049				
Humidity-controlled with electrically controlled demand-controlled ventilation level					
AE Hygro GBE 5/40/75*	02053			AE Hygro GBE 10/45/120*	02054
With filter and volume adjustment					
AE FV 125	09478			AE FV 125	09478

* Volume flow in m³/h

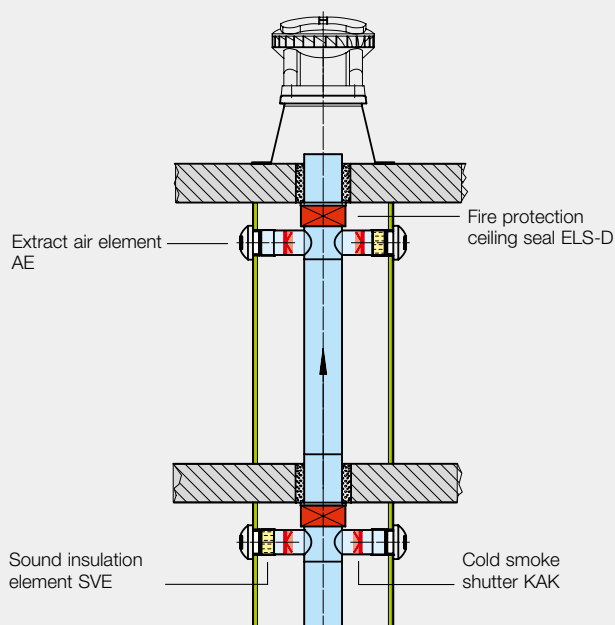

Acoustic data for extract air elements in series AE

The following noise data is relevant for the extract air elements:

- Sound power with permanent throughflow (L_w in dB (A))
- Sound insulation between duct system and room to be ventilated ($D_{n,e}$ in dB (A)).

This noise data is specified in the respective type table.

It has been measured according to standard EN 13141. The sound insulation value can be increased by using duct silencers "AESD" or "AESE" (accessories). These are positioned and easily inserted downstream of the extract air element.

Cross talk silencers (p. 571) are available for further noise reduction.

AE



Advantages

- Constant volume flow between 40 and 160 Pa.
- No need for system adjustment or calibration.
- Attractive design.
- High-quality construction in aerodynamic design with low noise levels.
- Cover and optimised height of the inlet ring prevent dirty marks.
- Easy cleaning without the risk of changes in air volume.

Design

Ready-to-install extract air element with mounting ring, made of white plastic, for insertion in ducts ND 125 mm. Lip seal on mounting ring to prevent air leakage from the side. Contamination of the surrounding environment is thereby minimised.

Function

Ensures constant volume flow in different pressure conditions between 40 and 160 Pa.

Delivery

Each element incl. mounting ring in separate polybag.

Accessories

- Silencer AESD for insertion downstream of the element (Ref. no. 02059).
- Attachment filter element VFE 70 (Ref. no. 02552).

Installation

Suitable for wall and ceiling installation. Attach mounting ring to duct or wall opening using screws and insert extract air element.

A straight duct section of at least 300 mm is required for uniform inflow and outflow.

Dimensions AE

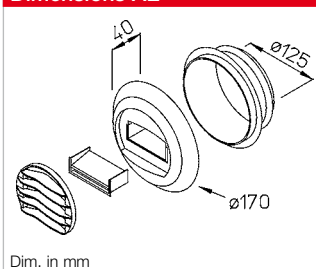

Application

Extract air elements with self-regulating volume flow stabilisation are ideal components for the ventilation of kitchens, bathrooms and toilets for central ventilation systems in residential constructions.

Volume flow performance curve AE

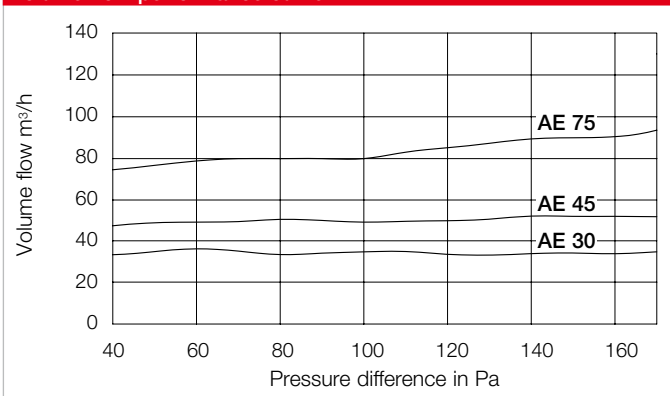

Order data		Sound power			Sound insulation	
Type	Ref. no.	L_w in dB (A)			$D_{n,e}$ in dB (A)	
		100 Pa	130 Pa	160 Pa	w/o AESD	w/ AESD
AE 30*	02030	30	33	36	60	64 ¹⁾
AE 45*	02031	33	34	37	56	63 ¹⁾
AE 75*	02033	35	36	39	57	64 ¹⁾

¹⁾ Equipped with silencer AESD (accessories). * Volume flows in m³/h.

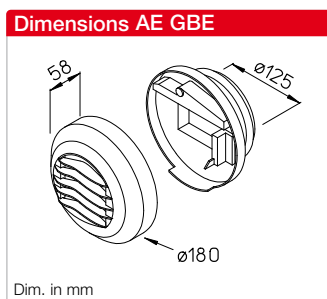
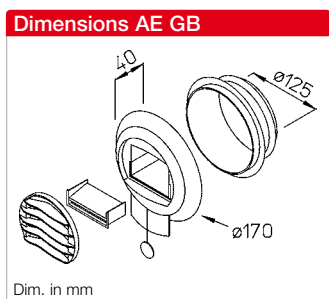

Application
Extract air elements for two volume flows (demand-controlled and basic ventilation) with self-regulating volume flow stabilisation are ideal components for the ventilation of kitchens, bathrooms and toilets for central ventilation systems in residential buildings.

Advantages

- Two volume flows for basic and demand-controlled ventilation.
- Constant volume flow between 40 and 160 Pa.
- No need for system adjustment or calibration.
- Attractive design.
- High-quality construction in aerodynamic design with

low noise levels.

- Cover and optimised height of the inlet ring prevent dirty marks.
- Easy cleaning without the risk of changes in air volume.

Function AE GB
The self-regulating volume flow limitation maintains the set nominal volume (between 40 and 160 Pa) (see performance diagram).
Two levels allow basic and demand-controlled ventilation. Manual setting and resetting of the high volume flow via draw-cord.

Design (AE GB, AE GBE)
Ready-to-install extract air element with mounting ring, made of white plastic, for insertion in ducts ND 125 mm. Lip seal on mounting ring to prevent air leakage from the side. Contamination of the surrounding environment is thereby minimised.

Installation (AE GB, AE GBE)
AE GB suitable for wall installation, AE GBE also for ceiling installation. Attach mounting ring or base body to duct or wall opening using screws, insert extract air element. A straight duct section of at least 300 mm is required for uniform inflow and outflow.

Accessories

- Silencer:
AE GB: AESD, Ref. no. 02059.
AE GBE: AESE, Ref. no. 02058.
- Attachment filter element
AE GBE: VFE 90, Ref. no. 02553. Prevents grease and dust deposits on extract air elements and inside the duct system.

Application
Extract air element with electric time control for two volume flows (demand-controlled and basic ventilation).
Ideal for the ventilation of kitchens, bathrooms and toilets for central ventilation systems in residential buildings.

Advantages

- Two volume flows for basic and demand-controlled ventilation e.g. via on-site switch.
- No need for system adjustment or calibration.
- Attractive design.
- High-quality construction in aerodynamic design with low noise levels.
- Cover and optimised height of the inlet ring prevent dirty marks.
- Easy cleaning without the risk of changes in air volume.

Function AE GBE
The basic volume flow is increased to the demand-controlled volume flow via an on-site switch. Resets to "basic ventilation" after 30 minutes, regardless of the position of the on-site switch.

Delivery
Each element incl. mounting ring in separate polybag.

Upon request

AE FV 125
Extract air element with filter and volume setting, Ref. no. 09478.

Volume flow performance curves AE GB Nominal volume flow (m³/h)

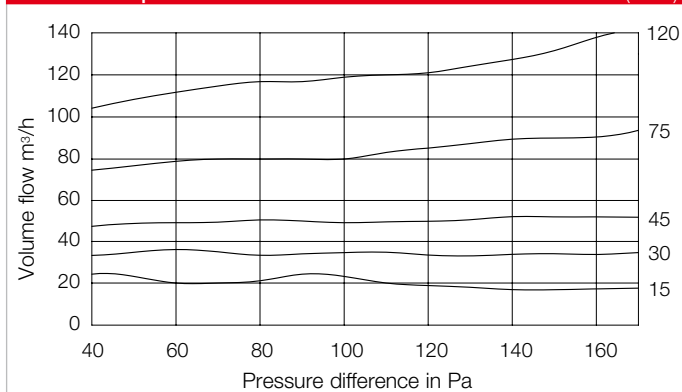

Volume flow performance curves AE GBE Nom. volume flow (m³/h)

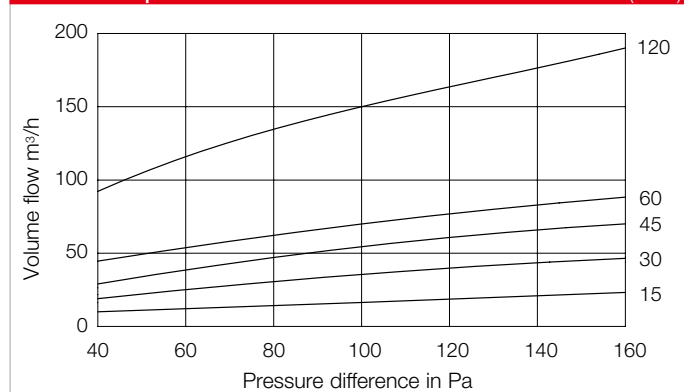

Order data		Sound power ³⁾			Sound insulation	
Type	Ref. no.	L _w in dB (A)			D _{n,e} in dB (A)	
		100 Pa	130 Pa	160 Pa	w/o AESD	w/ AESD
AE GB 15/30*	02035	27	31	34	60	64 ¹⁾
AE GB 20/75*	02036	27	30	33	57	64 ¹⁾
AE GB 45/120*	02038	33	34	37	56	63 ¹⁾

Order data		Sound power ³⁾			Sound insulation	
Type	Ref. no.	L _w in dB (A)			D _{n,e} in dB (A)	
		100 Pa	130 Pa	160 Pa	w/o AESD	w/ AESD
AE GBE 15/30*	02044	30	33	36	60	64 ²⁾
AE GBE 30/60*	02047	27	30	33	57	64 ²⁾
AE GBE 45/120*	02048	29	32	35	57	62 ²⁾

¹⁾ Equipped with silencer AESD (accessories). ²⁾ Equipped with silencer AESE (accessories). ³⁾ Values apply for basic ventilation level. * Volume flows in m³/h.

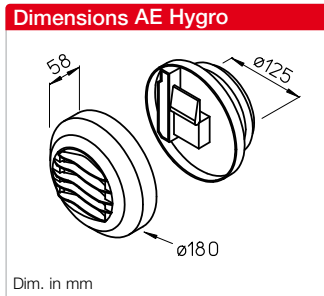
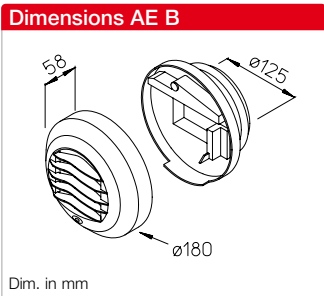

Application

Extract air element with motion sensor and time control for two volume flows (demand-controlled and basic ventilation). Ideal for the ventilation of toilets for central ventilation systems in residential buildings.

Advantages

- Two volume flows for basic and demand-controlled ventilation via integrated motion sensor.
- No need for system adjustment or calibration.
- Attractive design.
- High-quality construction in aerodynamic design with low noise levels.

- Cover and optimised height of the inlet ring prevent dirty marks.
- Easy cleaning without the risk of changes in air volume.

Design

Ready-to-install extract air element with mounting ring, made of white plastic, for insertion in ducts ND 125 mm. Lip seal on mounting ring to prevent air leakage from the side. Contamination of the surrounding environment is thereby minimised.

Function AE B

The basic volume flow is increased to the demand-controlled volume flow after the response of the integrated motion sensor. Resets to "basic ventilation" after 30 minutes. Electrical power supply through two batteries (on-site, type LR6/AA (1.5 V), service life approx. 18 months).

Application

The hygrostatically controlled extract air elements allow a variable volume flow depending on the relative room humidity. They are ideal for controlling the extract air volume in bathrooms and kitchens for central ventilation systems in residential buildings.

Advantages

- Volume flow automatically controlled between the minimum and maximum limits depending on the relative room humidity.
- No need for system adjustment or calibration.
- Attractive design.
- High-quality construction in aerodynamic design with low noise levels.
- Cover and optimised height of the inlet ring prevent dirty marks.
- Easy cleaning without the risk of changes in air volume.

Delivery and installation

See description Type AE GB.

Accessories

- Silencer AESE for insertion downstream of the element (Ref. no. 02058).

Design, delivery and installation

See description Type AE GB.

Function AE Hygro

The volume flow is automatically controlled between the minimum and maximum limits depending on the relative room humidity. Realisation of the defined basic volume flow at Δp of 80 Pa depending on the relative room humidity. No electrical connection necessary.

Additional function AE Hygro GBE

The basic volume flow is increased to the demand-controlled volume flow via an on-site switch. Resets to "basic ventilation" after 30 minutes, regardless of the position of the on-site switch.

230 V, AC 0.5/3 W, IPX1

Accessories

- Silencer AESE for insertion downstream of the element (Ref. no. 02058).
- Attachment filter element VFE 90 for insertion upstream of the element (Ref. no. 02553).

Volume flow performance curve AE B Nominal volume flow (m³/h)

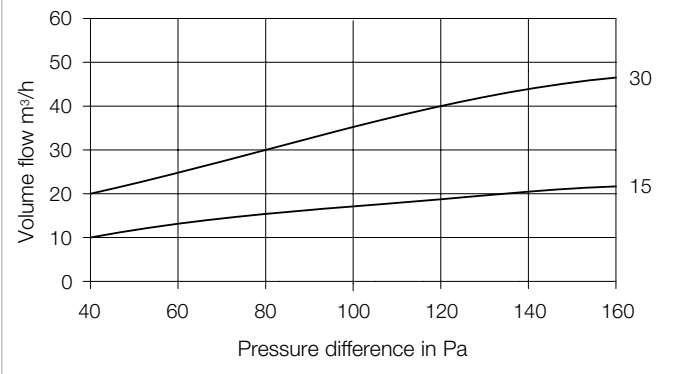

Operating range AE Hygro

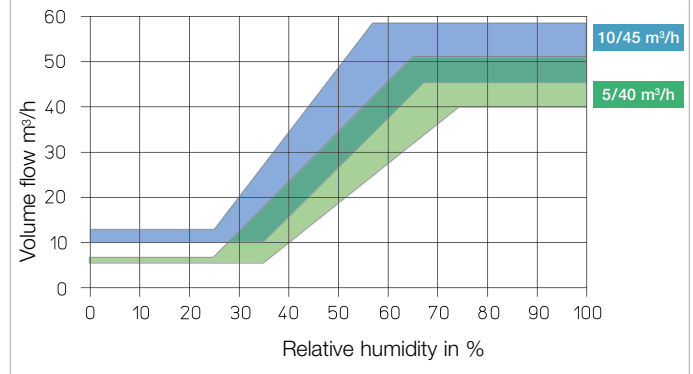

Order data		Sound power ³⁾			Sound insulation	
Type	Ref. no.	L _w in dB (A)			D _{n,e} in dB (A)	
		100 Pa	130 Pa	160 Pa	w/o AESD	w/ AESD
AE B 15/30*	02055	20	25	28	60	64 ¹⁾

Order data		Sound power ³⁾			Sound insulation	
Type	Ref. no.	L _w in dB (A)			D _{n,e} in dB (A)	
		100 Pa	130 Pa	160 Pa	w/o AESD	w/ AESD
AE Hygro 10/45*	02049	29	32	35	57	61 ²⁾
AE Hygro GBE 5/40/75 ⁴⁾ *	02053	28	31	34	56	64 ²⁾
AE Hygro GBE 10/45/120 ⁴⁾ *	02054	29	32	35	56	62 ²⁾

¹⁾ Equipped with silencer AESD (accessories). ²⁾ Equipped with silencer AESE (accessories). ³⁾ Values apply for basic ventilation level. ⁴⁾ Demand-control. vent. performance curve see AE GBE left page. * Volume flows in m³/h.

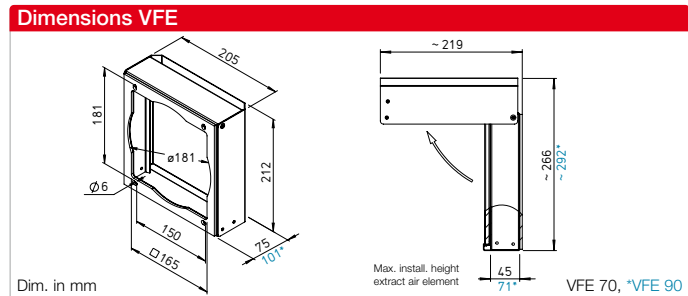
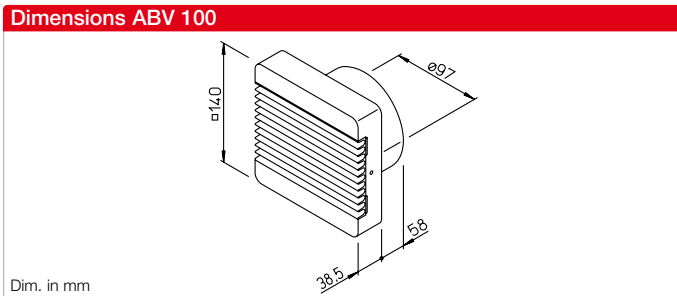

AbluVent ABV 100

Can be used in central ventilation systems according to DIN 18017-3 with variable volume flow in residential buildings. For the demand-controlled ventilation e.g. of windowless bathrooms and WCs. All elements in the system must be the same type and design. Made of high-quality plastic, colour: white.

Function

AbluVent is operated via the light switch. The blades open when the room is occupied. Basic ventilation is also guaranteed when the room is not occupied, since a minimum air flow rate is provided by the closed blades.

Advantages

- Energy saving.
- Low price.
- Rapid installation.
- Always the optimal solution.
- Shutter delay of approx. 5 minutes.
- Continuously variable volume flow setting.
- Silent function.
- Replaceable filter prevents clogging of the ventilation duct.

Volume throughput

The blade opening angle can be variably adjusted using a slider (covered by the facade) in the range from 15 – 80 degrees.

ABV Volume adjustment

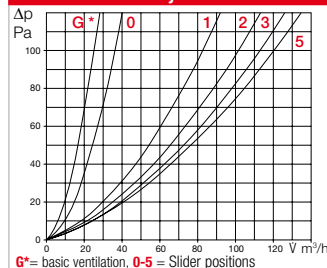

The throughflow depending on the setting and underpressure is shown in the diagram above.

Technical data – Connection

Control via commercially available on/off switch, preferably coupled with the light switch. Operating voltage: ~220/240 V, 3 W. Insulated, radio interference-free, protection category IP44. Casing: Plastic, alpine white. The thermo-metal spring causes a short switching delay when opening (approx. 30 sec.) and time-delayed closing after deactivation (approx. 5 min.). With ISO Coarse 30% filter.

ABV 100 Ref. no. 00452

Accessories

Replacement filter mats

ISO Coarse 30% unit = 5 pcs
ELF/ABV Ref. no. 06906

Attachment filter element VFE

Simple and cost-effective solution for filtering greasy, contaminated room air. For installation upstream of extract air elements or disc valves.

Application

Filter element for covering ventilation openings and preventing dirt deposits on disc valves, extract air elements and connected duct systems. Ideal for use in domestic kitchens with central ventilation systems according to DIN 18017.

Advantages

- Prevents grease and dust deposits on extract air elements or disc valves and connected duct systems.
- Filter change in just a few simple steps.
- Permanent filter can be cleaned in the dishwasher.
- Unobtrusive design in pleasant white.
- Easy installation using four screws.
- Conceals possible clogging zones.
- Lower maintenance costs for duct systems due to extended cleaning intervals.

Casing

Robust casing made of galvanised steel sheet, white, plastic powder-coated. The 90° retractable front panel prevents the view of the filter and clogging zone.

Filter

Dimensionally stable aluminium filter fabric with 295 cm² free filter surface and aluminium frame.

VFE Pressure loss in pure state

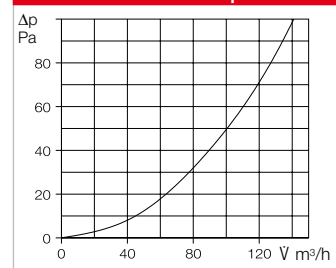

Installation

Suitable for wall and ceiling installation. Simple attachment with four screws. Long slot attachment points allow simple perpendicular adjustment. Attachment directly upstream of the installed extract air element (max. external Ø 180 mm). Front panel is 90° retractable; there should be free space between the upper edge of the casing and ceiling (see dimensional drawing) for easy filter removal.

Delivery

Each element incl. installation accessories individually packed.

Product range

VFE 70 Ref. no. 02552

Compatible with extract air elements with max. 45 mm installation depth, such as e.g. AE, MTVA, KTVA, BTV, BTK.

VFE 90 Ref. no. 02553

Compatible with extract air elements with max. 71 mm installation depth, such as e.g. AE GBE, AE Hygro.

Accessories

ELF/VFE Ref. no. 02554

Replacement air filter, compatible with types VFE 70 and VFE 90. Unit = 2 pcs.

ETS



Installation example Cross talk silencer ETS (cut open)

Dimensions ETS

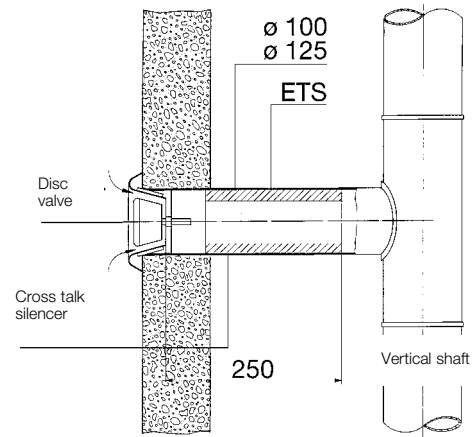

Dimensions in mm

Surprisingly simple and cost-effective solution for reducing cross talk sound transmissions in central ventilation systems. Easy installation directly downstream of the disc valve in the duct.

Advantages

- Optimal solution for preventing sound transmissions through ventilation ducts or pipes.
- Excellent damping values pursuant to the diagram.
- Easy installation through insertion into the duct downstream of the disc valve.
- No increase in system resistance since the resistance value is below the set value of a disc valve.
- Minimisation of system construction costs due to the use of cost-effective duct systems.
- Can be used with disc valves from any manufacturer.

Vertical system section

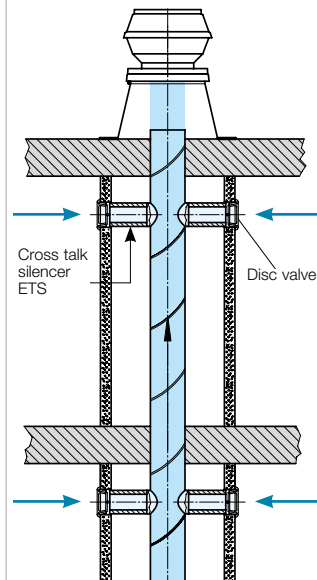

Horizontal system section

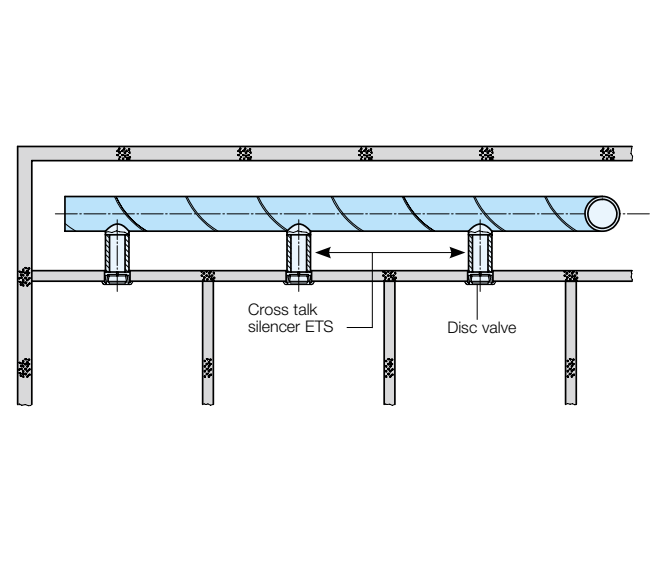

Product range

- ETS 100** Ref. no. 04521
Nominal duct size Ø 100 mm
- ETS 125** Ref. no. 04522
Nominal duct size Ø 125 mm

Damping values

Damping values should be doubled before cross talk sound transmissions from room to room if each opening is equipped with an ETS.

Material

Open-cell foam with improved behaviour in case of fire, complies with DIN 4102, class B1.

Type	Ref. no.	Insertion loss D_e dB at Hz							
		63	125	250	500	1000	2000	4000	8000
MTVZ 100	09604	5	6	6	7	8	9	11	11
MTVZ 100 + ETS 100	09604 + 04521	7	7	8	9	14	22	35	28
MTVA 100	08869	5	6	6	7	7	8	10	13
MTVA 100 + ETS 100	08869 + 04521	7	7	8	9	14	20	37	34
MTVZ 125	09605	5	5	6	7	8	8	11	12
MTVZ 125 + ETS 125	09605 + 04522	6	7	8	10	15	23	33	26
MTVA 125	08870	5	5	6	6	8	8	9	12
MTVA 125 + ETS 125	08870 + 04522	6	7	8	10	14	21	32	26

DLVZ



Dimensions DLVZ

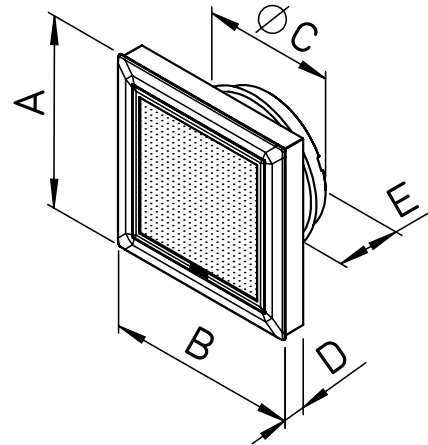

Dim. in mm see table

Application

For supply air operation in all rooms without specific fire protection requirements. Ideal for wall installation near the ceiling with air flow into the room.

Advantages

- Elegant, square casing made of high-quality plastic.
- Even flowing cone of air to the middle of the room.
- Includes mechanically adjustable volume controller for calibrating the ventilation system. Accessible by removing the casing, with adjustment markers (steps 0–9, see diagram).
- Casing can be removed without tools for easy cleaning of the air cooled valve parts.
- Sealing ring on duct connector for exact positioning and sealing in the duct, prevents dirt marks on the wall.
- Mounting holes in lower part of casing for secure attachment.

Design

Casing design made of white, break-resistant plastic.

Delivery

Valve individually packed in polybag, includes adjustment set (can be mounted if required) as well as installation and operating instructions.

Installation

- Mount volume controller if necessary. Air volume presets according to diagram.
- Position lower part of casing in ventilation duct and fix to wall.
- Adjust air volume setting if necessary when adjusting the entire system.
- Upper part of casing can be attached without tools.

Performance data

The diagrams provide an overview of the air volumes and pressure losses at various volume controller settings as well as the flow velocity of the outflowing air at 30 m³/h depending on the valve distance.

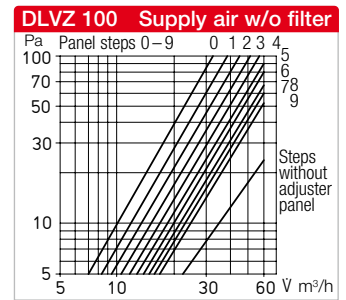

Performance curves DLVZ 100

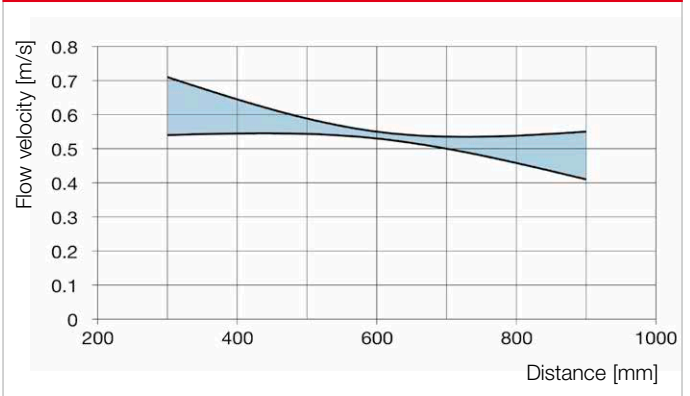

Order data	
Type	DLVZ 100
Ref. no.	03040
Ø C mm	100
A mm	135
B mm	135
D mm	20
E mm	38
Weight in g	150

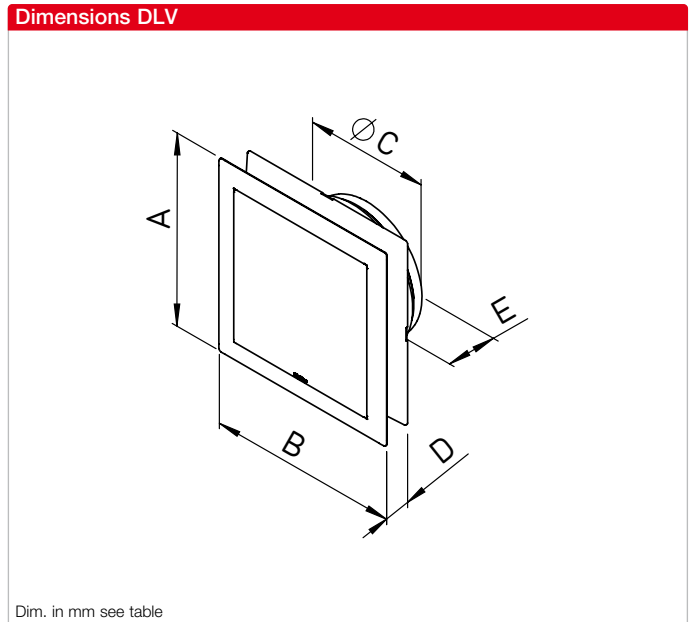

Application

For supply air and extract air operation in all rooms without specific fire protection requirements. Ideal for ceiling installation.

Advantages

- Elegant, square casing made of high-quality plastic with concealed air inlet and outlet area.
- Exact air volume adjustment by turning the elegant front panel in 90° steps, with adjustment markers for calibrating the ventilation system.
- Integrated filter can be replaced without tools and without risk of changing the setting.
- Selected air volume setting can be locked.
- Minimum air volume guaranteed, even with a fully closed air volume setting. Complete closure is only possible by irreversibly removing the minimum air volume stop.
- Front panel can be removed without tools, with adjustment mechanism and filter holder for easy cleaning of the air cooled valve parts.
- Sealing ring on duct connector for exact positioning and sealing in the duct.
- Mounting holes in lower part of casing for secure attachment to the ceiling.

Design

Casing design made of white, break-resistant plastic. Elegant square design with closed front panel.

Delivery

Valve individually packed in polybag, includes ISO Coarse 30% (G2) filter, installation and operating instructions.

Installation

- Insert ISO Coarse 30% (G2) filter in the filter holder.
- Air volume presets according to diagram.
- Position lower part of casing in ventilation duct and fix to ceiling.
- Adjust air volume setting if necessary when adjusting the entire system.
- Front panel with adjustment mechanism and filter holder can be attached without tools.

Performance data

The diagrams provide an overview of the air volumes and pressure losses at various front panel settings as well as the flow velocity of the outflowing air at 30 m³/h (DLV 100) or 60 m³/h (DLV 125) depending on the valve distance.

Accessories

Replacement air filter class ISO Coarse 30% (G2)

Unit = 5 pcs.

ELF-DLV 100 Ref. no. 03042

ELF-DLV 125 Ref. no. 03058

Order data		
Type	DLV 100	DLV 125
Ref. no.	03039	03049
Ø C mm	100	125
A mm	135	176.5
B mm	135	176.5
D mm	10 – 30	15 – 30
E mm	38	41
Weight in g	150	210

DLV 100 Extract air w/o filter

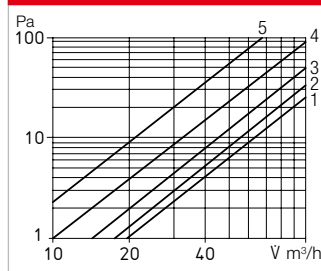

DLV 100 Supply air w/o filter

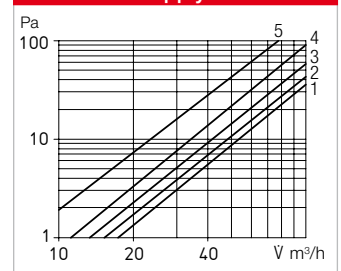

DLV 125 Extract air w/o filter

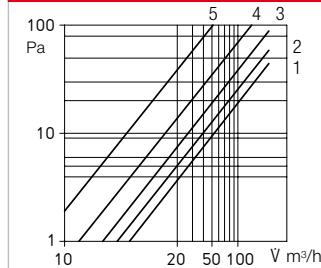

DLV 125 Supply air w/o filter

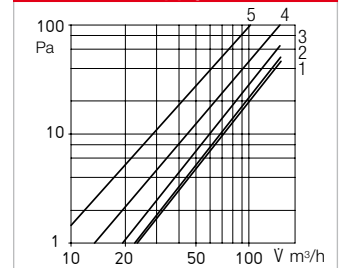

Performance curve DLV 100 – DLV 125

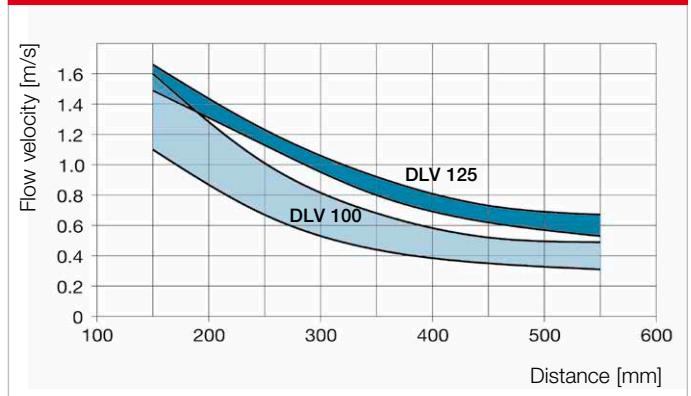

MTVA



Dimensions MTVA

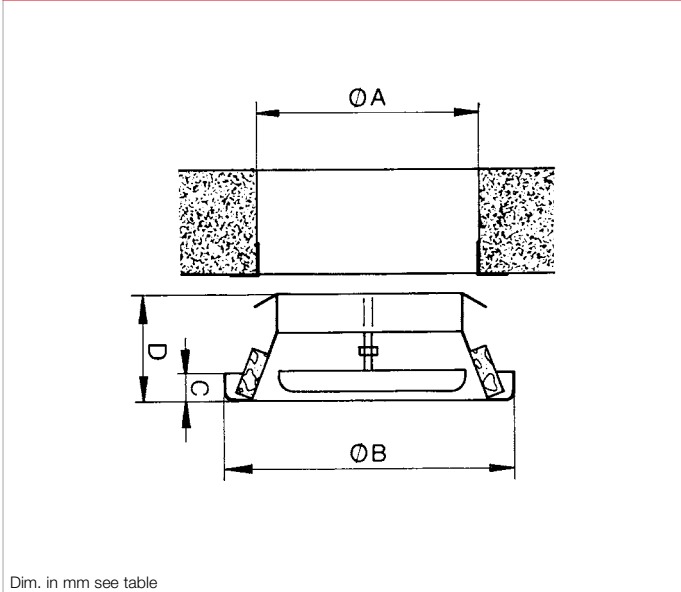

Application

For extract air operation in rooms of any kind and especially where ventilation components made of non-combustible material are stipulated. Can be used for low to high flow velocities. Low-noise.

Airtight closure of the opening circumferential foam ring to prevent air leakage from the side. Contamination of the surrounding environment is thereby prevented.

Advantages

- High-quality metal design in aerodynamic form with low noise levels.
- Wide cover and optimised height of the inlet ring prevent dirty marks.
- Installation in ceilings and walls within seconds and without tools.
- Plaster and difference compensation in case of unevenness, diameter differences or ducts that have been mounted too deep.
- Clamp spring holder allows direct insertion in ducts or walls with thickness of approx. 20 mm or more without additional mounting ring.

Delivery

Each valve in separate polybag.

Accessories

Mounting rings (see table) are required for installation in sheet metal duct walls and thin panels.

Installation

Set to desired volume flow pursuant to diagrams above. Distance "A" is specified in mm from the origin. Valve insertion in duct or wall opening.

Performance data

The diagrams provide an overview of the air volumes, resistances and noise levels at corresponding settings for distance "A" in mm.

Design

Metal design with high-quality finish in white. Protected against corrosion with epoxy powder coating.

Volume adjustment

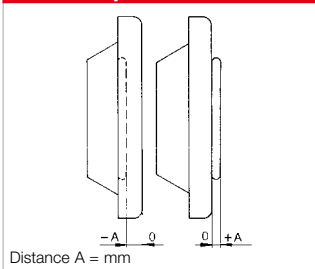

MTVA 125

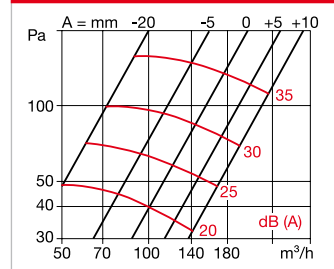

MTVA 75/80

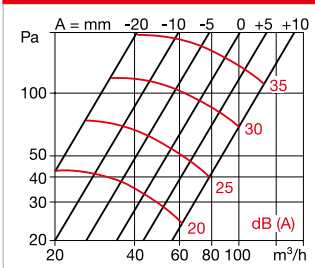

MTVA 160

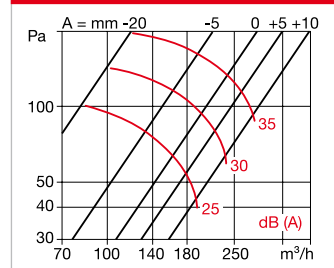

MTVA 100

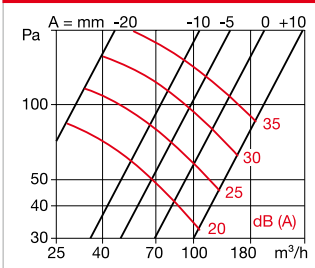

MTVA 200

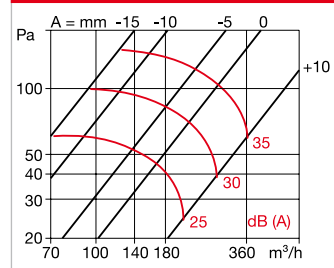

Order data

Type	MTVA 75/80	MTVA 100	MTVA 125	MTVA 160	MTVA 200
Ref. no.	08868	08869	08870	08871	08872
Ø A mm	73 – 85	95 – 105	120 – 130	150 – 165	195 – 205
Ø B mm	108	135	160	195	230
C mm	15	15	15	15	18
D mm	58	59	60	58	63
Weight in g	150	190	255	340	450

Mounting ring

Type	EBR 75/80	EBR 100	EBR 125	EBR 160	EBR 200
Ref. no.	00952	00953	00954	00955	00956
for NW (mm)	75/80	100	125	150/160	200

KTVA



Dimensions KTVA

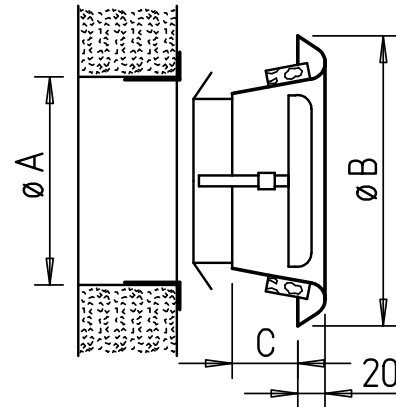

Dim. in mm see table

■ Application

For extract air operation at high and low flow velocities or resistances. In all rooms without specific fire protection requirements.

■ Advantages

- Installation in ceilings and walls within seconds and without tools.
- Good sound insulation due to built-in silencers in the valve disc.
- Made of high-quality, antistatic plastic, applicable up to +100 °C.
- Circumferential spacer ring prevents dirt deposits.
- Plaster and difference compensation in case of unevenness, diameter differences or ducts that have been mounted too deep.
- Clamp spring holder allows direct insertion in ducts or walls with thickness of approx. 20 mm or more without additional mounting ring.

■ Design

All-plastic design made of white, break-resistant plastic. Elegant, aerodynamic design. Volume adjustment using rotatable valve disc (see diagrams for volume throughput).

■ Delivery

Each valve in separate polybag.

■ Accessories

Mounting rings (see table) are required for installation in sheet metal duct walls and thin panels.

■ Installation

Set to desired volume flow with corresponding number of disc rotations according to the diagram. Valve insertion in duct or wall openings.

■ Performance data

The diagrams provide an overview of the air volumes, resistances and noise levels with the corresponding disc rotations.

KTVA 75/80 Disc rotations

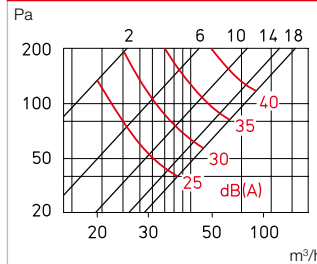

KTVA 125 Disc rotations

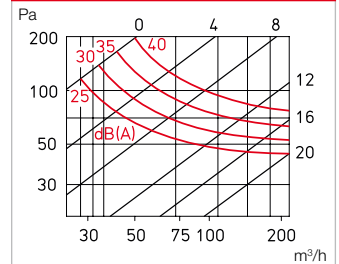

KTVA 100 Disc rotations

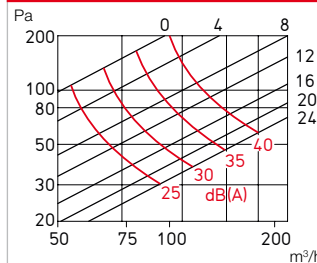

KTVA 160 Disc rotations

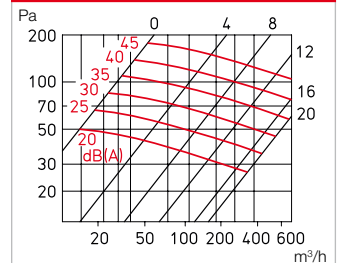

KTVA 200 Disc rotations

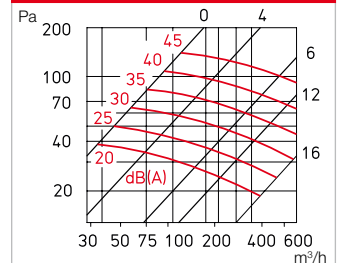

Order data

Type	KTVA 75/80	KTVA 100	KTVA 125	KTVA 160	KTVA 200
Ref. no.	00940	00941	00942	00943	00944
Ø A mm	73 – 85	95 – 105	120 – 130	150 – 165	195 – 205
Ø B mm	118	140	165	200	242
C mm	40	40	40	42	45
Weight in g	90	115	150	200	340

Mounting ring

Type	EBR 75/80	EBR 100	EBR 125	EBR 160	EBR 200
Ref. no.	00952	00953	00954	00955	00956
for NW (mm)	75/80	100	125	150/160	200

MTVZ



Dimensions MTVZ

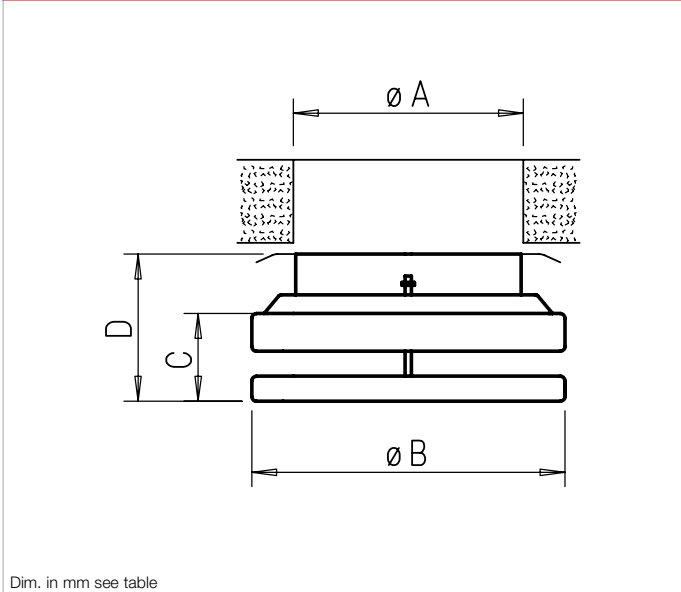

Application

For supply air operation in rooms of any kind and especially where ventilation components made of non-combustible material are stipulated. Can be used for low to high flow velocities. Low-noise.

Advantages

- High-quality metal design in aerodynamic form with low noise levels.
- Elegant valve disc concealing the opening for continuously variable adjustment.
- Installation in ceilings and walls within seconds and without tools.
- Plaster and difference compensation in case of unevenness, diameter differences or ducts that have been mounted too deep.
- Clamp spring holder allows direct insertion in ducts or walls with thickness of approx. 20 mm or more without additional mounting ring.

Design

Metal design with high-quality finish in white. Protected against corrosion with epoxy powder coating. Airtight closure of the opening circumferential foam

ring to prevent air leakage from the side. Contamination of the surrounding environment is thereby prevented.

Delivery

Each valve in separate polybag.

Accessories

Mounting rings (see table) are required for installation in sheet metal duct walls and thin panels.

Installation

Set to desired volume flow pursuant to adjacent diagram. Distance "A" is specified in mm from the origin. Valve insertion in duct or wall opening. A straight duct section of at least 300 mm is required for uniform throughflow.

Performance data

The diagrams provide an overview of the air volumes, resistances and noise levels at corresponding settings for distance "A" in mm.

Volume adjustment

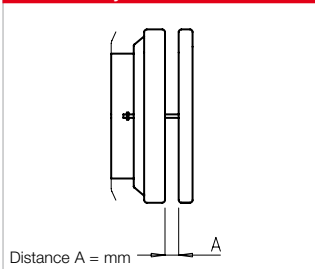

MTVZ 125

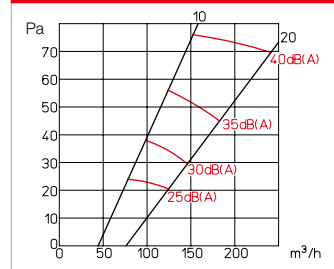

MTVZ 75/80

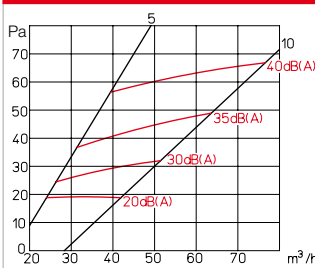

MTVZ 160

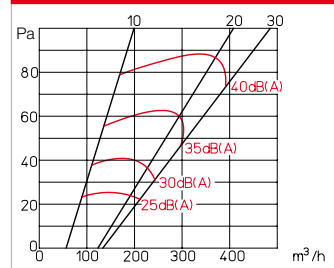

MTVZ 100

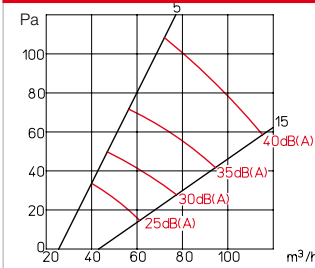

MTVZ 200

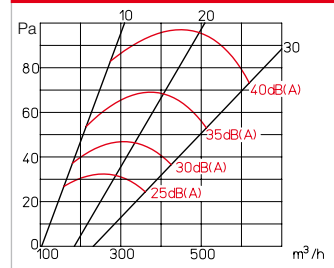

Order data

Type	MTVZ 75/80	MTVZ 100	MTVZ 125	MTVZ 160	MTVZ 200
Ref. no.	09603	09604	09605	09606	09607
Ø A mm	73 – 85	95 – 105	120 – 130	150 – 165	195 – 210
Ø B mm	108	135	160	195	230
C mm	26 – 46	26 – 46	26 – 46	26 – 56	26 – 56
D mm	68	70	70	68	73
Weight in g	190	240	300	390	480

Mounting ring

Type	EBR 75/80	EBR 100	EBR 125	EBR 160	EBR 200
Ref. no.	00952	00953	00954	00955	00956
for NW (mm)	75/80	100	125	150/160	200

KTVZ



Dimensions KTVZ

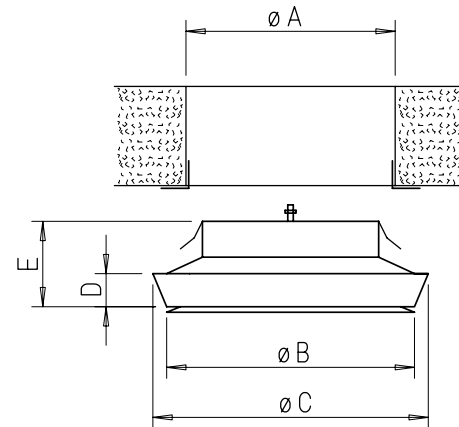

Dim. in mm see table

Application

For supply air operation at high and low flow velocities or resistances. In all rooms without specific fire protection requirements.

Advantages

- Installation in ceilings and walls within seconds and without tools.
- Elegant valve disc concealing the opening for continuously variable adjustment. Made of high-quality, white plastic, applicable up to +100 °C.
- Circumferential spacer ring prevents dirt deposits.
- Plaster and difference compensation in case of unevenness, diameter differences or ducts that have been mounted too deep.
- Clamp spring holder allows direct insertion in ducts or walls with thickness of approx. 20 mm or more without additional mounting ring.

Design

All-plastic design made of white, break-resistant plastic. Elegant, aerodynamic design. Volume adjustment using rotatable valve disc (see diagrams for volume throughput).

Delivery

Each valve in separate polybag.

Accessories

Mounting rings (see table) are required for installation in sheet metal duct walls and thin panels.

Installation

Set to desired volume flow with corresponding number of disc rotations according to the diagram.

Valve insertion in duct or wall openings.

A straight duct section of at least 300 mm is required for uniform throughflow.

The air flow can be directed in a defined direction e.g. just to the middle of the room through the selective insertion of the sealing elements included in the delivery.

Performance data

The diagrams (measured without sealing element) provide an overview of the air volumes, resistances and noise levels with the corresponding disc rotations.

KTVZ 80 Disc rotations

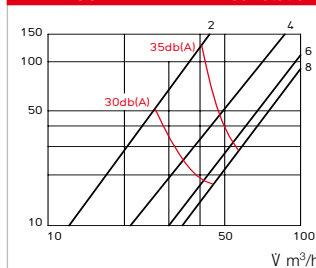

KTVZ 125 Disc rotations

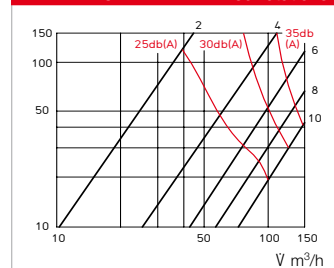

KTVZ 100 Disc rotations

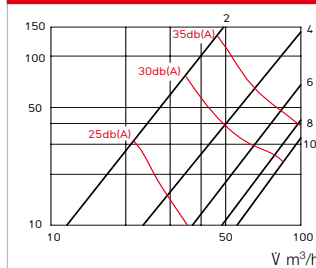

KTVZ 160 Disc rotations

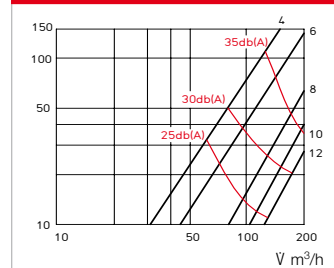

KTVZ 200 Disc rotations

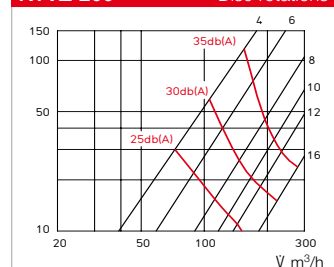

Order data

Type	KTVZ 80	KTVZ 100	KTVZ 125	KTVZ 160	KTVZ 200
Ref. no.	02762	02736	02737	02738	02739
Ø A mm	80	100	125	160	200
Ø B mm	115	135	160	195	235
Ø C mm	122	142	167	202	242
D mm	20	20	20	20	20
E mm	53	58	58	69	79
Weight in g	90	100	260	370	600
Mounting ring					
Type	EBR 75/80	EBR 100	EBR 125	EBR 160	EBR 200
Ref. no.	00952	00953	00954	00955	00956
for NW (mm)	75/80	100	125	150/160	200

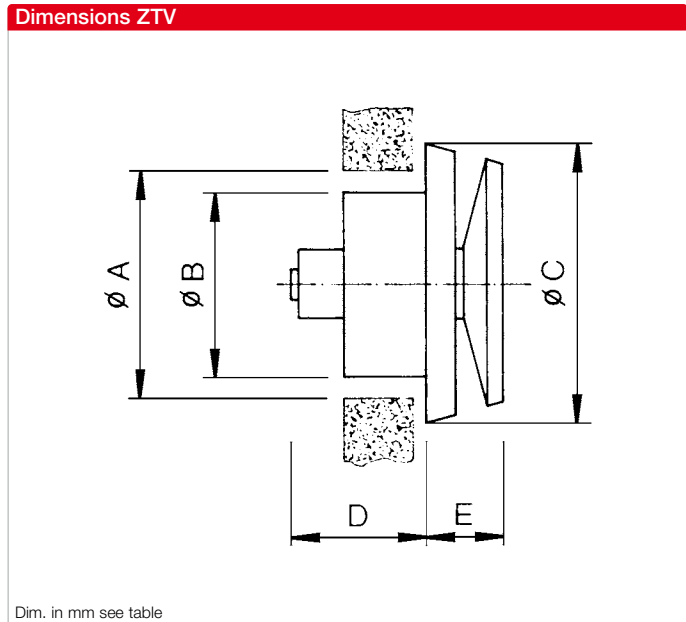

Special features – Application

Innovative thermostat supply air disc valve for self-regulating air exchange. Combines energy savings and constant ventilation with maximum efficiency. The constant supply air volume control with adjustable disc valve for rooms of any kind. Ideally suited for natural (thermal) ventilation and as a supply air element for mechanical ventilation.

Advantages

- Fully automated, demand-based supply air volume control.
- Completely maintenance-free and free of operating costs.
- Individual volume flow adjustment by rotating the disc.
- Good sound insulation due to built-in silencers in the valve disc.
- Attractive, functional design.
- Wide inlet ring covers unsightly dirt marks.
- Quick and easy installation.

Design

The Helios supply air thermostat valves are made of break-resistant, white plastic. Aerodynamic, elegant and unobtrusive design. Insulating coating of inside of valve disc to prevent condensation.

Installation

ZTV is easy to install in supply ventilation openings. Attachment in duct by press fit using provided rubber seal or with the provided screws in three concealed holes in the frame.

Function

The thermostat sensor automatically responds in a temperature range from $-6\text{ }^{\circ}\text{C}$ to $+20\text{ }^{\circ}\text{C}$. There are volume flows between 0 and $30\text{ m}^3/\text{h}$ within this range in compliance with the DIN guidelines. See performance diagram on the right. The valve closes from an outdoor temperature of approx. $-4\text{ }^{\circ}\text{C}$ in the “basic setting” position. A minimum supply air rate is guaranteed by the 4 mm wide spacer clip. Manual adjustment of the subsequently outdoor temperature-controlled volume flow is possible by rotating the valve disc. One rotation results in a gap change of 4 mm (see blue shaded areas in the diagram).

Number of units

The number of required supply air elements is defined pursuant to DIN 1946-6 depending on the size of the living unit and wind speed (see table on the right).

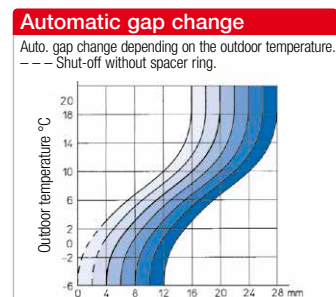
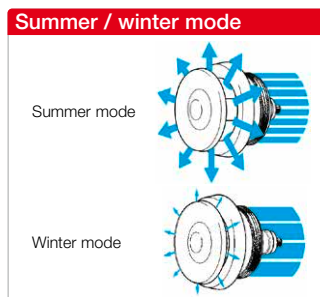
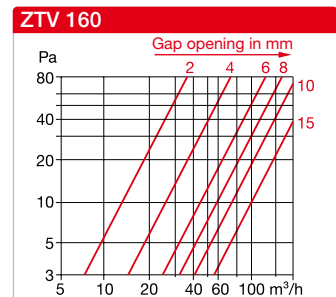
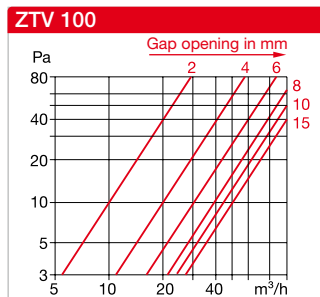
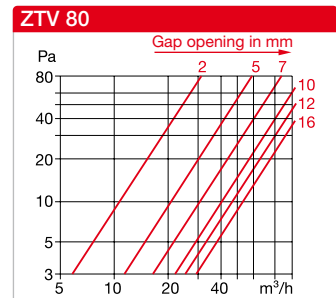

Order data			
Type	ZTV 80	ZTV 100	ZTV 160
Ref. no.	00078	00073	00074
Ø A = Duct NW	80	100	160
Ø B	77	95	156
Ø C	147	147	207
D	77	77	77
E	49	49	50
Weight approx. g	230	240	370

Number of units for mechanical demand-controlled ventilation				
Living unit size	m ²	Number ZLA/ZLE		Fans
		Extract air (8 Pa)*	Supply air (4 Pa)*	Number/unit
Hotel room	25 m ²	2	–	1
Suite	25 m ²	2 (3) **	–	1
Apartment I	50 m ²	2	3 – 4	2
Apartment II	> 50, < 80 m ²	3	4	2
Apartment III	> 80 m ²	4	5	3
Single fam. house	up to 120 m ²	4	5	3

* according to DIN 1946-6 tab. 10.

** if a kitchenette is also vented.

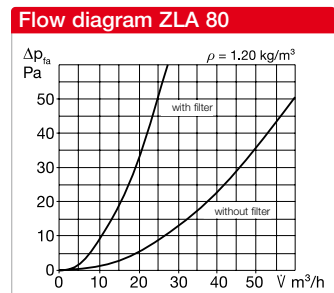
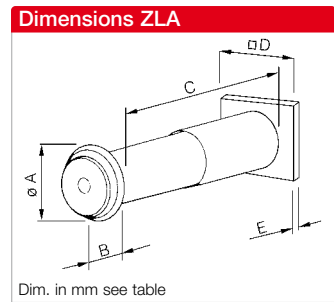
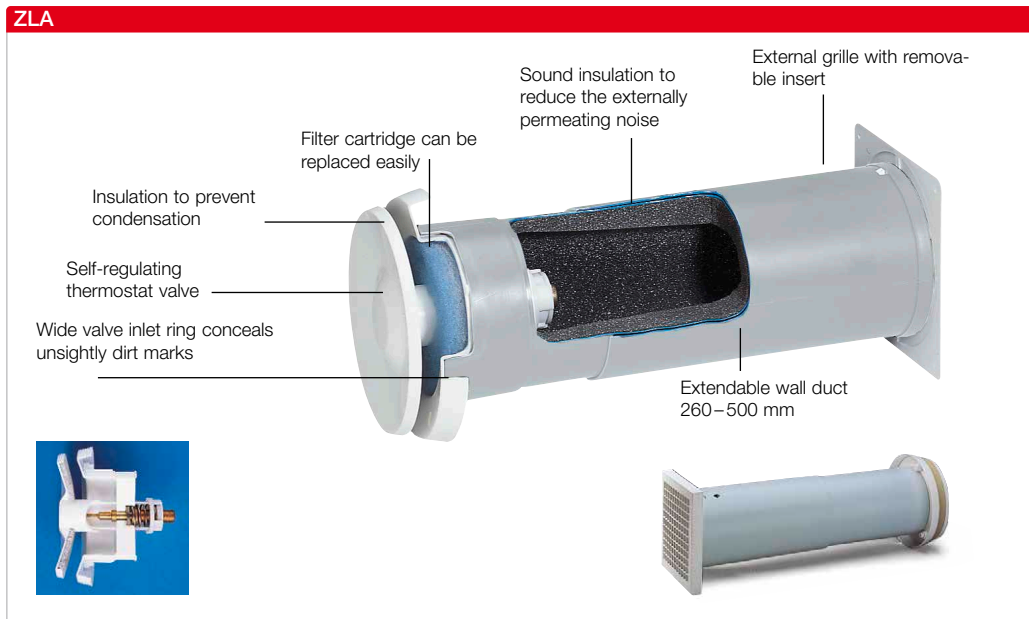

- Special features –Application**
 Universally applicable automatic supply air element. The self-regulating thermostat disc valve combines energy savings and constant ventilation with maximum efficiency. The outdoor temperature-dependent volume flow control takes place via a thermal sensor with no electrical connection. The supply air flow is optimally distributed, filtered (ISO Coarse 50% G3) and sound-insulated.

in a gap change of 4 mm (see blue shaded areas in the diagram).

- Advantages**
 - Fully automated, demand-based supply air volume control.
 - Maintenance-free and free of operating costs.
 - Individual volume flow adjustment by rotating the disc.
 - Extendable plastic wall duct for wall thicknesses from 260 to 500 mm.
 - Good sound insulation due to built-in silencers.
 - Easily replaceable filters.
 - Electrical connection is not required.
 - Quick and easy installation.

- Installation**
 Installation in wall outlets. Insert telescopic duct from outside, screw on cover grille. Mount the duct and insert the valve from inside.

- Performance data**
 The volume flow rate depending on the pressure difference is based on the opening gap of the valve disc. The performance values can be found in the diagrams above.

Accessories

Replacement air filter ISO Coarse 50% (G3)
 Each unit contains 10 pcs.

ELFZ 80	Ref. no. 00339
ELFZ 100	Ref. no. 00340
ELFZ 160	Ref. no. 00341

- Function**
 The thermostat sensor automatically responds in a temperature range from $-6 \text{ }^\circ\text{C}$ to $+20 \text{ }^\circ\text{C}$. There are volume flows between 0 and $30 \text{ m}^3/\text{h}$ within this range in compliance with the DIN guidelines. See performance diagram on the right. The valve closes from an outdoor temperature of approx. $-4 \text{ }^\circ\text{C}$ in the “basic setting” position. A minimum supply air rate is guaranteed by the 4 mm wide spacer clip. Manual adjustment of the subsequently outdoor temperature-controlled volume flow is possible by rotating the valve disc. One rotation results

- Reference**
 The number of automatic supply air elements must be determined pursuant to DIN 1946-6 (see table on left page).

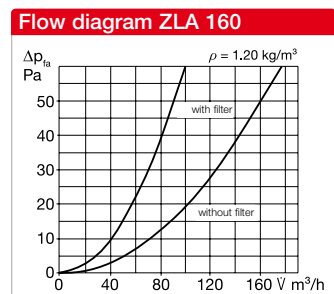
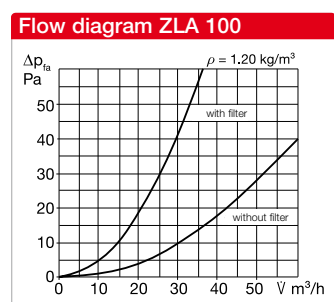
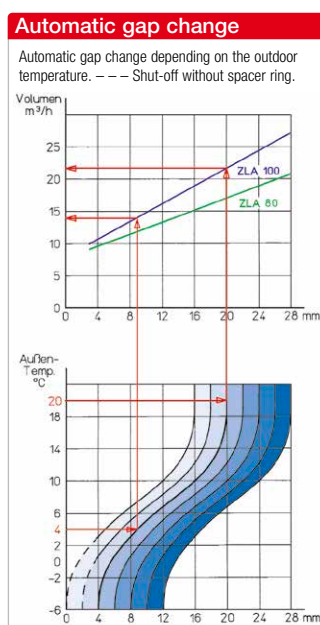

Order data			
Type	ZLA 80	ZLA 100	ZLA 160
Ref. no.	00214	00215	00216
Volume max. with filter m^3/h	25	35	100
Duct NW (mm)	80	100	160
Wall outlet \varnothing mm	96	115	175
$\varnothing A$ mm	147	147	207
B mm	49	49	50
C mm	260 – 500	260 – 500	260 – 500
D mm	107	140	190
E mm	3	15	24
Weight approx. kg	0.7	0.8	1.6
Standard sound level diff. $D_{n,e,w}$ dB(A)	41	37	35

Accessories

ZLE



Special features – Application
 Manually operated supply air element for rooms of any kind. The volume flow is changed by a four-level locking mechanism. Adjustment by means of a free-hanging drawcord. The supply air flows in through the disc valve optimally distributed, filtered (class G3¹⁾) and sound-insulated.

Advantages

- The dosed supply of intake air reduces draughts.
- The volume can be controlled according to requirements by adjusting the valve disc.
- Simple operation via drawcord.
- Electrical connection is not required.
- Wide valve inlet ring covers unsightly dirt marks.
- Extendable plastic wall duct for wall thicknesses from 255 to bis 400 mm.
- Good sound insulation due to built-in silencers.
- Easily replaceable filter.
- Quick and easy installation.

Installation

Simple installation in wall outlets. Insert telescopic duct from outside, adjust to wall thickness and mount. Insert rain-repellent grille into locking attachment from outside or mount with dowels. Insert valve component

from inside. The supply air can be preheated in cold periods by placing the unit near a heating element. Accessibility must be ensured for air filter replacement.

Design

ZLE comes complete with:

- Disc valve**
Elegant, unobtrusive design made of high-quality plastic in white. Integrated drawcord for three disc settings. Insulating coating of inside of valve disc to prevent condensation.
- Extendable wall duct**
Two-part telescoping, made of break-resistant plastic.
- Silencer**
For airborne sound insulation as sound insulation against external noise. Standard sound level difference: $D_{n,e,w}$: 38 dB.
- Air filter**
For clean and dust-free room air (class G3¹⁾), replaceable.
- External wall grille**
Fixed, rain-repellent, made of UV-resistant plastic, white.
- Filter replacement**
Easily removable without tools by removing the room-side valve.

Dimensions ZLE

Duct NW 100
 Wall outlet Ø 110 mm

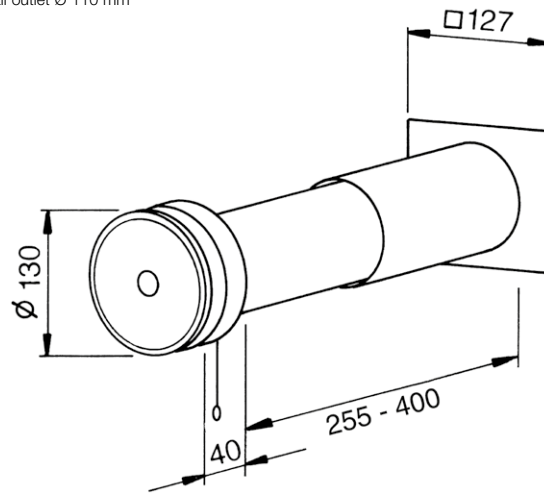

Dim. in mm

Performance data

The volume flow rate depending on the pressure difference is based on the opening gap of the valve disc. The performance values can be found in the diagram above. Sound insulation value: $D_{n,e}$: 30–35 dB (depending on the installation method and wall thickness; comparable to double glazing in protection class 2 or 3).

Number of units

The number of required supply air elements is defined pursuant to DIN 1946, pt.6 depending on the size of the living unit and wind speed (see table below).

ZLE 100 Ref. no. 00079

Accessories
Replacement air filter
ISO Coarse 50% (G3)
 Unit = 10 pcs.
ELF/ZLE 100 No. 00338

Performance curves ZLE

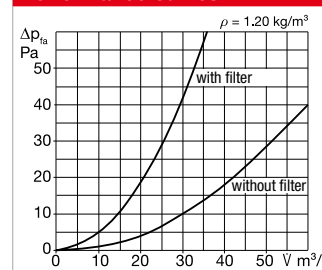

Number of units for mechanical demand-controlled ventilation

Living unit size	m ²	Number ZLA/ZLE		Fans
		Extract air (8 Pa)*	Supply air (4 Pa)*	Number/Unit
Hotel room	25 m ²	2	–	1
Suite	25 m ²	2 (3) **	–	1
Apartment I	50 m ²	2	3 – 4	2
Apartment II	> 50, < 80 m ²	3	4	2
Apartment III	> 80 m ²	4	5	3
Single fam. house	up to 120 m ²	4	5	3

* according to DIN 1946-6 tab. 10.

** if a kitchenette is also vented.

Automatic supply air element ZLA 125

The new supply air unit benefits from a standard sound level difference of up to 59 dB. In addition, the unit has a modular design which is the only one of its kind on the market.



p. 72 f

Soffit element ZLA LE

The soffit element ZLA LE directs the supply air inside the thermal insulation composite system into the window soffit by 90°. Apart from the grille in the window frame, no component can be seen on the outer facade.

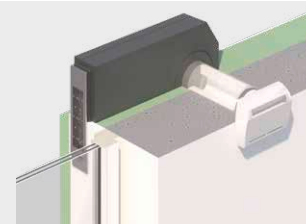

p. 74 f

ALEF

ALEF Hygro – Humidity-controlled

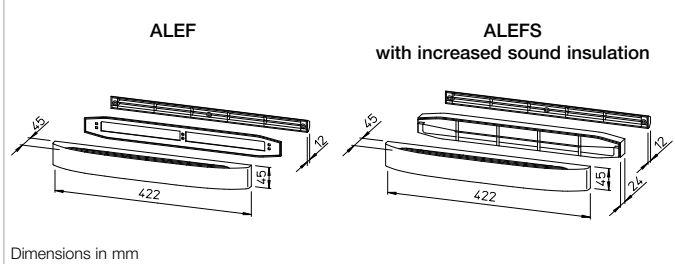
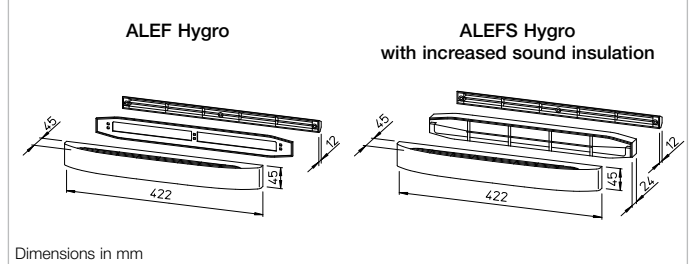
Dimensions ALEF

Dimensions ALEF Hygro – Humidity-controlled

Intake air elements ALEF with volume flow control/limitation, for installation in window frames/leaves.

Application

Differential pressure-dependently controlled window element for the controlled supply of intake air in living rooms and bedrooms. Simple installation, also suitable for retrofitting.

Design

Ready-to-install unit consisting of an inner facade with automatic volume flow limiter, mounting plate and external cover strip. All parts made of high-quality plastic in white. Types ALEFS also have an acoustic element for increased sound insulation.

Function

The element allows a controlled intake air volume (see diagram) to flow into living rooms/bedrooms using the underpressure of the extract air in kitchens, bathrooms and WCs.

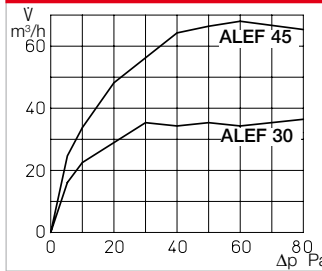
Performance curves ALEF

Installation

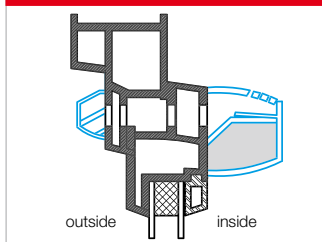
In wooden, plastic and metal window frames. Breakthrough using cutouts or holes in the upper bracket. Simply screw on external cover strip and mounting plate and clip on inner facade.

Installation example ALEF in window with aluminium frame

Humidity-controlled intake air elements ALEF Hygro with volume flow control/limitation, for installation in window frames/leaves.

Application

Window elements for the controlled supply of intake air in living rooms and bedrooms depending on the room air humidity. Ideal in combination with humidity-controlled extract air fans. Simple installation, also suitable for retrofitting.

Design

Ready-to-install unit consisting of an inner facade with automatic volume flow limiter, mounting plate and external cover strip. All parts made of high-quality plastic in white. Types ALEFS Hygro also have an acoustic element for increased sound insulation.

Function

The element allows a relative humidity-controlled intake air volume (see diagram) to flow into living rooms/bedrooms using the underpressure of the extract air in kitchens, bathrooms and WCs.

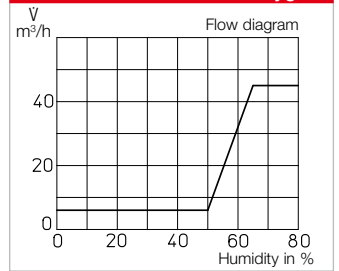
Performance curves ALEF Hygro

Installation

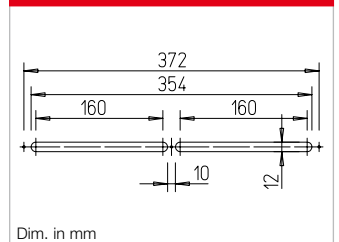
In wooden, plastic and metal window frames. Breakthrough using cutouts or holes in the upper bracket. Simply screw on external cover strip and mounting plate and clip on inner facade.

Dimensions for outlet and attachment

Order data	Intake air elements for installation in window frames			
	ALEF with volume flow control and limitation		ALEFS like ALEF, also sound-insulated	
Type	ALEF 30	ALEF 45	ALEFS 30	ALEFS 45
Ref. no.	02100	02101	02102	02103
Nom. volume m ³ /h	30	45	30	45
Standard sound level difference D _{n,e,w} in dB(A)	39	37	41	39
Weight approx. g	190	190	210	210

Order data	Intake air elements for installation in window frames	
	ALEF Hygro w/ humidity-controlled volume flow control and limitation	ALEFS like ALEF, also sound-insulated
Type	ALEF 5/45 Hygro	ALEFS 5/45 Hygro
Ref. no.	02056	02057
Nom. volume m ³ /h	5/45	5/45
Standard sound level difference D _{n,e,w} in dB(A)	37	39
Weight approx. g	200	220

Better safe than sorry. Components for preventative fire protection.



The aim of preventative fire protection in multi-floor constructions is to prevent the spread of fire to adjacent floors and rooms. Building regulations therefore divide residential units or room units into so-called utilisation units (fire sections) where the ceilings and walls must meet specific fire resistance duration requirements.

Since supply pipes and ventilation ducts cross fire sections, their openings must be equipped with dampers in the required classification.

Whether you are looking for fire dampers, ventilation tiles or ceiling seals, Helios offers precisely the right solutions.

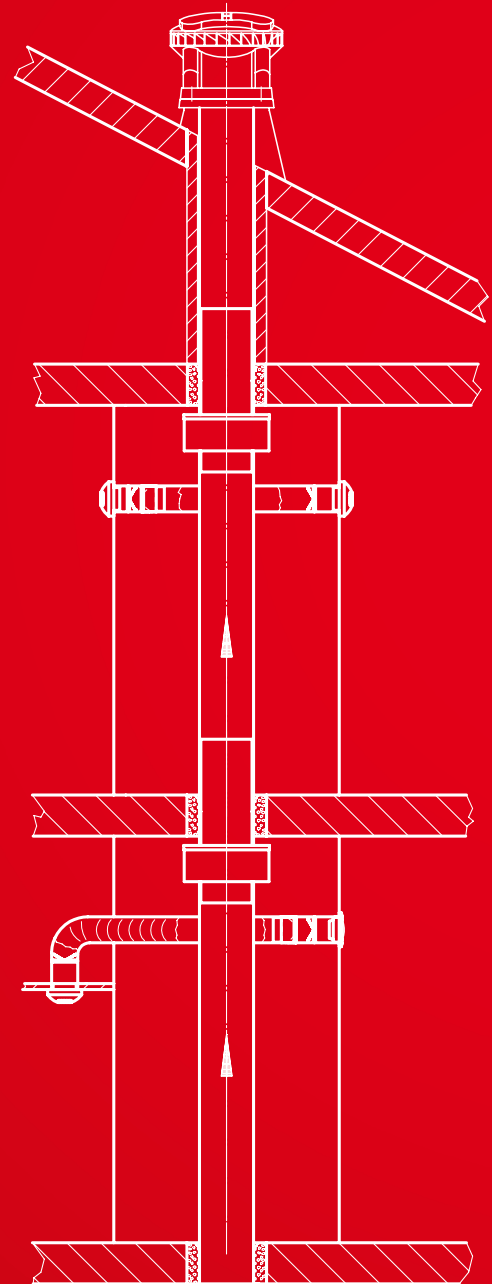



■ Fire damper elements

Fire damper elements BAE/BAK prevent the spread of fire and smoke to other fire sections through ventilation ducts or ventilation openings.

584^f



■ Fire protection disc valves

Dampers with volume flow throttle BTV/BTK to prevent the spread of fire and smoke through ventilation ducts or ventilation openings.

586^f

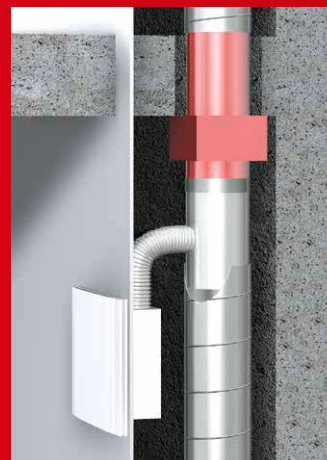

■ Fire protection ceiling seal, cold smoke shutters

Fire protection ceiling seal ELS-D for ventilation ducts pursuant to DIN 18017. Application eliminates the need for further dampers on air inlet or outlet openings. Ideal for mixed-use installation shafts.

Cold smoke shutters KAK for room-side duct insertion prevent the spread of cold smoke to other fire sections.

588^f

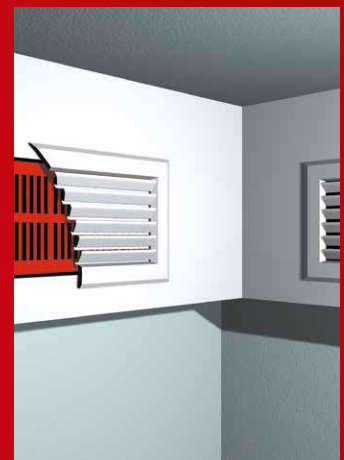

■ Fire protection ventilation tiles

Fire protection ventilation tiles BLS allow the static ventilation of closed rooms and chambers to be protected against the spread of fire and smoke, such as e.g. installation shafts, cable ducts, etc.

590^f

BAE

Approval Z-41.3-696
no maintenance conditions



Dimensions BAE

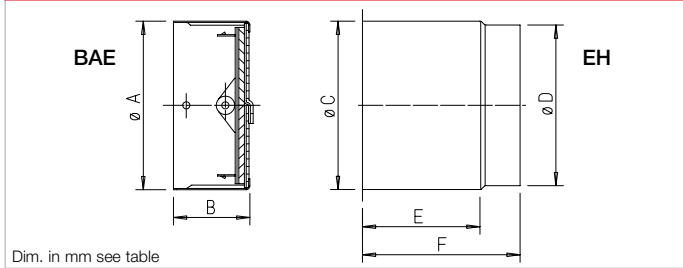

Dim. in mm see table

Pressure loss and acoustics

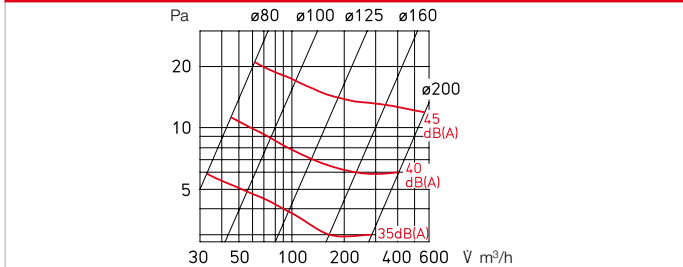

Application

Damper element to prevent the spread of fire and smoke. For installation in ventilation shafts and ducts with the required fire resistance class K 90-18017. Suitable for insertion in spiral ducts or for installation in walls and non-fire-resistant suspended ceilings using installation sleeve EH (accessories) as well as in fire-resistant ceilings as ceiling seals.

Function

When an air temperature of +72 °C is exceeded, the integrated fusible link releases the semi-circular damper blades which close abruptly by spring force. Two safety brackets lock the shutters.

Official approval

The proof of suitability of this damper element for ventilation systems according to DIN 18017 has been provided by means of appropriate tests. General technical approval from the DIBt with no. Z-41.3-696.

Special features

- No maintenance conditions.
- Cleaning and inspection together with the associated ventilation system.
- Insertion in spiral ducts without additional brickwork frame.

- Installation outside of the shaft wall is possible.
- Any air flow direction, i.e. for supply air and extract air.
- Low flow resistance, even at high air flow rates.
- Connection to fume extractor or extraction hood is possible.
- Low-noise.
- Application in residential and commercial areas, e.g. internal toilets, kitchenettes, etc.

Design

Cylindrical duct sleeve with butterfly valve and integrated fusible link.

Delivery

Shrink-wrapped in plastic film.

Installation and setting

- The installation and operating instructions contain exact specifications with regard to application and installation.
- The specifications in the related approval must be observed.

Accessories

End switch

For BAE monitoring and signalling the operating status to the central building management system. Attachable to all ND, simple snap-in installation.

BA-S Ref. no. 02585
Switch as changeover contact IP67
Max. load 5–250 V / 6 A (2 A ind.)
Connect. cable 50 cm long / 3 x 0.34 mm²
Wiring diagram no. 830



Installation examples

- Duct installation**
The element is installed by simple insertion (e.g. in spiral ducts) and fixed in the wall together with the duct. Installation is possible on both sides, regardless of the air flow direction.

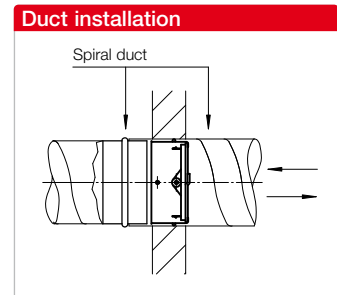

- Wall installation**
With installation sleeve EH (accessories) in walls made from brickwork, aerated concrete or plasterboard, shaft partition walls in F 90 and F 30 or system-tested walls over 40 mm thick. Installation is possible on both sides, regardless of the air flow direction.

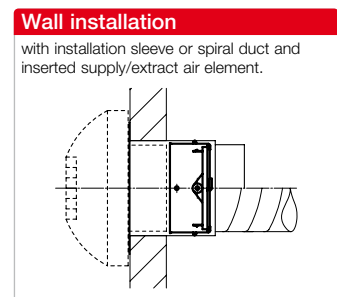

- Ceiling installation**
 - Possible in non-fire-resistant suspended ceilings.
 - In fire-resistant ceilings as ceiling seal if no free cross-section is required.

Ceiling installation

with installation sleeve and inserted supply/extract air element. Connection to main pipeline via spiral duct.

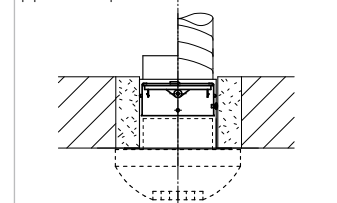

Order data

Type	Ref. no.	Dim. in mm			Weight aprx. kg	Accessories:				
		Ø A	B			Installation sleeve	Ref. no.	Dimensions in mm		
BAE 80	02624	78	60	0.17	EH 80	02639	100	98	110	140
BAE 100	02625	98	60	0.23	EH 100	02640	125	123	110	140
BAE 125	02626	123	60	0.30	EH 125	02641	160	158	110	140
BAE 160	02627	158	60	0.40	EH 160	02642	200	198	110	140
BAE 200	02628	198	60	0.55	EH 200					

BAK

EU Certificate of
Constancy of Performance
0749-CPR-BC1-606-0464-15650.69-2517



EU Certificate of Constancy of Performance
0749-CPR-BC1-606-0464-15650.69-2517

Fire dampers are construction products according to the European Construction Products Regulation.

They have an official Certificate of Constancy of Performance and a Declaration of Performance according to European construction law.

Application

Fire damper to prevent the spread of fire and smoke. For installation in walls, ceilings or ventilation shafts which serve as fire sections with the required fire resistance class EI 90 S. Suitable for wall and ceiling installation or as overflow openings. Can be inserted in spiral ducts. Installation sleeve EH (accessories) recommended for one-sided duct connection.

Function

When an air temperature of +72 °C is exceeded, the integrated fusible link releases the semi-circular damper blades which close abruptly by spring force. Two safety brackets lock the shutters.

European certification

- Declaration of Performance according to European Construction Products Regulation 305/2011.

- Tested according to EN 1366-2.
- Classification according to EN 13501-3: EI 90 (ve, ho, i→o) S – (300 Pa). Room closure and insulation 90 min., vertical, horizontal, applicable in both directions, sealed against 300 Pa, even during fire.
- Complies with European product standard DIN EN 15650.

Special features

- Installation directly in spiral duct in the room-closing component.
- Any air flow direction, i.e. for supply air and extract air.
- Low flow resistance, even at high air flow rates.
- Simple fixation with installation sleeve EH (accessories).

Design

Cylindrical duct sleeve with butterfly valve and integrated fusible link.

Delivery

Individually shrink-wrapped in plastic film.

Installation and setting

- The installation and operating instructions contain exact specifications with regard to application and installation.
- The specifications in the related approval must be observed.

Dimensions BAK

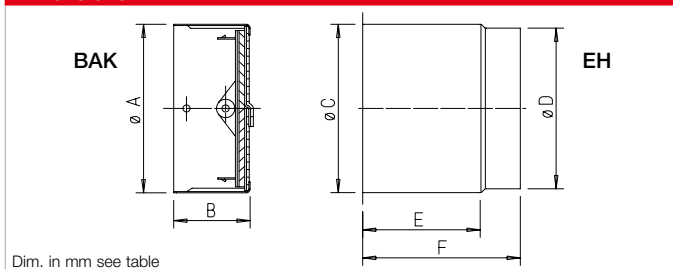

Dim. in mm see table

Pressure loss and acoustics

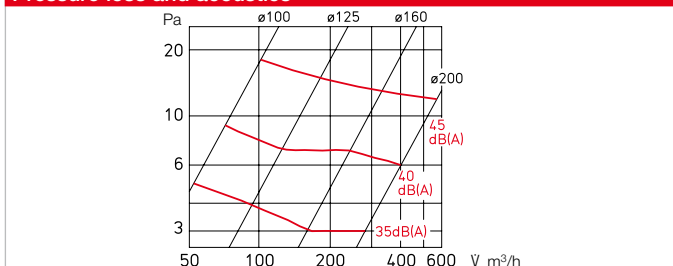

Accessories

End switch

For BAK monitoring and signalling the operating status to the central building management system. Attachable to all ND, simple snap-in installation.

BA-S Ref. no. 02585
Switch as changeover contact IP 67
Max. load 5–250 V / 6 A (2 A ind.)
Connect. cable 50 cm long / 3 x 0.34 mm²
Wiring diagram no. 830



Installation examples

Duct installation in walls or ceilings

The element is installed by simple insertion in the spiral duct or in the installation sleeve EH (accessories) and then fixed in the wall, ceiling or shaft wall. Installation is possible regardless of the air flow direction. Subsequent one-sided or double-sided duct connection.

Wall or ceiling installation

With installation sleeve EH (accessories) in walls made from brickwork, aerated concrete or plasterboard or system-tested walls over 100 mm thick. Installation is possible on both sides, regardless of the air flow direction.

Overflow opening

Without one-sided or double-sided duct connection, as overflow opening, can only be installed where there is no reason to fear smoke overflow below the trigger temperature. Approval required from building inspection authority in individual cases.

Duct installation

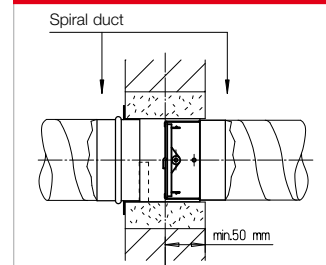

Wall installation

in brickwork, aerated concrete or plasterboard

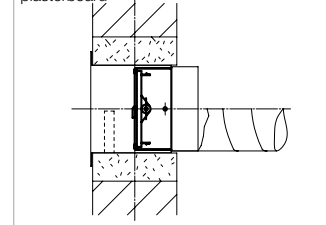

Ceiling installation

in brickwork, aerated concrete or plasterboard

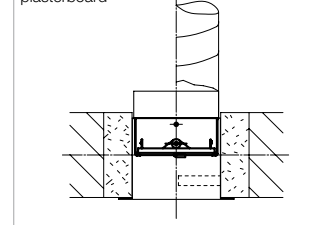

Order data

Type	Ref. no.	Dim. in mm			Weight aprx. kg	Accessories:				
		Ø A	B			Installation sleeve	Ref. no.	Dimensions in mm		
BAK 100	02620	98	60	0.24	EH 100	02639	100	98	110	140
BAK 125	02621	123	60	0.32	EH 125	02640	125	123	110	140
BAK 160	02622	158	60	0.46	EH 160	02641	160	158	110	140
BAK 200	02623	198	60	0.64	EH 200	02642	200	198	110	140

BTV

Approval Z-41.3-694
No maintenance conditions



Dimensions BTV

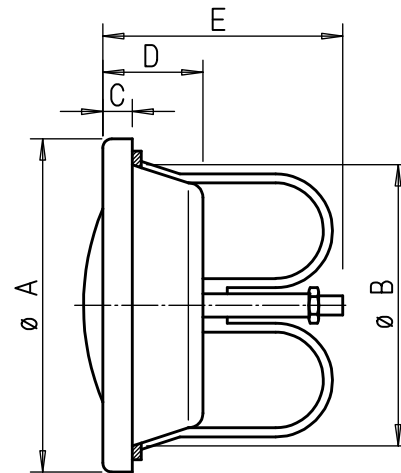

Dim. in mm see table

Application

Damper element to prevent the spread of fire and smoke. Suitable for installation in ventilation shafts and ducts with the required fire resistance class K 90-18017. For insertion in spiral ducts or for installation in walls and non-fire-resistant suspended ceilings using mounting ring (included in delivery).

Function

When an air temperature of +72 °C is exceeded, the fusible link responds. The built-in pressure spring automatically closes the valve.

Official approval

The proof of suitability of these damper elements with throttle device for ventilation systems according to DIN 18017 has been provided by means of appropriate tests and resulted in the approval from the DIBT, Z-41.3-694.

Special features

- No maintenance conditions.
- Cleaning and inspection together with the associated ventilation system.
- Officially tested fire protection disc valve with low air noise in case of high pressure drop.
- Installation in spiral ducts, shaft walls or non-fire-resistant ceilings.
- High damping value.
- Attractive, functional design.

- Simple adjustment, which cannot be changed by unauthorised persons, reduces the work load.
- Easily removable for inspection and cleaning, without unauthorised adjustment being possible.
- Large operating range.
- Application in residential and commercial areas, e.g. internal toilets, kitchenettes, etc.

Design

Sheet steel construction with white powder coating. Aerodynamically optimal design with inner cone and inlet ring.

Delivery

Includes mounting ring made of galvanised steel sheet; each valve in a separate polybag.

Installation and setting

- The installation and operating instructions contain exact specifications with regard to application and installation.
- Can be inserted by hand due to bayonet closure. Associated wall ring included in delivery.
- The specifications in the related approval must be observed.
- Volume flow settings according to adjacent diagrams.
- Settings remain fixed and cannot be changed by unauthorised persons or without dismantling the fan.

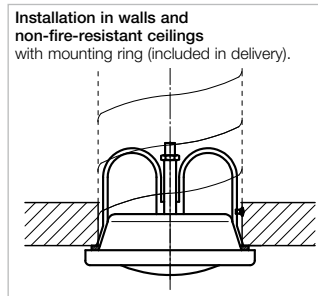

Installation in walls and non-fire-resistant ceilings with mounting ring (included in delivery).

BTV 100 Disc rotations

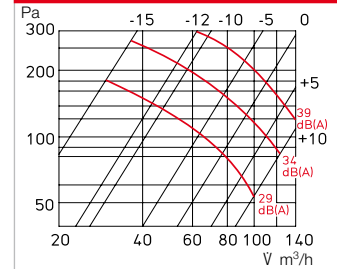

BTV 125 Disc rotations

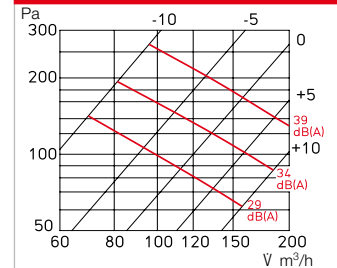

BTV 160 Disc rotations

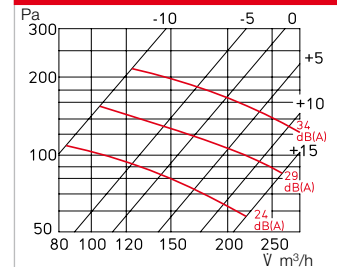

BTV 200 Disc rotations

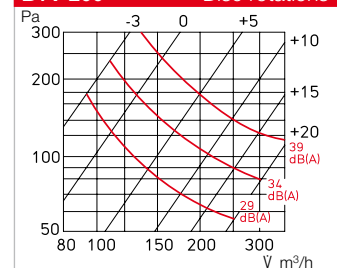

Order data

Mounting ring included in delivery							
Type	Ref. no.	Dimensions in mm					Weight approx. kg
		Ø A	Ø B	C	D	E	
BTV 100	02634	135	99	17	67	91	0.38
BTV 125	02635	161	124	18	68	103	0.48
BTV 160	02636	191	160	18	68	107	0.64
BTV 200	02637	242	199	17	67	124	0.77

BTK

EU Certificate of
Constasy of Performance
0749-CPR-BC1-606-0464-15650.69-2517



Dimensions BTK

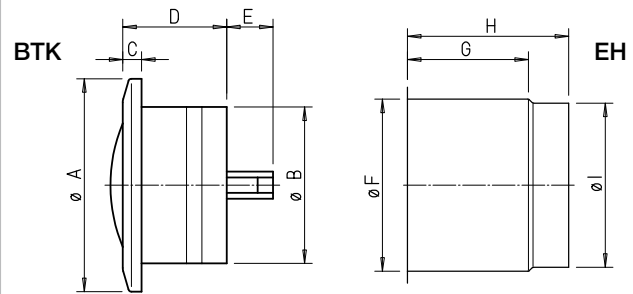

Dim. in mm see table

Fire dampers are construction products according to the European Construction Products Regulation. They have an official Certificate of Constasy of Performance and a Declaration of Performance according to European construction law.

Application

Fire damper to prevent the spread of fire and smoke. For installation in walls, ceilings or ventilation shafts which serve as fire sections with the required fire resistance class EI 90 S. Suitable for wall and ceiling installation or as overflow openings. Can be inserted in spiral ducts. Installation sleeve EH (accessories) recommended for one-sided duct connection.

Function

When an air temperature of +72 °C is exceeded, the fusible link responds. The built-in pressure spring automatically closes the valve.

European certification

- Declaration of Performance according to European Construction Products Regulation 305/2011.
- Tested according to EN 1366-2.
- Classification according to EN 13501-3: EI 90 (ve, ho, i↔o) S – (300 Pa). Room closure and insulation 90 min., vertical,

horizontal, applicable in both directions, sealed against 300 Pa, even during fire.

- Complies with European product standard DIN EN 15650.

Special features

- Installation directly in spiral duct in the room-closing component.
- Officially tested fire protection disc valve with low air noise in case of high pressure drop.
- High damping value.
- Attractive, functional design.
- Simple adjustment, which cannot be changed by unauthorised persons, reduces the work load.
- Easily removable for inspection and cleaning, without unauthorised adjustment being possible.
- Large operating range.

Design

Valve body made of plastic, aerodynamically optimal design with inner cone and inlet ring. Cylindrical duct sleeve with butterfly valve and integrated fusible link.

Delivery

Individually shrink-wrapped in plastic film.

Installation and setting

- The installation and operating instructions contain exact specifications with regard to application and installation.
- The specifications in the related approval must be observed.

Installation examples

- Duct installation in walls or ceilings**
The element is installed by simple insertion in the spiral duct or in the installation sleeve EH (accessories) and then fixed in the wall, ceiling or shaft wall. Installation is possible regardless of the air flow direction. Subsequent one-sided duct connection.

Overflow opening

Without one-sided or double-sided duct connection, as overflow opening, can only be installed where there is no reason to fear smoke overflow below the trigger temperature. Approval required from building inspection authority in individual cases.

Accessories

End switch

For BTK monitoring and signalling the operating status to the central building management system. Attachable to all ND, simple snap-in installation.

BA-S Ref. no. 02585
Switch as changeover contact IP 67
Max. load 5–250 V / 6 A (2 A ind.)
Connect. cable 50 cm long / 3 x 0.34 mm²
Wiring diagram no. 830



BTK 100 Disc rotations

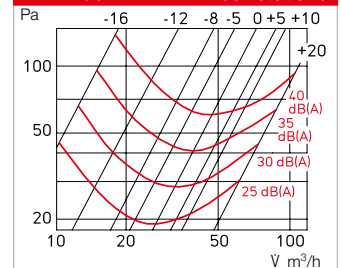

BTK 125 Disc rotations

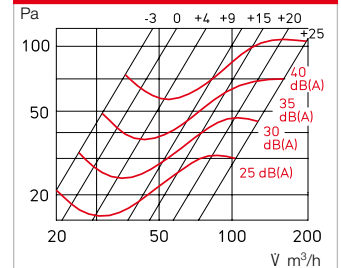

BTK 160 Disc rotations

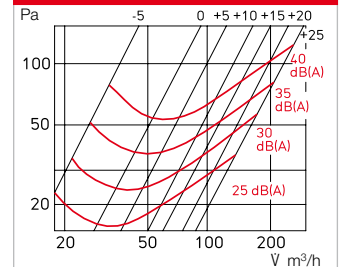

BTK 200 Disc rotations

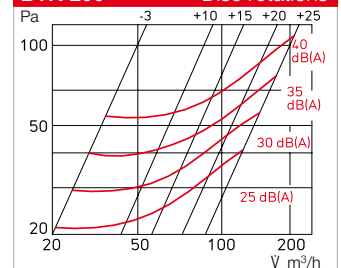

Order data

Type	Ref. no.	Dimensions in mm					Weight aprx. kg	Accessories:					
		∅ A	∅ B	C	D	E		Installation sleeve	Ref. no.	∅ F	G	H	∅ I
BTK 100	02633	150	98	19	129	20	0.45	EH 100	02639	100	110	140	98
BTK 125	02630	165	123	19	129	33	0.60	EH 125	02640	125	110	140	123
BTK 160	02631	220	158	19	129	51	0.85	EH 160	02641	160	110	140	158
BTK 200	02632	245	198	19	129	71	1.20	EH 200	02642	200	110	140	198

ELS-D



Approval Z-41.3-368
No maintenance conditions



Dimensions ELS-D

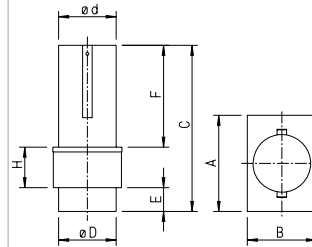

Dim. in mm

System with mono tube fans

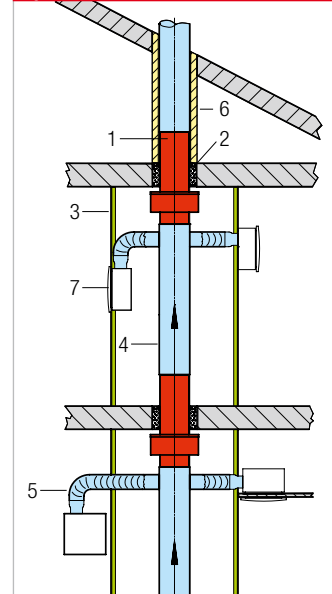

In accordance with building regulations, ventilation which vertically cross more than two full floors must be protected against fire and smoke. Traditionally, this requirement has been met by placing the ventilation duct in a fire-proof shaft. This involved: High investment costs, large space requirements, longer construction period and, above all, the cost of two shafts (distinction between mixed-use installation shaft and ventilation shaft).

■ The use of ELS-D ceiling seal has many advantages, such as e.g.:

- Placement of the ventilation duct in mixed-use installation shaft with simple, 12.5 mm thick plasterboard cladding.
- ELS-D have no maintenance requirements. Additional fire dampers with possible maintenance requirements are not necessary.
- Certified mono tube ventilation units without fire protection cladding or fire dampers may be connected via Aluflex pipes.
- Disc valves or volume flow-regulating extract air elements made of plastic can be used for central systems. These cold smoke shutters (type KAK) should be added to prevent the spread of cold smoke.

- The connection of extract air from domestic kitchens is permitted.
- The structural and functional advantages of plasterboard installations or elements can be fully realised.
- An approximate reduction of the space requirement to the ND of the main pipeline is possible through axial rotation during installation (either wide or narrow side forward or diagonal).
- The passage cross-section of the ventilation duct is fully maintained and there is no additional pressure loss. Cleaning and inspection are not affected.

General technical approval from the DIBt with no. Z-41.3-368.
Fire resistance class: K 90-18017 (three-floor test).

■ Description

Casing made of galvanised steel sheet with integrated connectors at top and bottom. The upper connector also serves as a ceiling outlet.

■ Two-stage function

- The dampers initially close the air flow opening at approx. 90 °C and prevent the introduction of high temperatures on other floors.
- The integrated foam actuator packages completely seal the

ventilation duct above the damper at approx. 180 °C.

■ Installation

ELS-D can be installed in the underside of the ceiling or in installation elements in just a few simple steps. The installation position is vertical. The ceiling seal is fixed by the two mounting brackets which are held in grouting and screed. The ceiling outlet is already integrated in ELS-D. The main pipeline can be simply slipped over and inserted on the other side like a fitting thanks to the standard connectors.

■ Accessories

Cold smoke shutter

Prevents the possible backflow of cold air etc. in central ventilation systems to other fire sections when the fan is at a standstill. (not required for systems with individual ventilation units.)

- KAK 100** Ref. no. 04097
ND 100 mm
- KAK 125** Ref. no. 04098
ND 125 mm

System with central fan

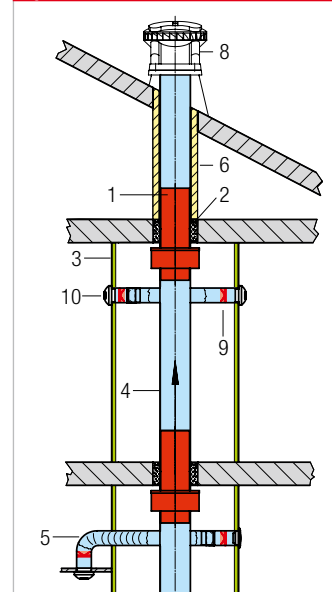

Legend

- 1 Ceiling seal ELS-D
- 2 Ceiling grouting
- 3 Installation shaft cladding e.g. 12.5 mm plasterboard
- 4 Main duct (spiral duct)
- 5 Connection duct (Aluflex)
- 6 Insulation against condensation
- 7 ELS ind. vent. units flush or surface without fire protection requirements
- 8 Central fan, e.g. Type DV EC (see page 76 ff.)
- 9 Cold smoke shutter KAK
- 10 Extract air element AE or disc valve (KTVA or MTVA)

■ Reference

Other sizes and product details regarding the use of cold smoke shutters KAK.

See page 589

Order data

Type	Ref. no.	Dimensions in mm								Weight approx. kg
		A	B	C	Ø d	Ø D	E	F	H	
ELS-D 100	00270	183	123	385	99	102	50	250	85	2.5
ELS-D 125	00185	208	148	394	124	127	50	250	94	3.4
ELS-D 140	00186	233	163	403	139	142	50	250	103	4.0
ELS-D 160	00187	258	183	413	159	162	50	250	113	5.0
ELS-D 180	00188	283	203	424	179	182	50	250	124	6.0
ELS-D 200	00271	308	223	434	199	202	50	250	134	7.2

KAK



Dimensions KAK

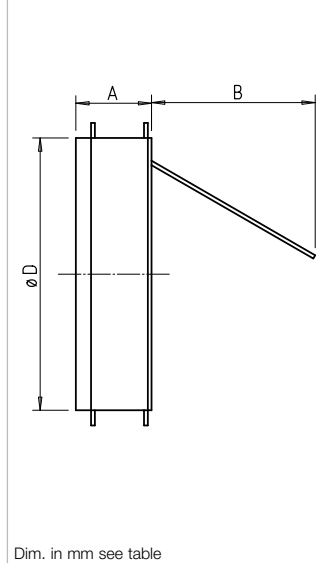

System with central fan

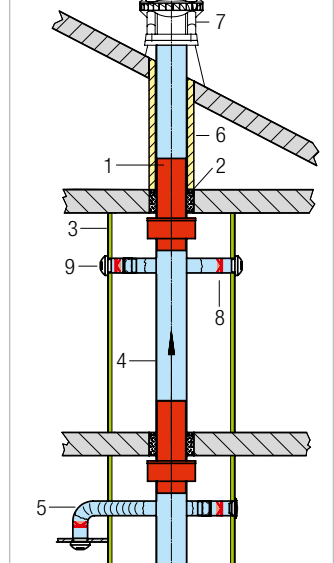

The Model Building Regulation and various regional building regulations require the following: The spread of fire and smoke must be prevented! This requirement is met by the automatic Helios cold smoke shutters with magnetic closure. They seal supply air and extract air openings against the ingress of cold smoke according to regulations.

Application

- Central ventilation systems according to DIN 18017-3 in multi-floor buildings have a central fan which is connected to a shared main pipeline and located above or below the roof. via The connected rooms (e.g. kitchens, bathrooms, WCs) on the respective floor (fire section) are ventilated via the extract air duct.
- The main pipeline must cross multiple fire sections and therefore has to be placed in a fire-proof, i.e. F90 classified shaft. The extract air openings in the individual fire sections must be equipped with fire dampers or fire protection disc valves.
- This cost-intensive and space-consuming solution can be replaced by using certified ceiling seals. Ceiling seals are installed or embedded in the main pipeline in the ceiling area. The main pipeline can thus be integrated in the installation shaft.
- Regional building regulations and general technical approvals for damper elements and ceiling seals stipulate that an outflow into the atmosphere via the main pipelines must be guaranteed for vertically installed dampers.
- This requirement becomes relevant if, in the event of a fire, the central fan fails and smoke

enters the main pipeline due to overpressure in the fire area and it can enter areas which are not affected by the fire (other fire sections) via openings (disc valves) due to generated dynamic pressure.

Helios cold smoke shutters with magnetic closure KAK prevent the ingress of cold smoke into other fire sections. They must be positioned in all supply air/extract air openings downstream of the disc valves or extract air elements (also in combination with BAE/BAK).

Design

- Ready-to-install element for insertion in ducts and fittings.
- Frame with circumferential U lip seal ring made of EPDM rubber for sealing in the ventilation duct.
- Double-sided shutter frame made of plastic with metal insert covers the silicone membrane. The shutter is therefore flutter-free and quiet in the air flow.
- A permanent magnet is positioned on the thread axle in the internal frame cylinder, which tightly seals the shutter in case of falling pressure.
- The closing and opening pressure can be adapted to the installation situation.
- The very short installation depth and the asymmetric shape of the shutter frame, which allow a large opening angle, are particularly advantageous.

Installation and setting

- Insert KAK into duct on room side and note the flow direction.
- In case of vertical installation with horizontal flow, Make sure that the axis of rotation is positioned horizontally.

Pressure loss diagram

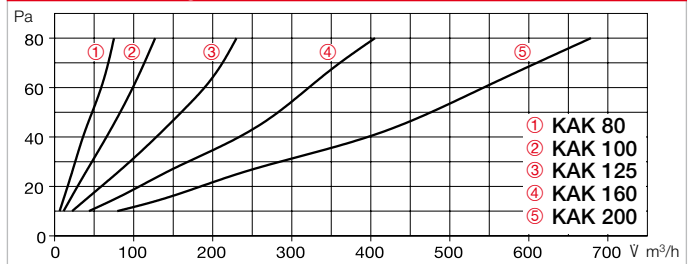

- Position directly downstream of the disc valve or air inlet/outlet element.



Order data

Type	Ref. no.	Dimensions in mm		
		Ø D	A	B
KAK 80	04096	79	12	63
KAK 100	04097	95	20	60
KAK 125	04098	120	20	83
KAK 160	04099	155	20	110
KAK 200	04100	196	20	150

Legend

- 1 Ceiling seal ELS-D
- 2 Ceiling grouting
- 3 Installation shaft cladding e.g. 12.5 mm plasterboard
- 4 Main duct (spiral duct)
- 5 Connection duct (Aluffex)
- 6 Insulation against condensation
- 7 Central fan, e.g. Type DV EC (see page 76 ff.)
- 8 Cold smoke shutter KAK
- 9 Extract air element AE or disc valve (KTVA or MTVA)

BLS

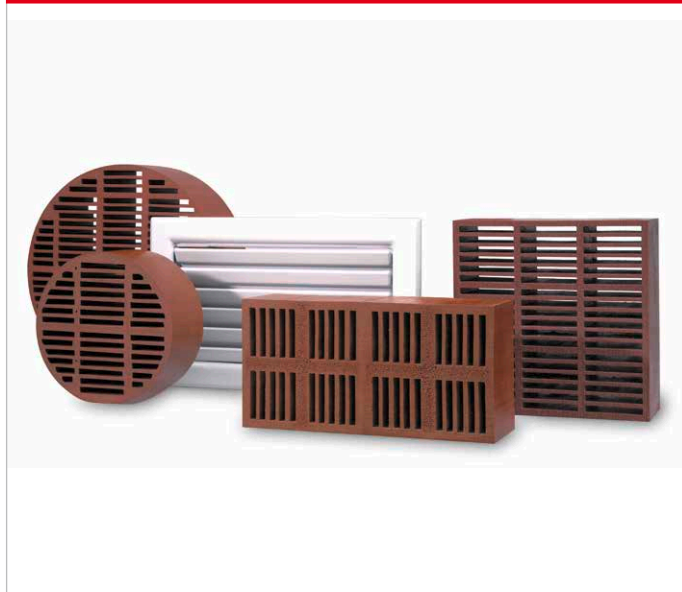

Fire protection ventilation tiles for the supply and extract ventilation of closed rooms and chambers to be protected against the spread of fire and smoke, such as e.g. installation shafts and cable ducts. They allow a constant, static air exchange which prevents heat accumulation in the closed chambers.

The tiles can also be used as inflow openings in crucial corridor walls (emergency escape routes), unless the openings are in the lower wall area.

Special features

- Fire resistance class F30 to F120 according to DIN 4102 (see box on right).
- Maintenance-free and inspection-free, no moving parts.
- Simple installation.
- Moisture-resistant, largely resistant to oils, petrol and weak acids.
- Use in individual cases on the basis of a project-related type approval (vBG).

- Installation does not affect the classification of the construction component. The ventilation tiles are made of organic intumescent material, which foams when exposed to heat, seals openings, slots and joints and thus prevents the passage of fire and smoke.

- Each tile is delivered with two ventilation grilles made of galvanised steel sheet. After inserting the tile, the grilles are to be placed over it on one or both sides as mechanical protection and optical cladding, i.e. screwed to the building structure (wall).

- Rectangular fire protection ventilation tiles must be installed horizontally.

- In case of walls of lower thickness, on-site doubling with fibre silicate frame in the BLS area.

Installation in brickwork and concrete walls F30 – F120

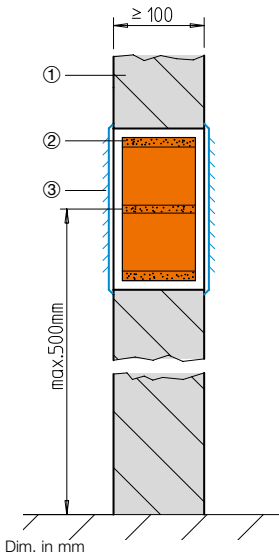

Installation in classified partition wall and cable duct F30 and F90

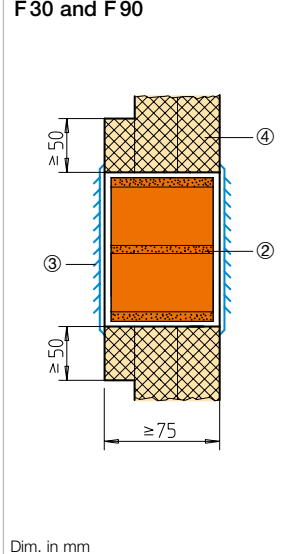

Legend

- ① Brickwork
- ② Ventilation tile
- ③ Ventilation grille, double-sided
- ④ Fibre silicate boards

Fire resistance class	Ventilation tile installation in	Thick. mm
F 30	Brickwork and concrete walls. Lightweight partition and shaft walls, classified cable ducts.	75
F 90 / F 120*	Brick and concrete walls. Lightweight partition, classified shaft walls and cable ducts.	75

* Double-sided cover grille.

Installation in classified partition wall and cable duct F30 – F120

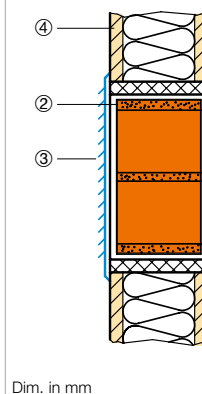

Product range, dimensions in mm									
Ventilation module		Install. open.		Wgt.	Free ventilation	Cover grille			
Ref. no.	Type	Ø	D	max. i.L.	ca. kg	cross-sect. cm ²	W	H	
02712	BLS 100	100	75	Ø 103	0.21	37	200	200	
02715	BLS 125	125	75	Ø 128	0.50	56	200	200	
02767	BLS 150	150	75	Ø 153	0.60	85	200	200	
02718	BLS 160	160	75	Ø 163	0.67	102	255	255	
02721	BLS 200	200	75	Ø 204	1.12	158	255	255	
		W	H	D			W	H	
02766	BLS 100 / 100	93	93	75	103 x 103	0.38	35	200	200
02724	BLS 150 / 150	150	150	75	153 x 153	0.80	115	255	255
02727	BLS 200 / 100	186	93	75	203 x 103	0.75	69	305	155
02730	BLS 200 / 150	200	150	75	203 x 153	1.15	153	305	200
02733	BLS 300 / 150	300	150	75	303 x 153	1.56	230	405	205

Volume flows – Differential pressure

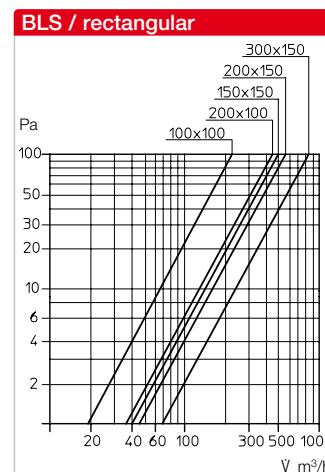
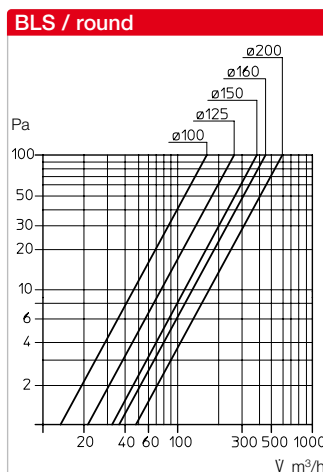

Convenient and energy-saving controlled.



The adjustment of ventilation and air-conditioning system performance to changing requirements is essential for meeting comfort standards and mandatory for energy policy reasons.

Measure.

Appropriate adjustments are required for changes in room occupancy, air deterioration at different times, changing temperatures, day and night settings, etc. Helios offers regulation, control and switching units adapted to the fans for all functions.

Control.

Complete system solutions provide maximum possible security for the user, fully guaranteed by Helios. Furthermore, a lot of time can be saved during planning, installation and operation if the control and regulation units are perfectly adapted to the fans and their functions. Problems are solved before they arise.

Regulate.

The extensive MSR range from Helios offers the ideal solution for every task and simultaneously meets all requirements in relation to energy saving and noise reduction.

Task	Our solutions at a glance	Page	
<p>Manual control of fan volume flow</p>	<p>■ Manual speed controller</p> <p>– without motor protection</p> <ul style="list-style-type: none"> – 10 V, 24 V DC – Potentiometer for EC fans – 230 V~ – Electronic, flush-m., surface-m., install. – 230 V~ – Transformer, surface-m., installation – 400 V 3~ – Transformer, surface-m., installation – 230 V~ – Transformer, elec., surface-mounted <p>– with built-in motor protection for connection to thermal contacts</p> <ul style="list-style-type: none"> – 230 V~ / 400 V 3~ – Transformer, surface-mounted – 400 V 3~ – Electronic, surface-mounted – 400 V 3~ – Frequency inverter <p>■ Operating switch for fans with 2 speeds</p> <ul style="list-style-type: none"> – Pole changing switch for Dahlander winding, surface / flush-mounted – Pole changing switch for separate windings, surface / flush-mounted 	<p>PU / PA, SU / SA 607</p> <p>ES.., BSX 597</p> <p>TSW, TSSW 598</p> <p>TSD, TSSD 599</p> <p>ETW 601</p> <p>MWS / RDS 598 f.</p> <p>ESD 601</p> <p>FU.. 602 f.</p> <p>PDA / PDU 595</p> <p>PGWA / PGWU 595</p>	
	<p>Turn-off delay</p>	<p>■ Turn-off delay switch Electronic, mechanical, with variable and fixed periods</p>	<p>ZNE, ZNI, ZV 593</p>
	<p>Air quality - automatic element</p>	<p>■ Air quality controller with on/off function depending on room air quality</p>	<p>ACL 608</p>
	<p>CO₂ traffic light display</p>	<p>■ Air quality with traffic light display, for determining the CO₂ content of the room air</p>	<p>CO₂ monitor 610</p>
	<p>Flow velocity</p>	<p>■ Flow monitor for monitoring the minimum flow velocity in rectangular and round ducts</p>	<p>SWE, SWT 609</p>
<p>Room temperature-dependent</p>	<p>■ Ventilation thermostat</p> <ul style="list-style-type: none"> – single-step with on/off function – four-step, mechanical – continuously variable, electronic <p>■ Temperature control units with integrated power unit, surface-mounted</p> <ul style="list-style-type: none"> – 230 V~ – electronic – 230 V~ / 400 V 3~ – via transformer 	<p>TME 1 608</p> <p>TME 4 600</p> <p>EST 600</p> <p>EUR 6 C 604</p> <p>KTRW / KTRD 600</p>	
	<p>Temp. difference-dependent</p>	<p>■ Diff. temp. controller Elec., cont. variable, with power unit for surface-mounting</p> <ul style="list-style-type: none"> – 230 V~ 	<p>EDTW 609</p>
	<p>Humidity-dependent control</p>	<p>■ Ventilation hygrostat with on/off function, room surf.-mount.</p> <p>■ Diff. humidity control system System component for optimal indoor humidity</p> <p>■ Fan for sanitary rooms with integ. humidity control function</p>	<p>HY 3, HY 3 SI 608</p> <p>FDR 611</p> <p>M1.. F, ELS-VF 22,51</p>
<p>Temp., pressure, speed Pressure-dependent control</p>		<p>■ Universal controller with power unit 230 V~ with 0-10 V DC output, for EC fans with power unit 400 V~</p> <p>■ Control units for differential pressure or temperature, with digital display</p> <ul style="list-style-type: none"> – 0-10 V DC – electronic, surface-mounted <p>■ Differential pressure switch for monitoring air filters, system pressure and fan operation</p>	<p>EUR 6 C 604</p> <p>EUR EC 605</p> <p>FU.. 602 f.</p> <p>EDR / ETR 606</p> <p>DDS 608</p>
		<p>Motor protection against overloading</p>	<p>■ Motor prot. circuit breaker for connection of thermal contacts for monitoring the winding temperature</p> <p>■ Motor prot. trigger unit for PTC therm. temp. sensor in winding</p>
	<p>Operating switch</p>	<p>■ Reverser switch for changing the direction of rotation and flow for axial fans</p> <p>■ Isolator switch for all-pole mains disconn. for serv. work</p> <p>■ Pole changing switch with reverser application like above, but only for axial fans with 2 speeds</p>	<p>WS 594</p> <p>RS, RHS 594 f.</p> <p>PWGW, PWDA 595</p>
<p>Automatic timer</p>		<p>■ Weekly timer for automatic control of the operating mode</p>	<p>WSUP, WSUP-S 593</p>

Flush-mounted turn-off delay timer for installation in flush-mounted boxes behind any switch

■ Special development with ideal features for fan turn-off delay e.g. in bathrooms/WCs. The small dimensions allow installation in flush-mounted box behind any switch. Activation via on/off switch coupled with the light in windowless rooms. Individually applicable due to various period variants.

■ Interference immunity and emitted interference of switch ZNE/ZNI comply with current EN guidelines.

■ ZV tested as follows, emitted interference according to:
DIN EN 55014 / VDE 0875-14-1;
DIN EN 50370 / VDE 0875-1;
DIN EN 61000-3-3 / VDE 0838-3.

■ Turn-off delay timer for installation in flush-m. box behind switch



ZNE Ref. no. 00342

Electronic turn-off delay timer with continuously adjustable turn-off delay periods

Activation via on/off switch, e.g. together with light. Minimal dimensions allow almost unrestricted installation.

Contin. adjustable turn-off delay period 0–21 min.
Start-up delay, deactivatable 45 sec.
Voltage 230 V, 1~, 50/60 Hz
Load cap. min. 0.05 A max. 0.8 A (ind.)
Protection category IP40
Dim. mm W 17 x H 37 x D 13
Installation Flush box behind switch
Wiring diagram no. 477.1
– for controlling two rooms / switches 174.3

■ Turn-off delay timer for installation in flush-m. box behind switch

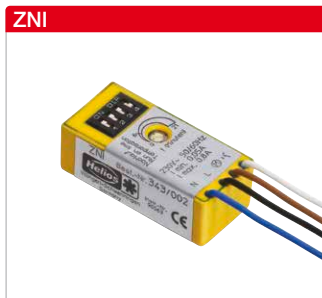

ZNI Ref. no. 00343

Electronic interval switch with adjustable interval and turn-off delay periods

Automatically ventilates in adjustable time intervals unless there is manual ventilation during these time phases. In case of manual operation, e.g. activation via light switch, there will be a turn-off delay in the set duration.

Adjust. interval period 0, 4, 8, 12, 24 h.
Turn-off delay per. w/ manual operation, Continuously adjustable 0–21 min.
Start-up delay, deactivatable 45 sec.
Voltage 230 V, 1~, 50/60 Hz
Load cap. min. 0.05 A max. 0.8 A (ind.)
Protection category IP40
Dim. mm W 17 x H 37 x D 13
Installation Flush box behind switch
Wiring diagram no. 477.1
– for controlling two rooms / switches 174.3

■ Turn-off delay timer for installation in distribution box

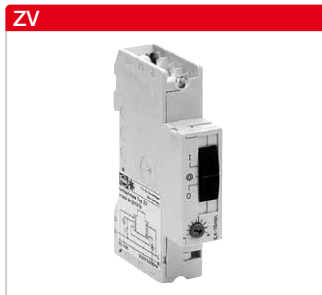

ZV Ref. no. 01279

Electronic turn-off delay timer with continuously adjustable periods and operating switch with turn-off delay and continuous operation positions. Parallel connection of light and fan possible via on/off switch or button.

Contin. adjustable turn-off delay period 4–15 min.
Voltage 230 V, 1~, 50/60 Hz
Load capacity 2.1 A (ind.)
Protection category IP20
Dim. mm W 18 x H 93 x D 67
Installation Distribution box, 35 mm profile rails
Wiring diagram no. 236.1

■ Weekly timer Surface-mounted or installation in flush-mounted box



WSUP Ref. no. 09990

Digital timer with illuminated LCD display for automatic controlling the operating modes of any units up to 10 A rated current. Suitable for switching the smallest electric currents from 1mW (0.1V/1mA) through standard, gold-plated μ contact. 56 programmable switching times for all weekdays. With smartphone via NFC (free App).

Voltage 230 V, 1~, 50-60 Hz
Load capacity 1 mW (0.1 V / 1 mA)
Switch cont. Pot.-fr. changeover contact, 250 V, 1~, 10 A $\cos \varphi \approx 1$
6 A $\cos \varphi \approx 0.6$, μ contact
Protection category/class IP20 / II
Dim. mm W 84 x H 84 x D 40
Installation Surf.-m. casing, flush-m. box
Temp. range -30° C to $+55^{\circ}$ C
Memory spaces (switching time) 56
Wiring diagram no. 862.1

■ Weekly timer for switch cabinet installation



WSUP-S Ref. no. 09577

Digital timer with illuminated LCD display for automatic controlling the operating modes of any units up to 16 A rated current. Suitable for switching the smallest electric currents from 1mW (0.1V/1mA) through standard, gold-plated μ contact. 56 programmable switching times for all weekdays. With smartphone via NFC (free App).

Voltage 230 V, 1~, 50-60 Hz
Load capacity 1 mW (0.1 V / 1 mA)
Switch cont. Pot.-fr. changeover contact, 250 V, 1~, 16 A $\cos \varphi \approx 1$
6 A $\cos \varphi \approx 0.6$, μ contact
Protection category/class IP20 / II
Dim. mm W 36 x H 90 x D 63
Installation DIN top-hat rail installation
Switch cabinet (2 space units)
Temp. range -30° C to $+55^{\circ}$ C
Memory spaces (switching time) 56
Wiring diagram no. 862.1

- Reverser switch
- Surface-mounted and flush-mounted installation possible



WS Ref. no. 01271
For switching the air flow direction of 1~ and 3~ high-performance axial fans.
Installation: Surface-mounted or flush-mounted (switch box included in delivery). With screw attachment (M 3, 60 mm).
Assignment as specified in type table on product pages.

Load capacity AC 3 / 5.5 kW / 12 A (ind.)
Voltage 230 V, 1~, 50/60 Hz
400 V, 3~, 50/60 Hz
Protection category IP54
(for flush-mounted installation IP30)
Wiring diagram no. 752
Weight approx. 0.4 kg
Dim. mm W 91 x H 121 x D 109
– for flush-m. install. W 72 x H 72 x D 35
Casing Plastic, light grey

- Reverser switch, speed switch and on/off switch
- Installation in flush-mounted switch box



DSEL 2 Ref. no. 01306
1. **Speed switch** and on/off switch for fans with two performance levels like ELS-V 60/35, -VN 100/60.
2. **Reverser switch** for switching the air flow direction of reversible fans (for supply and extract ventilation) and on/off switching.
Assignment as specified in type table on product pages.

Two replacement rockers with symbols for speed change or reversing operation included in delivery. Colour pure white.
Load capacity 3 A (ind.)
Voltage 230 V, 1~, 50/60 Hz
Protection category IP30
Installation in standard flush-m. box
Wiring diagram no. – two level 827
– reversing operation 828
Dim. mm W 80 x H 80 x D 15
Weight approx. 0.1 kg

- Three level speed switch and operating switch with 0 position
- Installation in flush-mounted switch box



Convenient flush-mounted speed switch for fans with three performance levels. Room light cannot be connected in parallel.
Voltage 230 V, 1~, 50/60 Hz
Weight approx. 0.1 kg

Type DSEL 3
Load capacity 3 A (ind.)
Protection category IP30
Installation in standard flush-m. box
Wiring diagram no. See fan type
Dim. mm W 80 x H 80 x D 23

DSEL 3 Ref. no. 01611
Can be used with fan types ELS-V 100/60/35 and ZEB 380.

DSZ Ref. no. 01598
Can be used with central extract ventilation box ZEB EC.

Type DSZ
Load capacity AC 3 / 2.2 kW, AC 15 / 6 A
Protection category IP20
Installation in flush-m. box 55 mm deep
Wiring diagram no. 735
Dim. mm W 80 x H 80 x D 23

- Speed switch, operating switch and reverser switch
- Surface-mounted and flush-mounted installation possible



FR 22/30 Ref. no. 00998
For switching fan type GX 225 or 300.
For surface-mounted and flush-mounted installation in dry rooms.
Three slide switches perform the following functions: Two-pole operating switch on/off with operating display, high or low speed and reverser switch (supply and extract ventilation).

Load capacity approx. 0.8 A (ind.)
Voltage 230 V, 1~, 50/60 Hz
Protection category IP20
Dim. mm W 210 x H 85 x D 55
Weight approx. 1.2 kg
Wiring diagram no. 497
Casing Plastic, white

- Isolator switch
- 3-pole with auxiliary contact for direct start-up



RS 3+1 7.5 Ref. no. 06387
Plastic casing for surface-mounted installation. Locking options in "0 OFF" and "I ON" positions.

Technical data
Voltage 400 V, 3~, 50/60 Hz
Operating current 20 A
Load capacity AC-23 B, 7.5 kW
Protection category IP65
Protection class II
Actuation Rotary drive
Temperature range –25 to +60 °C
Dim. mm W 90.5 x H 90.5 x D 102
Weight approx. 0.3 kg
Wiring diagram no. 1088
Casing UV-resistant and weather-resistant

- Isolator switch
- 6-pole with auxiliary contact for Dahlander winding or Y/Δ start-up



RS 6+1 7.5 Ref. no. 06388
Load capacity 20 A, AC-23 B, 7.5 kW
Dim. mm W 90.5 x H 90.5 x D 139
Weight approx. 0.4 kg

RS 6+1 11 Ref. no. 06389
Load capacity 25 A, AC-23 B, 11 kW
Dim. mm W 115 x H 115 x D 163
Weight approx. 0.6 kg

Technical data
Voltage 400 V, 3~, 50/60 Hz
Protection category IP65
Protection class II
Actuation Rotary drive
Locking options "0 OFF" and "I ON"
Temperature range –25 to +60 °C
Wiring diagram no. 1088
Casing UV-resistant and weather-resistant for surface-mounted installation

- Isolator switch/main switch
- 3-pole with auxiliary contact



RHS 3+1 Ref. no. 01594
"0" position can be locked with a padlock. In accordance with DIN EN 60204 p.1/VDE 0113-1. Plastic casing for surface-mounted installation. 3-pole with auxiliary contact, for single-speed and speed-controlled fans.

Technical data
Voltage 400 V, 3~, 50 Hz
Load capacity
– Main contact AC 3 / 5.5 kW 12 A ind.
– Aux. contact AC 3 / 2.2 kW 4 A ind.
Protection category IP54
Dim. mm W 101 x H 126 x D 104
Weight approx. 0.35 kg
Wiring diagram no. 505.2

- Isolator switch/main switch
- 6-pole with 2 aux. contacts



RHS 6+2 Ref. no. 01595
"0" position can be locked with a padlock. In accordance with DIN EN 60204 p.1/VDE 0113-1. Plastic casing for surface-mounted installation. 6-pole with 2 auxiliary contacts, for all pole-changing fans.

Technical data
Voltage 400 V, 3~, 50/60 Hz
Load capacity AC 3 / 5.5 kW
Protection category IP65
Dim. mm W 82 x H 82 x D 125
Weight approx. 0.3 kg
Wiring diagram no. 505.3

- Pole changing switch
- for separate winding PGWA
- for Dahlander winding PDA

Surface-mounted



Surface-mounted operating switch for pole-changing fans.

Type	Ref. no.	Load capacity	No.
For separate winding			
PGWA 12	05083	AC 3/5.5 kW 12 A	345
PGWA 25	05061	AC 3/11 kW 25 A	345
For Dahlander winding			
PDA 12	05081	AC 3/5.5 kW 12 A	733 ¹⁾
PDA 25	05060	AC 3/11 kW 25 A	733 ¹⁾

¹⁾ For motors w/o TK: Wiring diagram no. 732.

Technical data for all types
Voltage 400 V, 3~, 50/60 Hz
Protection category IP65

Type	Dim. mm			Weight aprx. kg
	B	H	T	
P 12	82	82	130	0.4
P 25	92	92	140	0.5

- Pole changing switch
- for separate winding PGWA
- for Dahlander winding PDA

Flush-mounted



Pole chang. switch PGWU/PDU
Flush-mounted operating switch for pole-changing fans.

Type	Ref. no.	Load capacity	No.
For separate winding			
PGWU 12	05084	AC 3/5.5 kW 12 A	345
For Dahlander winding			
PDU 12	05082	AC 3/5.5 kW 12 A	733 ¹⁾

¹⁾ For motors with thermal contacts; w/o TK: Wiring diagram no. 732.

Technical data for all types
Voltage 400 V, 3~, 50/60 Hz
Protection category IP30
Dim. mm Installation depth 87
Protrusion 40
Cover plate 80 x 80
Delivery incl. flush-mounted box
Weight approx. 0.2 kg

- Reverser and pole changing switch
- for separate winding PGWA
- for Dahlander winding PDA

Surface-mounted



PWGW Ref. no. 01281
For separate winding

PWDA Ref. no. 01282
For Dahlander winding

For speed switching and changing the air flow direction of individual pole-changing fans.
Grey plastic casing.

Technical data for all types
Voltage 400 V, 3~, 50/60 Hz
Load capacity AC 3 / 7.5 kW
Protection category IP55
Dim. mm W 96 x H 105 x D 147
Weight approx. 0.5 kg
Wiring diagram no. for PWGW 13
Wiring diagram no. for PWDA 11

- Speed switch DS 2
- for two-speed ∇/Δ switchable three-phase current fans



DS 2 Ref. no. 01351
Speed switch and on/off switch for two-speed three-phase current fans in ∇/Δ connection. Grey plastic casing for surface-mounting.

DS 2/2 Ref. no. 01267
Speed switch and on/off switch for two-speed 1~ fans, Types RR and SlimVent SVR, SVS.

Technical data for all types
Voltage 400 V, 3~, 50/60 Hz
Load capacity AC 3 / 5.5 kW / 12 A
Dim. mm W 82 x H 82 x D 130
Weight approx. 0.4 kg
Protection category, Type DS 2 IP65
Wiring diagram no. for Type DS 2 87

Protection category, Type DS 2/2 IP54
Wiring diagram no. for Type DS 2/2 939

■ Motor protection

Regulations and standards

The harmonised European standards and national Installation regulations stipulate that electric motors must be protected against thermal overload. This can be done in several ways and it depends on the motor features.

- Optimal protection is provided by thermal contacts (hereinafter "TK") which monitor the winding temperature. They also protect speed-controlled motors.
- The "TK" are connected in series with the winding, i.e. internally wired, for low motor outputs. This results in an automatic function (deactivation and reactivation after cooling) without the operator necessarily having to react to the fault.
- In case of motors/fans with larger outputs, the "TK" or PTC thermistor temperature sensors are connected to the terminal block and must be wired to the adjoining motor protection circuit breakers/trigging devices. Warranty claims shall only be applicable if this condition is met.
- Motors/fans without thermal monitoring elements in the winding (e.g. IEC standard motors) must have all-pole protection with appropriate motor protection circuit breakers.

■ For alternating current fans with external thermal contacts on terminal board

Motor protection circuit breaker MW

Switch and motor protection circuit breaker in plastic casing for surface-mounted installation or installation in switch cabinet (clamp fastening for mounting rails).

■ For three-phase current fans with thermal contacts

Motor protection circuit breaker MD

Switch and motor protection circuit breaker in plastic casing for surface-mounted installation or installation in switch cabinet (clamp fastening for mounting rails).

■ For pole-changing three-phase current fans with separate winding and thermal contacts

Motor protection circuit breaker M 2

Switch and motor protection circuit breaker in light grey plastic casing with indicator lights for surface-mounted installation.

■ For pole-changing three-phase current fans with Dahlander winding and thermal contacts

Motor prot. circuit breaker M 3

Design and function like M 2.

For two-speed three-phase current fans with γ/Δ connection and thermal contacts

Motor prot. circuit breaker M 4

Design and function like M 3.

■ For three-phase current fans with built-in PTC thermistors (PTC temperature sensors) for thermal motor protection. Mandatory use for speed-controlled, explosion-proof fans.

Motor prot. circuit breaker MSA

Triggering device with restart lockout for 1 to 6 in PTC thermistor temperature sensors connected in series.

■ Reference Page

Technical information	15 ff.
Transformer speed controller with motor protection circuit breaker	
– for 1~ altern. current MWS	598
– for 3~ 3-ph. current RDS	599



MW Ref. no. 01579

On/off operation by pushbutton switch. Manual recommissioning after fault.
Potential-free auxiliary contact for connection for fault signal.
230 V, 1~, 50/60 Hz, applic. from 80 V
Rated current 0.4 to 10 A
Protection cat. IP55 Weight aprx. 0.5 kg
Dim. mm W 80 x H 140 x D 95
Wiring diagram no. 517

MD Ref. no. 05849

On/off operation by pushbutton switch. Manual recommissioning after fault.
Potential-free auxiliary contact for connection for fault signal.
400 V, 3~, 50/60 Hz, applic. from 80 V
Rated current 0.1 to 25 A
Protection cat. IP55 Weight aprx. 0.5 kg
Dim. mm W 80 x H 140 x D 95
Wiring diagram no. 518

M 2 Ref. no. 01292

Motor disconnected from mains when TK react. Recommissioning after fault by turning switch to "0" position.
Voltage 400 V, 50/60 Hz
Switching capacity AC 3 / 5.5 kW
Rated current approx. 12 A
Protection cat. IP55 Weight aprx. 1.0 kg
Dim. mm W 170 x H 135 x D 115
Wiring diagram no. 142

M 3 Ref. no. 01293

Like M 2, but for pole-switching 3~ fans with Dahlander winding and built-in TK.
Dim. mm W 170 x H 135 x D 135
Wiring diagram no. 143

M 4 Ref. no. 01571

Like M 3, but for two-speed 3~ fans with γ/Δ connection and built-in TK.
Wiring diagram no. 144

MSA Ref. no. 01289

For the thermal protection of electric motors (even explosion-proof electric motors according to Directive 2014/34/EU (ATEX) with built-in PTC thermistor temp. sensors according to DIN 44081 and DIN 44082.

Voltage 230 V \pm 15 %, 50/60 Hz
3~ operation via contactor
Switching capacity at 230 V 3 A AC 15
Connection options 1 to 6 PTC thermistors connected in series.

Type tested by Physikalisch-Technische Bundesanstalt, according to
DIN EN 60079-14 / VDE 0165-1,
DIN EN 60079-0 / VDE 0170-1,
DIN EN 60079-17 / VDE 0165-10-1.
Protection category IP20
Weight approx. 0.2 kg
Dim. mm W 35 x H 90 x D 58
Wiring diagram no. 325.1

When a PTC thermistor reaches the nominal response temperature, the built-in relay drops out. Faults are indicated by the built-in LED. Recommissioning by pressing the "Reset" button or via external connectable switches. Plastic casing for switch cabinet installation on mounting rails according to DIN EN 60715.

Electronic speed controller for the continuously variable speed control of alternating current fans

- Multiple different fans can be operated with one controller until the rated load capacity is reached. A reserve of 10% must be taken into account for dimensioning.
- Minimum output voltage can be adjusted to motor characteristics via potentiometer. The lower limit for smooth motor start-up must be maintained!
- Overload protection from built-in microfuse.
- Additional connection of indicator lights or shutter possible via uncontrolled output.
- Complies with EMC guidelines, DIN EN 50370, DIN EN 61000 / VDE 0838, DIN EN 55014, DIN EN 60669.

■ Design ESU 1 and ESU 3 An innovation by HELIOS

- Both types are compatible with the current light switch ranges of many manufacturers. Thus, the speed controller can be integrated in the intended switch range on site. Colour adjustment is also not a problem. The frame, central insert and rotary knob are taken from the "dimmer range" in the switch series.
- Standard delivery includes: Controller insert, flush-mounted cover plate and rotary knob made of plastic in white.
- Operation indicator via light ring surrounding the rotary knob.

■ Surface-mounted design

- Closed plastic casing in attractive design.
- ESA 1 and ESA 3 with operation indication via light ring.

■ Important information

Only motors which are suitable for electronic control through voltage reduction can be connected.

- **Electronic speed control units**, which function on the basis of the phase control principle, can generate motor humming noises which may be perceived as disturbing in the lower speed/voltage range. Transformer control units which do not generate noise should therefore be used in noise-critical applications.

■ For flush-mounted installation 1~ alternating current, 230 V

ESU 1



ESU 1 Ref. no. 00236

Max. load 1 A
Front and rotary knob made of white plastic. Installation in standard flush-mounted box. Operation indicator via light ring.
Minimum load 0.15 A
Protection category (installed) IP30
Wiring diagram no. 556.1
Dim. mm W80 x H80 x D21 prot.

ESU 3



ESU 3 Ref. no. 00237

Max. load 2.5 A (T 40 E)
Front and rotary knob made of white plastic. Installation in standard flush-mounted box. Operation indicator via light ring.
Minimum load 0.15 A
Protection category (installed) IP30
Wiring diagram no. 556.1
Dim. mm W80 x H80 x D21 prot.

■ For surface-mounted installation 1~ alternating current, 230 V

ESA 1



ESA 1 Ref. no. 00238

Max. load 1 A
White plastic casing, operation indicator via light ring in rotary knob.
Minimum load 0.15 A
Protection category IP40
Wiring diagram no. 556.1
Dim. mm W 80 x H 80 x D 65

ESA 3



ESA 3 Ref. no. 00239

Max. load 2.5 A (T 40 E)
White plastic casing, operation indicator via light ring in rotary knob.
Minimum load 0.15 A
Protection category IP40
Wiring diagram no. 556.1
Dim. mm W 80 x H 80 x D 65

■ Surface-mounted, with reverser

1~ altern. current, 230 V

Can only be used with fan types: REW 150 and REW 200, series HV, H 200/4 and window fans GX.

BSX



BSX Ref. no. 00240

Max. load 1 A (T 40 E)
Surface-mounted speed controller with reverser for reversible fans (supply and extract ventilation) in white plastic casing. Only for fans which are reversible using a changeover switch.
Minimum load 0.15 A
Protection category IP40
Wiring diagram no. 480.2
Dim. mm W 80 x H 80 x D 65

■ For distribution box installation 1~ alternating current, 230 V

ESE 2.5



ESE 2.5 Ref. no. 01302

Max. load 2.5 A
For installation in switch cabinets and distribution cabinets. Compatible with 35 mm standard profile rails.
Minimum load 0.1 A
Protection category IP30
Wiring diagram no. 376
Dim. mm W 35 x H 86 x D 94

Five-step transformer speed controller for the speed control of alternating current fans

- Can be used for controlling the power of all speed-controllable 1~ alternating current fans.
- Four secondary voltage in the gradations 80 / 100 / 130 / 170 and 230 V (full mains voltage) allow 5 fan performance levels.
- Multiple different fans can be connected to one control unit until the rated load capacity is reached.

Advantages

- Advantageous price/performance ratio.
- Low fault susceptibility.
- Low-loss and low-noise fan operation.
- Uncontrolled output for connection of indicator lights or shutter for MWS-, TSW- (from type TSW 1.5) and STSSW types.

Surface-mounted unit design

- Robust ISO casing, light grey, made of break-resistant plastic in protection category IP54.
- Built-in operating switch for five speeds and activation/deactivation.
- Operation indication via indicator lights.
- Dip impregnated autotransformer T 40 E.
- Design complies with DIN VDE 0550.
- Max. permissible ambient temperature +40 °C.
- Delivered ready for operation, simple connection to terminal board.

Integral transformer design

- Mounted terminal block for five voltage taps.
- Mounted angled rails for simple attachment.
- Dip impregnated autotransformer T 40 E.

Accessories

Six-step cam switch Type STSSW for switch cabinet installation, with front attachment.

- For surface-mounted installation
Max. load 0.35 A
1~ alternating current, 230 V



- For surface-mounted installation
1~ altern. current, 230 V



- For switch cabinet installation
1~ alternating current, 230 V

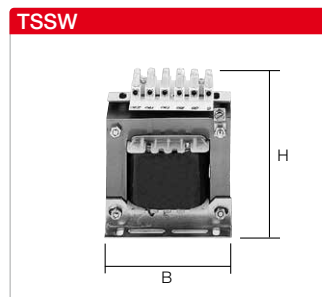

- With motor protection circuit breaker
1~ alternating current, 230 V
For surface-mounted installation



Mini speed controller TSW 0.3
Compact five-step speed controller with on/off switch for surface installation in dry rooms. Plastic casing, white.

TSW 0.3	Ref. no. 03608
Max. load 0.35 A	
Protection category	IP20
Dim. mm	W 160 x H 85 x D 60
Wiring diagram no.	496.1

Transformer speed control. TSW
For one or more alternating current fans.

Type	Ref. no.	I max. A	Dim. mm		
			B	H	T
TSW 1.5¹⁾	01495	1.5	154	200	79
TSW 3.0¹⁾	01496	3.0	154	200	148
TSW 5.0²⁾	01497	5.0	200	254	167
TSW 7.5²⁾	01596	7.5	200	254	167
TSW 10²⁾	01498	10.0	200	254	167

Wiring diagram no. ¹⁾ 960 ²⁾ 437.1

Speed contr. transformer TSSW
Integral transformer with foot rails and terminal block for 5 voltage taps.

Type	Ref. no.	I max. A	Dim. mm		
			B	H	T
TSSW 1.5	06520	1.5	78	90	78
TSSW 3	06521	3.0	84	94	92
TSSW 5	06522	5.0	105	111	87
TSSW 10	06523	10.0	120	122	112

Wiring diagram no. 268

Five-step operating switch STSSW
Accessory for control transformer TSSW for 230 V, 1~ fans. For switch cabinet installation with front attachment and front plate. connections are recessed.

STSSW	Ref. no. 00234
Voltage	AC 3, 230 V
Max. load	2.2 kW
Installation depth	70 mm, □ 46 mm
Wiring diagram no.	548

Transformer speed controller MWS with motor protection circuit breaker

Five-step speed controller with integrated triggering device for 230 V, 1~ fans. For connection of external thermal contacts on terminal board. Connection of multiple fans possible up to the rated load. All fans deactivated when thermal contact reacts. With step switch and indicator lights. Recommissioning after fault or mains disconnection via "0" position.

Type	Ref. no.	I max. A	Casing IP54 made of	Dim. mm			Weight aprx. kg
				W	H	D	
MWS 1.5	01947	1.5	Plastic	200	254	98	3.7
MWS 3	01948	3.0	Plastic	200	254	98	4.8
MWS 5	01949	5.0	Plastic	200	254	167	6.3
MWS 7.5	01950	7.5	Plastic	236	316	188	10.0
MWS 10	01946	10.0	Plastic	236	316	188	13.5

Wiring diagram no. 440.4

Five-step transformer speed controller for the speed control of three-phase current fans

- Can be used for controlling the power of all speed-controllable 3~ three-phase current fans, in large steps for γ/Δ switchable types.
- Four secondary voltage in the gradations 80 / (115)* / 140 / 200 / 280 and 400 V (full mains voltage) allow 5 fan performance levels.
* internally switchable for voltage-controllable, explosion-proof rectangular duct and roof fans for TSD.
- Multiple different fans can be connected to one control unit until the rated load capacity is reached.

Advantages

- Advantageous price/performance ratio.
- Low fault susceptibility.
- Low-loss and low-noise fan operation.
- Uncontrolled output for connection of indicator lights or shutter for RDS-, TSD- and STSSD-types.

Surface-mounted unit design

- Robust ISO casing, light grey, made of break-resistant plastic, protection category IP54.
- Types from RDS 7 and TSD 5.5 made of steel, lacquered twice, protection category IP65.
- Built-in operating switch for five speeds and activation/deactivation.
- Operation indication via indicator lights.
- Dip impregnated autotransformer T 40 E, protection class II.
- Design complies with DIN VDE 0550.
- Max. permissible ambient temperature +40 °C.
- Delivered ready for operation, simple connection to terminal board.

Integral transformer design

- Two autotransformers in V circuit allow the function described above.
- Mounted terminal block for five voltage taps.
- Mounted angled rails for simple attachment.
- Dip impregnated autotransformer T 40 E.
- Contactors and wiring on site.

Accessories

Six-step cam switch Type STSSD for switch cabinet installation, with front attachment.

- For surface-mounted installation
3~ three-phase current, 400 V

- For switch cabinet installation
3~ three-phase current, 400 V

- With motor protection circuit breaker
3~ three-phase current, 400 V
For surface-mounted installation

TSD



TSSD

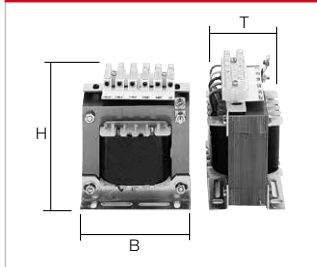

STSSD



RDS



Transformer speed control. TSD

Like TSW, but for 3~ fans.

Type	Ref. no.	I max. A	Dim. mm		
			B	H	T
TSD 0.8	01500	0.8	200	254	167
TSD 1.5	01501	1.5	200	254	167
TSD 3.0	01502	3.0	200	254	167
TSD 5.5	01503	5.5	300	300	150
TSD 7.0	01504	7.0	300	300	150
TSD 11.0	01513	11.0	300	400	200

Wiring diagram no. 436.2

Speed contr. transformer TSSD

Like TSSW, but two integral transformers, connection in V circuit.

Type	Ref. no.	I max. A	Dim. mm		
			B	H	T
TSSD 1	06516	1.0	84	95	80
TSSD 2	06517	2.0	96	104	92
TSSD 4	06518	4.0	105	112	98
TSSD 7	06519	7.0	120	122	134
TSSD 11	06515	11.0	150	146	158

Wiring diagram no. 267.1

Five-step operating switch

STSSD compatible with speed control transformer TSSD for 3~, 400 V fans. For switch cabinet installation with front attachment and front plate. Recessed connections.

STSSD	Ref. no. 00235
Voltage	AC 3, 400 V
Max. load	5.5 kW
Installation depth	110 mm, □ 46 mm
Wiring diagram no.	549.1

Transformer speed controller RDS with motor protection circuit breaker

Five-step speed controller with integrated thermal contact triggering device for 3~, 400 V three-phase current fans. For connection of external thermal contacts on terminal board.
Connection of multiple fans possible up to the rated load. All fans deactivated when thermal contact reacts. With step switch and indicator lights. Recommissioning after fault or mains disconnection via "0" position.

Type	Ref. no.	I max. A	Casing IP54 made of	Dim. mm			Weight aprx. kg
				B	H	T	
RDS 1	01314	1.0	Plastic	236	316	128	8.9
RDS 2	01315	2.0	Plastic	236	316	128	11.2
RDS 4	01316	4.0	Plastic	236	316	128	13.0
RDS 7	01578	7.0	Steel	300	300	150	21.2
RDS 11	01332	11.0	Steel	300	400	200	37.9

Design according to VDE 0550, dip impregnated transformer in V circuit.

Max. perm. ambient temp. +40 °C. Wiring diagram no. 139.

■ **Five-step climate transformer controllers KTRW and KTRD**

- Fault-resistant, low-loss transformer controller for temperature-dependent fan control including motor protection.
- Recommended for noise-critical applications.
- An electronic thermostat type TME 4 or EST is required for control and must be ordered separately as an accessory.

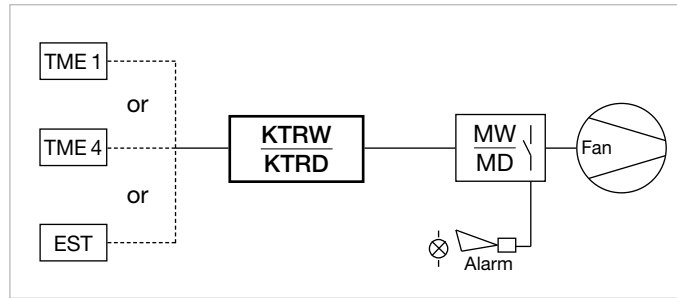

■ **For alternating current fans 1~, 230 V, 50/60 Hz**

Climate transformer controller KTRW 230 V

For automatic control of individual or multiple alternating current fans depending on room temperature. Five-step automatic operation, each step can also be switched manually. Integrated motor protection through connection of external thermal contacts on the motor. Suitable for stable ventilation. Plastic casing light grey.



Type	Ref. no.	I max.	Dim. mm			
			A	B	H	T
KTRW 3	01662	3.0	236	316	128	

Voltage 230 V~, 50/60 Hz
Protection category IP54
Max. ambient temperature +40 °C
Wiring diagram no. 674

■ **For three-phase current fans 3~, 400 V, 50/60 Hz**

Climate transformer controller KTRD 400 V

For five-step automatic control of three-phase current fans depending on room temperature. Via built-in operating switch, also manually step-controllable. Integrated motor protection through connection of external thermal contacts on the motor. Robust casing made of steel, lacquered twice in light grey.



Type	Ref. no.	I max.	Dim. mm			
			A	B	H	T
KTRD 3	01650	3.0	300	500	200	
KTRD 5.5	01651	5.5	300	500	200	
KTRD 10	01652	10.0	400	500	200	
KTRD 15	01653	15.0	400	500	200	

Voltage 400 V, 3~, 50/60 Hz
Protection category IP54
Max. ambient temperature +40 °C
Wiring diagram no. 676.1

■ **Accessories for KTRW and KTRD**

■ **Four-step electronic thermostat**

For temperature-dependent control of a KTR transformer controller or for series connection (on/off) of up to four 1~ fans. Supply voltage 230 V~ required.

Electronic four-step thermostat with switching sequence of 1 K to the defined setpoint. Allows five-step temperature-controlled fan operation depending on the pre-defined setpoint and actual temperature in combination with climate controller KTR. Robust casing made of impact-resistant plastic, light grey. Cable routing to bottom of casing in PG 11.



Type	Ref. no.
TME 4	01335

Voltage 230 V~, 50/60 Hz
Max. continuous current (AC 3) 6 A
Temperature range 0 to +50 °C
Control accuracy +/- 0.8 K at 20 °C
Switching distance 1 K
Protection class II
Protection category IP54
Dim. mm W 120 x H 80 x D 75
Weight approx. 0.4 kg
Wiring diagram no. 702

■ **Electronic control thermostat EST**

with multiple control variables for controlling a climate transformer controller KTR.

□ **Control functions**

- Temperature-dependent, five-step fan control via KTR units. Control range limit possible through specification of a minimum and maximum air rate (voltage). Minimum air rate can be switched on and off.
- Ventilation valve control (analogue 0...10 V)
- Frequency inverter control (analogue 0...10 V)
- Heating thermostat
- Temperature monitor (under and overtemperature with external temperature compensation).
- via a dirt-resistant membrane keyboard.

□ **Displays**

- Displays for operating mode, room temp., external temperature and setpoint temperature.
- Signal LED for auto. reduction.
- Alarm signal LED for overtemperature, undertemperature, system fault.
- Scaled illuminated point display (0-100 %) for fan speed and valve opening.

□ **Temperature sensor**

One external and one internal temperature sensor included in delivery. Casing in IP 55, installation up to a distance of 100 m from the controller, connection via NYM 3 x 1.5 mm².

□ **Possible settings**

- Continuously variable specification of setpoint temp. and control range.
- Min./max. power (speed) limit.
- Minimum volume flow can be switched on and off.



Type	Ref. no.
EST	01355

Voltage 230 V, 1~, 50/60 Hz
Protection category IP54
Transformer conn. 230 V AC / max. 10 A
Temperature range (adjustable) 0 to 40 °C
Control range (adjustable) 2 to 12 K
Alarm low temp. (adjustable) -20 to 0 K
Alarm high temp. (adjustable) 0 to 25 K
Heating (adjustable) -15 to +5 K
External temp. compensation 0 to 20 K
Min. air rate approx. 0 to 40 %
Max. air rate approx. 60 to 100 %
Minimum air shut-off -25 to 0 K
Dim. mm W 260 x H 215 x D 120
Weight approx. 2.0 kg
Wiring diagram no. 357.3

- Automatic reduction on/off.
 - Continuously variable temp. specification for activation of heating.
 - Continuously variable specification for alarm signal if temperature is too high or too low.
 - Min. and max. valve opening.
- **Casing**
- Plastic, light grey with transparent hinged cover, for surface-mounted installation.



Helios creates a simple solution by combining fans and customer-specified central building control technology with these speed control units!

Common features

- Control via analogue 0 – 10 V input through on-site signal, electronic control system EUR 6 C or other control units.
- Multiple different fans can be connected to a control unit up to the maximum control current load.
- Multiple control devices can be controlled in parallel by the building control technology and this enables the distribution of fan power to multiple fans or fan groups and circuits.
- **Accessories for both series**
In case control is not via central building control technology, universal controller with 10 V output can be used for this purpose.

EUR 6 C Ref. no. 01321
See Electronic control system page for description.

Description ESD

Convenient continuously variable electronic speed controller for 3~ fans, which can be phase angle-controlled by voltage reduction (except KVD Ex types). State-of-the-art technology through use of microcontrollers.

■ **Setting options/Display**

- On/off and continuously variable speed specification through rotary potentiometer.
- 0 – 10 V input. Remote control possible through on-site rotary potentiometer (22 kOhm).
- 3 ~ phase monitoring, protection against phase loss.
- Soft start-up function.
- Automatic minimum start-up voltage 80 V.
- Meets EMC requirements class B, shielded cable between unit and motor not required.
- LEDs as status and fault indicators.
- Integrated protection of electronics against overload.
- Motor protection by monitoring the motor's thermal contacts.

■ **Casing**

- Plastic casing, light grey with wide cooling element.
- Can be used directly in heavily contaminated environments (e.g. kitchen) due to protection category IP65.

■ **Product range**

Type	Ref. no.	Output current	Power consumpt.	Wiring diagram	Dimensions			Width cooling element	Weight	Prot. cat.
					W	H	D			
		A	kW	No.	mm	mm	mm	mm	ca. kg	IP
For three-phase current fans, 3~, 400 V, 50/60 Hz										
ESD 5	00501	5.0	2.2	831	115	160	165	23	1.5	65
ESD 11.5	00502	11.5	5.5	831	160	160	165	68	1.7	65

Description ETW

Seven-step electronic transformer control unit for controlling the speed of 1~ fans. Robust and low-loss power units for ventilation systems which are controlled via central building control technology.

■ **Setting options/Display**

- Built-in operating switch enables on, off and direct mains connection.
- Performance level rotary switch allows manual step specification (1–7) or automatic operation. The transformer control unit is automatically controlled by the on-site ventilation control system in the "Auto" position.
- The respective performance level is indicated by an LED.
- The integrated minimum air flow rate circuit can be switched off completely by the ventilation controller via the analogue input.

■ **Overload protection**

ETW types are protected against permanent overloading by a built-in temperature switch. When the overload protection is activated, the control unit automatically switches to the direct mains power supply. The control unit returns to normal operation after a cooling down phase. The fault can and should be indicated via the signal output to an on-site alarm system.

■ **Casing**

- Plastic casing, light grey.

■ **Dimensions**

Type	Ref. no.	Dim. mm			Weight approx. kg
		W	H	D	
ETW 5	01263	240	315	210	8.0
ETW 10	01264	240	315	210	12.5

■ **Product range**

Type	Ref. no.	Outlet current	Outlet voltages Steps							Wiring diagram	Prot. cat.
			1	2	3	4	5	6	7		
		A	V							No.	IP
For alternating current fans, 1~, 230 V, 50/60 Hz											
ETW 5	01263	5.0	80	95	115	135	165	195	230	683	54
ETW 10	01264	10.0	80	95	115	135	165	195	230	683	54

FU-B and FU-BS

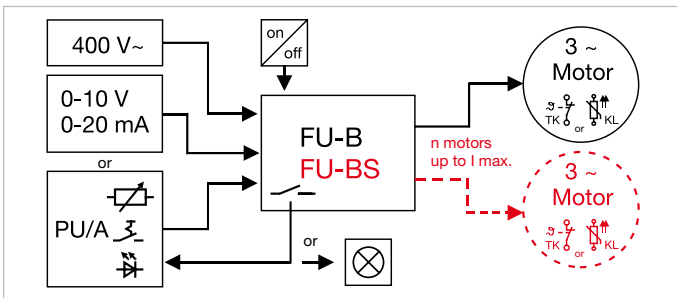

Description FU-B "Basic"

- Frequency inverter FU-B in basic design without sine filter for controlling the speed of an individual fan.
- Speed specification via 0-10 V control signal (e.g. PU/PA, AFS 0-10 V, accessories).
- Maximum cable length between FU-B and fan is 10 m with shielded cable.
- The fan must be designed for operation with frequency inverter (EMC suitable fan/motor, optional special design).
- The FU-B is fixed at its rated current.
- The frequency inverter compatibility must be specified when ordering fan for FU-B operation (without sine filter).

Description FU-BS "Basic-Sine"

- Frequency inverter FU-BS in basic design with integrated, all-pole effective sine filter.
- For controlling the speed of one or more fans. The permitted number of fans is calculated from the maximum FU current.
- Speed specification via 0-10 V control signal (e.g. PU/PA, AFS 0-10 V, accessories).
- Cable length between FU-BS and fan can be over 10 m.
- No additional EMC shielding of electrical cables required. The fans and motors do not require special EMC measures for frequency inverter operation.
- The FU-BS is fixed at its rated current.
- Conventional standard fans/ motors can be used when using the frequency inverter with integrated sine filter.

FU-C and FU-CS

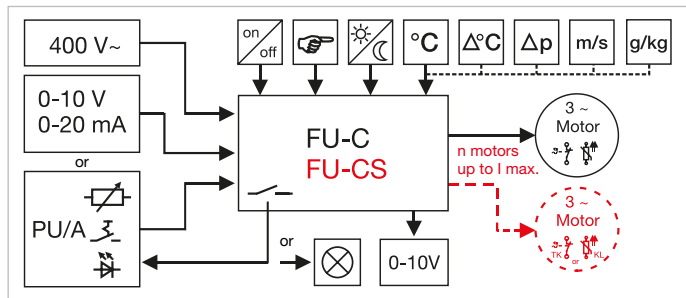

Description FU-C "Comfort"

- Frequency inverter FU-C in comfort design without sine filter for controlling the speed of an individual fan.
- Includes display and three operating buttons for adjusting the fan and control parameters.
- Parameterisation and control options via Modbus.
- With integrated, full control system for temperature, pressure and air velocity and absolute humidity difference. Required sensors LDF 500, LGF 10, LT..., AFS 0-10 V (access.) available.
- Speed specification via 0-10 V control signal (e.g. PU/PA, AFS 0-10 V, accessories) or via direct input on display.
- Cable length and fan suitability for operation with frequency inverter see FU-B.
- The frequency inverter compatibility must be specified when ordering fan for FU-C operation (without sine filter).
- With protection mode for use in smoke extraction systems, bridges internal protection device for max. operating duration.

Description FU-CS "Comfort-Sine"

- Frequency inverter FU-CS in comfort design with integrated, all-pole effective sine filter.
- For controlling the speed of one or more fans. The permitted number of fans is calculated from the maximum FU current.
- Includes display and three operating buttons for adjusting the fan and control parameters.
- Parameterisation and control options via Modbus.
- With integrated, full control system for temperature, pressure and air velocity and absolute humidity difference. Required sensors LDF 500, LGF 10, LT..., AFS 0-10 V (access.) available.
- Speed spec., cable length, EMC measures see FU-BS.
- Conventional standard fans/ motors can be used when using the frequency inverter with integrated sine filter.
- With protection mode for use in smoke extraction systems, bridges internal protection device for maximum operating duration.

	FU-B and FU-BS
Analogue inputs	1 x 0-10 V, Ri 100 kOhm or 0-20 mA
Logic inputs	1 x digital 24 V, release
Analogue output	—
Relay output	1 x NOC 250 V / 2 A ind.
Module power supply	1 x 10 V DC, 10 mA, 1 x 24 V DC, 70 mA
Motor temperature monitoring	Thermal contact or PTC thermistor

	FU-C and FU-CS
Analogue inputs	2 x 0-10 V, Ri 100 kOhm or 0-20 mA, or KTY
Logic inputs	2 x digital 24 V, function can be parameterised
Analogue output	1 x 0-10 V DC, 10 mA
Relay output	2 x changeover contact 250 V / 2 A ind.
Module power supply	1 x 10 V DC, 10 mA (in analogue output), 1 x 24 V DC, 70 mA
Motor temperature monitoring	Thermal contact or PTC thermistor

General features

- Inverter especially optimised for HLK application.
- Energy-saving through continuously variable speed setting.
- Specially adapted to fan operation, i.e. minimal energy consumption and minimal noise generation in partial load range.
- Use of maintenance-free three-phase current asynchronous motors of all types and performances.
- No performance restriction when using standard motors.
- Operating signal via potential-free contact.
- Potentiometer power supply: 10 V DC/10 mA for potentiometer with e.g. 10 kOhm
- Analogue input for speed specification (0–10 V, 0(4)–20 mA).
- Short-circuit and earth fault proof.
- Integrated electronic motor protection via TK or PTC thermistor.
- Controller galvanically isolated.
- Overvoltage-proof
- Also suitable for switch cabinet installation.
- Power reduction at ambient temp. over 40 °C – 55 °C.

Type-specific features

Basic types:

- Additional power supply: 24 V DC/70 mA for wiring of digital inputs and additional external components.
- Includes internal, all-pole effective sine filter.
- For the simple retrospective extension of existing ventilation systems.

Comfort types:

- Free specification of acceleration and deceleration times to reduce start-up noises.
- Additional power supply: 24 V DC/120 mA for wiring of digital inputs and additional external components.
- Simple adjustment and control of values using display.
- Comprehensive diagnostic display in case of fault.
- Speed specification directly on unit via display.
- Serial interface RS 485 / Modbus-RTU.
- Parameterisable, performance adjustment as required.

Information

Internal, all-pole effective sine filter (Types FU-..S)

Filters the voltages between the individual phases as well as the phase voltage between phase and protective conductor. The output voltage of the frequency inverter is purely sinusoidal and corresponds to the quality of a standard mains voltage.

Earth leakage circuit breaker (all types)

When using FU in an environment where an earth leakage circuit breaker is required, it must be sensitive to universal currents, type B+, 300 mA.

EMC

All FU types comply with EMV Directive 2004/108/EC and the applicable standards, such as DIN EN 60335-1 and DIN EN 550011. Radio interference filters are integrated to comply with cl. B (living area).

The cable between the fan and frequency inverter must be shielded for FU-B and -C with a max. length of 10 m. The motor power supply and temp. monitoring system must be installed separately.

Design Motor current / Frequency

When selecting a suitable frequency inverter, the maximum motor current must be taken into account. When operating multiple fans, the sum of the individual flows must be applied. In order to prevent faults and failures, a 10% reserve should be planned. A max. frequency of 50 Hz must not be exceeded for controlling the speed of a standard fan, otherwise the motor will be overloaded and destroyed. Operation at a higher frequency is only possible upon request.

Motor protection

Maximum motor protection is achieved by monitoring (thermal contact/PTC thermistor), whereby max. 6 PTC thermistors can be connected in series to a unit. The number of PTC thermistors can be increased by using monitoring units (Type MSA, accessories).

Accessories

PU 24/PA 24 No. 01736/01737
Speed potentiometer, flush/surface, LED 24 V, poti 10 V/1.3–10 V.

SU-3 10/SA-3 10 No. 04266/04267
Three-step speed switch, flush/surface-mounted, 10 V/1.7–10 V.

WSUP Ref. no. 09990
Weekly timer with LCD display, potential-free contact.

WSUP-S Ref. no. 09577
Weekly timer potential-free contact, for DIN top hat rails.

EDR Ref. no. 01437
Elec. differential pressure controller 0–1000 Pa, 10–24 V / 0–10 V.

ETR Ref. no. 01438
Electronic temperature controller (sensor see accessories ETR).

LDF 500 Ref. no. 01322
Differential air pressure sensor, measurement range 0 to 500 Pa.

LGF 10 Ref. no. 01325
Air velocity sensor, measurement range 0 to 10 m/s.

LTA 40 Ref. no. 01336
External temperature sensor, measurement range –20 °C to +60 °C, protection category IP54.

LTK 40 Ref. no. 01324
Temperature sensor for rectangular duct installation, measurement range 0 °C to +40 °C.

LTR 40 Ref. no. 01323
Room temperature sensor, measurement range +0.5 °C to +40 °C.

AFS 0–10V Ref. no. 06532
Absolute humidity sensor, with 0–10 V control output.

AFS set 0–10V Ref. no. 07376
Set consisting of 2 sensors.

General technical data

Mains voltage 3~, 208 – 480 V
Mains frequency 50/60 Hz
Output voltage 95 % of U_{mains}
Output frequency 50 Hz
Protection category IP54
Ambient temperature 0 to +40 °C (–20 °C not current-free)

Type	Ref. no.	Maximum power		Cable cross sections from mains and to motor cable	Wiring diagram	Dimensions			Weight net aprx.	
		Output current	Motor			Height	Width	Deep		
		A	kW	mm ²	No.	mm	mm	mm	kg	
Basic design without sine filter for three-phase current fans, 3~, 400 V, 50/60 Hz, protection category IP54										
FU-B 3.6	05453	3.6	1.5	4 x 1.5 ¹⁾	1020	284	240	115	2.6	
FU-B 5.0	05454	5.0	2.2	4 x 1.5 ¹⁾	1020	302	250	196	4.6	
FU-B 7.0	05455	7.0	3.0	4 x 1.5 ¹⁾	1020	302	250	196	4.7	
FU-B 8.5	05456	8.5	4.0	4 x 1.5 ¹⁾	1020	302	250	196	5.6	
FU-B 12	05457	12.0	5.5	4 x 1.5 ¹⁾	1020	302	250	196	5.7	
FU-B 17	05458	17.0	7.5	4 x 1.5 ¹⁾	1020	302	250	196	5.9	
Basic design with all-pole effective sine filter for three-phase current fans, 3~, 400 V, 50/60 Hz, protection category IP54										
FU-BS 2.5	05459	2.5	2)	4 x 1.5	1028	284	240	115	2.7	
FU-BS 5.0	05460	5.0	2)	4 x 1.5	1028	302	250	196	5.2	
FU-BS 8.0	05461	8.0	2)	4 x 1.5	1028	302	250	196	6.3	
FU-BS 10	05462	10.0	2)	4 x 1.5	1028	302	250	196	6.8	
FU-BS 16	05463	16.0	2)	4 x 1.5	1028	302	250	196	6.9	
Comfort design without sine filter for three-phase current fans, 3~, 400 V, 50/60 Hz, protection category IP54										
FU-C 4.2	05865	4.2	1.5	4 x 1.5 ¹⁾	1030	302	250	195.5	6.4	
FU-C 8.5	05868	8.5	4.0	4 x 1.5 ¹⁾	1030	302	250	195.5	7.3	
FU-C 12	05869	12.0	5.5	4 x 1.5 ¹⁾	1030	302	250	195.5	7.5	
FU-C 17	05870	17.0	7.5	4 x 2.5 ¹⁾	1030	302	250	195.5	7.5	
FU-C 25	05464	25.0	11	4 x 4.0 ¹⁾	1030	355	280	239	12.5	
FU-C 32	05465	32.0	15	4 x 6.0 ¹⁾	1030	524	386	283	24.5	
FU-C 39	05466	39.0	18.5	4 x 10.0 ¹⁾	1030	524	386	283	26.3	
FU-C 46	05467	46.0	22	4 x 10.0 ¹⁾	1030	524	386	283	26.3	
FU-C 62	05468	62.0	30	4 x 16.0 ¹⁾	1030	524	386	283	26.3	
Comfort design with all-pole effective sine filter for three-phase current fans, 3~, 400 V, 50/60 Hz, protection category IP54										
FU-CS 2.5	05871	2.5	2)	4 x 1.5	1032	284	240	115	3.3	
FU-CS 8	05873	8.0	2)	4 x 1.5	1032	302	250	195.5	7.9	
FU-CS 10	05874	10.0	2)	4 x 1.5	1032	302	250	195.5	8.2	
FU-CS 14	05875	14.0	2)	4 x 1.5	1032	302	250	195.5	8.7	
FU-CS 18	05469	18.0	2)	4 x 2.5	1032	302	250	196	9.1	
FU-CS 22	05470	22.0	2)	5 x 4.0	1032	355	280	239	14.5	
FU-CS 32	05471	32.0	2)	4 x 6.0	1032	525	386	283	29.6	
FU-CS 40	05472	40.0	2)	4 x 10.0	1032	525	386	283	29.6	
FU-CS 50	05473	50.0	2)	4 x 16.0	1032	525	386	283	32.8	

¹⁾ Max. 10 m shielded, Motor power supply and protection installed separately.

²⁾ The max. current for all connected fans is decisive for the design.

EUR 6 C



Universal controller EUR 6 C
Electronic automatic controller with phase angle-controlled power unit.

Area of application

For control of central/ventilation systems or for the continuously variable control of one or more speed-controllable single phase fans. In the residential, commercial, industrial and agricultural sector.

Control functions

Quick and easy commissioning of parameters using the integrated "Commissioning assistant". The following control parameters can be controlled depending on the connected sensors:

- Manual speed control**, e.g. adjustable via keyboard
- Temperature** (required accessory Temperature sensor LTR 40 or LTK 40).
- Temperature with additional functions** pre-programmed, (required accessory Temperature sensor LTR 40 or LTK 40).
- Differential temp. control** (required accessory Temperature sensor LTR 40 or LTK 40).
- Differential pressure** (required accessory Differential air pressure sensor LDF 500).
- Differential pressure with outdoor temperature compensation** (required accessory Differential air pressure and temperature sensors LDF 500 and LTR 40 or LTK 40). Ideal for central ventilation systems according to DIN 18017 in residential buildings.
- Air velocity** (required accessory Air velocity sensor LGF 10).

The desired sensors must be ordered separately as accessories. The control ranges are freely adjustable within the sensor measurement ranges.

The controlled output voltage balancing the actual value and set-point value lies between 0% (35 V) and 100% (corresponds to approx. 80 V – 230 V).

The minimum and maximum values can be specified.

Main switch with positions:

- "0" = control unit off.
- "1" = automatic operation.
- "230 V" = uncontrolled direct mains operation.

Inputs and outputs:

- Outputs:**
- 1 x motor connection phase angle-controlled.
 - 1 x analogue output 0–10 V for controlling e.g. frequency inverter, valve, EC motor.
 - 2 x potential-free relay, programmable, alarm, heating or status reports.

Inputs:

- 2 x sensor inputs, programmable to the respective required sensor type.
- Connection of thermal contacts for motor protection.

When a TK is triggered, the entire system will deactivate and it must be manually reactivated once the motor has cooled down.

- 2 x digital inputs, can be programmed to release, external fault, limit on/off, switching night reduction, internal/external, control/manual operation, reset, max. speed on/off.

Possible settings

- Continuously variable specification of setpoints and control range.
- Min./max. power (speed) limit.

Mode 2.03: Temperature control with additional function
Mode 2.05: Differential temperature control

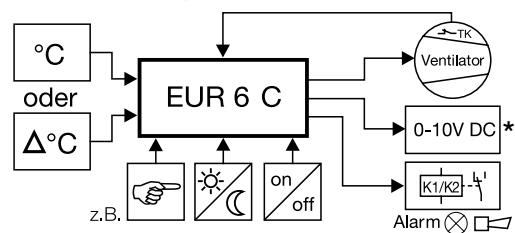

* e.g. for valve, frequency inverter.

Mode 4.01: Differential pressure control
Mode 6.01: Air velocity control

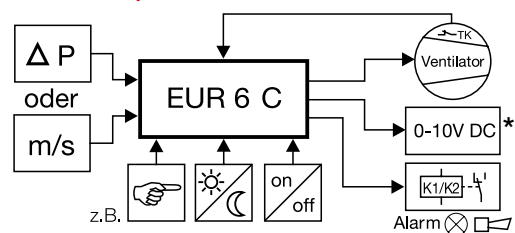

* e.g. for valve, frequency inverter.

- Minimum volume flow can be activated and deactivated.
- Connection of e.g. heating via programmable relay.
- Continuously variable specification for alarm signal if temperature is too high or low, output to display or also to relay.
- Min. and max. valve opening.
- Reversal of control function.
- Constant control of ventilation valves.
- Adjustment via a dirt-resistant membrane keyboard.

Display

- Multifunctional LC display.
- Numerical setpoint and actual value display with measurement unit.
- Symbols (alarm, heating, release).
- Bar/level display.
- Text display for menu, status and fault signals.

Required accessories

LDF 500 Ref. no. 01322
 Differential air pressure sensor, measurement range 0 to 500 Pa.

LGF 10 Ref. no. 01325
 Air velocity sensor, measurement range 0 to 10 m/s.

LTA 40 Ref. no. 01336
 External temperature sensor, measurement range –20 to +60 °C, protection category IP54.

LTK 40 Ref. no. 01324
 Temperature sensor for rectangular duct installation, measurement range 0 to +40 °C.

LTR 40 Ref. no. 01323
 Room temperature sensor, measurement range 0.5 to +40 °C.

EUR 6 C	Ref. no. 01321
Voltage	230 V~, 50/60 Hz
Max. load	6 A
Required minimum current	0.2 A
Controlled output voltage	0 – 100%
Temp. measurement range	0 – 40 °C
Pressure measurement range	0 – 500 Pa
Speed measurement range	0 – 10 m/s
Permitted ambient temp.	0 to +40 °C
Protection category	IP54
Casing	Surface installation, plastic, light grey
Dim. mm	W 223 x H 200 x D 131
Weight approx.	1.4 kg
Wiring diagram no.	911

References

Electronic speed control units can generate motor humming noises. Transformer control units should be used in noise-critical applications.



Universal control system EUR EC
Electronic automatic controller
with 0–10 V DC control output.

Area of application

For continuously variable control or control of single and three-phase EC fans with a setpoint input of 0–10 V DC.

Control functions

Quick and easy commissioning of parameters using the integrated "Commissioning assistant". The following control parameters can be controlled depending on the connected sensors:

- Manual speed control**, e.g. adjustable via keyboard
- Temperature** (required accessory Temperature sensor LTR 40 or LTK 40).
- Temperature with additional functions** pre-programmed, (required accessory Temperature sensor LTR 40 or LTK 40).
- Differential temp. control** (required accessory Temperature sensor LTR 40 or LTK 40).
- Differential pressure** (required accessory Differential air pressure sensor LDF 500).
- Differential pressure with outdoor temperature compensation** (required accessory Differential air pressure and temperature sensors LDF 500 and LTR 40 or LTK 40). Ideal for central ventilation systems according to DIN 18017 in residential buildings.
- Air velocity** (required accessory Air velocity sensor LGF 10).
- Differential absolute humidity control** (required accessory AFS..).

The desired sensors must be ordered separately as accessories. The control ranges are freely adjustable within the sensor measurement ranges.

The controlled output voltage balancing the actual value and setpoint value lies between 0% (0 V DC) and 100% (10 V DC). The minimum and maximum values can be specified.

Inputs and outputs:

Outputs:

- 2 x analogue outputs 0–10 V for controlling e.g. EC motor, frequency inverter, valve.
- 2 x potential-free relay, programmable, alarm, heating or status reports.

Inputs:

- 2 x sensor inputs, programmable to the respective required sensor type.
- 2 x digital inputs, can be programmed to release, external fault, limit on/off, switching night reduction, internal/external, control/manual operation, reset, max. speed on/off.

Possible settings

- Continuously variable specification of setpoints and control range.
- Min./max. power (speed) limit.
- Minimum volume flow can be activated and deactivated.
- Connection of e.g. heating via programmable relay.
- Continuously variable specification for alarm signal if temperature is too high or low, output to display or also to relay.
- Min. and max. valve opening.
- Reversal of control function.
- Constant control of ventilation valves.
- Adjustment via a dirt-resistant membrane keyboard.

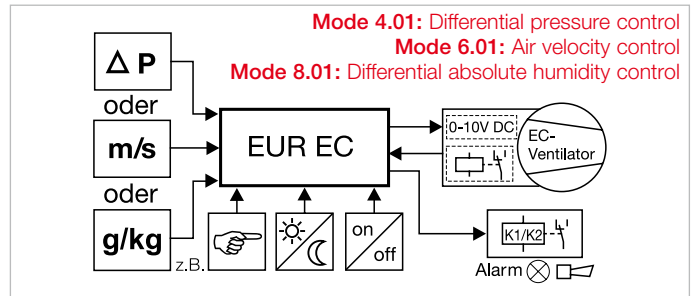
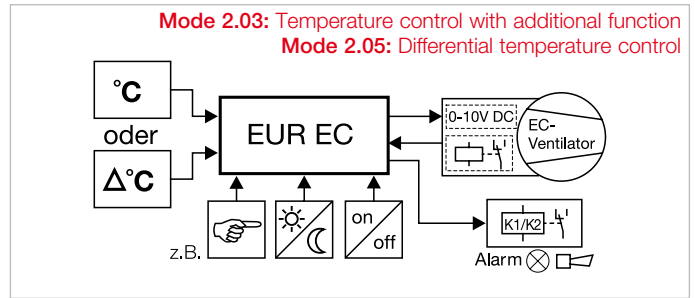

Display

- Multifunctional LC display.
- Numerical setpoint and actual value display with measurement unit.
- Symbols (alarm, heating, release).
- Bar/level display.
- Text display for menu, status and fault signals.

Accessories

LDF 500 Ref. no. 01322
Differential air pressure sensor, measurement range 0 to 500 Pa.

LGF 10 Ref. no. 01325
Air velocity sensor, measurement range 0 to 10 m/s.

LTA 40 Ref. no. 01336
External temperature sensor, measurement range –20 to +60 °C, protection category IP54.

LTK 40 Ref. no. 01324
Temperature sensor for rectangular duct installation, measurement range 0 to +40 °C.

LTR 40 Ref. no. 01323
Room temperature sensor, measurement range 0.5 to +40 °C.

AFS 0–10V Ref. no. 06532
Absolute humidity sensor, with 0–10 V control output, integrated measuring transducer and measuring transducers.

AFS set 0–10V No. 07376
Set consisting of 2 absolute humidity sensors, with 0–10 V control output, integrated measuring transducer and high long-term stability.

EUR EC	Ref. no. 01347
Voltage	230 V~, 50/60 Hz
Control output	0 – 10 V / max. 10 mA
Controlled output voltage	0 – 100 %
Temp. measurement range	0 – 40 °C
Pressure measurement range	0 – 500 Pa
Speed measurement range	0 – 10 m/s
Humidity measurement range	0...50 g/kg
Permissible ambient temp.	0 to +40 °C
Protection category	IP54
Casing	Surface installation, plastic, light grey
Dim. mm	W 223 x H 200 x D 131
Weight approx.	1.0 kg
Wiring diagram no.	1084

References

If necessary, multiple fans can be connected in parallel to one EUR EC depending on the fan type to be connected.

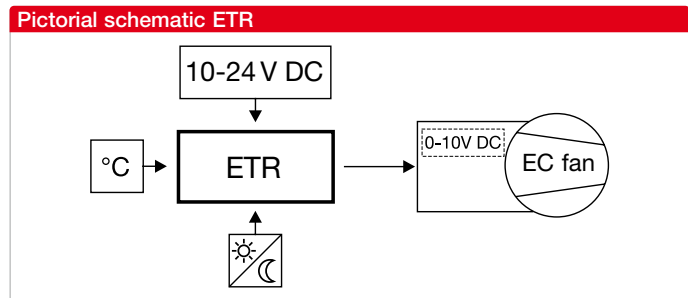
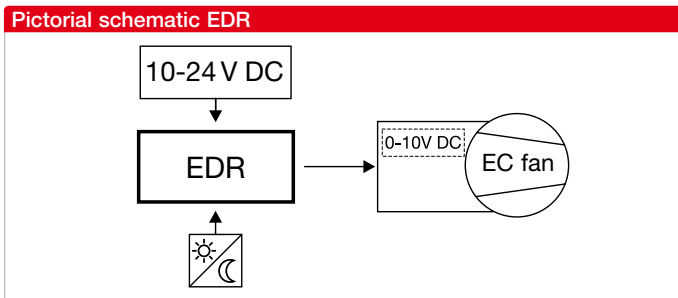

■ **Electronic controller for differential pressure or temperature**

□ **Area of application**

For continuously variable control of single and three-phase EC fans or frequency inverters with a setpoint input of 0–10 V DC. Provides the EC fan or frequency inverter with a supply voltage of 10–24 V DC/6 mA (safety extra-low voltage), the controller can be supplied directly from it, alternatively via a power supply unit (NG 24, accessories).

□ **Display**

- Multifunctional LCD display.
- Numerical setpoint and actual value display with measur. unit.
- Alarm, day/night operation.
- Text display for menu, status.

■ **Control functions**

Quick and easy commissioning of parameters using the LCD display and three internal input buttons. Permanent measurement display in LCD display. Optional parameterisation as

- **Actuator** = 0–10 V analogue output proportional to measured actual value as control variable for external controls or as
- **Controller** = controlled 0–10 V analogue output depending on the set setpoint and the measured actual value.

The controlled output voltage balancing the actual value and setpoint value lies between 0% (0 V DC) and 100% (10 V DC). The minimum and maximum values can be specified, two setpoints (e.g. for day/night operation) can also be set. Switching by means of weekly timer (types WSUP, WSUP-S, see accessories).

■ **Differential pressure controller EDR**

With fixed integrated pressure sensor and connections for pressure hoses (DN 5 mm, on-site).

- Adjustable pressure ranges: 0–1000 Pa, 0–500 Pa, 0–300 Pa, 0–200 Pa.

■ **Temperature controller ETR**

The controller is freely adjustable with the sensor measurement ranges, optionally in heating or cooling function, with adjustable minimum air shut-off.

- Temperature control range –50 to +150 °C.
- Appropriate sensors (types LTA, LTK, LTR, see accessories) are available for temperature measurement.

■ **References**

If necessary, multiple fans can be connected in parallel to EDR or ETR depending on the fan type to be connected.

■ **Accessories for EDR and ETR**

NG 24 Ref. no. 01439
Power supply unit for DIN top hat rail mounting, input 100–240 V AC, output 24 V DC/1.75 A. Required if fan type does not supply 10–24 V DC/6 mA.

WSUP Ref. no. 09990
Weekly timer.

WSUP-S Ref. no. 09577
Weekly timer for top hat rail mounting.

■ **Accessories for ETR**

LTA 40 Ref. no. 01336
External temperature sensor, measurement range –20 to +60 °C, protection category IP54.

LTK 40 Ref. no. 01324
Temperature sensor for rectangular duct installation, measurement range 0 to.

LTR 40 Ref. no. 01323
Room temperature sensor, measurement range 0.5 to +40 °C.

Type	Ref. no.	Power supply	Analogue outputs	Signal input	Perm. humidity	Protection category	Protection class	Permissible ambient temp.	Casing	Dim. mm	Weight	Wiring diagram
EDR	01437	10–24 V DC, 6 mA	0–10 V DC 10 V / 0.3 mA 24 V / 10 mA	10–24 V DC / 6 mA Switching setpoint 1/2 (day/night)	85 %	IP54	III (safety extra-low voltage, galvanically isolated)	–10 to +60 °C	Surf.-mount., plastic, light grey	W 137 H 106 D 56	250 g	1039
ETR	01438	10–24 V DC, 6 mA	0–10 V DC 10 V / 0.3 mA 24 V / 10 mA	10–24 V DC / 6 mA Switching setpoint 1/2 (day/night)	85 %	IP54	III (safety extra-low voltage, galvanically isolated)	–10 to +60 °C	Surf.-mount., plastic, light grey	W 137 H 106 D 56	200 g	1298

PU / PA



SU / SA



Pictorial schematic PU / PA

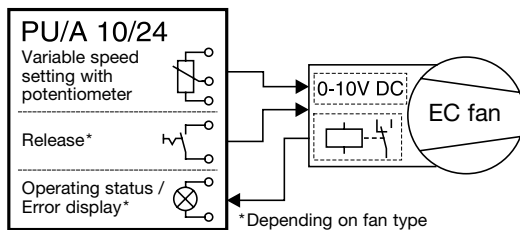

Pictorial schematic SU / SA

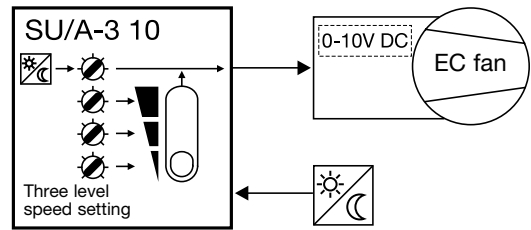

■ Speed potentiometer PU/PA with additional functions Switch and LED

- **Area of application**
For direct control/setpoint specification for EC fans with a potentiometer input. Also with release switch and LED display for operating status (depending on the fan type equipment).

- **Control with potentiometer**
The potentiometer is directly connected to the potentiometer input on the fan control. This has a potentiometer power supply of e.g. 10 V DC and a setpoint input of 0–10 V DC.

- **Minimum voltage**
A second potentiometer is integrated in the PU/PA. The minimum voltage (min. 1.3 V) is continuously variable, so that a safe motor start-up is guaranteed at the lowest speed setting.

- **Release switch**
The rotary knob for the potentiometer is also a pressure switch which can be used to activate/deactivate a fan with release input (e.g. 24 V DC).

- **Light ring with LED**
Optical indication of fan operating status. Changes from green (normal operation) to red (fault) for fans with operation signalling relay. Required supply voltage see technical data.

■ Product range

- **LED power supply 10 V**
PU 10 Ref. no. 01734
Installation in standard flush-m. box
Dim. mm W 80 x H 80 x D 21 prot.

- **PA 10** Ref. no. 01735
Casing Surf.-mounted installation, plastic, light grey
Dim. mm W 80 x H 80 x D 65

- **LED power supply 24 V**
PU 24 Ref. no. 01736
Installation, dimensions see PU 10

- **PA 24** Ref. no. 01737
Installation, dimensions see PA 10

■ Technical data for all types

Potentiometer 10 kOhm
(min. potenti. aprx. 7.9 – 16.5 kOhm)
A potenti. power supply of 10 V provides a control voltage 0 – 10 V DC.
Min. volt. 1.3 – 6.7 V DC adjustable.
LED supply voltage:
10/24 V DC (P 10/24), min. 6 mA
Perm. ambient temp. 0 to +40 °C
Protection category IP40
Wiring diagram no. 1000

■ Three level switch SU/SA 10 V / 0–10 V

- **Area of application**
Three level switch for flush-mounted or surface-mounted installation. Three level controlling of EC fans or frequency inverters with a 0–10 V DC control input.

- **Functions**
Three different setpoint specifications can be issued via SU/SA. Each level is freely definable from 0–10 V DC via a separate potentiometer. The connection of a weekly timer (WSUP, WSUP-S, accessories) for switching from 3 level day operation to e.g. night operation is also possible. Night/reduced operation can also be adjusted via another potentiometer from 0–10 V DC.

■ Product range

- **Flush-mounted SU-3 10** Ref. no. 04266
Install. deep flush-m. box (D 65 mm)
Dim. mm W 80 x H 80 x D 15 prot.

- **Surface-mounted SA-3 10** Ref. no. 04267
Protection category IP40
Casing Surf.-mounted installation, plastic, white
Dim. mm W 80 x H 80 x D 60

■ Technical data for all SU/SA types

Supply input: 10 VDC Ri=12.5 kOhm (safety extra-low voltage)
Internal consumption: 1.5 mA
Control output: 0 – 10 V DC either via switch or external switchover
Prot. category IP30 when installed
Protection class III
Wiring diagram no. 1022

■ References

If necessary, multiple fans can be connected in parallel to one speed potentiometer or three level switch depending on the fan type to be connected.

DDS



Function

Adjustable normally closed / normally open contact for monitoring drops in pressure and thus the contamination of air filters, fan pressure increases and ventilation system pressure levels.

Product range

Complete ready-to-install set consisting of:

- Differential pressure switch DDS
- 4 fixing screws
- 2 hose connections
- Connection hose
Ø 6 mm x 1.5 mm x 2000 mm
- Drilling template for connections
- Mounting plate + 3 fixing screws
- 3 screw terminals

Differential pressure switch DDS
DDS Ref. no. 00445

Area of application

- Complete installation set for monitoring air filters, system pressure and fan operation.
- Suitable for DDC applications due to the gold-plated connection contacts (24 V DC/0.1 A). When used in conventional technology (230 V AC/1.5 A), subsequent use in DDC applications is no longer possible.
- Suitable for applications according to VDI 6022.

Technical data

Adjustable meas. range	50 – 500 Pa
Switching differential Δp	20 Pa
Max. operating overpressure	5 kPa
Load capacity	230 V AC 1.5 (0.4) A 24 V DC 0.1 A
Ambient temp.	-20 to +85 °C
Air flow temp.	-20 to +85 °C
Humidity	0...50% RH, non-condensing
Protection category	IP54
Dimensions mm	Ø 104, D 58
Weight approx.	0.23 kg
Wiring diagram no.	490

TME 1



Function

- One-stage control thermostat for direct switching of one or more fans.
- Can also be used to control heating elements with optional connection.
- Potential-free change-over contact.

Description

- Closed casing made of break-resistant plastic, light grey. Cable insertion on underside of casing using clamping gland PG 11.
- Connection via terminal block after removal of casing cover.

One-stage thermostat TME 1
TME 1 Ref. no. 01334

Area of application

- Robust electronic thermostat for temperature-dependent on/off control of fans or heating elements.
- Suitable for installation in humid and dusty rooms. Surface installation in any position.

Technical data

Voltage	230 V~, 50/60 Hz
Load capacity	16 A
Max. current (AC 3)	6 A
Temperature range	0 to +50 °C
Switching accuracy	+/- 0.8 K at 20 °C
Protection class	II
Protection category	IP54
Ambient temp.	0 to +60 °C
Dim. mm	W 82 x H 80 x D 75
Weight approx.	0.2 kg
Wiring diagram no.	701
Connect. cable	NYM-0 4 x 1.5 mm ²

HY 3



Description

- Universally applicable hygrostat in elegant plastic casing for surface-mounted installation. Colour white.
- Setpoint adjustment from outside via rotary knob. Via internal scale for type HY 3 SI.

HY 3 SI



- Not suitable for dusty or aggressive air.
- Sensor element made of polyamide fibres.
- Also suitable for humidification with optional connection.

Ventilation hygrostat
HY 3 Ref. no. 01359

Ventilation hygrostat
HY 3 SI Ref. no. 01360

Internal scale.

Area of application

- Electromechanical humidity controllers for on/off fan control (control using contactor for 3~ three-phase current types), which reduce the room air humidity with the adequate air exchange.

Technical data

Relative operating range	25 to 90 %
Humidity	± 6 %
Switching differential approx.	± 6 %
Voltage max.	230 V~, 50/60 Hz
Load capacity	3 A (ind.)
Ambient temperature	0 – 40 °C
Protection category	IP20
Dim. mm	W 76 x H 76 x D 34
Weight approx.	0.25 kg
Wiring diagram no.	168.1

ACL



Air quality controller

ACL Ref. no. 00492

Area of application

- Electronic air quality controller for controlling:
 - 1~ alternating current fans
 - 3~ three-phase current fans using a contactor.

- For ventilation systems in conference rooms, restaurants, shops, production facilities, residential/community rooms.

Function

- Activation and deactivation of one or more fans depending on room air quality.

- The integrated sensor in the unit reacts to the oxidisable gases and odorous substances in the room air, such as carbon monoxide, alcohol, formaldehyde, benzene, solvents, methane, tobacco, etc.

Setting options

- Switching occurs when an adjustable setpoint is exceeded or a sharp increase in air pollution.
- Deactivation time with adjustable turn-off delay (adjustable from outside).
- Indicator light for operating mode (automatic/manual), fan operation and turn-off delay period.
- Function and operating mode switch on front of casing.

Casing

Flat casing with air exchange slots, made of light grey plastic, for surface-mounted installation.

Technical data

Voltage	230 V, 1~, 50/60 Hz
Turn-off delay time, adjust.	1 – 10 min.
Turn-on delay	approx. 5 sec.
Load capacity	2 A (ind.)
Protection category	IP30
Dim. mm	W 125 x H 75 x D 30
Weight approx.	0.2 kg
Wiring diagram no.	485.1

SWE



Electronic flow monitor

SWE Ref. no. 00065

Area of application

For monitoring the air flow in a duct section. Open-circuit or closed-circuit principle possible.

Function

The air flow sensor (combined with a control unit) detects the air flow and compares it to the specified setpoint.

This can be adjusted on the front of the control unit (in the range from 1–20 m/s).

The relay closes when the setpoint is reached/exceeded. Two LED's indicate UN and switching state of the output relay. Connection of external fault display possible via relay output (1 changeover contact, potential-free, max. switching current 5 A / AC 250 V).

Installation

Control unit suitable for switch cabinet installation for attachment to 35 mm mounting rails.

Air flow sensor with rose fixing for pipe/duct installation and connec-

tion cable (length 2.5 m; can extend to max. 10 m), which must be connected to the control unit.

Technical data

Voltage	230 V, 1~, 50/60 Hz
Load capacity	5 A (ind.) cos φ 0.4
Setpoint adjust. range	1 – 20 m/s
Air flow temperature	max. 60 °C
Ambient temperature	max. 60 °C
Protection category	IP20
Dim. mm	W 35 x H 90 x D 66
Sensor length mm	140
Weight approx.	0.4 kg
Wiring diagram no.	689.1

SWT



Mechanical flow monitor

SWT Ref. no. 00080

Area of application

- Mechanical flow monitor with adjustable release force for monitoring a minimum flow velocity in ducts and pipes from NW 315.

Design

Robust design with paddle made of stainless steel and device for mounting to outside of rectangular ducts.

Function

- Electrical switching possible as NC or NO.
- Signal triggered if flow velocity exceeds or falls below a critical value.
- Minimum adjustable flow velocities:
 - shortfall approx. 1.5 m/sec.
 - excess approx. 3 m/sec

Installation

Must be installed so that the paddle weight does not act with or against the spring force.

Technical data

Voltage	24 – 230 V AC, 50/60 Hz
Load capacity	15 (8) A (ind.)
Air temp. limits	- 40 ... + 85 °C
Protection category	IP65
Dimensions mm	
- Paddle	W 55, L 200, D 0.15
- Casing	W 140 x H 65 x D 62
Weight approx.	0.4 kg
Wiring diagram no.	557.1

EDTW



Differential temp. controller

EDTW Ref. no. 01613

Area of application and advantages

- Elec. continuously variable differential temp. controller for connection to elec. controllable
 - ceiling fans and all
 - 1~ alternating current fans.
- For constant speed control depending on the temperature differential.
- This controller saves valuable heating energy when used with ceiling fans or fans which circulate the room air from top to bottom. It optimises the temperature difference between the ceiling and floor.

Function

- Continuously variable speed control (0 – 100 %) depending on the difference value between the two temp. sensors and the comparison with the setpoint specification.
- Includes temperature sensors with external cable (1 x 10 m long, for installation below the ceiling; 1 x 2 m long, for installation above the floor.
- The speed increases within the proportional range when the temperature difference increases and the speed decreases when the difference decreases.
- Variable adjustment of proportional band from 1–10 K.

Setting options

- On/off (with function display).
- Automatic/manual operation.
- Change of direction of rotation.
- Proportional range.
- Summer operating mode:
 - As manual speed controller.
 - Motor humming noises can be generated during operation depending on the fan type.

Casing

Impact-resistant plastic, white, for surf. and flush-m. installation.

Technical data

Voltage	230 V, 1~, 50/60 Hz
Load capacity max.	2.5 A (T 40 E)
Control range adjustable	1 – 10 K
Protection category	IP20
Dim. mm	W 210 x H 85 x D 55
Weight approx.	0.7 kg
Wiring diagram no.	438
	609

CO₂ AP-A / CO₂ AP / CO₂ UP

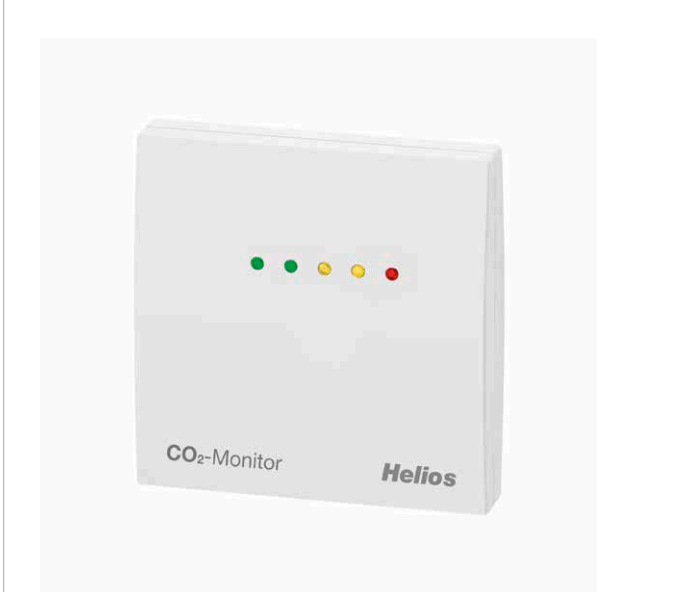

Dimensions CO₂ AP-A / CO₂ AP / CO₂ UP

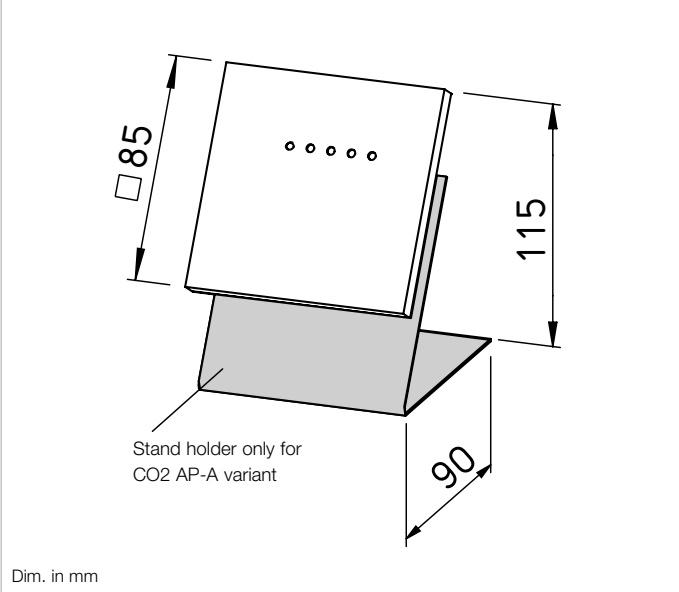

Maintenance-free CO₂ monitor with traffic light display, incl. power supply unit or power plug, self-calibrating, in elegant plastic casing. For determining the CO₂ content of the room air (0...3000 ppm) in individual rooms, such as class rooms, training and meeting rooms, offices, hotels, retail stores, etc. This enables energy-saving, needs-based room ventilation.

■ Unit variants

Standing unit with stainless steel stand holder (CO₂ AP-A), for direct wall installation (CO₂ AP) and for installation in flush-mounted boxes (CO₂ UP).

■ Casing

Plastic, material ABS, colour pure white (similar to RAL 9010).

■ Sensor

Optical NDIR sensor (non-dispersive infrared technology) with automatic calibration.

■ Air quality display

The measurement transducer converts the measurement variable into a standard signal that is visually displayed directly via five coloured LEDs (traffic light display). An acoustic signal can also be activated as an option.

■ Standards

CE conformity, electromagnetic compatibility according to EN 61326, EMC Directive 2014 / 30 / EU, Low-Voltage Directive 2014 / 35 / EU.

CO₂ AP-A

■ Installation

Mobile CO₂ measurement unit on stainless steel stand holder.

CO₂ AP / UP

■ Installation

Wall installation or in flush-mounted box, Ø 55 mm, base with 4 holes, for attachment to vertically or horizontally installed flush-mounted boxes for cable entry at rear. With predetermined breaking point for cable entry at top / bottom for surface mounting.

■ Reference

The unit must not be used for safety-related tasks.

Technical data	CO ₂ AP-A	CO ₂ AP	CO ₂ UP
Ref. no.	40109	40107	40108
Supply voltage	230 V AC (50 – 60 Hz)	230 V AC (50 – 60 Hz)	24 V AC / DC (+- 10%)
Electrical connection	Power supply unit 230 V / 50 - 60 Hz (included in scope of delivery)		
Measurement range	0...3000 ppm		
Measurement accuracy	typical +- 30 ppm +- 3% of measurement value		
Long-term stability	< 2% in 15 years		
Gas exchange	Diffusion		
Ambient temperature	0...+ 50 °C		
Start-up time	approx. 1 hour		
Response time	< 2 minutes		
Protection class	III (according to EN 60 730)		
Protection category	IP30 (according to EN 60 529)		
Equipment	Traffic light display (five colour LEDs, see table) for displaying the CO ₂ concentration, CO ₂ AP with plug-in power supply unit (conn. cable aprx. 1.5 m), CO ₂ UP for flush-mounting with flush-mounted power supply unit, CO ₂ AP-A with stainless steel stand holder and power supply unit with Micro-USB.		

FDR



Differential humidity controller incl. integrated sensor for inside humidity and temperature, external sensor for intake air humidity and temperature as well as the necessary switching power supply.

Area of application

- For controlling/regulating extract air fans depending on the absolute humidity difference between two measurement locations, e.g. inside the building and the outdoor environment using an internal sensor and external sensor for humidity and temperature.
- The internal sensor is housed directly in the electronic controller and the external sensor is housed in a casing for wall installation.

Features

- Non-ventilation periods can be programmed with the integrated weekly timer.
- The integrated anti-icing protection ensures that the room to be ventilated remains frost-free.
- The extract air fan can be manually activated for a pre-set turn-off delay period using standard switches, regardless of humidity-dependent ventilation operation.
- If ventilation is not required or if useful ventilation is not possible due to the inside and outside climate conditions, the controller will switch the extract air fan to an interval mode so that the preset regular air exchange takes place.

Additional switch output

- Allows the enabling of an additional external heater so that the minimum room temperature does not fall below the pre-set value while the fan ventilates the room.
- Or it can be programmed to operate an additional active external dehumidifier.

- Alternatively, it can be used for building control system signalling.

Control parameters FDR

- If the control parameter activation thresholds are exceeded, the room will be ventilated with the AC fan used in the room, which allows drier supply air to flow into the room.
- All single-phase Helios AC fans can be connected to the controller up to a max. current of 6 A.
- If fans with higher electrical outputs or three-phase current fans are required, a corresponding circuit breaker must be connected to the controller.
- If energy-saving EC extract air fans are used, the speed and thus the energy consumption will be reduced to a minimum depending on the absolute humidity difference.
- All Helios EC fans with a 0-10 V control input can be connected to the controller.

Control function

- The FDR is operational directly after installation due to its basic factory settings.
- All control parameters can be optimised in relation to the building using the free Helios FDR App.

Dimensions Internal controller for FDR

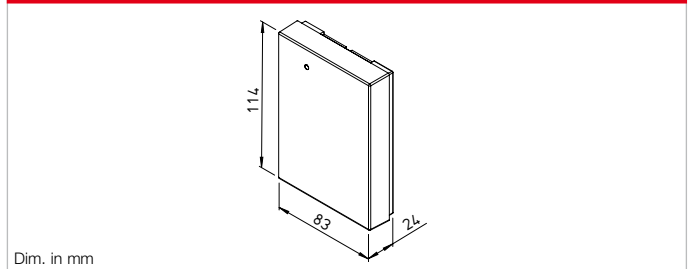

Dim. in mm

Dimensions External sensor for FDR

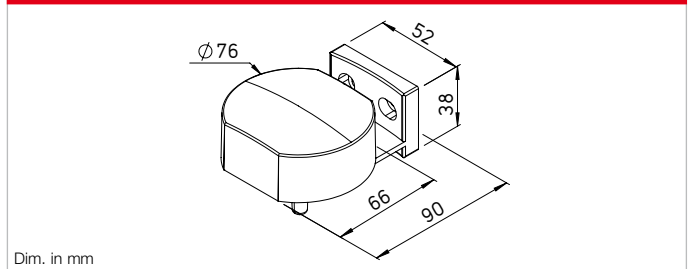

Dim. in mm

Pictorial schematic FDR

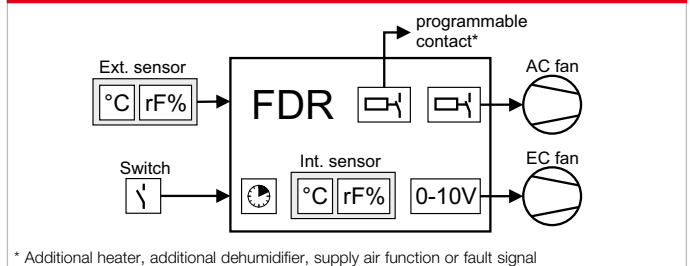

* Additional heater, additional dehumidifier, supply air function or fault signal

Helios FDR App

- All parameters can be changed at any time via the Bluetooth interface by using the free App.
- Software updates can be loaded on the controller via the App.
- The setting parameters and function history from the past few days can be read out via the App.



Technical data:

Type	FDR
Ref. no.	08157
Voltage	230 V~, 50 Hz
Power supply unit Controller	12 V DC
Switch output ON/OFF potential-free	max. 6 A, cos phi 0.95
Controlled output voltage	0-10 V / max. 2 mA / 0-100%
Max. temperature range	outside -30 °C – 55 °C inside 0 °C – 40 °C
IP external sensor	IP54
IP controller/internal sensor	IP20
Dimensions External sensor	DA 90 mm, H 40 mm
Dimensions Controller/internal sensor	114x83x24 mm
Wiring diagram no.	1381

Copyright

The copyright for text, graphic illustrations and photographic material of products lies exclusively with Helios Ventilatoren GmbH + Co KG, 78056 Villingen-Schwenningen · Germany.
Reprints of this catalogue, even in modified form, are only allowed with written authorization through Helios.

Technical modifications

All information and illustrations in this catalogue are non-binding and only an approximate description. We reserve the right to make modifications to the delivery item in comparison to the information and illustrations in this catalogue, e.g. with regard to technical data, construction, equipment, material and external appearance.



Τηλ: 211 - 70.55.500 & 210 - 21.30.051, Fax: 210 - 22.23.283



Helios Ventilatoren GmbH + Co KG · Lupfenstraße 8 · 78056 Villingen-Schwenningen · Germany
Phone +49 77 20 / 606 - 0 · Fax +49 77 20 / 606 - 257 · export@heliosventilatoren.de · www.heliosventilatoren.de

KWL® is a registered trademark of Helios Ventilatoren GmbH + Co KG. Copyright ©: Helios Ventilatoren GmbH + Co KG, 78056 VS-Schwenningen, Germany.
Certified according to ISO 9001/2015. Subject to technical modifications. Illustrations and information are non-binding. Document no. 90 718.844 / 11.22