

- CAN BE EASILY AND QUICKLY INSTALLED
- MOUNTED USING COMPLETE MODULES OR KIT
- INTEGRATED SOLUTION
- UNIT FULLY CALIBRATED AND TESTED
- FAST REACTION UNITS FOR CHAOTIC EVACUATIONS



KIT BOXPDS



HATCH PDS

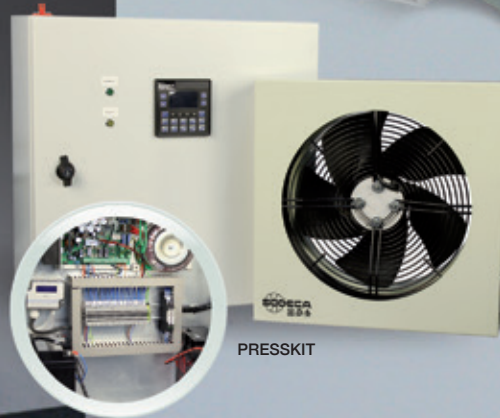

PRESSKIT



KIT SOBREPRESIÓN

# PRESSURISATION CONTROL SYSTEMS

FOR STAIRCASES, FIRE-FIGHTING LOBBIES AND ESCAPE ROUTES



EN-12101-6  
Smoke and heat control  
systems: Specifications  
for differential pressure systems



Certified: NR331151



**AIRTECHNIC**  
www.airtechnic.gr

Air-Conditioning & Ventilation Components & Systems



## OUR COMMITMENT TO THE ENVIRONMENT

Sodeca has embarked on a new phase of studying and designing new ventilation trends to help protect the environment and save energy, both matters of great concern for modern society.



### EFFICIENT WORK

SODECA presents its new “**Efficient Work**” high performance fans, fitted with next-generation motors to obtain higher energy savings. These new products exceed the requirements of the ErP 2009/125/CE Ecodesign Directive and its regulating provisions (EU) 327/2011 for fans, collaborating with the EU KYOTO Protocol objective of reducing carbon emissions.

**SODECA** focuses its business activity on the manufacture of industrial fans, ventilation systems and smoke extractor fans for fire protection since it was set up in 1983.

The fans and extractor fans manufactured by **SODECA** are present in Europe and in many other parts of the world due to their quality and the research and development methods used.

Our quality procedures, certified by BUREAU VERITAS in accordance with ISO 9001:2008, are another reason why **SODECA** is positioned as one of the best and most recognised fan manufacturer in Europe.

There is no doubt that the most important element in achieving our objectives is the human factor and the professionals who work in the company and offer not only ventilation equipment but solutions to all the needs of our customers in the ventilation sector.

We offer them the option of visiting our facilities in Sant Quirze de Besora, with a developed surface area of more than 16,000 m<sup>2</sup>, to see our fan production plant, which complies with the highest quality requirements and with the ISO and AMCA standards.

This catalogue contains just a few of all the options we offer. Please contact us and we will place all our experience and staff at your disposal.



Headquarters of SODECA S.L.U., in Sant Quirze de Besora



# PRESSURISATION CONTROL SYSTEMS

SODECA pressurisation control systems have been designed in accordance with European standards and with European standard "EN 12101-6 Smoke and heat control systems: Specifications for differential pressure systems

The overpressure smoke control method consists of pressurisation by injecting air into spaces which are used as escape routes by people in the case of fire, such as stairwells, corridors, passageways, lifts, etc. This method is based on smoke control by means of the speed of air and the artificial barrier created by the overpressure.

In accordance with the European standard, there are different classes of differential pressure systems in buildings, depending on their use.

System class	Examples of use
Class A system:	As a means of escape. On-site protection:
Class B system:	As a means of escape and fire fighting
Class C system:	As a means of escape via simultaneous evacuation
Class D system:	As a means of escape. Risk to persons who are sleeping
Class E system:	As a means of escape with evacuation in phases
Class F system:	Fire protection system and escape means:

In selecting and classifying the system for each specific case, it is necessary to consider the building use, size and evacuation instructions in the event of fire, as this choice will determine the necessary flow rate delivered by the pressurisation equipment. It is very important to pay special attention to the choice of the system as, depending on its class, different flow rates will be required.

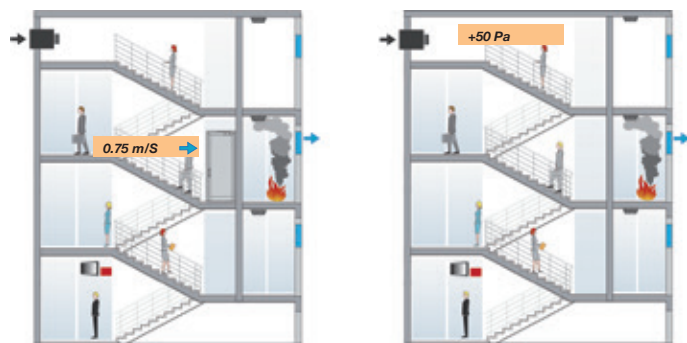

# SYSTEM CLASS

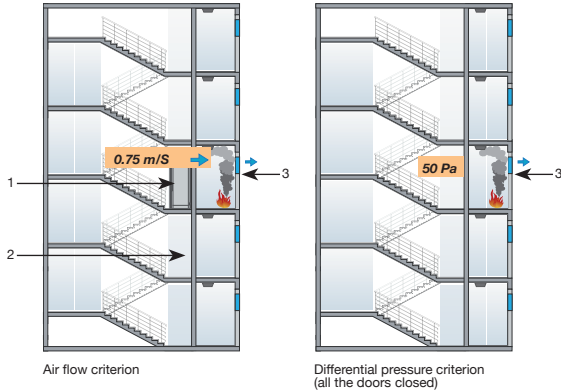

## CLASS A SYSTEM

The project conditions are based on assuming that the building will not be evacuated unless it is directly threatened by the fire.

The level of compartmentalisation of the fire is normally safe for the occupants who remain inside the building.

Therefore it is not very likely that more than one door will be open at the same time in the protected space (either between the stairs and the lobby / corridor or the final exit door).

- 1. Door open
- 2. Door closed
- 3. Air emission flow
- \*An open door may indicate a free passage of air through one lobby

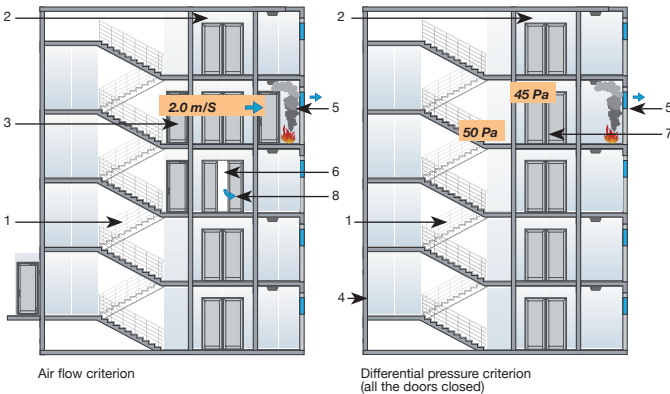

## CLASS B SYSTEM

A class B differential pressure system may be used to minimise the possibility of serious smoke contamination of the fire control stations during the evacuation of persons and while the fire fighters are extinguishing the fire.

During the extinguishing operations, it will be necessary to open the door between the lobby and the living quarters to fight a potentially developed fire.

- 1. Fire stairs
- 2. Fire fighting lobbies
- 3. Door open
- 4. Door closed
- 5. Air exhaust openings
- 6. Door open (fire fighting lobbies)
- 7. Door closed (fire fighting lobbies)
- 8. Air flow from fire fighter lift shaft

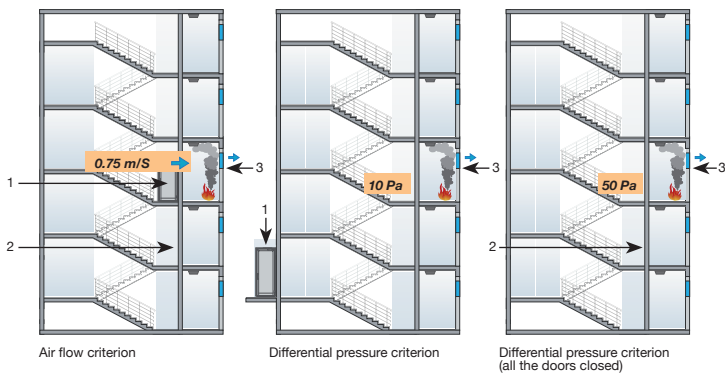

## CLASS C SYSTEM

Class C systems are designed for all the occupants of the building to be evacuated at once when the fire alarm is activated.

In the case of a simultaneous evacuation, it is assumed that the stairs will be occupied for the normal evacuation period and then be free of people. Thus, the evacuation will take place during the first stages of the fire development, and during this period, it is accepted that a certain volume of smoke may reach the staircase.

The air flow contributed by the pressurisation system can eliminate that smoke from the staircase.

It is assumed that during the evacuation, the occupants will remain alert and ready, and be familiar with the area in which they are moving, with the ensuing reduction of the time they remain inside the building.

- 1. Door open
- 2. Door closed
- 3. Air exhaust openings
- \*The figure may include lobbies

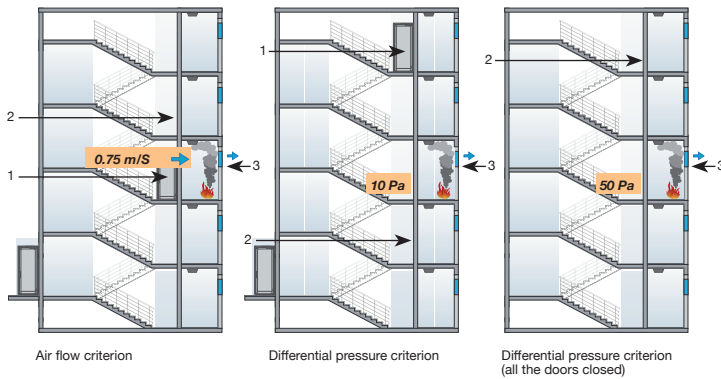

## CLASS D SYSTEM

Class D systems are designed for buildings where the occupants may be sleeping, for example, hotels, shelters and boarding establishments. The time necessary for the occupants to move in a protected space before reaching the final exit may be longer than that expected in the case of persons who are awake and in good physical condition, and the occupants may not be familiar with the building or need help to reach the final exit / protected space.

1. Door open  
2. Door closed  
3. Air exhaust openings  
\*The figure may include lobbies

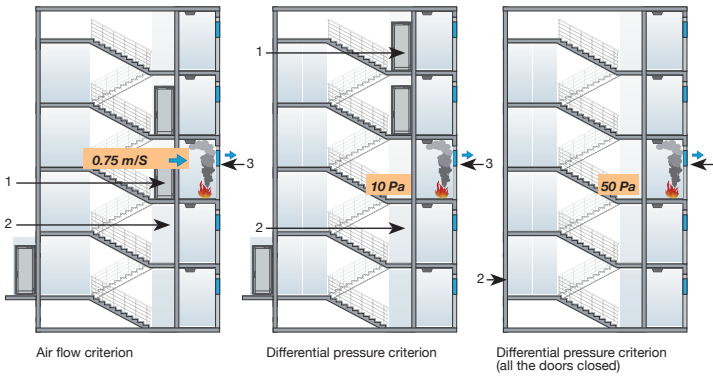

## CLASS E SYSTEM

They are used in buildings where fire evacuation is done by phases or as staggered evacuations.

In "evacuation by phases" it is considered that the building would still be occupied for a considerable time while the fire is developing, and so higher fire loads must be considered and hence, a larger volume of smoke and hot gases. (These factors may vary considerably, depending on the type of material in combustion, the fire load generated by them and the load geometry).

In such a situation, the protected staircases must be kept free of smoke to allow the safe evacuation of the people occupying the floors where there is no fire.

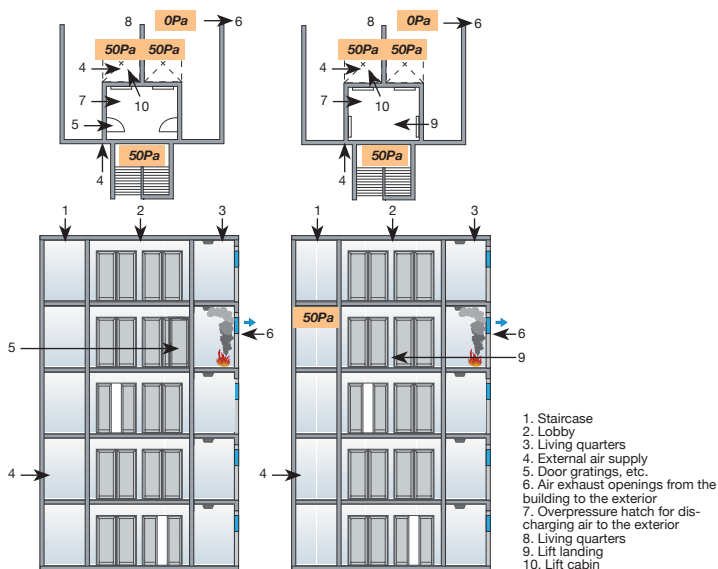

## CLASS F SYSTEM

Class F differential pressure systems are used to minimise the possibility of serious smoke contamination of the staircases that are used by fire fighters while the building is being evacuated and while the fire fighters are extinguishing the fire.

During the extinguishing operations, it will be necessary to open the door between the lobby and the living quarters to fight a potentially developed fire.

This system must be designed so that the stairwell and lift shaft (if any) remain free of smoke. If the smoke enters the lobby, the staircase pressure must not lead the smoke to the shaft, and vice versa.



### Differential pressure criterion

SYSTEM CLASS	A	B	C	D	E	F
Differential pressure between staircase and living quarters (all the doors closed)	50 Pa	50 Pa	50 Pa	50 Pa	50 Pa	50 Pa
Differential pressure on both sides of the living quarters door (final exit door open)	-	-	10 Pa	10 Pa	10 Pa	-
Doors open (differential pressure criterion) Final exit to exterior	NO	NO	YES	YES	YES	NO
Doors open (differential pressure criterion) Fire floor	NO	NO	NO	NO	NO	NO
Doors open (differential pressure criterion) No. of floors other than fire floor	0	0	0	1	2	0
Differential pressure (between lobby and living quarters)	45 Pa*	45 Pa	45 Pa*	45 Pa*	45 Pa*	45 Pa
Differential pressure (between life shaft and living quarters)	-	50 Pa	-	-	-	50 Pa

### Air flow criterion

SYSTEM CLASS	A	B	C	D	E	F	
						Situation 1	Situation 2
Air speed at fire floor door (doors open)	-	2 m/S	0.75 m/S	0.75 m/S	0.75 m/S	-	1 m/S
Air speed at fire floor staircase (doors open)	0.75 m/S	-	-	-	-	2 m/S	-
Doors open Final exit to exterior	NO	YES	NO	YES	YES	YES	YES
Doors open Lift	NO	YES	NO	NO	NO	YES	NO
Doors open Staircase – fire floor lobby	YES	YES	YES	YES	YES	YES	NO
Doors open Staircase – lobby on floor other than fire floor	NO	YES	NO	NO	NO	YES	NO
Doors open Fire floor	YES	YES	YES	YES	YES	YES	YES
Doors open No. of floors other than fire floor	0	0	0	0	1	0	0

\*It is not mandatory to pressurise the lobby if it only has doors connecting it with the staircase and floors.



## Response time

All the systems must be designed so that the force to be applied to the door handle to open it does not exceed 100N.

The SODECA equipment has next-generation, built-in controls that meet the most stringent requirements and are extremely reliable in the face of changes in situation that may occur during a fire, and in “chaotic” evacuation situations in which doors between fire zones and in pressurised smoke-free areas are opened and closed at random. Our systems react quickly and precisely to such changes, always ensuring an Overpressure of 50Pa for closed doors and maintaining the required air speed in each open door situation. This response capacity guarantees that the force used to open a door does not exceed 100N, as set out in European standards.

- t1: Opening of door (1 second)
- t2: Door open The system delivers 100% of the necessary flow rate in less than 6 seconds
- t3: Closing of door (3 seconds)

The SODECA equipment fully complies with the following reaction times:

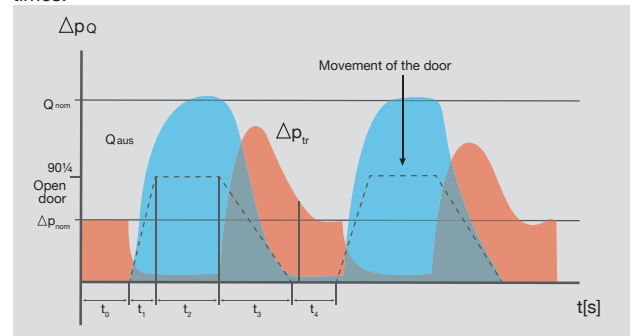

- t4: Door closed The system acquires the nominal pressure in less than 6 seconds, thus preventing prolonged excess pressure and ensuring that the force used on the door handle is no greater than 100N.

## Examples of application

The SODECA systems offer different types of equipment to satisfy all installation needs, depending on the building in which the pressurisation control system is used.

When selecting the equipment, it is important to consider where it will be installed and determine how the external air will enter and its delivery to the pressurised zone, based on the following recommendations:

### Intake of external air

The external air inlet must be far from areas where there is a risk of fire, to ensure the entry of clean air through the pressurisation system. In the event of an indoor installation, two air intakes will be needed, at a considerable distance from each other, and fitted with smoke detection systems so that if smoke enters through one of the nozzles, it can be closed automatically by a motorised damper (DAMPER KIT) or another equivalent system.

### Delivery of air to the interior

A single air delivery point to the pressurised zone is accepted for buildings less than 11 metres in height. For taller buildings, an air entry point must be provided for every three floors, using for example diffusers and an air conduit throughout the entire staircase.

### In technical room

#### BOXPDS KIT / KIT SOBREPRESIÓN



### On the roof

#### BOXPDS KIT / HATCH PDS / KIT SOBREPRESIÓN

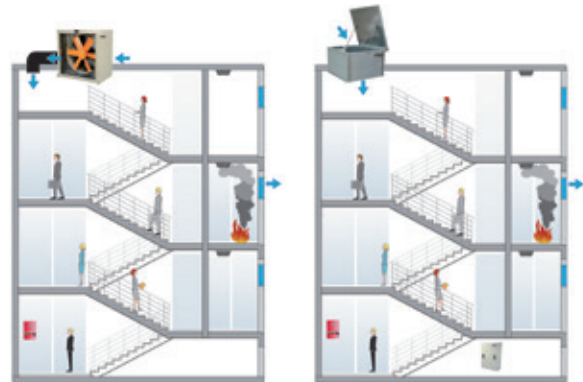

### In separate lobby

#### PRESSKIT / KIT SOBREPRESIÓN





## REAL-LIFE SIMULATION TESTS

All the equipment manufactured by SODECA is subject to stringent tests in real-life simulations using our installations and our test camera with fire doors, motorised dampers for leakage simulation and fire rated door opening/closing operations, in accordance with standard EN-12101-6 Smoke and heat control systems: Specifications for differential pressure systems

Equipment certified by independent laboratories



Certified: NR331151



EN-12101-6  
Smoke and heat control  
systems: Specifications  
for differential pressure systems

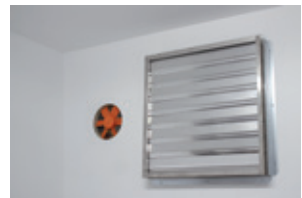
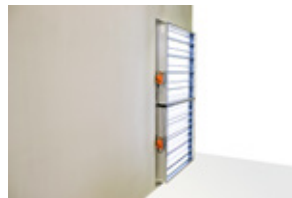

## REMOTE CONNECT START CONTROL

SODECA goes one step further, adapting to new market needs and offering a response to new technological demands. Our systems include advanced options and connectivity to facilitate the supervision and maintenance of the equipment, once installed in any building.

Any BMS (Building Management System) system can be connected to our equipment via the Modbus protocol, allowing end users or maintenance services to supervise the status and correct operation of the systems at all times.

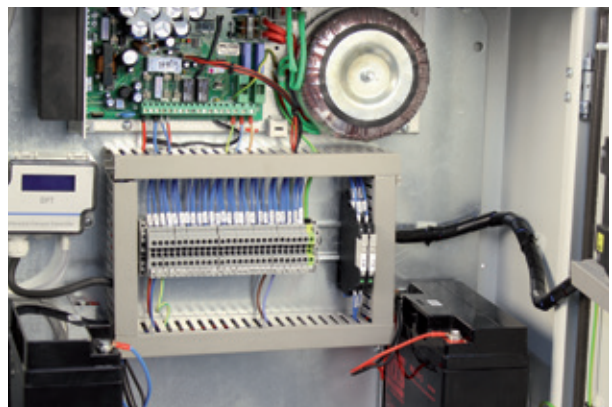



## PRESSURISATION CONTROL SYSTEMS

FOR STAIRCASES, FIRE FIGHTING LOBBIES AND ESCAPE ROUTES

### KIT SOBREPRESIÓN



Staircase, escape route or confinement pressurisation system

10

### KIT BOXPDS



Staircase, escape route and fire fighting lobby pressurisation equipment

14

### HATCH PDS



Staircase, escape route and fire fighting lobby pressurisation equipment

16

### PRESSKIT



Fire fighting lobby pressurisation equipment

20

# KIT SOBREPRESIÓN

**The staircase, escape route or confinement pressurisation system enables automatic control of the flow rate and the maintenance of a differential pressure of 50 Pa in a single phase, based on standard UNE EN 12101-6-2006**

STAIRCASE OVERPRESSURE KIT  
For three-phase equipment



## STAIRCASE OVERPRESSURE KIT

- Overpressure kit comprised of a control panel (BOXPRES KIT) and discharge units (CJHCH or CJBD), for pressurising staircases and escape routes. Also available for NEOLINEO AND CJBC single-phase equipment.

## OVERPRESSURE KIT WITH RESERVE FAN

- Overpressure kit comprised of a control panel (BOXPRES KIT II) with a built-in automatic switching system that maintains the overpressure in the event of a failure in the main fan and air discharge units with a TWIN or CJHCH/DUPLEX series reserve fan.

STAIRCASE OVERPRESSURE KIT  
For single-phase equipment



## BOXPRES



- Easy to install
- A compact, autonomous solution
- Preventive maintenance
- Easy start-up
- Safe, functional installation



- The correct operation of the pressurisation systems depends not only on their sound design, but on the correct regulation performed by the system. For this reason, it is extremely important to have calibrated, high precision regulation elements that will permit both situations present in the event of a fire to be maintained simultaneously, quickly and stably.
- The BOXPRES control panel not only complies with the strictest requirements, it simplifies the work for the installer.

OVERPRESSURE KIT WITH RESERVE FAN



It includes:

- A frequency changer programmed at 50 Pa.
- A differential pressure sensor.
- A magneto thermal switch.
- A line and failure led lamp.
- A check push button.

BOXPRES:

- All the equipment interconnections are made and tested.
- Ready to operate and execute its mission of controlling the installation pressure.
- Option of checking the installation to prevent failures.
- Only the power supply line, discharge fan and fire signal need to be connected.

The single-phase panels include:

- A voltage adjuster programmed at 50 Pa.
- A differential pressure sensor outside the equipment.

## Order code

**KIT SOBREPRESIÓN — 7.100**

Kit sobrepresión Staircase overpressure unit  
Kit sobrepresión II: Overpressure unit with reserve fan

Maximum flow rate

## Technical characteristics

Model	Power supply	Outlet	Discharge unit	Flow rate (m³/h)	Irradiated noise level * dB(A)
KIT SOBREPRESION-1060-LED	230 Vac II	230 Vac II	NEOLINEO-200	1060	38
KIT SOBREPRESION-2300-LED	230 Vac II	230 Vac II	NEOLINEO-315	2300	47
KIT SOBREPRESION-2880-LED	230 Vac II	230 Vac II	CJBC-2828-6M 1/3	2880	61
KIT SOBREPRESION-7100-LED	230 Vac II	230 Vac III	CJHCH-45-4T-0.5	7100	55
KIT SOBREPRESION-7800-LED	230 Vac II	230 Vac III	CJBD-3333-6T-1.5	7800	55
KIT SOBREPRESION-12900-LED	230 Vac II	230 Vac III	CJHCH-56-4T-1	12900	60
KIT SOBREPRESION-17000-LED	230 Vac II	230 Vac III	CJHCH-63-4T-1.5	17000	61
KIT SOBREPRESION-7100-BOX	400 Vac III	400 Vac III	CJHCH-45-4T-0.5	7100	55
KIT SOBREPRESION-7800-BOX	400 Vac III	400 Vac III	CJBD-3333-6T-1.5	7800	55
KIT SOBREPRESION-12900-BOX	400 Vac III	400 Vac III	CJHCH-56-4T-1	12900	60
KIT SOBREPRESION-17000-BOX	400 Vac III	400 Vac III	CJHCH-63-4T-1.5	17000	61
KIT SOBREPRESION II-6240-BOX	400 Vac III	400 Vac III	TWIN-12-6T-1.5	6240	55
KIT SOBREPRESION II-9520-BOX	400 Vac III	400 Vac III	TWIN-15/15-6T-3	9520	54
KIT SOBREPRESION II-12900-BOX	400 Vac III	400 Vac III	CJHCH/DUPLEX-56-4T-1-H	12900	60
KIT SOBREPRESION II-17000-BOX	400 Vac III	400 Vac III	CJHCH/DUPLEX-63-4T-1.5-H	17000	61
SI-PRESIÓN TPDA					
SI-PRESIÓN TPDA w/DISPLAY					
BOXPRES KIT-3A 230Vac	230 Vac II	230 Vac II			
BOXPRES KIT-10A 230Vac	230 Vac II	230 Vac II			
BOXPRES KIT-0.75KW 230Vac	230 Vac II	230 Vac III			
BOXPRES KIT-1.5KW 230Vac	230 Vac II	230 Vac III			
BOXPRES KIT-0.75KW 400Vac	400 Vac III	400 Vac III			
BOXPRES KIT-1.5KW 400Vac	400 Vac III	400 Vac III			
BOXPRES KIT-2.2KW 400Vac	400 Vac III	400 Vac III			
BOXPRES KIT II-1.5KW 400Vac	400 Vac III	400 Vac III			
BOXPRES KIT II-2.2KW 400Vac	400 Vac III	400 Vac III			

## Dimensions mm

### CJHCH

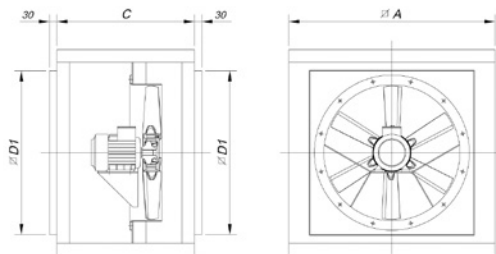

Model	∅A	C	∅D1
CJHCH-40/45/50	700	550	565
CJHCH-56/63	825	550	690

### CJBD

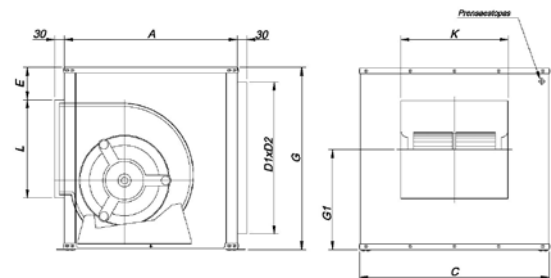

Model	Equiv. inches	A	B	C	E	D1xD2	G1	L	K
CJBD-3333	12/12	650	650	700	92	556X606	379	358	400

**Dimensions mm**

**TWIN**

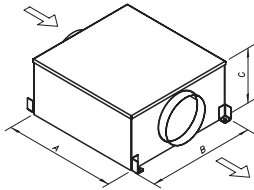

Model	A	B	C
TWIN-12/12	1103	1139	610
TWIN 15/15	1279	1639	698

**CJHCH/DUPLEX**

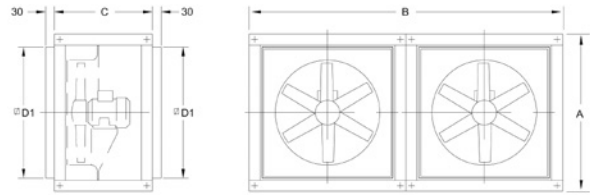

Model	ØA	B	C	ØD1
CJHCH/DUPLEX-56/63	825	1650	550	690

**NEOLINEO**

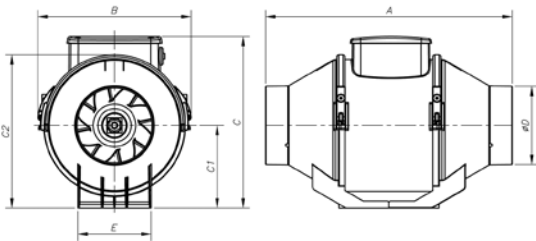

Model	A	B	C	C1	C2	øD	E
NEOLINEO-200	300	234.5	260.5	125.5	235	196	140
NEOLINEO-315	448	361.5	392.5	188.5	359	312	220.5

**CJBC**

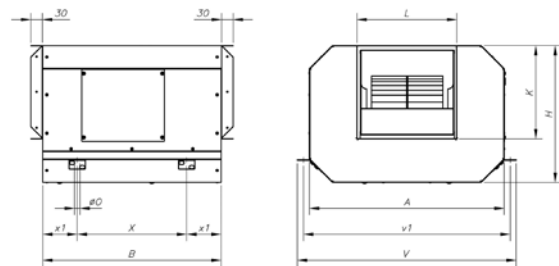

Model	A	B	H	K	L	øO	V	v1	X	x1
CJBC-2828-6M-1/3	696	645	460	290	320	15755	725	445	100	

**BOXPRESS KIT SOBREPRESIÓN**

**Technical characteristics and dimensions**

Model	Power kW	Power supply (V/Hz)	Outlet (V/Hz)	Outlet current (A)	Size	Measurements (length x width x depth)
BOXPRES KIT-3A 230Vac	-	230 Vac II	230 Vac II	3	-	255 x 170 x 140 mm
BOXPRES KIT-10A 230Vac	-	230 Vac II	230 Vac II	10	-	255 x 170 x 140 mm
BOXPRES KIT-0.75kW 230Vac	0.75	230 V II / 50Hz	230 V III / 50Hz	4.3	1	270 x 270 x 170 mm
BOXPRES KIT-1.5kW 230Vac	1.5	230 V II / 50Hz	230 V III / 50Hz	7	1	270 x 270 x 170 mm
BOXPRES KIT-0.75kW 400Vac	0.75	400 V III / 50Hz	400 V III / 50Hz	2.2	1	270 x 270 x 170 mm
BOXPRES KIT-1.5KW 400Vac	1.5	400 V III / 50Hz	400 V III / 50Hz	4.1	1	270 x 270 x 170 mm
BOXPRES KIT-2.2KW 400Vac	2.2	400 V III / 50Hz	400 V III / 50Hz	5.8	2	360 x 360 x 205 mm

**Equipment cable entry gland**

**BOXPRES KIT-3A / KIT-10A**

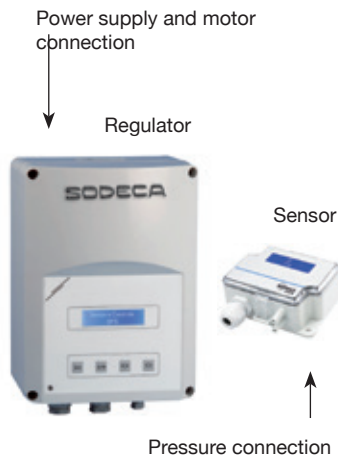

**BOXPRES KIT size 1 and 2**

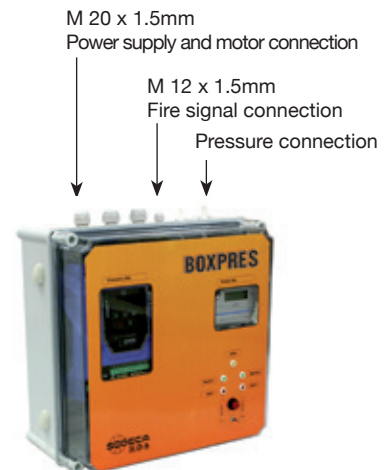

**BOXPRES KIT SOBREPRESIÓN II**

For equipment with a reserve fan

**Technical characteristics and dimensions**

Model	Power kW	Power supply (V/Hz)	Outlet (V/Hz)	Outlet current (A)	Size	Measurements (length x width x depth)
BOXPRES KIT II - 1.5KW 400Vac	1.5	400 V III / 50Hz	400 V III / 50Hz	4.1	1	270 x 270 x 170 mm
BOXPRES KIT II - 2.2KW 400Vac	2.2	400 V III / 50Hz	400 V III / 50Hz	5.4	2	360 x 360 x 205 mm

\* Both motors will never operate simultaneously

**Equipment cable entry gland**

**BOXPRES KIT size 1 and 2**

M 20 x 1.5mm  
Power supply and motor connection

M 12 x 1.5mm  
Fire signal connection  
Pressure connection



**Example of application**

The overpressure smoke control method consists of pressurisation by injecting air into spaces which are used as escape routes by people in the case of fire, such as stairwells, corridors, passageways, lifts, etc., especially in tall buildings with large occupancy. The method is based on smoke control by the air speed and the artificial barrier created by air overpressure, preventing it from entering the escape routes.

# KIT BOXPDS

## Pressurisation equipment for staircases, escape routes and fire fighting lobbies, pursuant to European standard EN 12101-6

Pressurisation equipment for escape routes in the event of a fire, pursuant to the requirements of European standard EN 12101-6. The BOXPDS KIT automatically regulates the air flow and is able to maintain the 50 Pa overpressure, even in the presence of leakages in the installation. The system can maintain the overpressure (pressure criteria) and a speed of 0.75 m/s in an open door situation (airflow criteria) almost immediately.

### KIT BOXPDS

- It is comprised of the BOXPDS control panel, a CJHCH ventilation unit and a Damper Kit with a built-in optical smoke sensor.

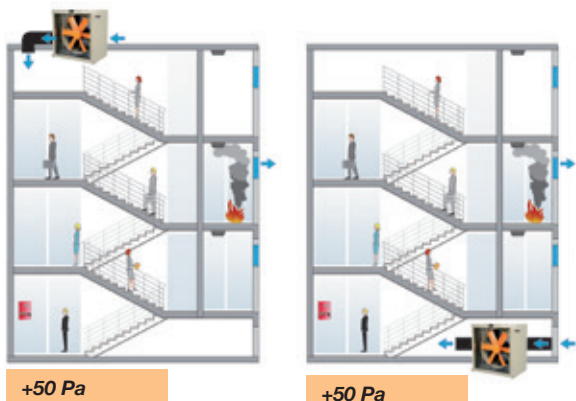

- Easy to install
- A compact, autonomous solution
- Preventive maintenance
- Easy start-up
- Safe, functional installation



BOXPDS



### BOXPDS

- Variable Frequency Drive.
- High precision differential pressure sensor.
- Electric panel with magneto thermal protections and general power supply failure indication.
- Electronic control for the management of alarms, maintenance, ModBUS RTU port for BMS (Building management systems) connection and DAMPER control.
- Certified power supply with batteries to ensure power supply to control equipment in the event of a power failure.

### Control panel:

- External control panel for real-time viewing of pressure, alarm pilot lamps and manual system activation



### Order code

**KIT BOXPDS — 800 — 5.5**

Pressurisation equipment for staircases, escape routes and fire fighting lobbies

Fan diameter

Power (HP)

### Technical characteristics

Model	Speed (r/min)	Max. admissible current 400V (A)	Installed power (kW)	Maximum flow rate (m <sup>3</sup> /h)	Irradiated NPS dB(A)	Approx. weight (Kg)
BOXPDS-710-1.5	1400	2.32	1.1	19750	75	188
BOXPDS-710-2	1430	3.44	1.5	21100	75	190.5
BOXPDS-710-3	1445	4.83	2.2	23950	78	200
BOXPDS-800-3	1445	4.83	2.2	28000	79	208
BOXPDS-800-4	1445	6.33	3	32700	80	210
BOXPDS-800-5.5	1440	8.12	4	37200	81	215

## Dimensions mm

### KIT BOXPDS

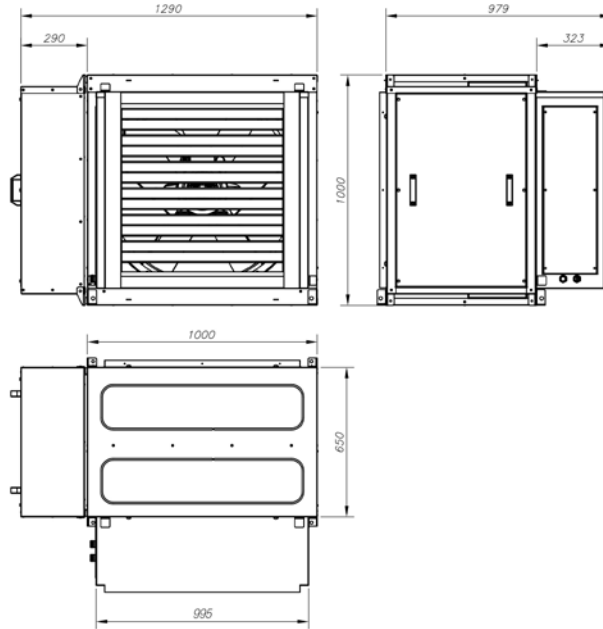
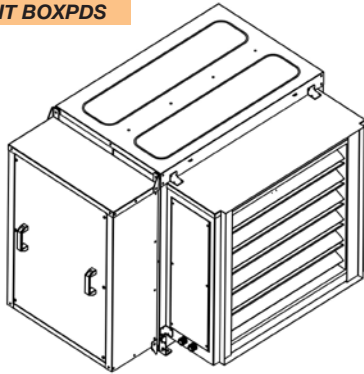

### BOXPDS

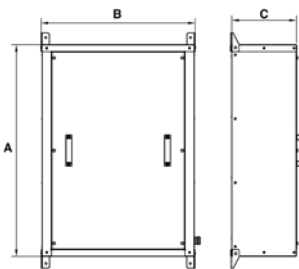

Model	A	B	C
BOXPDS	900	650	280

### DAMPER

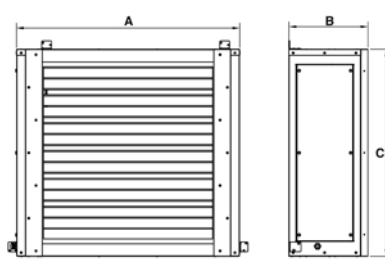

Model	A	B	C
DAMPER	995	326.5	855

### CJHCH

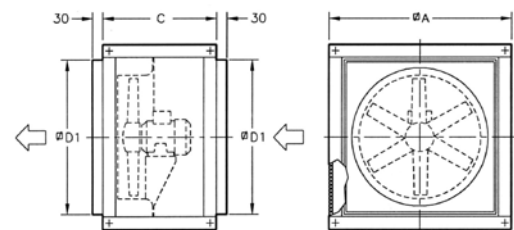

Model	ØA	C	ØD1
CJHCH-71/80	1000	650	850

## Examples of application

### BOXPDS

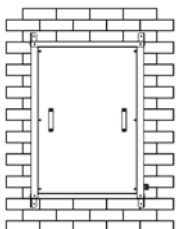

In technical room

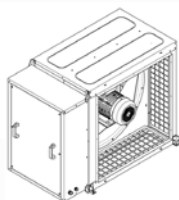

Next to ventilation unit

### DAMPER

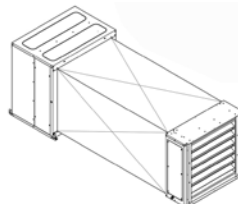

In intake conduit

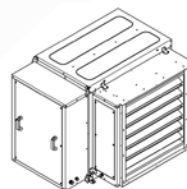

Next to ventilation unit

Two dampers can be used by installing two intake points at a considerable distance from the fan, so that one of the points is always in the open position and the other closed. In the event of smoke being detected in the intake nozzle with an open damper, the damper closes and the second damper opens to ensure the entry of clean air into the space to be protected (smoke-free escape route).

# HATCH PDS

## **Pressurisation equipment for staircases, escape routes and fire fighting lobbies, pursuant to European standard EN 12101-6**

Pressurisation equipment for escape routes in the event of a fire, pursuant to the requirements of European standard EN 12101-6. The HATCH PDS automatically regulates the air flow and is able to maintain the 50 Pa overpressure, even in the presence of leakages in the installation. The system can maintain the overpressure (pressure criteria) and a speed of 0.75 m/s in an open door situation (airflow criteria) almost immediately.

### **HATCH PDS**

It is formed by a HATCH-S ventilation unit with a motorised hatch opening function and a BOXPDS control panel.

- An extremely robust structure that is able to withstand severe weather changes.
- Equipment structure made of corrosive-proof galvanised sheet steel.
- Watertight design to prevent the entry of water.
- Heat insulation to prevent hot air loss in the winter.
- Adaptable skirting for correct, easy installation on the roof.

#### Opening system:

- Motorised opening arms, with encapsulated IP-65 mechanism.
- Supply voltage 230 V. AC 50Hz or 24V. DC.
- Reinforced, guaranteed system with more than 10,000 operations at maximum load.
- Maximum load 1000 Nw.
- Automatic opening via external control system signal (fire station, smoke detector, manual switch...).
- Control systems not included in the supply.
- Manual opening for environmental ventilation via switch.
- Limit switch to signal the hatch position.

#### Fan:

- HCT series extractor fans.
- Tubular wrap in sheet steel with polyester resin anti-corrosive treatment.
- Cast aluminium rotors.

#### Motor:

- IE2 efficiency motors for powers equal to or greater than 0.75kW and lower than 7.5kW.
- IE3 efficiency motors for powers equal to or greater than 7.5kW.
- Class F motors with ball bearings and IP55 protection.
- Three-phase 230/400V-50Hz (up to 4kW) and 400/690V-50Hz (powers greater than 4kW).
- Operating temperature: -25°C +50°C.

#### Finish:

- Anti-corrosive galvanised sheet steel.

#### On request:

- Fitted with F-300 and F-400 rated fans.
- Reversible pressurisation equipment for smoke evacuation in case of need.
- Polyester resin anti-corrosive paint finish.

### **BOXPDS**

- Variable Frequency Drive.
- High precision differential pressure sensor.
- Electric panel with magneto thermal protections and general power supply failure indication.
- Electronic control for the management of alarms, maintenance, ModBUS RTU port for BMS (Building management systems) connection and DAMPER control.
- Certified power supply with batteries to ensure power supply to control equipment in the event of a power failure.

#### Control panel:

- External control panel for real-time viewing of pressure, alarm pilot lamps and manual system activation.



+50 Pa



### Order code

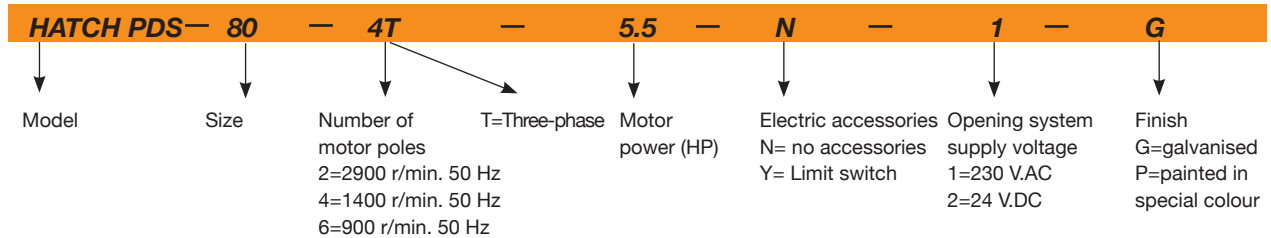

### Technical characteristics

Model	Speed (r/min)	Maximum admissible current (A)			Installed power (kW)	Maximum flow rate (m³/h)	Sound pressure level dB(A)	Approx. weight (Kg)
		230V	400V	690V				
HATCH PDS-40-2T-1	2850	3.15	1.80		0.75	6115	72	184
HATCH PDS-40-2T-1.5	2880	4.70	2.70		1.10	7050	73	188
HATCH PDS-45-2T-2	2880	5.90	3.40		1.50	9405	75	193
HATCH PDS-45-2T-3	2840	8.70	5.00		2.20	11325	77	194
HATCH PDS-50-2T-2	2880	5.90	3.40		1.50	10100	77	197
HATCH PDS-50-2T-3	2840	8.70	5.00		2.20	11925	78	199
HATCH PDS-50-2T-4	2880	11.20	6.50		3.00	13860	79	206
HATCH PDS-50-2T-5.5	2870		9.30	5.40	4.00	15900	80	222
HATCH PDS-56-2T-5.5	2870		9.50	5.50	4.00	18840	85	226
HATCH PDS-56-2T-7.5	2910		10.60	6.14	5.50	22510	86	237
HATCH PDS-56-2T-2	1440	6.20	3.60		1.50	15020	72	205
HATCH PDS-63-2T-3	1425	9.00	5.20		2.20	22460	73	262
HATCH PDS-63-2T-4	1430	11.40	6.60		3.00	24460	74	271
HATCH PDS-63-2T-1	940	4.70	2.70		0.75	16025	63	252
HATCH PDS-80-2T-3	1425	9.00	5.20		2.20	25545	79	280
HATCH PDS-80-2T-4	1430	11.40	6.60		3.00	30410	80	289
HATCH PDS-80-2T-5.5	1440		8.40	4.80	4.00	32940	81	295
HATCH PDS-80-2T-7.5	1460		12.60	7.30	5.50	39820	82	311
HATCH PDS-80-2T-1.5	945	5.50	3.20		1.10	21580	69	279
HATCH PDS-80-2T-2	945	7.40	4.30		1.50	26090	70	288
HATCH PDS-90-2T-7.5	1460		12.60	7.30	5.50	46325	88	392
HATCH PDS-90-2T-10	1460		17.70	10.20	7.50	50315	89	403
HATCH PDS-90-2T-15	1460		22.00	12.70	11.00	59610	90	456
HATCH PDS-90-2T-3	950	9.50	5.50		2.20	34055	75	365
HATCH PDS-90-2T-4	970	13.50	7.80		3.00	39055	76	391
HATCH PDS-100-2T-10	1460		17.70	10.20	7.50	57650	90	413
HATCH PDS-100-2T-15	1460		22.00	12.70	11.00	66505	91	466
HATCH PDS-100-2T-5.5	970		11.00	6.40	4.00	47955	81	413
HATCH PDS-100-2T-7.5	970		12.40	7.20	5.50	53545	82	420

### Technical characteristics of the dynamic discharge system based on standard EN 12101-3:2002/AC:2006

Model	Approval °C	Motor insulation class	Durability	Minimum room temperature	Wind load (Pa)	Snow load (Pa)
HATCH PDS	-	Class F	RE 10000	T(-15)	WL 1500	SL 500



## Erp. Maximum efficiency point (BEP) characteristics

<b>&lt;(°)</b>	Blade inclination angle (degrees)	<b>SR</b>	Specific ratio
<b>PN</b>	Nominal motor power (kW)	<b>ηe[%]</b>	Efficiency
<b>MC</b>	Measurement category	<b>N</b>	Efficiency grade
<b>EC</b>	Efficiency category	<b>[kW]</b>	Electric power
<b>S</b>	Static	<b>[m³/h]</b>	Flow rate
<b>T</b>	Total	<b>[mmH²O]</b>	Static or total pressure (based on EC)
<b>VSD</b>	Variable speed drive	<b>[RPM]</b>	Speed

Model	<(°)	PN	MC	EC	VSD	SR	ηe[%]	N	(kW)	(m³/h)	(mmH²O)	(RPM)
HATCH PDS-40-2T-1	16	0.75	A	S	NO	1.00	41.5%	48.1	0.933	4420	32.19	2850
HATCH PDS-40-2T-1.5	20	1.1	A	S	NO	1.00	33.6%	38.9	1.445	5180	34.43	2884
HATCH PDS-45-2T-2	16	1.5	A	S	NO	1.00	35.9%	40.8	1.688	6802	32.70	2896
HATCH PDS-45-2T-3	22	2.2	A	S	NO	1.01	37.7%	41.6	2.405	8144	40.86	2854
HATCH PDS-50-2T-2	8	1.5	A	S	NO	1.00	35.9%	40.3	2.014	6731	39.48	2876
HATCH PDS-50-2T-3	12	2.2	A	S	NO	1.01	36.8%	40.5	2.586	7884	44.29	2843
HATCH PDS-50-2T-4	16	3	A	S	NO	1.01	34.3%	37.3	3.381	8962	47.55	2885
HATCH PDS-50-2T-5.5	20	4	A	S	NO	1.01	32.6%	35.1	4.131	9537	51.91	2885
HATCH PDS-56-2T-5.5	16	4	A	S	NO	1.01	45.4%	47.8	4.202	12896	54.34	2883
HATCH PDS-56-2T-7.5	22	5.5	A	S	NO	1.01	41.2%	42.6	6.055	15917	57.53	2913
HATCH PDS-56-4T-2	36	1.5	B	T	NO	1.00	45.7%	50.7	1.665	13581	20.60	1445
HATCH PDS-63-4T-3	32	2.2	B	T	NO	1.00	62.0%	65.9	2.443	20324	27.38	1430
HATCH PDS-63-4T-4	38	3	B	T	NO	1.00	57.8%	60.9	3.270	24239	28.64	1440
HATCH PDS-63-4T-1	38	0.75	B	T	NO	1.00	48.4%	54.4	1.099	15880	12.29	942
HATCH PDS-80-2T-3	12	2.2	C	S	NO	1.00	47.1%	51.0	2.413	16923	24.69	1430
HATCH PDS-80-2T-4	16	3	C	S	NO	1.00	41.1%	43.8	3.686	20444	27.19	1432
HATCH PDS-80-2T-5.5	18	4	C	S	NO	1.00	41.2%	43.5	4.246	22304	28.78	1448
HATCH PDS-80-4T-7.5	26	5.5	B	T	NO	1.00	63.0%	64.5	5.914	35186	38.92	1465
HATCH PDS-80-2T-1.5	18	1.1	C	S	NO	1.00	35.4%	40.8	1.389	14613	12.35	951
HATCH PDS-80-4T-2	26	1.5	B	T	NO	1.00	57.5%	62.1	1.825	23053	16.71	950
HATCH PDS-90-2T-7.5	18	5.5	C	S	NO	1.00	44.1%	45.2	6.749	31521	34.72	1460
HATCH PDS-90-2T-10	22	7.5	C	S	NO	1.01	38.9%	39.2	9.154	35009	37.36	1463
HATCH PDS-90-4T-15	30	11	B	T	NO	1.01	67.1%	67.1	11.526	52205	54.45	1463
HATCH PDS-90-2T-3	24	2.2	C	S	NO	1.00	38.0%	41.5	2.832	23831	16.58	950
HATCH PDS-90-4T-4	30	3	B	T	NO	1.00	58.8%	61.6	3.698	34203	23.37	971
HATCH PDS-100-2T-10	16	7.5	C	S	NO	1.00	41.3%	41.4	9.606	37591	38.73	1461
HATCH PDS-100-2T-15	22	11	C	S	NO	1.01	43.6%	43.5	12.145	44571	43.65	1461
HATCH PDS-100-4T-20	28	15	B	T	NO	1.01	64.1%	63.8	16.091	66559	56.95	1462
HATCH PDS100-6T-5.5	26	4	B	T	NO	1.00	57.6%	59.7	4.671	42042	23.50	973
HATCH PDS-100-4T-7.5	32	5.5	B	T	NO	1.00	56.3%	57.9	5.690	53520	22.00	975

## Acoustic characteristics

The values given are determined by measuring the sound power in dB(A) obtained in a free field at a distance equivalent to twice the size of the fan plus the rotor diameter, with a minimum of 1.5 m.

Sound power spectrum Lw(A) in dB(A) per Hz frequency band.

Model	63	125	250	500	1000	2000	4000	8000	Model	63	125	250	500	1000	2000	4000	8000
40-2-1	44	65	72	77	80	76	69	58	80-4-4	54	74	82	87	89	86	79	71
40-2-1.5	45	66	73	78	81	77	70	59	80-4-5.5	54	74	82	87	89	86	79	72
45-2-2	47	68	75	80	83	79	72	61	80-4-7.5	55	75	83	88	90	87	80	73
45-2-3	49	70	77	82	85	81	74	63	80-6-1.5	47	64	72	77	79	76	69	58
50-2-2	52	72	80	85	87	84	77	66	80-6-2	48	65	73	78	80	77	70	59
50-2-3	53	73	81	86	88	85	78	67	90-4-7.5	57	78	85	90	93	89	82	71
50-2-4	54	74	82	87	89	86	79	68	90-4-10	56	77	84	89	92	88	81	70
50-2-5.5	55	75	83	88	90	87	80	69	90-4-15	58	79	86	91	94	90	83	72
56-2-5.5	60	80	88	93	95	92	85	74	90-6-3	54	68	75	80	83	79	72	61
56-2-7.5	61	81	89	94	96	93	86	75	90-6-4	55	70	77	82	85	81	74	63
56-4-2	47	67	75	80	82	79	72	61	100-4-10	60	80	88	93	95	92	85	74
63-4-3	50	68	76	81	83	80	75	64	100-4-15	59	79	87	92	94	91	84	73
63-4-4	51	69	77	82	84	81	76	65	100-4-20	61	81	89	94	96	93	86	75
63-6-1	41	60	68	73	75	72	65	55	100-6-5.5	62	71	79	84	86	83	76	65
80-4-3	56	75	83	89	90	87	81	70	100-6-7.5	63	72	80	85	87	84	77	66

## Dimensions mm

### HATCH PDS

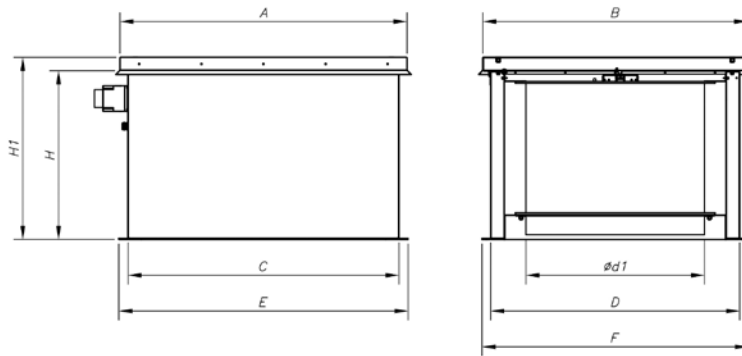

Model	A	B	C	D	ød1	E	F	H	H1	Model	A	B	C	D	ød1	E	F	H	H1
HATCH PDS-40-2T-1	1100	990	1022	920	400	1100	1000	760	820	HATCH PDS-80-4T-4	1295	1195	1222	1122	800	1300	1200	760	820
HATCH PDS-40-2T-1.5	1100	990	1022	920	400	1100	1000	760	820	HATCH PDS-80-4T-5.5	1295	1195	1222	1122	800	1300	1200	760	820
HATCH PDS-45-2T-2	1100	990	1022	920	450	1100	1000	760	820	HATCH PDS-80-4T-7.5	1295	1195	1222	1122	800	1300	1200	760	820
HATCH PDS-45-2T-3	1100	990	1022	920	450	1100	1000	760	820	HATCH PDS-80-6T-1.5	1295	1195	1222	1122	800	1300	1200	760	820
HATCH PDS-50-2T-2	1100	990	1022	920	500	1100	1000	760	820	HATCH PDS-80-6T-2	1295	1195	1222	1122	800	1300	1200	760	820
HATCH PDS-50-2T-3	1100	990	1022	920	500	1100	1000	760	820	HATCH PDS-90-4T-7.5	1492	1392	1420	1320	900	1500	1400	860	920
HATCH PDS-50-2T-4	1100	990	1022	920	500	1100	1000	760	820	HATCH PDS-90-4T-10	1492	1392	1420	1320	900	1500	1400	860	920
HATCH PDS-50-2T-5.5	1100	990	1022	920	500	1100	1000	760	820	HATCH PDS-90-4T-15	1492	1392	1420	1320	900	1500	1400	860	920
HATCH PDS-56-2T-5.5	1100	990	1022	920	560	1100	1000	760	820	HATCH PDS-90-6T-3	1492	1392	1420	1320	900	1500	1400	860	920
HATCH PDS-56-2T-7.5	1100	990	1022	920	560	1100	1000	760	820	HATCH PDS-90-6T-4	1492	1392	1420	1320	900	1500	1400	860	920
HATCH PDS-56-4T-2	1100	990	1022	920	560	1100	1000	760	820	HATCH PDS-100-4T-10	1492	1392	1420	1320	1000	1500	1400	860	920
HATCH PDS-63-4T-3	1295	1195	1222	1122	630	1300	1200	760	820	HATCH PDS-100-4T-15	1492	1392	1420	1320	1000	1500	1400	860	920
HATCH PDS-63-4T-4	1295	1195	1222	1122	630	1300	1200	760	820	HATCH PDS-100-4T-20	1492	1392	1420	1320	1000	1500	1400	860	920
HATCH PDS-63-6T-1	1295	1195	1222	1122	630	1300	1200	760	820	HATCH PDS-100-6T-5.5	1492	1392	1420	1320	1000	1500	1400	860	920
HATCH PDS-80-4T-3	1295	1195	1222	1122	800	1300	1200	760	820	HATCH PDS-100-6T-7.5	1492	1392	1420	1320	1000	1500	1400	860	920

### BOXPDS

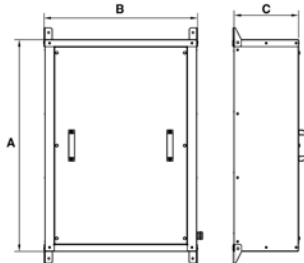

Model	A	B	C
BOXPDS	900	650	280

# PRESSKIT

**Fire fighting lobby pressurisation equipment in accordance with DM 30/11/1983 and with European standard EN 12101-6**

The PRESSKIT equipment is comprised of one or more fans. In the case of fire they are activated to exert an overpressure of 50Pa in safe zones and to prevent the entry of smoke in escape routes for the evacuation of people.



Certified: NR331151



Common characteristics:

- Self-regulation of pressure throughout the lobby.
- Brushless 24Vdc E.C. fans with a maximum flow rate of 2100m<sup>3</sup>/H.
- An overpressure of 50Pa is maintained in the lobby.

Equipment control:

- S models: Simplified regulation of the ventilation unit via a pressure sensor with a built-in PID signal adjuster.
- P models: PLC control with multiple inputs, outputs, alarms and fan regulation via PID signal.
- Delay in equipment connection depending on the fire door status.
- Power supply panel with autonomy of more than 2 hours through 18Ah batteries.
- Ease in connecting equipment.
- Fast configuration and adjustment of all the parameters via LCD display and keyboard.
- MANUAL system activation button.
- Viewing of pressure in safe zone and equipment status in real time.

## PRESSURISATION FAN

- Brushless 24VDC fan, 0-10V analogue control input.
- Maximum flow rate 2100m<sup>3</sup>/h.
- Mural fan for conduits with a diameter of 310mm.
- ROTOR-MOTOR air direction.
- Useful life in continuous operation of more than 20,000 hours.
- Rotor made of painted sheet steel.
- Protective anti-contact grille.

- Possibility of controlling 2 fans with a single panel and power source. (PRESSKIT TWIN).
- Regulation through a single control panel of 1 or 2 ventilation units.
- Key lock.

## CONTROL PANEL

- System control panel through small PLC that is easy to install. Power supply 230VAC.
- Digital input for detecting open door.
- Digital outputs indicating fire alarm activated, through visual and acoustic indicator light that flashes with configurable times.
- Configurable connection delay times in the event of detecting a fire alarm and fire doors open.
- Configuration of all the PID output parameters.
- Manual system activation button.
- Viewing of pressure in Pa in real time, indication of equipment status STANDBY/ PRESSURISING.

### Control panel characteristics

Total voltage (V): 1x230	Total current (A): 0.3
Output Voltage 1 (V): 19.7-28VDC	Output Voltage 2 (V): 19.7-28VDC
Max. current Output 1 (A): 6	Max. current Output 2 (A): 7
Protection (IP): 44	Operating temperature (°C): -25 to +60
Weight (Kg): 30.5	

## PRESSURE SENSOR WITH DISPLAY

(BUILT INTO CONTROL PANEL)

- 0-100 Pa preconfigured differential pressure sensor.
- 0..10V analogue output.
- LCD display.
- Calibrated high precision analogue sensor.



+50 Pa

## Order code

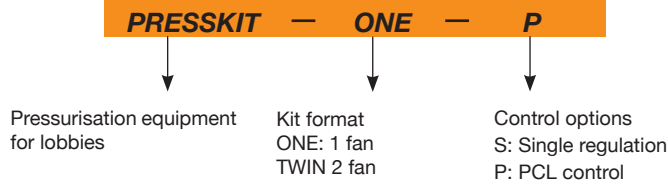

## Technical characteristics

Model	Maximum flow rate (m3/h)	Maximum pressure (Pa)	Speed (rpm)	Irradiated LpA 3m dB(A)	Total voltage (V)	Total current (A)	Total power (w)	Weight (kg)	Protection (IP)	Operating temperature: (°C)	Nominal diameter of conduit (mm)
PRESSKIT ONE	2100	180	1800	65	24VDC	4.8	115	6.8	42	-25 to +60	310
PRESSKIT TWIN	4100	180	1800	68	24VDC	9.6	230	13.6	42	-25 to +60	310

## Dimensions mm

### PRESSURISATION FAN

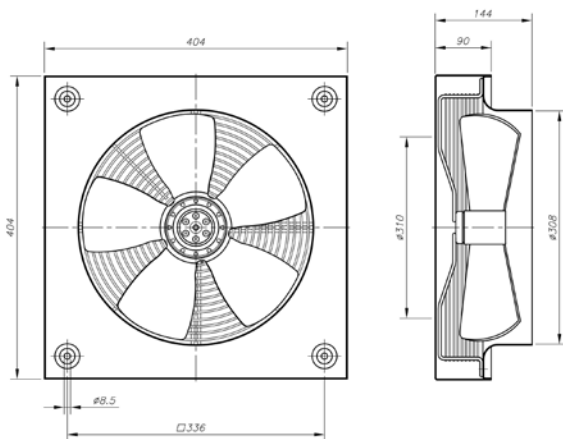

### CONTROL PANEL

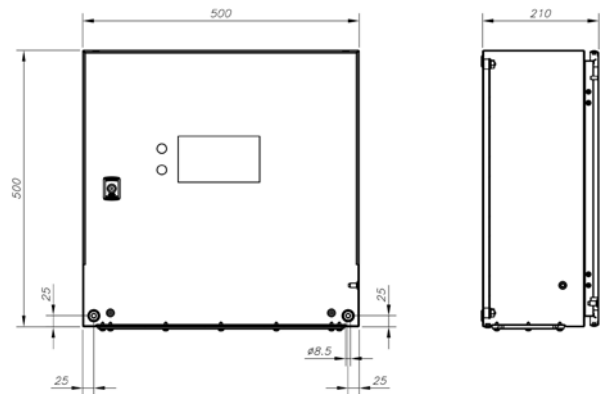

## Kit characteristics

Component	PRESSKIT ONE	PRESSKIT TWIN
Regulation by means of pressure sensor	YES	YES
Regulation of several fans	-	YES*
Relay outputs to indicate the equipment is activated	YES	YES
Door sensor inputs	YES	YES

\* PRESSKIT TWIN regulates two fans simultaneously with a single pressure sensor for large lobbies/pressurised areas. The regulation of each fan is not separate, they have the same PID set point depending on the signal received from the sensor.

## Configurations

Component	PRESSKIT ONE	PRESSKIT TWIN
E.C. FAN BRUSHLESS 24Vdc	1 unit	2 units
CONTROL PANEL	1 unit	1 unit
PRESSURE SENSOR (BUILT INTO CONTROL PANEL)	1 unit	1 unit

## Accessories



Alarm push button

Checker batteries

Power source and battery output voltage checker via RJ45 connector.

## SELECTION SOFTWARE



**PREPARE TECHNICAL**

**NEW  
PROJECTS  
MODULE**

**REPORTS IN A  
MATTER OF MINUTES**

Our **new tool** that will help you select the product that is most appropriate for your ventilation system.

**PROJECTS MODULE:** a **new function** for preparing technical reports in a matter of minutes.

- . Select hundreds of models in just one step
- . Mass load the data into Excel
- . Edit and process the technical files
- . Print out the report with the table of contents and cover, edit it or send it to another QuickFan

# QUICKFAN SODECA SELECTOR



SEARCH  
EASY



REPORTS  
CUSTOMISED



CONSTANTLY  
UPDATED



REPORTS  
IN A MATTER OF  
MINUTES



Ctra. de Berga, km 0,7  
E-08580 SANT QUIRZE  
DE BESORA  
BARCELONA, SPAIN  
Tel. +34 93 852 91 11  
+34 93 852 90 42

comercial@sodeca.com  
**Export sales:** ventilation@sodeca.com  
[www.sodeca.com](http://www.sodeca.com)



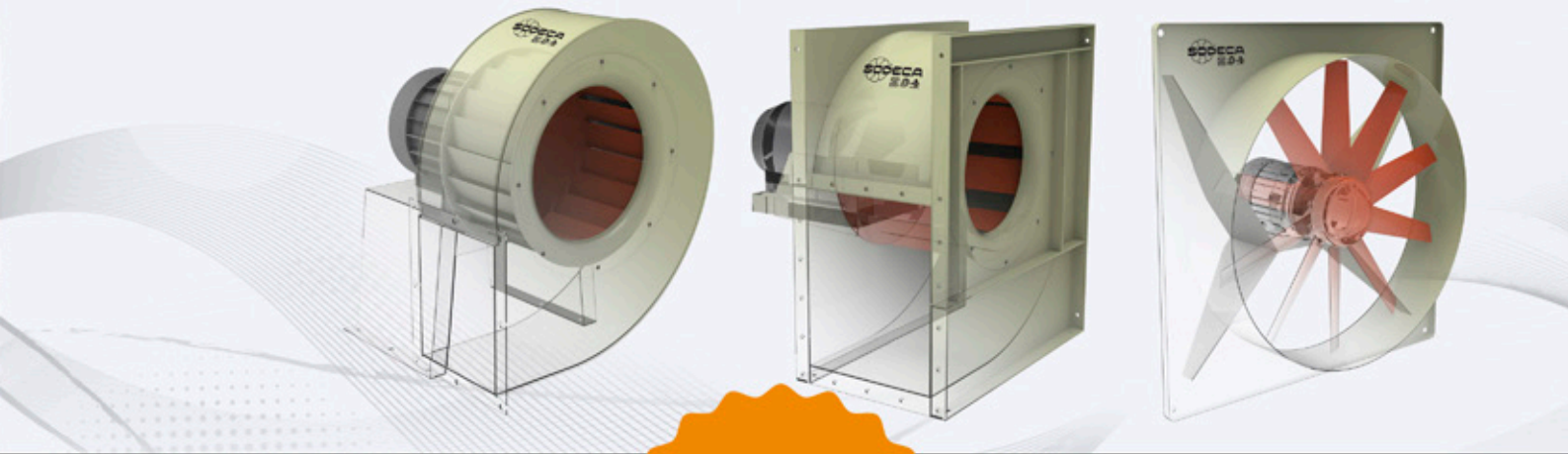

**PREPARE TECHNICAL**

**NEW  
MODELS IN  
CAD 3D**

**REPORTS IN A  
MATTER OF MINUTES**

Our **new tool** for technical departments and engineering firms will make it easy for you to select the most suitable product for your ventilation system

**MODELS IN CAD 3D:**

- . Download our fans in Cad 3D from our website
- . Choose from among more than 40 available Cad formats
- . Including Revit
- . More than 2,000 models and configurations available



**3D**  
**SODECA**



**FANS  
CAD 3D**

**40  
FORMATS  
AVAILABLE**



**CONSTANTLY  
UPDATED**



**REPORTS  
IN A MATTER OF  
MINUTES**



**AIRTECHNIC**  
www.airtechnic.gr

Air-Conditioning & Ventilation Components & Systems



EFFICIENT WORK FANS



# SOLution DEvelopment CAPacity

Fast and flexible industrial fan solutions and tailored fans

Extensive experience in smoke control systems and ATEX applications

Wide range of certified products for specific markets

HELICAL FANS AND  
ROOF-MOUNTED EXTRACTOR  
FANS



CENTRIFUGAL  
FANS AND IN-LINE EXTRACTOR  
FANS



SMOKE  
EXTRACTOR  
FANS



HEAVY DUTY FANS  
AND EXTRACTOR FANS FOR  
ATEX AND EXPLOSIVE  
ATMOSPHERES



HEAT RECOVERY UNITS, AIR  
FILTERING  
AND TREATMENT UNITS



AIR CURTAINS FOR  
COMMERCIAL AND INDUSTRIAL  
APPLICATIONS



PRESSURISATION  
SYSTEMS FOR  
HOMES



ASK US  
FOR INFORMATION  
[www.sodeca.com](http://www.sodeca.com)



Distributed by:

 **AIRTECHNIC**  
[www.airtechnic.gr](http://www.airtechnic.gr)  
Air-Conditioning & Ventilation Components & Systems



**SODECA** Group

**SODECA. HEADQUARTERS**  
Sodeca S.L.U.  
Ctra. de Berga, km 0,7  
E-08580 SANT QUIRZE  
DE BESORA  
Barcelona, SPAIN  
Tel. +34 93 852 91 11  
Fax: +34 93 852 90 42  
[ventilation@sodeca.com](mailto:ventilation@sodeca.com)

**PORTUGAL**  
Sodeca Portugal Lda  
Sr. Luiz Araújo  
Rua Veloso Salgado 1120/1138  
4450-801 Leça de Palmeira,  
Porto, PORTUGAL  
Tel. +351 229 991 100  
Fax: +351 229 991 119  
[geral@sodeca.pt](mailto:geral@sodeca.pt)

**PORTUGAL**  
Sodeca Portugal Lda  
Sr. Luiz Araújo  
P. E. da Granja - Pavilhão 8  
2625-607 Vialonga,  
Lisboa, PORTUGAL  
Tel. +351 219 748 491  
Fax: +351 219 748 493  
[geral@sodeca.pt](mailto:geral@sodeca.pt)

**FINLAND**  
Sodeca Finland Oy  
Mr. Kai Yli-Sipiä  
Metsälinnankatu 30, PL2,  
FI-32700 Huittinen,  
FINLAND  
Tel. 358 400 320 125  
[orders.finland@sodeca.com](mailto:orders.finland@sodeca.com)

**CHILE**  
Sodeca Ventiladores Ltda  
Sr. Francesc Bertran  
Avda. Puerta Sur  
03380 San Bernardo,  
Santiago, CHILE  
Tel. +56 22 840 5582  
[ventas.chile@sodeca.com](mailto:ventas.chile@sodeca.com)

**ÁREA CARIBE**  
Sodeca Cuba  
Sr. Carlos Hernández  
Residencial Miramar  
Apto. No. 108  
Ave. 7ma N° 1805 entre 18 y 20  
Miramar Playa, Havana, CUBA  
Tel. 00537 20 43721  
[sodeca@sodeca.co.cu](mailto:sodeca@sodeca.co.cu)

**RUSSIA**  
Sodeca, L.L.C.  
Mr. Stanislav Alifanov  
Russia, 140180, Moscow region,  
Zhukovskiy, Myasisheva str, 1,  
room 603  
Business Center "Chaika"  
Tel: +7 495 955 90 50  
[alifanov@sodeca.com](mailto:alifanov@sodeca.com)

Μιχαήλ Καραολή 19, τκ 143 43, Ν. Χαλκηδόνα, Αθήνα  
Τηλ: 211 - 70.55.500 & 210 - 21.30.051, Fax: 210 - 22.23.283